

650

W. M. Stevenson
A. H. B.

6.2.70

Library of the Theological Seminary,
PRINCETON, N. J.

Presented by President Patton.

Division

BS
440

Section

.K557
1857

v.1

100
S.W.

100 1/2 - 1 :
8

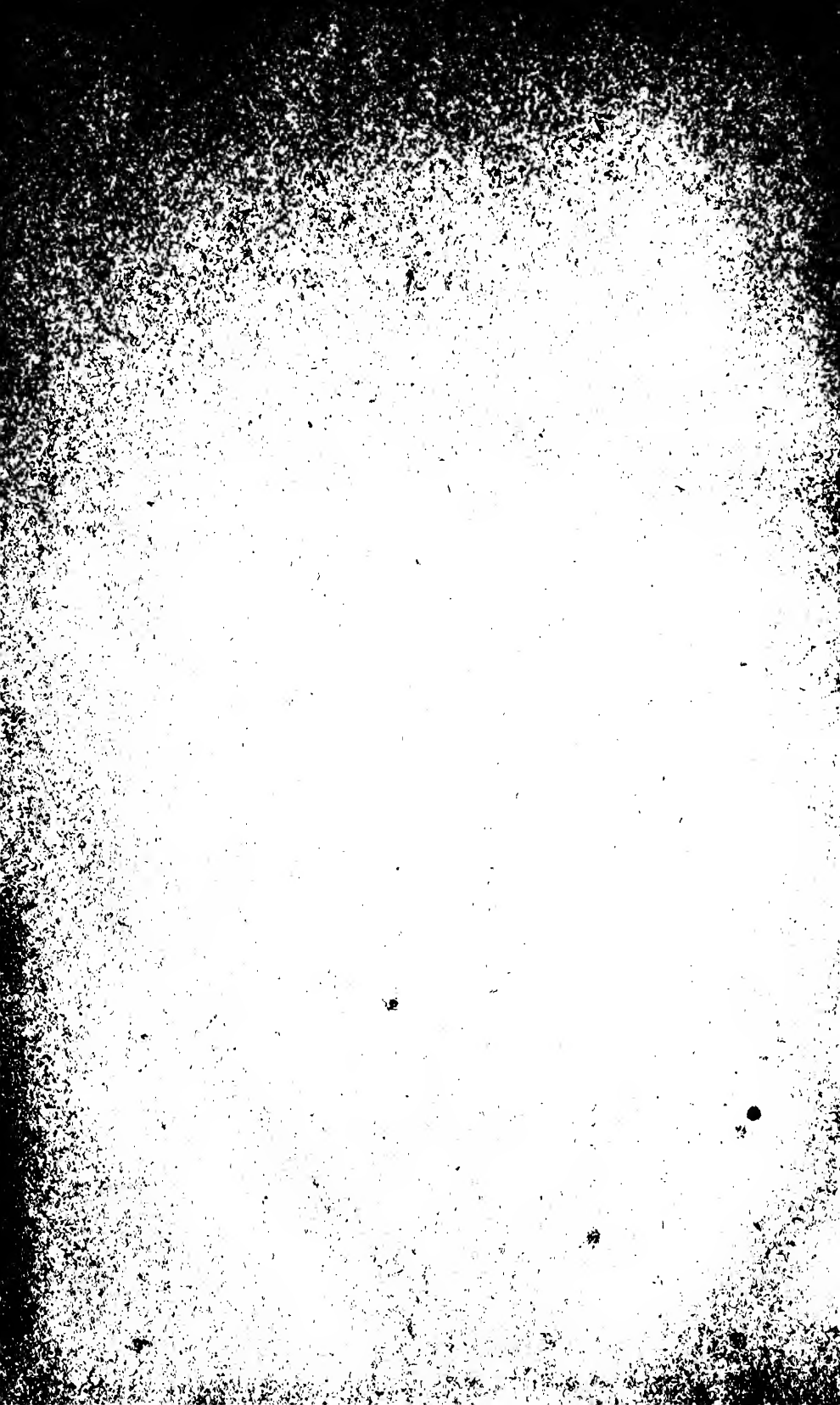



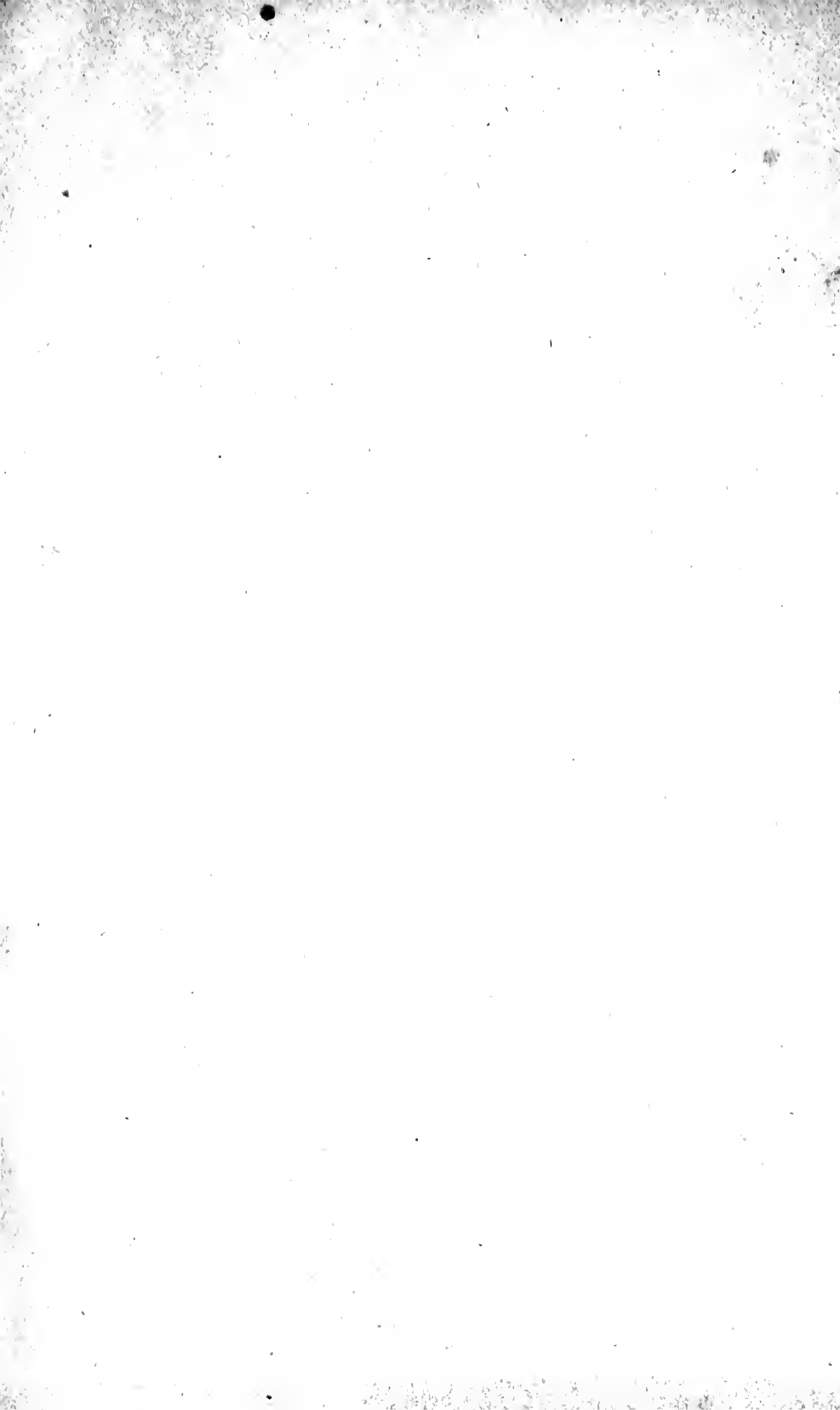

THE
CYCLOPÆDIA
OF
BIBLICAL LITERATURE.

EDITED BY
✓
JOHN KITTO, D.D., F.S.A.,

AUTHOR OF "THE HISTORY AND PHYSICAL GEOGRAPHY OF PALESTINE," EDITOR OF
"THE PICTORIAL BIBLE," &c. &c.

ILLUSTRATED BY NUMEROUS MAPS AND ENGRAVINGS.

IN TWO VOLUMES.

VOL. I.

TENTH EDITION.

NEW YORK:
IVISON & PHINNEY, 321 BROADWAY.

CHICAGO: S. C. GRIGGS & CO., 111 LAKE ST.

BUFFALO: PHINNEY & CO. CINCINNATI: MOORE, WILSTACH, KEYS & CO.

PHILADELPHIA: SOWER & BARNES. DETROIT: MORSE & SELLECK.

NEWBURG: T. S. QUACKENBUSH. AUBURN: SEYMOUR & CO.

1857.

THE UNIVERSITY OF CHICAGO

PHYSICS DEPARTMENT

1950

LIST OF CONTRIBUTORS.

INITIALS.	NAMES.
W. L. A.	REV. W. L. ALEXANDER, M.A., Author of 'The Connexion and Harmony of the Old and New Testaments,' &c.
G. B.	REV. G. BAUR, Ph. D. of the University of Giessen.
J. R. B.	REV. J. R. BEARD, D.D., Member of the Historico-Theological Society of Leipzig.
G. M. B.	G. M. BELL, Author of 'Universal Mechanism,' &c.
C. H. F. B. . . .	REV. C. H. F. BIALLOBLITZKY, Ph. D., Göttingen, Author of 'De Abrogatione Legis.'
J. B.	REV. JOHN BROWN, D.D., Professor of Exegetical Theology to the United Secession Church.
G. B.	REV. GEORGE BUSH, Professor of Hebrew and Oriental Literature in the University of New York.
J. D. B.	REV. JAMES D. BUTLER, Abbot Resident, Theological Seminary, Andover, United States.
K. A. C.	K. A. CREDNER, Doctor and Professor of Theology in the University of Giessen.
S. D.	REV. S. DAVIDSON, LL.D., Professor of Biblical Literature and Oriental Languages in the Lancashire Independent College.
B. D.	REV. BENJAMIN DAVIES, D.D.
J. F. D.	REV. J. F. DENHAM, M.A., St. John's College, Cambridge, F.R.S.
J. W. D.	REV. J. W. DOBAN, LL.D., Association Secretary of the Church Missionary Society.
J. E.	REV. JOHN EADIE, LL.D., Professor of Biblical Literature to the United Secession Church.
G. H. A. v. E. .	G. H. A. VON EWALD, Doctor and Professor of Theology in the University of Tübingen.
F. W. G.	REV. F. W. GOTCH, M.A., Trinity College, Dublin.
H. A. C. H. . . .	H. A. C. HAVERNICK, Doctor and Professor of Theology in the University of Königsberg.
E. W. H.	E. W. HENGSTENBERG, Doctor and Professor of Theology in the University of Berlin.
J. J.	REV. J. JACOBI, of the University of Berlin.
R. J.	REV. R. JAMIESON, M.A., Editor of 'Paxton's Illustrations of Scripture.'
E. A. L.	REV. E. A. LAWRENCE, Haverhill, United States.

INITIALS.	NAMES.
R. L.	REV. ROBERT LEE, D.D., Edinburgh.
F. R. L.	FREDERICK R. LEES, Ph. D., F.S.S.A.; Editor of 'The Truth-Seeker' &c.
E. M.	E. MICHELSON, Ph. D. of the University of Heidelberg.
P. M.	PETER MEARNS, Author of 'Tirosh,' &c.
N. M.	REV. N. MORREN, M.A., Author of 'Biblical Theology,' and Translator of 'Rosenmüller's Biblical Geography.'
F. W. N.	F. W. NEWMAN, late Fellow of Balliol College, Oxford.
J. N.	JOHN NICHOLSON, B.A., Oxford, Ph. D., Tübingen, Author of 'An Account of the Establishment of the Fatemite Dynasty,' Translator of 'Ewald's Hebrew Grammar.'
W. A. N.	W. A. NICHOLSON, M.D.
J. P. P.	REV. JOHN PHILLIPS POTTER, M.A., Oriel College, Oxford.
B. P.	REV. BADEN POWELL, M.A., F.R.S., F.G.S., Savilian Professor of Geometry in the University of Oxford.
J. F. R.	J. F. ROYLE, M.D., F.R.S., F.L.S., F.G.S., Member of the Royal Asiatic Societies of Calcutta and London; Professor of Materia Medica and Therapeutics in King's College, London.
J. E. R.	J. E. RYLAND, Translator of 'Neander's Church History,' and of 'Semisch's Justin Martyr.'
C. H. S.	LIEUT.-COLONEL C. HAMILTON SMITH, K.H. and K.W., F.R. and L.S., President of the Devon and Cornwall Natural History Society, &c. &c.
J. P. S.	REV. J. PYE SMITH, D.D., F.R.S., F.G.S.
H. S.	REV. H. STEBBING, D.D. of St. John's College, Cambridge, Author of 'A History of the Church,' &c.
A. T.	REV. A. THOLUCK, Doctor and Professor of Theology in the University of Halle.
D. W.	REV. DAVID WELSH, D.D., Professor of Divinity and Church History, New College, Edinburgh.
L. W.	REV. LEONARD WOODS, D.D., Professor of Theology in the Andover Theological Seminary, United States.
W. W.	REV. WILLIAM WRIGHT, M.A. and LL.D. of Trinity College, Dublin, Translator of 'Seiler's Biblical Hermeneutics.'

The initials of the Contributors of the following articles have been inadvertently omitted:—
 J. R. B., ROMAN EMPIRE; TABERNACLES, FEAST OF.—H. A. C. H., GENESIS.—J. F. R., SPICES; STORAX, TAMAR, 1; TEIL TREE; TIRZAH, 1.—W. W., JUDE; NEBUCHAD-NEZZAR.

P R E F A C E.

THE present work was undertaken with the design of providing the public with a more complete view of the existing state of Biblical literature, both at home and abroad, than it previously possessed. It was felt that former works of the kind, numerous as they are, and useful as some of them may be considered, were built too exclusively upon the 'old learning' of Calmet and others; and that some recent attempts to give a more modern character to such undertakings had been made too entirely from home materials, and had too exclusive reference to such external facts and circumstances as travellers and antiquarians offer, to meet the demands of the present time. The work, therefore, owes its origin to the Editor's conviction of the existence of a great body of untouched materials, applicable to such a purpose, which the activity of modern research and the labours of modern criticism had accumulated, and which lay invitingly ready for the use of those who might know how to avail themselves of such resources.

It was no task for one man to gather in this great harvest. And as the ground seemed, for the most part, common to all Christian men, it appeared desirable that assistance should be sought from a sufficient number of competent Biblical scholars and others, without distinction of country or religious party, that the field might be the more thoroughly swept, and the greater wealth of illustration obtained, from men of different lines of reading and various habits of thought. The prompt manner in which the call of the Editor for co-operation has been met by the numerous eminent Biblical scholars and naturalists, whose names appear in the List of Contributors, has been among the highest gratifications arising to him out of this undertaking; while the ability, the laborious research, the care and the punctuality, with which they have discharged the various tasks confided to them, demand his warmest acknowledgments.

The only drawback likely to arise from co-operation so various and extensive, lay in the probability that considerably different views might be manifested in the several articles; and that, too, on subjects on which every reader is likely to have formed some opinion of his own, and will be disposed to regard as

erroneous or suspicious every opinion which may not entirely coincide with that which he has been accustomed to entertain. In this lay the sole danger and the greatest difficulty of such an undertaking. Here was to be a book which no one man, and not even a very few men, could produce; and which the public would yet probably expect to exhibit as much unity, not only of plan and execution, but of opinion and sentiment, as if it were the produce of a single mind. The Editor, however, felt that he could not undertake to find forty independent thinkers among whom there should be no visible diversities of sentiment. But he thought that much might be done in producing so near an approach to uniformity on matters of real importance as would satisfy every reasonable reader; especially when he should come to consider that the choice lay between taking the work with such diversities as necessarily arose from the extent of the co-operation employed in its production, or of altogether dispensing with the immense amount of Biblical information which it embodies. Entire uniformity, if attainable at all, could only have been attained at the cost of providing a very different and greatly inferior work; and a work thus different and inferior could not have established a distinction sufficiently marked from all previous undertakings of the kind to justify its production.

It has not consisted with the Editor's idea of the functions he had undertaken, to dictate to the Contributors the views they were to take of the subjects intrusted to them, or to set up his own views as the standard of correct opinion. This he must have done, had he made it his rule to insert only such statements as exactly coincided with his own sentiments, or to exclude altogether whatever views of particular subjects might differ from those with which his own mind is satisfied. The Contributors were expected to abstain from introducing the opinions peculiar to their nation or to their religious communion; but they have been under slight restraint with respect to the conclusions which they might form as independent thinkers and reasoners, competent by their attainments and studies to form a judgment worthy of attention on the various matters coming under their consideration. In conformity with no other principle could this work have been produced; and such being the nature of its execution, it became necessary that the initials of the several writers should be affixed to their contributions, that the reader might know to whom to ascribe the responsibility of the particular articles, and that no one contributor might be deemed responsible for any other articles than those to which his signature is annexed. The Editor also, who has provided all those articles which bear no signature (except those adverted to at the end of the List of Contributors), does not hold himself responsible for any statements or opinions advanced in any other articles than these. Some of them exhibit opinions in which he is not able to concur, but which have nevertheless been furnished by persons whom he could not regard as less competent than himself to arrive at just conclusions.

Yet although some explanation is due to those who may possibly find in this

work, in a few articles, opinions in which they cannot agree, and views from which their own differ; it is right that the persons engaged in producing it should claim for it a judgment founded not upon particular articles, but upon its general character, which was intended to be, and is, in accordance with the known standards of orthodox opinion in this country, as may be ascertained by reference to those leading articles which may be regarded as stamping the character of any work in which they are found. In fact, a Cyclopædia of *Biblical Literature*, as distinct from *Theology* properly so called, offers less occasion than might at first sight appear for the obtrusion of those matters of doctrine and discipline which Christian men regard with differences of opinion which the Editor would fain believe to be less wide and less important than is too generally supposed. In the dispensations of Divine Providence, he has been by physical privations shut out from many of those external influences and associations which tend to magnify such differences, and to deepen into impassable gulfs the space which lies between them. He has not found this condition a disadvantage in conducting the work which he has now the happiness of having brought to a conclusion; nor will he venture to regard that condition as an unmitigated evil, if, through the complete isolation in which he has thereby been placed, he has been enabled, without any compromise of the views he conscientiously entertains and which *his own* writings will sufficiently indicate, to realize more extensive co-operation in this undertaking than under pastoral or official connection with any religious denomination he could expect to have attained. It is believed that the English language has no other book which eminent foreign scholars have co-operated with our own in producing; and it is certain that it possesses no other work which embodies the combined labours of writers who, indeed, are of different communions here, and are known by different names among men, but who have the same hope in this world, and but one name in heaven.

The nature of the present work, and the place which its conductors desire it should occupy in the Biblical Literature of this country, will be best understood by a sketch of the whole field in which that place is marked out. This will show not only what is here attempted, but how much of this wide and fruitful field remains open to the same process of cultivation. For this sketch we are indebted to the able pen of Dr. Credner, who has enriched this work by several valuable contributions, and by whom it has been prepared expressly for the place which it here occupies. It will be understood by most readers that the term *Theological Encyclopædia* is technically employed on the Continent, and is beginning to be employed in this country, to describe the whole field of Sacred Literature, of which Biblical Literature, strictly so called, is but a part.

“A comprehensive arrangement of all that belongs to the region of human knowledge has—not quite properly—been indicated by the term *Encyclopædia*, i. e., ἐν κύκλῳ παιδεία or ἐγκύκλιος παιδεία. Another term, *Wissenschaft*

Kunde (knowledge of science), has also been applied to that arrangement in Germany, when it includes likewise an internal and scientific development of the systems and subjects under discussion. In our title, *Cyclopædia of Biblical Literature*, it is obvious that the word 'Cyclopædia' cannot be taken in the more extended acceptance of the term, but merely so far as the Bible and Theology are concerned. As the peculiar province of *Biblical Encyclopædia* can only be clearly understood and defined in its connection with *Theological Encyclopædia*, it may be requisite to describe at length the meaning of the latter and more comprehensive term.

But even the notion of Theological Encyclopædia in general, is yet of too extended range for our purpose, as it might be supposed to comprehend a systematic development of *all* that refers to the knowledge of God generally; while here cognizance can be only taken of some particular branch of that knowledge, namely, of that belonging to Christianity alone. Our notice must therefore be limited to the Encyclopædia of *Christian* theology. But Christian theology forms only a special and limited part of general theology. The former, in endeavouring to comprehend scientifically the Christian religion, deals altogether with a subject of experience. For the Christian religion, or the Christian knowledge of God, is not innate and constitutional in man, or something existing in his mind *à priori*, but is a religion connected with Jesus Christ as its revealer. Christian theology is thus a positive or historical science, which can be traced from its origin at a known point of time.

Now, nothing more intimately concerns the spirit of Christian theology than the solution of the question, By what standard are we to determine the tenets of the Christian religion, or from what source must they be deduced? It is in the solution of this important question that the adherents of the Christian religion divide themselves into two large bodies; the one considers the Scriptures, emanating from the Holy Ghost, as the first and last source of knowledge for Christian truth,—a source, however, not bounded by time and space, but continuing to flow, and pour forth new religious truths within the range of the Church formed under the guidance of the Holy Spirit. This doctrine is usually expressed in the following terms: the Catholic Church assumes a double outward source of the knowledge of religious truth, namely, the *Apostolic*, both *Scriptural* and *traditional*. The other great religious party makes a very marked distinction between the revealed doctrines laid down in the Scriptures and the later views and development of the same by the Church; in other words, they distinguish between Scriptural and traditional revelation. Their leading principle is that the Christian religion can be derived pure and unalloyed from the Bible alone; and they therefore reject, as unnecessary and unauthorised, all professed sources of religious knowledge which are foreign to the Holy Scriptures. As Christians of the latter category we here take the Scriptures as the *only* external source of revelation for religious truth; and in this point of view we also trace the outlines of theological science.

Thus considered, a little examination of the subject leads us to discover in it a threefold principle :—1. An eternal, ever-prevailing, and therefore immutable, Christian principle ; 2. Another, *established* upon this positive foundation ; and 3. One that is *developing* itself out of this. Our business is, therefore, not with a revealed doctrine which has long since been completed, which had lived, lost its spirit, and died ; but with one which, like the human mind itself, is continually expanding in youthful vigour—one which, when correctly comprehended, exhibits a mutual relationship and equal degree of development with whatever stage of culture and civilization its adherents, the Christians, may have reached. Thus it has happened that in process of time many truths which must ever be most essential to the Christian, have been variously and differently understood and interpreted. Every thinking Christian must strive to bring his religious opinions and actions into a possible, perfect, and continued harmony with a correct view of the doctrines contained in the Bible. *Christian Protestantism* is the spiritual advancement of humanity at the side of the Bible ; and the task of Christian theology must thus be to show, not only how far that end has been aimed at in past times and until now, but also in what manner man is to strive after it in time to come, and to indicate the means by which the teachings of the Scriptures are to be exhibited in their true unison with every advancement which mankind can make in knowledge and civilization.

It is thus evident that Christian theology stands in the closest relation to all the departments of human knowledge, and more especially to philosophy, to which, when duly applied, Christianity has ever been much indebted,—while it has caused her great damage and injury whenever its natural and necessary boundaries have been overpassed ; and it is not less clear that the efforts of the theologian must, above all, be directed towards a due comprehension and a progressively seasonable development and advancement of the always living Christian spirit contained in the Scriptural doctrines. This task pre-supposes a proper understanding of the Scriptures. Christian theology must, therefore, in the first instance, try to solve scientifically the questions—What is meant by Holy Writ ? How have its doctrines been understood until now ? And by what laws are we to proceed so as to arrive at a right understanding of their scope and spirit ? The results of these inquiries, systematically obtained, form a complete science in themselves. As Christianity, however, is not limited to abstract speculations, but has for its chief aim the enkindling and diffusion of true piety, in thought and in practice, Christian theology has further to display the means by which this Christian conviction may be on the one hand called forth in the soul of man and diffused abroad, and on the other quickened and defended. Christian theology is, finally, required to set forth the course which Christianity has pursued in former ages, and to describe its past vicissitudes and present condition.

The foundation of Christian theology must thus be sought in the Scriptures : and, divesting ourselves of all prepossessions and hypotheses, it will, in the first instance, be necessary for us to obtain a clear insight as to the

circumstances and the times in which the series of books which constitute the Scriptures came into existence. This leads us to the first branch of theological science, namely, to BIBLICAL ARCHÆOLOGY, or BIBLICAL ANTIQUITIES. Biblical Archæology, usually confined within too narrow limits, is that part of theological science which tries to unravel the various circumstances and conditions which have exercised more or less influence upon the composition of the Scriptural books. Its object is, therefore, to treat of:—

1. The nature of the country in which those books have originated ; to this branch of inquiry belong *Physical Geography* and *Natural History*. By the latter we understand not only (a common mistake) a systematic survey of the natural productions, but also and chiefly an enumeration of the peculiar features of their origin, growth, continuance, cultivation, use, etc. It is, for instance, quite immaterial what place the date-palms or balsam-shrubs occupy in the system—such investigations being of no importance for the understanding of the Bible, the writers of which have disregarded those points ; while, on the other hand, the peculiarities of the locality where the palm-tree stands, its external appearance at the different seasons of the year, its growth, fertility, use, etc.—in short, all that particularly strikes the sense of the beholder, have frequently exercised considerable influence on the inspired writers ; and these sources of external impressions on the senses and mind of man, are to be particularly considered and noticed by Biblical Archæology.
2. The inhabitants of those countries ; their peculiar character, manners, customs, way of living, and their intercourse with other nations.
3. The vicissitudes of their people,—consequently, the history of the Hebrews and Jews, down to that time when the last books of the Scriptures were written.
4. The politico-religious institutions, the civil and geographical order and division of the land and the people ; and
5. The mental development of the Hebrews and Jews, the regulations founded on it, and the degree of progress which the arts and sciences had attained among them.

Biblical Archæology may be further divided into two classes—that of the Old Testament and that of the New Testament : the former may again be subdivided into the *Hebrew* and the *Jewish* archæology.

As soon as the foundation for Biblical researches is laid by the help of Biblical Archæology, the theologian then turns to the solution of the second main question in theology:—What is meant by the Scriptures? How and when have they arisen? In what form do they lie before us? The answer to all these questions is the object of BIBLICAL INTRODUCTION, or, more correctly, of the *History of Holy Writ*. It is divided into Introduction to the Old Testament and Introduction to the New Testament. It must render an account—

1. Of the origin of the individual books received into the sacred canon ; not omitting to notice at the same time the various views that have been entertained on that point by critics of all ages, as well as those particular opinions which are seemingly the more correct.
2. Of the origin of the collection of the books of Scripture as the repository of Christian knowledge, or of religion ; constituting the *History of the Canon*.
3. Of the spread of the Scriptures by transcriptions, translations, and printing.
4. Of the vicissitudes and fate of the original text ; forming the *History of the Text* ; and—
5. Of the various motives which have led to various modes of understanding the Bible ; being the *History of Interpretation*.

We next come to that important part of Theological Encyclopædia connected with the question—What precepts have been regarded as Christian doctrines from the introduction of Christianity to the present day ?

The answer to this important question is given by DOCTRINE-HISTORY,* which, in a less limited sense than that in which the term is usually taken, points out the peculiar doctrines which have from time to time been received as articles of Christian belief. But as a variety of opinions with regard to the essentials of the Christian religion has arisen, not only among the various and different sects as separate bodies, but likewise at sundry times among the members of even one and the same sect or party, Doctrine-History must necessarily include all the peculiar features of schismatic views, their origin and history, the causes of their rise and gradual development, as well as their connection with the Scriptures, from which they all claim to be derived, and by which they must be tried.

A principle that is given out by a Christian sect as an essentially Christian doctrine, becomes an article of creed, a *dogma* (δόγμα = ὁ δέδοκται).

A *Dogma* is understood to be the doctrine of a particular party or sect, although that party may agree with the other sects in respect of other doctrines of Christianity, and must necessarily agree with them in regard to the spirit and central point of the Christian religion. Such dogmas, or articles of creed, are the fruit of a certain way of thinking peculiar to the age in which they arise, and obtain clerical importance when received either into the system of *Symbols* or into the public liturgy. All symbols must therefore only be considered as belonging to both a certain party and a certain time, and are thus not to be ranked among the eternal and universal articles of faith. The exhibition of a finished system of doctrines lies beyond the range of *Symbolik* ; it sets forth merely the

* *Dogmen-geschichte*, 'history of doctrines.' We have no corresponding term in the English language, and therefore propose that of *Doctrine-History*.

most essential truths, the fundamental elements, leaving the farther scientific or systematic details to the sphere of *Dogmatik*. *Dogmatik* is therefore immediately linked to the doctrines established by a certain party of Christians. An universal Christian *Dogmatik* is not to be hoped for, so long as there are different parties among Christians. We should therefore have to range Symbol, Dogma, and *Dogmatik* together, under the comprehensive head of Doctrine-History. Such history ought, however, not to be limited to actual dogmas alone, but ought likewise to embrace many of the more loose and unembodied doctrinal views and speculations; partly on account of the influence which they may have had upon the rise and reception of some embodied dogmas, and partly because history shows that some doctrinal views advanced but rejected in earlier times, have, perhaps after the lapse of some centuries, been reproduced, received, and sanctioned. A comparative survey of the various dogmas of the different sects or church parties is the object of *Comparative Dogmatik*; though it has hitherto limited its views chiefly to the dogmas of the principal sects alone.

It is greatly to be desired that the scope of *Comparative Dogmatik* should be so extended as to embrace the collection of those dogmas which have, from time to time, prevailed within the church of one and the same party—as, *e. g.*, of the Roman Catholics, with special regard to the variety of opinions entertained by this church on some doctrinal points, from her foundation in the second century, in comparison with those held in the fourth, fifth, and sixth centuries. This function of Doctrine-History has been too much confined to the established doctrines within *one* church-party alone; and this limitation is almost unavoidable with those sects which, like the Roman Catholics, look at all other sects as infidels,—a judgment surely as erroneous as it is partial and uncourteous.

CHRISTIAN MORALS is, properly speaking, only the practical part of *Dogmatik*, and was, indeed, formerly always exhibited only in its connection therewith. Its province is to show the influence which the Christian dogmas exercise upon the dispositions of the heart, or in what degree those dogmas may be brought into action upon the will of man. What, in our recent times, has often been called—especially on the part of some German Protestant theologians—*dogmatics* or *doctrines of faith*, without attaching to them any particular meaning of a sect or church-party, partakes mostly of a middle view between church *dogmatik*, Biblical theology, and religious philosophy, wavering between all, and belonging to none.

PATRISTICS* and PATROLOGY† seem to lie beyond the circle by which we have defined the limits of theological science. For the notion attached to the term ‘Fathers of the Church’ is not universally acknowledged by all Christian sects, and least so among Protestants, who consider it a contradiction to the

* PATRISTICS, the literary character and history of the Fathers.

† PATROLOGY, the doctrinal and ethical systems founded on their writings.

principle by which the Scriptures are recognised as the *only* source of the knowledge of religious truth.

The immense mass of manifold and various tenets which have prevailed as Christian doctrines at different times and in different countries, ever since the introduction of Christianity, makes it evidently impossible to ascertain what is real Christian doctrine, and what is not, if we do not take the SCRIPTURES as the only guide in this labyrinth. The science, therefore, which discloses to us the tenets of Holy Writ we call BIBLICAL EXEGESIS, or INTERPRETATION. It involves the difficult task of discovering the true meaning attached to the words by the writer. To be able to do this, a thorough knowledge of the language in which the author has written down his thoughts is indispensable; consequently, a profound knowledge of Hebrew for the Old Testament, and of Greek for the New Testament, is of the utmost necessity, and is one of the first requisites, in an expounder of the Bible. But as the Sacred Writings have greatly suffered from, and have been disfigured by the liberties of transcribers and emendators, it is needful to try to discover or restore the real words of the original text; and the science employed in this task is known by the name of BIBLICAL CRITICISM. By means of criticism and philological research the sense of the Biblical writings may be ascertained, *grammatically* or philologically. To this mode of exegesis or interpretation is given the name of *Grammatical Exposition*. But although it is most essential to correct interpretation of the Scriptures that the text should be grammatically considered, yet it is equally undeniable that philological exegesis is by itself insufficient to develop completely the meaning of the sacred writers in the words which they employ. To be able to do this completely and satisfactorily, it is necessary that the interpreter should possess the means of transporting himself into the times and into the spirit of the ages in which those writers lived; or, in other words, that he should be well acquainted with the historical conditions of those ages, and with the modes of thought which then prevailed; as well as with the circumstances affecting the particular position of the individual writer of every sacred book, and of the people whom he addressed. Biblical Archæology and Biblical Introduction are the proper instruments for the accomplishment of that object, which we call the Historical Interpretation of the Scriptures; the *true* and perfect Biblical Interpretation is thus comprised in the category of GRAMMATICO-HISTORICAL EXEGESIS,—a term implying conditions which are hardly ever found in an equal degree of profundity in one and the same interpreter.

A more easy, partial, and objectionable species of interpretation is that called DOGMATICAL EXEGESIS, which does not limit itself to an independent inquiry into the meaning of the sacred writings, but attempts rather to determine the sense of the text by arbitrary dogmas. Equally objectionable, and still more arbitrary, is the process of the ALLEGORICAL mode of exposition, which tortures the Biblical sense into figurative meanings; and which rarely fails to evince the essential difference that exists between the *mode* of

thinking in the author and the interpreter, or between the ancient and modern times.

HERMENEUTICS establishes the laws by which the interpreter is to proceed in his labours. Its relation to Interpretation is that of theory to practice. The suggestions which have led to the formation of Biblical Hermeneutics were given chiefly by Dogmatical Exegesis.

The requisites of theology are, however, not confined to the mere endeavour to discover by means of correct exegesis the true meaning of Holy Writ, or of particular passages in the New Testament; but the object of theology as a science is also and chiefly to collect the various religious views and doctrines dispersed in the Scriptures, and to compare and unite them into an entire system; and this science, aided by exegesis, is called BIBLICAL THEOLOGY, which is the true corner-stone of Biblical Exegesis. The inquiries involved in it are rendered difficult and intricate by the fact that the Scriptures were composed by various authors, and at different, and often at very long intervals. Biblical Theology must in the first instance be divided into two parts, that of the Old Testament and that of the New Testament. But at the time of the rise of Christianity and the writing of the New Testament, the Jews had already formed a theology of their own, founded upon what may be called exegetical explanations of the religious views set forth in the Old Testament, and which, although not essentially wrong in its principles, was considerably at variance with historical truth. This system of Jewish theology represents the religious opinions which prevailed in the time of Christ, in consequence of the peculiar views which the Jews entertained of the Old Testament writings and of the revelations contained in them; and it therefore supplies an intermediate link which is often of more direct use to us for understanding the theology of the New Testament, than the theology of the Old Testament viewed in its purer and more simple results. Neither the Biblical theology of the Old Testament, nor the Jewish theology in general, can be of binding force upon Christians, except in so far as either may be borne out by the Biblical theology of the New Testament. The former bear about the same relation to the latter as Biblical archæology does to the exegesis of the New Testament.

If the essence of Christianity be made a foundation for farther philosophical speculations, we arrive then at CHRISTIAN RELIGIOUS-PHILOSOPHY, which embodies into its system some but by no means all the doctrines of Scripture.

There have always been individuals, ever since Christianity has existed, who have particularly employed themselves in diffusing, enlivening, animating, and defending the Christian faith; and in most instances the Church, as an independent community, has made the conservation of the Christian interests the particular obligation of some of her members. Thus has arisen a science for itself, directed towards the care and preservation of Christianity, and usually called PRACTICAL THEOLOGY. The province of this science is of a threefold character:—

1. A guidance to the right method of calling forth Christian conviction either in those who had hitherto been attached to another religion,—PROSELYTISM, MISSIONARY-STUDIES; or in those who, although Christians, are still in want of Christian instruction,—CATECHETICS.
2. The preservation and religious animation of the Church community by means either of public worship itself,—LITURGICS; or of edifying discourses during the same,—HOMILETICS; or of that peculiar agency which has its sphere in domestic and private life,—PASTORAL THEOLOGY.
3. Defence of the Christian Church, by diverting the attacks made either against her rights,—CHURCH RIGHTS; or against her sublime truths,—APOLOGETICS.

Finally, Christianity having already existed for very many centuries as a religious institution, it must be for every man, as a *man*, and more particularly for the thinking Christian, of the highest importance to learn the origin of Christianity, its propagation and vicissitudes until our present times, and the extent and nature of the influence which it has exercised upon its votaries. The science which gives information on all these points is called CHURCH HISTORY, describing all the known facts belonging to the total process of development of Christianity. This science is of such an enormous extent as to compel its division into several departments, which have also been variously treated. Such are the *History of the Spread of Christianity; History of Church Doctrine; History of the Moral Influence of Christianity; History of Religious Confusions and Fanaticisms arising out of Christianity; History of Christian Civil Constitutions; History of the Relations of the Church to the State; Ecclesiastical Antiquities or Archæology; History of some Christian Sects, such as, History of the Jewish Christians; History of the Catholics; History of the Protestant Church, of the Presbyterians, Methodists, etc.; Church History of some Countries and Nations; History of Christian Literature.* In that part of Church History which describes the vicissitudes of the Church in times long gone by, the question at last suggests itself, What is the present state of Christianity in the world? The science which—far from being as yet sufficiently cultivated—solves this important question, goes by the name of CHURCH STATISTICS, and with it we may regard the sphere of THEOLOGICAL ENCYCLOPÆDIA as completed.

It cannot lie within the province of the present work as a *Cyclopædia of Biblical Literature* to embrace in the form of a dictionary all the subjects thus described as appertaining to Christian theology. Passing by systematic theology (which is the object of dogmatic history), practical theology, and church-history, the work comprises those branches of positive knowledge which are indispensable for the understanding of the Bible, and its historical interpretation, including, therefore, *Biblical Archæology* and *Biblical Introduction*, but leaving the application itself, together with grammatical criticism, to the department of *Biblical Interpretation*. The treatment of these matters in the form here adopted has

certainly the disadvantage of somewhat obscuring the survey and impeding the systematic development of the whole; but this disadvantage is greatly counter-balanced by the benefits arising from the easy and convenient use which in this form can be made of the abundant and various materials belonging to the subjects discussed: a dictionary of such a character has, moreover, this important advantage, that the subjects embraced in its plan can be handled with such fulness of criticism as the present age requires.

Attempts were early made to exhibit information pertaining to the Bible under the alphabetical arrangement of a dictionary. Of the many works of that kind, deserving notice, are: *Hierolexicon reale collectum, moderante*. Ad. Rechenbergio, Lipsiæ et Francf., 1714, 2 vols.; Aug. Calmet, *Dictionnaire Historique, Critique, Chronologique, Géographique, et Littérale de la Bible*, Paris, 1722, 2 vols., and (most complete) 1730, 4 vols. fol.; *Dictionnaire Universelle, Dogmatique, Canonique, Historique, et Chronologique des Sciences Ecclésiastiques, et avec des Sermons abrégés des plus célèbres Orateurs Chrétiens*, par le P. R. Richard et autres Religieux Dominicains, etc., Paris, 1760-64, 5 vols.; W. F. Hezel, *Biblisches Real-Lexicon, über Biblische, und die Bibel erläuternde alte Geschichte, Erdbeschreibung, Zeitrechnung, etc.*, Leipz., 1783-85, 3 vols., 4to.; F. G. Leun, *Bibl. Encyclopædie, oder exegetisches Real-wörterbuch über die Sämmtlichen Hülfswissenschaften des Auslegers, nach den Bedürfnissen jetziger Zeit. Durch eine Gesellschaft von Gelehrten*. Gotha, 1793-98, 4 vols., 4to.

Although the work of Calmet was the most learned and practically useful of all, the partial standing point of the author rendered it unsuited to the enlarged demands of the present age; which, with the superficiality and want of plan in later works, had brought performances of this kind into some disrepute; and it was reserved for George Benedict Winer, a theologian of Leipsic, to restore them to their former credit by his *Biblisches Real-wörterbuch*, Leip., 1820, 2 vols., 8vo., of which a second and improved edition was published in 1833-38. The sphere of that work is, however, too narrowly drawn, the critical treatment in it is of a very unequal character, and many of the subjects examined in its pages, especially in the department of natural history, have in reality no relation whatever to the Bible. Similar publications by various other writers have been produced on the Continent, but they cannot be regarded as exhibiting any claims to scientific criticism, or well-considered arrangement."

To particularise the works of the kind produced in our own country might appear invidious. It may suffice to say that they have all in their day served purposes of more or less usefulness, for which they are no longer available. All that has been done till now has been in various degrees based upon Calmet's great work; and the present is the only production which can be regarded as even professing to draw its materials from original sources of information. Calmet's

own work was composed in a great degree out of the materials already used by him in the notes, dissertations, and prefaces of his great work, the *Commentaire Littérale*. The first translation of it appeared in 1732, in three large and costly folio volumes, executed by two clergymen, Samuel d'Oyley, M.A., and John Colson, M.A., F.R.S., the former of whom translated to the letter M, and the other to the end of the book. This translation formed the great treasury from which were drawn the materials of the large number of lesser Dictionaries of the Bible which subsequently appeared. These exhibited little more diversity from each other than such as naturally arises where persons of different habits of mind form different abridgments of the same work, the original or new matter being chiefly exhibited by the interspersion of doctrinal articles in support of the particular views which the compiler entertained. At length a new edition of Calmet was undertaken by Mr. Charles Taylor, and appeared in 1795 in four, and in later editions in five, quarto volumes. This was a very eccentric performance, composed thus:—two volumes consisted of *an abridgment* of Calmet; one volume of engravings; and two volumes of 'Fragments.' These fragments contained a sprinkling of useful matter drawn from histories and travels; but three-fourths of the whole consist of singularly wild and fanciful speculations respecting mythology, ethnology, natural history, antiquities, and sundry other matters, and are replete with unsound learning, outrageous etymologies, and the vagaries of an undisciplined intellect. Calmet, thus transformed, and containing as much of the editor as of the original author, has in its turn formed the basis of the Biblical Dictionaries which have since appeared, including a very painstaking digest of the more useful parts of Taylor's matter incorporated with the Dictionary under one alphabet, the whole abridged into one volume royal 8vo., which appeared in 1832. This work was in the same year reproduced in America under the supervision of Dr. Robinson, who made some few but valuable additions to particular articles. For the sake of these additions, reference has in the present work been occasionally made to that edition, but more in the early than in the latter part, where the sources of such additions were rather sought in the German authorities from which they were found to be derived. This is the sole assistance which has been obtained from any edition of Calmet; and it is so trifling that no notice would have been taken of it here, were it not that Calmet's name has been in this country so much used in connection with such undertakings, that many readers would, without this explanation, be disposed to confound the present work with the numerous compilations based upon or made up out of his folios. Of Winer's *Biblisches Real-wörterbuch* more frequent use has, in some classes of subjects, been made; but rather as an index than as a direct source of materials; and not to any extent which can impair the claim of this work to be derived from original sources of information, rather than from other productions of the same description.

The Editor cannot but regard with peculiar satisfaction the ample refer-

ences to books which occur in almost every article, and which indicate to the reader the means of more extensive inquiry into the various subjects which have been noticed with indispensable brevity in this work. The numerous references to Scripture will greatly assist its chief use and design—the illustration of the sacred volume. It is believed that the articles in the departments of Biblical INTRODUCTION and CRITICISM embrace a body of information, respecting the books of Scripture and sacred criticism, such as no work of the kind in any language has hitherto contained. The NATURAL HISTORY of Scripture has now for the first time been examined, and as far as possible settled, not by mere scholars ignorant of natural history, but by naturalists of acknowledged eminence. The SCRIPTURE GEOGRAPHY has, by the help of Dr. Robinson's invaluable *Biblical Researches in Palestine*, and of other publications less known in this country, assumed in the present work a greatly altered and much more distinct aspect. The ARCHEOLOGICAL articles exhibit an extent of illustration and research which will tend greatly to elucidate the obscurities which the subjects necessarily involve. The HISTORY has been discussed under the influence of those broad principles which constitute its philosophy; and in this, as well as in the BIOGRAPHY, it has not been forgotten that while actions are always to be judged by the immutable standard of right and wrong which the word of God has established, the judgments which we pass upon men must be qualified by considerations of age, country, situation, and other incidental circumstances.

It is hoped that with such claims to attention, and embodying, as it does, the results of great labour and much anxious thought, the work now offered to the public will receive indulgent consideration for the minute errors, defects, and perhaps discrepancies, from which the Editor dares not hope that it is wholly exempt, and which are perhaps inevitable in a work executed by so many different hands, and involving so large a body of references, titles, and proper names.

JOHN KITTO.

Woking, Oct. 15th, 1845.

CYCLOPÆDIA

OF

BIBLICAL LITERATURE.

AARON.

AARON (אֲהֲרֹן, etymology and signification unknown; Sept. Ἀαρών), the eldest son of Amram and Jochebad, of the tribe of Levi, and brother of Moses. He was born n.c. 1574 (Hales, b.c. 1730), three years before Moses, and one year before Pharaoh's edict to destroy the male children of the Israelites (Exod. v. 20; vii. 7). His name first occurs in the mysterious interview which Moses had with the Lord, who appeared to him in the burning bush, while he kept Jethro's flock in Horeb. Among other excuses by which Moses sought to evade the great commission of delivering Israel, one was that he lacked that persuasive readiness of speech (literally was 'not a man of words') which appeared to him essential to such an undertaking. But he was reminded that his brother Aaron possessed in a high degree the endowment which he deemed so needful, and could therefore speak in his name and on his behalf. During the forty years' absence of Moses in the land of Midian, Aaron had married a woman of the tribe of Judah, named Elisheba (or Elizabeth), who had born to him four sons, Nadab, Abihu, Eleazar, and Ithamar; and Eleazar had, before the return of Moses, become the father of Phinehas (Exod. vi. 23-25).

Pursuant to an intimation from God, Aaron went into the wilderness to meet his long-exiled brother, and conduct him back to Egypt. After forty years of separation they met and embraced each other at the mount of Horeb. When they arrived in Goshen, Aaron, who appears to have been well known to the chiefs of Israel, introduced his brother to them, and assisted him in opening and enforcing the great commission which had been confided to him. In the subsequent transactions, from the first interview with Pharaoh till after the delivered nation had passed the Red Sea, Aaron appears to have been almost always present with his more illustrious brother, assisting and supporting him; and no separate act of his own is recorded. This co-operation was ever afterwards maintained. Aaron and Hur were present on the hill from which Moses surveyed the battle which Joshua fought with the Amalekites; and these two long sustained the weary hands upon whose uplifting the fate of the battle was found to depend (Exod. xvii. 10-12). Afterwards, when Moses ascended Mount Sinai to receive the tables of the law, Aaron, with his sons and seventy of the elders, accompanied him part of the way up, and, as a token of the Divine favour,

AARON.

were permitted to behold afar off the outskirts of that radiant symbol of the Sacred Presence, which Moses was allowed to view more nearly (Exod. xxiv. 1, 2, 9-11).

The absence of Moses in the mountain was prolonged for forty days, during which the people seem to have looked upon Aaron as their head, and an occasion arose which first brings the respective characters of the brothers into real comparison, and the result fully vindicates the Divine preference of Moses by showing that, notwithstanding the seniority and greater eloquence of Aaron, he wanted the high qualities which were essential in the leader of the Israelites, and which were possessed by Moses in a very eminent degree. The people grew impatient at the protracted stay of their great leader in the mountain, and at length concluded that he had perished in the devouring fire that gleamed upon its top. The result of this hasty conclusion gives us the first intimation of the extent to which their minds were tainted with the rank idolatries of Egypt. Recognising the authority of their lost chief's brother, they gathered around him, and clamorously demanded that he should provide them with a visible symbolic image of their God, that they might worship him as other gods were worshipped. Either afraid to risk the consequences of a refusal, or imperfectly impressed with the full meaning of the recent and authoritative prohibition of all such attempts to represent or symbolize the Divine Being, Aaron complied with their demand; and with the ornaments of gold which they freely offered, cast the figure of a calf [CALE, GOLDEN], being, probably, no other than that of the Egyptian god Mnevis, whose worship prevailed in Lower Egypt. However, to fix the meaning of this image as a symbol of the true God, Aaron was careful to proclaim a feast to Jehovah for the ensuing day. On that day the people met to celebrate the feast, after the fashion of the Egyptian festivals of the calf-idol, with dancing, with shouting, and with sports.

Meanwhile Moses had been dismissed from the mountain, provided with the decalogue, written 'by the finger of God,' on two tablets of stone. These, as soon as he came sufficiently near to observe the proceedings in the camp, he cast from him with such force that they brake in pieces. His re-appearance confounded the multitude, who quailed under his stern rebuke, and quietly submitted to see their new-made idol destroyed. For

this sin the population was decimated by sword and plague. Aaron, when taxed by his brother for his conduct in this matter, attempted to excuse himself by casting the whole blame upon the people, and pleading the necessity of circumstances (Exod. xxxii.).

During his long absence in the mountain, Moses had received instructions regarding the ecclesiastical establishment, the tabernacle [TABERNACLE], and the priesthood [PRIESTS], which he soon afterwards proceeded to execute. Under the new institution Aaron was to be high-priest, and his sons and descendants priests; and the whole tribe to which he belonged, that of Levi, was set apart as the sacerdotal or learned caste [LEVITES]. Accordingly, after the tabernacle had been completed, and every preparation made for the commencement of actual service, Aaron and his sons were consecrated by Moses, who anointed them with the holy oil and invested them with the sacred garments. The high-priest applied himself assiduously to the duties of his exalted office, and during the period of nearly forty years that it was filled by him, his name seldom comes under our notice. But his elevation was soon followed by a most afflictive event. His two eldest sons, Nadab and Abihu, were struck dead for daring, seemingly when in a state of partial inebriety, to conduct the service of God in an irregular manner, by offering incense with unlawful fire. On this occasion it was enjoined that the priests should manifest none of the ordinary signs of mourning for the loss of those who were so dear to them. To this heavy stroke Aaron bowed in silence (Lev. x. 1-11).

Aaron would seem to have been liable to some fits of jealousy at the superior influence and authority of his brother; for he joined in, or at least sanctioned the invidious conduct of his sister Miriam [MIRIAM], who, after the wife of Moses had been brought to the camp by Jethro, became apprehensive for her own position, and cast reflections upon Moses, much calculated to damage his influence, on account of his marriage with a foreigner—always an odious thing among the Hebrews. For this, Miriam was struck with temporary leprosy, which brought the high-priest to a sense of his sinful conduct, and he sought and obtained forgiveness (Num. xii.).

Some twenty years after (b.c. 1471); when the camp was in the wilderness of Paran, a formidable conspiracy was organized against the sacerdotal authority exercised by Aaron and his sons, and the civil authority exercised by Moses. This conspiracy was headed by chiefs of influence and station—Korah, of the tribe of Levi, and Dathan and Abiram, of the tribe of Reuben [KORAH]. But the divine appointment was attested and confirmed by the signal destruction of the conspirators: and the next day, when the people assembled tumultuously and murmured loudly at the destruction which had overtaken their leaders and friends, a fierce pestilence broke out among them, and they fell by thousands on the spot. When this was seen, Aaron, at the command of Moses, filled a censer with fire from the altar, and, rushing forward to the point where life had ended and death had not begun, he stood there, and the plague was stayed where he stood. This was in fact another attestation of the Divine appointment; and, for its further confirmation, as regarded

Aaron and his family, the chiefs of the several tribes were required to deposit their staves, and with them was placed that of Aaron for the tribe of Levi. They were all laid up together over night in the tabernacle, and in the morning it was found that, while the other rods remained as they were, that of Aaron had budded, blossomed, and yielded the fruit of almonds. The rod was preserved in the tabernacle, as an authentic evidence of the divine appointment of the Aaronic family to the priesthood—which, indeed, does not appear to have been ever afterwards disputed (Num. xvii. 1).

Aaron was not allowed to enter the Promised Land, on account of the distrust which he, as well as his brother, manifested when the rock was stricken at Meribah (Num. xx. 8-13). His death indeed occurred very soon after that event. For when the host arrived at Mount Hor, in going down the Wady Arabah [ARABAH], in order to double the mountainous territory of Edom, the Divine mandate came that Aaron, accompanied by his brother Moses and by his son Eleazer, should ascend to the top of that mountain in the view of all the people; and that he should there transfer his pontifical robes to Eleazer, and then die. He was 123 years old when his career thus strikingly terminated; and his son and his brother buried him in a cavern of the mountain [HOR, MOUNT]. The Israelites mourned for him thirty days; and on the first day of the month Ab, the Jews still hold a fast in commemoration of his death.

AARONITES, the descendants of Aaron, who served as priests at the sanctuary (Num. iv. 5, seq.; 1 Chron. xii. 27; xxvii. 17).

AB (אב, father) is found as the first member of several compound Hebrew proper names, the etymology and meaning of which may be explained by a few remarks on the laws of their construction. This is the more necessary, as Leusden, Hiller, and Simonis, the authors of the three most celebrated *Onomastica Sacra*, as well as the many who blindly follow them, indifferently take the former or latter member of such compounds to be in the relation of genitive to the other, *i. e.* consider it equally legitimate to say, *Abner* means *father of light*, or *light of the father*. Nevertheless, it may be laid down as an incontestable canon—being founded not merely on an accessory law, but on one of the characteristic peculiarities of the Syro-Arabian languages (that is, on the *state construct*)—that, in all cases in which a compound name consists of two nouns, *one of which is to be considered in the relation of genitive to the other*, that one must invariably be the latter. *Abner*, therefore, can only mean *father of light*.

This error appears to have arisen (besides the want of sure principles of construction) from the inability to appreciate the metaphorical sense in which the Hebrews use the terms *father*, *son*, &c. The name *Abigail*, *father of joy*, appeared inexplicable as the name of a woman; and therefore those scholars thought it allowable to sacrifice the construction to the necessities of the sense. And yet it is not difficult to conceive the process by which the idea of a natural father became modified into that of *author*, *cause*, *source* (as when it is said, 'has the rain a father?' Job

xxxviii. 28); nor that, when once the language had sanctioned the use of father as equivalent to source, the word might be sometimes treated as an abstract, in idea, and be applied without gross incongruity to a woman.

As the Ethiopic, and especially the Arabic languages very frequently use *father* in the sense of *possessor* (as *father of white*, a name for milk), some have been disposed to vindicate the same privilege to Hebrew also. Thus Gesenius seems to have entertained this view, when he rendered *Abigail* by 'pater exultationis, i. e. hilaris,' in his *Thesaurus*. In the German edition of his *Manual*, however, he has explained it by 'whose father is joy.' Into the question as to the principle involved in the latter of his modes of interpretation, there is no need to enter; the immediate object of this article being solely to define the relation of the two nouns in a compound proper name, when one of them is considered dependent as a genitive on the other.

Very much light yet remains to be thrown on compound Hebrew proper names, by a study of those of the same class in Arabic. The innumerable compound *prænomina* and *cognomina* which the Arabs bestow not only on men, but on beasts and inanimate objects, furnish parallels to almost every peculiarity observable in Hebrew; and although no example may be found in which a woman is called *father* of joy, yet the principle of the metaphorical use of terms of relationship, as the first element in a name, will receive ample illustration, and be brought within the reach of our occidental conceptions. (See an instructive paper on the *Prænomina* of the Arabs, by Kosegarten, in Ewald's *Zeitschrift für die Kunde des Morgenlandes*, i. 297-317.)—J. N.

AB (אב); 'אבבא, Joseph. *Antiq.* iv. 4; the Macedonian ἄβος is the Chaldee name of that month which is the fifth of the ecclesiastical and eleventh of the civil year of the Jews. The name was first introduced after the Babylonian captivity, and does not occur in the Old Testament, in which this month is only mentioned by its numeral designation as *the fifth*. It commenced with the new moon of our *August* (the reasons for this statement will be given in the article MONTHS), and always had 30 days. This month is pre-eminent in the Jewish calendar as the period of the most signal national calamities. The 1st is memorable for the death of Aaron (Num. xxxiii. 38). The 9th is the date assigned by Moses Cotzensis (cited in Wagenseil's *Sota*, p. 736) to the following events: the declaration that no one then adult, except Joshua and Caleb, should enter into the Promised Land (Num. xiv. 30); the destruction of the first Temple by Nebuchadnezzar (to these first two 'the fast of the fifth month,' in Zech. vii. 5; viii. 19, is supposed to refer; yet the tract *Pesachim*, cited in Reland's *Antiq. Sacr.*, iv. 10, asserts that the latter was the only fast observed during the Captivity); the destruction of the second Temple by Titus; the devastation of the city Betar (בֵּיתר); and the slaughter of Ben Cozibah (Bar Cocab), and of several thousand Jews there; and the ploughing up of the foundations of the Temple by Turnus Rufus—the two last of which happened in the time of Hadrian.

With regard to the destruction of the first Temple, although there is no doubt that the Jews commemorate that event by a fast on the 9th of Ab, yet the *seventh* is the date given for it in 2 Kings xxv. 8 (where, however, the Syriac and Arabic versions read the *ninth*), and the *tenth* that assigned in Jer. lii. 12. Josephus, however, in mentioning that the Herodian Temple was burnt on the *tenth* of Lous, expressly asserts that it was on the *same* day of the month on which the first Temple was destroyed (*Bell. Jud.* vi. 4, 5). Buxtorf, in his *Synag. Jud.* ch. xxx., reconciles the discrepancy between the 9th as the day of commemoration and the 10th as the date of the event, by saying that the conflagration *began* on the former day. Compare also Wagenseil's *Sota*, p. 942.

In a calendar ascribed to the celebrated astronomer Rab Ada, who lived in the third century, which Bodenschatz has given in his *Kirchliche Verfassung der Juden*, ii. 106, the 15th is the day appointed for the festival of the ξυλοφωλα, in which the wood for the burnt-offering was stored up in the court of the Temple, to which Nehemiah alludes in x. 34, and xiii. 31. Some place this festival on another day, or even month; or assume, on the authority of the treatise *Taanith*, that nine particular families brought wood on nine separate days, four of which, however, occur in Ab (Otho, *Lexicon Rabbin.* p. 380). The election of particular families accords with the statement in Nehemiah. Nevertheless, Josephus, speaking of this festival, says, ἐν ἡ πάσων ἔθος ἕλην προσφέρειν (*Bell. Jud.* ii. 17); and the date of the day succeeding it, which he mentions in the next section, fixes its celebration, in his time, on the 14th of the month. It is, however, extremely difficult to distinguish the original from the later forms in any rite of a people so prone to multiply its ceremonial observances as the Jews were.

Lastly, the *Megillat Taanith* states that the 18th is a fast in memory of the western lamp going out in the Temple in the time of Ahaz. It may be conjectured that this refers to the extinction of 'the lamps' which is mentioned in 2 Chron. xxix. 7, as a part of Ahaz's attempts to suppress the Temple service. For an inquiry into what is meant by the *western* or *evening* lamp, see the article CANDLESTICK.—J. N.

ABADDON, or APOLLYON (אבדון, *destruction*; Ἀβαδδὸν in Rev. ix. 11, where it is rendered by the Greek Ἀπολλύων, *destroyer*). The former is the Hebrew name, and the latter the Greek, for the angel of death, described (Rev. ix. 11) as the king and chief of the Apocalyptic locusts under the fifth trumpet, and as the angel of the abyss or 'bottomless pit.' This personification is peculiar to the present text. In the Bible, and in every Rabbinical instance that occurs to us, the word אבדון (*abaddon*) means destruction (Job xxxi. 12), or the place of destruction, i. e. the subterranean world, Hades, the region of the dead (Job xxvi. 6; xxviii. 22; Prov. xv. 11). It is in fact the second of the seven names which the Rabbins apply to that region; and they deduce it particularly from Ps. lxxxviii. 11, 'Shall thy loving kindness be declared in the grave, or thy faithfulness in (*abaddon*) destruction?' [HADES.]

ABANA, or AMANA (אָמָנָה or אֲבָנָה; the former being the *kethib* or Hebrew text, and the latter the *keri* or marginal reading; Sept. *Abana*), the name of one of the rivers which are mentioned by Naaman (2 Kings v. 12), 'Abana and Pharpar,' as 'rivers of Damascus.' Amana signifies 'perennial,' and is probably the true name, the permutation of *b* and *m* being very common in the Oriental dialects. It is easy to find 'rivers of Damascus;' but there is a difficulty in appropriating the distinctive names which are here applied to them. The main stream by which Damascus is now irrigated is called *Barrada*. This river, the Chrysorroas, or 'golden stream,' of the ancient geographers, as soon as it issues from a cleft of the Anti-Lebanon mountains, is immediately divided into three smaller courses. The central or principal stream runs straight towards the city, and there supplies the different public cisterns, baths, and fountains; the other branches diverge to the right and left along the rising ground on either hand, and having furnished the means of extensive irrigation, fall again into the main channel, after diffusing their fertilizing influences, without which the whole would be an arid desert, like the vast surrounding plains. In those plains the soil is in some parts even finer than here, but barren from the want of water. The main stream and its subsidiaries unite in greatly weakened force beyond the town on the south-east; and the collected waters, after flowing for two or three hours through the eastern hills, are at length lost in a marsh or lake, which is known as the *Bahr el Merdj*, or Lake of the Meadow. Dr. Richardson (*Travels*, ii. 499) states that the 'water of the Barrada, like the water of the Jordan, is of a white sulphureous hue, and an unpleasant taste.' At the present day it seems scarcely possible to appropriate with certainty the Scriptural names to these streams. There is indeed a resemblance of name which would suggest the Barrada to be the Pharpar, and then the question would be, which of the other streams is the Abana. But some contend that the Barrada is the Abana, and are only at a loss for the Pharpar. Others find both in the two subsidiary streams, and neglect the Barrada. The most recent conjecture seeks the Abana in the small river *Fidgi* or *Fijih*, which Dr. Richardson describes as rising near a village of the same name in a pleasant valley fifteen or twenty miles to the north-west of Damascus. It issues from the limestone rock, in a deep, rapid stream, about thirty feet wide. It is pure and cold as iced water; and, after coursing down a stony and rugged channel for above a hundred yards, falls into the Barrada, which comes from another valley, and at the point of junction is only half as wide as the *Fijih*. Dr. Mansford (*Script. Gaz.* in ABANA), who adopts the notion that the Abana was one of the subsidiary streams, well remarks that 'Naaman may be excused his national prejudice in favour of his own rivers, which, by their constant and beautiful supply, render the vicinity of Damascus, although on the edge of a desert, one of the most beautiful spots in the world; while the streams of Judæa, with the exception of the Jordan, are nearly dry the greater part of the year, and, running in deep and rocky channels, convey but partial fertility to the lands through which they flow.'

ABARIM (עֲבָרִים; Sept. Ἀβαρίμ), a mountain (הַר הָעֲבָרִים), or rather chain of mountains (הַרְיֵה עֲבָרִים) which form or belong to the mountainous district east of the Dead Sea and the lower Jordan. It presents many distinct masses and elevations, commanding extensive views of the country west of the river (Irby and Mangles, p. 459). From one of the highest of these, called Mount Nebo, Moses surveyed the Promised Land before he died. From the manner in which the names Abarim, Nebo, and Pisgah are connected (Deut. xxxii. 49, 'Get thee up into this mountain Abarim, unto Mount Nebo;' and xxxiv. 1, 'Unto the mountain of Nebo, to the top of Pisgah'), it would seem that Nebo was a mountain of the Abarim chain, and that Pisgah was the highest and most commanding peak of that mountain. The loftiest mountain of the neighbourhood is Mount Attarous, about ten miles north of the Arnon; and travellers have been disposed to identify it with Mount Nebo. It is represented as barren, its summit being marked by a wild pistachio-tree overshadowing a heap of stones. The precise appropriation of the three names, however, remains to be determined, as this locality has not yet (1843) had the advantage of such searching exploration as Professor Robinson has applied to Western Palestine.

[*Cucurbita citrullus*.]

ABATTACHIM (אֲבַטָּחִים; Sept. Ἀβαττίμος). This word occurs only in Numbers xi. 5, where the murmuring Israelites say, 'We remember the fish which we did eat freely in Egypt, the cucumbers and the *abattachim*,' &c. The last word has always been rendered 'MELONS.' The probable correctness of this translation may be inferred from melons having been known to the nations of antiquity; and it may be proved to be so, by comparing the original term with the name of the melon in a cognate language such as the Arabic.

The cucurbitaceæ, or gourd tribe, are remarkable for their power of adapting themselves to the different situations where they can be grown. Thus Mr. Elphinstone describes some of them as yielding large and juicy fruit in the midst of the Indian desert, where water is 300 feet from the surface. Extreme of moisture, however, is far from injurious to them, as the great majority are successfully cultivated in the rainy season in India. Mr. Moorcroft describes an ex-

tensive cultivation of melons and cucumbers on the beds of weeds which float on the lakes of Cashmere. They are similarly cultivated in Persia and in China. In India, 'some of the species may be seen in the most arid places, others in the densest jungles. Planted at the foot of a tree, they emulate the vine in ascending its branches; and near a hut, they soon cover its thatch with a coating of green. They form a principal portion of the culture of Indian gardens: the farmer even rears them in the neighbourhood of his wells' (Royle, *Himalayan Botany*, p. 218).

These plants, though known to the Greeks, are not natives of Europe, but of Eastern countries, whence they must have been introduced into Greece. They probably may be traced to Syria or Egypt, whence other cultivated plants, as well as civilization, have travelled westwards. In Egypt they formed a portion of the food of the people at the very early period when the Israelites were led by Moses from its rich cultivation into the midst of the desert. The melon, the water-melon, and several others of the Cucurbitaceæ, are mentioned by Wilkinson (*Thebes*, p. 212; *Ancient Egyptians*, iv. 62), as still cultivated there, and are described as being sown in the middle of December, and cut, the melons in ninety and the cucumbers in sixty days.

If we consider that the occurrences so graphically detailed in the Bible took place in the East, we should expect, among the natural products noticed, that those which appear from the earliest times to have been esteemed in these countries would be those mentioned. But as all are apt to undervalue the good which they possess, and think of it only when beyond their reach, so the Israelites in the desert longed for the delicious coolness of the melons of Egypt. Among these we may suppose both the melon and water-melon to have been included, and therefore both will be treated of in this article.

By the term *Abattachim* there is little doubt that melons are intended, as, when we remove the plural form *im*, we have a word very similar to the Arabic **بطيخ** *Butikh*, which is the name

of the melon in that language. This appears, however, to be a generic term, inasmuch as they employ it simply to indicate the common or musk melon, while the water-melon is called *Butikh-hindee*, or Indian melon. The former is called in Persian *khurpoozeh*, and in Hindee *khurbooja*. It is probably a native of the Persian region, whence it has been carried south into India, and north into Europe, the Indian being a slight corruption of the Persian name. As the Arabian authors append *fufash* as the Greek name of *butikh*, which is considered to be the melon, it is evident that *fufash* must, in their estimation, be the same. From there being no *p* in Arabic, and as the diacritical point *noon* might, by transcribers, have easily been mistaken for that of *shen*, it is more than probable that this is intended for *πέπων*, especially if we compare the description in Avicenna with that in Dioscorides. By Galen it was called *Melopepo*, from *melo* and *pepo*, the former from being roundish in form like the apple. The melon is supposed to have been the *σίκκος* of Theophrastus, and the *σίκκος πέπων* of Hippo-

crates. It was known to the Romans, and cultivated by Columella, with the assistance of some precaution at cold times of the year. It is said to have been introduced into this country about the year 1520, and was called musk-melon to distinguish it from the pumpkin, which was usually called melon.

The melon, being thus a native of warm climates, is necessarily tender in those of Europe, but, being an annual, it is successfully cultivated by gardeners with the aid of glass and artificial heat of about 75° to 80°. The fruit of the melon may be seen in great variety, whether with respect to the colour of its rind or of its flesh, its taste or its odour, and also its external form and size. The flesh is soft and succulent, of a white, yellowish, or reddish hue, of a sweet and pleasant taste, of an agreeable, sometimes musk-like odour, and forms one of the most delicious of fruits, which, when taken in moderation, is wholesome, but, like all other fruits of a similar kind, is liable to cause indigestion and diarrhoea when eaten in excess, especially by those unaccustomed to its use.

All travellers in Eastern countries have borne testimony to the refreshment and delight they have experienced from the fruit of the melon. But we shall content ourselves with referring to Alpinus, who, having paid particular attention to such subjects, says of the Egyptians, 'Fructibus, &c. se replent, ut ex iis solis sæpe cenam, vel prandium perficiant, cujusmodi sunt precocia, cucurbitæ, pepones, melopepones; quorum quidem nomen genericum est Batech' (*Rerum Egypt. Hist.* l. 17). He also describes in the same chapter the kind of melon called Abdellavi, which, according to De Sacy, receives its name from having been introduced by Abdullaï, a governor of Egypt under the Khalif Al Mamoon. It may be a distinct species, as the fruit is oblong, tapering at both ends, but thick in the middle, a figure (tab. xli.) is given in his work *De Plantis Egypti*; but Forskal applies this name also to the Chate, which is separately described by Alpinus, and a figure given by him at tab. xl.

The *Cucumis Chate* is a villous plant with trailing stems, leaves roundish, bluntly angled, and toothed; the fruit pilose, elliptic, and tapering to both ends. 'Horum usum corporibus in cibo ipsis tum crudis, tum coctis vescentibus, salubrem esse apud omnes eorum locorum incolæ creditur' (Alpin. *l. c.* p. 54). Hasselquist calls this the 'Egyptian melon' and 'queen of cucumbers,' and says that it grows only in the fertile soil round Cairo; that the fruit is a little watery, and the flesh almost of the same substance as that of the melon, sweet and cool. 'This the grandees and Europeans in Egypt eat as the most pleasant fruit they find, and that from which they have the least to apprehend. It is the most excellent fruit of this tribe of any yet known' (Hasselquist, *Travels*, p. 258). Forskal, uniting the Abdellavi and Chate into one species, says it is the commonest of all fruits in Egypt, and is cultivated in all their fields, and that many prepare from it a very grateful drink (*Flora Egyptiaco-Arabica*, p. 168).

With the melon it is necessary to notice the Water-Melon, which is generally supposed to be specially indicated by the term *Battich*. But

this it would be difficult to determine in the affirmative in a family like the cucurbitaceæ, where there are so many plants like each other, both in their herbage and fruit. In the first place, the term Battich is rather generic than specific, and, therefore, if *Abattachim* were similarly employed, it might include the water-melon, but not to the exclusion of the others. In the second place, it is doubtful whether the water-melon was introduced into Egypt at a very early period, as we find no distinct mention of it in Greek writers. It is now common in all parts of Asia. It seems to have been first distinctly mentioned by Serapion under the name of Dullaha, which in the Latin translation is interpreted, 'id est melo magnus viridis;' and Sethio is quoted as the earliest author who applies the term 'Ἀγγούριον' to the water-melon, as has subsequently been frequently the case, though it is often distinguished as *Anguria indica*. Serapion, however, quotes Rhases, Mescha, and Ishmahelita. In the Persian books referred to in a Note, the author finds *Battich hindee* given as the Arabic of *turbooz*, which is the name assigned in India to the water-melon. So Alpinus, speaking of the anguria in Egypt, says, 'vulgo *Batech el Maovi* (water), et in Scriptoribus Medicis *Batech-Indi* vel *Anguria indica* dicitur.' One of the Persian names is stated to be *hinduanah*. It may be indigenous to India, but it is difficult, in the case of this as of other long-cultivated plants, to ascertain its native country with certainty. For, even when we find such a plant apparently wild, we are not sure that the seed has not escaped from cultivation; and at present we know that the water-melon is cultivated in all parts of Asia, in the north of Africa, and in the south of Europe.

The water-melon is clearly distinguished by Alpinus as cultivated in Egypt, and called by the above names, 'quæ intus semina tantum, et aquam dulcissimam continent.' It is mentioned by Forskal, and its properties described by Hasselquist. Though resembling the other kinds very considerably in its properties, it is very different from them in its deeply-cut leaves, from which it is compared to a very different plant of this tribe—that is, the colocynth. 'Citrullus folio colocynthidis secto semine nigro.' A few others have cut leaves, but the water-melon is so distinguished among the edible species. The plant is hairy, with trailing cirriferous stems. The pulp abounds so much in watery juice, that it will run out by a hole made through the rind; and it is from this peculiarity that it has obtained the names of water-melon, melon d'eau, wasser-melon. Hasselquist says that it is cultivated on the banks of the Nile, in the rich clayey earth which subsides during the inundation, and serves 'the Egyptians for meat, drink, and physic. It is eaten in abundance, during the season, even by the richer sort of people; but the common people, on whom Providence hath bestowed nothing but poverty and patience, scarcely eat anything but these, and account this the best time of the year, as they are obliged to put up with worse at other seasons of the year' (*Travels*, p. 256).—J. F. R.

* In concluding the first article in this work on the botany of the Bible, the author thinks it desirable to state the mode in which he has

studied the subject, and the grounds upon which he has formed his opinions, whether they agree with or differ from those of previous writers. He has already related, in his 'Essay on the Antiquity of Hindoo Medicine,' that his attention was first directed to the identification of the natural products mentioned in ancient authors, in consequence of being requested by the Medical Board of Bengal to investigate the medicinal plants and drugs of India, for the purpose of ascertaining how far the public service might be supplied with medicines grown in India, instead of importing them nearly all from foreign countries. In effecting this important object, his first endeavour was to make himself acquainted with the different drugs which the natives of India are themselves in the habit of employing as medicines. For this purpose he had to examine the things themselves, as well as to ascertain the names by which they were known. He therefore directed specimens of every article in the bazars to be brought to him, whether found wild in the country or the produce of culture—whether the result of home manufacture or of foreign commerce—whether of the animal, vegetable, or mineral kingdom—whether useful as food or as medicine, or employed in any of the numerous arts which minister to the wants or comforts of man. In order to acquire a knowledge of their names, he caused the native works on *Materia Medica* to be collated by competent hakeems and moonshees, and the several articles arranged under the three heads of the animal, vegetable, and mineral kingdoms. The works collated were chiefly the 'Mukhzun-ul-Udwieh,' 'Tohfah-al-Moomeeneen,' 'Ihtiarut Buddie,' and 'Taleef Shereef,' all of them in Persian, but consisting principally of translations from Arabic authors. These were themselves indebted for much of their information respecting drugs to Dioscorides; but to his descriptions the Persians have fortunately appended the Asiatic synonymes, and references to some Indian products not mentioned in the works of the Arabs. The author himself made a catalogue of the whole, in which, after the most usually received, that is, the Arabic name, the several synonymes in Persian, Hindee, &c., as well as in metamorphosed Greek, were inserted. He traced the articles as much as possible to the plants, animals, and countries whence they were derived; and attached to them their natural history names, whenever he was successful in ascertaining them.

Being without any suitable library for such investigations, and being only able to obtain a small copy of Dioscorides, he was in most cases obliged to depend upon himself for the identification of the several substances. The results of several of these investigations are briefly recorded in his observations on the history and uses of the different natural families of plants, in his 'Illustrations of the Botany of the Himalayan Mountains.' The author also made use of these materials in his 'Essay on the Antiquity of Hindoo Medicine,' in tracing different Indian products from the works of the Arabs into those of the Greeks, even up to the time of Hippocrates. He inferred that tropical products could only travel from south to north, and that the Hindoos must have ascertained their properties, and used them as medicines, before they became suffi-

ciently famous to be observed and recorded by the Greeks. Having thus traced many of these Eastern products to the works of almost contemporary authors, he was led to conclude that many of them must be the same as those mentioned in the Bible, especially as there is often considerable resemblance between their Arabic and Hebrew names (*Essay*, p. 138).

Although, like Hasselquist, Alpinus, Forskal, and others, the author studied these subjects in Eastern countries, yet he differs from them all in the circumstances under which he pursued his inquiries. His investigations were carried on while he was resident in the remotest of the Eastern nations known in early times, who were probably among the first civilized, and who are still not only acquainted with the various drugs and their names, but possess an ancient literature, in which many of these very substances are named and arranged. Having obtained the drugs, heard their names applied by the natives, read their descriptions, and traced them to their plants, he formed many of his opinions from independent sources. It may therefore be considered a strong confirmation of the correctness of his results when they agree with those of previous inquirers; when they differ, it must be ascribed to the peculiar process by which they have been obtained.—J. F. R.



[*Cucumis melo*.]

ABBA (אבבא, אבבא) is the Hebrew word אב, *father*, under a form peculiar to the Chaldee idiom. The Aramaic dialects do not possess the definite article in the form in which it is found in Hebrew. They compensate for it by adding a syllable to the end of the simple noun, and thereby produce a distinct form, called by grammarians the *emphatic*, or *definitive*, which is equivalent (but with much less strictness in its use, especially in Syriac) to a noun with the article in Hebrew. This emphatic form is also commonly used to express the vocative case of our language—the context alone determining when it is to be taken in that sense (just as the noun with the article is sometimes similarly used in Hebrew). Hence this form is appropriately employed in all the passages in which it occurs in the New Testament (Mark xiv. 36; Rom. viii. 15; Gal. iv. 6): in all of which it is an invocation. Why *Abba* is, in all these passages, immediately rendered by δ πατήρ, instead of πάτερ,

may perhaps be in part accounted for on the supposition that, although the Hellenic (as well as the classical) Greek allows the use of the nominative with the article for the vocative (Winer, *Gram. des Neutest. Sprach.* § 29), the writers of the New Testament preferred the former, because the article more adequately represented the force of the emphatic form.

It is also to be observed that, in the usage of the Targums, אבבא, even when it is the subject of an ordinary proposition, may mean *my father*; and that the absolute form of the word is not used with the suffix of the *first* person singular. Lightfoot has endeavoured (*Horæ Hebr. ad Marc.* xiv. 36) to show that there is an important difference between the Hebrew אב and the Chaldee אבבא: that whereas the former is used for all senses of *father*, both strict and metaphorical, the latter is confined to the sense of a *natural* or *adoptive* father. This statement, which is perhaps not entirely free from a doctrinal bias, is not strictly correct. At least the Targums have rendered the Hebrew *father* by אבבא, in Gen. xlv. 8, and Job xxxviii. 28, where the use of the term is clearly metaphorical; and, in later times, the Talmudical writers (according to Buxtorf, *Lex. Talm.*) certainly employ אבבא to express *rabbi, master*—a usage to which he thinks reference is made in Matt. xxiii. 9.—J. N.

ABBREVIATIONS. As there are satisfactory grounds for believing that the word *Selah*, in the Psalms, is not an anagram, the earliest positive evidence of the use of abbreviations by the Jews occurs in some of the inscriptions on the coins of Simon the Maccabee. Some of these, namely, have יש for ישראל, and חר for חרות; and some of those of the first and second years have נ and ש; the former of which is considered to be a numeral letter, and the latter an abbreviation for שנת ב, *anno II.* (Bayer, *De Numis Hebræo-Samaritanis*, p. 171). It is to be observed, however, that both these latter abbreviations alternate on other equally genuine coins, with the full legends שנת אחת and שנת שתיים; and that the coins of the third and fourth years invariably express both the year and the numeral in *words* at length.

The earliest incontestable evidence of the use of abbreviations in the copies of the Old Testament is found in some few extant MSS., in which common words, not liable to be mistaken, are curtailed of one or more letters at the end. Thus ישׁר is written for ישראל; and the phrase כי לעולם חסדו, so frequently recurring in Ps. cxxxvi., is in some MSS. written כ ל ח. Yet even this licence, which is rarely used, is always denoted by the sign of abbreviation, an oblique stroke on the last letter, and is generally confined to the end of a line; and as all the MSS. extant (with hardly *two* exceptions) are later than the tenth century, when the Rabbinical mode of abbreviation had been so long established and was carried to such an extent, the infrequency and limitation of the licence, under such circumstances, might be considered to favour the belief that it was not more freely employed in earlier times.

Nevertheless, some learned men have endeavoured to prove that abbreviations must have

been used in the MSS. of the sacred text which were written before the Alexandrian version was made; and they find the grounds of this opinion in the existence of several Masoretic various readings in the Hebrew text itself, as well as in the several discrepancies between it and the ancient versions, which may be plausibly accounted for on that assumption. This theory supposes that both the copyists who resolved the abbreviations (which it is assumed existed in the ancient Hebrew MSS. prior to the LXX.) into the entire full text which we now possess, and the early translators who used such abbreviated copies, were severally liable to error in their solutions. To illustrate the application of this theory to the Masoretic readings, Eichhorn (*Einleit. ins A. T.* i. 323) cites, among other passages, Jos. viii. 16, in which the Kethib is עָרִי, and the Keri עָרִי; and 2 Sam. xxiii. 20, in which הָי is the Kethib, and הָיִל the Keri. With regard to the versions, *Drusius* suggests that the reason why the LXX. rendered the words (Jon. i. 9) אֲנֹכִי עֲבָרִי, by δούλος κυπριον εἶμυ, was because they mistook the *Resh* for *Daleth*, and believed the *Jod* to be an abbreviation of *Jehovah*, as if it had been originally written עֲבָרִי (*Quæst. Ebraic.* iii. 6). An example of the converse is cited from Jer. vi. 11, where our text has חֲמַת יְהוָה, which the LXX. has rendered θυμὸς μου, as if the original form had been חֲמַתִּי, and they had considered the *Jod* to be a suffix, whereas the later Hebrew copyists took it for an abbreviation of the sacred name. Kennicott's three *Dissertations* contain many similar conjectures; and *Stark's Davidis aliorumque Carminum Libri V.* has a collection of examples out of the ancient versions, in which he thinks he traces false solutions of abbreviations.

In like manner some have endeavoured to account for the discrepancies in statements of numbers in parallel passages and in the ancient versions, by assuming that numbers were not expressed in the early MSS. by entire words (as they invariably are in our present text), but by some kind of abbreviation. *Ludolf*, in his *Commentar. ad Hist. Æthiop.* p. 85, has suggested that numeral letters may have been mistaken for the initial letter, and, consequently, for the abbreviation of a numeral word, giving as a pertinent example the case of the Roman V being mistaken for *Viginti*. He also thinks the converse to have been possible. Most later scholars, however, are divided between the alternative of letters or of arithmetical cyphers analogous to our figures. The last was the idea *Cappellus* entertained (*Critica Sacra*, i. 10), although *De Vignoles* appears to have first worked out the theory in detail in his *Chronologie de l'Histoire Sainte*: whereas *Scaliger* (cited in *Walton's Prolegomena*, vii. 14) and almost all modern critics are in favour of letters. *Kennicott* has treated the subject at some length; but the best work on it is that of *J. M. Faber*, entitled *Literas olim pro vocibus in numerando à scriptoribus V. T. esse adhibitās*, Onoldi, 1775, 4to.

It is undeniable that it is much easier to explain the discordant statements which are found, for instance, in the parallel numbers of the 2nd chapter of *Ezra* and the 7th of *Nehemiah*, by having recourse to either of these suppositions,

than it is to conceive how such very dissimilar signs and sounds, as the entire names of the Hebrew numerals are, could be so repeatedly confounded as they appear to have been. This adequacy of the theory to account for the phenomena constitutes the internal argument for its admission. *Gesenius* has also, in his *Geschichte der Hebräischen Sprache*, p. 173, adduced the following external grounds for its adoption: the fact that both letters and numeral notes are found in other languages of the Syro-Arabian family, so that neither is altogether alien to their genius; letters, namely, in Syriac, Arabic, and later Hebrew; numeral figures on the Phœnician coins and Palmyrene inscriptions (those employed by the Arabs and transmitted through them to us are, it is well known, of Indian origin). And although particular instances are more easily explained on the one supposition than on the other, yet he considers that analogy, as well as the majority of examples, favours the belief that the numerals were expressed, in the ancient copies, by letters; that they were then liable to frequent confusion; and that they were finally written out at length in words, as in our present text.

There is an easy transition from these abbreviations to those of the later Hebrew, or Rabbinical writers, which are nothing more than a very extended use and development of the same principles of stenography. Rabbinical abbreviations, as defined by *Danz*, in his valuable *Rabbinismus Emucleatus*, § 65, are either perfect, when the initial letters only of several words are written together, and a double mark is placed between such a group of letters, as in אַמְנוֹת, the common abbreviation of the Hebrew names of the books of *Job*, *Proverbs*, and *Psalms* (the last letters only of words are also written in *Cabbalistical* abbreviations); or imperfect, where more than one letter of a single word is written, and a single mark is placed at the end to denote the mutilation, as יִשְׂרָאֵל for יִשְׂרָאֵל. The perfect abbreviations are called by the Rabbinical writers רֵאשִׁי תִיבּוֹת, i. e. capitals of words. When proper names, as frequently happens, are abbreviated in this manner, it is usual to form the mass of consonants into proper syllables by means of the vowel *Patach*, and to consider *Jod* and *Vau* as representatives of *I* and *U*. Thus רַמְבַּם, *Ramban*, the abbreviation of 'Rabbi Mosheh ben Maimon,' and רַשִׁי, *Rashi*, that of 'Rabbi Shelomoh Jarchi,' are apposite illustrations of this method of contraction. Some acquaintance with the Rabbinical abbreviations is necessary to understand the Masoretic notes in the margin of the ordinary editions of the Hebrew text; and a considerable familiarity with them is essential to those who wish, with ease and profit, to consult the Talmud and Jewish commentators. The elder *Buxtorf* wrote a valuable treatise on these abbreviations, under the title *De Abbreviaturis Hebraicis*, which has often been reprinted; but, from the inexhaustible nature of the subject, *O. G. Tychsen* added two valuable supplements, in 1768, and *Selig* incorporated them with his own researches in his *Compendia vocum Hebraico-Rabbinicarum*, Lips. 1780, which is the completest work of the kind extant.

With regard to the abbreviations in the MSS

of the New Testament, it may be observed that they have furnished little matter for critical inquiry. Those that exist are almost exclusively confined to common and easily supplied words, e. g. *God, Lord, father, son, &c.*; or to the terminations of formation and inflexion, in which case they fall more properly under the province of general Greek Palæography. They very rarely furnish any hint of the mode in which a various reading has arisen, as has been suggested, for instance, in the case of *καυφῶ* and *κυριῶ* in Romans xii. 11. The use of letters for numerals, however, according to Eichhorn's *Einleit. ins N. T.*, iv. 199, is not only found in some MSS. now extant, but, in the instance of the number 666, in Rev. xiii. 18, can be traced up to the time of the apostles; partly on the testimony of Irenæus, and partly because those MSS. which wrote the number out in words differ in the gender of the first word, some writing *ἑξακόσιοι*, some *ἑξακόσια*, some *ἑξακόσια*. The early fathers have also unhesitatingly availed themselves of the theory that numbers were originally denoted by letters, whenever they wished to explain a difficulty in numbers. Thus Severus of Antioch (cited by Theophylact) accounts for the difference of the hour of our Lord's crucifixion, as stated in Mark xv. 25, and John xix. 14, by the mistake of γ (3) for s (6). Eichhorn has given a lithographed table of the most usual abbreviations in the MSS. of the New Testament.

Lastly, the abbreviations by which Origen, in his 'Hexapla,' cites the Septuagint and other Greek versions, deserve some notice. The nature of this work rendered a compendious mode of reference necessary; and, accordingly, numeral letters and initials are the chief expedients employed. A large list of them may be seen in Montfaucou's edition of the 'Hexapla;' and Eichhorn (*Einleit. ins A. T.* i. 548-50) has given those which are most important.—J. N.

1. ABDON (אָבְדֹן, *a servant*; Sept. Ἀβδὸν), the son of Hillel, of the tribe of Ephraim, and tenth judge of Israel. He succeeded Elon, and judged Israel eight years. His administration appears to have been peaceful; for nothing is recorded of him but that he had forty sons and thirty nephews, who rode on young asses—a mark of their consequence (Judg. xii. 13-15). Abdon died B.C. 1112.

There were three other persons of this name, which appears to have been rather common. They are mentioned in 1 Chron. viii. 29; ix. 36; xxxiv. 20.

2. ABDON, a city of the tribe of Asher, which was given to the Levites of Gershom's family (Job xxi. 30; 1 Chron. vi. 74).

ABEDNEGO (אֲבֵדְנֵגוֹ, *servant of Nego*, i. e. Nebo; Sept. Ἀβδενεγός), the Chaldee name imposed by the king of Babylon's officer upon Azariah, one of the three companions of Daniel. With his two friends, Shadrach and Meshach, he was miraculously delivered from the burning furnace, into which they were cast for refusing to worship the golden statue which Nebuchadnezzar had caused to be set up in the plain of Dura (Dan. iii.).

ABEL (אָבֵל; Sept. Ἀβελ), properly HEBEL, the second son of Adam, who was slain by Cain,

his elder brother (Gen. iv. 1-16). The circumstances of that mysterious transaction are considered elsewhere [CAIN]. To the name *Abel* a twofold interpretation has been given. Its primary signification is *weakness or vanity*, as the word אָבֵל, from which it is derived, indicates. By another rendering it signifies *grief or lamentation*, both meanings being justified by the Scripture narrative. CAIN (*a possession*) was so named to indicate both the joy of his mother and his right to the inheritance of the first-born: Abel received a name indicative of his weakness and poverty when compared with the supposed glory of his brother's destiny, and *prophetically* of the pain and sorrow which were to be inflicted on him and his parents.

Ancient writers abound in observations on the mystical character of Abel; and he is spoken of as the representative of the pastoral tribes, while Cain is regarded as the author of the nomadic life and character. St. Chrysostom calls him the *Lamb of Christ*, since he suffered the most grievous injuries solely on account of his innocency (*Ad Stagir.* ii. 5); and he directs particular attention to the mode in which Scripture speaks of his offerings, consisting of the best of his flock, 'and of the fat thereof,' while it seems to intimate that Cain presented the fruit which might be most easily procured (*Hom. in Gen.* xviii. 5). St. Augustin, speaking of regeneration, alludes to Abel as representing the new or spiritual man in contradistinction to the natural or corrupt man, and says, 'Cain founded a city on earth, but Abel as a stranger and pilgrim looked forward to the city of the saints which is in heaven' (*De Civitate Dei*, xv. i.). Abel, he says in another place, was the first-fruits of the Church, and was sacrificed in testimony of the future Mediator. And on Ps. cxviii. (*Serm.* xxx. sec. 9) he says: 'this city' (that is, 'the city of God') 'has its beginning from Abel, as the wicked city from Cain.' Irenæus says that God, in the case of Abel, subjected the just to the unjust, that the righteousness of the former might be manifested by what he suffered (*Contra Hæres.* iii. 23).

Heretics existed in ancient times who represented Cain and Abel as embodying two spiritual powers, of which the mightier was that of Cain, and to which they accordingly rendered divine homage.

In the early Church Abel was considered the first of the martyrs, and many persons were accustomed to pronounce his name with a particular reverence. An obscure sect arose under the title of *Abelites*, the professed object of which was to inculcate certain fanatical notions respecting marriage; but it was speedily lost amid a host of more popular parties.—H. S.

ABEL (אָבֵל; Sept. Ἀβέλ), a name of several villages in Israel, with additions in the case of the more important, to distinguish them from one another. From a comparison of the Arabic and Syriac, it appears to mean *fresh grass*; and the places so named may be conceived to have been in peculiarly verdant situations. In 1 Sam. vi. 18, it is used as an appellative, and probably signifies a *grassy plain*.

ABEL, ABEL-BETH-MAACHAH, or ABEL-MAIM, a city in the north of Palestine, which seems to have been of considerable strength from his his-

tory, and of importance from its being called 'a mother in Israel' (2 Sam. xx. 19). The identity of the city under these different names will be seen by a comparison of 2 Sam. xx. 14, 15, 18; 1 Kings xv. 20; 2 Chron. xvi. 4. The addition of 'Maacah' marks it as belonging to, or being near to, the region Maacah, which lay eastward of the Jordan under Mount Lebanon. This is the town in which Sheba posted himself when he rebelled against David. Eighty years afterwards it was taken and sacked by Benhadad, king of Syria; and 200 years subsequently by Tiglath-pileser, who sent away the inhabitants captives into Assyria (2 Kings xx. 29).

ABEL-BETH-MAACHAH, that is, Abel near the house or city of Maacah: the same as Abel.

ABEL-CARMAIM (אֲבֵל כַּרְמַיִם), *place of the vineyards*; Sept. Ἐβελχαρμίμ, a village of the Ammonites, about six miles from Philadelphia, or Rabbath Ammon, according to Eusebius, in whose time the place was still rich in vineyards (Judg. xi. 33).

ABEL-MAIM. The same as ABEL.

ABEL-MEHOLAH, or ABEL-MEA (אֲבֵל מְחֹלָה), *place of the dance*; Sept. Ἀβελμουλά, a town supposed to have stood near the Jordan, and some miles (Eusebius says ten) to the south of Bethshan or Scythopolis (1 Kings iv. 12). It is remarkable in connection with Gideon's victory over the Midianites (Judg. vii. 22), and as the birth-place of Elisha (1 Kings xix. 16).

ABEL-MIZRAIM (אֲבֵל מִצְרַיִם), *the mourning of the Egyptians*; Sept. Πένθος Αἰγύπτου, the name of a threshing-floor, so called on account of the 'great mourning' made there for Jacob by the funeral party from Egypt (Gen. L. 11). Jerome places it between Jericho and the Jordan, where Bethagla afterwards stood.

ABEL-SHITTIM (אֲבֵל הַשִּׁטִּים), *place of acacias*; Sept. Βελσῶ, a town in the plains of Moab, on the east of the Jordan, between which and Beth-Jesimoth was the last encampment of the Israelites on that side the river (Num. xxxiii. 49). It is more frequently called Shittim merely (Num. xxv. 1; Josh. ii. 1; Mic. vi. 5). Eusebius says it was in the neighbourhood of Mount Peor; and in the time of Josephus it was known as Abila, and stood sixty stadia from the Jordan (*Antiq. iv. 8, 1; v. 1, 1*). The place is noted for the severe punishment which was there inflicted upon the Israelites when they were seduced into the worship of Baal-Peor, through their evil intercourse with the Moabites and Midianites.

ABELA. [ABILA.]

ABI, the mother of King Hezekiah (2 Kings xviii. 2), called also Abijah (2 Chron. xxix. 1). Her father's name was Zachariah, perhaps the same who was taken by Isaiah (viii. 2) for a witness.

ABIA. [ABIJAH, 3.]

ABIAH or ABIJAH (אֲבִיָּה, *pater Jehova*, i. e. *vir divinus*, ut videtur, i. q. אֵישׁ אֱלֹהִים, *Gesenius in Thesaur.*; Sept. Ἀβιά), one of the sons of Samuel, who were intrusted with the administration of justice, and whose misconduct afforded the ostensible ground on which the Israelites demanded that their government should be changed into a monarchy (1 Sam. viii. 1-5).

ABI-ALBON. [ABIEL 2.]

ABIATHAR (אֲבִיָּתָר, *father of abundance*; Sept. Ἀβιάθαρ), the tenth high-priest of the Jews, and fourth in descent from Eli. When his father, the high-priest Abimelech, was slain with the priests at Nob, for suspected partiality to the fugitive David, Abiathar escaped the massacre; and bearing with him the most essential part of the priestly raiment [EPIPHON], repaired to the son of Jesse, who was then in the cave of Adulam (1 Sam. xxii. 20-23; xxiii. 6). He was well received by David, and became the priest of the party during its exile and wanderings. As such he sought and received for David responses from God. When David became king of Judah he appointed Abiathar high-priest. Meanwhile Zadok had been appointed high-priest by Saul, and continued to act as such while Abiathar was high-priest in Judah. The appointment of Zadok was not only unexceptionable in itself, but was in accordance with the divine sentence of deposition which had been passed, through Samuël, upon the house of Eli (1 Sam. ii. 30-36). When, therefore, David acquired the kingdom of Israel, he had no just ground on which Zadok could be removed, and Abiathar set in his place; and the attempt to do so would probably have been offensive to his new subjects, who had been accustomed to the ministrations of Zadok, and whose good feeling he was anxious to cultivate. The king got over this difficulty by allowing both appointments to stand; and until the end of David's reign Zadok and Abiathar were joint high-priests. How the details of duty were settled, under this somewhat anomalous arrangement, we are not informed. As a high-priest Abiathar must have been perfectly aware of the divine intention that Solomon should be the successor of David: he was therefore the least excusable, in some respects, of all those who were parties in the attempt to frustrate that intention by raising Adonijah to the throne. So his conduct seems to have been viewed by Solomon, who, in deposing him from the high-priesthood, and directing him to withdraw into private life, plainly told him that only his sacerdotal character, and his former services to David, preserved him from capital punishment. This deposition of Abiathar completed the doom long before denounced upon the house of Eli, who was of the line of Ithamar, the younger son of Aaron. Zadok, who remained the high-priest, was of the elder line of Eleazer. Solomon was probably not sorry to have occasion to remove the anomaly of two high-priests of different lines, and to see the undivided pontificate in the senior house of Eleazer (1 Kings i. 7, 19; ii. 26, 27).

In Mark ii. 26, a circumstance is described as occurring 'in the days of Abiathar, the high-priest,' which appears, from 1 Sam. xxi. 1, to have really occurred when his father Abimelech was the high-priest. Numerous solutions of this difficulty have been offered. The most probable in itself is that which interprets the reference thus 'in the days of Abiathar, who was afterwards the high-priest' (Bishop Middleton, *Greek Article*, pp. 188-190). But this leaves open another difficulty which arises from the precisely opposite reference (in 2 Sam. viii. 17; 1 Chron. xviii. 16; xxiv. 3, 6, 31) to 'Abimelech, the son of Abia-

that,' as the person who was high-priest along with Zadok, and who was deposed by Solomon; whereas the history describes that personage as Abiathar, the son of Abimelech. The only explanation which seems to remove all these difficulties—although we cannot allege it to be altogether satisfactory—is, that both father and son bore the two names of Abimelech and Abiathar, and might be, and were called by, either. But although it was not unusual for the Jews to have two names, it was *not* usual for both father and son to have the same two names. We therefore incline to leave the passage in Mark ii. 26, as explained above; and to conclude that the other discrepancies arose from an easy and obvious transposition of words by the copyists, which was afterwards perpetuated. In these places, the Syriac and Arabic versions have 'Abiathar, the son of Abimelech.'

ABIB. [NISAN.]

1. ABIEL (אֲבִי־אֵל, *father of strength*, i. e. *strong*; Sept. 'Αβιήλ), the father of Kish, whose son Saul was the first king of Israel, and of Ner, whose son Abner was captain of the host to his cousin Saul (1 Sam. ix. 1; xiv. 5).

2. ABIEL, one of the thirty most distinguished men of David's army (1 Chron. xi. 32). He is called Abi-albon (אֲבִי־עֲלֹבֹן) in 2 Sam. xxiii. 31; a name which has precisely the same signification (*father of strength*) as the other.

ABIEZER (אֲבִי־עֵזֶר, *father of help*; Sept. 'Αβιέζω, Josh. xvii. 2), a son of Gilead, the grandson of Manasseh (Num. xxvi. 30), and founder of the family to which Gideon belonged, and which bore his name as a patronymic—Abiezrites (Judg. vi. 34; viii. 2). Gideon himself has a very beautiful and delicate allusion to this patronymic in his answer to the fierce and proud Ephraimites, who, after he had defeated the Midianites with 300 men, chiefly of the family of Abiezer, came to the pursuit, and captured the two Midianitish princes Zeba and Zalmunna. They sharply rebuked him for having engrossed all the glory of the transaction by not calling them into action at the first. But he soothed their pride by a remark which insinuated that their exploit, in capturing the princes, although late, surpassed his own in defeating their army:—'What have I done now in comparison with you? Is not the (grape) *gleaning* of Ephraim better than the *vintage* of Abiezer?' (Judg. viii. 1-3).

ABIGAIL (אֲבִיגַיִל or אֲבִיגַיִל, *father of joy*; Sept. 'Αβρυγαία), the wife of a prosperous sheepmaster, called Nabal, who dwelt in the district of Carmel, west of the Dead Sea. She is known chiefly for the promptitude and discretion of her conduct in taking measures to avert the wrath of David, which, as she justly apprehended, had been violently excited by the insulting treatment which his messengers had received from her husband [NABAL]. She hastily prepared a liberal supply of provisions, of which David's troop stood in much need—and went forth to meet him, attended by only one servant. When they met, he was marching to exterminate Nabal and all that belonged to him; and not only was his rage mollified by her prudent remonstrances and delicate management, but he became sensible

that the vengeance which he had purposed was not warranted by the circumstances, and was thankful that he had been prevented from shedding innocent blood. The beauty and prudence of Abigail made such an impression upon David on this occasion, that when, not long after, he heard of Nabal's death, he sent for her, and she became his wife (1 Sam. xxv. 14-42). By her it is usually stated that he had two sons, Chileab and Daniel; but it is more likely that the Chileab of 2 Sam. iii. 3, is the same as the Daniel of 1 Chron. iii. 1; the son of Abigail being known by both these names.

1. ABIHAIL (אֲבִי־חַיִל, *father of light or splendour*; Sept. 'Αβιαία), the wife of Rehoboam, king of Judah. She is called the daughter of Eliab, David's elder brother (2 Chron. xi. 18): but, as David began to reign more than eighty years before her marriage, and was 30 years old when he became king, we are doubtless to understand that she was only a descendant of Eliab. This name, as borne by a female, illustrates the remarks under AB.

2. ABIHAIL (אֲבִי־חַיִל, *father of might*, i. e. *mighty*; Sept. 'Αβιχαίλ). This name, although the same as the preceding in the authorized version, is, in the original, different both in orthography and signification. It should be written ABICHAIL. The name was borne by several persons: 1. ABICHAIL, the son of Huri, one of the family-chiefs of the tribe of Gad, who settled in Bashan (1 Chron. v. 14); 2. ABICHAIL, the father of Zurie!, who was the father of the Levitical tribes of Merari (Num. iii. 35); 3. ABICHAIL, the father of queen Esther, and brother of Mordecai (Esth. ii. 15).

ABIHU (אֲבִי־חַי, *father of him*; Sept. 'Αβιούδ), the second of the sons of Aaron, who, with his brothers Nadab, Eleazer, and Ithamar, was set apart and consecrated for the priesthood (Exod. xxviii. 1). When, at the first establishment of the ceremonial worship, the victims offered on the great brazen altar were consumed by fire from heaven, it was directed that this fire should always be kept up; and that the daily incense should be burnt in censers filled with it from the great altar. But one day, Nadab and Abihu presumed to neglect this regulation, and offered incense in censers filled with 'strange' or common fire. For this they were instantly struck dead by lightning, and were taken away and buried in their clothes without the camp [AARON]. There can be no doubt that this severe example had the intended effect of enforcing becoming attention to the most minute observances of the ritual service. As immediately after the record of this transaction, and in apparent reference to it, comes a prohibition of wine or strong drink to the priests, whose turn it might be to enter the tabernacle, it is not unfairly surmised that Nadab and Abihu were intoxicated when they committed this serious error in their ministrations (Lev. x. 1-11).

1. ABIJAH (אֲבִי־יָהוּ, see signif. in ABIAH; Sept. 'Αβιά, 2 Chron. xiii. 1). He is also called Abijam (אֲבִיָּאָם; Sept. 'Αβισού, 1 Kings xv. 1). Lightfoot (*Harm. O. T.* in loc.) thinks that the writer in Chronicles, not describing his reign as wicked, admits the sacred JAH in his name; but which the book of Kings, charging him with fol-

lowing the evil ways of his father, changes into JAM. This may be fanciful; but such changes of name were not unusual. Abijah was the second king of the separate kingdom of Judah, being the son of Rehoboam, and grandson of Solomon. He began to reign B.C. 958 (Hales, B.C. 973), in the eighteenth year of Jeroboam, king of Israel; and he reigned three years. At the commencement of his reign, looking on the well-founded separation of the ten tribes from the house of David as rebellion, Abijah made a vigorous attempt to bring them back to their allegiance. In this he failed; although a signal victory over Jeroboam, who had double his force and much greater experience, enabled him to take several cities which had been held by Israel. The speech which Abijah addressed to the opposing army before the battle has been much admired. It was well suited to its object, and exhibits correct notions of the theocratical institutions. His view of the political position of the ten tribes with respect to the house of David is, however, obviously erroneous, although such as a king of Judah was likely to take. The numbers reputed to have been present in this action are 800,000 on the side of Jeroboam, 400,000 on the side of Abijah, and 500,000 left dead on the field. Hales and others regard these extraordinary numbers as corruptions, and propose to reduce them to 80,000, 40,000, and 50,000 respectively, as in the Latin Vulgate of Sixtus Quintus, and many earlier editions, and in the old Latin translation of Josephus; and probably also in his original Greek text, as is collected by De Vignoles from Abarnel's charge against the historian of having made Jeroboam's loss no more than 50,000 men, contrary to the Hebrew text (Kennicott's *Dissertations*, i. 533; ii. 201, &c. 564). The book of Chronicles mentions nothing concerning Abijah adverse to the impressions which we receive from his conduct on this occasion; but in Kings we are told that 'he walked in all the sins of his father' (1 Kings xv. 3). He had fourteen wives, by whom he left twenty-two sons and sixteen daughters. Asa succeeded him.

There is a difficulty connected with the maternity of Abijah. In 1 Kings xv. 2, we read, 'His mother's name was Maachah, the daughter of Abishalom;' but in 2 Chron. xiii. 2, 'His mother's name was Michaiah, the daughter of Uriel of Gibeah.' Maachah and Michaiah are variations of the same name; and Abishalom is in all likelihood Absalom, the son of David. The word (מַתָּה) rendered 'daughter' is applied in the Bible not only to a man's child, but to his niece, grand-daughter, or great-grand-daughter. It is therefore probable that Uriel of Gibeah married Tamar, the beautiful daughter of Absalom (2 Sam. xiv. 27), and by her had Maachah, who was thus the daughter of Uriel and grand-daughter of Absalom.

2. ABIJAH, son of Jeroboam I., king of Israel. His severe and threatening illness induced Jeroboam to send his wife with a present [PRESENT], suited to the disguise in which she went, to consult the prophet Ahijah respecting his recovery. This prophet was the same who had, in the days of Solomon, foretold to Jeroboam his elevation to the throne of Israel. Though blind with age, he knew the disguised wife of Jeroboam, and was authorized, by the prophetic impulse that came

upon him, to reveal to her that, because there was found in Abijah only, of all the house of Jeroboam, 'some good thing towards the Lord,' he only, of all that house, should come to his grave in peace, and be mourned in Israel. Accordingly, when the mother returned home, the youth died as she crossed the threshold of the door. 'And they buried him, and all Israel mourned for him' (1 Kings xiv. 1-18).

3. ABIJAH, one of the descendants of Eleazer, the son of Aaron, and chief of one of the twenty-four courses or orders into which the whole body of the priesthood was divided by David (1 Chron. xxiv. 10). Of these the course of Abijah was the eighth. Only four of the courses returned from the captivity, of which that of Abijah was not one (Ezra ii. 36-39; Neh. vii. 39-42; xii. 1). But the four were divided into the original number of twenty-four, with the original names; and it hence happens that Zecharias, the father of John the Baptist, is described as belonging to the course of Abijah or 'Abia' (Luke i. 5).

ABIJAM [ABIJAH, 1.]

ABILA, capital of the Abilene of Lysanias (Luke iii. 1); and distinguished from other places of the same name as the Abila of Lysanias (Ἀβίλη τοῦ Λυσανίου), and (by Josephus) as 'the Abila of Lebanon.' It is unnecessary to reason upon the meaning of this Greek name; for it is obviously a form of the Hebrew *Abel*, which was applied to several places, and means a grassy spot. This has been supposed to be the same as Abel-beth-Maachah, but without foundation, for that was a city of Naphtali, which Abila was not. An old tradition fixes this as the place where Abel was slain by Cain, which is in unison with the belief that the region of Damascus was the land of Eden. But the same has been said of other places bearing the name of Abel or Abila, and appears to have originated in the belief (created by the Septuagint and the versions which followed it) that the words are identical; but, in fact, the name of the son of Adam is in Hebrew *Hebel* (הֶבֶל), and therefore different from the repeated local name of *Abel* (אֵבֶל). However, under the belief that the place and district derived their name from Abel, a monument upon the top of a high hill, near the source of the river Barrada, which rises among the eastern roots of Anti-Libanus, and waters Damascus, has long been pointed out as the tomb of Abel, and its length (thirty yards) has been alleged to correspond with his stature! (Quaresmius, *Elucid. Terræ Sanctæ*, vii. 7, 1; Maundrell, under May 4th). This spot is on the road from Heliopolis (Baalbec) to Damascus, between which towns—thirty-two Roman miles from the former and eighteen from the latter—Abila is indeed placed in the Itinerary of Antoninus. About the same distance north-west of Damascus is Souk Wady Barrada, where an inscription was found by Mr. Banks, which, beyond doubt, identifies that place with the Abila of Lysanias (*Quart. Rev.* xxvi. 388; Hogg's *Damascus*, i. 301). Souk means market, and is an appellation often added to villages where periodical markets are held. The name of Souk (Wady) Barrada first occurs in Burckhardt (*Syria*, p. 2); and he states that there are here two villages, built on the opposite sides of the Barrada. The lively and refreshing green of this neigh-

bourhood is noticed by him and other travellers, and undesignedly suggests the propriety of the name of Abel, in its Hebrew acceptation of a grassy spot.

ABILENE (Αβιλινη, Luke iii. 1), the small district or territory which took its name from the chief town, Abila. Its situation is in some degree determined by that of the town; but its precise limits and extent remain unknown. Northward it must have reached beyond the Upper Barrada, in order to include Abila; and it is probable that its southern border may have extended to Mount Hermon (Jebel es-Sheikh). It seems to have included the eastern declivities of Anti-Libanus, and the fine valleys between its base and the hills which front the eastern plains. This is a very beautiful and fertile region, well wooded, and watered by numerous springs from Anti-Libanus. It also affords fine pastures; and in most respects contrasts with the stern and barren western slopes of Anti-Libanus.

This territory had been governed as a tetrachate by Lysanias, son of Ptolemy and grandson of Menæus (Joseph. *Antiq.* xiv. 13, 3), but he was put to death, B.C. 33, through the intrigues of Cleopatra, who then took possession of the province (*Antiq.* xiv. 4, 1). After her death it fell to Augustus, who rented it out to one Zenodorus; but as he did not keep it clear of robbers, it was taken from him, and given to Herod the Great (*Antiq.* xv. 10, 1; *Bell. Jud.* i. 20, 4). At his death, a part (the southern, doubtless) of the territory was added to Trachonitis and Iturea to form a tetrarchy for his son Philip; but by far the larger portion, including the city of Abila, was then, or shortly afterwards, bestowed on another Lysanias, mentioned by Luke (iii. 1), who is supposed to have been a descendant of the former Lysanias, but who is nowhere mentioned by Josephus. Indeed, nothing is said by him or any other profane writer, of this part of Abilene until about ten years after the time referred to by Luke, when the emperor Caligula gave it to Agrippa I. as 'the tetrarchy of Lysanias' (Joseph. *Antiq.* xviii. 6, 10), to whom it was afterwards confirmed by Claudius. At his death, it was included in that part of his possessions which went to his son Agrippa II. This explanation (which we owe to the acuteness and research of Winer), as to the division of Abilene between Lysanias and Philip, removes the apparent discrepancy between Luke, who calls Lysanias tetrarch of Abilene at the very time that, according to Josephus, (a part of) Abilene was in the possession of Philip.

1. ABIMELECH (אֲבִימֶלֶךְ, *father of the king*, or perhaps *royal father*; Sept. Ἀβιμέλεχ), the name of the Philistine king of Gerar in the time of Abraham (Gen. xx. 1, *sqq.*: B.C. 1898; Hales, B.C. 2054); but, from its recurrence, it was probably less a proper name than a titular distinction, like PHARAOH for the kings of Egypt, or AUGUSTUS for the emperors of Rome. Abraham removed into his territory after the destruction of Sodom; and fearing that the extreme beauty of Sarah might bring him into difficulties, he declared her to be his sister. The conduct of Abimelech in taking Sarah into his harem, shows that even in those early times kings claimed the right of taking to themselves the unmarried females not only of their natural

subjects, but of those who sojourned in their dominions. Another contemporary instance of this custom occurs in Gen. xii. 15; and one of later date in Esth. ii. 3. But Abimelech, obedient to a divine warning communicated to him in a dream, accompanied by the information that Abraham was a sacred person who had intercourse with God, restored her to her husband. As a mark of his respect he added valuable gifts, and offered the patriarch a settlement in any part of the country; but he nevertheless did not forbear to rebuke, with mingled delicacy and sarcasm, the deception which had been practised upon him (Gen. xx.). The most curious point in this transaction seems to be, that it appears to have been admitted, on all hands, that he had an undoubted right to appropriate to his harem whatever unmarried woman he pleased—all the evil in this case being that Sarah was already married: so early had some of the most odious principles of despotism taken root in the East. The interposition of Providence to deliver Sarah twice from royal harems will not seem superfluous when it is considered how carefully women are there secluded, and how impossible it is to obtain access to them, or get them back again (Esth. iv. 5). It is scarcely necessary to add that these practices still prevail in some Eastern countries, especially in Persia. The present writer, when at Tabreez, in the days of Abbas Meerza, was acquainted with a Persian klan who lived in continual anxiety and alarm lest his only daughter should be required for the harem of the prince, who, he was aware, had heard of her extreme beauty. Nothing further is recorded of King Abimelech, except that a few years after, he repaired to the camp of Abraham, who had removed southward beyond his borders, accompanied by Phichol, 'the chief captain of his host,' to invite the patriarch to contract with him a league of peace and friendship. Abraham consented; and this first league on record [ALLIANCE] was confirmed by a mutual oath, made at a well which had been dug by Abraham, but which the herdsmen of Abimelech had forcibly seized without his knowledge. It was restored to the rightful owner, on which Abraham named it BEERSHEBA (*the Well of the Oath*), and consecrated the spot to the worship of Jehovah (Gen. xxi. 22-34).

2. ABIMELECH, another king of Gerar, in the time of Isaac (about B.C. 1804; Hales, 1960), who is supposed to have been the son of the preceding. Isaac sought refuge in his territory during a famine; and having the same fear respecting his fair Mesopotamian wife, Rebekah, as his father had entertained respecting Sarah, he reported her to be his sister. This brought upon him the rebuke of Abimelech, when he accidentally discovered the truth. The country appears to have become more cultivated and populous than at the time of Abraham's visit, nearly a century before; and the inhabitants were more jealous of the presence of such powerful pastoral chieftains. In those times, as now, wells of water were of so much importance for agricultural as well as pastoral purposes, that they gave a proprietary right to the soil, not previously appropriated, in which they were dug. Abraham had dug wells during his sojourn in the country; and, to bar the claim which re-

sulted from them, the Philistines had afterwards filled them up; but they were now cleared out by Isaac, who proceeded to cultivate the ground to which they gave him a right. The virgin soil yielded him a hundred-fold; and his other possessions, his flocks and herds, also received such prodigious increase that the jealousy of the Philistines could not be suppressed; and Abimelech desired him to seek more distant quarters, in language which gives a high notion of the wealth of the patriarchal chiefs, and the extent of their establishments:—'Depart from us: for thou art more and mightier than we.' Isaac complied, and went out into the open country, and dug wells for his cattle. But the shepherds of the Philistines, out with their flocks, were not inclined to allow the claim to exclusive pasturage in these districts to be thus established; and their opposition induced the quiet patriarch to make successive removals, until he reached such a distance that his operations were no longer disputed. Afterwards, when he was at Beersheba, he received a visit from Abimelech, who was attended by Ahuzzath, his friend, and Phicol, the chief captain of his army. They were received with some reserve by Isaac; but when Abimelech explained that it was his wish to renew, with one so manifestly blessed of God, the covenant of peace and goodwill which had been contracted between their fathers, they were more cheerfully entertained, and the desired covenant was, with due ceremony, contracted accordingly. (Gen. xxvi.) From the facts recorded respecting the connection of the two Abimelechs with Abraham and Isaac, it is manifest that the Philistines, even at this early time, had a government more organized, and more in unison with that type which we now regard as Oriental, than appeared among the native Canaanites, one of whose nations had been expelled by these foreign settlers from the territory which they occupied [PHILISTINES].

3. ABIMELECH, a son of Gideon, by a concubine-wife, a native of Shechem, where her family had considerable influence. Through that influence Abimelech was proclaimed king after the death of his father, who had himself refused that honour, when tendered to him, both for himself and his children (Judg. viii. 22-24). In a short time, a considerable part of Israel seems to have recognised his rule. One of the first acts of his reign was to destroy his brothers, seventy in number, being the first example of a system of barbarous state policy of which there have been frequent instances in the East, and which indeed has only within a recent period been discontinued. They were slain 'on one stone' at Ophrah, the native city of the family. Only one, the youngest, named Jotham, escaped; and he had the boldness to make his appearance on Mount Gerizim, where the Shechemites were assembled for some public purpose (perhaps to inaugurate Abimelech), and rebuke them in his famous parable of the trees choosing a king [JOTHAM; PARABLE]. In the course of three years the Shechemites found ample cause to repent of what they had done; they eventually revolted in Abimelech's absence, and caused an ambush to be laid in the mountains, with the design of destroying him on his return. But Zebul, his governor in Shechem, contrived to apprise him of

these circumstances, so that he was enabled to avoid the snare laid for him; and, having hastily assembled some troops, appeared unexpectedly before Shechem. The people of that place had meanwhile secured the assistance of one Gaal and his followers [GAAL], who marched out to give Abimelech battle. He was defeated, and returned into the town; and his inefficiency and misconduct in the action had been so manifest, that the people were induced by Zebul to expel him and his followers. Although without his protection, the people still went out to the labours of the field. This being told Abimelech, who was at Arumah, he laid an ambush in four bodies in the neighbourhood; and when the men came forth in the morning, two of the ambushed parties rose against them, while the other two seized the city gates to prevent their return. Afterwards the whole force united against the city, which, being now deprived of its most efficient inhabitants, was easily taken. It was completely destroyed by the exasperated victor, and the ground strewn with salt, symbolical of the desolation to which it was doomed. The fortress, however, still remained; but the occupants, deeming it untenable, withdrew to the temple of Baal-Berith, which stood in a more commanding situation. Abimelech employed his men in collecting and piling wood against this building, which was then set on fire and destroyed, with the thousand men who were in it. Afterwards Abimelech went to reduce Thebez, which had also revolted. The town was taken with little difficulty, and the people withdrew into the citadel. Here Abimelech resorted to his favourite operation, and while heading a party to burn down the gate, he was struck on the head by a large stone cast down by a woman from the wall above. Perceiving that he had received a death-blow, he directed his armour-bearer to thrust him through with his sword, lest it should be said that he fell by a woman's hand. Thus ended the first attempt to establish a monarchy in Israel. The chapter in which these events are recorded (Judg. ix.) gives a more detailed and lively view of the military operations of that age than elsewhere occurs, and claims the close attention of those who study that branch of antiquities. Abimelech himself appears to have been a bold and able commander, but utterly uncontrolled by religion, principle, or humanity in his ambitious enterprises. His fate resembled that of Pyrrhus II., king of Epirus (Justin. xxv. 5; Pausan. i. 13; Thucyd. iii. 74); and the dread of the ignominy of its being said of a warrior that he died by a woman's hand was very general (Sophoc. *Trach.* 1064; Senec. *Herc. Oet.* 1176). Vainly did Abimelech seek to avoid this disgrace; for the fact of his death by the hand of a woman was long after associated with his memory (2 Sam. xi. 21).

ABINADAB אֲבִינָדָב, *father of voluntariness*; Sept. *Ἀβινάδαβ*. There are several persons of this name, all of whom are also called AMINADAB—the letters *b* and *m* being very frequently interchanged in Hebrew.

1. ABINADAB, one of the eight sons of Jesse, and one of the three who followed Saul to the war with the Philistines (1 Sam. xvi. 8).

2. ABINADAB, one of Saul's sons, who was slain at the battle of Gilboa (1 Sam. xxxi. 2).

3. ABINADAB, the Levite of Kirjath-jearim,

in whose house, which was on a hill, the Ark of the Covenant was deposited, after being brought back from the land of the Philistines. It was committed to the special charge of his son Eleazer; and remained there seventy years, until it was removed by David (1 Sam. vii. 1, 2; 1 Chron. xiii. 7). [ARK.]

1. ABIRAM (אִבִּירָם, *father of altitude*, i. e. *high*; Sept. Ἀβειράμ), one of the family-chiefs of the tribe of Reuben, who, with Dathan and On of the same tribe, joined Korah, of the tribe of Levi, in a conspiracy against Aaron and Moses [AARON]. (Num. xvi.)

2. ABIRAM, eldest son of Hiel the Bethelite (1 Kings xvi. 34). [HIEL; JERICHO.]

ABISHAG (אִבִּישָׁג, *father of error*; Sept. Ἀβισάγ), a beautiful young woman of Shunam, in the tribe of Issachar, who was chosen by the servants of David to be introduced into the royal harem, for the special purpose of ministering to him, and cherishing him in his old age. She became his wife; but the marriage was never consummated. Some time after the death of David, Adonijah, his eldest son, persuaded Bathsheba, the mother of Solomon, to entreat the king that Abishag might be given to him in marriage. But as rights and privileges peculiarly regal were associated with the control and possession of the harem of the deceased kings [HAREM], Solomon detected in this application a fresh aspiration to the throne, which he visited with death (1 Kings i. 1-4; ii. 13-25) [ADONIJAH].

ABISHAI (אִבִּישַׁי, *father of gifts*; Sept. Ἀβισαί), a nephew of David by his sister Zeruiah, and brother of Joab and Asahel. The three brothers devoted themselves zealously to the interests of their uncle during his wanderings. Though David had more reliance upon the talents of Joab, he appears to have given more of his private confidence to Abishai, who seems to have attached himself in a peculiar manner to his person, as we ever find him near, and ready for council or action, on critical occasions. Abishai, indeed, was rather a man of action than of council; and although David must have been gratified by his devoted and uncompromising attachment, he had more generally occasion to check the impulses of his ardent temperament than to follow his advice. Abishai was one of the two persons whom David asked to accompany him to the camp of Saul; and he alone accepted the perilous distinction (1 Sam. xxvi. 5-9). The desire he then expressed to smite the sleeping king, identifies him as the man who afterwards burned to rush upon Shimei and slay him for his abuse of David (2 Sam. xvi. 9). For when the king fled beyond the Jordan from Absalom, Abishai was again by his side: and he was entrusted with the command of one of the three divisions of the army which crushed that rebellion (2 Sam. xviii. 2). Afterwards, in a war with the Philistines, David was in imminent peril of his life from a giant named Ishbi-benob; but was rescued by Abishai, who slew the giant (2 Sam. xx. 15-17). He was also the chief of the three 'mighties,' who, probably in the same war, performed the chivalrous exploit of breaking through the host of the Philistines to procure David a draught of water from the well of his

native Bethlehem (2 Sam. xxiii. 14-17). Among the exploits of this hero it is mentioned that he withstood 300 men and slew them with his spear: but the occasion of this adventure, and the time and manner of his death, are equally unknown. In 2 Sam. viii. 13, the victory over the Edomites in the Valley of Salt is ascribed to David, but in 1 Chron. xviii. 12, to Abishai. It is hence probable that the victory was actually gained by Abishai, but is ascribed to David as king and commander-in-chief.

ABISHUA (אִבִּישׁוּא, *father of safety*; Sept. Ἀβισουά), the son of Phinehas, and fourth high-priest of the Jews (1 Chron. vi. 50). The commencement and duration of his pontificate are uncertain, but the latter is inferred from circumstances, confirmed by the Chronicon of Alexandria, to have included the period in which Ehud was judge, and probably the preceding period of servitude to Eglon of Moab. Blair places him from B.C. 1352 to 1302—equivalent to Hales, B.C. 1513 to 1463. This high-priest is called Abiezer by Josephus (*Antiq.* v. 12, 5).

ABIYONAH (אִבְיוֹנָה; Sept. κάππaris). This word occurs only once in the Bible, Eccles. xii. 5: 'When the almond-tree shall flourish, and the grasshopper shall be a burden, and *desire* shall fail; because man goeth to his long home.' The word translated *desire* is ABIYONAH, which by others has been considered to signify the CAPER-PLANT. The reasons assigned for the latter opinion are: that the Rabbins apply the term *abionoth* to the small fruit of trees and berries, as well as to that of the caper-bush; that the caper-bush is common in Syria and Arabia; that its fruit was in early times eaten as a condiment, being stimulating in its nature, and



[Capparis spinosa.]

therefore calculated to excite desire; that as the caper-bush grows on tombs, it will be liable to

be destroyed when these are opened; and, finally, that as Solomon speaks here in symbols and allegories, we must suppose him to deviate from the course he had apparently prescribed to himself, if he were to express in plain words that 'desire shall fail,' instead of intimating the same thing, by the failure of that which is supposed to have been used to excite desire.

Celsius (*Hierobotanicon*, i. 210) argues, on the contrary, that Solomon in other places, when treating of the pleasures of youth, never speaks of capers, but of wine and perfumes; that, had he wished to adduce anything of the kind, he would have selected something more remarkable; that capers, moreover, instead of being pleasantly stimulant, are rather acrid and hurtful, and though occasionally employed by the ancients as condiments, were little esteemed by them; and, finally, that the word abionoth of the Rabbins is distinct from the abiyonah of this passage, as is admitted even by Ursinus: 'Nam quod vocabulum אביונת *Abionoth*, quod Rabbinis usitatum, alia quædam puncta habeat, non puto tanti esse momenti' (*Arboret. Biblicum*, xxviii. 1). To this Celsius replies: 'Immo, nisi vocales et puncta genuina in Ebraicis observentur, Babelica fiet confusio, et cælo terra miscebitur. Incertum pariter pro certo assumunt, qui cappares volunt proprie abionoth dici Rabbinis' (*l. c.* p. 213).

But as the Septuagint, the Vulgate, and some other translations, have understood the caper-bush to be meant, it is desirable to give some account of it, especially as, from its ornamental nature, it could not but attract attention. There are, moreover, some points in its natural history which have been overlooked, but which may serve to show that in the passage under review it might without impropriety have been employed in carrying out the figurative language with which the verse commences.

The caper-plant belongs to a tribe of plants, the Capparidææ, of which the species are found in considerable numbers in tropical countries, such as India, whence they extend northwards into Arabia, the north of Africa, Syria, and the south of Europe. The common caper-bush—*Capparis spinosa*, Linn. (the *C. sativa* of Persoon)—is common in the countries immediately surrounding the Mediterranean. Dioscorides describes it as spreading in a circular manner on the ground, in poor soils and rugged situations; and Pliny, 'as being set and sown in stony places especially.' Theophrastus states that it refuses to grow in cultivated ground. Dioscorides describes it as having thorns like a bramble, leaves like the quince, and fruit like the olive; characters almost sufficient to identify it. The caper is well known to the Arabs, being their

قبر *kibbur*; and designated also by the name

أثف *athuf* or *azuf*. The bark of the root, which is still used in the East, as it formerly was in Europe, no doubt possesses some irritant property, as it was one of the five aperient roots. The unexpanded flower-buds, preserved in vinegar, are well known at our tables as a condiment by the name of capers. Parts of the plant seem to have been similarly used by the ancients.

The caper-plant is showy and ornamental, growing in barren places in the midst of the

rubbish of ruins, or on the walls of buildings. It was observed by Ray on the Temple of Peace at Rome, and in other similar situations. It forms a much-branched, diffuse shrub, which annually loses its leaves. The branches are long and trailing; smooth, but armed with double curved stipular spines. The leaves are alternate, roundish or oblong-oval, a little fleshy, smooth, of a green colour, but sometimes a little reddish. The flowers are large and showy, produced singly in the axils of the leaves, on stalks which are larger than the leaves. The calyx is four-leaved, coriaceous; the petals are also four in number, white, and of an oval roundish form. The stamens are very numerous and long; and their filaments being tinged with purple, and terminated by the yellow anthers, give the flowers a very agreeable appearance. The ovary is borne upon a straight stalk, which is a little longer than the stamens, and which, as it ripens, droops and forms an oval or pear-shaped berry, enclosing within its pulp numerous small seeds.



Many of the caper tribe, being remarkable for the long stalks by which their fruit is supported, conspicuously display, what also takes place in other plants, namely, the drooping and hanging down of the fruit as it ripens. As, then, the flowering of the almond-tree, in the first part of the verse, has been supposed to refer to the whitening of the hair, so the drooping of the ripe fruit of a plant like the caper, which is conspicuous on the walls of buildings, and on tombs, may be supposed to typify the hanging down of the head before 'man goeth to his long home.'—J. F. R.

ABLUTION, the ceremonial washing, whereby, as a symbol of purification from uncleanness, a person was considered—1. to be cleansed from the taint of an inferior and less pure condition, and initiated into a higher and purer state; 2. to be cleansed from the soil of common life, and fitted for special acts of religious service; 3. to be cleansed from defilements contracted by particular acts or circumstances, and restored to the privileges of ordinary life; 4. as absolving or purifying himself, or declaring himself absolved and purified, from the guilt of a particular act. We do not meet with any such ablutions in patriarchal times: but under the Mosaic dispensation they all occur.

A marked example of the first kind of ablution occurs when Aaron and his sons, on their being set apart for the priesthood, were washed with water before they were invested with the priestly robes and anointed with the holy oil (*Lev. viii. 6*). To this head we are inclined to refer the ablution of persons and raiment which was commanded to the whole of the Israelites, as a preparation to their receiving the law from Sinai (*Exod. xix. 10-15*). We also find examples of this kind of purification in connection with initiation into a higher state. Thus those admitted into the lesser or introductory mysteries of Eleusis were previously

purified on the banks of the Ilissus, by water being poured upon them by the Udranos.

The *second* kind of ablation was that which required the priests, on pain of death, to wash their hands and their feet before they approached the altar of God (Exod. xxx. 17-21). For this purpose a large basin of water was provided both at the tabernacle and at the temple. To this the Psalmist alludes when he says—'I will wash my hands in innocency, and so will I compass thine altar' (Ps. xxvi. 6). Hence it became the custom in the early Christian church for the ministers, in the view of the congregation, to wash their hands in a basin of water brought by the deacon, at the commencement of the communion (Jamieson, p. 126); and this practice, or something like it, is still retained in the Eastern churches, as well as in the church of Rome, when mass is celebrated. Similar ablutions by the priests before proceeding to perform the more sacred ceremonies were usual among the heathen. The Egyptian priests indeed carried the practice to a burdensome extent, from which the Jewish priests were, perhaps designedly, exonerated; and in their less torrid climate it was, for purposes of real cleanliness, less needful. Reservoirs of water were attached to the Egyptian temples; and Herodotus (ii. 37) informs us that the priests shaved the whole of their bodies every third day, that no insect or other filth might be upon them when they served the gods, and that they washed themselves in cold water twice every day and twice every night: Porphyry says thrice a day, with a nocturnal ablation occasionally. This kind of ablation, as preparatory to a religious act, answers to the simple *Wādū* of the Moslems, which they are required to go through five times daily before their stated prayers. This makes the ceremonies of ablation much more conspicuous to a traveller in the Moslem East at the present day than they would appear among the ancient Jews, seeing that the law imposed this obligation on the priests only, not on the people. Connected as these Moslem ablutions are with various forms and imitative ceremonies, and recurring so frequently as they do, the avowedly heavy yoke of even the Mosaic law seems light in the comparison.

In the *third* class of ablutions washing is regarded as a purification from positive defilements. The Mosaic law recognises eleven species of uncleanness of this nature (Lev. xii.-xv.), the purification for which ceased at the end of a certain period, provided the unclean person then washed his body and his clothes; but in a few cases, such as leprosy and the defilement contracted by touching a dead body, he remained unclean seven days after the physical cause of pollution had ceased. This was all that the law required: but in later times, when the Jews began to refine upon it, these cases were considered generic instead of specific—as representing classes instead of individual cases of defilement—and the causes of pollution requiring purification by water thus came to be greatly increased. This kind of ablation for substantial

uncleanness answers to the Moslem *غُشْ* *ghash*, in which the causes of defilement greatly exceed those of the Mosaic law, while they are perhaps equalled in number and minuteness by those which the later Jews devised. The uncleanness

in this class arises chiefly from the natural secretions of human beings and of beasts used for food; and from the ordure of animals not used for food; and, as among the Jews, the defilement may be communicated not only to persons, but to clothes, utensils, and dwellings—in all which cases the purification must be made by water, or by some representative act where water cannot be applied.

Of the *last* class of ablutions, by which persons declared themselves free from the guilt of a particular action, the most remarkable instance is that which occurs in the expiation for an unknown murder, when the elders of the nearest village washed their hands over the expiatory heifer, beheaded in the valley, saying, 'Our hands have not shed this blood, neither have our eyes seen it' (Deut. xxi. 1-9). It has been thought by some that the signal act of Pilate, when he washed his hands in water and declared himself innocent of the blood of Jesus (Matt. xxvii. 24), was a designed adoption of the Jewish custom: but this supposition does not appear necessary, as the custom was also common among the Greeks and Romans.

We have confined this notice to the usages of ablation as a sign of purification sanctioned or demanded by the law itself. Other practices not there indicated appear to have existed at a very early period, or to have grown up in the course of time. From 1 Sam. xvi. 5, compared with Exod. xix. 10-14, we learn that it was usual for those who presented or provided a sacrifice to purify themselves by ablation: and as this was everywhere a general practice, it may be supposed to have existed in patriarchal times, and, being an established and approved custom, not to have required to be mentioned in the law. There is a passage in the apocryphal book of Judith (xii. 7-9) which has been thought to intimate that the Jews performed ablutions before prayer. But we cannot fairly deduce that meaning from it. It would indeed prove too much if so understood, as Judith bathed in the water, which is more than even the Moslems do before their prayers. Moreover, the authority, if clear, would not be conclusive.

But after the rise of the sect of the Pharisees, the practice of ablation was carried to such excess, from the affectation of excessive purity, that it is repeatedly brought under our notice in the New Testament through the severe animadversions of our Saviour on the consummate hypocrisy involved in this fastidious attention to the external types of moral purity, while the heart was left unclean. All the practices there exposed come under the head of purification from uncleanness;—the acts involving which were made so numerous that persons of the stricter sect could scarcely move without contracting some involuntary pollution. For this reason they never entered their houses without ablation, from the strong probability that they had unknowingly contracted some defilement in the streets; and they were especially careful never to eat without washing the hands (Mark vii. 1-5), because they were peculiarly liable to be defiled; and as unclean hands were held to communicate uncleanness to all food (excepting fruit) which they touched, it was deemed that there was no security against eating unclean food but by always

washing the hands ceremonially before touching any meat. We say 'ceremonially,' because this article refers only to ceremonial washing. The Israelites, who, like other Orientals, fed with their fingers, washed their hands before meals, for the sake of cleanliness [WASHING]. But these customary washings were distinct from the ceremonial ablutions, as they are now among the Moslems. There were, indeed, distinct names for them. The former was called simply נטילה, or *washing*, in which water was poured upon the hands; the latter was called טבילה, *plunging*, because the hands were plunged in water (Lightfoot, on Mark vii. 4). It was this last, namely, the ceremonial ablution, which the Pharisees judged to be so necessary. When therefore some of that sect remarked that our Lord's disciples ate 'with unwashed hands' (Mark vii. 2), it is not to be understood literally that they did not at all wash their hands, but that they did not *plunge* them ceremonially according to their own practice. And this was expected from them only as the disciples of a religious teacher; for these refinements were not practised by the class of people from which the disciples were chiefly drawn. Their wonder was, that Jesus had not inculcated this observance on his followers, and not, as some have fancied, that he had enjoined them to neglect what had been their previous practice.

In at least an equal degree the Pharisees multiplied the ceremonial pollutions which required the ablution of inanimate objects—cups and pots, brazen vessels and tables; the rules given in the law (Lev. vi. 28; xi. 32-36; xv. 23) being extended to these multiplied contaminations. Articles of earthenware which were of little value were to be broken; and those of metal and wood were to be scoured and rinsed with water. All these matters are fully described by Buxtorf, Lightfoot, Gill, and other writers of the same class, who present many striking illustrations of the passages of Scripture which refer to them. The Mohammedan usages of ablution, which offer many striking analogies, are fully detailed in the third book of the *Mischat ul Masabih*, and also in D'Ohsson's *Tableau*, liv. i. chap. i.

ABNAIM (אֲבָנַיִם). This word is the dual of אֶבֶן, a stone, and in this form only occurs twice, Exod. i. 16, and Jer. xviii. 3. In the latter passage it undeniably means a *potter's wheel*; but what it denotes in the former, or how to reconcile with the use of the word in the latter text any interpretation which can be assigned to it in the former, is a question which (see Rosenmüller *in loc.*) has mightily exercised the ingenuity and patience of critics and philologists. The meaning appears to have been doubtful even of old, and the ancient versions are much at variance. The LXX. evades the difficulty by the general expression ὄραν ὄσι πρὸς τῷ ῥίτκειν, 'when they are about to be delivered,' and is followed by the Vulgate, 'et partus tempus advenerit'; but our version is more definite, and has 'and see them upon the stools.' This goes upon the notion that the word denotes a particular kind of open stool or chair constructed for the purpose of delivering pregnant women. The usages of the East do not, however, acquaint us with any such utensil, the employment of which, indeed, is not in accordance with

the simple manners of ancient times. Others, therefore, suppose the word to denote stone or other bathing troughs, in which it was usual to lave new-born infants. This conjecture is so far probable, that the midwife, if inclined to obey the royal mandate, could then destroy the child without check or observation. Accordingly, this interpretation is preferred by Gesenius (*The-saur. s. v. אֶבֶן*), quoting in illustration Thevenot (*Itin. ii. 98*), who states 'that the kings of Persia are so afraid of being deprived of that power which they abuse, and are so apprehensive of being dethroned, that they cause the male children of their female relations to be destroyed in the stone bathing-troughs in which newly-born children are laved.' The question, however, is not as to the existence of the custom, but its application to the case in view. Professor Lee treats the preceding opinions with little ceremony, and decides nearly in accordance with the LXX. and other ancient versions, none of which, as he remarks, say anything about *wash-pots, stools*, or the like. He then gives reasons for understanding the command of Pharaoh thus: 'Observe, look carefully on the two occasions (*i. e.* in which either a male or female child is born). If it be a son, then,' &c. We may add that this is a subject on which some light may possibly be thrown at a future day by the monuments of Egypt, in which the ancient manners of that country are so minutely portrayed.

ABNER (אֲבִינֵר or אֲבִינֵר, *father of light*; Sept. Ἀβεννίρ), the cousin of Saul (being the son of his uncle Ner), and the commander-in-chief of his army. He does not come much before us until after the death of Saul, B.C. 1056. Then, the experience which he had acquired, and the character for ability and decision which he had established in Israel, enabled him to uphold the falling house of Saul for seven years; and he might probably have done so longer if it had suited his views. It was generally known that David had been divinely nominated to succeed Saul on the throne: when, therefore, that monarch was slain in the battle of Gilboa, David was made king over his own tribe of Judah, and reigned in Hebron. In the other tribes an influence adverse to Judah existed, and was controlled chiefly by the tribe of Ephraim. Abner, with great decision, availed himself of this state of feeling, and turned it to the advantage of the house to which he belonged, of which he was now the most important surviving member. He did not, however, venture to propose himself as king; but took Ishbosheth, a surviving son of Saul, whose known imbecility had excused his absence from the fatal fight in which his father and brothers perished, and made him king over the tribes, and ruled in his name. Ishbosheth reigned in Mahanaim, beyond Jordan, and David in Hebron. A sort of desultory warfare arose between them, in which the advantage appears to have been always on the side of David. The only one of the engagements of which we have a particular account is that which ensued when Joab, David's general, and Abner, met and fought at Gibeon. Abner was beaten and fled for his life; but was pursued by Asahel, the brother of Joab and Abishai, who was 'swift of foot as a wild roe.' Abner,

dreading a blood-feud with Joab, for whom he seems to have entertained a sincere respect, entreated Asahel to desist from the pursuit: but finding that he was still followed, and that his life was in danger, he at length ran his pursuer through the body by a back thrust with the pointed heel of his spear (2 Sam. ii. 8-32). This put a strife of blood between the two foremost men in all Israel (after David); for the law of honour which had from times before the law prevailed among the Hebrews, and which still prevails in Arabia, rendered it the conventional duty of Joab to avenge the blood of his brother upon the person by whom he had been slain [BLOOD-REVENGE].

As time went on, Abner had occasion to feel more strongly that he was himself not only the chief, but the only remaining prop of the house of Saul: and this conviction, acting upon a proud and arrogant spirit, led him to more presumptuous conduct than even the mildness of the feeble Ishbosheth could suffer to pass without question. He took to his own harem a woman who had been a concubine-wife of Saul. This act, from the ideas connected with the harem of a deceased king [HAREM], was not only a great impropriety, but was open to the suspicion of a political design, which Abner may very possibly have entertained. A mild rebuke from the nominal king, however, enraged him greatly; and he plainly declared that he would henceforth abandon his cause and devote himself to the interests of David. To excuse this desertion to his own mind, he then and on other occasions avowed his knowledge that the son of Jesse had been appointed by the Lord to reign over all Israel: but he appears to have been unconscious that this avowal exposed his previous conduct to more censure than it offered excuse for his present. He, however, kept his word with Ishbosheth. After a tour, during which he explained his present views to the elders of the tribes which still adhered to the house of Saul, he repaired to Hebron with authority to make certain overtures to David on their behalf. He was received with great attention and respect; and David even thought it prudent to promise that he should still have the chief command of the armies, when the desired union of the two kingdoms took place. The political expediency of this engagement is very clear, and to that expediency the interests and claims of Joab were sacrificed. That distinguished personage happened to be absent from Hebron on service at the time, but he returned just as Abner had left the city. He speedily understood what had passed; and his dread of the superior influence which such a man as Abner might establish with David, quickened his remembrance of the vengeance which his brother's blood required. His purpose was promptly formed. Unknown to the king, but apparently in his name, he sent a message after Abner to call him back; and as he returned, Joab met him at the gate, and, leading him aside, as if to confer peaceably and privately with him, suddenly thrust his sword into his body (u.c. 1048). The lamentations of David, the public mourning which he ordered, and the funeral honours which were paid to the remains of Abner, the king himself following the bier as chief mourner, exonerated him in public opinion from having been privy to this assassination. As for Joab, his privilege as a blood-avenger must to a

great extent have justified his treacherous act in the opinion of the people; and that, together with his influence with the army, screened him from punishment (2 Sam. iii. 6-39).

For the following interesting elucidation of David's lament over Abner, we are indebted to a learned and highly valued contributor.

[David's short but emphatic lament over Abner (2 Sam. iii. 33) may be rendered, with stricter adherence to the *form* of the original, as follows:—

‘Should Abner die as a villain dies?—

Thy hands—not bound,

Thy feet—not brought into fetters:

As one falls before the sons of wickedness,
fellest thou!’

As to the syntactical structure of these lines, it is important to observe that the second and third lines are two *propositions of state* belonging to the *last*, which describe the *condition in which he was when he was slain*. This kind of proposition is marked by the *subject* being placed *first*, and by the verb generally becoming a *participle*. On the right knowledge of this structure the beauty and sense of many passages altogether depend; and the common ignorance of it is to be ascribed to the circumstance, that the study of Hebrew so very seldom reaches beyond the vocabulary into the deeper-seated peculiarities of its *construction*. (See Ewald's *Hebr. Gram.* §556.) As to the sense of the words, J. D. Michaelis (in his *Uebersetzung des Alten Test. mit Anmerkungen für Ungelehrte*) saw that the point of this indignant, more than sorrowful, lament, lies in the *mode* in which Abner was slain. Joab professed to kill him ‘for the blood of Asahel his brother,’ 2 Sam. iii. 27. But if a man claimed his brother's blood at the hand of his murderer, the latter (even if he fled to the altar for refuge, Exod. xxi. 14) would have been delivered up (bound, hand and foot, it is *assumed*) to the avenger of blood, who would then possess a legal right to slay him. Now Joab not only had no title to claim the right of the *Goel*, as Asahel was killed under justifying circumstances (2 Sam. ii. 19); but, while pretending to exercise the avenger's right, he took a lawless and private mode of satisfaction, and committed a murder. Hence David charged him, in allusion to this conduct, with ‘shedding the blood of war in peace’ (1 Kings ii. 5); and hence he expresses himself in this lament, as if indignant that the noble Abner, instead of being surrendered with the formalities of the law to meet an authorized penalty, was treacherously stabbed like a worthless fellow by the hands of an assassin.—J. N.]

ABNET (אֲבֵט). As this word can be traced to no root in the Hebrew language, and as it occurs in the narrative immediately after the departure from Egypt, it is reasonably supposed by Professor Lee to be Egyptian, in opposition however to Hottinger, who refers it to the Persian, and to Gesenius, who finds it in the Sanscrit. It means a *band*, a *bandage*; and from the places in which it occurs, it appears to have been made of fine linen variously wrought, and used to bind as a girdle about the body of persons in authority especially the Jewish priests (Exod. xxix. 9; xxviii. 39; xxxix. 29; Lev. viii. 13. Isa. xxii.

21). These girdles may be considered as fairly represented by those which we observe on such persons in the Egyptian paintings.

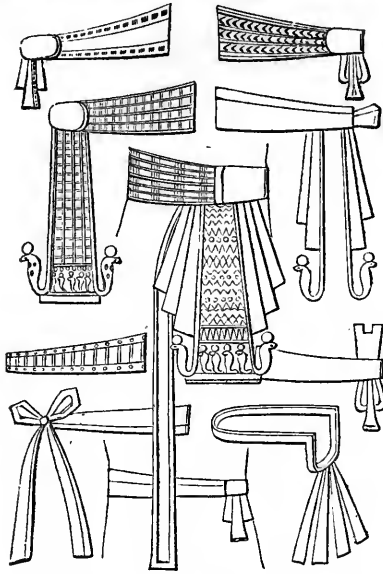

ABOMINATION (תועבה and שְׂקוּץ; Sept. and New Test.—*e. g.* Matt. xxiv. 15—βδέλυγμα, for both). These words describe generally any object of detestation or disgust (Lev. xviii. 22; Deut. vii. 25); and are applied to an impure or detestable action (Ezek. xxii. 11; xxx. 26; Mal. ii. 11, &c.); to any thing causing a ceremonial pollution (Gen. xliii. 32; xlv. 34; Deut. xiv. 3); but more especially to idols (Lev. xviii. 22; xx. 13; Deut. vii. 26; 1 Kings xi. 5, 7; 2 Kings xxiii. 13); and also to food offered to idols (Zech. ix. 7); and to filth of every kind (Nahum iii. 6). There are two or three of the texts in which the word occurs, to which, on account of their peculiar interest or difficulty, especial attention has been drawn. The *first* is Gen. xliii. 32: 'The Egyptians might not eat bread with the Hebrews; for that is an abomination (תועבה) unto the Egyptians.' This is best explained by the fact that the Egyptians considered themselves ceremonially defiled if they ate with *any* strangers. The primary reason appears to have been that the cow was the most sacred animal among the Egyptians, and the eating of it was abhorrent to them; whereas it was both eaten and sacrificed by the Jews and most other nations, who on that account were abominable in their eyes. It was for this, as we learn from Herodotus (ii. 41), that no Egyptian man or woman would kiss a Greek on the mouth, or would use the cleaver of a Greek, or his spit, or his dish, or would taste the flesh of even clean beef (that is, of oxen) that had been cut with a Grecian carving-knife. It is true that Sir J. G. Wilkinson (*Anc. Egyptians*, iii. 358) ascribes this to the repugnance of the fastidiously clean Egyptians to the comparatively foul habits of their Asiatic and other neighbours: but it seems scarcely fair to take the *facts* of the father of history, and ascribe

to them any other than the very satisfactory reason which he assigns. We collect then that it was as *foreigners*, not pointedly as Hebrews, that it was an abomination for the Egyptians to eat with the brethren of Joseph. The Jews themselves subsequently exemplified the same practice; for in later times they held it unlawful to eat or drink with foreigners in their houses, or even to enter their houses (John xviii. 28; Acts x. 28; xi. 3); for not only were the houses of Gentiles unclean (*Mishn. Oholoth*. 18, § 7), but they themselves rendered unclean those in whose houses they lodged (*Maimon. Mishcab a. Morheb*, c. 12, § 12); which was carrying the matter a step further than the Egyptians (see also *Mitzvoth Tora*, p. 148). We do not however trace these examples before the Captivity.

The *second* passage is Gen. xlvi. 34. Joseph is telling his brethren how to conduct themselves when introduced to the king of Egypt; and he instructs them that when asked concerning their occupation they should answer: 'Thy servants' trade hath been about cattle from our youth even until now, *both we and also our fathers.*' This last clause has emphasis, as showing that they were hereditary nomade pastors; and the reason is added: 'That ye may dwell in the land of Goshen,—for every shepherd is an abomination unto the Egyptians.' In the former instance they were 'an abomination' as *strangers*, with whom the Egyptians could not eat; here they are a further abomination as *nomade shepherds*, whom it was certain that the Egyptians, for that reason, would locate in the border land of Goshen, and not in the heart of the country. That it was nomade shepherds, or Bedouins, and not simply shepherds, who were abominable to the Egyptians, is evinced by the fact that the Egyptians themselves paid great attention to the rearing of cattle. This is shown by their sculptures and paintings, as well as by the offer of this very king of Egypt to make such of Jacob's sons as were men of activity 'overseers of his cattle' (xlvii. 6). For this aversion to nomade pastors two reasons are given; and it is not necessary that we should choose between them, for both of them were, it is most likely, concurrently true. One is, that the inhabitants of Lower and Middle Egypt had previously been invaded by, and had remained for many years subject to, a tribe of nomade shepherds [EGYPT], who had only of late been expelled, and a native dynasty restored—the grievous oppression of the Egyptians by these pastoral invaders, and the insult with which their religion had been treated. The other reason, not necessarily superseding the former, but rather strengthening it, is, that the Egyptians, as a settled and civilized people, detested the lawless and predatory habits of the wandering shepherd tribes, which then, as now, bounded the valley of the Nile, and occupied the Arabias. Their constantly aggressive operations upon the frontiers, and upon all the great lines of communication, must, with respect to them, have given intensity to the odium with which all strangers were regarded. If any proof of this were wanting, it is found in the fact (attested by the Rev. R. M. Macchiari and others) that, sunk as Modern Egypt is, there is still such a marked and irreconcilable difference of ideas and habits between the inhabitants and the Bedouins, whose camps are often in the near neighbourhood of their towms and villages,

that the latter are regarded with dislike and fear, and no friendly intercourse exists between them. We know that the same state of feeling prevails between the settled inhabitants and the Bedouins along the Tigris and Euphrates.

The third marked use of this word again occurs in Egypt. The king tells the Israelites to offer to their god the sacrifices which they desired, without going to the desert for that purpose. To which Moses objects, that they should have to sacrifice to the Lord 'the abomination of the Egyptians,' who would thereby be highly exasperated against them (Exod. viii. 25, 26). A reference back to the first explanation shows that this 'abomination' was the cow, the only animal which all the Egyptians agreed in holding sacred; whereas, in the great sacrifice which the Hebrews proposed to hold, not only would heifers be offered, but the people would feast upon their flesh.

THE ABOMINATION OF DESOLATION. In Dan. ix. 27, שְׁבוּץ מִשְׁמַשׁ, literally, 'the abomination of the desolator,' which, without doubt, means the idol or idolatrous apparatus which the desolator of Jerusalem should establish in the holy place. This appears to have been a prediction of the pollution of the temple by Antiochus Epiphanes, who caused an idolatrous altar to be built on the altar of burnt offerings, whereon unclean things were offered to Jupiter Olympius, to whom the temple itself was dedicated. Josephus distinctly refers to this as the accomplishment of Daniel's prophecy; as does the author of the first book of Maccabees, in declaring that 'they set up the abomination of desolation upon the altar'—ἐκοδόμησαν τὸ βδέλυγμα τῆς ἐρημώσεως ἐπὶ τὸ θυσιαστήριον (1 Macc. i. 59; vi. 7; 2 Macc. vi. 2-5; Joseph. Antiq. xii. 5, 4; xii. 7, 6). The phrase is quoted by Jesus, in the form of τὸ βδέλυγμα τῆς ἐρημώσεως (Matt. xxiv. 15), and is applied by him to what was to take place at the advance of the Romans against Jerusalem. They who saw 'the abomination of desolation standing in the holy place' were enjoined to 'flee to the mountains.' And this may with probability be referred to the advance of the Roman army against the city with their image-crowned standards, to which idolatrous honours were paid, and which the Jews regarded as idols. The unexpected retreat and discomfiture of the Roman forces afforded such as were mindful of our Saviour's prophecy an opportunity of obeying the injunction which it contained. That the Jews themselves regarded the Roman standards as abominations is shown by the fact that, in deference to their known aversion, the Roman soldiers quartered in Jerusalem forbore to introduce their standards into the city: and on one occasion, when Pilate gave orders that they should be carried in by night, so much stir was made in the matter by the principal inhabitants, that for the sake of peace the governor was eventually induced to give up the point (Joseph. Antiq. xviii. 3, 1). Those however who suppose that 'the holy place' of the text must be the temple itself, may find the accomplishment of the prediction in the fact that, when the city had been taken by the Romans, and the holy house destroyed, the soldiers brought their standards in due form to the temple, set them up over the eastern gate, and offered sacrifice to them (Joseph. Bell. Jud. vi. 6, 1); for (as Havercamp judiciously notes from Tertullian, Apol. c. xvi. 162) 'almost the entire

religion of the Roman camp consisted in worshipping the ensigns, swearing by the ensigns, and in preferring the ensigns before all the other gods.'

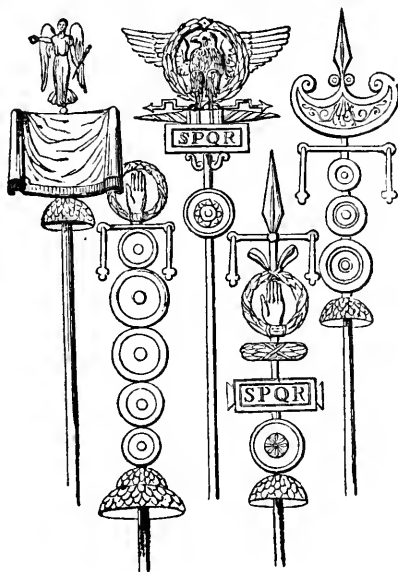

Nor was this the last appearance of 'the abomination of desolation, in the holy place:' for, not only did Hadrian, with studied insult to the Jews, set up the figure of a boar over the Bethlehem gate of the city (Ælia Capitolina) which rose upon the site and ruins of Jerusalem (Euseb. Chron. l. i. p. 45, ed. 1658), but he erected a temple to Jupiter upon the site of the Jewish temple (Dion Cass. lxi. 12), and caused an image of himself to be set up in the part which answered to the most holy place (Nicephorus Callist., iii. 24). This was a consummation of all the abominations which the iniquities of the Jews brought upon their holy place.

ABRAHAM (אַבְרָהָם, father of a multitude; Sept. Ἀβραάμ), the founder of the Hebrew nation. Up to Gen. xvii. 4, 5, he is uniformly called ABRAH (אַבְרָם, father of elevation, or high father; Sept. Ἀβραμ), and this was his original name; but the extended form, which it always afterwards bears, was given to it to make it significant of the promise of a numerous posterity which was at the same time made to him.

Abraham was a native of Chaldea, and descended, through Heber, in the ninth generation, from Shem the son of Noah. His father was Terah, who had two other sons, Nahor and Haran. Haran died prematurely 'before his father,' leaving a son Lot, and two daughters, Milcah and Iscah. Lot attached himself to his uncle Abraham; Milcah became the wife of her uncle Nahor; and Iscah, who was also called Sarai, became the wife of Abraham (Gen. xi. 26-29: comp. Joseph. Antiq. i. 6, 5) [ISCAH].

Abraham was born A.M. 2008, B.C. 1996 (Hales, A.M. 3258, B.C. 2153), in 'Ur of the Chaldees' (Gen. xi. 28). The concise history in Genesis states nothing concerning the portion of

his life prior to the age of 60; and respecting a person living in times so remote no authentic information can be derived from any other source. There are indeed traditions, but they are too manifestly *built up* on the foundation of a few obscure intimations in Scripture to be entitled to any credit. Thus it is intimated in Josh. xxiv. 2, that Terah and his family 'served other gods' beyond the Euphrates: and on this has been founded the romance that Terah was not only a worshipper, but a maker of idols; that the youthful Abraham, discovering the futility of such gods, destroyed all those his father had made, and justified the act in various conversations and arguments with Terah, which we find repeated at length. Again, 'Ur of the Chaldees' was the name of the place where Abraham was born, and from which he went forth to go, he knew not whither, at the call of God. Now Ur (𐤎𐤍) means *fire*; and we may therefore read that he came forth from the *fire of the Chaldees*; on which has been built the story that Abraham was, for his disbelief in the established idols, cast by king Nimrod into a burning furnace, from which he was by special miracle delivered. And to this the premature death of Haran has suggested the addition that he, by way of punishment for his disbelief of the truths for which Abraham suffered, was marvellously destroyed by the same fire from which his brother was still more marvellously preserved. Again, the fact that Chaldea was the region in which astronomy was reputed to have been first cultivated, suggested that Abraham brought astronomy westward, and that he even taught that science to the Egyptians (Joseph. *Antiq.* i. 8). These are goodly specimens of tradition-building; and more of them may be found in the alleged history of Abraham by those who think them worth the trouble of the search. It is just to Josephus to state that most of these stories are rejected by him, although the tone of some of his remarks is in agreement with them.

Although Abraham is, by way of eminence, named first, it appears probable that he was the youngest of Terah's sons, and born by a second wife, when his father was 130 years old. Terah was seventy years old when the eldest son was born (Gen. xi. 32; xii. 4; xx. 12: comp. Hales, ii. 107); and that eldest son appears to have been Haran, from the fact that his brothers married his daughters, and that his daughter Sarai was only ten years younger than his brother Abraham (Gen. xvii. 17). It is shown by Hales (ii. 107), that Abraham was 60 years old when the family quitted their native city of Ur, and went and abode in Charran. The reason for this movement does not appear in the Old Testament. Josephus alleges that Terah could not bear to remain in the place where Haran had died (*Antiq.* i. 6. 5); while the apocryphal book of Judith, in conformity with the traditions still current among the Jews and Moslems, affirms that they were cast forth because they would no longer worship the gods of the land (Judith v. 6-8). The real cause transpires in Acts vii. 2-4: 'The God of glory appeared to our father Abraham while he was (at Ur of the Chaldees) in Mesopotamia, before he dwelt in Charran, and said unto him, Depart from thy land, and from thy kindred, and come hither to a land (γῆν) which I will shew thee. Then departing from the land of the Chaldees, he dwelt

in Charran.' This *first* call is not recorded, but only implied in Gen. xii.: and it is distinguished by several pointed circumstances from the *second*, which alone is there mentioned. Accordingly Abraham departed, and his family, including his aged father, removed with him. They proceeded not at once to the land of Canaan, which indeed had not been yet indicated to Abraham as his destination; but they came to Charran, and tarried at that convenient station for fifteen current years, until Terah died, at the age of 205 years. Being free from his filial duties, Abraham, now 75 years of age, received a second and more pointed call to pursue his destination: 'Depart from thy land, and from thy kindred, and from thy father's house, unto the land (אֶרֶץ, τῆν γῆν), which I will shew thee' (Gen. xii. 1). The difference of the two calls is obvious: in the former the *land* is indefinite, being designed only for a temporary residence; in the latter it is definite, intimating a permanent abode. A third condition was also annexed to the latter call, that he should separate from his father's house, and leave his brother Nabor's family behind him in Charran. This must have intimated to him that the Divine call was personal to himself, and required that he should be isolated not only from his nation, but from his family. He however took with him his nephew Lot, whom, having no children of his own, he appears to have regarded as his heir, and then went forth 'not knowing whither he went' (Heb. xi. 8), but trusting implicitly to the Divine guidance. And it seems to have been the intention of Him by whom he had been called, to open gradually to him the high destinies which awaited him and his race, as we perceive that every successive communication with which he was favoured rendered more sure and definite to him the objects for which he had been called from the land of his birth.

No particulars of the journey are given. Abraham arrived in the land of Canaan, which he found occupied by the Canaanites in a large number of small independent communities, which cultivated the districts around their several towns. The country was however but thinly peopled; and, as in the more recent times of its depopulation, it afforded ample pasture-grounds for the wandering pastors. One of that class Abraham must have appeared in their eyes. In Mesopotamia the family had been pastoral, but dwelling in towns and houses, and sending out the flocks and herds under the care of shepherds. But the migratory life to which Abraham had now been called, compelled him to take to the tent-dwelling as well as the pastoral life: and the usages which his subsequent history indicates are therefore found to present a condition of manners and habits analogous to that which still exists among the nomade pastoral, or Bedouin tribes of south-western Asia.

The rich pastures in that part of the country tempted Abraham to form his first encampment in the vale of Moreh, which lies between the mountains of Ebal and Gerizim. Here the strong faith which had brought the childless man thus far from his home was rewarded by the grand promise:—'I will make of thee a great nation, and I will bless thee and make thy name great, and thou shalt be a blessing; and I will bless them that bless thee, and curse them that curse

thee: and in thee shall all the families of the earth be blessed' (Gen. xii. 2, 3). It was further promised that to his posterity should be given the rich heritage of that beautiful country into which he had come (v. 7). It will be seen that this important promise consisted of two parts, the one temporal, the other spiritual. The *temporal* was the promise of posterity, that he should be blessed himself, and be the founder of a great nation; the *spiritual*, that he should be the chosen ancestor of the Redeemer, who had been of old obscurely predicted (Gen. iii. 15), and thereby become the means of blessing all the families of the earth. The implied condition on his part was, that he should publicly profess the worship of the true God in this more tolerant land; and accordingly 'he built there an altar unto the Lord, who appeared unto him.' He soon after removed to the district between Bethel and Ai, where he also built an altar to that 'JEHOVAH' whom the world was then hastening to forget. His farther removals tended southward, until at length a famine in Palestine compelled him to withdraw into Egypt, where corn abounded. Here his apprehension that the beauty of his wife Sarai might bring him into danger with the dusky Egyptians, overcame his faith and rectitude, and he gave out that she was his sister. As he had feared, the beauty of the fair stranger excited the admiration of the Egyptians, and at length reached the ears of the king, who forthwith exercised his regal right of calling her to his harem, and to this Abraham, appearing as only her brother, was obliged to submit. As, however, the king had no intention to act harshly in the exercise of his privilege, he loaded Abraham with valuable gifts, suited to his condition, being chiefly in slaves and cattle. These presents could not have been refused by him without an insult which, under all the circumstances, the king did not deserve. A grievous disease inflicted on Pharaoh and his household relieved Sarai from her danger, by revealing to the king that she was a married woman; on which he sent for Abraham, and, after rebuking him for his conduct, restored his wife to him, and recommended him to withdraw from the country. He accordingly returned to the land of Canaan, much richer than when he left it 'in cattle, in silver, and in gold' (Gen. xii. 8; xiii. 2).

Lot also had much increased his possessions: and soon after their return to their previous station near Bethel, the disputes between their respective shepherds about water and pasturage soon taught them that they had better separate. The recent promise of posterity to Abraham himself, although his wife had been accounted barren, probably tended also in some degree to weaken the tie by which the uncle and nephew had hitherto been united. The subject was broached by Abraham, who generously conceded to Lot the choice of pasture-grounds. Lot chose the well-watered plain in which Sodom and other towns were situated, and removed thither [Lot]. Thus was accomplished the dissolution of a connection which had been formed before the promise of children was given, and the disruption of which appears to have been necessary for that complete isolation of the coming race which the Divine purpose required. Immediately afterwards the patriarch was cheered and encouraged by a more distinct and formal reiteration of the promises which had

been previously made to him, of the occupation of the land in which he lived by a posterity numerous as the dust. Not long after, he removed to the pleasant valley of Mamre, in the neighbourhood of Hebron (then called Arba), and pitched his tent under a terebinth tree (Gen. xiii.).

It appears that fourteen years before this time the south and east of Palestine had been invaded by a king called Chedorlaomer, from beyond the Euphrates, who brought several of the small disunited states of those quarters under tribute. Among them were the five cities of the Plain of Sodom, to which Lot had withdrawn. This burden was borne impatiently by these states, and they at length withheld their tribute. This brought upon them a ravaging visitation from Chedorlaomer and four other (perhaps tributary) kings, who scoured the whole country east of the Jordan, and ended by defeating the kings of the plain, plundering their towns, and carrying the people away as slaves. Lot was among the sufferers. When this came to the ears of Abraham, he immediately armed such of his slaves as were fit for war, in number 318, and being joined by the friendly Amoritic chiefs, Aner, Eshcol, and Mamre, pursued the retreating invaders. They were overtaken near the springs of the Jordan; and their camp being attacked on opposite sides by night, they were thrown into disorder, and fled. Abraham and his men pursued them as far as the neighbourhood of Damascus, and then returned with all the men and goods which had been taken away. Although Abraham had no doubt been chiefly induced to undertake this exploit by his regard for Lot, it involved so large a benefit, that, as the act of a sojourner, it must have tended greatly to enhance the character and power of the patriarch in the view of the inhabitants at large. In fact, we afterwards find him treated by them with high respect and consideration. When they had arrived as far as Salem on their return, the king of that place, Melchizedek, who was one of the few native princes, if not the only one, who retained the knowledge and worship of 'the Most High God,' whom Abraham served, came forth to meet them with refreshments, in acknowledgment for which, and in recognition of his character, Abraham presented him with a tenth of the spoils. By strict right, founded on the war usages which still subsist in Arabia (Burckhardt's *Notes*, p. 97), the recovered goods became the property of Abraham, and not of those to whom they originally belonged. This was acknowledged by the king of Sodom, who met the victors in the valley near Salem. He said, 'Give me the persons, and keep the goods to thyself.' But with becoming pride, and with a disinterestedness which in that country would now be most unusual in similar circumstances, he answered, 'I have lifted up mine hand [i. e. I have sworn] unto Jehovah, the most high God, that I will not take from a thread even to a sandal-thong, and that I will not take any thing that is thine, *lest thou shouldst say, I have made Abram rich*' (Gen. xiv.).

Soon after his return to Mamre the faith of Abraham was rewarded and encouraged, not only by a more distinct and detailed repetition of the promises formerly made to him, but by the confirmation of a solemn covenant contracted, as nearly as might be, 'after the manner of men' [COVENANT] between him and God. It was now

that he first understood that his promised posterity were to grow up into a nation under foreign bondage; and that, in 400 years after (or, strictly, 405 years, counting from the birth of Isaac to the Exode), they should come forth from that bondage as a nation, to take possession of the land in which he sojourned (Gen. xiv.).

After ten years' residence in Canaan (B.C. 1913), Sarai, being then 75 years old, and having long been accounted barren, chose to put her own interpretation upon the promised blessing of a progeny to Abraham, and persuaded him to take her woman-slave Hagar, an Egyptian, as a secondary or concubine-wife, with the view that whatever child might proceed from this union should be accounted her own [HAGAR]. The son who was born to Abraham by Hagar, and who received the name of Ishmael [ISHMAEL], was accordingly brought up as the heir of his father and of the promises (Gen. xvi.). Thirteen years after (B.C. 1900), when Abraham was 99 years old, he was favoured with still more explicit declarations of the Divine purposes. He was reminded that the promise to him was that he should be the father of many nations; and to indicate this intention his name was now changed (as before described) from *Abram* to *Abraham*. The Divine Being then solemnly renewed the covenant to be a God to him and to the race that should spring from him; and in token of that covenant directed that he and his should receive in their flesh the sign of circumcision [CIRCUMCISION]. Abundant blessings were promised to Ishmael; but it was then first announced, in distinct terms, that the heir of the special promises was not yet born, and that the barren Sarai, then 90 years old, should twelve months thence be his mother. Then also her name was changed from Sarai to Sarah (*the princess*); and to commemorate the laughter with which the prostrate patriarch received such strange tidings, it was directed that the name of Isaac (*he laughed*) should be given to the future child. The very same day, in obedience to the Divine ordinance, Abraham himself, his son Ishmael, and his household and purchased slaves were all circumcised (Gen. xvii.).

Three months after this, as Abraham sat in his tent door during the heat of the day, he saw three travellers approaching, and hastened to meet them, and hospitably pressed upon them refreshment and rest. They assented, and under the shade of a terebinth tree partook of the abundant fare which the patriarch and his wife provided, while Abraham himself stood by in respectful attendance. From the manner in which one of the strangers spoke, Abraham soon gathered that his visitants were no other than the Lord himself and two attendant angels in human form. The promise of a son by Sarah was renewed; and when Sarah herself, who overheard this within the tent, laughed inwardly at the tidings, which, on account of her great age, she at first disbelieved, she incurred the striking rebuke, 'Is any thing too hard for Jehovah?' The strangers then addressed themselves to their journey, and Abraham walked some way with them. The two angels went forward in the direction of Sodom, while the Lord made known to him that, for their enormous iniquities, Sodom and the other 'cities of the plain' were about to be made signal monuments of his wrath and of his moral government. Moved by com-

passion and by remembrance of Lot, the patriarch ventured, reverently but perseveringly, to intercede for the doomed Sodom; and at length obtained a promise that, if but ten righteous men were found therein, the whole city should be saved for their sake. Early the next morning Abraham arose to ascertain the result of this concession: and when he looked towards Sodom, the smoke of its destruction, rising 'like the smoke of a furnace,' made known to him its terrible overthrow [SODOM]. He probably soon heard of Lot's escape: but the consternation which this event inspired in the neighbourhood induced him, almost immediately after, to remove farther off into the territories of Abimelech, king of Gerar. By a most extraordinary infatuation and lapse of faith, Abraham allowed himself to stoop to the same mean and foolish prevarication in denying his wife, which, twenty-three years before, had occasioned him so much trouble in Egypt. The result was also similar [ABIMELECH], except that Abraham answered to the rebuke of the Philistine by stating the fears by which he had been actuated—adding, 'And yet indeed she is my sister; she is the daughter of my father, but not the daughter of my mother; and she became my wife.' This mends the matter very little, since in calling her his sister he designed to be understood as saying she was *not* his wife. As he elsewhere calls Lot his 'brother,' this statement that Sarah was his 'sister' does not interfere with the probability that she was his niece.

The same year* Sarah gave birth to the long-promised son, and, according to previous direction, the name of Isaac was given to him [ISAAC]. This greatly altered the position of Ishmael, who had hitherto appeared as the heir both of the temporal and the spiritual heritage; whereas he had now to share the former, and could not but know that the latter was limited to Isaac. This appears to have created much ill-feeling both on his part and that of his mother towards the child; which was in some way manifested so pointedly, on occasion of the festivities which attended the weaning, that the wrath of Sarah was awakened, and she insisted that both Hagar and her son should be sent away. This was a very hard matter to a loving father; and Abraham was so much pained that he would probably have refused compliance with Sarah's wish, had he not been apprised in a dream that it was in accordance with the Divine intentions respecting both Ishmael and Isaac. With his habitual uncompromising obedience, he then hastened them away early in the morning, with provision for the journey. Their adventures belong to the article HAGAR.

When Isaac was about 20 years old (B.C. 1872) it pleased God to subject the faith of Abraham to a severer trial than it had yet sustained, or that has ever fallen to the lot of any other mortal man. He was commanded to go into the mountainous country of Moriah (probably where the temple afterwards stood), and there offer up in sacrifice the son of his affection, and the heir of so many hopes and

* It is, however, supposed by some biblical critics that the preceding adventure with Abimelech is related out of its order, and took place at an earlier date. Their chief reason is that Sarah was now 90 years of age. But the very few years by which such a supposition might reduce this age, seem scarcely worth the discussion [SARAH].

promises, which his death must nullify. It is probable that human sacrifices already existed; and as, when they did exist, the offering of an only or beloved child was considered the most meritorious, it may have seemed reasonable to Abraham that he should not withhold from his own God the costly sacrifice which the heathen offered to their idols. The trial and peculiar difficulty lay in the singular position of Isaac, and in the unlikelihood that his loss could be supplied. But Abraham's 'faith' shrunk not, assured that what God had promised he would certainly perform, and that he was able to restore Isaac to him even from the dead' (Heb. xii. 17-19), and he rendered a ready, however painful, obedience. Assisted by two of his servants, he prepared wood suitable for the purpose, and without delay set out upon his melancholy journey. On the third day he described the appointed place; and informing his attendants that he and his son would go some distance farther to worship, and then return, he proceeded to the spot. To the touching question of his son respecting the victim to be offered, the patriarch replied by expressing his faith that God himself would provide the sacrifice; and probably he availed himself of this opportunity of acquainting him with the Divine command. At least, that the communication was made either then or just after is unquestionable; for no one can suppose that a young man of twenty-five could, against his will, have been bound with cords and laid out as a victim on the wood of the altar. Isaac would most certainly have been slain by his father's uplifted hand, had not the angel of Jehovah interposed at the critical moment to arrest the fatal stroke. A ram which had become entangled in a thicket was seized and offered; and a name was given to the place (יהוה יראה), *Jehovah-Jireh*—'the Lord will provide') allusive to the believing answer which Abraham had given to his son's inquiry respecting the victim. The promises before made to Abraham—of numerous descendants, superior in power to their enemies, and of the blessings which his spiritual progeny, and especially the Messiah, were to extend to all mankind—were again confirmed in the most solemn manner; for Jehovah swore by himself (comp. Heb. vi. 13, 17), that such should be the rewards of his uncompromising obedience. The father and son then rejoined their servants, and returned rejoicing to Beersheba (Gen. xxi. 19).

Eight years after (b.c. 1860) Sarah died at the age of 120 years, being then at or near Hebron. This loss first taught Abraham the necessity of acquiring possession of a family sepulchre in the land of his sojourning. His choice fell on the cave of Machpelah [MACHPELAH], and after a striking negotiation with the owner in the gate of Hebron, he purchased it, and had it legally secured to him, with the field in which it stood and the trees that grew thereon. This was the only possession he ever had in the Land of Promise (Gen. xxiii.). The next care of Abraham was to provide a suitable wife for his son Isaac. It has always been the practice among pastoral tribes to keep up the family ties by intermarriages of blood-relations (Burckhardt, *Notes*, p. 154): and now Abraham had a further inducement in the desire to maintain the purity of the separated race from foreign and idolatrous connections. He therefore sent his aged and confidential steward Eliezer, under the bond of a solemn oath to discharge

his mission faithfully, to renew the intercourse between his family and that of his brother Nahor, whom he had left behind in Charran. He prospered in his important mission [ISAAC], and in due time returned, bringing with him Rebekah, the daughter of Nahor's son Bethuel, who became the wife of Isaac, and was installed as chief lady of the camp, in the separate tent which Sarah had occupied (Gen. xxiv.). Some time after Abraham himself took a wife named Keturah, by whom he had several children. These, together with Ishmael, seem to have been portioned off by their father in his lifetime, and sent into the east and south-east, that there might be no danger of their interference with Isaac, the divinely appointed heir. There was time for this: for Abraham lived to the age of 175 years, 100 of which he had spent in the land of Canaan. He died in b.c. 1822 (Hales, 1978), and was buried by his two eldest sons in the family sepulchre which he had purchased of the Hittites (Gen. xxv. 1-10).

ABRAHAM'S BOSOM. There was no name which conveyed to the Jews the same associations as that of Abraham. As undoubtedly he was in the highest state of felicity of which departed spirits are capable, 'to be with Abraham' implied the enjoyment of the same felicity; and 'to be in Abraham's bosom' meant to be in repose and happiness with him. The latter phrase is obviously derived from the custom of sitting or reclining at table which prevailed among the Jews in and before the time of Christ [ACCUBATION]. By this arrangement, the head of one person was necessarily brought almost into the bosom of the one who sat above him, or at the top of the triclinium; and the guests were so arranged that the most favoured were placed so as to bring them into that situation with respect to the host (comp. John xiii. 23; xxi. 20). These Jewish images and modes of thought are amply illustrated by Lightfoot, Schoettgen, and Wetstein, who illustrate Scripture from Rabbinical sources. It was quite usual to describe a just person as being with Abraham, or lying on Abraham's bosom; and as such images were unobjectionable, Jesus accommodated his speech to them, to render himself the more intelligible by familiar notions, when, in the beautiful parable of the rich man and Lazarus, he describes the condition of the latter after death under these conditions (Luke xvi. 22, 23).

ABRECH (אַבְרֵךְ). This word occurs only in Gen. xli. 43, where it is used in proclaiming the authority of Joseph. Something similar happened in the case of Mordecai; but then several words were employed (Esth. vi. 11). If the word be Hebrew, it is probably an imperative of בָּרַךְ in Hiphil, and would then mean, as in our version, 'bow the knee!' We are indeed assured by Wilkinson (*Anc. Egyptians*, ii. 24) that the word *abrek* is used to the present day by the Arabs, when requiring a camel to kneel and receive its load. But Luther and others suppose the word to be a compound of אָבִירֵךְ, 'the father of the state,' and to be of Chaldee origin. It is however probably Egyptian, and Dr. Lee is inclined with De Rossi (*Etym. Egypt.* p. 1) to repair to the Coptic, in which *Aberek* or *Abrek* means 'bow the head.' It is right to add, that Origen, a native of Egypt, and Jerome, both of whom knew the Semitic languages, concur in the

opinion that *Abrech* means 'a native Egyptian;' and when we consider how important it was that Joseph should cease to be regarded as a foreigner [ABOMINATION], it has in this sense an importance and significance which no other interpretation conveys. It amounts to a proclamation of naturalization, which, among such a people as the Egyptians, was essential to enable Joseph to work out the great plan he had undertaken. We believe however that it is not now possible to determine the signification of the word with certainty.

ABSALOM (אֲבִשָׁלוֹם, *father of peace*; Sept. Ἀβεσσαλώμ; Vulg. *Absalon*), the third son of David, and his only son by Maachah, daughter of Talmi, king of Geshur (2 Sam. iii. 3). He was deemed the handsomest man in the kingdom; and was particularly noted for the profusion of his beautiful hair, which appears to have been regarded with great admiration; but of which we can know nothing with certainty, except that it was very fine and very ample. We are told that when its inconvenient weight compelled him at times (מִכֶּן כִּי־לִימִים לִימִים) does not necessarily mean 'every year,' as in the A.V.) to cut it off, it was found to weigh '200 shekels after the king's weight;' but as this has been interpreted as high as 112 ounces (Geddes) and as low as 7½ ounces (A. Clarke), we may be content to understand that it means a quantity unusually large. David's other child by Maachah was a daughter named Tamar, who was also very beautiful. She became the object of lustful regard to her half-brother Amnon, David's eldest son; and was violated by him. In all cases where polygamy is allowed, we find that the honour of a sister is in the guardianship of her full brother, more even than in that of her father, whose interest in her is considered less peculiar and intimate. We trace this notion even in the time of Jacob (Gen. xxxiv. 6, 13, 25, sqq.). So in this case the wrong of Tamar was taken up by Absalom, who kept her secluded in his own house, and said nothing for the present, but brooded silently over the wrong he had sustained and the vengeance which devolved upon him. It was not until two years had passed, and when this wound seemed to have been healed, that Absalom found opportunity for the bloody revenge he had meditated. He then held a great sheep-shearing feast at Baal-hazor near Ephraim, to which he invited all the king's sons; and, to lull suspicion, he also solicited the presence of his father. As he expected, David declined for himself, but allowed Amnon and the other princes to attend. They feasted together; and, when they were warm with wine, Amnon was set upon and slain by the servants of Absalom, according to the previous directions of their master. Horror-struck at the deed, and not knowing but that they were included in the doom, the other princes took to their mules and fled to Jerusalem, filling the king with grief and horror by the tidings which they brought. As for Absalom, he hastened to Geshur and remained there three years with his father-in-law, king Talmi.

Now it happened that Absalom, with all his faults, was eminently dear to the heart of his father. His beauty, his spirit, his royal birth, may be supposed to have drawn to him those fond paternal feelings which he knew not how to appreciate. At

all events, David mourned every day after the banished fratricide, whom a regard for public opinion and a just horror of his crime forbade him to recall. His secret wishes to have home his beloved though guilty son were however discerned by Joab, who employed a clever woman of Tekoah to lay a supposed case before him for judgment; and she applied the anticipated decision so adroitly to the case of Absalom, that the king discovered the object and detected the interposition of Joab. Regarding this as in some degree expressing the sanction of public opinion, David gladly commissioned Joab to 'call home his banished.' Absalom returned; but David, still mindful of his duties as a king and father, controlled the impulse of his feelings, and declined to admit him to his presence. After two years, however, Absalom, impatient of his disgrace, found means to compel the attention of Joab to his case; and through his means a complete reconciliation was effected, and the father once more indulged himself with the presence of his son (2 Sam. xiii. xiv.).

The position at this time occupied by Absalom was very peculiar, and the view of it enables us to discover how far the general Oriental laws of primogeniture were affected by the peculiar conditions of the Hebrew constitution. At the outset he was the third son of David, Amnon and Chileab being his elder brothers. But it was possible that he might even then, while they lived, consider himself entitled to the succession; and Oriental usage would not have discountenanced the pretension. He alone was of royal descent by the side of his mother; and royal or noble descent by the mother is even now (as we see by the recent instance of Abbas Meerza in Persia) of itself a sufficient ground of preference over an elder brother whose maternal descent is less distinguished. This circumstance, illustrated by Absalom's subsequent conduct, may suggest that he early entertained a design upon the succession to the throne, and that the removal of Amnon was quite as much an act of policy as of revenge. The other elder brother, Chileab, appears to have died: and if the claims of Absalom, or rather his grounds of pretension, were so important while Amnon and Chileab lived, his position must have been greatly strengthened when, on his return from exile, he found himself the eldest surviving son, and, according to the ordinary laws of primogeniture, the heir apparent of the crown. Such being his position, and his father being old, it would seem difficult at the first view to assign a motive for the conspiracy against the crown and life of his indulgent father, in which we soon after find him engaged. It is then to be considered that the king had a dispensing power, and was at liberty, according to all Oriental usage, to pass by the eldest son and to nominate a younger to the succession. This could not have affected Absalom, as there is every reason to think that David, if left to himself, would have been glad to have seen the rule of succession take its ordinary course in favour of his best loved son. But then, again, under the peculiar theoretical institutions of the Hebrews, the Divine king reserved and exercised a power of dispensation, over which the human king, or viceroy, had no control. The house of David was established as a reigning dynasty; and although the law of

primogeniture was allowed eventually to take in general its due course, the Divine king reserved the power of appointing any member of that house whom he might prefer. That power had been exercised in the family of David by the preference of Solomon, who was at this time a child, as the successor of his father. David had known many years before that his dynasty was to be established in a son not yet born (2 Sam. vii. 12); and when Solomon was born, he could not be ignorant, even if not specially instructed, that *he* was the destined heir. This fact must have been known to many others as the child grew up, and probably the mass of the nation was cognizant of it. In this we find a clear motive for the rebellion of Absalom—to secure the throne which he deemed to be his right by the laws of primogeniture, during the lifetime of his father; lest delay, while awaiting the natural term of his days, should so strengthen the cause of Solomon with his years, as to place his succession beyond all contest.

The fine person of Absalom, his superior birth, and his natural claim, pre-disposed the people to regard his pretensions with favour: and this pre-disposition was strengthened by the measures which he took to win their regard. In the first place he insinuated that he was the heir apparent, by the state and attendance with which he appeared in public; while that very state the more enhanced the show of condescending sympathy with which he accosted the suitors who repaired for justice or favour to the royal audience, inquired into their various cases, and hinted at the fine things which might be expected if he were on the throne, and had the power of accomplishing his own large and generous purposes. By these influences 'he stole the hearts of the men of Israel'; and when at length, four years after his return from Geshur, he repaired to Hebron and there proclaimed himself king, the great body of the people declared for him. So strong ran the tide of opinion in his favour, that David found it expedient to quit Jerusalem and retire to Mahanaim, beyond the Jordan.

When Absalom heard of this, he proceeded to Jerusalem and took possession of the throne without opposition. Among those who had joined him was Ahithophel, who had been David's counsellor, and whose profound sagacity caused his counsels to be regarded like oracles in Israel. This defection alarmed David more than any other single circumstance in the affair, and he persuaded his friend Hushai to go and join Absalom, in the hope that he might be made instrumental in turning the sagacious counsels of Ahithophel to foolishness. The first piece of advice which Ahithophel gave Absalom was that he should publicly take possession of that portion of his father's harem which had been left behind in Jerusalem. This was not only a mode by which the succession to the throne might be confirmed [ABISHAG: comp. Herodotus, iii. 68], but in the present case, as suggested by the wily counsellor, this villainous measure would dispose the people to throw themselves the more unreservedly into his cause, from the assurance that no possibility of reconciliation between him and his father remained. Hushai had not then arrived. Soon after he came, when a council of war was held, to consider the course of operations to be taken against David. Ahithophel counselled that the king

should be pursued that very night, and smitten, while he was 'weary and weak handed, and before he had time to recover strength.' Hushai, however, whose object was to gain time for David, speciously urged, from the known valour of the king, the possibility and fatal consequences of a defeat, and advised that all Israel should be assembled against him in such force as it would be impossible for him to withstand. Fatally for Absalom, the counsel of Hushai was preferred to that of Ahithophel; and time was thus given to enable the king, by the help of his influential followers, to collect his resources, as well as to give the people time to reflect upon the undertaking in which so many of them had embarked. The king soon raised a large force, which he properly organized and separated into three divisions, commanded severally by Joab, Abishai, and Ittai of Gath. The king himself intended to take the chief command; but the people refused to allow him to risk his valued life, and the command then devolved upon Joab. The battle took place in the borders of the forest of Ephraim; and the tactics of Joab, in drawing the enemy into the wood, and there hemming them in, so that they were destroyed with ease, eventually, under the providence of God, decided the action against Absalom. Twenty thousand of his troops were slain, and the rest fled to their homes. Absalom himself fled on a swift mule; but as he went, the boughs of a terebinth tree caught the long hair in which he gloried, and he was left suspended there. The charge which David had given to the troops to respect the life of Absalom prevented any one from slaying him: but when Joab heard of it, he hastened to the spot, and pierced him through with three darts. His body was then taken down and cast into a pit there in the forest, and a heap of stones was raised upon it.

David's fondness for Absalom was unextinguished by all that had passed; and as he sat, awaiting tidings of the battle, at the gate of Mahanaim, he was probably more anxious to learn that Absalom lived, than that the battle was gained; and no sooner did he hear that Absalom was dead, than he retired to the chamber above the gate, to give vent to his paternal anguish. The victors, as they returned, slunk into the town like criminals, when they heard the bitter wailings of the king:—'O my son Absalom! my son, my son Absalom! would God I had died for thee, O Absalom, my son, my son!' The consequences of this weakness—not in his feeling, but in the inability to control it—might have been most dangerous, had not Joab gone up to him, and, after sharply rebuking him for thus discouraging those who had risked their lives in his cause, induced him to go down and cheer the returning warriors by his presence (2 Sam. xiii.-xix. 8).

ABSALOM'S TOMB. A remarkable monument bearing this name makes a conspicuous figure in the Valley of Jehoshaphat, outside Jerusalem; and it has been noticed and described by almost all travellers. It is close by the lower bridge over the Kedron, and is a square isolated block hewn out from the rocky ledge so as to leave an area or niche around it. The body of this monument is about 24 feet square, and is ornamented on each side with two columns and two half co-

lums of the Ionic order, with pilasters at the corners. The architrave exhibits triglyphs and Doric ornaments. The elevation is about 18 or 20 feet to the top of the architrave, and thus far it is wholly cut from the rock. But the adjacent rock is here not so high as in the adjoining tomb of Zecharias (so called), and therefore the upper part of the tomb has been carried up with mason-work of large stones. This consists, first, of two square layers, of which the upper one is smaller than the lower; and then a small dome or cupola runs up into a low spire, which appears to have spread out a little at the top, like an opening flame. This mason-work is perhaps 20 feet high, giving to the whole an elevation of about 40 feet. There is a small excavated chamber in the body of the tomb, into which a hole had been broken through one of the sides several centuries ago.

The old travellers who refer to this tomb, as well as Calmet after them, are satisfied that they find the history of it in 2 Sam. xviii. 18, which states that Absalom, having no son, built a monument to keep his name in remembrance, and that this monument was called 'Absalom's Hand'—that is, *index, memorial, or monument* [HAND]. With our later knowledge, a glance at this and the other monolithic tomb bearing the name of Zecharias, is quite enough to show that they had no connection with the times of the persons whose names have been given to them. 'The style of architecture and embellishment,' writes Dr. Robinson, 'shows that they are of a later period than most of the other countless sepulchres round about the city, which, with few exceptions, are destitute of architectural ornament. Yet, the foreign ecclesiastics, who crowded to Jerusalem in the fourth century, found these

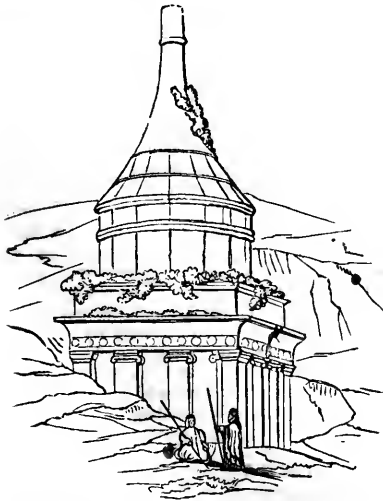

monuments here; and of course it became an object to refer them to persons mentioned in the Scriptures. Yet, from that day to this, tradition seems never to have become fully settled as to the individuals whose names they should bear. The *Itin. Hieros.* in A.D. 333, speaks of the two monolithic monuments as the tombs of Isaiah and

Hezekiah. Adamnus, about A.D. 697, mentions only one of these, and calls it the tomb of Jehoshaphat. . . . The historians of the Crusades appear not to have noticed these tombs. The first mention of a tomb of Absalom is by Benjamin of Tudela, who gives to the other the name of King Uzziah; and from that time to the present day the accounts of travellers have been varying and inconsistent' (*Biblical Researches*, i. 519, 520). The remarks of professed architects on things requiring a real knowledge of the Scriptures and of the ancient Hebrews, are generally so unsound and trivial that little can be expected from them in such matters. Yet with the clear information on some points which we now possess, it is surprising to hear so learned an architect as Professor Cockerell speak of this alleged tomb of Absalom as a most precious monument of antiquity, and insist on its undoubted identity, and its 'perfect correspondence with holy writ' (*Athenæum*, Jan. 28, 1843); which holy writ says no more than that Absalom *did erect some monument.*

ABSINTHIUM (*Ἀψίνθιον* in New Test., by which also the Sept. renders the Heb. מַרְרֹן; A. V. *wormwood*). This proverbially bitter plant is used in the Hebrew, as in most other languages, metaphorically, to denote the moral bitterness of distress and trouble (Deut. xxix. 17; Prov. v. 4; Jer. ix. 14; xxiii. 15; Lam. iii. 15, 19; Amos v. 7; vi. 12). Thence also the name given to the fatal star in Rev. viii. 10, 11. *Artemisia* is the botanical name of the genus of plants in which the different species of wormwoods are found. The plants of this genus are easily recognised by the multitude of fine divisions into which the leaves are usually separated, and the numerous clusters of small, round, drooping, greenish-yellow, or brownish flower-heads with which the branches are laden. It must be understood that our common wormwood (*Artemisia absinthium*) does not appear to exist in Palestine, and cannot therefore be that specially denoted by the Scriptural term. Indeed it is more than probable that the word is intended to apply to *all* the plants of this class that grew in Palestine, rather than to any one of them in particular. The examples of this genus that have been found in that country are:—1. *Artemisia Judaica*, which, if a particular species be intended, is probably the Absinthium of Scripture. Rauwolf found it about Bethlehem, and Shaw in Arabia and the deserts of Numidia plentifully. This plant is erect and shrubby, with stem about eighteen inches high. Its taste is very bitter; and both the leaves and seeds are much used in Eastern medicine, and are reputed to be tonic, stomachic, and anthelmintic. 2. *Artemisia Romana*, which was found by Hasselquist on Mount Tabor (p. 281). This species is herbaceous, erect, with stem one or two feet high (higher when cultivated in gardens), and nearly upright branches. The plant has a pleasantly aromatic scent; and the bitterness of its taste is so tempered by the aromatic flavour as scarcely to be disagreeable. 3. *Artemisia abrotanum*, found in the south of Europe, as well as in Syria and Palestine, and eastward even to China. This is a hoary plant, becoming a shrub in warm countries; and its branches bear loose panicles of nodding yellow flower-heads. It is bitter and aromatic, with a very strong scent. It is not much used in

medicine; but the branches are employed in imparting a yellow dye to wool.



[*Artemisia Judaica.*]

ABSTINENCE is a refraining from the use of certain articles of food usually eaten; or from all food during a certain time for some particular object. It is distinguished from **TEMPERANCE**, which is moderation in ordinary food; and from **FASTING**, which is abstinence from a religious motive. The first example of abstinence which occurs in Scripture is that in which the use of blood is forbidden to Noah (Gen. ix. 20) [**BLOOD**]. The next is that mentioned in Gen. xxxii. 32: 'The children of Israel eat not of the sinew which shrank, which is upon the hollow of the thigh, *unto this day*, because he (the angel) touched the hollow of Jacob's thigh in the sinew that shrank.' This practice of particular and commemorative abstinence is here mentioned by anticipation long after the date of the fact referred to, as the phrase '*unto this day*' intimates. No actual instance of the practice occurs in the Scripture itself, but the usage has always been kept up; and to the present day the Jews generally abstain from the whole hind-quarter on account of the trouble and expense of extracting the particular sinew (Allen's *Modern Judaism*, p. 421). By the law, abstinence from blood was confirmed, and the use of the flesh of even lawful animals was forbidden, if the manner of their death rendered it impossible that they should be, or uncertain that they were, duly exsanguinated (Exod. xxii. 31; Deut. xiv. 21). A broad rule was also laid down by the law, defining whole classes of animals that might not be eaten (Lev. xi.) [**ANIMAL; FOOD**]. Certain parts of lawful animals, as being sacred to the altar, were also interdicted. These were the large lobe of the liver, the kidneys and the fat upon them, as well as the tail of the 'fat-tailed' sheep (Lev. iii. 9-11). Everything consecrated to idols was also forbidden (Exod. xxxiv. 15). In conformity with these rules the Israelites abstained generally from food which was more or less in use among other people. Instances of abstinence from allowed food are not frequent, except in commemorative or afflictive fasts. The forty days' abstinence of Moses, Elijah, and Jesus are peculiar cases requiring to be separately considered [**FASTING**]. The priests were commanded to abstain from wine previous to their actual ministrations (Lev. x. 9), and the same abstinence was enjoined to the Nazarites during the whole period of their separation (Num. vi. 5). A constant abstinence of this kind was, at a later period, voluntarily undertaken by the Rechabites (Jer. xxxv. 16, 18). Among the early Christian converts there were some who deemed themselves bound to adhere to the Mosaical limitations regarding food, and they accordingly abstained from

flesh sacrificed to idols, as well as from animals which the law accounted unclean; while others contemned this as a weakness, and exulted in the liberty wherewith Christ had made his followers free. This question was repeatedly referred to St. Paul, who laid down some admirable rules on the subject, the purport of which was, that every one was at liberty to act in this matter according to the dictates of his own conscience; but that the strong-minded had better abstain from the exercise of the freedom they possessed, whenever it might prove an occasion of stumbling to a weak brother (Rom. xiv. 1-3; 1 Cor. viii.). In another place the same apostle reproves certain sectaries who should arise, forbidding marriage and enjoining abstinence from meats which God had created to be received with thanksgiving (1 Tim. iv. 3, 4). The council of the apostles at Jerusalem decided that no other abstinence regarding food should be imposed upon the converts than 'from meats offered to idols, from blood, and from things strangled' (Acts xv. 29).

The Essenes, a sect among the Jews which is not mentioned by name in the Scriptures, led a more abstinent life than any recorded in the sacred books. As there is an account of them elsewhere [**ESSENES**], it is only necessary to mention here that they refused all pleasant food, eating nothing but coarse bread and drinking only water; and that some of them abstained from food altogether until after the sun had set (Philo, *De Vita Contemplativa*, p. 692, 696).

That abstinence from ordinary food was practised by the Jews medicinally is not shown in Scripture, but is more than probable, not only as a dictate of nature, but as a common practice of their Egyptian neighbours, who, we are informed by Diodorus (i. 82), 'being persuaded that the majority of diseases proceed from indigestion and excess of eating, had frequent recourse to *abstinence*, emetics, slight doses of medicine, and other simple means of relieving the system, which some persons were in the habit of repeating every two or three days.'

ABYSS (*ἄβυσσος*). The Greek word means literally '*without bottom*,' but actually *deep, profound*. It is used in the Sept. for the Hebrew צוּהַת, which we find applied either to the ocean (Gen. i. 2; vii. 11), or to the under world (Ps. lxxi. 21; cvii. 26). In the New Testament it is used as a noun to describe Hades, or the place of the dead generally (Rom. x. 7); but more especially that part of Hades in which the souls of the wicked were supposed to be confined (Luke viii. 31; Rev. ix. 1, 2, 11; xx. 1, 3; comp. 2 Pet. ii. 4). In the Revelation the authorized version invariably renders it '*bottomless pit*,' elsewhere '*deep*.'

Most of these uses of the word are explained by reference to some of the cosmological notions which the Hebrews entertained in common with other Eastern nations. It was believed that the abyss, or sea of fathomless waters, encompassed the whole earth. The earth floated on the abyss, of which it covered only a small part. According to the same notion, the earth was founded upon the waters, or, at least, had its foundations in the abyss beneath (Ps. xxiv. 2; cxxxvi. 6). Under these waters, and at the bottom of the abyss, the wicked were represented as groaning, and undergoing the punishment of their sins.

There were confined the Rephaim—those old giants who while living caused surrounding nations to tremble (Prov. ix. 18; xxix. 16). In those dark regions the sovereigns of Tyre, Babylon, and Egypt are described by the prophets as undergoing the punishment of their cruelty and pride (Jer. xxvi. 14; Ezek. xxviii. 10, &c.). This was 'the deep' into which the evil spirits in Luke, viii. 31, besought that they might not be cast, and which was evidently dreaded by them [COSMOGONY; HADES].

The notion of such an abyss was by no means confined to the East. It was equally entertained by the Celtic Druids, who held that *Anwn* (the deep, the low port), the abyss from which the earth arose, was the abode of the evil principle (Gwarthawn), and the place of departed spirits, comprehending both the Elysium and the Tartarus of antiquity. With them also wandering spirits were called *Plant anwn*, 'the children of the deep' (Davis's *Celtic Researches*, p. 175; *Myth. and Rites of the B. Druids*, p. 49).

ABYSSINIA. 'There is no part of Africa, Egypt being excepted, the history of which is connected with so many objects of interest as Abyssinia. A region of Alpine mountains, ever difficult of access by its nature and peculiar situation, concealing in its bosom the long-sought sources of the Nile, and the still more mysterious origin of its singular people, Abyssinia has alone preserved, in the heart of Africa, its peculiar literature and its ancient Christian church. What is still more remarkable, it has preserved existing remains of a previously existing and wide-spread Judaism, and with a language approaching more than any living tongue to the Hebrew, a state of manners, and a peculiar character of its people, which represent in these latter days the habits and customs of the ancient Israelites in the times of Gideon and of Joshua. So striking is the re-

probable hypothesis, which should bring them down as a band of wandering shepherds from the mountains of Habesh (Abyssinia), and identify them with the pastor kings, who, according to Manetho, multiplied their bands of the Pharaohs, and being, after some centuries, expelled thence by the will of the gods, sought refuge in Judea, and built the walls of Jerusalem. Such an hypothesis would explain the existence of an almost Israelitish people, and the preservation of a language so nearly approaching to the Hebrew, in intertropical Africa. It is certainly untrue, and we find no other easy explanation of the facts which the history of Abyssinia presents, and particularly the early extension of the Jewish religion and customs through that country' Prichard's *Physical History of Man*, pp. 279, 280).

The above paragraph will suggest the grounds which appear to entitle Abyssinia to a place in a Biblical Cyclopædia. But as the country has no physical connection with Palestine—which is, geographically, our central object—a particular description of it is not necessary, and it will suffice to notice the points of inquiry suggested by the quotation. A brief outline is all that seems requisite.

'ABYSSINIA' is an European improvement upon the native name of 'HABESH.' That this country lies to the south of Nubia, which separates it from Egypt, and to the east of the Gulf of Bab-el-Mandah and the southern part of the Arabian sea, will sufficiently indicate its position. Abyssinia is a high country, which has been compared by Humboldt to the lofty Plain of Quito. By one of those beautiful synthetical operations of which his writings offer so many examples, the greatest living geographer, Carl Ritter of Berlin, has established, from the writings of various travellers, that the high country of Habesh consists of three terraces, or distinct table-lands, rising one above another, and of which the several grades of ascent offer themselves in succession to the traveller as he advances from the shores of the Red Sea (*Erdkunde*, th. i. s. 168). The *first* of these levels is the plain of Baharnegash; the *second* level is the plain and kingdom of Tigré, which formerly contained the kingdom of Axum; the *third* level is High Abyssinia, or the kingdom of Ambara. This name of Ambara is now given to the whole kingdom, of which Gondar is the capital, and where the Amharic language is spoken, eastward of the Takazzé. Ambara Proper is, however, a mountainous province to the south-east, in the centre of which was Tegulat, the ancient capital of the empire, and at one period the centre of the civilization of Abyssinia. This province is now in the possession of the Gallas, a barbarous people who have overcome all the southern parts of Habesh. The present kingdom of Ambara is the heart of Abyssinia, and the abode of the emperor, or *Negush*. It contains the upper course of the Nile, the valley of Dembea, and the lake Tzana, near which is the royal city of Gondar, and likewise the high region of Gojam, which Bruce states to be at least two miles above the level of the sea.

Abyssinia is inhabited by several distinct races, who are commonly included under the name of Habesh or Abyssins. They are clearly distin-



Female.

Priests.

Warrior.

semblance between the modern Abyssinians and the Hebrews of old, that we can hardly look upon them but as branches of one nation; and if we had not convincing evidence to the contrary, and knew not for certain that the Abrahamidæ originated in Chaldea, and to the northward and eastward of Palestine, we might frame a very

quished from each other by their languages, but have more or less resemblance in manners and physical character. These races are—1. The *Tigrani*, or Abyssins of the kingdom of Tigré, which nearly coincides in extent with the old kingdom of Axum. They speak a language called by Tellez and Ludolph *lingua Tigrania*. It is a corruption or modern dialect of the Gheez or old Ethiopic, which was the ancient vernacular tongue of the province; but is now a dead language consecrated to literature and religious uses [ETHIOPIC LANGUAGE], and the modern language of Tigré has been for more than five centuries merely an oral dialect. 2. The *Amharas*, who have been for ages the dominant people in Abyssinia; the genuine Ambara being considered as a higher and nobler caste, as the military and royal tribe. Their language—the Amharic—now extends over all the eastern parts of Abyssinia, including various provinces, some of which appear at one time to have had vernacular languages of their own. 3. The *Agows*, which name is borne by two tribes, who speak different languages and inhabit different parts of Abyssinia. These are the Agows of Damot, one of the most extensive of the southern provinces, where they are settled about the sources and on the banks of the Nile; and the Agows of Lasta, who, according to Bruce, are Troglodytes, living in caverns and paying the same adoration to the river Takazzé which those of Damot pay to the Nile. These last are called by Salt the Agows of Takazzé; and although they scarcely differ from the other Abyssinians in physical character, their language shows them to be a distinct race from the *Persian* as well as from the Ambara. 4. The *Falasha*, a people whose present condition suggests many curious inquiries, and the investigation of whose history may hereafter throw light upon that of the Abyssins, and of their literature and ecclesiastical antiquities. They all profess the Jewish religion, and probably did so before the era of the conversion of the Abyssins to Christianity. They themselves profess to derive their origin from Palestine; but their language, which is said to have no affinity with the Hebrew, seems sufficiently to refute this pretension (Vater, *Mithridates*, t. iii.). According to Bruce, the Falasha were very powerful at the time of the conversion of the Abyssins to Christianity. They were formerly a caste of potters and tile-makers in the low country of Dembea, but, owing to religious animosities, and being weakened by long wars, they were driven out thence, and took refuge among rugged and almost inaccessible rocks, in the high ridge called the mountains of Samen, where they live under princes of their own, bearing Hebrew names, and paying tribute to the Negushi. It is conjectured that the Falasha and the Agows were at one time the principal inhabitants of the south-eastern parts of Abyssinia. 5. The *Gafats*, a pagan tribe, with a distinct language, living on the southern banks of the Nile, near Damot. 6. The *Gongas* and *Enareans*. The former inhabit the province of Gonga, and have a language distinct from all the preceding, but the same which is spoken by the people of Narea, or Enarea, to the southward of Habesh. 7. To these we should perhaps now add the *Gallas*, a race of wandering herdsmen, extensively spread in eastern intertropical Africa,

who have become, during the last century, very formidable by their numbers, and threaten to overwhelm the Abyssinian empire.

The Abyssinians are to be regarded as belonging to the *black* races of men, but this is to be received with some explanation. Without entering into particulars, it may be observed, after Ruppell (*Reise in Abyssinien*), that there are two physical types prevalent among the Abyssinians. The greater number are a finely-formed people of the European type, having a countenance and features precisely resembling those of the Bedouins of Arabia. To this class belong most of the inhabitants of the high mountains of Samen, and of the plains around Lake Tzana, as well as the Falasha, or Jews, the heathen Gafats, and the Agows, notwithstanding the variety of their dialects. The other and very large division of the Abyssinian people is identified, as far as physical traits are concerned, with the race which has been distinguished by the name of Ethiopian. This race is indicated by a somewhat flattened nose, thick lips, long and rather dull eyes, and by very strongly crisped and almost woolly hair, which stands very thickly upon the head. They are therefore one of the connecting links between the Arabian and the Negro races, being separated from the former by a somewhat broader line than from the latter. In their essential characteristics they agree with the Nubians, Berberines, and native Egyptians (Prichard's *Nat. Hist. of Man*, p. 285).

Abyssinia has for ages been united under one governor, who during the earliest periods resided at Axum, the ancient capital of Tigré; but who for some centuries past has resided at Gondar, a more central part of the kingdom. For ages also the Abyssins have been Christians, but with a strange mixture of the Judaism which appears to have been previously professed, and with the exceptions which have been already indicated. Tigré, in which was the ancient capital of the empire, was the country in which Judaism appears to have been in former times the most prevalent. It was also the country which possessed, in the Gheez or ancient Ethiopic, a Semitic language. It was, moreover, the seat of civilization, which, it is important to observe, appears to have been derived from the opposite coast of Arabia, and to have had nothing Egyptian or Nubian in its character.

These observations have brought us back again to the difficulty stated at the commencement of this article, in the words of Dr. Prichard, which has hitherto been considered insuperable. There is no doubt, however, that this difficulty has chiefly arisen from attempting to explain *all* the phenomena on a single principle; whereas two causes at least contributed to produce them, as the following remarks will clearly show:—

The former profession of Judaism in the country is sufficient to account for the class of observances and notions derivable from the Jewish ritual, which are very numerous, and appear singular, mixed up as they are with a professedly Christian faith. This, however, does not account for Jewish manners and customs, or for the existence of a language so much resembling the Hebrew, and so truly a Semitic dialect as the Gheez, or old Ethiopian. For nations may adopt a foreign religion, and maintain the usages

arising from it, without any marked change of their customs or language. But all which this leaves unsolved may, to our apprehension, be very satisfactorily accounted for by the now generally admitted fact, that at least the people of Tigré, who possessed a Semitic language so nearly resembling the Hebrew, are a Semitic colony, who imported into Abyssinia not only a Semitic language, but Semitic manners, usages, and modes of thought. Whether this may or may not be true of the Amhara also, depends in a great degree upon the conclusion that may be reached respecting the Amharic language, which, through the large admixture of Ethiopic and Arabic words, has a Semitic appearance, but may, notwithstanding, prove to be fundamentally African. At all events, the extent to which the Gheez language has operated upon it would afford a proof of the influence of the Semitic colony upon the native population: which is all that can reasonably be desired to account for the phenomena which have excited so much inquiry and attention.

If it should be objected that it is not sufficient to identify as Semitic the manners and usages which have been described as Hebrew, we would beg to call attention to that passage, in the commencing extract, which, with an unintended significance, intimates that these customs are those of the early times of Gideon and Joshua, when the Hebrews had not been long subject to the peculiar modifying influences of the Mosaical institutions. This is very much the same as to say that the customs and usages in view are in accordance with the general type of Semitic manners, rather than with the particular type which the Mosaical institutions produced; or, in other words, that they resemble the manners of the Hebrews most when those manners had least departed from the general standard of usages which prevailed among the Semitic family of nations. They are, therefore, less Hebrew manners than Semitic manners, and, as such, are accounted for by the presence of Semitic races in the country. In point of fact, travellers who derive their first notions of the East from the Bible, when they come among a strange people, are too ready to set down as *specifically* Hebrew some of the more striking usages which attract their notice; whereas, in fact, they are generically *Oriental*, or at least Semitic, and are Hebrew also merely because the Hebrews were an Oriental people, and had Oriental features, habits, and usages. Our conclusion, then, is, that the former prevalence of the Jewish religion in Abyssinia accounts for the existence of the Jewish ritual usages; and that the presence of one (perhaps more than one) paramount Semitic colony accounts for the existence, in this quarter, of a Semitic language, and Semitic (and therefore Hebrew) manners and usages. We entertain a very strong conviction that this conclusion will be corroborated by all the research into Abyssinian history and antiquities which may hereafter be made.

Having thus considered the question which alone authorized the introduction of this article, we reserve for other articles [CANDACE; ETHIOPIA; SHEBA, QUEEN OF] some questions connected with other points in the history of Abyssinia, especially the introduction of Judaism into that

country. Of the numerous books which have been written respecting Abyssinia, the *Histories* of Tellez and Ludolph, and the *Travels* of Kramp, Bruce, Salt, and Ruppell, are the most important: and an admirable digest of existing information may be found in Ritter's *Erdrkunde*, th. i., and (as far as regards ethnography and languages) in Prichard's *Researches*, vol. ii. ch. vi., and his *Natural History of Man*, sect. 26.

ACCAD (אֲכָד; Sept. 'Αρχάδ), one of the five cities in 'the land of Shinar,' or Babylonia, which are said to have been built by Nimrod, or rather to have been 'the beginning of his kingdom' (Gen. x. 10). Their situation has been much disputed. Ælian (*De Animal.* xvi. 42) mentions that in the district of Sittacene was a river called 'Αρχάδης, which is so near the name 'Αρχάδ which the LXX. give to this city, that Bochart was induced to fix Accad upon that river (*Phælog.* iv. 17). It seems that several of the ancient translators found in their Hebrew MSS. Achar (אָחַר) instead of Accad (אֲכָד) (Ephrem Syrus, Pseudo-Jonathan, *Targum Hieros.*, Jerome, Abulfaragi, &c.); and the ease with which the similar letters א and ח might be interchanged in copying, leaves it doubtful which was the real name. Achar was the ancient name of Nisibis; and hence the Targumists give Nisibis or Nisibim (נִסְבִּימִן) for Accad, and they continued to be identified by the Jewish literati in the times of Jerome. But the Jewish literati have always been deplorable geographers, and their unsupported conclusions are worth very little. Nisibis is unquestionably too remote northward to be associated with Babel, Erech, and Calneh, 'in the land of Shinar.' These towns could not have been very distant from each other; and when to the analogy of names we can add that of situation and of tradition, a strong claim to identity is established. These circumstances unite at a place in the ancient Sittacene, to which Bochart had been led by other analogies. The probability that the original name was *Achar* having been established, the attention is naturally drawn to the remarkable pile of ancient buildings called *Akker-koof*, in Sittacene, and which the Turks know as *Akker-i-Nimrod* and *Akker-i-Babil*. Col. Taylor, the British resident at Baghdad, who has given much attention to the subject, was the first to make out this identification, and to collect evidence in support of it; and to his unpublished communications the writer and other recent travellers are indebted for their statements on the subject. The Babylonian Talmud might be expected to mention the site; and it occurs accordingly under the name of *Aggada*. It occurs also in Maimonides (*Jud. Chaz. Tract. Madec*, fol. 25, as quoted by Hyde), who says, 'Abraham xl. annos natus cognovit creatorem suum'; and immediately adds, 'Extat Aggada tres annos natus.'

Akker-koof is about nine miles west of the Tigris, at the spot where that river makes its nearest approach to the Euphrates. The heap of ruins to which the name of Nimrod's Hill—*Tel-i-Nimrod*, is more especially appropriated, consists of a mound surmounted by a mass of brick-work, which looks like either a tower or an irregular pyramid, according to the point from which it is viewed. It is about 400 feet in circumference at the bottom, and rises to the height of 125 feet above the sloping elevation on which it stands.

The mound, which seems to form the foundation of the pile, is a mass of rubbish accumulated by the decay of the superstructure. In the ruin itself, the layers of sun-dried bricks, of which it is composed, can be traced very distinctly. They are cemented together by lime or bitumen, and are divided into courses varying from 12 to 20 feet in height, and are separated by layers of reeds, as is usual in the more ancient remains of this primitive region. Travellers



have been perplexed to make out the use of this remarkable monument, and various strange conjectures have been hazarded. The embankments of canals and reservoirs, and the remnants of brick-work and pottery occupying the place all around, evince that the Tel stood in an important city; and, as its construction announces it to be a Babylonian relic, the greater probability is that it was one of those pyramidal structures erected upon high places, which were consecrated to the heavenly bodies, and served at once as the temples and the observatories of those remote times. Such buildings were common to all Babylonian towns; and those which remain appear to have been constructed more or less on the model of that in the metropolitan city of Babylon.

ACCARON. [EKRON.]

ACCENT. This term is often used with a very wide meaning: as when we say that a person has 'a Scotch accent,' in which case it denotes all that distinguishes the Scotch from the English pronunciation. We here confine the word, in the first place, to mean those peculiarities of sound for which grammarians have invented the *marks* called accents; and we naturally must have a principal reference to the Hebrew and the Greek languages. Secondly, we exclude the consideration of *such* a use of accentual marks (so called) as prevails in the French language; in which they merely denote a certain change in the quality of a sound attributed to a vowel or diphthong. It is evident that, had a sufficient number of alphabetical vowels been invented, the accents (in such a sense) would have been superseded. While the Hebrew and Greek languages are here our chief end, yet, in order to pass from the known to the unknown, we shall throughout refer to our own tongue as the best source of illustration. In this respect, we undoubtedly overstep the proper limits of a Biblical Cyclopædia; but we are in a manner constrained so to do, since the whole subject is misrepresented or very defectively ex-

plained in most English grammars: and if we abstained from this full exposition, many readers would most probably, after all, misunderstand our meaning.

Even after the word accent has been thus limited, there is an ambiguity in the term; it has still a double sense, according to which we name it either oratorical or vocabular. By the latter, we mean the accent which a word in isolation receives; for instance, if we read in a vocabulary: while by oratorical accent we understand that which words actually have when read aloud or spoken as parts of a sentence.

The Greek men of letters, who, after the Macedonian kingdoms had taken their final form, invented accentual marks to assist foreigners in learning their language, have (with a single uniform exception) been satisfied to indicate the vocabular accent: but the Hebrew grammarians aimed, when the pronunciation of the old tongue was in danger of being forgotten, at indicating by marks the traditional inflections of the voice with which the Scriptures were to be read aloud in the synagogues. In consequence, they have introduced a very complicated system of accentuation to direct the reader. Some of their accents (so called) are, in fact, *stops*, others syntactical notes, which served also as guides to the voice in chanting.

In intelligent reading or speaking, the vocal organs execute numerous intonations which we have no method of representing on paper; especially such as are called *inflections* or *slides* by teachers of elocution: but on these a book might be written; and we can here only say, that the Masoretic accentuation of the Hebrew appears to have struggled to depict the *rhythm* of sentences; and the more progress has been made towards a living perception of the language, the higher is the testimony borne by the learned to the success which this rather cumbersome system has attained. The rhythm, indeed, was probably a sort of chant; since to this day the Scriptures are so recited by the Jews, as also the Koran by the Arabs or Turks: nay, in Turkish, the same verb (*oğumag*) signifies to sing and to read. But this chant by no means attains the sharp *discontinuity* of European singing: on the contrary, the voice *slides* from note to note. Monotonous as the whole sounds, a deeper study of the expression intended might probably lead to a fuller understanding of the Masoretic accents.

Wherein the Accent consists.—In ordinary European words, one syllable is pronounced with a peculiar stress of the voice; and is then said to be accented. In our own language, the most obvious accompaniment of this stress on the syllable is a greater clearness of sound in the vowel; insomuch that a *very* short vowel cannot take the primary accent in English. Nevertheless, it is very far from the truth, that accented vowels and syllables are necessarily long, or longer than the unaccented in the same word; of which we shall speak afterwards. In illustration, however, of the loss of clearness in a vowel, occasioned by a loss of accent, we may compare a *cóntest* with *contést*; *équal* with *equality*; in which the syllables *con*, *qual*, are sounded with a very obscure vowel when unaccented.

Let us observe, in passing, that when a vowel sound changes through transposition of the ac-

cent, the Hebrew grammarians—instead of trusting that the voice will of itself modify the vowel when the accent is shifted—generally think it necessary to depict the vowel differently: which is one principal cause of the complicated changes of the vowel points.

A second concomitant of the accent is less marked in English than in Italian or Greek; namely—a musical elevation of the voice. On a piano or violin we of course separate entirely the *stress* given to a note (which is called forte and staccato) from its elevation (which may be Δ , or C , or V); yet in speech it is natural to execute in a higher tone, or, as we improperly term it, in a higher *key*, a syllable on which we desire to lay stress: possibly because sharp sounds are more distinctly heard than flat ones. Practically, therefore, accent embraces a slide of the voice into a higher note, as well as an emphasis on the vowel; and in Greek and Latin it would appear that this slide upwards was the most marked peculiarity of accent, and was that which gained it the names *προσῳδία*, *accentus*. Even at the present day, if we listen to the speech of a Greek or Italian, we shall observe a marked elevation in the slides of the voice, giving the appearance of great vivacity, even where no peculiar sentiment is intended. Thus, if a Greek be requested to pronounce the words *σοφία* (wisdom), *παραβολή* (parable), his voice will rise on the *i* and *η* in a manner never heard from an Englishman. In ancient Greek, however, yet greater nicety existed; for the voice had *three kinds* of accent, or slides, which the grammarians called flat, sharp, and circumflex; as in *τις*, *τίς*; *πῶν*. It is at the same time to be remarked, that this flat accent was solely oratorical; for when a word was read in a vocabulary, or named in isolation, or indeed at the end of a sentence, it never took the flat accent, even on the last syllable; except, it would seem, the word *τις*, a certain one. In the middle of a sentence, however, the simple accent (for we are not speaking of the circumflex) on a penultima or antepenultima was always sharp, and on a last syllable was flat. Possibly a stricter attention to the speech of the best educated modern Greeks, or, on the contrary, to that of their peasants in isolated districts, might detect a similar peculiarity: but it is generally believed that it has been lost, and some uncertainty therefore naturally rests on the true pronunciation. On the whole, it is most probable that the flat accent was a stress of the voice uttered in a lower note, much as the second accent in *grandfather*; that the sharp accent was that which prevails in modern Greek, and has been above described; and that the circumflex combined an upward and a downward slide on the same vowel. The last was naturally incapable of being executed, unless the vowel was long; but the other two accents could exist equally well on a short vowel.

In English elocution various slides are to be heard, more complicated than the Greek circumflex; but with us they are wholly oratorical, never vocubular. Moreover, they are peculiar to vehement or vivacious oratory; being abundant in familiar or comic speech, and admissible also in high pathetic or indignant declamation: but they are almost entirely excluded from tranquil and serious utterance.

Secondary Accent.—On the same word, when it consists of many syllables, a double accent is frequently heard, certainly in English, and probably in most languages; but in our own tongue one of the two is generally feebler than the other, and may be called secondary. If we agree to denote this by the flat accent (\flat) of the Greeks, we may indicate as follows our double accent:

consideration, disobedience, unprefending;
secondary, accessory, preëmporarily.

We have purposely selected as the three last examples cases in which the secondary accent falls on a very short or obscure vowel, such as *can* never sustain the primary accent.

In some cases, *two syllables* intervene between the accents, and it may then be difficult to say which accent is the principal. In *aristocrat*, *equalize*, *antedote*, the first syllable has a stronger accent than the last; but in *aristocratic*, *equalization*, *antediluvian*, they seem to be as equal as possible, though the latter catches the ear more. In *aristocracy*, the former is beyond a doubt secondary; but here the two are separated by only one syllable. *Prëdetermination* has three accents, of which the middlemost is secondary.

In the Greek language a double accent is sometimes found on one word; but only when the latter is superinduced by some short and subordinate word which hangs upon the other. Such short words are called *enclitics*, and form a class by themselves in the language, as they cannot be known by their meaning or form. By way of example we may give, *τίσωνός τις* (a certain usurper), *οἶδά σε* (I know thee). In these cases, we observe that the two accents, if both are sharp, are found on alternate syllables, as in English; but whether one of them was secondary we do not know. If the former is a circumflex, the latter is on the following syllable. Occasionally, two or more enclitics follow each other in succession, and produce a curious combination; as, *εἰράς τοῦ τί μοι*. These accents, however, are not vocubular, but oratorical.

The Hebrews have, in many cases, secondary accents, called a *foretone*, because with them it always precedes the principal accent (or 'tone'), as, כֹּתֵב , *katebû*; the intermediate and unaccented vowel being in such cases exceedingly short and obscure, so that some grammarians refuse to count it at all. This foretone is described as a stress of the voice uttered in a lower note, and therefore may seem identical in sound with the flat accent of the Greeks. It differs, however, in being always accompanied with the sharp accent on the same word, and in being vocubular, not merely oratorical.

On the Place of the Accent.—A great difference exists between different languages as to the place of the accent. In Hebrew it is found solely on the last syllable and last but one, and is assumed systematically by many grammatical terminations, as in *Mélek* (for *Málk*), a king, pl. *Mel'ák'im*. This is so entirely opposed to the analogies of English, that it has been alleged (Latham *On the English Language*) that *Princess* is the only word in which our accent falls on a final inflection. The radical contrast of all this to our own idiom leads to a perverse pronunciation of most Hebrew names: thus we say *Isáiah*, *Nehemíah*, *Cánaan*, *Ísraël*—although with their true

accent they are Isaiáh, Nehemyáh, Caná-an, Isra-él; to say nothing of other peculiarities of the native sound. In Greek, the accent is found on any of the three last syllables of a word; the circumflex only on the two last. In the Latin language, it is very remarkable that (except in the case of monosyllables) the accent never fell on the last syllable, but was strictly confined to the penultima and antepenultima. This peculiarity struck the Greek ear, it is said, more than anything else in the sound of Latin, as it gave to it a pompous air. It is the more difficult to believe that any thoughtful Greek seriously imputed it to Roman pride, since we are told that the Æolic dialect of Greek itself agreed in this respect with the Latin (See Foster *On Accent and Quantity*, ch. iv.). The Latin accentuation is remarkable for having the place of the accent dictated solely by euphony, without reference to the formation or meaning of the word; in which respect the Greek only partly agrees with it, chiefly when the accent falls on the penultima or antepenultima. The Latin accent, however, is guided by the quantity of the penultimate syllable; the Greek accent by the quantity of the ultimate vowel. The rules are these:—

1. Greek: 'When the last vowel is long, the accent is on the penultima; when the last vowel is short, the accent is on the antepenultima.' *Oxytons* are herein excepted. 2. Latin: 'When the penultimate syllable is long, the accent is upon it; when short, the accent is on the antepenultima. Every dissyllable is accented on the penultima.' Accordingly, the Greek accent, even on the cases of the very same noun, shifted in the following curious fashion: N. ἄνθρωπος, G. ἀνθρώπου, D. ἀνθρώπου, Ac. ἄνθρωπον; and in Latin, rather differently, yet with an equal change, N. *Sermo*, G. *Sermonis*, &c. It is beyond all question that the above rule in Greek is genuine and correct (though it does not apply to *oxytons*, that is, to words accented on the last syllable, and has other exceptions which the Greek grammars will tell); but there is a natural difficulty among Englishmen to believe it, since we have been taught to pronounce Greek with the accentuation of Latin; a curious and hurtful corruption, to which the influence of Erasmus is said to have principally contributed. It deserves to be noted that the modern Greeks, in pronouncing their ancient words, retain, with much accuracy on the whole, the ancient rules of accent; but in words of recent invention or introduction they follow the rule, which seems natural to an Englishman, of keeping the accent on the same syllable through all cases of a noun. Thus, although they sound as of old, N. ἄνθρωπος, G. ἀνθρώπου, yet in the word κοκόνη, a lady, which is quite recent, we find (plural), N. αἱ κοκόνες, G. τῶν κοκόνων, &c. Similarly, δ καπιτάνος, the captain, G. τοῦ καπιτάνου, &c. This is only one out of many marks that the modern Greek has lost the nice appreciation of the quantity or time of vowel sounds, which characterized the ancient.

In all Latin or Greek words which we import into English, so long as we feel them to be foreign, we adhere to the Latin rules of accentuation as well as we know how: thus, in *démocrat*, *démocrácy*, *démocrátical*; *philósophy*, *philosóphical*; *astrónomy*, *astronómical*; *domestic*, *do-*

mesticity, *domésticdation*; *possible*, *possibility*; *bárbarous*, *barbárity*. But the moment we treat any of these words as natives, we follow our own rule of keeping the accent on the radical syllable; as in *bárbarousness*, where the Saxon ending, *ness*, is attached to the foreign word. With the growth of the language, we become more and more accustomed to hear a long train of syllables following the accent. Thus, we have *cómfort*, *cómfortable*, *cómfortábleness*; *párliament*, *párliamentary*, which used to be *párliaméntary*.

In many provinces of England, and in particular families, the older and better pronunciations, *contráry*, *indústry*, keep their place, instead of the modern *contráry*, *indústry*. The new tendency has innovated in Latin words so far, that many persons say *inimical*, *cóntemplete*, *incúcate*, *décorous*, *sónorous*, and even *cóncordance*, for *inimical*, *contémpate*, &c. 'Alexándér' has supplanted 'Alexánder'. In the cases of *cón cordance*, *clámorous*, and various others, it is probable that the words have been made to follow the pronunciation of *cóncord*, *clámor*, as in native English derivatives. The principle of change, to which we have been pointing, is probably deep-seated in human speech; for the later Attics are stated to have made a similar innovation in various words; for example, Æschylus and Thucydides said *δμοίος*, *τροπαίον*, but Plato and Aristotle, *δμοιος*, *τρόπαιον*.

If the principal accent is very distant from one end of a long word, a great obscurity in the distant vowel-sounds results, which renders a word highly unmusical, and quite unmanageable to poetry. This will be seen in such pronunciations as *párliamentary*, *péremptorily*.

In Hebrew the same phenomenon is exhibited in a contrary way, the early vowels of a word being apt to become extremely short, in consequence of the accent being delayed to the end.

Thus, לָהֶן , *shé'el*, a tent, pl. שָׁלְמִים , *shál'm*; קָטְלוּ , *qátelú*, they killed; קָטְלוּהוּ , *qátalíhu*, they killed him. Oratorical reasons occasionally induce a sacrifice of the legitimate vocabulary accent. In English this happens chiefly in cases of antithesis; as when the verbs, which would ordinarily be sounded *incréase* and *decréase*, reverse their accent in order to bring out more clearly the contrasted syllables: 'He must *incréase*, but I must *décreease*.'

This change is intended, not for mere euphony, but to assist the meaning. Variety and energy seem to be aimed at in the following Hebrew example, which Ewald has noticed, and which seems to indicate that more of the same sort must remain to be discovered: *Judges* v. 12, 'Uri, 'urí, *Deborá*: 'urí, 'urí, *dabbirí shír*; which, after Ewald, we may imitate by translating thus, 'Up thén, up thén, *Deboráh*: úp thén, úp thén, utter a sòng.' The Greek and Hebrew languages, moreover, in the *pause* of a sentence, modified the accent without reference to the meaning of the words. Thus the verb ordinarily sounded גָּדְלוּ , *gád'elú*, with a very short penultimate vowel, becomes at the end of the sentence גָּדְלוּ , *gád'elú*, with a long and accented penultima (See Ewald's *Hebrew Gram.* § 131, 133). The Greek lan-

guage also at the end of a sentence changes a flat accent into a sharp one; for instance, the word τιμή (honor) before a pause becomes τιμή; but no elongation of vowels ever accompanies this phenomenon.

Accent in Compound Words.—It is principally by the accent that the syllables of a word are joined into a single whole; and on this account a language with well-defined accentuation is (*cæteris paribus*) so much the easier to be understood when heard, as well as so much the more musical. This function of the accent is distinctly perceived by us in such words of our language as have no other organized union of their parts. To the eye of a foreigner reading an English book, *steam-boat* appears like two words; especially as our printers have an extreme dislike of hyphens, and omit them whenever the corrector of the press will allow it. In Greek or Persian two such words would be united into one by a *vowel of union*, which is certainly highly conducive to euphony, and the compound would appear in the form *steamboat* or *steamobotos*. As we are quite destitute of such apparatus (in spite of a few such exceptions as *handicraft*, *mountebank*), the accent is eminently important; by which it is heard at once that *steamboat* is a single word. In fact, we thus distinguish between a *stónebox* and a *stóne bóx*; the former meaning a box for holding stones, the latter a box made of stone. Mr. Latham (*Engl. Language*, § 231) has ingeniously remarked that we may read the following lines from Ben Jonson in two ways:

‘An’d thy silvershining quiver’—
or, ‘An’d thy silver shining quiver’—

with a slight difference of sense.

The Hebrew language is generally regarded as quite destitute of compound words. It possesses, nevertheless, something at least closely akin to them in (what are called) *nouns in regimen*. Being without a genitive case, or any particle devoted to the same purpose as the English preposition *of*, they make up for this by sounding two words as if in combination. The former word loses its accent, and thereby often incurs a shortening and obscuration of its vowels; the voice hurrying on to the latter. This may be illustrated by the English pronunciation of *ship of war*, *man of war*, *man at arms*, phrases which, by repetition, have in spirit become single words, the first accent being lost. Many such exist in our language, though unregistered by grammarians—in fact, even in longer phrases the phenomenon is observable. Thus, *Secretary at War*, *Court of Queen’s Bench*, have very audibly but one predominating accent, on the last syllable.

So, in Hebrew, from חִזְיוֹן, *chizzayon*, a vision, comes חִזְיוֹן חִזְיוֹן, *cheyyon-lailá*, vision of the night (Job xx. 8). That every such case is fairly to be regarded as a compound noun was remarked by Dr. Campbell of Aberdeen, who urged that otherwise, in Isaiah ii. 20, we ought to render the words ‘the idols of his silver;’ whereas, in fact, the exact representation of the Hebrew in Greek is not εἰδωλα ἀργύρου-αὐτοῦ, but, so to say, ἀργυρεῖδωλα αὐτοῦ. In Greek compounds the position of the accent is sometimes a very critical matter in distinguishing active and passive

meanings of epithets. Thus, *μητρόκτορος* means *mother-slain*, or slain by one’s mother; while *μητροκτόνος* is *mother-slaying*, or slaying one’s mother. Such distinctions, however, seem to have been confined to a very small class of compounds.

Sense of a simple word modified by the Accent.—It is familiarly remarked in our English grammars, that (in words of Latin origin, generally imported from French) we often distinguish a verb from a noun by putting the accent on the penultimate syllable of the noun and the ultimate of the verb. Thus, we say, an *insult*, *tr insult*; a *contest*, *to contest*; &c., &c. The distinction is so useful, that in doubtful cases it appears desirable to abide by the rule, and to say (as many persons do say) a *perfume*, *to perfume*; *détails*, *to detail*; *the contents of a book*, *to content*; &c. It is certainly curious that the very same law of accent pervades the Hebrew language, as discriminating the simplest trilateral noun and verb. Thus, we have מֶלֶךְ, *mélék*, king; מָלַךְ, *málák*, he ruled. In the Greek language the number of nouns is very considerable in which the throwing of the accent on the last syllable seriously alters the sense; as, *τρόπος*, a manner; *τροπὸς*, the leather of an oar: *θυαὸς*, anger or mind; *θύμος*, garlic: *κρίνον*, judging; *κρινών*, a lily-bed: *ἄμος*, a shoulder; *ὤμος*, cruel. A very extensive vocabulary of such cases is appended to Scapula’s *Greek Lexicon*.

Relation of Accent to Rhythm and Metre.—Every sentence is necessarily both easier to the voice and pleasanter to the ear when the whole is broken up into symmetrical parts, with convenient pauses between them. The measure of the parts is marked out by the number of principal beats of the voice (or oratorical accents) which each clause contains; and when these are so regulated as to attain a certain musical uniformity without betraying art, the sentence has the pleasing *rhythm* of good prose. When art is not avowed, and yet is manifest, this is displeasing, as seeming to proceed from affectation and insincerity. When, however, the art is avowed, we call it no longer rhythm, but *metre*; and with the cultivation of poetry, more and more melody has been exacted of versifiers.

To the English ear, three and four beats of the voice give undoubtedly the most convenient length of clauses. Hence, in what is called *poetical prose*, it will be found that any particularly melodious passage, if broken up into lines or verses, yields generally either three or four beats in every verse. For example:

‘Where is the máid of Ar’van ?

Góne, as a vision of the night.

Where shall her lóver loók for her ?

The háll, which ónce she gláddened, is désolate.’

But no poetical prose, not even translations of poetry which aim at a half-metrical air, will be found to retain constantly the *threefold* and *fourfold* accent. To produce abruptness, *half* lines, containing but two accents, are thrown in; and in smoother feeling clauses of five accents, which often tend to become the true English blank verse. All *longer* clauses are composite, and can be resolved into three and three, four and three, four and four, &c. To illustrate this, let us take

a passage of the *Old Testament* in the common English translation. Habakkuk iii. 2:

Yh, Lórd!
I have heard thy speéch; and was afraid.
O'h Lórd!
Revíve thy wórk in the mídst of the yeárs!
In the mídst of the yeárs make kñown!
In wráth reméber mércy!
Gód cáme from Téman,
And the Hóly One from Móunt Páran.
His glóry cówéred the héavens,
And the éarþh was fíll of his práise.
His bríghtness was ás the líght,
He had hórn coming óút of his hánd,
And thér was the híding of his pówer.' &c. &c.

The accent which we have been here describing as the source of rhythm is strictly the *oratorical* accent. As this falls only on the more emphatic words of the sentence, it is decidedly strong, and, in comparison with it, all the feebler and secondary accents are unheard, or at least uncounted. Nor is any care taken that the successive accents should be at equable distances. Occasionally they occur on successive syllables; much oftener at the distance of two, three, or four syllables. Nevertheless, this poetical rhythm, as soon as it becomes avowedly cultivated, is embryo-metre; and possibly this is the real state of the Hebrew versification. Great pains have been taken, from Gomarus in 1630 to Bellemann and Saalschutz in recent times, to define the laws of Hebrew metre. A concise history of these attempts will be found in the Introduction to De Wette's *Commentary on the Psalms*. But although the occasional use of *rhyme* or *assonance* in Hebrew seems to be more than accidental, the failure of so many efforts to detect any real metre in the old Hebrew is decisive enough to warn future inquirers against losing their labour. (See the article *Parallelismus* in Ersch and Gruber's *Encyclopedie*). The modern Jews, indeed, have borrowed accentual metre from the Arabs: but, although there is nothing in the genius of the tongue to resist it, perhaps the fervid, practical genius of the Hebrew prophets rejected any such trammel. Repetition and amplification mark their style as too declamatory to be what we call poetry. Nevertheless, in the Psalms and lyrical passages, increasing investigation appears to prove that considerable artifice of composition has often been used (See Ewald's *Poetical Books of the Old Test.* vol. i.).

In our own language, it is obvious to every considerate reader of poetry that the metres called anapestic depend far more on the oratorical accent than on the vocabular (which is, indeed, their essential defect); and on this account numerous accents, which the voice really utters, are passed by as counting for nothing in the metre. We offer, as a single example, the two following lines of Campbell, in which we have denoted by the flat accent those syllables the stress upon which is subordinate and *extra metrum*:

'Sáy, rúsh'd the bóld eaglé exúltíngly fórth
From his hóme, in the dárk-róllíng clóuds of
the nórth.'

Such considerations, drawn entirely out of *oratory*, appear to be the only ones on which it is any longer useful to pursue an inquiry concerning Hebrew metres.

Confusion of Accent with Quantity.—It is a striking fact that Foster, the author of a learned and rather celebrated book intended to clear up this confusion, succeeded in establishing the truth concerning Greek and Latin, by help of ancient grammarians, but himself fell into the popular errors whenever he tried to deal with the English language. Not only does he allege that 'the voice dwells longer' on the first syllable of *honestly*, *character*, &c., than on the two last (and improperly writes them *honestly*, *cháracter*), but he makes a general statement that accent and quantity, though separated in Greek and Latin, are inseparable in English. The truth is so far otherwise, that probably in three words out of four we separate them. As single instances, consider the words *honestly*, *character*, just adduced. The accent is clearly on the first syllable; but that syllable in each is very short. On the other hand, the second syllable of both, though unaccented, yet by reason of the consonants *s t l*, *c t*, is long, though less so than if its vowel likewise had been long. The words are thus, like the Greek *κύλινδρος*, a *cylinder*, accented on the first syllable, yet as to quantity an amphibrach ($\circ - \circ$). Until an Englishman clearly feels and knows these facts of his own tongue, he will be unable to avoid the most perplexing errors on this whole subject.

Invention of Accents.—We have already said that the accentual marks of the Greeks were invented not long after the Macedonian conquests. To Aristophanes of Byzantium, master of the celebrated Aristarchus, is ascribed the credit of fixing both the punctuation and the accentuation of Greek. He was born near the middle of the second century B.C.; and there seems to be no doubt that we actually have before our eyes a pronunciation which cannot have greatly differed from that of Plato. As for the Hebrew accentuation generally called *Masoretic*, the learned are agreed that it was a system only gradually built up by successive additions; the word *Masora* itself meaning *tradition*. The work is ascribed to the schools of Tiberias and Babylon, which arose after the destruction of Jerusalem by the Romans; but it cannot be very accurately stated in how many centuries the system of vowel-points and accentuation attained the fully-developed state in which we have received it. There is, however, no question among the ablest scholars that these marks represent the utterance of a genuine Hebrew period; the pronunciation, it may be said with little exaggeration, of Ezra and Nehemiah.—F. W. N.

ACCHABIS. [SPIDER.]

ACCHO (אֲכֹ; Sept. *Ακχω), a town and haven within the nominal territory of the tribe of Asher, which however never acquired possession of it (Judg. i. 31). The Greek and Roman writers call it *Ακη. ACE (Strab. xvi. 877; Diod. Sic. xix. 93; C. Nep. xiv. 5); but it was eventually better known as PTOLEMAIS (Plin. *Hist. Nat.* v. 19), which name it received from the first Ptolemy, king of Egypt, by whom it was much improved. By this name it is mentioned in the Apocrypha (1 Macc. x. 56; xi. 22, 24; xii. 43, 48; 2 Macc. xiii. 14), in the New Testament (Acts xxi. 7), and by Josephus (*Antiq.* xiii. 12, 2, *seq.*). It was also called *Colonia Claudii*

Cæsaris, in consequence of its receiving the privileges of a Roman city from the emperor Claudius (Plin. v. 17; xxxvi. 65). But the names thus imposed or altered by foreigners never took with the natives, and the place is still known in the country by the name of **ك** *AKKA*.

It continued to be called Ptolemais by the Greeks of the lower empire, as well as by Latin authors, while the Orientals adhered to the original designation. This has occasioned some speculation. Vitruvius, who was bishop of the place, produces the opinion (*Hist. Orient.* c. 25) that the town was founded by twin-brothers, Ptolemæus and Acon. Vinisauf imagines that the old town retained the name of Accho, while that of Ptolemais was confined to the more modern additions northward, towards the hill of Turon (G. Vinisauf, i. 2, p. 248), but the truth undoubtedly is that the natives never adopted the foreign names of this or any other town. The word Accho, or Akka, can be traced to no Hebrew or Syriac root, and is, Sir W. Drummond alleges (*Origines*, b. v. c. 3), clearly of Arabian origin, and derived from **ك** *ak*, which signifies sultry.

The neighbourhood was famous for the sands which the Sidonians employed in making glass (Plin. *Hist. Nat.* v. 19; Strabo, xvi. 877); and the Arabians denote a sandy shore heated by the sun by the word **ك** *okch*, or **ك** *aket*, or (with the nunation) *aketon*. During the Crusades the place was usually known to Europeans by the name of **ACON**: afterwards, from the occupation of the Knights of St. John of Jerusalem, as **St. JEAN D'ACRE**, or simply **ACRE**.

This famous city and haven is situated in N. lat. 32° 55', and E. long. 35° 5', and occupies the north-western point of a commodious bay, called the Bay of Acre, the opposite or south-western point of which is formed by the promontory of Mount Carmel. The city lies on the plain to which it gives its name. Its western side is washed by the waves of the Mediterranean, and on the south lies the bay, beyond which may be seen the town of Caïpha, on the site of the ancient Calamos, and, rising high above both, the shrubby heights of Carmel. The mountains belonging to the chain of Anti-Libanus are seen at the distance of about four leagues to the north, while to the east the view is bounded by the fruitful hills of the Lower Galilee. The bay, from the town of Acre to the promontory of Mount Carmel, is three leagues wide and two in depth. The port, on account of its shallowness, can only be entered by vessels of small burden; but there is excellent anchorage on the other side of the bay, before Caïpha, which is, in fact, the roadstead of Acre (Turner, ii. 111; G. Robinson, i. 198). In the time of Strabo Accho was a great city (*Πτολεμαΐς ἔστι μεγάλη πόλις ἢν Ἀκκην ἀνόμαζον πρότερον*, xvi. p. 877), and it has continued to be a place of importance down to the present time. But after the Turks gained possession of it, Acre so rapidly declined, that the travellers of the sixteenth and seventeenth centuries concur in describing it as much fallen from its former glory, of which, however, traces still remained. The missionary Eugene Roger (*La Terre Sainte*, 1645, pp. 44-46), remarks that the whole place had such a sacked

and desolated appearance, that little remained worthy of note except the palace of the grand-master of the Knights Hospitallers, and the church of St. Andrew: all the rest was a sad and deplorable ruin, pervaded by a pestiferous air which soon threw strangers into dangerous maladies. The Emir Fakr-ed-din had, however, lately built a commodious khan for the use of the merchants: for there was still considerable traffic, and vessels were constantly arriving from France, Venice, England, and Holland, laden with oil, cotton, skins, and other goods. The Emir had also built a strong castle, notwithstanding repeated orders from the Porte to desist. Roger also fails not to mention the immense stone balls, above a hundredweight, which were found in the ditches and among the ruins, and which were thrown into the town from machines before the use of cannon. This account is confirmed by other travellers, who add little or nothing to it (Doubdan, Cotovicus, Zuallart, Morison, Nau, D'Arvieux, and others). Morison, however, dwells more on the ancient remains, which consisted of portions of old walls of extraordinary height and thickness, and of fragments of buildings, sacred and secular, which still afforded manifest tokens of the original magnificence of the place. He (ii. 8) affirms that the metropolitan church of St. Andrew was equal to the finest of those he had seen in France and Italy, and that the church of St. John was of the same perfect beauty, as might be seen by the pillars and vaulted roof, half of which still remained. An excellent and satisfactory account of the place is given by Nau (liv. v. ch. 19), who takes particular notice of the old and strong vaults on which the houses are built; and the present writer, having observed the same practice in Baghdad, has no doubt that Nau is right in the conjecture that they were designed to afford cool underground retreats to the inhabitants during the heat of the day in summer, when the climate of the plain is intensely hot. This provision might not be necessary in the interior and cooler parts of the country. Our Maundrell gives no further information, save that he mentions that the town appears to have been encompassed on the land side by a double wall, defended with towers at small distances; and that without the walls were ditches, ramparts, and a kind of bastions faced with hewn stone (*Journey*, p. 72). Pococke speaks chiefly of the ruins. After the impulse given to the prosperity of the place by the measures of Sheikh Daher, and afterwards of Djezzar Pasha, the descriptions differ. Much of the old ruins had disappeared from the natural progress of decay, and from their materials having been taken for new works. It is, however, mentioned by Buckingham, that, in sinking the ditch in front of the then (1816) new outer wall, the foundations of small buildings were exposed, twenty feet below the present level of the soil, which must have belonged to the earliest ages, and probably formed part of the original *Accho*. He also thought that traces of *Ptolemais* might be detected in the shafts of grey and red granite and marble pillars, which lie about or have been converted into thresholds for large doorways, of the Saracenic period; some partial remains might be traced in the inner walls; and he is disposed to refer to that time the now old khan, which, as stated above, was really built by the Emir Fakr-

el-din. All the Christian ruins mentioned by the travellers already quoted had disappeared. In actual importance, however, the town had much increased. The population in 1819 was computed at 10,000, of whom 3000 were Turks, the rest Christians of various denominations (Connor, in Jowett, i. 423). Approached from Tyre the city presented a beautiful appearance, from the trees in the inside, which rise above the wall, and from the ground immediately around it on the outside being planted with orange, lemon, and palm trees. Inside, the streets had the usual narrowness and filth of Turkish towns; the houses solidly built with stone, with flat roofs; the bazaars mean, but tolerably well supplied (Turner, ii. 113). The principal objects were the mosque, the pasha's seraglio, the granary, and the arsenal (Irby and Mangles, p. 195). Of the mosque, which was built by Djezzar Pasha, there is a description by Pliny Fisk (*Life*, p. 337; also G. Robinson, i. 200). The trade was not considerable; the exports consisted chiefly of grain and cotton, the produce of the neighbouring plain; and the imports chiefly of rice, coffee, and sugar from Damietta (Turner, ii. 112). As thus described, the city was all but demolished in 1832 by the hands of Ibrahim Pasha; and although considerable pains were taken to restore it, yet, as lately as 1837, it still exhibited a most wretched appearance, with ruined houses and broken arches in every direction (Lord Lindsay, *Letters*, ii. 81).

As the fame of Acre is rather modern than biblical, its history must in this place be briefly told. It belonged to the Phœnicians, until they, in common with the Jews, were subjugated by the Babylonians. By the latter it was doubtless maintained as a military station against Egypt, as it was afterwards by the Persians (Strabo, xvi. p. 877). In the distribution of Alexander's dominions Accho fell to the lot of Ptolemy Soter, who valued the acquisition, and gave it his own name. Afterwards it fell into the hands of the kings of Syria; and is repeatedly mentioned in the wars of the Maccabees. It was at one time the head-quarters of their heathen enemies (1 Macc. v. 15, 22, 55). In the endeavour of Demetrius Soter and Alexander Balas to bid highest for the support of Jonathan, the latter gave Ptolemais and the lands around to the temple at Jerusalem (x. 1, 39). Jonathan was afterwards invited to meet Alexander and the king of Egypt at that place, and was treated with great distinction by them (x. 56-66); but there he at length (b.c. 144) met his death through the treachery of Tryphon (xii. 48-50). Alexander Jannæus took advantage of the civil war between Antiochus Philometer and Antiochus Cyzicenus to besiege Ptolemais, as the only maritime city in those parts, except Gaza, which he had not subdued; but the siege was raised by Ptolemy Lathyrus (then king of Cyprus), who got possession of the city (Joseph. *Antiq.* xiii. 12, 2-6), of which he was soon deprived by his mother Cleopatra (xiii. 13, 2). She probably gave it, along with her daughter Selene, to Antiochus Grypus, king of Syria. At least, after his death, Selene held possession of that and some other Phœnician towns, after Tigranes, king of Armenia, had acquired the rest of the kingdom (xiii. 16, 4). But an injudicious attempt to extend her dominions drew upon her the vengeance of

that conqueror, who, in b.c. 70, reduced Ptolemais, and, while thus employed, received with favour the Jewish embassy which was sent by Queen Alexandra, with valuable presents, to seek his friendship (xiii. 16, 4). A few years after, Ptolemais was absorbed, with all the country, into the Roman empire; and the rest of its ancient history is obscure and of little note. It is only mentioned in the New Testament from St. Paul having spent a day there on his voyage to Casarea (Acts xxi. 7). The importance acquired by the last-named city through the mole constructed by Herod, and the safe harbour thus formed, must have had some effect on the prosperity of Ptolemais; but it continued a place of importance, and was the seat of a bishopric in the first ages of the Christian Church. The see was filled sometimes by orthodox and sometimes by Arian bishops; and it has the equivocal distinction of having been the birth-place of the Sabellian heresy (Niceph. vi. 7). Accho, as we may now again call it, was an imperial garrison town when the Saracens invaded Syria, and was one of those that held out until Casarea was taken by Amru, in a.d. 638 (*Mod. Univ. Hist.* i. 473).

The Franks first became masters of it in a.d. 1110, when it was taken by Baldwin, king of Jerusalem. But in a.d. 1187 it was recovered by Salah-ed-din, who retained it till a.d. 1191, when it was retaken by the Christians. This was the famous siege in which Richard Cœur-de-Lion made so distinguished a figure. The Christians kept it exactly one hundred years, or till a.d. 1291; and it was the very last place of which they were dispossessed. It had been assigned to the Knights Hospitallers of Jerusalem, who fortified it strongly, and defended it valiantly, till it was at length wrested from them by Khalil ben Kelaoum, Sultan of Egypt, who is called Melek Seruf by Christian writers (D'Herbelot, in 'Accha,' Will. Tyr. l. xxxiii. c. 6, 7; Vitriacus, capp. 25, 99, 100; Quaresmius, tom. ii. p. 897). Under this dominion it remained till a.d. 1517, when the Mamluke dynasty was overthrown by Selim I., and all its territories passed to the Turks (*Chronica de Syria*, lib. v. cap. 1; *Mod. Univ. Hist.* b. xv. c. 10, § 2). After this Acre remained in quiet obscurity till the middle of the last century, when the Arab Sheikh Daher took it by surprise. Under him the place recovered some of its trade and importance. He was succeeded by the barbarous but able tyrant Djezzar Pasha, who strengthened the fortifications and improved the town. Under him it rose once more into fame, through the gallant and successful resistance which, under the direction of Sir Sidney Smith, it offered to the arms of Buonaparte. After that the fortifications were further strengthened, till it became the strongest place in all Syria. In 1832 the town was besieged for nearly six months by Ibrahim Pasha, during which 35,000 shells were thrown into it, and the buildings were literally beaten to pieces (Hogg's *Damascus*, pp. 160-166). It had by no means recovered from this calamity, when it was subjected to the operations of the English fleet under Admiral Stopford, in pursuance of the plan for restoring Syria to the Porte. On the 3rd of November, 1840, it was bombarded for several hours, when the explosion of the powder-magazine destroyed the garrison and laid the town in ruins (Nanier's *War in Syria*).

ACCOMMODATION, as used by theological writers, has been defined to be the application of one thing to another by analogy. This definition, however, is far from being complete, as the term, at least in modern times, has been used in various senses.

It has been applied to the *form* of instruction in which it has pleased the Almighty to communicate his will to mankind. Thus the sensible images and anthropomorphic expressions which were used for the conveyance of divine truths, especially in the infancy of mankind, are frequently denominated *accommodation*. To express this sense the term *divine condescension* has been also employed. It is meant thereby that God, in order to lead mankind to a knowledge of religion and morality, humbled himself to the weakness, the prevailing ignorance, modes of thought, and spiritual wants of men, and communicated truths under various images [ANTHROPOMORPHISM]. When it is considered that the first oracles of our holy religion are the earliest monuments of human thought extant, and preserve the memorials of the infancy of society, and that, in order to attain their end—that of communicating instruction—they must be accommodated in their form to the prevalent modes of thought and language, we may readily perceive the reasons for the employment of figurative expressions and typical symbols. (See Archbishop Whately's *Bampton Lectures*; also, *Lectures on Theology*, by the Rev. W. D. Conybeare, Lond. 1836). This is called *divine condescension*, in order to distinguish it from *human*, which consists in a teacher's adapting himself to the modes of thought and imperfections of men, with the design of leading them to fresh knowledge and better views. This is considered to be a necessary condescension to the weakness of the ignorant and uncivilized. Few, it is maintained, would have received wholesome truths if the teacher had not regulated himself according to this system, at least, in matters of *subordinate* import, so far as this could be done without prejudice to the truth. The person who employs this method is said to speak *κατ' οἰκονομίαν*, or economically (See Seiler's *Biblical Hermeneutics*, by the Rev. W. Wright, LL.D., Lond. 1834, § 31, &c.). Symbols, types, parables, and allegories are included under this form of instruction, of which, in all its parts, the inspired teachers, both under the former as well as the Christian dispensation, are considered to have availed themselves in the communication of the divine will. They conformed themselves to the capacities of their hearers, and did not think it necessary to refute such of their errors as had no connection with religious truths. But in modern times, and especially within the last half-century, the principle of accommodation in dogmatic theology has, in the interpretation of the Scriptures, far exceeded these limits. While sober interpreters allowed that it was the duty of a religious instructor to reserve the inculcation of certain religious truths, which the hearers were yet inadequate to comprehend, or admitted that the inspired teachers adopted the prevailing opinions in natural science, or even in regard to genealogical records, or points of chronology and other topics unconnected with the salvation of mankind—such as the received popular notions respecting demons—or, at

least, would not disturb the minds of their hearers by correcting their notions on such subjects—the advocates of this theory, feeling the difficulty of fixing the exact limits of the system, or considering the only substantial truths to be those of natural religion, proceeded to the length of holding that all beyond these, including every peculiar doctrine of Christianity, was a mere accommodation to the prejudices or expectations of their contemporaries. They thus confounded what was true, viz., accommodation in the *form*, with—what was inconsistent with the character of a divine revelation, or even with that of an upright human legislator—accommodation in the *matter* of their instructions; every thing mysterious and difficult, the very notion that Christianity was a revelation from heaven, was said to be merely a wise condescension to the weakness of former ages; and this system long continued to be the prevalent one in Germany. Others have maintained that the sacred writers were themselves not free from the errors and prejudices of their countrymen, and that, instead of accommodating themselves to these, they were only teaching what they believed to be true. The question has assumed a new shape since the rise and development of this latter view, according to which the apostles have been placed, in regard to their interpretations, said to be derived from the Rabbinical schools, on a level with the mass of their countrymen. The general inclination and tendency of the system is this—that in the New Testament we shall find only the opinions of Christ and the apostles, and not religious and eternal truths. The principle of dogmatical accommodation, to a certain extent, has, in various degrees, exercised from an early age an influence on the interpretation of the Scriptures; but it did not assume its present form before the time of Semler, in whose writings we find the germ, at least, of that system which has been considered as the most formidable weapon ever devised for the destruction of Christianity (Rose's *Protestantism in Germany*, p. 75, Lond. 1829).

The dogmatical accommodation has been also called, in latter times, *historical interpretation*, in contradistinction to *grammatical*, or doctrinal, inasmuch as it refers to the alleged transient opinions of a peculiar age, which the inspired teachers are said to have employed in their instructions. Those who support this theory are strongly opposed to verbal, or what they designate *literal* criticism, which they condemn as being barren, minute, and of little value, as if it had reference only to words and syllables; but experience has shown that where verbal criticism has been neglected, literature has been unknown or uncultivated (Preface to Tittman's *Meletemata Sacra*. See also Storr, *De Sensu Historico Scripturæ Sacræ*, and his *Dissertation on the Object of the Death of Christ*; also his *Confidential Letters on the subject of Religion*; Haupt's *Bemerkungen über die Lehrart Jesu*; Heringa, *Verhandeling, ten betooge, dat Jesus end zyn Apostelen zich doorgaans niet geschikt hebben naar de Verkeerde denkbeelden van hunne tydgeenooten*; Reason and Revelation, by Crusius; Planck's *Introduction to Theological Sciences*, in *Biblical Cabinet*, vol. vii.; Less's *Letters on the Principle of Accommodation*; Lang, in *Flatt's Magazine*; Meyer's *Attempt*; Tzschirner's *Memorabilia*; and Starck's *Dialogues*, pp.

113-116. The doctrine has been defended, with various limitations, by Vogel, in his *Aufsätze*, and in his *Manual of Practical Divinity*; and by Schott, in his *Journal for Clergymen*. See also Bauer's *Hermeneutik*, § 147-151, p. 121-126; and Wright's *Seiler*, § 264-276, p. 418-435: these paragraphs are thus referred to by Jahn, *Enchiridion Hermeneuticæ*, p. 49).—W. W.

ACCOMMODATION (exegetical or special) is principally employed in the application of certain passages of the Old Testament to events in the New, to which they had no actual historical or typical reference. In this sense it is also called *illustration*. Citations of this description are apparently very frequent throughout the whole New Testament, but especially in the Epistle to the Hebrews. As the system of exegetical accommodation has in modern times been the occasion of much angry controversy, it will be necessary to enter somewhat minutely into its character and history.

It cannot be denied that many such passages, although apparently introduced as referring to, or predictive of, certain events recorded in the New Testament, seem to have, in their original connection, an exclusive reference to quite other objects. The difficulty of reconciling such *seeming* misapplications, or deflections from their original design, has been felt in all ages, although it has been chiefly reserved to recent times to give a solution of the difficulty by the theory of *accommodation*. By this it is meant that the prophecy or citation from the Old Testament was not designed literally to apply to the event in question, but that the New Testament writer merely adopted it for the sake of ornament, or in order to produce a strong impression, by showing a remarkable parallelism between two analogous events, which had in themselves no mutual relation.

There is a catalogue of more than seventy of these accommodated passages adduced by the Rev. T. H. Horne, in support of this theory, in his *Introduction to the Critical Study of the Holy Scriptures* (vol. ii. part i. ch. iv. sect. 11, p. 343, 7th ed. 1834), but it will suffice for our purpose to select the following specimens, which are those given by Jahn, in his *Enchiridion Hermeneuticæ*, § 31 :—

Matt. xiii. 35,	cited from	Psalms lxxviii. 2.
” viii. 17	”	Isaiah liii. 4.*
” ii. 15	”	Hosea xi. 1.
” ii. 17, 18	”	Jeremiah xxxi. 15.
” iii. 3	”	Isaiah xl. 3.

It will be necessary, for the complete elucidation of the subject, to bear in mind the distinction not only between accommodated passages and such as must be properly explained (as those which are absolutely adduced as proofs), but also between such passages and those which are merely borrowed, and applied by the sacred writers, sometimes in a higher sense than they were used by the

original authors. Passages which do not strictly and literally predict future events, but which can be applied to an event recorded in the New Testament by an accidental parity of circumstances, can alone be thus designated. Such accommodated passages therefore, if they exist, can only be considered as descriptive, and not predictive.

It will here be necessary to consider the various modes in which the prophecies of the Old Testament are supposed to be fulfilled in the New. For instance, the opinion has been maintained by several divines, and is adopted in Mr. Horne's *Introduction*, that there is sometimes a literal, sometimes only a mediate, typical, or spiritual fulfilment. Sometimes a prophecy is cited merely by way of illustration (accommodation), while at other times nothing more exists than a mere allusion. Some prophecies are supposed to have an immediate literal fulfilment, and to have been afterwards accomplished in a larger and more extensive sense; but as the full development of this part of the subject appertains more properly to the much controverted question of the single and double sense of prophecy, we shall here dwell no further on it than to observe, that not only are commentators who support the theory of a double sense divided on the very important question, what are literal prophecies and what are only prophecies in a secondary sense, but they who are agreed on this question are at variance as to what appellation shall be given to those passages which are applied by the New Testament writers to the ministry of our Saviour, and yet historically belong to an antecedent period. In order to lessen the difficulty, a distinction has been attempted to be drawn, by Dathe and others, from the formula with which the quotation is ushered in. Passages, for instance, introduced by the formula *ἵνα πληρωθῆ*, 'that it might be fulfilled,' are considered, on this account, as direct predictions by some, who are willing to consider citations introduced with the expression *τότε ἐπληρώθη*, 'then was fulfilled,' as nothing more than accommodations. The use of the former phrase, as applied to a mere accommodation, they maintain is not warranted by Jewish writers: such passages, therefore, they hold to be prophecies, at least in a secondary sense (see Bishop Marsh's seventeenth *Lecture*, in which, however, he justly observes, that if *all* prophecies were to be considered such only in a secondary or mystical sense, they would lose much of their satisfactory character). Bishop Kidder (*Demonstration of the Messias*, part ii. p. 81, Lond. 1726) appositely observes, in regard to this subject, that 'a scripture may be said to be fulfilled several ways, viz., properly and in the letter, as when that which was foretold comes to pass; or again, when what was fulfilled in the type is fulfilled again in the antitype; or else a scripture may be fulfilled more improperly, viz., by way of *accommodation*, as when an event happens to any place or people like to that which fell out some time before.' He instances the citation, Matt. ii. 17, 'In Ramah was a voice heard,' &c. 'These words,' he adds, 'are made use of by way of allusion to express this sorrow by. The evangelist doth not say "that it might be fulfilled," but "then was fulfilled," *q. d.*, such another scene took place.'

It must at the same time be admitted that this distinction in regard to the formula of quotation

* Jahn has observed that the quotation from the Old Testament in this passage 'He cast out the spirits with his word, and healed all that were sick, *that it might be fulfilled which was spoken by Esaias, saying, Himself took our infirmities, and bare our sicknesses,*' is constantly used in its proper sense when cited in other parts of the New Testament.

is not acknowledged by the majority of commentators, either of those who admit or of those who deny the theory of accommodation. Among the former it will suffice to name Calnet, Doddridge, Rosenmüller, and Jahn, who look upon passages introduced by the formula 'that it might be fulfilled,' as equally accommodations with those which are prefaced by the words 'then was fulfilled;' while those who deny the accommodative theory altogether, consider both as formulas of direct prophecies, at least in a secondary or typical sense. This, for instance, is the case especially in regard to the two citations of this description which first present themselves in the New Testament, viz. Matt. ii. 13, and Matt. ii. 17, the former of which is introduced by the first, and the latter by the second of these formulas. But inasmuch as the commentators above referred to cannot perceive how the citation from Hosea xi. 1, 'Out of Egypt have I called my son,' although prefaced by the formula 'that it might be fulfilled,' and which literally relates to the calling of the children of Israel out of Egypt, can be prophetically diverted from its historical meaning, they look upon it as a simple accommodation, or applicable quotation, and consider the *ἡνα πληρωθῆ* as a Jewish formula of accommodation. Mr. Horne, after referring in support of this explanation to some questionable examples from Surenhusius's *Βίβλος καταλλαγῆς*, and Rosenmüller's *Commentary on the New Testament*, observes, that 'it was a familiar idiom of the Jews, when quoting the writings of the Old Testament, to say, *that it might be fulfilled which was spoken by such and such a prophet*, not intending it to be understood that such a particular passage in one of the sacred books was ever designed to be a *real prediction* of what they were then relating, but signifying only that the words of the Old Testament might be properly adopted to express their meaning and illustrate their ideas' (*Introduction*, vol. ii. part i. ch. 4). 'The apostles,' he adds, 'who were Jews by birth, and wrote and spoke in the Jewish idiom, frequently thus cite the Old Testament, intending no more by this mode of speaking, than that the words of such an ancient writer might with equal propriety be adopted to characterize any similar occurrence which happened in their times. The formula "that it might be fulfilled," does not therefore differ in signification from the phrase "then was fulfilled," applied in the following citation in Matt. ii. 17, 18, from Jer. xxxi. 15-17, to the massacre of the infants at Bethlehem. They are a beautiful quotation, and not a prediction of what then happened, and are therefore applied to the massacre of the infants according not to their original and historical meaning, but according to Jewish phraseology.' Dr. Adam Clarke, also, in his *Commentary on Jeremiah* (xxx. 15-17), takes the same view:—'St. Matthew, who is ever fond of accommodation, applied these words to the massacre of the children of Bethlehem; that is, they were suitable to that occasion, and therefore he applied them, but they are not a prediction of that event. So opposed, however, was the late Rev. Hugh James Rose to this principle of accommodation, that he included the application of it to this very passage among those which ought to exclude Kuinoel as a commentator from the library of the theological student (Supplement to *State*

of Protestantism, p. xlii.); and the Rev. Chas. Forster, in his *Critical Essays*, p. 59, in which he altogether opposes the theory, designates the distinction attempted to be drawn by Dathe and Bishop Marsh into the formulas of citation as "in all its bearings fanciful and licentious." Mr. Forster's view is, that in the return of the Messiah out of Egypt, and in his return alone, the promise of the Lord to Rachel (Jer. xxxi. 16), 'and they shall come again from the land of the enemy,' which was figuratively fulfilled in the return of the Jews of the three generations from the captivity in Babylon, was adequately and literally fulfilled, and that his coming again out of Egypt is an event distinctly predicted of the Messiah, under the figure of Israel in Egyptian bondage (Hos. xi. 1).

In the same manner he infers that, so far from the prophecy in Jer. xxxi. being an accommodation of the evangelist's, the prophet himself had diverted to his immediate purpose (the Babylonish captivity), in the way of accommodation only, the prophetic type (Gen. xxxv. 16-19) from its proper object, the birth of the Messiah at Bethlehem, in which the historical type found its literal fulfilment (*Critical Essays*, p. 34).

D. J. G. Rosenmüller gives as examples, which he conceives clearly show the use of these formulas, the passages Matt. i. 22, 23; ii. 15, 17, 23; xv. 7; Luke iv. 21; James ii. 23; alleging that they were designed only to denote that something took place which resembled the literal and historical sense. The sentiments of a distinguished English divine are to the same effect:—'I doubt not that this phrase, "that it might be fulfilled," and the like were used first in quoting real prophecies, but that this, by long use, sunk in its value, and was more vulgarly applied, so that at last it was given to scripture only accommodated.' And again, 'If prophecy could at last come to signify singing (Titus i. 12; 1 Sam. x. 10; 1 Cor. xiv. 1), why might not the phrase *fulfilling of Scripture and prophecy* signify only quotation?' (Nicholl's *Conference with a Theist*, 1698, part iii. p. 13).

The accommodation theory in exegesis has been equally combated by two classes of opponents. Those of the more ancient school consider such mode of application of the Old Testament passages not only as totally irreconcilable with the plain grammatical construction and obvious meaning of the controverted passages which are said to be so applied, but as an unjustifiable artifice, altogether unworthy of a divine teacher; while the other class of expositors, who are to be found chiefly among the most modern of the German (so called) Rationalists, maintain that the sacred writers, having been themselves trained in this erroneous mode of teaching, had mistakenly, but *bonâ fide*, interpreted the passages which they had cited from the Old Testament in a sense altogether different from their historical meaning, and thus applied them to the history of the Christian dispensation. Some of these have maintained that the accommodation theory was a mere shift (see Rosenmüller's *Historia Interpretationis*) resorted to by commentators who could not otherwise explain the application of Old Testament prophecies in the New consistently with the inspiration of the sacred writers: while the advocates of the system consider that the apostles, in adapting themselves to the mode of interpretation which

was customary in their days, and in further adopting what may be considered an argument *e concessis*, were employing the most persuasive mode of oratory, and the one most likely to prove effectual; and that it was therefore lawful to adopt a method so calculated to attract attention to their divine mission, which they were at all times prepared to give evidence of by other and irrefragable proofs.

We shall conclude with giving a brief sketch of the history of this method of interpretation. Mr. Stuart, of Andover, in the Excursus to his *Commentary on Hebrews*, alleges that the fathers of the church had no hesitation in applying this system to the interpretation of the Scriptures. But he has furnished us with no example of their critical application of it, and any such application seems to us scarcely compatible with the allegorical fancies to which they seem to have been addicted. The difference, indeed, had been at all times felt, from Origen downwards, between the historical sense of the citations, and that to which they are applied in the New Testament; and expositors have been divided into two classes; the one making the New Testament interpretation the rule for the explanation of Old Testament passages, and the other attempting, in various ways, to reconcile the discrepancy (see Tholuck's *Commentary on Hebrews*). But the first who appears to have led the way to the mode of interpretation in question, was Theodore of Mopsuestia, in the fifth century, who, so far as we can judge from the few writings of his which have come down to us, was decidedly favourable to literal and historical interpretation. He considered that the Old Testament contained very few direct prophecies of the Messiah, and in reference to other quotations, such as that in John xix. 24, and Rom. x. 6, observes that the apostle 'alters the phrase to suit it to his argument' (see Tholuck's *Commentary on Hebrews*). And again, in reference to Psalm xxii. 19, Theodore observes that the second verse, and consequently the psalm itself, cannot possibly refer to Him 'who did no sin, neither was guile found in His mouth;' but that as our Lord on the cross cited the words of the psalm, 'My God, my God, why hast thou forsaken me?' the apostle, on this account, *accommodated* to Christ the words of this verse also: 'They parted my garments among them, and for my vesture did they cast lots.' He seems at the same time to have acknowledged the existence of a higher and lower sense, for he observes that some passages referring to the Messiah had been 'hyperbolically applied to historical personages in the Old Testament,' and says of Psalm lxix. 22, that the words may, in another sense, be referred to our Lord, although the Psalm did not historically refer to him (see Rosenmüller's *Historia Interpretationis*, vol. iii. 260). Rosenmüller conceives, from an expression of Nicholas Lyranus, that he (Nicholas) had at least a glimpse of this system. But the person who, 'so far as modern theology is concerned,' to use the words of the Rev. J. J. Conybeare (*Bampton Lectures*), 'was the first and most eminent patron and advocate of the system' was Calvin, who 'adopted principles of exposition which, since the condemnation of Theodore, in the fifth century, had scarcely perhaps been heard of, and assuredly never been entertained in the

Christian church.' Erasmus and Luther had, no doubt, led the way by their advocacy of the literal interpretation; but, even in passages which have been supposed to bear a double relation to the Jewish and Christian church, Calvin appears rather to ground such application on the nature and similarity of the subjects and their condition, than upon anything of a distinctly typical and prophetic character. He is, therefore, disposed to look not so much for an intention originally spiritual and predictive of higher things, as for the authoritative application of a new and more extended sense by the inspired writers themselves. On Heb. ii. 6, he remarks, 'that it was not the apostle's intention to give the genuine exposition of the words, and that no inconvenience can result from supposing that the apostle makes allusions to the Old Testament passage for the sake of embellishment.' In regard to the passages in Matt. ii. 15-17, already cited, he observes, 'beyond controversy, the passage Hos. xi. 1, must not be restricted to Christ;' and in reference to the second quotation (Jerem. xxxi. 15), he says 'it is certain that the prophet refers to the slaughter of the tribe of Benjamin, which took place in his own time; and Matthew, in citing the words of the prophet, does not mean that this was a prediction of what Herod was about to do, but that there was a renewal of the lamentation of the Benjaminites.' And again, 'Non tam impetratur, quam *piâ deflexione* ad Christi personam *accommodat'* (Calvin's *Commentary on Hebrews*, *passim*).

But while the credit of this invention has been thus attributed to Calvin, 'a writer, whom on the one hand no one will accuse of any Neologian tendency, while on the other the most sober and judicious critic will find nothing in his exposition revolting to the strictest rules of just interpretation' (*Lectures, &c.*, by W. D. Conybeare), the doctrine of accommodation, once employed for the purpose of discarding all spiritual and allegorical methods of interpretation, was at a later period extended to all that had been hitherto considered as typical. In England, Dr. Sykes, in his answer to Collins, and in the preface to his *Commentary on the Epistle to the Hebrews*, surrendered the whole scheme of typical prefiguration and secondary prophecy, as destitute of proof, and accommodated to the mission of our Lord in condescension to the reigning prejudices of the people. Le Clerc carried his notions of accommodation to such excess, as nearly to invalidate the prophetic character of the Old Testament altogether, and considerably to depreciate the divine authority of the New; and Semler pronounced *all* the references made in Scripture by our blessed Lord and his disciples, to be the mere result of a compliance with the false and Rabbinical theories of their unenlightened countrymen.

Among those who, in modern times, have most ably vindicated the system of the typical interpretation of prophecy, as opposed to the accommodation theory, is Professor Tholuck, of Berlin, in the Dissertation affixed to his *Commentary on Hebrews*. He does not, indeed, deny all instances of accommodation, but refers a great number of passages which had been so interpreted (as Matt. ii. 15, 18; xxvii. 9, 35; John iii. 14; xix. 24, 36; Acts i. 20; ii. 27-31) to the class of typical prophecies

The only canon furnished by Professor Tholuck for distinguishing between types and accommodation is, the consideration of the importance of the subject to which they are applied—a rule which must ever be vague and unsatisfactory. The Rev. J. J. Conybeare is of opinion that we are 'not to look for any secondary sense but what is inherent in and consequential on the typical, the typical being determined by the real and essential points of analogy between the connected objects.' Professor Tholuck had been preceded by Billoth in his *Commentary on Corinthians*, who had observed in reference to the citation in 1 Cor. i. 19, that we are 'not to look for a strict historical identity between the meaning which St. Paul attaches to the passages, and that entertained by their original authors, but merely a connection of an analogical kind.' Billoth then proceeds to vindicate the sacred writers from the charge of ignorance, if not disingenuousness, by the consideration that the Old Testament, taken as a whole, is a type of the New. This is the idea on which Tholuck has enlarged, and which, he thinks, dispels all misconception on the subject; but Billoth's translator observes that, if it be meant that 'the declarations of the prophets, instead of being actual descriptions of the coming Messiah, directly communicated by divine impulse, were merely poetical delineations of persons or events connected with Jewish history, and intended by the divine Spirit to be typical of what was to happen in after times, then were they, correctly speaking, no prophecies at all, and it was vain and foolish in our Lord and his apostles to appeal to the fulfilment of them in Him and His church, as a proof that he was the Messiah to whom they referred.' The writer conceives it to be more philosophical to consider the Old Testament passages as having the meaning which the apostle ascribes to them, than suppose our own interpretation of them to be correct, or attempt to explain them in an accommodative or even typical sense. To remark on these views would amount to a re-opening of the question: we shall, therefore, conclude these observations in the words of the temperate and judicious writer whom we have already cited.

'Although, even the most cautious and unquestionably pious expositors of Scripture have admitted that some few passages of the Old Testament, quoted or referred to in the New, must, in the present state of our knowledge, be regarded as so applied or accommodated to the description and illustration of subjects foreign to their original scope and intention, yet it is surely unreasonable and uncritical to argue from these few to the whole, or even the larger portion of those sayings, which we are assured that holy men of old uttered, as the spirit directed and enabled them' (*Bampton Lectures*, by J. J. Conybeare, Oxford, 1826).—W. W.

ACCUBATION, the posture of reclining on couches at table, which prevailed among the Jews in and before the time of Christ. We see no reason to think that, as commonly alleged, they borrowed this custom from the Romans after Judea had been subjugated by Pompey. But it is best known to us as a Roman custom, and as such must be described. The dinner-bed, or *triclinium*, stood in the middle of the dining-room, clear of the walls, and formed three sides of a square which enclosed the table. The open end of the

square, with the central hollow, allowed the servants to attend and serve the table. In all the existing representations of the dinner-bed it is shown to have been higher than the enclosed table. Among

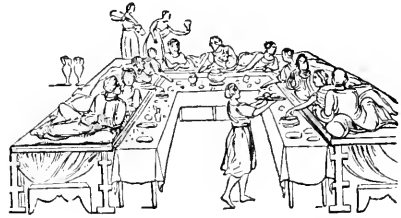

the Romans the usual number of guests on each couch was three, making nine for the three couches, equal to the number of the Muses; but sometimes there were four to each couch. The Greeks went beyond this number (*Cic. In Pis.* 27); the Jews appear to have had no particular fancy in the matter, and we know that at our Lord's last supper thirteen persons were present. As each guest leaned, during the greater part of the entertainment, on his left elbow, so as to leave the right arm at liberty, and as two or more lay on the same couch, the head of one man was near the breast of the man who lay behind him, and he was, therefore, said 'to lie in the bosom' of the other. This phrase was in use among the Jews (*Luke xvi. 22, 23; John i. 18; xiii. 23*), and occurs in such a manner as to show that to lie next below, or 'in the bosom' of the master of the feast, was considered the most favoured place; and is shown by the citations of Kypke and Wetstein (on *John xiii. 23*) to have been usually assigned to near and dear connections. So it was 'the disciple whom Jesus loved' who 'reclined upon his breast' at the last supper. Lightfoot and others suppose that as, on that occasion, John lay next below Christ, so Peter, who was also highly favoured, lay next above him. This conclusion is founded chiefly on the fact of Peter beckoning to John that he should ask Jesus who was the traitor. But this seems rather to prove the contrary—that Peter was not near enough to speak to Jesus himself. If he had been there, Christ must have lain near his bosom, and he would have been in the best position for whispering to his master, and in the worst for beckoning to John. The circumstance that Christ was able to reach the sop to Judas when he had dipped it, seems to us rather to intimate that he was the one who filled that place. Any person who tries the posture may see that it is not easy to deliver anything but to the person next above or next below. And this is not in contradiction to, but in agreement with, the circumstances. The morsel of favour was likely to be given to one in a favoured place; and Judas being so trusted and honoured as to be the treasurer and almoner of the whole party, might, as much as any other of the apostles, be expected to fill that place. This also gives more point to the narrative, as it aggravates by contrast the turpitude and baseness of his conduct.

The frame of the dinner-bed was laid with mattresses variously stuffed, and, latterly, was furnished with rich coverings and hangings. Each person

was usually provided with a cushion or bolster on which to support the upper part of his person in a somewhat raised position; as the left arm alone could not long without weariness sustain the weight. The lower part of the body being extended diagonally on the bed, with the feet outward, it is at once perceived how easy it was for 'the woman that was a sinner' to come behind between the dinner-bed and the wall, and anoint the feet of Jesus (Matt. xxvi. 7; Mark xiv. 3).

The dinner-beds were so various at different times, in different places, and under different circumstances, that no one description can apply to them all. Even among the Romans they were at first (after the Punic war) of rude form and materials, and covered with mattresses stuffed with rushes or straw; mattresses of hair and wool were introduced at a later period. At first the wooden frames were small, low, and round; and it was not until the time of Augustus that square and ornamented couches came into fashion. In the time of Tiberius the most splendid sort were veneered with costly woods or tortoiseshell, and were covered with valuable embroideries, the richest of which came from Babylon, and cost large sums (U. K. S. *Pompeii*, ii. 88). The Jews perhaps had all these varieties, though it is not likely that the usage was ever carried to such a pitch of luxury as among the Romans; and it is probable that the mass of the people fed in the ancient manner—seated on stools or on the ground. It appears that couches were often so low, that the feet rested on the ground; and that cushions or bolsters were in general use. It would also seem, from the mention of two and of three couches, that the arrangement was more usually square than semicircular or round (*Lightfoot, Hor. Heb.* in John xiii. 23).



It is utterly improbable that the Jews derived this custom from the Romans, as is constantly alleged. They certainly knew it as existing among the Persians long before it had been adopted by the Romans themselves (Esth. i. 6; vii. 8); and the presumption is that they adopted it while subject to that people. The Greeks also had the usage (from the Persians) before the Romans; and with the Greeks of Syria the Jews had very much intercourse. Besides, the Romans adopted the custom from the Carthaginians (Val. Max. xii. 1, 2; Liv. xxviii. 28); and, that they had it, implies that it previously existed in Phœnicia, in the neighbourhood of the Jews. Thus, that in the time of Christ the custom had been lately

adopted from the Romans, is the last of various probabilities. It is also unlikely that in so short a time it should have become usual and even (as the Talmud asserts) obligatory to eat the Passover in that posture of indulgent repose, and in no other. All the sacred and profane literature of this subject has been most industriously brought together by Stuckius (*Antiq. Convivialium*, ii. 34); and the works on Pompeii and Herculaneum supply the more recent information.

ACCUSED. [ANATHIEMA.]

ACCUSER (אָנאָרִיבֵּן וְיֵבֵן; Sept. and New Test. ἄντιδικος). The original word, which bears this leading signification, means, 1. One who has a cause or matter of contention; the accuser, opponent, or plaintiff in any suit (Judg. xii. 2; Matt. v. 25; Luke xii. 58). We have little information respecting the manner in which causes were conducted in the Hebrew courts of justice, except from the Rabbinical authorities, who, in matters of this description, may be supposed well informed as to the later customs of the nation. Even from these we learn little more than that great care was taken that, the accused being deemed innocent until convicted, he and the accuser should appear under equal circumstances before the court, that no prejudicial impression might be created to the disadvantage of the defendant, whose interests, we are told, were so anxiously guarded, that any one was allowed to speak whatever he knew or had to say in his favour, which privilege was withheld from the accuser (Lewis, *Origines Hebrææ*, i. 68). The word is, however, to be understood in regard to the real plaintiff, not to the advocates, who only became known in the later period of the Jewish history [ADVOCATE].

The word is also applied in Scripture, in the general sense, to any adversary or enemy (Luke xviii. 3; 1 Pet. v. 8). In the latter passage there is an allusion to the old Jewish notion that Satan was the accuser or calumniator of men before God (Job i. 6, sq.; Rev. xii. 10, sq.; comp. Zech. iii. 1). In this application the forensic sense was still retained, Satan being represented as laying to man's charge a breach of the law, as in a court of justice, and demanding his punishment [SATAN].

ACELDAMA (Ἀκελδამά, from the Syro-Chaldaic, אַכֶּלְדָּמָא, *field of blood*), the field purchased with the money for which Judas betrayed Christ, and which was appropriated as a place of burial for strangers (Matth. xxvii. 8; Acts i. 19). It was previously 'a potter's field.' The field now shown as Aceldama lies on the slope of the hills beyond the valley of Hinnom, south of Mount Zion. This is obviously the spot which Jerome points out (*Onomast. s. v.* 'Acheldamach'), and which has since been mentioned by almost every one who has described Jerusalem. Sandys thus writes of it: 'On the south side of this valley, neere where it meeteth with the valley of Jehoshaphat, mounted a good height on the side of the mountain, is *Aceldama*, or the field of blood, purchased with the restored reward of treason, for a burial place for strangers. In the midst whereof a large square roome was made by the mother of Constantine; the south side, walled with the natural rock; flat at the top, and equal with the upper level; out of which ariseth certaine

little cupoles, open in the midst to let down the dead bodies. Throw these we might see the bottom, all covered with bones, and certain corpses but newly let down, it being now the sepulchre of the Armenians. A greedy grate, and great enough to devour the dead of a whole nation. For they say (and I believe it), that the earth thereof within the space of eight and forty hours will consume the flesh that is laid thereon' (*Relation of a Journey*, p. 187). He then relates the common story, that the empress referred to caused 270 ship-loads of this flesh-consuming mould to be taken to Rome, to form the soil of the Campo Sancto, to which the same virtue is ascribed. Castela affirms that great quantities of the wondrous mould were removed by divers Christian princes in the time of the Crusades, and to this source assigns the similar sarcophagic properties claimed not only by the Campo Santo at Rome, but by the cemetery of St. Innocents at Paris, by the cemetery at Naples (*Le Sainct Voyage de Hierusalem*, 1603, p. 150; also Roger, p. 160); and, we may add, that of the Campo Santo at Pisa.

The plot of ground originally bought 'to bury strangers in,' seems to have been early set apart by the Latins, as well as by the Crusaders, as a place of burial for pilgrims (Jac. de Vitriaco, p. 64). The charnel-house is mentioned by Sir John Mandeville, in the fourteenth century, as belonging to the Knights-hospitallers. Sandys shows that, early in the seventeenth century, it was in the possession of the Armenians. Eugene Roger (*La Terre Saincte*, p. 161) states that they bought it for the burial of their own pilgrims, and ascribes the erection of the charnel-house to them. They still possessed it in the time of Maundrell, or rather rented it, at a sequin a day, from the Turks. Corpses were still deposited there; and the traveller observes that they were in various stages of decay, from which he conjectures that the grave did not make that quick dispatch with the bodies committed to it which had been reported. 'The earth, hereabouts,' he observes, 'is of a chalky substance; the plot of ground was not above thirty yards long by fifteen wide; and a moiety of it was occupied by the charnel-house, which was twelve yards high' (*Journey*, p. 136). Richardson (*Travels*, p. 567) affirms that bodies were thrown in as late as 1818; but Dr. Robinson alleges that it has the appearance of having been for a much longer time abandoned: 'The field or plat is not now marked by any boundary to distinguish it from the rest of the hill-side; and the former charnel-house, now a ruin, is all that remains to point out the site. . . . An opening at each end enabled us to look in; but the bottom was empty and dry, excepting a few bones much decayed' (*Biblical Researches*, l. 524).

ACHAIA (*Ἀχαΐα*), a region of Greece, which in the restricted sense occupied the north-western portion of the Peloponnesus, including Corinth and its isthmus (Strabo, viii. p. 438, sq.). By the poets it was often put for the whole of Greece, whence *Ἀχαιοί*, the *Greeks*. Under the Romans, Greece was divided into two provinces, Macedonia and Achaia, the former of which included Macedonia proper, with Illyricum, Epirus, and Thessaly; and the latter, all that lay southward of the former (Cellar. i. p. 1170, 1022). It is in this latter acceptation that the name of Achaia is always employed in the

New Testament (Acts xviii. 12, 16; xix. 21; Rom. xv. 26; xvi. 25; 1 Cor. xvi. 15; 2 Cor. i. 1; ix. 2; xi. 10; 1 Thess. i. 7, 8). Achaia was at first a senatorial province, and, as such, was governed by proconsuls (Dion Cass. liii. p. 704). Tiberius changed the two into one imperial province under procurators (Tacit. *Annal.* i. 76); but Claudius restored them to the senate and to the proconsular form of government (Suet. *Claud.* 25). Hence the exact and minute propriety with which St. Luke expresses himself in giving the title of proconsul to Gallio, who was appointed to the province in the time of Claudius (Acts xviii. 12).

ACHAICUS (*Ἀχαικός*), a native of Achaia, and a follower of the apostle Paul. He, with Stephanus and Fortunatus, was the bearer of the 1st Epistle to the Corinthians, and was recommended by the apostle to their special respect (1 Cor. xvi. 17).

ACHIAN (*אֲחִיאן*; Sept. *Ἀχαιαν*, or *Ἀχαπ*, Josh. vii. 1). In the parallel passage (1 Chron. ii. 7) the name is spelt *אֲחִיא*, and as it has there the meaning of *troubling*, it is thought by some that this is an intentional change, after the fact, to give the name a significant reference to the circumstance which renders it notorious. The city of Jericho, before it was taken, was put under that awful ban, of which there are other instances in the early Scripture history, whereby all the inhabitants (excepting Rahab and her family) were devoted to destruction, all the combustible goods to be consumed by fire, and all the metals to be consecrated to God. This vow of devotion was rigidly observed by all the troops when Jericho was taken, save by one man, Achan, a Judahite, who could not resist the temptation of secreting an ingot of gold, a quantity of silver, and a costly Babylonish garment, which he buried in his tent, deeming that his sin was hid. But God made known this infraction, which, the vow having been made by the nation as one body, had involved the whole nation in his guilt. The Israelites were defeated, with serious loss, in their first attack upon Ai; and as Joshua was well assured that this humiliation was designed as the punishment of a crime which had inculturated the whole people, he took immediate measures to discover the criminal. As in other cases, the matter was referred to the Lord by the lot, and the lot ultimately indicated the actual criminal. The conscience-stricken offender then confessed his crime to Joshua; and his confession being verified by the production of his ill-gotten treasure, the people, actuated by the strong impulse with which men tear up, root and branch, a polluted thing, hurried away not only Achan, but his tent, his goods, his spoil, his cattle, his children, to the valley (afterwards called) of Achor, north of Jericho, where they stoned him, and all that belonged to him; after which the whole was consumed with fire, and a cairn of stones raised over the ashes. The severity of this act, as regards the *family* of Achan, has provoked some remark. Instead of vindicating it, as is generally done, by the allegation that the members of Achan's family were probably accessories to his crime after the fact, we prefer the supposition that they were included in the doom by one of those sudden impulses of indiscriminate popular vengeance to which the Jewish people were exceed-

ingly prone, and which, in this case, it would not have been in the power of Joshua to control by any authority which he could under such circumstances exercise. It is admitted that this is no more than a conjecture: but, as such, it is at least worth as much, and assumes considerably less, than the conjectures which have been offered by others (Josh. vii.).

ACHAR. [ACHAN.]

ACHASHDARPENIM (אֲחַשְׁדַּרְפֵּינִים; Sept. *ααρησαι* and *στρατηγοι*; Vulg. *satrapæ*; A. V. 'rulers of provinces.' It occurs in Esth. iii. 12; viii. 9; ix. 3; and with the Chaldee termination *an*, in Dan. iii. 2, 3, 27; vi. 2, 3). The word is undoubtedly merely another form of writing the Persian word *satrap*, the origin of which has been much disputed, and does not claim to be here considered. These satraps are known in ancient history as the governors or viceroys of the provinces into which the Persian empire was divided. Strictly speaking, they had an extended civil jurisdiction over several smaller provinces, each of which had its own פחה or governor. Thus Zerubbabel and Nehemiah were 'governors' of Judea, under the Persian satraps of Syria (Ezra, iv. 3, 6; Neh. ii. 9). The power and functions of the Persian satraps were not materially different from those of the modern Persian governors and Turkish pashas; and, indeed, the idea of provincial government by means of viceroys, entrusted with almost regal powers in their several jurisdictions, and responsible only to the king, by whom they are appointed, has always been prevalent in the East. The important peculiarity and distinction in the ancient Persian government, as admirably shown by Heeren (*Researches*, i. 489, sq.), was that the civil and military powers were carefully separated: the satrap being a very powerful civil and political chief, but having no immediate control over the troops and garrisons, the commanders of which were responsible only to the king. The satraps, in their several provinces, employed themselves in the maintenance of order and the regulation of affairs; and they also collected and remitted to the court the stipulated tribute, clear of all charges for local government and for the maintenance of the troops (Xenoph. *Cyrop.* viii. 6, § 1-3). In later times this prudent separation of powers became neglected, in favour of royal princes and other great persons (Xenoph. *Anab.* i. 1, § 2), who were entrusted with the military as well as civil power in their governments; to which cause may be attributed the revolt of the younger Cyrus, and the other rebellions and civil wars, which, by weakening the empire, facilitated its ultimate subjugation by Alexander.

ACHBAR. [MOUSE.]

ACHISH (אֲחִישׁ; signification uncertain; Sept. Ἀγχιος, also Ἀχις, Ἀχίς, called Abimelech in the title of Ps. xxxiv.), the Philistine king of Gath, with whom David twice sought refuge when he fled from Saul (1 Sam. xxi. 10-15; xxvii. 1-3). The first time David was in imminent danger; for he was recognised and spoken of by the officers of the court as one whose glory had been won at the cost of the Philistines. This talk filled David with such alarm that he feigned himself mad when introduced to the notice of Achish, who, seeing him 'scrabbling upon the

doors of the gate, and letting his spittle fall down upon his beard,' rebuked his people sharply for bringing him to his presence, asking, 'Have I need of madmen, that ye have brought this fellow to play the madman in my presence? Shall this fellow come into my house?' After this David lost no time in quitting the territories of Gath. Winer illustrates David's conduct by reference to the similar proceeding of some other great men, who feigned themselves mad in difficult circumstances—as Ulysses (Cic. *Off.* iii. 26; Hygin. f. 95, *Schol. ad Lycophr.* 818), the astronomer Meton (Ælian, *Hist.* xiii. 12), L. Junius Brutus (Liv. i. 56; Dion. Hal. iv. 68), and the Arabian king Bacha (Schultens, *Anth. Vet. Itanasa*, p. 535). About four years after, when the character and position of David became better known, and when he was at the head of not less than 600 resolute adherents, he again repaired with his troop to King Achish, who received him in a truly royal spirit, and treated him with a generous confidence, of which David took rather more advantage than was creditable to him [DAVID].

ACHMETHA (אֲחֻמֶּתָּה, Ezra vi. 2; Ἐκβάτανα, 2 Macc. ix. 3; Judith xi. 1; Tob. v. 9; Joseph. *Antiq.* x. 11, 7; xi. 4, 6; also, in Greek authors, Ἐγβάτανα and Ἀγβάτανα), a city in Media. The derivation of the name is doubtful; but Major Rawlison (*Geogr. Journal*, x. 134) has left little question that the title was applied exclusively to cities having a fortress for the protection of the royal treasures. In Ezra we learn that in the reign of Darius Hystaspes the Jews petitioned that search might be made in the king's treasure-house at Babylon, for the decree which Cyrus had made in favour of the Jews (Ezra v. 17). Search was accordingly made in the record-office ('house of the rolls'), where the treasures were kept at Babylon (vi. 1): but it appears not to have been found there, as it was eventually discovered 'at Achmetha, in the palace of the province of the Medes' (vi. 2). It is here worthy of remark, that the LXX. regarded 'Achmetha,' in which they could hardly avoid recognising the familiar title of Ecbatana, as the generic name for a city, and, accordingly, rendered it by πόλις; and that Josephus, as well as all the Christian Greeks, while retaining the proper name of Ecbatana, yet agree, with the Greek Scriptures, in employing the word βάσις to express the Hebrew בֵּיתָה, *Birtha* ('the palace'), which is used as the distinctive epithet of the city.

In Judith i. 2-4, there is a brief account of Ecbatana, in which we are told that it was built by Arphaxad, king of the Medes, who made it his capital. It was built of hewn stones, and surrounded by a high and thick wall, furnished with wide gates and strong and lofty towers. Herodotus ascribes its foundation to Dejeoces, in obedience to whose commands the Medes erected 'that great and strong city, now known under the name of Agbatana, where the walls are built circle within circle, and are so constructed that each inner circle overtops its outer neighbour by the height of the battlements alone. This was effected partly by the nature of the ground, a conical hill, and partly by the building itself. The number of the circles was seven, and within the innermost was the palace of the treasury. The battlements of the first circle were white, of

the second black, of the third scarlet, of the fourth blue, of the fifth orange; all these were brilliantly coloured with different pigments; but the battlements of the sixth circle were overlaid with silver, and of the seventh with gold. Such were the palace and the surrounding fortification that Dejeoces constructed for himself: but he ordered the mass of the Median nation to construct their houses in a circle around the outer wall (Herodot. i. 98). It is contended by Major Rawlinson (*Geogr. Journal*, x. 127) that this story of the seven walls is a fable of Sabeian origin, the seven colours mentioned being precisely those employed by the Orientals to denote the seven great heavenly bodies, or the seven climates in which they revolve. He adds (p. 128), 'I cannot believe that at Agbatana the walls were really painted of these colours: indeed, battlements with gold and silver are manifestly fabulous; nor do I think that there ever could have been even seven concentric circles: but in that early age, where it is doubtful whether mithraicism, or fire-worship, had originated in this part of Asia, it is not at all improbable that, according to the Sabeian superstitions, the city should have been dedicated to the seven heavenly bodies, and perhaps a particular part assigned to the protection of each, with some coloured device emblematic of the tutelary divinity.'

This Ecbatana has been usually identified with the present Hamadan. Major Rawlinson, however, while admitting that Hamadan occupies the site of the Median Ecbatana, has a learned and most elaborate paper in the *Geographical Journal* (x. 65-158; *On the Site of the Atropatenian Ecbatana*), in which he endeavours to show that the present Takht-i-Suleiman was the site of another, the Atropatenian Ecbatana; and that to it, rather than to the proper Median Ecbatana, the statement in Herodotus and most of the other ancient accounts are to be understood to refer. Our only business is with the Achmetha of Ezra; and that does not require us to enter into this question. The major, indeed, seems inclined to consider the Ecbatana of the apocryphal books as his Atropatenian Ecbatana; but is rather more doubtful in claiming it as the Achmetha of Ezra. But without undertaking to determine what amount of ancient history should be referred to the one or to the other, we feel bound to conclude that Hamadan was the site of the Achmetha of Ezra, and the Ecbatana of the Apocrypha: 1. Because it is admitted that the Median Ecbatana was a more ancient and more anciently great city than the Atropatenian metropolis. 2. Because the name 'Achmetha' may easily, through the Syrian Ahmethan, and the Armenian Ahmetan, be traced in the Persian Hamadan. 3. And because all the traditions of the Jews refer to Hamadan as the site of the Achmetha and Ecbatana of their Scriptures.

Hamadan is still an important town, and the seat of one of the governments into which the Persian kingdom is divided. It is situated in north lat. 34° 53', east long. 40°, at the extremity of a rich and fertile plain, on a gradual ascent, at the base of the Elwund Mountains, whose higher summits are covered with perpetual snow. Some remnants of ruined walls of great thickness, and also of towers of sun-dried bricks, present the only positive evidence of a more ancient city than the present on the same spot. Heaps of compara-

tively recent ruins, and a wall fallen to decay, attest that Hamadan has declined from even its modern importance. The population is said by Southgate to be about 30,000, which, from what the present writer has seen of the place, he should judge to exceed the truth very considerably. It is little distinguished, inside, from other Persian towns of the same rank, save by its excellent and well-supplied bazaars, and the unusually large number of khans of rather a superior description. This is the result of the extensive transit trade of which it is the seat, it being the great centre where the routes of traffic between Persia, Mesopotamia, and Persia converge and meet. Its own manufactures are chiefly in leather. Many Jews reside here, claiming to be descended from those of the Captivity who remained in Media. Benjamin of Tudela says that in his time the number was 50,000. Modern travellers assign them 500 houses; but the Rabbi David de Beth Hillel (*Travels*, pp. 85-87, Madras, 1832), who was not likely to underrate the fact, and had the best means of information, gives them but 200 families. He says they are mostly in good circumstances, having fine houses and gardens, and are chiefly traders and goldsmiths. They speak the broken Turkish of the country, and have two synagogues. They derive the name of the town from 'Haman' and 'Mede,' and say that it was given to that foe of Mordecai by King Ahasuerus. In the midst of the city is a tomb which is in their charge, and which is said to be that of Mordecai and Esther. It is a plain structure of brick, consisting of a small cylindrical tower and a dome (the whole about 20 feet high), with small projections or wings on three sides. Within are two apartments—a small porch formed by one of the wings, and beyond it the tomb-chamber, which is a plain room paved with glazed tiles. In the midst, over the spots where the dead are supposed to lie, are two large wooden frames or chests, shaped like sarcophagi, with inscriptions in Hebrew and flowers carved upon them. There is another inscription on the wall, in bas-relief, which, as translated by Sir Gore Ouseley, describes the present tomb as having been built over the graves of Mordecai and Esther by two devout Jews of Kashan, in A.M. 4174. The original structure is said to have been destroyed when Hamadan was sacked by Timour. As Ecbatana was then the summer residence of the Persian court, it is probable enough that Mordecai and Esther died and were buried there; and traditional testimony, taken in connection with this fact, and with such a monument in a place where Jews have been permanently resident, is better evidence than is usually obtained for the allocation of ancient sepulchres. The tomb is in charge of the Jews, and is one of their places of pilgrimage. Kinneir, Ker Porter, Morier, Frazer, and Southgate furnish the best accounts of modern Hamadan.

History mentions another Ecbatana, in Palestine, at the foot of Mount Carmel, towards Ptolemais, where Cambyes died (Herod. iii. 64; Plin. v. 19). It is not mentioned by this or any similar name in the Hebrew writings: and we are at a loss to discover the grounds which Major Rawlinson says exist for concluding that there was a treasury in this position (*Geogr. Journ.* x. 134).

ACHIOR (אֲחִיּוֹר; Sept. Ἀχίωρ), a valley between Jericho and Ai, which received this name (signifying *trouble*) from the trouble brought upon the Israelites by the sin of Achan (Josh. ii. 24) [ACHAN].

ACHSAH (אֲחִסָּה, *an anklet*; Sept. Ἀχσά), the daughter of Caleb, whose hand her father offered in marriage to him who should lead the attack on the city of Debir, and take it. The prize was won by his nephew Othniel; and as the bride was conducted with the usual ceremony to her future home, she alighted from her ass, and sued her father for an addition of springs of water to her dower in lands. It is probable that custom rendered it unusual, or at least ungracious, for a request tendered under such circumstances by a daughter to be refused; and Caleb, in accordance with her wish, bestowed upon her 'the upper and the nethersprings' (Josh. xv. 16-19; Judg. i. 9-15).

ACHSHAPH (אֲחִשָּׁפַח; Sept. Ἀχσάφ, Ἀχσάφ, and Ἀχ(φ), a royal city of the Canaanites (Josh. xi. 1), has been supposed by many to be the same as Achziv, both being in the tribe of Asher. But a careful consideration of Josh. xix. 25 and 29, will make it probable that the places were different. There is more reason in the conjecture (Hamelsveld, iii. 237) that Achshaph was another name for Accho or Acre, seeing that Accho otherwise does not occur in the list of towns in the lot of Asher, although it is certain, from Judg. i. 31, that Accho was in the portion of that tribe.

ACHU (אֲחֻ; Sept. Ἀχ), This word occurs in Job viii. 11, where it is said, 'Can the rush grow up without mire? can the FLAG grow without water?' Here *flag* stands for *achu*; which would seem to indicate some specific plant, as *gome*, or rush, in the first clause of the sentence, may denote the papyrus. *Achu* occurs also twice in Gen. xli. 2, 18, 'And, behold, there came up out of the river seven well-favoured kine and fat-fleshed, and they fed in a meadow:' here it is rendered *meadow*, and must, therefore, have been considered by our translators as a general, and not a specific term. In this difficulty it is desirable to ascertain the interpretation put upon the word by the earlier translators. Dr. Harris has already remarked that 'the word is retained in the Septuagint, in Gen. ἐν τῷ ἄχαι; and is used by the son of Sirach, Eccles. xi. 16, ἄχι or ἄχει, for the copies vary. Jerome, in his Hebrew questions or traditions on Genesis, writes 'Achi neque Græcus sermo est, nec Latinus, sed et Hebræus ipse corruptus est.' The Hebrew vau ם and iod ם being like one another, differing only in length, the LXX., he observes, wrote אֲחִי, *achi*, for אֲחֻ, *achu*, and according to their usual custom put the Greek χ for the double aspirate אֲ (Nat. Hist. of the Bible, in 'Flag').

From the context of the few passages in which *achu* occurs, it is evident that it indicates a plant or plants which grew in or in the neighbourhood of water, and also that it or they were suitable as pasturage for cattle. Now it is generally well known that most of the plants which grow in water, as well as many of those which grow in its vicinity, are not well suited as food for cattle; some being very watery, others very coarse

in texture, and some possessed of acrid and even poisonous properties. None, therefore, of the *Algae* can be intended, nor any species of *Butomus*. The different kinds of *Juncus*, or rush, though abounding in such situations, are not suited for pasturage, and in fact are avoided by cattle. So are the majority of the *Cyperaceæ*, or sedge tribe; and also the numerous species of *Carex*, which grow in moist situations, yet yield a very coarse grass, which is scarcely if ever touched by cattle. A few species of *Cyperus* serve as pasturage, and the roots of some of them are esculent and aromatic; but these must be dug up before cattle can feed on them. Some species of scirpus, or club-rush, however, serve as food for cattle: *S. cespitosus*, for instance, is the principal food of cattle and sheep in the highlands of Scotland, from the beginning of March till the end of May. Varieties of *S. maritimus*, found in different countries, and a few of the numerous kinds of *Cyperaceæ* common in Indian pastures, as *Cyperus dubius* and *hexastachyus*, are also eaten by cattle. Therefore, if any specific plant is intended, as seems implied in what goes before, it is perhaps one of the edible species of scirpus or cyperus, perhaps *C. esculentus*, which, however, has distinct Arabic names: or it may be a true grass; some species of *panicum*, for instance, which form excellent pasture in warm countries, and several of which grow luxuriantly in the neighbourhood of water.

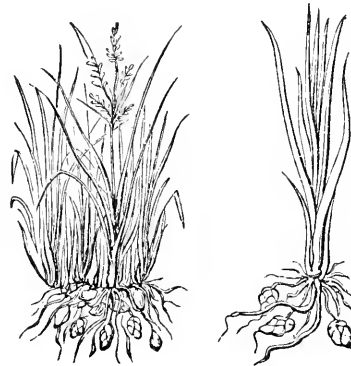

[Cyperus esculentus.]

But it is well known to all acquainted with warm countries subject to excessive drought, that the only pasturage to which cattle can resort is a green strip of different grasses, with some sedges, which runs along the banks of rivers or of pieces of water, varying more or less in breadth according to the height of the bank, that is, the distance of water from the surface. Cattle emerging from rivers, which they may often be seen doing in hot countries, as has been well remarked by the editor of the 'Pictorial Bible' on Gen. xli. 2, would naturally go to such green herbage as intimated in this passage of Genesis, and which, as indicated in Job xviii. 2, could not grow without water in a warm dry country and climate. As no similar name is known to be applied to any plant or plants in Hebrew, endeavours have been made to find a similar one so applied in the cognate languages; and, as quoted by Dr. Harris, the learned Chapellon says, 'we have no radix for אֲחֻ

unless we derive it, as Schultens does, from the Arabic *aehi*, to bind or join together.* Hence it has been inferred that it might be some one of the grasses or sedges employed in former times, as some still are, for making ropes. But there is probably some other Arabic root which has not yet been ascertained, and which may have become obsolete; for there are numerous words in the Arabic language having reference to greenness, all of which have *akh* as a common element. Thus

أخياس *akhyas*, thickets, dark groves, places full of reeds or flags, in which animals take shelter;

أخواس *akhevas*, putting forth leaves; so *akh-zirar*, greenness, verdure; *akhchishab*, abounding in grass. These may be connected with *kah*, a common term for grass in Northern India, derived from the Persian, whence amber is called *kah-roshy*, grass-attracter. So Jerome, with reference to *achu*, says, "Cum ab eruditis quaerent, quid hic sermo significaret, audivi ab Ægyptis hoc nomine lingua eorum omne quod in palude virens nascitur appellari."—J. F. R.

ACHZIB (אֲחִזִּיב). There were two places of this name, not usually distinguished.

1. ACHZIB (Sept. Ἀρχαί), in the tribe of Asher nominally, but almost always in the possession of the Phœnicians; being, indeed, one of the places from which the Israelites were unable to expel the former inhabitants (Judg. i. 31). In the Talmud it is called CHEZIB. The Greeks called it ΕΣΤΡΙΑ, from the Aramean pronunciation אֲחִזִּיב (Ptol. v. 15); and it still survives under the name of ZIB. It is upon the Mediterranean coast, about ten miles north of Acra. It stands on an ascent close by the sea-side, and is described as a small place, with a few palm-trees rising above the dwellings (Pococke, ii. 115; Richter, p. 70; Maundrell, p. 71; Irby and Mangles, p. 196; Buckingham, ch. iii.).

2. ACHZIB (Sept. Ἀχέιβ) in the tribe of Judah (Josh. xv. 44; Mic. i. 14), of which there is no historical mention, but, from its place in the catalogue, it appears to have been in the middle part of the western border-land of the tribe, towards the Philistines. This is very possibly the Chezib (כִּזְיָב) of Gen. xxxviii. 5.

ACRA (Ἀκρά), a Greek word, signifying a *citadel*, in which sense אֲקֵרָא also occurs in the Syriac and Chaldaic. Hence the name of Acra was acquired by the eminence north of the Temple, on which a citadel was built by Antiochus Epiphanes, to command the holy place. It thus became, in fact, the *Aeropolis* of Jerusalem. Josephus describes this eminence as semicircular; and reports that when Simon Maccabæus had succeeded in expelling the Syrian garrison, he not only demolished the citadel, but caused the hill itself to be levelled, that no neighbouring site might thenceforth be higher or so high as that on which the temple stood. The people had suffered so much from the garrison, that they willingly laboured day and night, for three years, in this great work (*Antiq.* xiii. 6. 6; *Bell. Jud.* v. 4. 1). At a later period the palace of Helena, queen of Adiabene, stood on the site, which still retained the name of Acra, as did also, probably, the council-house, and the repository of the archives

(*Bell. Jud.* vi. 6. 3; see also *Descript. Urbis Ierosolymæ*, per J. Heydenum, lib. iii. cap. 2).

1. ACRABATTENE, a district or toparchy of Judæa, extending between Shechem (now Nâbulus) and Jericho, inclining east. It was about twelve miles in length. It is not mentioned in Scripture, but it occurs in Josephus (*Bell. Jud.* ii. 12. 4; iii. 3. 4, 5). It took its name from a town called Acrabi in the *Onomasticon*, s. v. Ἀκραβέβειν, where it is described as a large village, nine Roman miles east of Neapolis, on the road to Jericho. In this quarter Dr. Robinson (*Bib. Researches*, iii. 103) found a village still existing under the name of Akrahel.

2. ACRABATTENE, another district in that portion of Judæa, which lies towards the south end of the Dead Sea, occupied by the Edomites during the Captivity, and afterwards known as Idumæa. It is mentioned in 1 Macc. v. 3; *Joseph. Antiq.* xii. 8. 1. It is assumed to have taken its name from the Maaleh Akrahbim (מַעֲלֵה עֲקֵרְבִים), or *Steep of the Scorpions*, mentioned in Num. xxxiv. 4, and Josh. xv. 3, as the southern extremity of the tribe of Judah [АКРАБИМ].

ACRE. [Асчо.]

ACTS OF THE APOSTLES. This is the title of one of the canonical books of the New Testament, the fifth in order in the common arrangement, and the last of those properly of an historical character. Commencing with a reference to an account given in a former work of the sayings and doings of Jesus Christ before his ascension, its author proceeds to conduct us to an acquaintance with the circumstances attending that event, the conduct of the disciples on their return from witnessing it, the outpouring on them of the Holy Spirit according to Christ's promise to them before his crucifixion, and the amazing success which, as a consequence of this, attended the first announcement by them of the doctrine concerning Jesus as the promised Messiah and the Saviour of the World. After following the fates of the mother-church at Jerusalem up to the period when the violent persecution of its members by the rulers of the Jews had broken up their society and scattered them, with the exception of the apostles, throughout the whole of the surrounding region; and after introducing to the notice of the reader the case of a remarkable conversion of one of the most zealous persecutors of the church, who afterwards became one of its most devoted and successful advocates, the narrative takes a wider scope and opens to our view the gradual expansion of the church by the free admission within its pale of persons directly converted from heathenism and who had not passed through the preliminary stage of Judaism. The first step towards this more liberal and cosmopolitan order of things having been effected by Peter, to whom the honour of laying the foundation of the Christian church, both within and without the confines of Judaism, seems, in accordance with our Lord's declaration concerning him (Matt. xvi. 18), to have been reserved, Paul, the recent convert and the destined apostle of the Gentiles, is brought forward as the main actor on the scene. On his course of missionary activity, his successes and his sufferings, the chief interest of the narrative is thenceforward concentrated, until, having followed him to Rome, whither he had been sent as

a prisoner to abide his trial, on his own appeal, at the bar of the emperor himself, the book abruptly closes, leaving us to gather further information concerning him and the fortunes of the church from other sources.

Respecting the *authorship* of this book there can be no ground for doubt or hesitation. It is, unquestionably, the production of the same writer by whom the third of the four Gospels was composed, as is evident from the introductory sentences of both (comp. Luke i. 1-4, with Acts i. 1). That this writer was Luke has not in either case been called in question. With regard to the book now under notice tradition is firm and constant in ascribing it to Luke (Irenæus, *Adv. Hæc.* lib. i. c. 31; iii. 14; Clemens Alexandr. *Strom.* v. p. 588; Tertullian, *Adv. Marcion.* v. 2; *De Jejun.* c. 10; Origen, apud Euseb. *Hist. Eccles.* vi. 23, &c. Eusebius himself ranks this book among the *ὁμολογούμενα*, *H. E.* iii. 25). From the book itself, also, it appears that the author accompanied Paul to Rome when he went to that city as a prisoner (xxviii.). Now, we know from two epistles written by Paul at that time, that *Luke* was with him at Rome (Col. iv. 14; Phil. 24), which favours the supposition that he was the writer of the narrative of the apostle's journey to that city. The only parties in primitive times by whom this book was rejected were certain heretics, such as the Marcionites, the Severians, and the Manicheans, whose objections were entirely of a dogmatical, not of a historical nature; and indeed, they can hardly be said to have questioned the authenticity of the book; they rather cast it aside because it did not favour their peculiar views. At the same time, whilst this book was acknowledged as genuine where it was known, it does not appear to have been at first so extensively circulated as the other historical books of the New Testament; for we find Chrysostom complaining that by many in his day it was not so much as known (*Hom. i. in Act.* sub init.). Perhaps, however, there is some rhetorical exaggeration in this statement; or, it may be, as Kuinoel (*Proleg. in Acta App. Comment.* tom. iv. p. 5) suggests, that Chrysostom's complaint refers rather to a prevalent omission of the Acts from the number of books publicly read in the churches, which would, of course, lead to its being comparatively little known among the people attending those churches.

Many critics are inclined to regard the Gospel by Luke and the Acts of the Apostles as having formed originally only one work, consisting of two parts. For this opinion, however, there does not appear to be any satisfactory authority; and it is hardly accordant with Luke's own description of the relation of these two writings to each other; being called by him, the one the former and the other the latter *treatise* (*λόγος*), a term which would not be appropriate had he intended to designate by it the first and second parts of the same treatise. It would be difficult, also, on this hypothesis to account for the two, invariably and from the earliest times, appearing with *distinct titles*.

Of the greater part of the events recorded in the Acts the writer himself appears to have been witness. He is for the first time introduced into the narrative in ch. xvi. 11, where he speaks of accompanying Paul to Philippi. He then disap-

pears from the narrative until Paul's return to Philippi, more than two years afterwards, when it is stated that they left that place in company (xx. 6); from which it may be justly inferred that Luke spent the interval in that town. From this time to the close of the period embraced by his narrative he appears as the companion of the apostle. For the materials, therefore, of all he has recorded from ch. xvi. 11, to xxviii. 31, he may be regarded as having drawn upon his own recollection or on that of the apostle. To the latter source, also, may be confidently traced all he has recorded concerning the earlier events of the apostle's career; and as respects the circumstances recorded in the first twelve chapters of the Acts, and which relate chiefly to the church at Jerusalem and the labours of the apostle Peter, we may readily suppose that they were so much matter of general notoriety among the Christians with whom Luke associated, that he needed no assistance from any other merely human source in recording them. Some of the German critics have laboured hard to show that he must have had recourse to written documents, in order to compose those parts of his history which record what did not pass under his own observation, and they have gone the length of supposing the existence of a work in the language of Palestine, under the title of *מכתביו* or *מכתובתה*, of which the Apocryphal book *Πράξεις Πέτρου* or *Κήρυγμα Πέτρου*, mentioned by Clement of Alexandria and Origen, was an interpolated edition (Heinrichs, *Prolegg. in Acta App.* p. 21; Kuinoel, *Proleg.* p. 14). All this, however, is mere ungrounded supposition.* There is not the shadow of evidence that any written documents were extant from which Luke could have drawn his materials, and with regard to the alleged impossibility of his learning from traditionary report the minute particulars he has recorded (which is what these critics chiefly insist on), it is to be remembered that, in common with all the sacred writers, he enjoyed the superintending and inspiring influence of the Divine Spirit, whose office it was to preserve him from all error and to guide him into all truth.

A more important inquiry respects the *design* of the evangelist in writing this book. A prevalent popular opinion on this head is, that Luke, having in his Gospel given a history of the life of Christ, intended to follow that up by giving in the Acts a narrative of the establishment and early progress of his religion in the world. That this, however, could not have been his design is obvious from the very partial and limited view which his narrative gives of the state of things in

* This is admitted by Heinrichs: 'Quot enim et qualia fuerint illa monumenta, quo idiomate consignata, num Syriaco, Aramaeo, an Græco, quo titulo vulgata, quotusque à Luca excerpta, &c. de his quidem non certissime, sed ex conjecturarum tantummodo umbris poterit disquiri' (Heinrichs, *l. c.* p. 21). Of documents whose names, nature, language, as well as the extent to which they were used by a writer who is said to have been indebted for his materials to them, can be gathered only out of the 'shadowy regions of conjecture,' one would think no mind that is accustomed to weigh evidence would think it worth while to take any notice.

the church generally during the period through which it extends. As little can we regard this book as designed to record the official history of the apostles Peter and Paul, for we find many particulars concerning both these apostles mentioned incidentally elsewhere, of which Luke takes no notice (comp. 2 Cor. xi.; Gal. i. 17; ii. 11; 1 Pet. v. 13. See also Michaelis, *Introduction*, vol. iii. p. 328. Haenlein's *Einleitung*, th. iii. s. 159). Heinrichs, Kuinoel, and others are of opinion that no particular design should be ascribed to the evangelist in composing this book beyond that of furnishing his friend Theophilus with a pleasing and instructive narrative of such events as had come under his own personal notice, either immediately through the testimony of his senses or through the medium of the reports of others; but such a view savours too much of the lax opinions which these writers unhappily entertained regarding the sacred writers, to be adopted by those who regard all the sacred books as designed for the permanent instruction and benefit of the church universal. Much more deserving of notice is the opinion of Haenlein, with which that of Michaelis substantially accords, that 'the general design of the author of this book was, by means of his narratives, to set forth the co-operation of God in the diffusion of Christianity, and along with that, to prove, by remarkable facts, the dignity of the apostles and the perfectly equal right of the Gentiles with the Jews to a participation in the blessings of that religion' (*Einleitung*, th. iii. s. 156. Comp. Michaelis, *Introduction*, vol. iii. p. 330). Perhaps we should come still closer to the truth if we were to say that the design of Luke in writing the Acts was to supply, by select and suitable instances, an illustration of the power and working of that religion which Jesus had died to establish. In his gospel he had presented to his readers an exhibition of Christianity as embodied in the person, character, and works of its great founder; and having followed him in his narration until he was taken up out of the sight of his disciples into heaven, this second work was written to show how his religion operated when committed to the hands of those by whom it was to be announced 'to all nations, beginning at Jerusalem' (Luke xxiv. 47). In this point of view the recitals in this book present a theme that is practically interesting to Christians in all ages of the church and all places of the world; for they exhibit to us what influences guided the actions of those who laid the foundations of the church, and to whose authority all its members must defer—what courses they adopted for the extension of the church,—what ordinances they appointed to be observed by those Christians who, under their auspices, associated together for mutual edification,—and what difficulties, privations, and trials were to be expected by those who should zealously exert themselves for the triumph of Christianity. We are thus taught not by dogmatical statement, but by instructive narrative, under what sanctions Christianity appears in our world, what blessings she offers to men, and by what means her influence is most extensively to be promoted and the blessings she offers to be most widely and most fully enjoyed.

Respecting the *time* when this book was composed it is impossible to speak with certainty.

As the history is continued up to the close of the second year of Paul's imprisonment at Rome, it could not have been written before a.d. 63; it was probably, however, composed very soon after, so that we shall not err far if we assign the interval between the year 63 and the year 65 as the period of its completion. Still greater uncertainty hangs over the *place* where Luke composed it, but as he accompanied Paul to Rome, perhaps it was at that city and under the auspices of the apostle that it was prepared.

The *style* of Luke in the Acts is, like his style in his Gospel, much purer than that of most other books of the New Testament. The Hebraisms which occasionally occur are almost exclusively to be found in the speeches of others which he has reported. These speeches are indeed, for the most part, to be regarded rather as summaries than as full reports of what the speaker uttered; but as these summaries are given in the speakers' own words, the appearance of Hebraisms in them is as easily accounted for as if the addresses had been reported in full. His mode of narrating events is clear, dignified, and lively; and, as Michaelis observes, he 'has well supported the character of each person whom he has introduced as delivering a public harangue, and has very faithfully and happily preserved the manner of speaking which was peculiar to each of his orators' (*Introduction*, vol. iii. p. 332).

Whilst, as Lardner and others have very satisfactorily shown (Lardner's *Credibility*, Works, vol. i.; Biscoe, *On the Acts*; Paley's *Horæ Paulinæ*; Benson's *History of the First Planting of Christianity*, vol. ii. &c.), the *credibility* of the events recorded by Luke is fully authenticated both by internal and external evidence, very great obscurity attaches to the *chronology* of these events. Of the many conflicting systems which have been published for the purpose of settling the questions that have arisen on this head, it is impossible within such limits as those to which this article is necessarily confined, to give any minute account. As little do we feel ourselves at liberty to attempt an original investigation of the subject, even did such promise to be productive of any very satisfactory result. The only course that appears open to us is to present, in a tabular form, the dates affixed to the leading events by those writers whose authority is most deserving of consideration in such an inquiry.—(See next page.)

The majority of these dates can only be regarded as approximations to the truth, and the diversity which the above table presents shows the uncertainty of the whole matter. The results at which Mr. Greswell and Dr. Anger have arrived are, in many cases, identical, and upon the whole the earlier date which they assign to the ascension of Christ seems worthy of adoption. We cannot help thinking, however, that the interval assigned by these writers to the events which transpired between the ascension of Christ and the stoning of Stephen is much too great. The date which they assign to Paul's first visit to Jerusalem is also plainly too late, for Paul himself tells us that his flight from Damascus occurred whilst that town was under the authority of Aretas, whose tenure of it cannot be extended beyond the year 38 of the common æra (2 Cor. xi. 32. See also Neander's remarks on these in *Geschichte der Pflanzung und Leitung der Christlichen Kirche*, Bd. i.

	Usher. ¹	Pearson. ²	Michaëlis. ³	Hug. ⁴	Hæmlein. ⁵	Greswell. ⁶	Anger. ⁷
The Ascension of Christ	33	33	33	31	33	30	31
Stoning of Stephen	34	34	—	—	36	37	37
Conversion of Paul	35	35	37 ?	35	36-38	37	38
Paul's first journey to Jerusalem (Acts ix. 26)	38	38	—	38	39	41	41
James's Martyrdom, &c.	44	44	44	44	44	43	43
Paul's second journey to Jerusalem (Acts xi. 12)	44	44	44	44	44	43	44
Paul's first missionary tour	45-46	44-47	—	44	—	44	44
Paul's third journey to Jerusalem (Acts xv.)	53	49	—	52	49 ?	48	48
Paul arrives at Corinth	54	52	54 ?	53	54	50	52
Paul's fourth journey to Jerusalem (Acts xviii. 22)	56	54	—	55	54	52	54
Paul's abode at Ephesus	56-59	54-57	—	56-58	—	53-55	55-59
Paul's fifth journey to Jerusalem (Acts xxi. 17)	59	58	60	59	60	56	58
Paul arrives in Rome	63	61	63	62	63	59	61

s. 80). Perhaps the following is the true order of the events of the apostle's early career as a Christian. In Gal. ii. 1, he speaks himself of going up to Jerusalem fourteen years, or about fourteen years, after his conversion (for so we understand his words). Now this visit could not have been that recorded in Acts xv., because we cannot conceive that *after* the events detailed in that chapter Peter would have acted as Paul describes in Gal. ii. 11. We conclude, therefore, that the visit here referred to was one earlier than that mentioned in Acts xv. It must, therefore, have been that mentioned in Acts xi. 12. Now, this being at the time of the famine, its date is pretty well fixed to the year 45, or thereabouts. Subtract 14 from this, then, and we get 31 as the date of Paul's conversion, and adding to this the three years that elapsed between his conversion and his first visit to Jerusalem (Gal. i. 18), we get the year 34 as the date of this latter event. If this arrangement be not adopted, the visit to Jerusalem mentioned in Gal. ii. 1, must, for the reason just mentioned, be intercalated between the commencement of Paul's first missionary tour and his visit to Jerusalem at the time of the holding of the so-called council; so that the number of Paul's visits to that city would be *six*, instead of *five*. Schrader adopts somewhat of a similar view, only he places this additional visit between the fourth and fifth of those mentioned in the Acts (*Der Apostel Paulus*, 4 Th. Leipz. 1830-1838).

9. Of separate commentaries on the Acts of the Apostles the most valuable are the following: Limborch, *Commentarium in Acta Apostolorum*, &c. fol., Roterodami, 1711; J. E. M. Walch,

Dissert. in Acta App. 3 tom. 4to. Jena, 1756 1761; Sam. F. N. Morus, *Fersio et Explicatio Act. App.* ed. Dindorf, 2 tom. 8vo. Leips. 1794; Richard Biscoe's *History of the Acts, confirmed from other authors*, &c. 8vo. Oxford, 1829; Kuinoel, *Comment. in Acta App.* which forms the fourth vol. of his *Comment. in Libros Hist. N. T.* Leips. 1818; Heinrichs, *Acta App. perpetua Annot. illustrata*, being the third vol. of the *Nor. Test. Koppianum*. The works of Benson on the *Planting of the Christian Churches*, 3 vols. 4to.; and of Neander, *Geschichte der Leitung und Pflanzung der Christlichen Kirche durch die Apostel* (recently translated into English as part of the *Edinburgh Biblical Cabinet*), may be also viewed in the light of Commentaries on the Acts.—W. L. A.

ACTS, SPURIOUS [ΑΠΟΚΡΥΦΑ]. This term has been applied to several ancient writings pretended to have been composed by, or to supply historical facts respecting our Blessed Saviour and his disciples, or other individuals whose actions are recorded in the holy Scriptures. Of these spurious or pseudepigraphal writings several are still extant; others are only known to have existed, by the accounts of them which are to be met with in ancient authors.

ACTS OF CHRIST, SPURIOUS. Several sayings attributed to our Lord, and alleged to be handed down by tradition, may be included under this head, as they are supposed by some learned men to have been derived from histories which are no longer in existence. As explanatory of our meaning it will suffice to refer to the beautiful sentiment cited by St. Paul (Acts xx. 35), *Μακάριον ἔστι μάλλον διδόναι ἢ λαμβάνειν*, to which the term apocryphal has been sometimes applied, inasmuch as it is not contained in any of the written biographies of our Lord. This term is so applied by M. Gausson of Geneva, in his *Theopneustia* (English translation, Bagster, 1842). The learned Heinsius is of opinion that the passage is taken from some lost apocryphal book, such as that entitled, in the *Recognitions* of Clement, 'the Book of the Sayings of Christ,' or the pretended *Constitutions of the Apostles*.

¹ *Annales*. Folio. Bremæ, 1686, p. 641.
² *Annales Paulini. Opp. Posthuma.* 4to. Lond. 1688.
³ *Introduction to the New Testament*, vol. iii. p. 336.
⁴ *Einleitung*, 3te Auflage, Bd. ii. s. 307.
⁵ *Einleitung*, 2te Aufl. Bd. iii. s. 157.
⁶ *Dissertations*, &c. 5 vols. 8vo. Oxf. 1837.
⁷ *De Temporum in Actis App. Ratione.* 8vo. Lips. 1833.

Others, however, conceive that the apostle, in Acts xx. 35, does not refer to any one saying of our Saviour's in particular, but that he deduced Christ's sentiments on this head from several of his sayings and parables (see Matt. xix. 21; xxv.; and Luke xvi. 9). But the probability is that St. Paul received this passage by tradition from the other apostles.

There is also a saying ascribed to Christ to be found in the *Epistle of Barnabas*, a work at least of the second century: 'Let us resist all iniquity, and hate it;' and again, 'So they who would see me, and lay hold on my kingdom, must receive me through much suffering and tribulation:' but it is not improbable that these passages contain merely an allusion to some of our Lord's discourses.

Clemens Romanus, the third bishop of Rome after St. Peter (or the writer who passes under the name of Clement), in his *Second Epistle to the Corinthians*, ascribes the following saying to Christ:—'Though ye should be united to me in my bosom, and yet do not keep my commandments, I will reject you, and say, Depart from me, I know not whence ye are, ye workers of iniquity.' This passage seems evidently to be taken from St. Luke's gospel, xiii. 25, 26, 27.

There are many similar passages, which several eminent writers, such as Grabe, Mill, and Fabricius, have considered as derived from apocryphal gospels, but which seem with greater probability to be nothing more than loose quotations from the Scriptures, which were very common among the apostolical Fathers.

There is a saying of Christ's, cited by Clement in the same epistle, which is found in the apocryphal gospel of the Egyptians:—'The Lord, being asked when his kingdom should come, replied, *When two shall be one, and that which is without as that which is within, and the male with the female neither male nor female*' [GOSPELS, APOCRYPHAL].

We may here mention that the genuineness of the Second Epistle of Clement is itself disputed, and is rejected by Eusebius, Jerome, and others; at least Eusebius says of it, 'We know not that this is as highly approved of as the former, or that it has been in use with the ancients' (*Hist. Eccles.* iii. 38, Cruse's translation, 1842).

Eusebius, in the last chapter of the same book, states that Papias, a companion of the apostles, 'gives another history of a woman who had been accused of many sins before the Lord, which is also contained in the Gospel according to the Nazarenes.' As this latter work is lost, it is doubtful to what woman the history refers. Some suppose it alludes to the history of the woman taken in adultery; others, to the woman of Samaria. There are two discourses ascribed to Christ by Papias, preserved in Irenæus (*Adversus Hæres.* v. 33), relating to the doctrine of the Millennium, of which Papias appears to have been the first propagator. Dr. Grabe has defended the truth of these traditions, but the discourses themselves are unworthy of our blessed Lord.

There is a saying ascribed to Christ by Justin Martyr, in his *Dialogue with Trypho*, which has been supposed by Dr. Cave to have been taken from the *Gospel of the Nazarenes*. Mr. Jones conceives it to have been an allusion to a passage

in the prophet Ezekiel. The same Father furnishes us with an apocryphal history of Christ's baptism, in which it is asserted that 'a fire was kindled in Jordan.' He also acquaints us that Christ worked, when he was on earth, at the trade of a carpenter, making ploughs and yokes for oxen.

There are some apocryphal sayings of Christ preserved by Irenæus, but his most remarkable observation is, that Christ 'lived and taught beyond his fortieth, or even fiftieth year.' This he founds partly on absurd inferences drawn from the character of his mission, partly on John vii. 57, and also on what he alleges to have been John's own testimony, delivered to the presbyter of Asia. It is scarcely necessary to refute this absurd idea, which is in contradiction with all the statements in the genuine gospels. There is also an absurd saying attributed to Christ by Athenagoras, *Legat. pro Christ. aïs*, cap. 28.

There are various sayings ascribed to our Lord by Clemens Alexandrinus and several of the Fathers. One of the most remarkable is, 'Be ye skilful money-changers.' This is supposed to have been contained in the *Gospel of the Nazarenes*. Others think it to have been an early interpolation into the text of scripture. Origen and Jerome cite it as a saying of Christ's.

In Origen, *Contra Celsum* lib. i., is an apocryphal history of our Saviour and his parents, in which it is reproached to Christ that he was born in a mean village, of a poor woman who gained her livelihood by spinning, and was turned off by her husband, a carpenter. Celsus adds that Jesus was obliged by poverty to work as a servant in Egypt, where he learned many powerful arts, and thought that on this account he ought to be esteemed as a god. There was a similar account contained in some apocryphal books extant in the time of St. Augustine. It was probably a Jewish forgery. Augustine, Epiphanius, and others of the Fathers equally cite sayings and acts of Christ, which they probably met with in the early apocryphal gospels.

There is a spurious hymn of Christ's extant, ascribed to the Priscillianists by St. Augustine. There are also many such acts and sayings to be found in the *Koran* of Mahomet, and others in the writings of the Mohammedan doctors (see Toland's *Nazarenus*).

There is a prayer ascribed to our Saviour by the same persons, which is printed in Latin and Arabic in the learned Selden's *Commentary on Eutyphius's Annals of Alexandria*, published at Oxford, in 1650, by Dr. Pococke. It contains a petition for pardon of sin, which is sufficient to stamp it as a forgery.

We must not omit to mention here the two curious acts of Christ recorded, the one by Eusebius, and the other by Evagrius. The first of these included a letter said to have been written to our Saviour by Agbarus (or Abgarus), king of Edessa, requesting him to come and heal a disease under which he laboured. The letter, together with the supposed reply of Christ, are preserved by Eusebius. This learned historian asserts that he obtained the documents, together with the history, from the public registers of the city of Edessa, where they existed in his time in the Syriac language, from which he translated them into Greek.

These letters are also mentioned by Ephraim Syrus, deacon of Edessa, at the close of the fourth century. Jerome refers to them in his comment on Matt. x., and they are mentioned by Pope Gelasius, who rejects them as spurious and apocryphal. They are, however, referred to as genuine by Evagrius and later historians. Among modern writers the genuineness of these letters has been maintained by Dr. Parker, in the preface to his *Demonstration of the Law of Nature, and the Christian Religion*, part ii. § 16, p. 235; by Dr. Cave, in his *Historia Literaria*, vol. i. p. 23; and by Grote, in his *Spiciliegium Patrum*, particularly p. 319. On the other hand, most writers, including the great majority of Roman Catholic divines, reject them as spurious. Mr. Jones, in his valuable work on the *Canonical Authority of the New Testament*, although he does not venture to deny that the Acts were contained in the public registers of the city of Edessa, yet gives it, as a probable conjecture, in favour of which he adduces some strong reasons, drawn from internal evidence, that this whole chapter (viz. the 13th of the first book) in the *Ecclesiastical History* of Eusebius is itself an interpolation. But the letters will speak for themselves:—

Copy of a Letter written by King Agbarus to Jesus, and sent to him at Jerusalem, by Ananias, the courier.

'Agbarus, prince of Edessa, sends greeting, to Jesus, the excellent Saviour, who has appeared in the borders of Jerusalem. I have heard the reports respecting thee and thy cures, as performed by thee without medicines and without the use of herbs. For, as it is said, thou caustest the blind to see again, the lame to walk, and thou clearest the lepers, and thou castest out impure spirits and demons, and thou healest those who are tormented by long disease, and thou raisest the dead. And hearing all these things of thee, I concluded in my mind one of two things: either, that thou art God, and having descended from heaven, doest these things; or else, doing them, thou art the Son of God. Therefore, now I have written, and besought thee to visit me, and to heal the disease with which I am afflicted. I have also heard that the Jews murmur against thee, and are plotting to injure thee; I have, however, a very small but noble estate, which is sufficient for us both.'

The Answer of Jesus to King Agbarus, by the courier Ananias.

'Blessed art thou, O Agbarus, who, without seeing, hast believed in me. For it is written concerning me, that they who have seen will not believe, that they who have not seen may believe, and live. But in regard to what thou hast written, that I should come to thee, it is necessary that I should fulfil all things here, for which I am sent, and after their fulfilment, then to be received again by him that sent me; and after I have been received up, I will send to thee a certain one of my disciples, that he may heal thy affliction, and give life to thee and those who are with thee' [EPISTLES, SPURIOUS].

The other apocryphal history related by Evagrius, out of Procopius, states that Agbarus sent a limner to draw the picture of our Saviour, but that not being able to do it by reason of the brightness of Christ's countenance, our Saviour 'took a cloth, and laying it upon his divine and life-giving face, he impressed his likeness on it.' This

story of Christ's picture is related by several, in the Second Council of Nice, and by other ancient writers, one of whom (Leo) asserts that he went to Edessa, and saw 'the image of Christ, not made with hands, worshipped by the people.' This is the first of the four likenesses of Christ mentioned by ancient writers. The second is that said to have been stamped on a handkerchief by Christ, and given to Veronica, who had followed him to his crucifixion. The third is the statue of Christ, stated by Eusebius to have been erected by the woman whom he had cured of an issue of blood, and which the learned historian acquaints us he saw at Casarea Philippi (Eusebius, *Hist. Eccles.* vii. 18). Sozomen and Cassiodorus assert that the emperor Julian took down this statue and erected his own in its place. It is, however, stated by Asterius, a writer of the fourth century, that it was taken away by Maximinus, the predecessor of Constantine. The fourth picture is one which Nicodemus presented to Gamaliel, which was preserved at Berytus, and which having been crucified and pierced with a spear by the Jews, there issued out from the side blood and water. This is stated in a spurious treatise concerning the passion and image of Christ, falsely ascribed to Athanasius. Eusebius the historian asserts (*loc. cit.*) that he had here seen the pictures of Peter, Paul, and of Christ himself, in his time (see also Sozomen, *Hist. Eccles.* v. 21).

ACTS OF THE APOSTLES, SPURIOUS.

Of these several are extant, others are lost, or only fragments of them are come down to us.

Of the following we know little more than that they once existed. They are here arranged chronologically:—*The Preaching of Peter*, referred to by Origen, in his *Commentary on St. John's Gospel*, lib. xiv.; also referred to by Clemens Alexandrinus.—*The Acts of Peter*, supposed by Dr. Cave to be cited by Serapion.—*The Acts of Paul and Thecla*, mentioned by Tertullian, *Lib. de Baptismo*, cap. xvii.: this is, however, supposed by some to be the same which is found in a Greek MS. in the Bodleian Library, and has been published by Dr. Grabe, in his *Spicil. Petrum Secl. I.*—*The Doctrine of Peter*, cited by Origen, 'Proem.' in *Lib. de Princip.*—*The Acts of Paul*, *ib. de Princip.* i. 2.—*The Preaching of Paul*, referred to by St. Cyprian, *Tract. de non iterando Baptismo.*—*The Preaching of Paul and Peter at Rome*, cited by Lactantius, *De vera Sap.* iv. 21.—*The Acts of Peter*, thrice mentioned by Eusebius, *Hist. Eccles.* iii. 3: 'as to that work, however, which is ascribed to him, called "The Acts" and the "Gospel according to Peter," we know nothing of their being handed down as Catholic writings, since neither among the ancient nor the ecclesiastical writers of our own day has there been one that has appealed to testimony taken from them.'—*The Acts of Paul*, *ib.*—*The Revelation of Peter*, *ib.*—*The Acts of Andrew and John*, *ib.* cap. 25. Thus, he says, 'we have it in our power to know . . . those books that are adduced by the heretics, under the name of the apostles, such, viz. as compose the gospels of Peter, Thomas, and Matthew, . . . and such as contain the Acts of the Apostles by Andrew and John, and others of which no one of those writers in the ecclesiastical succession has condensed to make any mention in his works; and, indeed, the character of the style it-

self is very different from that of the apostles, and the sentiments and the purport of those things that are advanced in them, deviating as far as possible from sound orthodoxy, evidently proves they are the fictions of heretical men; whence they are to be ranked not only among the spurious writings, but are to be rejected as altogether absurd and impious.—*The Acts of Peter, John, and Thomas*. Athanasius, *Synops.* § 76.—*The Writings of Bartholomew the Apostle*, mentioned by the pseudo-Dionysius.—*The Acts, Preaching, and Revelation of Peter*, cited by Jerome, in his *Catal. Script. Eccles.*—*The Acts of the Apostles by Seleucus*, ib. *Epist. ad Chrom.*, &c.—*The Acts of Paul and Thecla*, ib. *Catalog. Script. Eccles.*—*The Acts of the Apostles, used by the Ebionites*, cited by Epiphanius, *Adversus Hæres.* § 16.—*The Acts of Leucius, Lentius, or Lenticus*, called the Acts of the Apostles, Augustin. *Lib. de Fid.* c. 38.—*The Acts of the Apostles, used by the Manichees.*—*The Revelations of Thomas, Paul, Stephen, &c.* Gelasius, *de Lib. Apoc. apud Gratian. Distinct.* 15. c. 3.

To these may be added the *genuine Acts of Pilate*, appealed to by Tertullian and Justin Martyr, in their *Apologies*, as being then extant. Tertullian describes them as ‘the records which were transmitted from Jerusalem to Tiberius concerning Christ.’ He refers to the same for the proof of our Saviour’s miracles.

The following is a catalogue of the principal spurious Acts still extant:—*The Creed of the Apostles.*—*The Epistles of Barnabas, Clement, Ignatius, and Polycarp.*—*The Recognitions of Clement, or the Travels of Peter.*—*The Shepherd of Hermas.*—*The Acts of Pilate* (spurious), or the Gospel of Nicodemus.—*The Acts of Paul, or the Martyrdom of Thecla.*—Abdias’s *History of the Twelve Apostles.*—*The Constitutions of the Apostles.*—*The Canons of the Apostles.*—*The Liturgies of the Apostles.*—*St. Paul’s Epistle to the Laodiceans.*—*St. Paul’s Letters to Seneca.* Together with some others, for which see Cotelerius’s *Ecclesiæ Græcæ Monumenta*, Paris, 1677-92; Fabricius, *Codex Apocryphus*, N. T.; Du Pin, *History of the Canon of the New Testament*, London, 1699; Grabe’s *Spicilegium Patrum*, Oxford, 1714; Lardner’s *Credibility*, &c.; Jones’s *New and Just Method of Settling the Canonical Authority of the New Testament*; Birell’s *Tractatus*, Hafniae, 1804; Thilo’s *Acta St. Thomæ*, Lips. 1823, and *Codex Apocryphus N. T.*, Lips. 1832.—W. W.

ADAD is the name of the chief deity of the Syrians, the sun, according to Macrobius, whose words are (*Saturnal.* i. 23): ‘Accipe quid Assyrii de Solis potentia opinantur; deo enim, quem summum maximumque venerantur, Adad nomen dederunt. Ejus nominis interpretatio significat unus. . . . Simulacrum, Adad insigne cernitur radiis inclinat, quibus monstratur vim cæli in radiis esse Solis, qui demittuntur in terram.’ Moreover, Pliny (*Hist. Nat.* xxxvii. 11, 71), speaking of remarkable stones named after parts of the body, mentions some called ‘Adadunephros, ejusdem oculis ac digitis dei;’ and adds, ‘et hic colitur a Syris.’ He is also called Ἄδαδος βασιλεὺς θεῶν by Philo *Byblius* (in Eusebii *Præpar. Evan.* i. 10), where the occurrence of the long o for a is to be ascribed to the characteristic pronunciation of the Western Ara-

mæan dialect. The passage of Hesychius which Harduin adduces in his note to Pliny, concerning the worship of this god by the Phrygians, only contains the name Ἄδαδος by an emendation of Salmasius, which Jablonski declares to be inadmissible (*De Ling. Lycæonica*, p. 64).

This Syrian deity claims some notice here, because his name is most probably an element in the names of the Syrian kings Benhadad and Hadadezer. Moreover, several of the older commentators have endeavoured to find this deity in Isaiah lvi. 17; either by altering the text there to suit the name given by Macrobius; or by adapting the name he gives to his *interpretation* and to the reading of the Hebrew, so as to make that extract bear testimony to a god *Achad*. Michaelis has argued at some length against both these views: and the modern commentators, such as Gesenius, Hitzig, Böttcher (in *Proben Alttest. Schrifterklär.*), and Ewald, do not admit the name of any deity in that passage.—J. N.

ADAD-RIMMON, properly HADAD-RIMMON (הַדָּדִים הַרִמּוֹן; Sept. ῥόδων, a garden of pomegranates), a city in the valley of Jezreel, where was fought the famous battle between King Josiah and Pharaoh-Necho (2 Kings xxiii. 29; Zech. xii. 11). Adad-rimmon was afterwards called Maximianopolis, in honour of the emperor Maximian (Jerome, *Comment. in Zach.* xii.). It was seventeen Roman miles from Cæsarea, and ten miles from Jezreel (*Itin. Hieros.*).

ADAH (אֲדָה, adornment, comeliness; Sept. Ἄδα): 1. one of the wives of Lamech (Gen. iv. 19). 2. one of the wives of Esau, daughter of Elon the Hittite (Gen. xxxvi. 4). She is called Judith in Gen. xxvi. 34.

ADAM (אָדָם), the word by which the Bible designates the first human being.

It is evident that, in the earliest use of language, the vocal sound employed to designate the first perceived object, of any kind, would be an appellative, and would be formed from something known or apprehended to be a characteristic property of that object. The word would, therefore, be at once the appellative and the proper name. But when other objects of the same kind were discovered, or subsequently came into existence, difficulty would be felt; it would become necessary to guard against confusion, and the inventive faculty would be called upon to obtain a discriminative term for each and singular individual, while some equally appropriate term would be fixed upon for the whole kind. Different methods of effecting these two purposes might be resorted to, but the most natural would be to retain the original term in its simple state, for the first individual: and to make some modification of it by prefixing another sound, or by subjoining one, or by altering the vowel or vowels in the body of the word, in order to have a term for the kind, and for the separate individuals of the kind.

This reasoning is exemplified in the first applications of the word before us: (Gen. i. 26), ‘Let us make man [Adam] in our image;’ (i. 27), ‘And God created the man [the Adam] in his own image.’ The next instance (ii. 7) expresses the source of derivation, a character or property, namely, the material of which the human body was formed: ‘And the Lord God [Jehovah

Elohim] formed the man [the Adam] dust from the ground [the adamah]. The meaning of the primary word is, most probably, any kind of reddish tint, as a beautiful human complexion (Lam. iv. 7); but its various derivatives are applied to different objects of a red or brown hue, or approaching to such. The word *Adam*, therefore, is an appellative noun made into a proper one. It is further remarkable that, in all the other instances in the second and third chapters of Genesis, which are nineteen, it is put with the article, *the man*, or *the Adam*. It is also to be observed that, though it occurs very frequently in the Old Testament, and though there is no grammatical difficulty in the way of its being declined by the dual and plural terminations and the pronominal suffixes (as its derivative אָדָם, *dam*, blood, is), yet it never undergoes those changes; it is used abundantly to denote *man* in the general and collective sense—*mankind*, *the human race*, but it is never found in the plural number. When the sacred writers design to express *men* distributively, they use either the compound term, *sons of men* (בְּנֵי אָדָם, *benei adam*), or the plural of אָנוּשׁ *enosh*, or אִישׁ *ish*.

The question arises, Was the uttered sound, originally employed for this purpose, the very vocable *Adam*, or was it some other sound of correspondent signification? This is equivalent to asking, what was the primitive language of men?

That language originated in the instinctive cries of human beings herding together in a condition like that of common animals, is an hypothesis which, apart from all testimony of revelation, must appear unreasonable to a man of serious reflection. There are other animals, besides man, whose organs are capable of producing articulate sounds, through a considerable range of variety, and distinctly pronounced. How, then, is it that parrots, jays, and starlings have not among themselves developed an articulate language, transmitted it to their successive generations, and improved it, both in the life-time of the individual and in the series of many generations? Those birds never attempt to speak till they are compelled by a difficult process on the part of their trainers, and they never train each other.

Upon the mere ground of reasoning from the necessity of the case, it seems an inevitable conclusion that not the capacity merely, but the actual use of speech, with the corresponding faculty of promptly understanding it, was given to the first human beings by a superior power: and it would be a gratuitous absurdity to suppose that power to be any other than the Almighty Creator. In what manner such communication or infusion of what would be equivalent to a habit took place, it is in vain to inquire; the subject lies beyond the range of human investigation: but, from the evident exigency, it must have been instantaneous, or nearly so. It is not necessary to suppose that a copious language was thus bestowed upon the human creatures in the first stage of their existence. We need to suppose only so much as would be requisite for the notation of the ideas of natural wants and the most important mental conceptions; and from these, as germs, the powers of the mind and the faculty of vocal designation would educe new words and combinations as occasion demanded

That the language thus formed continued to be the universal speech of mankind till after the deluge, and till the great cause of diversity [LANGUAGE] took place, is in itself the most probable supposition. If there were any families of men which were not involved in the crime of the Babel-builders, they would almost certainly retain the primeval language. The longevity of the men of that period would be a powerful conservative of that language against the slow changes of time. That there were such exceptions seems to be almost an indubitable inference from the fact that Noah long survived the unholy attempt. His faithful piety would not have suffered him to fall into the snare; and it is difficult to suppose that none of his children and descendants would listen to his admonitions, and hold fast their integrity by adhering to him: on the contrary, it is reasonable to suppose that the habit and character of piety were established in many of them.

The confusion of tongues, therefore, whatever was the nature of that judicial visitation, would not fall upon that portion of men which was the most orderly, thoughtful, and pious, among whom the second father of mankind dwelt as their acknowledged and revered head.

If this supposition be admitted, we can have no difficulty in regarding as the mother of languages, not indeed the Hebrew, absolutely speaking, but that which was the stock whence branched the Hebrew, and its sister tongues, usually called the Shemitic, but more properly, by Dr. Prichard, the Syro-Arabian. It may then be maintained that the actually spoken names of Adam and all the others mentioned in the ante-diluvian history were those which we have in the Hebrew Bible, very slightly and not at all essentially varied.

On the other hand, some of the greatest names in the study and comparison of languages maintain that 'the primeval language has not been anywhere preserved, but that fragments of it must, from the common origin of all, everywhere exist; that these fragments will indicate the original derivation and kindredship of all; and that some direct causation of no common agency has operated to begin, and has so permanently affected mankind as to establish, a striking and universally experienced diversity' (Mr. Sharon Turner 'On the Languages of the World,' &c., in the *Transactions of the Royal Society of Literature*, the volumes published in 1827 and 1834). We take this citation from Dr. Bosworth's Anglo-Saxon Dictionary, Pref. p. iii., where that eminent scholar and antiquary seems tacitly to intimate his concurrence with Mr. Turner, and subjoins,— 'A gentleman, whose erudition is universally acknowledged, and whose opinion, from his extensive lingual knowledge and especially from his critical acquaintance with the Oriental tongues, deserves the greatest attention, has come to this conclusion; for he has stated, "The original language, of which the oldest daughter is the Sanskrit, the fruitful mother of so many dialects, exists no longer" (Prof. Hamaker's *Academische Voorlezingen*, Leyden, 1835).

Upon this hypothesis it will follow that a knowledge of the proper names of the first human family, and of all down to the times of Abraham, is absolutely unattainable; and that the Hebrew designations which we possess are not echoes of the

sounds, but representatives or translations of their signification. We acknowledge that the former seems to us the more probable opinion.

That men and other animals have existed from eternity, by each individual being born of parents and dying at the close of his period, that is, by an infinite succession of finite beings, has been asserted by some: whether they really believed their own assertion may well be doubted. Others have maintained that the first man and his female mate, or a number of such, came into existence by some spontaneous action of the earth or the elements, a chance-combination of matter and properties, without an intellectual designing cause. We hold these notions to be unworthy of a serious refutation. An upright mind, upon a little serious reflection, must perceive their absurdity, self-contradiction, and impossibility. To those who may desire to see ample demonstration of what we here assert, we recommend Dr. Samuel Clarke *On the Being and Attributes of God*; Mr. Samuel Drew's *Essays*; or an admirable work not known in a manner corresponding to its worth, *Discourses on Atheism*, by the Rev. Thomas Allin, 1828.

It is among the clearest deductions of reason, that men and all dependent beings have been created, that is, produced or brought into their first existence by an intelligent and adequately powerful being. A question, however, arises of great interest and importance. Did the Almighty Creator produce only one man and one woman, from whom all other human beings have descended?—or did he create several parental pairs, from whom distinct stocks of men have been derived? The affirmative of the latter position has been maintained by some, and, it must be confessed, not without apparent reason. The manifest and great differences in complexion and figure, which distinguish several races of mankind, are supposed to be such as entirely to forbid the conclusion that they have all descended from one father and one mother. The question is usually regarded as equivalent to this: whether there is only one species of men, or there are several. But we cannot, in strict fairness, admit that the questions are identical. It is hypothetically conceivable that the Adorable God might give existence to any number of creatures, which should all possess the properties which characterize identity of species, even without such differences as constitute varieties, or with any degree of those differences. A learned German divine, Dr. de Schrank, thinks it right to maintain that, of all organized beings besides man, the Creator gave existence to innumerable individuals, of course in their proper pairs (*Comm. in Gen.* p. 69, Sulzbach, 1835). His reason probably is, that otherwise there would not be a provision of food: but whether the conjecture be admitted or not, it is plain that it involves no contradiction, and that therefore distinct races of men might have been created, differing within certain limits, yet all possessing that which physiologists lay down as the only proper and constant character, the perpetuity of propagation.

But the admission of the possibility is not a concession of the reality. So great is the evidence in favour of the derivation of the entire mass of human beings from one pair of ancestors, that it has obtained the suffrage of the men most com-

petent to judge upon a question of comparative anatomy and physiology. The late illustrious Cuvier and Blumenbach, and our countryman Mr. Lawrence, are examples of the highest order. But no writer has a claim to deference upon this subject superior to that of Dr. J. C. Prichard. He has devoted a large work, which is still in the progress of publication, to this subject and others allied to it—*Researches into the Physical History of Mankind*, 3 volumes, and one more at least to come, 1836-1841: also another work, just completed—*The Natural History of Man*, 1842. In the Introductory Observations contained in the latter work we find a passage which we cite as an example of that noble impartiality and disregard of even sacred prepossessions with which the author has pursued his laborious investigation: 'I shall not pretend that in my own mind I regard the question now to be discussed as one of which the decision is indifferent either to religion or to humanity. But the strict rule of scientific scrutiny exacts, according to modern philosophers, in matters of inductive reasoning, an exclusive homage. It requires that we should close our eyes against all presumptive and extrinsic evidence, and abstract our minds from all considerations not derived from the matters of fact which bear immediately on the question. The maxim we have to follow in such controversies is, *fat justitia, ruat cælum*. In fact, what is actually true, it is always most desirable to know, whatever consequences may arise from its admission.'

The animals which render eminent services to man, and peculiarly depend upon his protection, are widely diffused—the horse, the dog, the hog, the domestic fowl. Now of these the varieties in each species are numerous and different, to a degree so great, that an observer ignorant of physiological history would scarcely believe them to be of the same species. But man is the most widely diffused of any animal. In the progress of ages and generations, he has naturalized himself to every climate, and to modes of life which would prove fatal to an individual man suddenly transferred from a remote point of the field. The alterations produced affect every part of the body, internal and external, without extinguishing the marks of the specific identity. A further and striking evidence is, that when persons of different varieties are conjugally united, the offspring, especially in two or three generations, becomes more prolific, and acquires a higher perfection in physical and mental qualities than was found in either of the parental races. From the deepest African black to the finest Caucasian white, the change runs through imperceptible gradations; and, if a middle hue be assumed, suppose some tint of brown, all the varieties of complexion may be explained upon the principle of divergence influenced by outward circumstances. The conclusion may be fairly drawn, in the words of the able translators and illustrators of Baron Cuvier's great work:—'We are fully warranted in concluding, both from the comparison of man with inferior animals, so far as the inferiority will allow of such comparison, and, beyond that, by comparing him with himself, that the great family of mankind loudly proclaim a descent, at some period or other, from one common origin.' (*Animal Kingdom*, with the Supplements of Mr. E.

Griffith, Col. Hamilton Smith, and Mr. Pidgeon, vol. i. p. 179).

Thus, by an investigation totally independent of historical authority, we are brought to the conclusion of the inspired writings, that the Creator 'hath made of one blood all nations of men, for to dwell on all the face of the earth' (Acts xvii. 26).

We shall now follow the course of those sacred documents in tracing the history of the first man, persuaded that their right interpretation is a sure basis of truth. At the same time we shall not reject illustrations from natural history and the reason of particular facts.

It is evident upon a little reflection, and the closest investigation confirms the conclusion, that the first human pair must have been created in a state equivalent to that which all subsequent human beings have had to reach by slow degrees, in growth, experience, observation, imitation, and the instruction of others: that is, a state of prime maturity, and with an infusion, concretion, or whatever we may call it, of knowledge and habits, both physical and intellectual, suitable to the place which man had to occupy in the system of creation, and adequate to his necessities in that place. Had it been otherwise, the new beings could not have preserved their animal existence, nor have held rational converse with each other, nor have paid to their Creator the homage of knowledge and love, adoration and obedience; and reason clearly tells us that the last was the noblest end of existence. Those whom unhappy prejudices lead to reject revelation must either admit this, or must resort to suppositions of palpable absurdity and impossibility. If they will not admit a direct action of Divine power in creation and adaptation to the designed mode of existence, they must admit something far beyond the miraculous, an infinite succession of finite beings, or a spontaneous production of order, organization, and systematic action, from some unintelligent origin. The Bible coincides with this dictate of honest reason, expressing these facts in simple and artless language, suited to the circumstances of the men to whom revelation was first granted. That this production in a mature state was the fact with regard to the vegetable part of the creation, is declared in Gen. ii. 4, 5: 'In the day of Jehovah God's making the earth and the heavens, and every shrub of the field before it should be in the earth, and every herb of the field before it should bud.' The reader sees that we have translated the verbs (which stand in the Hebrew future form) by our potential mood, as the nearest in correspondence with the idiom called by Dr. Nordheimer the 'Dependent Use of the Future' (*Critical Grammar of the Heb. Lang.*, vol. ii. p. 186; New York, 1841). The two terms, shrubs and herbage, are put, by the common synecdoche, to designate the whole vegetable kingdom. The reason of the case comprehends the other division of organized nature; and this is applied to man and all other animals, in the words, 'Out of the ground—dust out of the ground—Jehovah God formed them.'

It is to be observed that there are two narratives at the beginning of the Mosaic records, different in style and manner, distinct and independent; at first sight somewhat discrepant, but when strictly examined, perfectly compatible, and each

one illustrating and completing the other. The first is contained in Gen. i. 1, to ii. 3; and the other, ii. 4, to iv. 26. As is the case with the Scripture history generally, they consist of a few principal facts, detached anecdotes, leaving much of necessary implication which the good sense of the reader is called upon to supply; and passing over large spaces of the history of life, upon which all conjecture would be fruitless.

In the second of these narratives we read, 'And Jehovah God formed the man [*Heb.* the Adam], dust from the ground [*הָאָדָמָה*, *haadama*], and blew into his nostrils the breath of life; and the man became a living animal' (Gen. ii. 7). Here are two objects of attention, the organic mechanism of the human body, and the vitality with which it was endowed.

The mechanical material, formed (moulded, or arranged, as an artificer models clay or wax) into the human and all other animal bodies, is called 'dust from the ground.' This would be a natural and easy expression to men in the early ages, before chemistry was known or minute philosophical distinctions were thought of, to convey, in a general form, the idea of *earthy matter*, the constituent substance of the ground on which we tread. To say, that of this the human and every other animal body was formed, is a position which would be at once the most easily apprehensible to an uncultivated mind, and which yet is the most exactly true upon the highest philosophical grounds. We now know, from chemical analysis, that the animal body is composed, in the inscrutable manner called *organization*, of carbon, hydrogen, oxygen, nitrogen, lime, iron, sulphur, and phosphorus. Now all these are mineral substances, which in their various combinations form a very large part of the solid ground.

Some of our readers may be surprised at our having translated *נֶפֶשׁ חַיָּה* *nephesh khaya* by *living animal*. There are good interpreters and preachers who, confiding in the common translation, *living soul*, have maintained that here is intimated the distinctive pre-eminence of man above the inferior animals, as possessed of an immaterial and immortal spirit. But, however true that doctrine is, and supported by abundant argument from both philosophy and the Scriptures, we should be acting unfaithfully if we were to affirm its being contained or implied in this passage. The two words are frequently conjoined in the Hebrew, and the meaning of the compound phrase will be apparent to the English reader, when he knows that our version renders it, in Gen. i. 20, 'creature that hath life;' in verse 24, 'living creature,' and so in ch. ii. 19; ix. 12, 15, 16; and in ch. i. 30, 'wherein there is life.'

This expression therefore sets before us the ORGANIC LIFE of the animal frame, that mysterious something which man cannot create nor restore, which baffles the most acute philosophers to search out its nature, and which reason combines with Scripture to refer to the immediate agency of the Almighty—'in him we live, and move, and have our being.'

The other narrative is contained in these words, 'God created man in his own image: in the image of God created he him; male and female, created he them' (Gen. i. 27). *The image* (*צֶלֶם* *tselem*, resemblance, such as a shadow bears to the object which casts it) of God is an expression which

breathes at once archaic simplicity and the most recondite wisdom: for what term could the most cultivated and copious language bring forth more suitable to the purpose? It presents to us man as made in a resemblance to the author of his being, a true resemblance, but faint and shadowy; an outline, faithful according to its capacity, yet infinitely remote from the reality: a distant form of the *intelligence, wisdom, power, rectitude, goodness, and dominion* of the Adorable Supreme. To the inferior sentient beings with which he is connected man stands in the place of God. We have every reason to think that none of them are capable of conceiving a being higher than man. All, in their different ways, look up to him as their superior; the ferocious generally flee before him, afraid to encounter his power, and the gentle court his protection and show their highest joy to consist in serving and pleasing him. Even in our degenerate state it is manifest that if we treat the domesticated animals with wisdom and kindness, their attachment is most ardent and faithful.

Thus had man the shadow of the divine *dominion and authority* over the inferior creation. The attribute of *power* was also given to him, in his being made able to convert the inanimate objects and those possessing only the vegetable life, into the instruments and the materials for supplying his wants, and continually enlarging his sphere of command.

In such a state of things *knowledge and wisdom* are implied: the one quality, an acquaintance with those substances and their changeful actions which were necessary for a creature like man to understand, in order to his safety and comfort; the other, such sagacity as would direct him in selecting the best objects of desire and pursuit, and the right means for attaining them.

Above all, *moral excellence* must have been comprised in this 'image of God;' and not only forming a part of it, but being its crown of beauty and glory. The Christian inspiration, than which no more perfect disclosure of God is to take place on this side eternity, casts its light upon this subject: for the apostle Paul, in urging the obligations of Christians to perfect holiness, evidently alludes to the endowments of the first man in two parallel and mutually illustrative epistles; '—the new man, renewed in knowledge after the image of $\text{H}\mu\mu$ that created him; the new man which, after [*κατὰ*, according to] God, is created in righteousness and true holiness' (Col. iii. 10; Eph. iv. 24).

In this perfection of faculties, and with these high prerogatives of moral existence, did human nature, in its first subject, rise up from the creating hand. The whole Scripture-narrative implies that this STATE of existence was one of correspondent *activity and enjoyment*. It plainly represents the DEITY himself as condescending to *assume a human form and to employ human speech*, in order to instruct and exercise the happy creatures whom (to borrow the just and beautiful language of the Apocryphal 'Wisdom') 'God created for incorruptibility, and made him an image of his own nature.*' The only plau-

sible objection to this is, that the condescension is too great, an objection which can be no other than a presumptuous limiting of the Divine goodness. It was the voice of reason which burst through the trammels of an infidel philosophy, when the celebrated German, Fichte, wrote, 'Who, then, educated the first human pair? A spirit bestowed its care upon them, as is laid down in an ancient and venerable original record, which, taken altogether, contains the profoundest and the loftiest wisdom, and presents those results to which all philosophy must at last return' (cited in the German Bible of Brentano, Dereser, and Scholz, vol. i., p. 16, Frankfort, 1820-1833).

The noble and sublime idea that man thus had his Maker for his teacher and guide, precludes a thousand difficulties. It shows us the simple, direct, and effectual method by which the newly formed creature would have communicated to him all the intellectual knowledge, and all the practical arts and manipulations, which were needful and beneficial for him. The universal management of the 'garden in Eden eastward' (Gen. ii. 8), the treatment of the soil, the use of water, the various training of the plants and trees, the operations for insuring future produce, the necessary implements and the way of using them;—all these must have been included in the words 'to dress it and to keep it' (ver. 15). To have gained these attainments and habits without any instruction previous or concomitant, would have required the experience of men in society and co-operation for many years, with innumerable anxious experiments, and often the keenest disappointment. If we suppose that the first man and woman continued in their primitive state but even a few weeks, they must have required some tools for 'dressing and keeping the garden:' but if not, the condition of their children, when severe labour for subsistence became necessary, presented an obvious and undeniable need. They could not do well without *iron* instruments. Iron, the most useful and the most widely diffused of all the metals, cannot be brought into a serviceable state without processes and instruments which it seems impossible to imagine could have been first possessed *except in the way of supernatural communication*. It would, in all reasonable estimation, have required the difficulties and the experience of some centuries, for men to have discovered the means of raising a sufficient heat, and the use of fluxes: and, had that step been gained, the fused iron would not have answered the purposes wanted. To render it malleable and ductile, it must be beaten, at a white heat, by long continued strokes of prodigious hammers. To *make* iron (as is the technical term) requires previous iron. If it be said that the first iron used by man was native metallic iron, of which masses have been found, the obvious reply is, not only the rarity of its occurrence, but that, when obtained, it also requires previous iron instruments to bring it into any form for use. Tubal-cain most probably lived before the death of Adam; and he acquired fame as 'a hammerer, a universal workman in brass and iron' (Gen. iv. 22). This is the most literal

* Wisd. Sol. ii. 23. ἐν ἀφθαρσίᾳ, *incorruptibility*, often denoting *immortality*. We have translated *ιδιότης*, *nature*, not being able to find

a better word. The exact meaning of the Greek is, the whole combination of characteristic peculiarities.

translation of this grammatically difficult clause. In this brief description it is evident that much is implied beyond our power of ascertaining. The necessity and importance of the greatest hammers seem to be included. Considering these instances as representatives of many similar, we are confirmed in our belief that God not only gave to the earliest human families such *knowledge* as was requisite, but the *materials* and the *instruments* without which knowledge would have been in vain.

Religious knowledge and its appropriate habits also required an immediate infusion: and these are pre-eminently comprehended in the 'image of God.' On the one hand, it is not to be supposed that the newly created man and his female companion were inspired with a very ample share of the doctrinal knowledge which was communicated to their posterity by the successive and accumulating revolutions of more than four thousand years: and, on the other, the idea of their being left in gross ignorance upon the existence and excellencies of the Being who had made them, their obligations to him, and the way in which they might continue to receive the greatest blessings from him. It is self-evident that, to have attained such a kind and degree of knowledge, by spontaneous effort, under even the favourable circumstances of a state of negative innocence, would have been a long and arduous work. But the sacred narrative leaves no room for doubt upon this head. In the primitive style it tells of God as speaking to them, commanding, instructing, assigning their work, pointing out their danger, and showing how to avoid it. All this, reduced to the dry simplicity of detail, is equivalent to saying that the Creator, infinitely kind and condescending, by the use of forms and modes adapted to their capacity, fed their minds with truth, gave them a ready understanding of it and that delight in it which constituted holiness, taught them to hold intercourse with himself by direct addresses in both praise and prayer, and gave some disclosures of a future state of blessedness when they should have fulfilled the conditions of their probation.

An especial instance of this instruction and infusion of practical habits is given to us in the narrative: 'Out of the ground Jehovah God formed every beast of the field and every fowl of the air [*Hebr.* of the heavens]; and brought them unto the man [*Hebr.* the Adam], to see what he would call them' (Gen. ii. 19). This, taken out of the style of condescending anthropomorphism, amounts to such a statement as the following: the Creator had not only formed man with organs of speech, but he taught him the use of them, by an immediate communication of the practical faculty and its accompanying intelligence; and he guided the man, as yet the solitary one of his species, to this among the first applications of speech, the designating of the animals with which he was connected, by appellative words which would both be the help of his memory and assist his mental operations, and thus would be introductory and facilitating to more enlarged applications of thought and language. We are further warranted, by the recognised fact of the anecdotal and fragmentary structure of the Scripture history, to regard this as the selected instance for exhibiting a whole kind or class of operations or

processes; implying that, in the same or similar manner, the first man was led to understand something of the qualities and relations of vegetables, earthy matters, the visible heavens, and the other external objects to which he had a relation.

The next important article in this primeval history is the creation of the human female. It has been maintained that the Creator formed Adam to be a sole creature, in some mode of androgynous constitution capable of multiplying from his own organization without a conjugate partner. This notion was advanced by Jacob (or James) Bœhmen, the Silesian 'Theosophist,' and one very similar to it has been recently promulgated by Baron Giraud (*Philosophie Catholique de l'Histoire*, Paris, 1841), who supposes that the 'deep sleep' (Gen. ii. 21) was a *moral fainting* ('*défaillance*'), the first step in departing from God, the beginning of sin, and that Eve was its personified product by some sort of divine concurrence or operation. To mention these vagaries is sufficient for their refutation. Their absurd and unscriptural character is stamped on their front. The narrative is given in the more summary manner in the former of the two documents:—'Male and female created he them' (Gen. i. 27). It stands a little more at length in a *third* document, which begins the fifth chapter, and has the characteristic heading or title by which the Hebrews designated a separate work. 'This, the book of the generations of Adam. In the day God created Adam; he made him in the likeness [דְמוּת *demuth*, a different word from that already treated upon, and which merely signifies *resemblance*] of God, male and female he created them; and he blessed them, and he called their name Adam, in the day of their being created' (ver. 1, 2). The reader will observe that, in this passage, we have translated the word for *man* as the proper name, because it is so taken up in the next following sentence.

The second of the narratives is more circumstantial: 'And Jehovah God said, it is not good the man's being alone: I will make for him a help suitable for him.' Then follows the passage concerning the review and the naming of the inferior animals; and it continues—'but for Adam he found not a help suitable for him. And Jehovah God caused a deep sleep to fall upon the man [the Adam], and he slept: and he took one out of his ribs, and closed up the flesh in its place: and Jehovah God built up the rib which he had taken from the man into a woman, and he brought her to the man: and the man said, this is the bit; bone out of my bones, and flesh out of my flesh; this shall be called woman [*ishah*], for this was taken from out of man [*ish*]' (Gen. ii. 18-23).

Two remarkable words in this passage demand attention. 'Suitable for him' (כְּנֶדְרוֹ *chenegdo*), literally, *according to his front-presence*, than which no words could better express a perfect adaptation or correspondence. That we render הַפְעָם *happaam*, the *hit*, seems strange and even vulgar; but it appears necessary to the preservation of rigorous fidelity. The word, indeed, might have acquired a secondary adverbial meaning, like our English *now*, when very emphatical and partaking of the nature of an interjection; but there is only one passage in which that signification may be pleaded, and it is there repeated—'now in the open place, now in the

streets' (Prov. vii. 12). It properly means a smart, bold, successful *stroke*, and is used to signify *hitting the precise time* of any action or requirement. In this first and primitive instance it is equivalent to saying, this is the very thing, this hits the mark, this reaches to what was desired.

This *peculiar manner* of the creation of the woman has, by some, been treated as merely a childish fable; by others, as an allegorical fiction intended to represent the close relation of the female sex to the male, and the tender claims which women have to sympathy and love. That such was the intention we do not doubt; but why should that intention be founded upon a mythic allegory? Is it not taught much better, and impressed much more forcibly, by its standing not on a fiction, but on a fact? We have seen that, under the simple archaic phrase that man was made of the 'dust of the ground,' is fairly to be understood the truth, which is verified by the analysis of modern chemistry; and, in the case of the woman, it is the same combination of materials, the same carbon, and hydrogen, and lime, and the rest; only that, in the first instance, those primordial substances are taken *immediately*, but in the second, *mediately*, having been brought into a state of organization. Let an unprejudiced mind reflect, and we think that he must see in this part of the will and working of the Almighty, at once, a simplicity gentle and tender, adapted to affect, in the strongest manner, the hearts of primitive men; and yet, a sublimity of meaning worthy of 'Jehovah of hosts,' at whose command stand all atoms and organisms, and 'who is wonderful in counsel and excellent in working.'

The form of direct speech which appears here and in every part of these most ancient writings, and is a characteristic of the Hebrew and other ancient writings, should make no difficulty. It is the natural language of lively description; and it is equal to saying, such was the wise and benevolent will of God, and such were the feelings and thoughts of Adam. The 24th verse is a comment or doctrinal application of the inspired writer; pointing out the great law of marriage as founded in the original constitution of human nature.

The next particular into which the sacred history leads us, is one which we cannot approach without a painful sense of its difficulty and delicacy. It stands thus in the authorized version: 'And they were both naked, the man and his wife; and were not ashamed' (ii. 25). The common interpretation is, that, in this respect, the two human beings, the first and only existing ones, were precisely in the condition of the youngest infants, incapable of perceiving any incongruity in the total destitution of artificial clothing. But a little reflection will tell us, and the more carefully that reflection is pursued the more it will appear just, that this supposition is inconsistent with what we have established on solid grounds, the supernatural infusion into the minds of our first parents and into their nervous and muscular faculties, of the knowledge and practical habits which their descendants have had to acquire by the long process of instruction and example. We have seen the necessity that there must have been communicated to them,

directly by their Creator, no inconsiderable measure of natural knowledge and the methods of applying it, or their lives could not have been secured; and of moral and spiritual 'knowledge, righteousness, and true holiness,' such a measure as would belong to the sinless state, and would enable them to render an intelligent and perfect worship to the Glorious Deity. It seems impossible for that state of mind and habits to exist without a correct sensibility to proprieties and decencies which infant children cannot understand or feel; and the capacities and duties of their conjugal state are implied in the narrative. Further, it cannot be overlooked that, though we are entitled to ascribe to the locality of Eden the most bland atmosphere and delightful soil, yet the action of the sun's rays upon the naked skin, the range of temperature through the day and the night, the alternations of dryness and moisture, the various labour among trees and bushes, and exposure to insects, would render some protective clothing quite indispensable.

From these considerations we feel ourselves obliged to understand the word אָרוֹם (*arom*) in that which is its *most usual* signification in the Hebrew language, as importing *not an absolute*, but a *partial or comparative* nudity. It is one of a remarkable family of words which appear to have branched off in different ways from the same root, originally אָר (or or *er*), but assuming several early forms, and producing five or six divergent participials: but they all, and especially this *arom*, are employed to denote a stripping off of the upper garment, or of some other usual article of dress, when all the habiliments were not laid aside; and this is a more frequent signification than that of entire destitution. If it be asked, Whence did Adam and Eve derive this clothing? we reply, that, as a part of the divine instruction which we have established, they were taught to take off the inner bark of some trees, which would answer extremely well for this purpose. If an objection be drawn from Gen. iii. 7, 10, 11, we reply, that, in consequence of the transgression, the clothing was disgracefully injured.

Another inquiry presents itself. How long did the state of paradisiac innocence and happiness continue? Some have regarded the period as very brief, not more even than a single day; but this manifestly falls very short of the time which a reasonable probability requires. The first man was brought into existence in the region called Eden; then he was introduced into a particular part of it, the garden, replenished with the richest productions of the Creator's bounty for the delight of the eye and the other senses; the most agreeable labour was required 'to dress and to keep it,' implying some arts of culture, preservation from injury, training flowers and fruits, and knowing the various uses and enjoyments of the produce; making observation upon the works of God, of which an investigation and designating of animals is expressly specified; nor can we suppose that there was no contemplation of the magnificent sky and the heavenly bodies: above all, the wondrous communion with the condescending Deity, and probably with created spirits of superior orders, by which the mind would be excited, its capacity enlarged, and its holy felicity continually increased. It is also to be remarked, that the narrative (Gen. ii. 19, 20) conveys the

implication that some time was allowed to elapse, that Adam might discover and feel his want of a companion of his own species, 'a help correspondent to him.'

These considerations impress us with a sense of probability, amounting to a conviction, that a period not very short was requisite for the exercise of man's faculties, the disclosures of his happiness, and the service of adoration which he could pay to his Creator. But all these considerations are strengthened by the recollection that they attach to man's solitary state; and that they all require new and enlarged application when the addition of conjugal life is brought into the account. The conclusion appears irresistible that a duration of many days, or rather weeks or months, would be requisite for so many and important purposes.

Thus divinely honoured and happy were the progenitors of mankind in the state of their creation.

The next scene which the sacred history brings before us is a dark reverse. Another agent comes into the field and successfully employs his arts for seducing Eve, and by her means Adam, from their original state of rectitude, dignity, and happiness.

Among the provisions of divine wisdom and goodness were two vegetable productions of wondrous qualities and mysterious significance; 'the tree of life in the midst of the garden, and the tree of knowledge of good and evil' (Gen. ii. 9). It would add to the precision of the terms, and perhaps aid our understanding of them, if we were to adhere strictly to the Hebrew by retaining the definite prefix: and then we have 'the tree of the life' and 'the tree of the knowledge.' Thus would be indicated the particular *life* of which the one was a symbol and instrument, and the fatal *knowledge* springing from the abuse of the other. At the same time, we do not maintain that these appellations were given to them at the beginning. We rather suppose that they were applied afterwards, suggested by the events and connection, and so became the historical names.

We see no sufficient reason to understand, as some do, 'the tree of the life,' collectively, as implying a species, and that there were many trees of that species. The figurative use of the expression in Rev. xxii. 10, where a plurality is plainly intended, involves no evidence of such a design in this literal narrative. The phraseology of the text best agrees with the idea of a single tree, designed for a special purpose, and not intended to perpetuate its kind. Though in the state of innocence, Adam and Eve might be liable to some corporal suffering from the changes of the seasons and the weather, or accidental circumstances; in any case of which occurring, this tree had been endowed by the bountiful Creator with a medicinal and restorative property, probably in the way of instantaneous miracle. We think also that it was designed for a sacramental or symbolical purpose, a representation and pledge of 'the life,' emphatically so called, heavenly immortality when the term of probation should be happily completed. Yet we by no means suppose that this 'tree of the life' possessed any intrinsic property of communicating immortality. In the latter view, it was a sign and seal of the divine promise. But, with regard to the former inten-

tion, we see nothing to forbid the idea that it had most efficacious medicinal properties in its fruit, leaves, and other parts. Such were called *trees of life* by the Hebrews (Prov. iii. 18; xi. 30; xiii. 12; xv. 4).

The 'tree of the knowledge of good and evil' might be any tree whatever; it might be of any species even yet remaining, though, if it were so, we could not determine its species, for the plain reason, that no name, description, or information whatever is given that could possibly lead to the ascertainment. One cannot but lament the vulgar practice of painters representing it as an apple-tree; and thus giving occasion to profane and silly witticisms.

Yet we cannot but think the more reasonable probability to be, that it was a tree having poisonous properties, stimulating, and intoxicating, such as are found in some existing species, especially in hot climates. On this ground, the prohibition to eat or even touch the tree was a beneficent provision against the danger of pain and death. Should any cavil at the placing of so perilous a plant in the garden of delights, the abode of sinless creatures, we reply, that virulent poisons, mineral, vegetable, and animal, though hurtful or fatal to those who use them improperly, perform important and beneficial parts in the general economy of nature.

But the revealed object of this 'tree of the knowledge of good and evil' was that which would require no particular properties beyond some degree of external beauty and fruit of an immediately pleasant taste. That object was to be a *test of obedience*. For such a purpose, it is evident that to select an indifferent act, to be the object prohibited, was necessary; as the obligation to refrain should be only that which arises simply, so far as the subject of the law can know, from the sacred will of the lawgiver. This does not, however, nullify what we have said upon the possibility, or even probability, that the tree in question had noxious qualities: for upon either the affirmative or the negative of the supposition, the subjects of this positive law, having upon all antecedent grounds the fullest conviction of the perfect rectitude and benevolence of their Creator, would see in it the simple character of a test, a means of proof, whether they would or would not implicitly confide in him. For so doing they had every possible reason; and against any thought or mental feeling tending to the violation of the precept, they were in possession of the most powerful motives. There was no difficulty in the observance. They were surrounded with a paradise of delights, and they had no reason to imagine that any good whatever would accrue to them from their seizing upon anything prohibited. If perplexity or doubt arose, they had ready access to their divine benefactor for obtaining information and direction. But they allowed the thought of disobedience to form itself into a disposition, and then a purpose.

Thus was the seal broken, the integrity of the heart was gone, the sin was generated, and the outward act was the consummation of the dire process. Eve, less informed, less cautious, less endowed with strength of mind, became the more ready victim. 'The woman, being deceived, was in the transgression; but Adam was not deceived' (1 Tim. ii. 14). He rushed knowingly

and deliberately to ruin. The offence had grievous aggravations. It was the preference of a trifling gratification to the approbation of the Supreme Lord of the universe; it implied a denial of the wisdom, holiness, goodness, veracity, and power of God; it was marked with extreme ingratitude; and it involved a contemptuous disregard of consequences, awfully impious as it referred to their immediate connection with the moral government of God, and cruelly selfish as it respected their posterity.

The instrument of the temptation was a serpent; whether any one of the existing kinds it is evidently impossible for us to know. Of that numerous order many species are of brilliant colours and playful in their attitudes and manners; so that one may well conceive of such an object attracting and fascinating the first woman. Whether it spoke in an articulate voice, like the human, or expressed the sentiments attributed to it by a succession of remarkable and significant actions, may be a subject of reasonable question. The latter is possible, and it seems the preferable hypothesis, as, without a miraculous intervention, the mouth and throat of no serpent could form a vocal utterance of words; and we cannot attribute to any wicked spirit the power of working miracles.

This part of the narrative begins with the words 'And the serpent was crafty above every animal of the field' (Gen. iii. 1). It is to be observed that this is not said of the order of serpents, as if it were a general property of them, but of that particular serpent. Had the noun been intended generically, as is often the case, it would have required to be without the substantive verb; for such is the usual Hebrew method of expressing universal propositions: of this the Hebrew scholar may see constant examples in the Book of Proverbs.

Indeed, this 'cunning craftiness, lying in wait to deceive' (Eph. iv. 14), is the very character of that malignant creature of whose wily stratagems the reptile was a mere instrument. The existence of spirits, superior to man, and of whom some have become depraved, and are labouring to spread wickedness and misery to the utmost of their power, has been found to be the belief of all nations, ancient and modern, of whom we possess information. It has also been the general doctrine of both Jews and Christians, that one of those fallen spirits was the real agent in this first and successful temptation. Of this doctrine, the declarations of our Lord and his apostles contain strong confirmation. In the same epistle in which St. Paul expresses his apprehension of some of the Corinthian Christians being seduced into error and sin, he adverts to the temptation of Eve as a monitory example: 'Lest Satan should get an advantage over us, for we are not ignorant of his devices. I fear, lest by any means, as the serpent beguiled Eve through his subtlety, so your minds should be corrupted from the simplicity that is in Christ. Such are false apostles, deceitful workers, transforming themselves into apostles of Christ; and no marvel; for even Satan himself is transformed into an angel of light' (2 Cor. ii. 11; xi. 3, 14). In the book of the Revelation the great tempter is mentioned as 'that old (*ἀρχαῖος*, *he of antiquity*) serpent, who is called the devil and the Satan, who deceiveth the whole world

(2 Cor. xii. 9; xx. 2). The language of Jesus is a very definite allusion to the guilty transaction of Eden: 'Ye are of your father the devil, and the desires of your father ye are determined (*θέλετε*) to do. He was a man-murderer (*ἀνθρωποκτόνος*) from the beginning; and in the truth he stood not, for truth is not in him. When he speaketh falsehood, out of his own (stores) he speaketh, for a liar is he, and the father of it (*i. e.* of falsehood)' (John viii. 44). The summary of these passages presents almost a history of the Fall—the tempter, his manifold arts, his serpentine disguises, his falsehood, his restless activity, his bloodthirsty cruelty, and his early success in that career of deception and destruction. The younger Rosenmüller says upon this passage, 'That it was not a natural serpent that seduced Eve, but a wicked spirit which had assumed the form of a serpent; and although Moses does not expressly say so, from the fear of affording a handle to superstition, yet it is probable that he designed to intimate as much, from the very fact of his introducing the serpent as a rational being, and speaking; also, that this opinion was universal among the nations of Central and Upper Asia, from the remotest antiquity, appears from this, that, in the system of Zoroaster, it is related that Ahriman, the chief of wicked spirits, seduced the first human beings to sin by putting on the form of a serpent' (*Schol. in Gen. iii. 1*); and he refers to Kleuker's German version of the *Zendavesta*, and his own *Ancient and Modern Oriental Country*).

The condescending Deity, who had held gracious and instructive communion with the parents of mankind, assuming a human form and adapting all his proceedings to their capacity, visibly stood before them; by a searching interrogatory drew from them the confession of their guilt, which yet they aggravated by evasions and insinuations against God himself; and pronounced on them and their seducer the sentence due. On the woman he inflicted the pains of child-bearing, and a deeper and more humiliating dependence upon her husband. He doomed the man to hard and often fruitless toil, instead of easy and pleasant labour. On both, or rather on human nature universally, he pronounced the awful sentence of death. The denunciation of the serpent partakes more of a symbolical character, and so seems to carry a strong implication of the nature and the wickedness of the concealed agent. The human sufferings threatened are all, excepting the last, which will require a separate consideration, of a remedial and corrective kind. The pains and subjection of the female sex, when they come into connection with the benignant spirit of the gospel, acquire many alleviations, and become means of much good in relative life, which reacts with a delightful accumulation of benefit upon the Christian wife, mother, daughter, sister, friend. So also human labour, in the cultivation of the various soils, in all geognostic operations, in all fabrics and machinery, in means of transit by land, and in the wonders of navigation over the ocean, which for many ages was regarded as the barrier sternly forbidding intercourse;—while these have been the occasion of much suffering, they have been always towering over the suffering, counteracting and remedying it, diminishing the evil, and increasing the sum

of good. Further, under the influence of true Christianity, these and all the other mechanical and liberal arts are consecrated to the universal improvement of mankind; they afford means of spreading the gospel, multiplying every kind of good agency and increasing its force. Thus, 'in all labour there is profit,' and 'labour itself becomes a pleasure.'

Of a quite different character are the penal denunciations upon the serpent. If they be understood literally, and of course applied to the whole order of Ophidia (as, we believe, is the common interpretation), they will be found to be so flagrantly at variance with the most demonstrated facts in their physiology and economy, as to lead to inferences unfavourable to belief in revelation. Let us examine the particulars:—

'Because thou hast done this, cursed art thou above all cattle?' very properly so rendered, for we have not an English singular noun to answer to בְּהֵמָה, so as to effect a literal translation of 'above every *behemah*.' But the serpent tribe cannot be classed with that of the *behemoth*. The word is of very frequent occurrence in the Old Testament; and though, in a few instances, it seems to be put for brevity so as to be inclusive of the flocks as well as the herds, and in poetical diction it sometimes stands metonymically for animals generally (as Job xviii. 3; Ps. lxxiii. 22; Eccles. iii. 18, 19, 21); yet its proper and universal application is to the large animals (pachyderms and ruminants), such as the elephant, camel, deer, horse, ox, rhinoceros, hippopotamus, &c. [БЕHEМОТН].

As little will the declaration, 'cursed —,' agree with natural truth. It may, indeed, be supposed to be verified in the shuddering which persons generally feel at the aspect of any one of the order of serpents; but this takes place also in many other cases. It springs from fear of the formidable weapons with which some species are armed, as few persons know beforehand which are venomous and which are harmless; and, after all, this is rather an advantage than a curse to the animal. It is an effectual defence without effort. Indeed, we may say that no tribe of animals is so secure from danger, or is so able to obtain its sustenance and all the enjoyments which its capacity and habits require, as the whole order of serpents. If, then, we decline to urge the objection from the word *behemah*, it is difficult to conceive that serpents have more causes of suffering than any other great division of animals, or even so much.

Further, 'going upon the belly' is to none of them a punishment. With some differences of mode, their progression is produced by the pushing of scales, shields, or rings against the ground, by muscular contractions and dilatations, by elastic springings, by vertical undulations, or by horizontal wriggings; but, in every variety, the *entire organization*—skeleton, muscles, nerves, integuments—is adapted to the mode of progression belonging to each species. That mode, in every variety of it, is sufficiently easy and rapid (often very rapid) for all the purposes of the animal's life and the amplitude of its enjoyments. To imagine this mode of motion to be, in any sense, a change from a prior attitude and habit of the erect kind, or being furnished with wings, indicates a perfect ignorance of the anatomy of ser-

pents. Yet it has been said by learned and eminent theological interpreters, that, before this crime was committed, the serpent probably did 'not go upon his belly, but moved upon the hinder part of his body, with his head, breast, and belly upright' (Clarke's *Bible*, p. 1690). This notion may have obtained credence from the fact that some of the numerous serpent species, when excited, raise the neck pretty high; but the posture is to strike, and they cannot maintain it in creeping except for a very short distance.

Neither do they 'eat dust.' All serpents are carnivorous: their food, according to the size and power of the species, is taken from the tribes of insects, worms, frogs, and toads, and newts, birds, mice and other small quadrupeds, till the scale ascends to the pythons and boas, which can master and swallow very large animals. The excellent writer just cited, in his anxiety to do honour, as he deemed it, to the accuracy of Scripture allusions, has said of the serpent, 'Now that he creeps with his very mouth upon the earth, he must necessarily take his food out of the dust, and so lick in some of the dust with it.' But this is not the fact. Serpents habitually obtain their food among herbage or in water; they seize their prey with the mouth, often elevate the head, and are no more exposed to the necessity of swallowing adherent earth than are carnivorous birds or quadrupeds. At the same time, it may be understood figuratively. '*Eating the dust*' is but another term for grovelling in the dust; and this is equivalent to being reduced to a condition of meanness, shame, and contempt.—See Micah vii. 17' (Bush on *Genesis*, vol. i. p. 84. New York, 1810).

But these and other inconsistencies and difficulties (insuperable they do indeed appear to us) are swept away when we consider the fact before stated, that the Hebrew הַחַשׁ הַחַיָּה *hannachash haiaah*, *the serpent was*, &c., and that it refers specifically and personally to a rational and accountable being, the *spirit of lying and cruelty, the devil, the Satan, the old serpent*. That God, the infinitely holy, good, and wise, should have permitted any one or more celestial spirits to apostatize from purity, and to be the successful seducers of mankind, is indeed an awful and overwhelming mystery. But it is not more so than the permitted existence of many among mankind, whose rare talents and extraordinary command of power and opportunity, combined with extreme depravity, have rendered them the plague and curse of the earth; and the whole merges into the awful and insoluble problem, Why has the All-perfect Deity permitted evil at all? We are firmly assured that He will bring forth, at last, the most triumphant evidence that 'He is righteous in all his ways, and holy in all his works.' In the mean time, our happiness lies in the implicit confidence which we cannot but feel to be due to the Being of Infinite Perfection.

The remaining part of the denunciation upon the false and cruel seducer sent a beam of light into the agonized hearts of our guilty first parents: 'And enmity will I put between thee and the woman, and between thy seed and her seed: he will attack thee [on] the head, and thou wilt attack him [at] the heel.' The verb here used twice, occurs in only two other places of the O. T.: Job ix. 17, 'Who breaketh upon me with a tempestuous horror;' and Ps. cxxxix. 11, 'And if

I say, Surely darkness will burst upon me,' &c. as a sudden and impervious covering. The meaning is established by Gesenius after Umbreit as the idea of a *violent and eager assault*. Christian interpreters generally regard this as the *Protevangelium*, the first gospel-promise, and we think with good reason. It was a manifestation of mercy: it revealed a Deliverer, who should be a human being, in a peculiar sense the offspring of the female, who should also, in some way not yet made known, counteract and remedy the injury inflicted, and who, though partially suffering from the malignant power, should, in the end, completely conquer it and convert its very success into its own punishment' (J. Pye Smith, *Scripture Testimony to the Messiah*, vol. i. p. 226).

The awful threatening to man was, 'In the day that thou eatest of it, thou wilt die the death.' *Beyom*, literally *in the day*, was also used as a general adverb of time, denoting *when*, without a strict limitation to a natural day. The verbal repetition is a Hebrew idiom to represent not only the *certainty* of the action, but its *intensity and efficacy*: we therefore think that the phrase *die the death* would more exactly convey the sense of the original than what some have proposed *dying thou shalt die*. The infliction is *Death* in the most comprehensive sense, that which stands opposed to *Life*, the life of not only animal enjoyment, but holy happiness, the life which comported with the image of God. This was lost by the fall; and the sentence of physical death was pronounced, to be executed in due time. Divine mercy gave a long respite.

The same mercy was displayed in still more tempering the terrors of justice. The garden of delights was not to be the abode of rebellious creatures. But before they were turned out into a bleak and dreary wilderness, God was pleased to direct them to make clothing suitable to their new and degraded condition, of the skins of animals. That those animals had been offered in sacrifice is a conjecture supported by so much probable evidence, that we may regard it as a well-established truth. Any attempt to force back the way, to gain anew the tree of life, and take violent or fraudulent possession, would have been equally impious and nugatory. The sacrifice (which all approximative argument obliges us to admit), united with the promise of a deliverer, and the provision of substantial clothing, contained much hope of pardon and grace. The terrible debarring by lightning flashes and their consequent thunder, and by visible supernatural agency (Gen. iii. 22-24), from a return to the bowers of bliss, are expressed in the characteristic patriarchal style of anthropopathy; but the meaning evidently is, that the fallen creature is unable by any efforts of his own to reinstate himself in the favour of God, and that whatever hope of restoration he may be allowed to cherish must spring solely from free benevolence. Thus, in laying the first stone of the temple which shall be an immortal habitation of the Divine glory, it was manifested that 'Salvation is of the Lord,' and that 'grace reigneth through righteousness unto eternal life.'

From this time we have little recorded of the lives of Adam and Eve. Their three sons are mentioned with important circumstances in connection with each of them. See the articles **CAIN**,

ABEL, and **SETH**. Cain was probably born in the year after the fall; Abel, possibly some years later; Seth, certainly one hundred and thirty years from the creation of his parents. After that, Adam lived eight hundred years, and had sons and daughters, doubtless by Eve, and then he died, nine hundred and thirty years old. In that prodigious period many events, and those of great importance, must have occurred; but the wise providence of God has not seen fit to preserve to us any memorial of them, and scarcely any vestiges or hints are afforded of the occupations and mode of life of men through the antediluvian period [**ANTEDILUVIANS**].—J. P. S.

2. **ADAM**, a city at some distance east from the Jordan, to which, or beyond which, the overflow of the waters of that river extended when the course of the stream to the Dead Sea was stayed to afford the Israelites a passage across its channel. Our public version follows the *keri*, or marginal reading, of Josh. iii. 16, 'very far from Adam' (אָדָם); but the *kethib*, or textual reading, is, 'in Adam' (בְּאָדָם). The former suggests that the overflow extended beyond Adam, the latter that it reached thereto. It appears from 1 Kings iv. 12; vii. 46, that Zarethan was on the west side of the Jordan, in the tribe of Manasseh: whereas certainly Adam was on the east side of that river, where the Israelites already were. The text must therefore signify that the overflow reached on the east side to Adam, and on the west to Zarethan; and it admits of the construction that the 'heap of waters' was 'beside' Zarethan and beyond Adam, instead of that Zarethan itself was 'beside Adam.' The name of the city Adam (*red*) was probably derived from the colour of the clay in the neighbourhood.

ADAMAH. [אֲדָמָה.]

ADAMANT. [שַׁמְרִית.]

ADAR (אָדָר; 'Αδάρ, Esth. iii. 7; the Macedonian *Δόστρος*) is the sixth month of the civil and the twelfth of the ecclesiastical year of the Jews. The name was first introduced after the Captivity. The following are the chief days in it which are set apart for commemoration:—The 7th is a fast for the death of Moses (Dent. xxxiv. 5, 6). There is some difference, however, in the date assigned to his death by some ancient authorities. Josephus (*Antiq.* iv. 8) states that he died on the *first* of this month; which also agrees with Midrash Megillath Esther, cited by Reland (*Antiq. Hebr.* iv. 10); whereas the Talmudical tracts *Kiddushim* and *Sota* give the *seventh* as the day. It is at least certain that the latter was the day on which the fast was observed. On the 9th there was a fast in memory of the contention or open rupture of the celebrated schools of Hillel and Shammai, which happened but a few years before the birth of Christ. The cause of the dispute is obscure (Wolf's *Biblioth. Hebr.* ii. 826). The 13th is the so-called 'Fast of Esther.' Iken observes (*Antiq. Hebr.* p. 150) that this was not an actual fast, but merely a commemoration of Esther's fast of three days (Esth. iv. 16), and a preparation for the ensuing festival. Nevertheless, as Esther appears, from the date of Haman's edict, and from the course of the narrative, to have fasted in Nisan, Buxtorf adduces from the Rabbins the following account

of the name of this fast, and of the foundation of its observance in Adar (*Synag. Jud.* p. 551): that the Jews assembled together on the 13th, in the time of Esther, and that, after the example of Moses, who fasted when the Israelites were about to engage in battle with the Amalekites, they devoted that day to fasting and prayer, in preparation for the perilous trial which awaited them on the morrow. In this sense, this fast would stand in the most direct relation to the feast of Purim. The 13th was also, 'by a common decree,' appointed as a festival in memory of the death of Nicanor (2 Macc. xv. 36). The 14th and 15th were devoted to the feast of Purim (Esth. ix. 21). In case the year was an intercalary one, when the month of Adar occurred twice, this feast was first moderately observed in the intercalary Adar, and then celebrated with full splendour in the ensuing Adar. The former of these two celebrations was then called the *lesser*, and the latter the *great Purim*. These designations do not apply, as Horne has erroneously stated (*Introduction*, iii. 177), to the two days of the festival in an ordinary year, but to its double celebration in an intercalary year.—J. N.

ADARCONIM (אָדאַר־כּוֹנִים) *i. q.* אָדאַר־כּוֹנִים; Sept. δραχμή and χρυσός; Vulg. drachma and aureus). Gesenius and most others are of opinion that these words, which occur in 1 Chron. xxix. 7; Ezra viii. 27; ii. 69; Neh. vii. 70-72, denote the *Persian Daric*, a gold coin, which must have been in circulation among the Jews during their subjection to the Persians. The א is prosthetic; and אָדַר־כּוֹנִים occurs in the Rabbin. Dr. Lee disputes the etymology of the word with Gesenius: but it is sufficient to observe that the *Daric*, which is radically included in these words, is not, as might be fancied, derived from the name of any particular king, but from the Persian دَارَا *dara*, a king. The

last of these words seems to identify itself with the Greek δραχμή; and, observing that in some of the texts it is manifestly connected with words denoting weight, and in none with names of coins, he expresses some doubt of its being the *δρακεῖδος* (*daric*) of the Greeks. He is rather inclined to suppose, with Salmasius, that the Arabic *dirhem*

درهم or درم presents us with the same word. The opinion of Heeren (*Researches*, i. 410) would, indirectly, go to discountenance the notion that the *daric* is to be here understood. He affirms that 'before the time of Darius Hystaspes the Persians had no coinage of their own, and that the *daricus* coined by him was probably a medal (Herod. iv. 166) of the finest gold. When the *darics* became current, especially after the mercenary troops were paid in them, their numbers must have been greatly augmented: yet Strabo assures us (l. xv. p. 1068) that the coin was by no means abundant among the Persians, and that gold was employed by them rather in decoration than as a circulating medium.' This, however, is of little real consequence; for it proceeds on the erroneous supposition that the coin derived its name from the first Darius, and could not have previously existed. In the later day of Strabo the coin may have become scarce, although once plentiful. Be this as it may, the *daric* is of interest, not only as the most ancient gold coin of

which any specimens have been preserved to the present day, but as the earliest coined money which, we can be sure, was known to and used by the Jews. The distinguishing mark of the coin was a crowned archer, who appears with some slight variations on different specimens. His



garb is the same which is seen in the sculptures at Persepolis, and the figure on the coin is called, in numismatics, *Sagittarius*. The specimens weighed by Dr. Bernard were fifteen grains heavier than an English guinea, and their intrinsic value may, therefore, be reckoned at twenty-five shillings (Eckhel, *Doctrina Numorum Veterum*; Bernard, *De Mensuris et Ponderibus*).

ADARGAZERIN (אָדאַר־גַּזֶּרִין). This is a Chaldean word which occurs in Dan. iii. 2, 3, where the titles of the Babylonian officers are enumerated. It is difficult, perhaps impossible, to determine the particular office which the word describes; and opinions and versions have differed greatly. The Sept., which is followed by the Vulgate, has *τίσαννοι*. Our version has 'treasurers'; and although we do not know the reason on which they proceeded, we may find one in the fact that *gaza* (גָּזָא), which seems the principal element of the word, means a treasury, and was avowedly adopted by the Greeks from the Persians. Jacchiades, who identifies all these officers with those of the Turkish court and government, compares the present to the *defterdars*, who have the charge of the receipts and disbursements of the public treasury. Gesenius and others conceive that the word means *chief-judges* (from דָּרַן, *magnificent*, and גִּזְרִין, *deciders*); but Dr. Lee, while admitting the uncertainty of the whole matter, seems to prefer seeking its meaning in the Persian *آذر* *fire*, and *گذر* *passing*; and hence concludes that the *Adargazerin* were probably officers of state who presided over the ordeals by fire, and other matters connected with the government of Babylon. This last explanation is not, however, new, being the one rejected by Gesenius.

ADASA, or ADARSA (ʾΑδασά), called also by Josephus ADAZER, ADACO, and ACODACO, a city in the tribe of Ephraim, said to have been four miles from Beth-horon, and not far from Gophna (*Joseph. Antiq.* xii. 17; Euseb. *Onomast.* in 'Αδασά). It was the scene of some important transactions in the history of the Maccabees (1 Mac. vii. 40, 45; *Joseph. Antiq.* xii. 17; *Bell. Jud.* i. 1).

ADASHIM (אָדאַשִׁים; Sept. φακός; Vulg. *lens*). 'LENTILES' is the interpretation given by our own and most other versions, and there is no reason to question its accuracy. In Syria lentiles are still called in Arabic عدس *addas* (Russel, *N. H. of Aleppo*, i. 74). Lentiles appear to have been chiefly used for making a kind of pottage. The red pottage for which Esau bar-

tered his birthright was of lentiles (Gen. xxv. 29-34). The term *red* was, as with us, extended to *yellowish brown*, which must have been the true colour of the pottage, if derived from lentiles. The Greeks and Romans also called lentiles red (see authorities in Celsius, i. 105). Lentiles were among the provisions brought to David when he fled from Absalom (2 Sam. xvii. 25), and a field of lentiles was the scene of an exploit of one of David's heroes (2 Sam. xxiii. 11). From Ezek. iv. 9, it would appear that lentiles were sometimes used as bread. This was, doubtless, in times of scarcity, or by the poor. Sonnini (*Travels*, p. 603, English translation) assures us that in southernmost Egypt, where corn is comparatively scarce, lentiles mixed with a little barley form almost the only bread in use among the poorer classes. It is called *betlan*, is of a golden yellow colour, and is not bad, although rather heavy. In that country, indeed, probably even more than in Palestine, lentiles anciently, as now, formed a chief article of food among the labouring classes. This is repeatedly noticed by ancient authors; and so much attention was paid to the culture of this useful pulse, that certain varieties became remarkable for their excellence. The lentiles of Pelusium, in the part of Egypt nearest to Palestine, were esteemed both in Egypt and foreign countries (Virg. *Georg.* i. 228); and this is probably the valued Egyptian variety which is mentioned in the *Mishna* (tit. *Kilvim*, xviii. 8) as neither large nor small. Large quantities of lentiles were exported from Alexandria (Augustin. *Comm. in Ps.* xlvi.). Pliny, in mentioning two Egyptian varieties, incidentally lets us know that one of them was red, by remarking that they like a red soil, and by speculating whether the pulse may not have thence derived the reddish colour which it imparted to the pottage made with it (*Hist. Nat.* xviii. 12). This illustrates Jacob's red pottage. Dr. Shaw (i. 257) also states that these lentiles easily dissolve in boiling, and form a red or chocolate coloured pottage, much esteemed in North Africa and Western Asia. Putting these facts together, it is likely that the reddish lentile, which is now so common in Egypt (*Descript. de l'Egypte*, xix. 65), is the sort to which all these statements refer.

The tomb-paintings actually exhibit the operation of preparing pottage of lentiles, or, as Wilkinson (*Anc. Egyptians*, ii. 387) describes it, 'a man engaged in cooking lentiles for a soup or porridge; his companion brings a bundle of faggots for the fire, and the lentiles themselves are seen standing near him in wicker baskets.' The lentiles of Palestine have been little noticed by travellers.



Nau (*Voyage Nouveau*, p. 13) mentions lentiles along with corn and pease, as a principal article of traffic at Tortoura; D'Arvieux (*Mémoires*, ii. 237) speaks of a mosque, originally a Christian church, over the patriarchal tomb at Hebron, connected with which was a large kitchen, where

lentile pottage was prepared every day, and distributed freely to strangers and poor people, in memory of the transaction between Esau and Jacob, which they (erroneously) believe to have taken place at this spot.

The lentile (*Ervum lens*) is an annual plant, and the smallest of all the leguminosæ which are cultivated. It rises with a weak stalk about eighteen inches high, having pinnate leaves at each joint composed of several pairs of narrow leaflets, and terminating in a tendril, which supports it by fastening about some other plant.



Lentiles (Cicer lens).

The small flowers, which come out of the sides of the branches on short peduncles, three or four together, are purple, and are succeeded by the short and flat legumes, which contain two or three flat round seeds slightly curved in the middle. The flower appears in May, and the seeds ripen in July. When ripe, the plants are rooted up, if they have been sown along with other plants, as is sometimes done; but they are cut down when grown by themselves. They are threshed, winnowed, and cleaned like corn.

ADBEEL, one of the twelve sons of Ishmael, and founder of an Arabian tribe (Gen. xxv. 13, 16).

ADDER, the English name of a kind of serpent, is a dialectical variation of the same word in a variety of languages of the Gothic and Teutonic family. Another name, varying, in the old European tongues, from *ag*, *ach*, to *hag*, has more connection with the Semitic; and in the south of Europe, where the Latin and its derivatives prevail, both are represented by the word *viper* (*viper*). The first radically indicates poison; the second, pain, distress, strife; the third, parturition of offspring, not in the state of an egg, but of the perfect animal. Though not clearly distinguished, in common acceptation, from innoxious snakes, all strictly indicate serpents armed with poisonous fangs, and therefore all are truly viviparous. In the English version of the Bible the name 'adder' occurs several times, and is there used not for a particular species, but generally for several of this dangerous class of reptiles, without, therefore, being intended to be confined to a *genus*, in the sense modern systematists would ascribe to that denomination. We have before us

list, far from complete, of the erpetology of Palestine, Arabia, and Egypt, in which there are, among forty-three species indicated, about eight whose bite is accompanied with a venomous effusion, and therefore almost all very dangerous. The Hebrew names applicable to them, depending upon some radical word descriptive of a property or character of the animal, are in themselves mostly insufficient to distinguish the one meant specifically; and therefore recourse must be had to the kindred dialects, and to a careful study of each species. This object is so far from being accomplished, that, in our present state of knowledge, we deem it best to discuss, under the words SERPENT and VIPER, all the Hebrew names not noticed in this article, and to refer to them those occurring in our version under the appellations of 'asp,' 'cockatrice,' &c.; and likewise to review the allusions to colossal boas and pythons, evidently meant, in some places, where the terms תן *than* and תנין *thannin* are used; and, finally, to notice water-snakes and muræne, which translators and biblical naturalists have totally overlooked,

although they must exist in the lakes of the Delta, are abundant on the north coast of Africa, and often exceed eight feet in length.

In this place we shall retain that genus alone which Laurenti and Cuvier have established upon characters distinguished from the innocuous coluber and the venomous vipera, and denominated *naja*, one of the Sanscrit forms of the same appellation whence we have the word *hag*, before noticed; and to the same root, in the Semitic tongues, we may refer the Hebrew עכשוב *ach-sub*, found in Psalm cxi. 3, and declared to be derived from a verb implying 'to bend back upon oneself'—a characteristic which most, if not all, of the species of the genus *Naja* evince. The Chaldee paraphrases render it by עכביש *acchabis*, perhaps erroneously applied to the spider, which, if we refer to several of the noxious arachnides, possesses nevertheless the faculty of springing back upon its victim, and therefore comes within the radical meaning of the term.

The genus *Naja*—Hardi (?) of Savary—is distinguished by a plaited head, large, very venomous

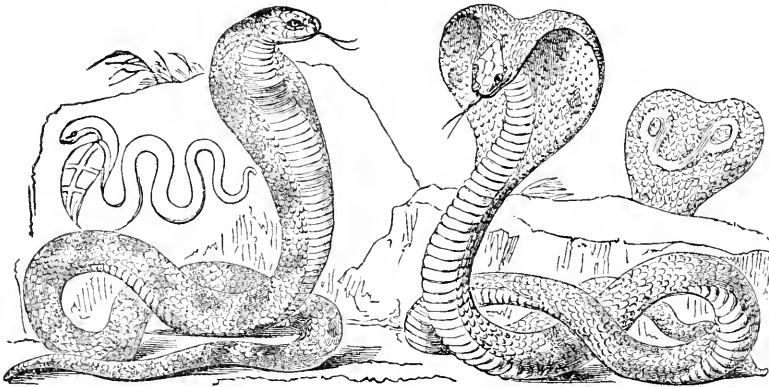

Naja Hajje; and the form of *Cneph* from the Egyptian Monuments.

Naja Tripudians and *Cobra di Capello*; or, Hooded and Spectacled Snakes.

fangs, a neck dilatable under excitement, which raises the ribs of the anterior part of the body into the form of a disk or hood, when the scales, usually not imbricated, but lying in juxtaposition, are separated, and expose the skin, which at that time displays bright iridescent gleams, contrasting highly with their brown, yellow, and bluish colours. The species attain at least an equal, if not a superior, size to the generality of the genus viper; are more massive in their structure; and some possess the faculty of self-inflation to triple their diameter, gradually forcing the body upwards into an erect position, until, by a convulsive crisis, they are said suddenly to strike backwards at an enemy or a pursuer. With such powers of destroying animal life, and with an aspect at once terrible and resplendent, it may be easily imagined how soon fear and superstition would combine, at periods anterior to historical data, to raise these monsters into divinities, and endeavour to deprecate their wrath by the blandishments of worship; and how design and cupidity would teach these very votaries the manner of subduing their ferocity, of extracting their instruments of

mischief, and making them subservient to the wonder and amusement of the vulgar, by using certain cadences of sound which affect their hearing, and exciting in them a desire to perform a kind of pleasurable movements that may be compared to dancing. Hence the *najas* of the East, the *hag-worms* of the West, and the *haje*, have all been deified, styled agathodæmon or good spirit; and figures of them occur wherever the superstition of Pagan antiquity has been accompanied by the arts of civilization.

The most prominent species of the genus at present is the *naja tripudians*, *cobra di capello*, hooded or spectacled snake of India, venerated by the natives; even by the serpent-charmers styled the good serpent to this day, and yet so ferocious that it is one of the very few that will attack a man when surprised in its haunt, although it may be gorged with prey. This species is usually marked on the nape with two round spots, transversely connected in the form of a pair of spectacles; but among several varieties, one, perhaps distinct, is without the marks, and has a glossy golden hood, which may make it identical with

the *naja haje* of Egypt, the undoubted Ith-nuphi, cnephi, or agathodæmon of ancient Egypt, and accurately represented on the walls of its temples, in almost innumerable instances, both in form and colour. This serpent also inflates the skin on the neck, not in the expanded form of a hood, but rather into an intumescence of the neck. As in the former, there is no marked difference of appearance between the sexes; but the psilli, or charmers, by a particular pressure on the neck have the power of rendering the inflation of the animal, already noticed as a character of the genus, so intense, that the serpent becomes rigid, and can be held out horizontally as if it were a rod. This practice explains what the soothsayers of Pharaoh could perform when they were opposing Moses, and reveals one of the names by which the Hebrews knew the species; for although the text (Exod. iv. 3) uses, for the rod of Aaron converted into a serpent, the word נחש *nachash*, and subsequently (vii. 15) תנין *thanin*, it is plain that, in the second passage, the word indicates 'monster,' as applied to the *nachash* just named—the first being an appellative, the second an epithet. That the rods of the magicians of Pharaoh were of the same external character is evident from no different denomination being given to them: therefore we may infer that they used a real serpent as a rod—namely, the species now called *haje*—for their imposture; since they no doubt did what the present serpent-charmers perform with the same species, by means of the temporary *asphyxiation*, or suspension of vitality, before noticed, and producing restoration to active life by liberating or throwing down. Thus we have the miraculous character of the prophet's mission shown by his real rod becoming a serpent, and the magicians' real serpents merely assuming the form of rods; and when both were opposed, in a state of animated existence, by the rod devouring the living animals, conquering the great typical personification of the protecting divinity of Egypt. *Nachash* may, therefore, with some confidence, be assumed to have been the Hebrew name, or at least one of the names, of the *naja haje*, *el haje*, and *haje nacher*, of the Arabs.* This species may be regarded as extending to India and Ceylon; and probably the *naja tripudians* is likewise an inhabitant of Arabia, if not of Egypt, although the assertion of the fact (common in authors) does not exclude a supposition that they take the two species to be only one. We are disposed to refer the 'winged' or 'flying' serpent to the *naja tripudians*, in one of its varieties, because—with its hood dilated into a kind of shining wings on each side of the neck, standing, in undulating (מעופף) motion, one-half or more erect, rigid, and fierce in attack, and deadly poisonous, yet still denominated 'good spirit,' and in Egypt ever figured in combination with the winged

* *Nachash* was intensely the serpent of serpents with the Hebrews; and when figured with the crowns or caps of Upper and Lower Egypt, was the crowned serpent and basilisk. It is evident that *nach-ash* led authors, and Pliny among the number, to affix the term *aspis* to the *haje*, which however he did not recognise as the sacred serpent of Egypt. The true asp is a small viper, notwithstanding the opinion of M. Geoffroy to the contrary.

globe—it well may have received the name of שרף *saraph*, and may thus meet all the valid objections, and conciliate seemingly opposite comments (see Num. xxi. 6, 8; Deut. viii. 15-Isa. xvi. 29; xxx. 6; and Paxton's *Illustrations*), excepting the authority of Herodotus, Pausanias, and Bochart, which, with all the respect due to their names, is not now sufficient to establish the existence of a kind of serpents whose structure is contrary to the laws of zoological organization.*

ACUSUB (עכשוב *naja* (?), *reflectrix, nobis*) is another name of a serpent which may be considered as specifically different from the former, though it is most probably one more of this group of terrible creatures. The root of the name implies bending back, recurving, but not coiling up, for all snakes have that faculty. The syllable *ach*, however, shows a connection with the former denominations; and both are perfectly reconcilable with a serpent very common at the Cape of Good Hope, not unfrequent in Western Africa, and probably extending over that whole continent, excepting perhaps Morocco. It is the 'poif-adder' of the Dutch colonists, about three feet in length, and about six inches in circumference at the middle of the body; the head is larger than is usual in serpents; the eyes are large, and very brilliant; the back beautifully marked in half circles, and the colours black, bright yellow, and dark brown; the belly yellow; the appearance at all times, but chiefly when excited, extremely brilliant; the upper jaw greatly protruding, somewhat like what occurs in the shark, places the mouth back towards the throat, and this structure is said to be connected with the practice of the animal when intending to bite, to swell its skin till it suddenly rises up, and strikes backwards as if it fell over.† It is this faculty which appears to be indicated by the Hebrew name *achusub*, and therefore we believe it to refer to that species, or to one nearly allied to it. The Dutch name (poif-adder, or spooch-adder) shows that, in the act of swelling, remarkable eructations and spittings take place, all which no doubt are so many warn-

* In Isaiah xiv. 29, and xxx. 6, the epithet מעופף *meophpeph*, 'vibrating,' (rendered 'flying' in A. V.) is another form for 'winged,' and occurs in passages unconnected with the events in Exodus. Both bear metaphorical interpretations.

A further confirmation of the 'fiery serpents,' or 'serpents of the burning bite,' being *najas*, occurs in the name Ras om Haye (Cape of the Haje serpents), situated in the locality where geographers and commentators agree that the children of Israel were afflicted by these reptiles. Should it be objected that these are the *haje*, and not the spectacle-snake, it may be answered that both Arabs and Hindoos confound the species.

† The writer is indebted for the details concerning this reptile to the kindness of Captain Stevens of the Royal Marines, who killed several; and from whom we learn the further fact that, in order to ascertain the truth of the universal report concerning the mode of striking back, ascribed to the serpent, he had a quill introduced into the vent of one lying dead on the table, and blown into. The skin distended till the body rose up nearly all its length: he then caused the experiment to stop, from the alarming attitude it assumed.

ings, the bite being fatal. The puff-adder usually resides among brushwood in stony places and rocks, is fond of basking in the sun, rather slow in moving, and is by nature timid [SERPENT; VIPER].—C. H. S.

ADDON (אָדוֹן), one of several places mentioned in Neh. vii. 61, being towns in the land of captivity, from which those who returned to Palestine were unable to 'shew their father's house, or their seed, whether they were of Israel.' This, probably, means that they were unable to furnish such undeniable legal proof as was required in such cases. And this is in some degree explained by the subsequent (v. 63) mention of priests who were expelled the priesthood because their descent was not found to be genealogically registered. These instances show the importance which was attached to their genealogies by the Jews [GENEALOGY].

ADIABENE (Ἀδιabηνή), the principal of the six provinces into which Assyria was divided. Pliny (*Hist. Nat.* v. 12) and Ammianus (xxiii. 6, § 20) comprehend the whole of Assyria under this name, which, however, properly denoted only the province which was watered by the rivers Diab and Adiab, or the Great and Little Zab (Dhab), which flow into the Tigris below Nineveh (Mosul), from the north-east. This region is not mentioned in Scripture; but in Josephus, its queen Helena and her son Izates, who became converts to Judaism, are very often named (Joseph. *Antiq.* xx. 2, 4; *Bell. Jud.* ii. 16, 19; v. 4, 6, 11).

ADIDA (Ἀδιδα; Vulg. *Addus*), a fortified town in the tribe of Judah. In 1 Macc. xii. 38, we read that Simon Maccabeus set up 'Adida in Sephela (Ἀδιδα ἐν τῇ Σεφάλα), and made it strong with bolts and bars.' Eusebius says that Sephela was the name given in his time to the open country about Eleutheropolis. And this Adida in Sephela is probably the same which is mentioned in the next chapter (xiii. 13) as 'Adida over against the plain,' where Simon Maccabeus encamped to dispute the entrance into Judæa of Tryphon, who had treacherously seized on Jonathan at Ptolemais. In the parallel passage Josephus (*Antiq.* xiii. 6, 4) adds that this Adida was upon a hill, before which lay the plains of Judæa. Lightfoot, however, contrives to multiply the single place mentioned in the Maccabees and Josephus into four or five different towns (see *Chorog. Decad.* § 3). One of the places which Josephus calls Adida (*Bell. Jud.* iv. 9, 1) appears to have been near the Jordan, and was probably the Hadid of Ezra ii. 32.

ADJURATION. This is a solemn act or appeal, whereby one man, usually a person vested with natural or official authority, imposes upon another the obligation of speaking or acting as if under the solemnity of an oath. We find the word אָשַׁבּוּעַ used in this sense in Cant. ii. 7; iii. 5, &c. In the New Testament the act of adjuration is performed with more marked effect; as when the high-priest thus calls upon Christ, 'I adjure thee by the living God, tell us' &c.—'Ἐφορκίζω σε κατὰ τοῦ Θεοῦ τοῦ ζῶντος, &c. (Matt. xxvi. 61). The word used here is that by which the LXX. render the Hebrew (see also Mark v. 7; Acts xix. 13; 1 Thess. v. 27). An oath, although thus imposed upon one without

his consent, was not only binding, but solemn in the highest degree; and when connected with a question, an answer was compulsory, which answer being as upon oath, any falsehood in it would be perjury. Thus our Saviour, who had previously disdained to reply to the charges brought against him, now felt himself bound to answer the question put to him. The abstract moral right of any man to impose so serious an obligation upon another without his consent, may very much be doubted—not, indeed, as compelling a true answer, which a just man will give under all circumstances, but as extorting a truth which he might have just reasons for withholding.

ADMAH, one of the cities in the vale of Siddim (Gen. x. 19), which had a king of its own (Gen. xiv. 2). It was destroyed along with Sodom and Gomorrah (Gen. xix. 24; Hos. xi. 8).

ADMONI (אָדמוֹני; Sept. *πυρράκης*; Vulg. *rufus*). This word means *red-haired*, and is so rendered in the ancient versions, although ours understands a *ruddy complexion*. It would thus appear that Esau (Gen. xxv. 25) and David (1 Sam. xvi. 12; xvii. 42) were red-haired. Red hair is so uncommon in the East, that it forms a particular distinction, as in the Scriptural instances; but it is by no means unknown, especially in mountainous countries. The writer has observed it in Persia repeatedly, accompanied with the usual fresh complexion. Such hair and complexion together seem to have been regarded as a beauty among the Jews. The personal characters of Esau and David appear to agree well with the temperament which red hair usually indicates.

ADONAI (אֲדוֹנָי; Sept. *Κύριος*, *lord*, *master*), the old plural form of the noun אָדוֹן *adon*, similar to that with the suffix of the first person; used as the *pluralis excellentie*, by way of dignity, for the name of JEHOVAH. The similar form with the suffix is also used of men, as of Joseph's master (Gen. xxxix. 2, 3, *sq.*); of Joseph himself (Gen. xlii. 30, 33; so also Isa. xix. 4). The Jews, out of superstitious reverence for the name JEHOVAH, always, in reading, pronounce *Adonai* where *Jehovah* is written; and hence the letters יהוה are usually written with the points belonging to *Adonai* [JEHOVAH]. The view that the word exhibits a plural termination without the affix is that of Gesenius (*Thesaur. s. v.* אָדוֹן), and seems just, though rather disapproved by Professor Lee (*Lec.* in אָדוֹן). The latter adds that 'Our English bibles generally translate יהוה by LORD, in capitals; when preceded by הוֹאֲדוֹן, they translate it GOD; when צְבָאוֹת *tzabaoth* follows, by LORD; as in Isa. iii. 1, 'The Lord, the LORD of Hosts.' The copies now in use are not, however, consistent in this respect.

ADONIBEZEK (אֲדוֹנִי-בֶזֶק; *lord of Bezek*; Sept. Ἀδωνιβεζεκ), king or lord of Bezek, a town which Eusebius (in Bezek) places 17 miles east of Neapolis or Shechem. The small extent of the kingdoms in and around Palestine at the time of its invasion by the Hebrews is shown by the fact that this petty *melek* had subdued no less than seventy of them; and the barbarity of the war-usages in those early times is painfully shown by his cutting off all the thumbs and great toes of his prisoners, and allowing them no food but that

which they gathered under his table. These conquests made Adonibezek 'a triton among the minnows;' and we find him at the head of the confederated Canaanites and Perizzites, against whom the tribes of Judah and Simeon marched after the death of Joshua. His army was routed and himself taken prisoner. The victors failed not to express their indignation at the mode in which he had treated his captives, by dealing with him in the same manner. His conscience was then awakened to the enormity of his conduct, and in his own treatment he recognised a severe but just application of the *lex talionis*. That the act was so intended by the captors is very clear; and it is strange that this strong reprobation of his conduct by the Israelites should have been construed into an example of their own barbarous usages in war. Adonibezek was taken to Jerusalem, where he died, B.C. 1419.

ADONIJAH (אֲדוֹנִיָּהוּ, *Jehovah [is] my Lord*; Sept. Ἀδωνίας), the fourth son of David, by Haggith. He was born after his father became king, but when he reigned over Judah only (2 Sam. iii. 4). According to the Oriental notion developed in the article ABSALOM, Adonijah might have considered his claim superior to that of his eldest brother Amnon, who was born while his father was in a private station; but not to that of Absalom, who was not only his elder brother, and born while his father was a king, but was of royal descent on the side of his mother. When, however, Amnon and Absalom were both dead, he became, by order of birth, the heir-apparent to the throne. But this order had been set aside in favour of Solomon, who was born while his father was king of all Israel. Absalom perished in attempting to assert his claim of primogeniture, in opposition to this arrangement. Unawed by this example, Adonijah took the same means of showing that he was not disposed to relinquish the claim of primogeniture which now devolved upon him. He assumed the state of an heir-apparent, who, from the advanced age of David, must soon be king. But it does not appear to have been his wish to trouble his father as Absalom had done; for he waited till David appeared at the point of death, when he called around him a number of influential men, whom he had previously gained over, and caused himself to be proclaimed king. This was a formidable attempt to subvert the appointment made by the Divine king of Israel; for Adonijah was supported by such men as Joab, the general-in-chief, and Abiathar, the high-priest; both of whom had followed David in all his fortunes. The adhesion of such men, and the previous defection of the nation to Absalom, show the strength of the hereditary principle among the Israelites. In all likelihood, if Absalom had waited till David was on his death-bed, Joab and Abiathar would have given him their support; but his premature and unnatural attempt to dethrone his father, disgusted these friends of David, who might not otherwise have been adverse to his claims. This danger was avoided by Adonijah: but his plot was, notwithstanding, defeated by the prompt measure taken by David, who directed Solomon to be at once proclaimed, and crowned, and admitted to the real exercise of the sovereign power. Adonijah then saw that all was lost, and

fled to the altar, which he refused to leave without a promise of pardon from King Solomon. This he received, but was warned that any further attempt of the same kind would be fatal to him. Accordingly, when, some time after the death of David, Adonijah covertly endeavoured to reproduce his claim through a marriage with Abishag, the virgin widow of his father [ABISHAG], his design was at once penetrated by the king, by whose order he was instantly put to death (1 Kings i.-ii. 13-25).

ADONIRAM (אֲדוֹנִירָם, *lord of height*, i. q. *high lord*; Sept. Ἀδωνιράμ, 1 Kings iv. 6). This name is exhibited in the contracted form of ADORAM (אֲדוֹרָם) in 2 Sam. xx. 24; 1 Kings xii. 18; and of Hadoram (הַדּוֹרָם) in 2 Chron. x. 18.

1. ADONIRAM, or HADORAM, son of Toi, king of Hamath, who was sent by his father to congratulate David on his victory over their common enemy Hadarezer, king of Syria (1 Chron. xviii. 10). This prince is called Joram in 2 Sam. viii. 10.

2. ADONIRAM. A person of this name is mentioned as receiver-general of the imposts in the reigns of David, Solomon, and Rehoboam. Commentators have been much at a loss to determine whether the office was held by one person for so long a period, or by two or three persons of the same name. It appears very unlikely that even two persons of the same name should successively bear the same office, in an age when no example occurs of the father's name being given to his son. We find also that not more than forty-seven years elapse between the first and last mention of the Adoniram who was 'over the tribute;' and as this, although a long term of service, is not too long for one life, and as the person who held the office in the beginning of Rehoboam's reign had served in it long enough to make himself odious to the people, it appears on the whole most probable that one and the same person is intended throughout. Only one incident is recorded in connection with this person. When the ten tribes seceded from the house of David, and made Jeroboam king, Rehoboam sent Adoniram among them, for the purpose, we may presume, of collecting the usual imposts, which had become very heavy. Perhaps he had been rigid in his invidious office under Solomon: at all events the collector of the imposts which had occasioned the revolt was not the person whose presence was the most likely to sooth the exasperated passions of the people. They rose upon him, and stoned him till he died. Rehoboam, who was not far off, took warning by his fate, and, mounting his chariot, returned with all speed to Jerusalem (1 Kings xii. 18).

ADONIS. [THAMMUZ.]

ADONI-ZEDEK (אֲדוֹנִי־זֶדֶק; Sept. Ἀδωνι-βεζέκ, confounding him with Adonibezek). The name denotes *lord of justice*, i. e. *just lord*, but some would rather have it to mean *king of Zedek*. He was the Canaanitish king of Jerusalem when the Israelites invaded Palestine; and the similarity of the name to that of a more ancient king of (as is supposed) the same place, Melchi-zedek (*king of justice*, or *king of Zedek*), has suggested that Zedek was one of the ancient names of Jerusalem. Be that as it may, this Adonizedek was the firm

the native princes that attempted to make head against the invaders. After Jericho and Ai were taken, and the Gibeonites had succeeded in forming a treaty with the Israelites, Adonizadek was the first to rouse himself from the stupor which had fallen on the Canaanites (Josh. i. 9-11), and he induced the other Amoritish kings of Hebron—Jarmuth, Lachish, and Eg on—to join him in a confederacy against the enemy. They did not, however, march directly against the invaders, but went and besieged the Gibeonites, to punish them for the discouraging example which their secession from the common cause had afforded. Joshua no sooner heard of this than he marched all night from Gilgal to the relief of his allies; and falling unexpectedly upon the besiegers, soon put them to utter rout. The pursuit was long, and was signalized by Joshua's famous command to the sun and moon, as well as by a tremendous hail-storm, which greatly distressed the fugitive Amorites [JOSHUA]. The five kings took refuge in a cave; but were observed, and by Joshua's order the mouth of it was closed with large stones, and a guard set over it, until the pursuit was over. When the pursuers returned, the cave was opened, and the five kings brought out. The Hebrew chiefs then set their feet upon the necks of the prostrate monarchs—an ancient mark of triumph, of which the monuments of Persia and Egypt still afford illustrations. They were then slain, and their bodies hung on trees until the evening, when, as the law forbade a longer exposure of the dead (Deut. xxi. 23), they were taken down, and cast into the cave, the mouth of which was filled up with large stones, which remained long after (Josh. x. 1-27). The severe treatment of these kings by Joshua has been censured and defended with equal disregard of the real circumstances, which are, that the war was avowedly one of extermination, no quarter being given or expected on either side; and that the war-usages of the Jews were neither worse nor better than those of the people with whom they fought, who would most certainly have treated Joshua and the other Hebrew chiefs in the same manner, had they fallen into their hands.

ADOPTION. The Old Testament does not contain any word equivalent to this; but the act occurs in various forms. The New Testament has the word *υιοθεσία* often (Rom. viii. 15, 23; ix. 4; Gal. iv. 5; Eph. i. 5); but no example of the act occurs. The term itself is well defined, and the act described, in the *literal* signification of the Greek word. It is the *placing as a son* of one who is not so by birth.

The practice of adoption had its origin in the desire for male offspring among those who have, in the ordinary course, been denied that blessing, or have been deprived of it by circumstances. This feeling is common to our nature; but its operation is less marked in those countries where the equalizing influences of high civilization lessen the peculiar privileges of the paternal character, and where the security and the well-observed laws by which estates descend and property is transmitted, withdraw one of the principal inducements to the practice. And thus most of the instances in the Bible occur in the patriarchal period. The law of Moses, by settling the relations of families and the rules of descent, and by formally establishing the Levirate law, which in some

sort secured a representative posterity even to a man who died without children, appears to have put some check upon this custom. The allusions in the New Testament are mostly to practices of adoption which then existed among the Greeks and Romans, and rather to the latter than to the former; for among the more highly civilized Greeks adoption was less frequent than among the Romans. In the East the practice has always been common, especially among the Semitic races, in whom the love of offspring has at all times been strongly manifested. And here it may be observed that the additional and peculiar stimulus which the Hebrews derived from the hope of giving birth to the Messiah, was inoperative with respect to adoption, through which that privilege could not be realized.

In early times there appears to have been no limitation or restriction of the exercise of the power of adoption. But as the arrangements of society became more complicated, some restrictions were imposed, and certain public forms were made necessary to legalize the act. We are not much acquainted with the usages in this matter, which, in *different ages*, were, among the Hebrews, connected with the act of adoption. This is partly because the practice had ceased to be common among them by the time the sources of information became more open. And, indeed, the culpable facility of divorce in later times rendered unnecessary those adoptions which might have arisen, and in earlier times did arise, from the sterility of a wife. The want of positive information, however, is supplied, in some degree, by our acquaintance with the analogous practices of other Eastern nations.

It is scarcely necessary to say that adoption was confined to sons. The whole Bible history affords no example of the adoption of a female; for the Jews certainly were not behind any Oriental nation in the feeling expressed in the Chinese proverb—'He is happiest in daughters who has only sons' (*Mém. sur les Chinois*, t. x. 149).

The first instances of adoption which occur in Scripture are less the acts of men than of women, who, being themselves barren, give their female slaves to their husbands, with the view of adopting the children they may bear. Thus Sarah gave her handmaid Hagar to Abraham; and the son who was born, Ishmael, appears to have been considered as her son as well as Abraham's, until Isaac was born. In like manner Rachel, having no children, gave her handmaid Bilhah to her husband, who had by her Dan and Naphtali (Gen. xxx. 5-9); on which his other wife, Leah, although she had sons of her own, yet fearing that she had left off bearing, claimed the right of giving her handmaid Zilpah to Jacob, that she might thus increase their number; and by this means she had Gad and Asher (Gen. xxx. 9-13). In this way the greatest possible approximation to a natural relation was produced. The child was the son of the husband, and, the mother being the property of the wife, the progeny must be her property also; and the act of more particular appropriation seems to have been that, at the time of birth, the handmaid brought forth her child 'upon the knees of the adoptive mother' (Gen. xxx. 3). Strange as this custom may seem, it is in accordance with the notions of *representation* which we find very prevalent in analogous states of

society. We do not see the use of explaining away customs we do not like, or which do not agree with our own notions, by alleging that by this expression nothing more is meant than that the son was to be dandled and brought up *upon the knees* of the adoptive mother. In this case the vicarious bearing of the handmaid for the mistress was as complete as possible; and the sons were regarded as fully equal in right of heritage with those by the legitimate wife. This privilege could not, however, be conferred by the adoption of the wife, but by the natural relation of such sons to the husband. A curious fact is elicited by the peculiar circumstances in Sarah's case, which were almost the only circumstances that could have arisen to try the question, whether a mistress retained her power, as such, over a female slave whom she had thus vicariously employed, and over the progeny of that slave, even though by her own husband. The answer is given, rather startlingly, in the affirmative in the words of Sarah, who, when the birth of Isaac had wholly changed her feelings and position, and when she was exasperated by the offensive conduct of Hagar and her son, addressed her husband thus, 'Cast forth *this bond-woman* and her son; for *the son of this bond-woman* shall not be heir with *my son*, even with Isaac' (Gen. xxi. 10).

A previous instance of adoption in the history of Abraham, when as yet he had no children, appears to be discoverable in his saying, 'One born in my house is mine heir.' This unquestionably denotes a house-born slave, as distinguished from one bought with money. Abraham had several such; and the one to whom he is supposed here to refer is his faithful and devoted steward Eliezer. This, therefore, is a case in which a slave was adopted as a son—a practice still very common in the East. A boy is often purchased young, adopted by his master, brought up in his faith, and educated as his son; or if the owner has a daughter, he adopts him through a marriage with that daughter, and the family which springs from this union is counted as descended from him. But house-born slaves are usually preferred, as these have never had any home but their master's house, are considered members of his family, and are generally the most faithful of his adherents. This practice of slave adoption was very common among the Romans; and, as such, is more than once referred to by St. Paul (Rom. viii. 15; 1 Cor. ii. 12), the transition from the condition of a slave to that of a son, and the privilege of applying the tender name of 'Father' to the former 'Master,' affording a beautiful illustration of the change which takes place from the bondage of the law to the freedom and privileges of the Christian state.

As in most cases the adopted son was to be considered dead to the family from which he sprung, the separation of natural ties and connections was avoided by this preference of slaves, who were mostly foreigners or of foreign descent. For the same reason the Chinese make their adoptions from children in the hospitals, who have been abandoned by their parents (*Mém. sur les Chinois*, t. vi. 325). The Tartars are the only people we know who prefer to adopt their near relatives—nephews or cousins, or, failing them, a Tartar of their own banner (*Ibid.*, t. iv. 136). The only Scriptural example of this kind is that in

which Jacob adopted his own grandsons Ephraim and Manasseh to be counted as his sons. Some have questioned whether this was really an act of adoption: but it seems to us that there is no way in which an act of adoption could be more clearly expressed. Jacob says to Joseph, their father—'Thy two sons, Ephraim and Manasseh, shall be mine: . . . as Reuben and Simeon (his two eldest sons), they shall be mine. But thy issue which thou begetteth after them shall be thine' (Gen. xlviii. 6). The object of this remarkable adoption was, that whereas Joseph himself could only have one share of his father's heritage along with his brothers, the adoption of his two sons enabled Jacob, through them, to bestow two portions upon his favourite son. One remarkable effect of this adoption was that the sons of Jacob, and the tribes which sprung from them, thus became thirteen instead of twelve; but the ultimate exclusion of Levi from a share of territory, rectified this so far as regarded the distribution of lands in Canaan.

The adoption of Moses by Pharaoh's daughter (Exod. ii. 1-10) is an incident rather than a practice; but it recalls what has just been stated respecting the adoption of outcast children by the Chinese.

A man who had only a daughter would naturally wish to build up a family, to be counted as his own, through her. We have seen that, under such circumstances, the daughter is often married to a freed slave, and the children counted as those of the woman's father, or the husband himself is adopted as a son. An instance of the former kind occurs in 1 Chron. ii. 34, sq. Sheshan, of the tribe of Judah, gives his daughter to Jarha, an Egyptian slave (whom, as the Targum premises, he no doubt liberated on that occasion); the posterity of the marriage are not, however, reckoned to Jarha, the husband of the woman, but to her father, Sheshan, and as *his* descendants they take their heritage and station in Israel. The same chapter gives another instance. Machir (grandson of Joseph) gives his daughter in marriage to Hezron, of the tribe of Judah. She gave birth to Segub, who was the father of Jair. This Jair possessed twenty-three cities in the land of Gilead, which came to him in right of his grandmother, the daughter of Machir; and he acquired other towns in the same quarter, which made up his possessions to three-score towns or villages (1 Chron. ii. 21-24; Josh. xiii. 9; 1 Kings iv. 13). Now this Jair, though of the tribe of Judah by his grandfather, is, in Num. xxxii. 41, counted as of Manasseh, for the obvious reason which the comparison of these texts suggests, that, through his grandmother, he inherited the property, and was the lineal representative of Machir, the son of Manasseh. This case is of some importance from the ground which it offers for the opinion of those who account for the difference between the pedigree of Christ as given by Matthew, and that in Luke, by supposing that the former is the pedigree through Joseph, his supposed father, and the latter through his mother Mary. This opinion, which will be examined in another place [GENEALOGY], supposes that Mary was the daughter of Heli, and that Joseph is called his son (Luke iii. 23) because he was adopted by Heli when he married his daughter, who was an heiress, as is proved by

the fact of her going to Bethlehem to be registered, when in the last stage of pregnancy.

The following are among the foreign customs connected with adoption which are supposed to be alluded to in the New Testament; and in explanation of these it may be remarked, that by the time of Christ the Jews had, through various channels, become well acquainted with the more remarkable customs of the Greeks and Romans; and the perfect familiarity of St. Paul, in particular, with such customs would be probable from circumstances, even were it not constantly apparent in his Epistles. In John viii. 36, 'If the Son shall make you free, ye shall be free indeed,' is supposed by Grotius and other commentators to refer to a custom in some of the cities of Greece, and elsewhere, called ἀδελφοθεσία, whereby the son and heir was permitted to adopt brothers and admit them to the same rights which he himself enjoyed. But it seems more likely that the reference was to the more familiar Roman custom, by which the son, after his father's death, often made free such as were born slaves in his house (Theophil. Antecessor, *Institut. Imp. Justinian.* i. 6. 5). In Rom. viii. 23, *υιοθεσίαν ἀπεκδεχόμενοι*, 'anxiously waiting for the adoption,' the former word appears to be used in a sense different from that which it bears in ver. 15, and to signify the consummation of the act there mentioned; in which point of view it is conceived to apply to the twofold ceremony among the Romans. The one was the private act, between the parties; and if the person to be adopted was not already the slave of the adopter, this private transaction involved the purchase of him from his parents, when practicable. In this manner Caius and Lucius were purchased from their father Agrippa before their adoption by Augustus. The other was the public acknowledgment of that act on the part of the adopter, when the adopted person was solemnly avowed and declared to be his son. The peculiar force and propriety of such an allusion in an epistle to the Romans must be very evident.

In Gal. iv. 5, 6, there is a very clear allusion to the privilege of adopted slaves to address their former master by the endearing title of *Abba*, or Father. Selden has shown that slaves were not allowed to use this word in addressing the master of the family to which they belonged, nor the corresponding title of *Mana*, mother, when speaking to the mistress of it (*De Succ. in Bona Defunct. secund. Hebr.* c. iv.).

A more minute investigation than would here be in place, might discover other allusions to the custom of adoption. The ideas and usages connected with the adoption of an official successor are considered elsewhere [INVESTITURE].

ADORAİM (אֲדוֹרַיִם; Sept. Ἀδωραΐμ), a town in the south of Judah, enumerated along with Hebron and Mareshah, as one of the cities fortified by Rehoboam (2 Chron. xi. 9). Under the name of Adora it is mentioned in the Apocrypha (1 Macc. xiii. 20), and also often by Josephus *Antiq.* viii. 10, 1; xiii. 6, 4, 15, 4; *Bell. Jud.* i. 2, 6, 8, 4), who usually connects Adora with Maressa, as cities of the later Idumaea. It was captured by Hyrcanus at the same time with Maressa, and rebuilt by Gabinus (Joseph. *Antiq.* xiii. 9, 1; xiv. 5, 3). This town does not occur in any writer after Josephus, until the re-

cent researches of Dr. Robinson, who discovered it under the name of Dura, the first feeble letter having been dropped. It is situated five miles W. by S. from Hebron, and is a large village, seated on the eastern slope of a cultivated hill, with olive-groves and fields of grain all around. There are no ruins (Robinson's *Bib. Researches*, iii. 2-5).

ADORATION. This word is compounded of *ad* 'to,' and *os, oris*, 'the mouth,' and literally signifies to apply the hand to the mouth, that is, 'to kiss the hand.' The act is described in Scripture as one of worship. Job says:—'If I had beheld the sun when it shined, or the moon, walking in brightness; and my heart had been secretly enticed, or my mouth had kissed my hand; this also were an iniquity to be punished by the judge' (Job xxxi. 26, 27). And this very clearly intimates that kissing the hand was considered an overt act of worship in the East. So Minutius Felix (*De Sacrific.* cap. 2, ad fin.) remarks, that when Cæcilius observed the statue of Serapis, '*Ut vulgus supersticiosus solet, manum ori admoveus, osculum labiis pressit*'; according to the custom of the 'superstitious vulgar, he moved his hand to his mouth, and kissed it with his lips.'

The same act was used as a mark of respect in the presence of kings and persons high in office or station. Or rather, perhaps, the hand was not merely kissed and then withdrawn from the mouth, but held continuously before or upon the mouth, to which allusion is made in such texts as Judg. xviii. 10; Job xxi. 5; xxix. 9; xl. 4; Ps. xxxix. 9; in which 'laying the hand upon the mouth' is used to describe the highest degree of reverence and submission; as such, this posture is exhibited on the monuments of Persia and of Egypt. In one of the sculptures at Persepolis a king is seated on his throne, and before him a person standing in a bent posture, with his hand laid upon his mouth as he ad-

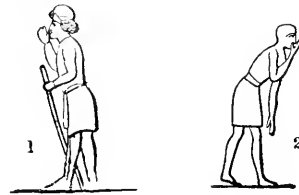

dresses the sovereign (fig. 1). Exactly the same attitude is observed in the sculptures at Thebes, where one person, among several (in various postures of respect) who appear before the scribes to be registered, has his hand placed thus submissively upon his mouth (fig. 2). The particular object of this act is said to have been to prevent the breath from reaching the face of the superior. But we are not to suppose that this was always its direct purpose, seeing that many acts which originally had a specific purpose, eventually became merely conventional marks of respect and homage under given circumstances.

ADRA. [ARAD.]

ADRAMMELECH (אֲדַרְמֶלֶךְ, Ἀδραμέλεχ) is mentioned, together with Anammelech, in 2 Kings xvii. 31, as one of the idols whose

worship the inhabitants of Sepharvaim established in Samaria, when they were transferred thither by the king of Assyria, and whom they worshipped by the sacrifice of their children by fire. This constitutes the whole of our certain knowledge of this idol. With regard to the etymology of the name, the two most probable modes of interpretation are those which assume, either that, as the latter half of the word is evidently Semitic, the former is so too, and that it means *the magnificence of the king* (and this is the view which Gesenius now favours); or, according to a suggestion first made by Reland (in his *Dissertat. Miscell.* ii. 113), that the former member is Assyrian, and that the word means *the king of fire*. It is to be observed that, although it has been disputed to what family of languages the Assyrian belongs, some modern scholars incline to consider it as Medo-Persian (Gesenius, *Geschichte der Hebr. Sprache*, p. 62), and that, in this case, the position of that member of the compound which would be dependent on the other as the genitive, is exactly the converse of that which is necessary in Hebrew and the other Syro-Arabian languages. As to the figure under which this idol was worshipped, the Babylonian Talmud (cited at length in Carpzov's *Apparatus*, p. 516) asserts that he was adored under that of a *mule*; whereas Kimchi says it was under that of a *peacock*; statements upon which little reliance can be placed. There is greater unanimity in the opinion that the power adored under this name was one of the heavenly bodies, in general accordance with the astrological character of the Assyrian idolatry (Gesenius, *Jesaja*, iii. 327, seq.). Selden (*De Diis Syris*, i. 6) and others have identified him with Moloch, chiefly on the ground that the sacrifice of children by fire, and the general signification of the name, are the same in both. According, then, to the great difference of opinion concerning Moloch, authorities of nearly equal weight may be adduced for the opinion that Adrammelech represents the planet *Saturn*, or the *Sun*: the kind of sacrifice being the chief argument in favour of the former; the etymology of the name being that in favour of the latter [MOLOCH].

Selden has also maintained (*De Diis Syris*, ii. 9) that Adrammelech and Anammelech are only different names of one and the same idol. The contrary, however, is asserted by most ancient authorities, and by Hyde, Jurieu, Gesenius, and others, among the moderns. No argument for their identity can be drawn from the *kethib*, in 2 Kings xvii. 31, because the singular מלך is not found *in prose* prior to the Captivity (and, even if it were, it would be *defectively* written here, of which there is only one instance in our present text, unless when it has a prefix or suffix). Besides, upwards of seventy MSS. and several early editions read the plural מלכים *in the text* here (De Rossi, *Var. Lect.* ad loc.); and it is also the *keri* of our printed copies.—J. N.

2. ADRAMMELECH, one of the sons and murderers of Sennacherib, king of Assyria (2 Kings xix. 27; Isa. xxxvii. 38).

ADRAMYTTIUM (Ἀδραμύττιον), a sea-port town in the province of Mysia in Asia Minor, opposite the isle of Lesbos, and an Athenian colony (Strabo, xiii. p. 606; Herod. vii. 42). It is mentioned in Scripture only (Acts xxvii. 2) from the fact

that the ship in which Paul embarked at Cæsarea as a prisoner on his way to Italy, belonged to Adramyttium. It was rare to find a vessel going direct from Palestine to Italy. The usual course therefore was to embark in some ship bound to one of the ports of Asia Minor, and there go on board a vessel sailing for Italy. This was the course taken by the centurion who had charge of Paul. The ship of Adramyttium took them to Myra in Lycia, and here they embarked in an Alexandrian vessel bound for Italy. Some commentators (Hammond, Grotius, Witsius, &c.) strangely suppose that *Adrametum* in Africa (Plin. v. 3; Ptol. iv. 3) was the port to which the ship belonged. Adramyttium is still called '*Adramyt*.' It is built on a hill, contains about 1000 houses, and is still a place of some commerce (Turner, *Tour*, iii. 265).

ADRIATIC SEA (Ἀδριακός, Acts xxvii. 27). This name is now confined to the gulf lying between Italy on one side, and the coasts of Dalmatia and Albania on the other. But in St. Paul's time it extended to all that part of the Mediterranean between Crete and Sicily. Thus Ptolemy (iii. 16) says that Sicily was bounded on the east by the Adriatic, and that Crete was bounded by the Adriatic on the west; and Strabo (ii. p. 185; vii. p. 488) says that the Ionian Gulf was a part of what was in his time called the Adriatic Sea. This fact is of importance, as relieving us from the necessity of finding the island of Melita on which Paul was shipwrecked, in the present Adriatic gulf; and consequently removing the chief difficulty in the way of the identification of that island with the present Malta. To this use it has been skilfully applied by Dr. Falconer in his tractate *On the Voyage of St. Paul*.

ADRIEL (אֲדִיֵּל, the flock of God; Sept. Ἀδριήλ), the person to whom Saul gave in marriage his daughter Merab, who had been originally promised to David (1 Sam. xviii. 19). Five sons sprung from this union, who were taken to make up the number of Saul's descendants, whose lives, on the principle of blood-revenge, were required by the Gibeonites to avenge the cruelties which Saul had exercised towards their race [GIBEONITES]. In 2 Sam. xxi. 8, the name of *Michal* occurs as the mother of these sons of Adriel: but as it is known that Merab, and not Michal, was the wife of Adriel, and that Michal had never any children (2 Sam. vi. 23), there only remains the alternative of supposing either that Michal's name has been substituted for Merab's by some ancient copyist, or that the word which properly means *bare* (which Michal *bare* unto Adriel), should be rendered *brought up* or *educated* (which Michal *brought up* for Adriel). The last is the choice of our public version, and also of the Targum. The Jewish writers conclude that Merab died early, and that Michal adopted her sister's children, and brought them up for Adriel (*T. Bab. Sanhed.* fol. 19. 2). But, as the word אֲדִיֵּל will not easily take any other sense than '*she bare*,' the change of names seems the easier explanation.

ADULLAM (אֲדֻלָּם; Sept. Ὀδολάμ), an old city (Gen. xxxviii. 1, 12, 20) in the plain country of the tribe of Judah (Josh. xv. 35), and one of the royal cities of the Canaanites (Josh.

xii. 15). It was one of the towns which Rehoboam fortified (2 Chron. xi. 7; Micah i. 15), and is mentioned after the Captivity (Neh. xi. 30; 2 Mace. 12, 38). Eusebius and Jerome state that it existed in their time as a large village, ten miles to the east of Eleutheropolis; but they follow the Sept. in confounding it with Eglon (עגלון), whereas it is certain that these were different places, and had distinct kings in the time of Joshua (xii. 12, 15). It is evident that Adullam was one of the cities of 'the valley,' or plain between the hill country of Judah and the sea; and from its place in the lists of names (especially 2 Chron. xi. 8), it appears not to have been far from the Philistine city of Gath. This circumstance would suggest that the 'cave of Adullam' (1 Sam. xxii. 1), to which David withdrew immediately from Gath, was near the city of that name. But there is no passage of Scripture which connects the city and the cave, and it is certainly not in a plain that one would look for a cave capable of affording a secure retreat to 400 men; nor has any such cave been found in that quarter. It is therefore far from improbable that the cave of Adullam was in the mountainous wilderness in the west of Judah towards the Dead Sea, where such caves occur, and where the western names (as Carmel) are sometimes repeated. This conjecture is favoured by the fact that the usual haunts of David were in this quarter; whence he moved into the land of Moab, which was quite contiguous, whereas he must have crossed the whole breadth of the land, if the cave of Adullam had been near the city of that name. Other reasons occur which would take too much room to state: but the result is, that there appears at length good grounds for the local tradition which fixes the cave on the borders of the Dead Sea, although there is no certainty with regard to the particular cave usually pointed out. The cave so designated is at a point to which David was far more likely to summon his parents, whom he intended to take from Bethlehem into Moab, than to any place in the western plains. It is about six miles south-west of Bethlehem, in the side of a deep ravine (Wady Khureitun) which passes below the Frank mountain [HERODION] on the south. It is an immense natural cavern, the mouth of which can be approached only on foot along the side of the cliff. Irby and Mangles, who visited it without being aware that it was the reputed cave of Adullam, state that it 'runs in by a long winding, narrow passage, with small chambers or cavities on either side. We soon came to a large chamber with natural arches of great height; from this last there were numerous passages, leading in all directions, occasionally joined by others at right angles, and forming a perfect labyrinth, which our guides assured us had never been perfectly explored, the people being afraid of losing themselves. The passages are generally four feet high by three feet wide, and were all on a level with each other. There were a few petrifications where we were: nevertheless the grotto was perfectly clean, and the air pure and good' (*Travels*, pp. 340, 341). It seems probable that David, as a native of Bethlehem, must have been well acquainted with this remarkable spot, and had probably often availed himself of its shelter when out with his father's flocks. It would therefore naturally occur to

him as a place of refuge when he fled from Gath; and his purpose of forming a band of followers was much more likely to be realized here, in the neighbourhood of his native place, than in the westward plain, where the *city* of Adullam lay. These circumstances have considerable weight, when taken in connection with what has already been adduced; but the question is one which there is no means of deciding with certainty.

ADULTERY. In the common acceptation of the word adultery denotes the sexual intercourse of a married woman with any other man than her husband, or of a married man with any other woman than his wife. But the crime is not understood in this extent among Eastern nations, nor was it so understood by the Jews. With them, adultery was the act whereby any married man was exposed to the risk of having a spurious offspring imposed upon him. An adulterer was, therefore, any man who had illicit intercourse with a married or betrothed woman; and an adulteress was a betrothed or married woman who had intercourse with any other man than her husband. An intercourse between a married man and an unmarried woman was not, as with us, deemed adultery, but fornication—a great sin, but not, like adultery, involving the contingency of polluting a descent, of turning aside an inheritance, or of imposing upon a man a charge which did not belong to him. Adultery was thus considered a great social wrong, against which society protected itself by much severer penalties than attended an unchaste act not involving the same contingencies.

It will be seen that this Oriental limitation of adultery is intimately connected with the existence of polygamy. If adultery be defined as a breach of the marriage covenant, then, where the contract is between one man and one woman, as in Christian countries, the man as much as the woman infringes the covenant, or commits adultery, by *every* act of intercourse with any other woman: but where polygamy is allowed—where the husband may marry other wives, and take to himself concubines and slaves, the marriage contract cannot and does not convey to the woman a legal title that the man should belong to her alone. If, therefore, a Jew associated with a woman who was not his wife, his concubine, or his slave, he was guilty of unchastity, but committed no offence which gave a wife reason to complain that her legal rights had been infringed. If, however, the woman with whom he associated was the wife of another, he was guilty of adultery—not by infringing his own marriage covenant, but by causing a breach of that which existed between that woman and her husband (Michaelis, *Mosaisches Recht*. art. 259; *Jahn's Archæologie*, th. i. b. 2, § 183). By thus excluding from the name and punishment of adultery, the offence which did *not* involve the enormous wrong of imposing upon a man a supposititious offspring, in a nation where the succession to landed property went entirely by birth, so that a father could not by his testament alienate it from any one who was regarded as his son—the law was enabled, with less severity than if the inferior offence had been included, to punish the crime with death. It is still so punished wherever the practice of polygamy has similarly operated in limiting the crime—not, perhaps, that the law expressly assigns that punishment, but it recognises the **right**

of the injured party to inflict it, and, in fact, leaves it, in a great degree, in his hands. Now death was the punishment of adultery before the time of Moses; and if he had assigned a less punishment, his law would have been inoperative, for private vengeance, sanctioned by usage, would still have inflicted death. But by adopting it into the law, those restrictions were imposed upon its operation which necessarily arise when the calm inquiry of public justice is substituted for the impulsive action of excited hands. Thus, death would be less frequently inflicted; and that this effect followed seems to be implied in the fact that the whole biblical history offers no example of capital punishment for the crime. "Indeed, Lightfoot goes farther, and remarks, 'I do not remember that I have anywhere, in the Jewish Pandect, met with an example of a wife punished for adultery with death. There is mention (*T. Hieros. Sanhed. 212*) of the daughter of a certain priest burned for committing fornication in her father's house; but she was not married' (*Hor. Hebr. ad Matt. xix. 8*). Eventually, divorce superseded all other punishment. There are indeed some grounds for thinking that this had happened before the time of Christ, and we throw it out as a matter of inquiry, whether the Scribes and Pharisees, in attempting to entrap Christ in the matter of the woman taken in adultery, did not intend to put him between the alternatives of either declaring for the revival of a practice which had already become obsolete, but which the law was supposed to command; or, of giving his sanction to the apparent infraction of the law, which the substitution of divorce involved (*John viii. 1-11*). In *Matt. v. 32*, Christ seems to assume that the practice of divorce for adultery already existed. In later times, it certainly did; and Jews who were averse to part with their adulterous wives, were compelled to put them away (*Maimon. in Gerushin, c. 2*). In the passage just referred to, our Lord does not appear to render divorce compulsory, even in case of adultery; he only permits it in that case alone, by forbidding it in every other.

In the law which assigns the punishment of death to adultery (*Lev. xx. 10*), the mode in which that punishment should be inflicted is not specified, because it was known from custom. It was not, however, *strangulation*, as the Talmudists contend, but *stoning*, as we may learn from various passages of Scripture (*e. g. Ezek. xvi. 38, 40; John viii. 5*); and as, in fact, Moses himself testifies, if we compare *Exod. xxxi. 14; xxxv. 2*; with *Num. xv. 35, 36*. If the adulteress was a slave, the guilty parties were both scourged with a leather whip (*בקרר*), the number of blows not exceeding forty. In this instance the adulterer, in addition to the scourging, was subject to the further penalty of bringing a trespass offering (a ram) to the door of the tabernacle, to be offered in his behalf by the priest (*Lev. xix. 20-22*). Those who wish to enter into the reasons of this distinction in favour of the slave, may consult *Michaelis (Mosäisches Recht. art. 264)*. We only observe that the Moslem law, derived from old Arabian usage, only inflicts upon a slave, for this and other crimes, half the punishment incurred by a free person.

It seems that the Roman law made the same important distinction with the Hebrew, between the infidelity of the husband and of the wife.

'Adultery' was defined by the civilians to be the violation of another man's bed (*violatio tori alieni*); so that the infidelity of the husband could not constitute the offence. The more ancient laws of Rome, which were very severe against the offence of the wife, were silent as to that of the husband. The offence was not capital until made so by Constantine, in imitation of the Jewish law; but under Leo and Marcian the penalty was abated to perpetual imprisonment, or cutting off the nose; and, under Justinian, the further mitigation was granted to the woman, that she was only to be scourged, to lose her dower, and to be shut up in a convent.

The punishment of cutting off the nose brings to mind the passage in which the prophet Ezekiel (*xxiii. 25*), after, in the name of the Lord, reproving Israel and Judah for their adulteries (*i. e. idolatries*) with the Assyrians and Chaldeans, threatens the punishment—'they shall take away thy nose and thy ears,' which Jerome states was actually the punishment of adultery in those nations. One or both of these mutilations, most generally that of the nose, were also inflicted by other nations, as the Persians and Egyptians, and even the Romans; but we suspect that among the former, as with the latter, it was less a judicial punishment than a summary infliction by the aggrieved party. It is more than once alluded to as such by the Roman poets; thus Martial asks,

'Quis tibi persuasit nares abscindere mæcho?' and in Virgil (*Æn. vi. 496*) we read—

'Ora, manusque ambas, populataque tempora raptis

Auribus, et truncas inhonesto vulnere nares.'

It would also seem that these mutilations were more usually inflicted on the male than the female adulterer. In Egypt, however, cutting off the nose was the female punishment, and the man was beaten terribly with rods (*Diod. Sic. i. 89, 90*). The respect with which the conjugal union was treated in that country in the earliest times is manifested in the history of Abraham (*Gen. xii. 19*).

ADULTERY. TRIAL OF. It would be unjust to the spirit of the Mosaic law to suppose that the trial of the suspected wife by the bitter water, called the *Water of Jealousy*, was by it first produced. It is to be regarded as an attempt to mitigate the evils of, and to bring under legal control, an old custom which could not be entirely abrogated. The original usage, which it was designed to mitigate, was probably of the kind which we still find in Western Africa; and a comparison of the two may suggest the real points of the evil which the law of Moses was designed to rectify, and the real advantages which it was calculated to secure. The matter deserves particular attention, inasmuch as it relates to the only ordeal in use among the Israelites, or sanctioned by their law. The illustrative details of the *Trial by Red Water*, as it is called, vary among different nations, in minute particulars, which it would be tiresome to distinguish. The substantial facts may be embodied in one statement:—

The ordeal is, in some tribes, confined to the case of adultery, but in others it is used in all cases. Differences, rather than resemblances, must indicate the particular points in which the Mosaic law, while retaining the form, abandoned the sub-

stance and obviated the evils of this institution. The differences are, in fact, all-important. In Africa the drink is poisonous, and calculated to produce the effects which the oath imprecates; whereas the 'water of jealousy,' however unpleasant, was prepared in a prescribed manner, with ingredients known to all to be perfectly innocuous. It could not therefore injure the innocent; and its action upon the guilty must have resulted from the consciousness of having committed a horrible perjury, which crime, when the oath was so solemnly confirmed by the draught, and attended by such awful imprecations, was believed to be visitable with immediate death from heaven. It cannot be too strongly inculcated, that in the African examples the effect is not ascribed to the drink, but to a supernatural visitation upon a perjury which the confirmation of the oath-drink renders so awful. This name of 'oath-drink' is commonly applied to it on the Gold Coast. And it was, doubtless, to strengthen such an impression that this awful drink, so much dreaded in Africa, was with the Jews exclusively appropriated to the only ordeal trial among them. On the Gold Coast the oath-drink (not, of course, poisonous) is used as a confirmation of all oaths, not only oaths of purgation, but of accusation, or even of obligation. In all cases it is accompanied with an imprecation that the Fetish may destroy them if they speak untruly, or do not perform the terms of their obligation; and it is firmly believed that no one who is perjured under this form of oath will live an hour (Villault; Bosman). Doubtless the impression with respect to this more ordinary oath-drink is derived from observation of the effects attending the drink used in the actual ordeal; and it is our object to show that the popular and general opinion regards such an oath as of so solemn a nature that perjury is sure to bring down immediate punishment. The red-water as an ordeal is confined to crimes of the worst class. These are murder, adultery, witchcraft. Perhaps this arises less from choice than from the fact that such crimes are not only the highest, but are the least capable of that direct proof for which the ordeal is intended as a substitute. A party is accused: if he denies the crime, he is required to drink the red water, and, on refusing, is deemed guilty of the offence. The trial is so much dreaded that innocent persons often confess themselves guilty, in order to avoid it. And yet, the immediate effect is supposed to result less from the water itself than from the terrible oath with which it is drunk; for there are instances which show that the draught is the seal and sanction of the most solemn oath which barbarous imaginations have been able to devise; and in kind it is the same—if we may be forgiven the familiar illustration—which is heard but too often in our own land, 'May this drink be my poison, if—.' So the person who drinks the red water invokes the Fetish to destroy him if he is really guilty of the offence with which he is charged. The drink is made by an infusion in water of pieces of a certain tree, or of herbs. It is highly poisonous in itself; and, if rightly prepared, the only chance of escape is the rejection of it by the stomach, in which case the party is deemed innocent; as he also is, if, being retained, it has no sensible effect, which can only be the case when the priests (so to call them), who have the ma-

nagement of the matter, are influenced by private considerations, or by reference to the probabilities of the case, to prepare the draught with a view to acquittal. The imprecations upon the accused if he be guilty, are repeated in an awful manner by the priests, and the effect is watched very keenly. If the party seems affected by the draught, like one intoxicated, and begins to foam at the mouth, he is considered undoubtedly guilty, and is slain on the spot; or else he is left to the operation of the poisonous draught, which causes the belly to swell and burst, and occasions death (Barbot, p. 126; Bosman, p. 148; Artus, in De Bry, vi. 62; Villault, p. 191; Corry's *Windward Coast*, p. 71; *Church Missionary Paper*, No. 17; Davis's *Journal*, p. 24).

The resemblances and the differences between this and the trial by bitter water, as described in Num. v. 11-31, will be apparent on comparison. The object, namely, to discover a crime incapable of being proved by evidence, is the same; the oath, and a draught as its sanction, are essentially the same; and similar also are the effects upon the guilty. If, therefore, we suppose the pre-existing custom to have been analogous to that which has been described, similar practices may be produced from other quarters. Hesiod, in his *Theogonia*, reports that when a falsehood had been told by any of the gods, Jupiter was wont to send Iris to bring some water out of the river Styx in a golden vessel; upon this an oath was taken, and if the god swore falsely, he remained for a whole year without life or motion. There was an ancient temple in Sicily, in which were two very deep basins, called Delli, always full of hot and sulphurous water, but never running over. Here the more solemn oaths were taken; and perjuries were immediately punished most severely (Diod. Sic. xi. 67). This is also mentioned by Aristotle, Silius Italicus, Virgil, and Macrobius; and from the first it would seem that the oath was written upon a ticket and cast into the water. The ticket floated if the oath was true, and sunk if it was false. In the latter case the punishment which followed was considered as an act of Divine vengeance.

The result of these views and illustrations will be, that the trial for suspected adultery by the bitter water amounted to this—that a woman suspected of adultery by her husband was allowed to repel the charge by a public oath of purgation, which oath was designedly made so solemn in itself, and was attended by such awful circumstances, that it was in the highest degree unlikely that it would be dared by any woman not supported by the consciousness of innocence. And the fact that no instance of the actual application of the ordeal occurs in Scripture, affords some countenance to the assertion of the Jewish writers—that the trial was so much dreaded by the women, that those who were really guilty generally avoided it by confession; and that thus the trial itself early fell into disuse. And if, as we have supposed, this mode of trial was only tolerated by Moses, the ultimate neglect of it must have been desired and intended by him. In later times, indeed, it was disputed in the Jewish schools, whether the husband was bound to prosecute his wife to this extremity, or whether it was not lawful for him to connive at and pardon her act, if he were so inclined. There were some who

held that he was bound by his duty to prosecute, while others maintained that it was left to his pleasure (*P. Hieros. tit. Sotah*, fol. 16, 2).

From the same source we learn that this form of trial was finally abrogated about forty years before the destruction of Jerusalem. The reason assigned is, that the men themselves were at that time generally adulterous; and that God would not fulfil the imprecations of the ordeal oath upon the wife while the husband was guilty of the same crime (*John viii. 1-8*).

ADULTERY, in the symbolical language of the Old Testament, means idolatry and apostasy from the worship of the true God (*Jer. iii. 8, 9; Ezek. xvi. 32; xxiii. 37; also Rev. ii. 22*). Hence an *Adulteress* meant an apostate church or city, particularly 'the daughter of Jerusalem,' or the Jewish church and people (*Isa. i. 21; Jer. iii. 6, 8, 9; Ezek. xvi. 22; xxiii. 7*). This figure resulted from the primary one, which describes the connection between God and his separated people as a marriage between him and them. By an application of the same figure, 'An adulterous generation' (*Matt. xii. 39; xvi. 4; Mark viii. 38*) means a faithless and impious generation.

ADUMMIM (אֲדֻמִּים; Sept. Ἀδαμίμ; various readings are Ἀδομίμ, Ἀδομίμ, and Ἐδομίμ), a place which is only twice named in Scripture. Once (*Josh. xv. 7*), where, from the context, it seems to indicate the border between Judah and Benjamin, and that it was an ascending road (מַעְלֵה אֲדֻמִּים) between Gilgal (and also Jericho) and Jerusalem. The second notice (*Josh. xviii. 17*) adds no further information, but repeats 'the ascent to Adummim.' Most commentators take the name to mean the *place of blood* (from the Heb. אֲדָם), and follow Jerome, who finds the place in the dangerous or mountainous part of the road between Jerusalem and Jericho, and supposes that it was so called from the frequent effusion of blood by the robbers, by whom it was much infested. In his time it was called corruptly *Mali domin*; in Greek, Ἀβαβα; in Latin, *Ascensus rufforum*, sive *robentium*. These are curious interpretations of the original word, which is most likely from אֲדָם, and merely denotes the redness of the soil or rock. It does not appear that any traveller mentions the geological aspect of the spot, and therefore this must be regarded only as a probable conjecture. However, as a difficult pass in a desolate rocky region, between important cities, the part of the road indicated by Jerome, and all after him, was as likely to be infested by robbers in earlier times as in those of Jerome and at the present day. Indeed, the character of the road was so notorious, that Christ lays the scene of the parable of the good Samaritan (*Luke x.*) upon it; and Jerome informs us that Adummim or Adommim was believed to be the place where the traveller (taken as a real person) 'fell among thieves.' He adds that a fort and garrison was maintained here for the safeguard of travellers (*Jerome, in Loc. Heb. Adommim, et in Epit. Paulæ*). The travellers of the sixteenth and seventeenth centuries noticed the ruins of a castle, and supposed it the same as that mentioned by Jerome (*Zuallart. iv. 30*); but the judicious Nau (*Voyage Nouveau de la Terre-Sainte*, p. 349) perceived that this castle belonged to the time of the Crusades. Not far from this spot was a khan, called the 'Samaritan's khan'

(*le Khan du Samaritain*), in the belief that it was the 'inn' to which the Samaritan brought the wounded traveller. The travellers of the present century mention the spot and neighbourhood nearly in the same terms as those of older date; and describe the ruins as those of 'a convent and a khan' (*Hardy, 193*). They all represent the road as still infested by robbers, from whom some of them (as Sir F. Henniker) have not escaped without danger. The place thus indicated is about eight miles from Jerusalem, and four from Jericho.

ADVOCATE (Παράκλητος), one who pleads the cause of another; also one who exhorts, defends, comforts, prays for another. It is an appellation given to the Holy Spirit by Christ (*John xiv. 16; xv. 26; xvi. 7*), and to Christ himself by an apostle (*1 John ii. 1*; see also *Rom. viii. 34; Heb. vii. 25*).

In the forensic sense, advocates or pleaders were not known to the Jews until they came under the dominion of the Romans, and were obliged to transact their law affairs after the Roman manner. Being then little conversant with the Roman laws, and with the forms of the jurists, it was necessary for them, in pleading a cause before the Roman magistrates, to obtain the assistance of a Roman lawyer or *advocate*, who was well versed in the Greek and Latin languages (*Otti Spicil. Crim. p. 325*). In all the Roman provinces such men were found, who devoted their time and labour to the pleading of causes and the transacting of other legal business in the provincial courts (*Lamprid. Vit. Alex. Sev. c. 44*). It also appears (*Cic. pro Cælio, c. 30*) that many Roman youths who had devoted themselves to forensic business used to repair to the provinces with the consuls and prætors, in order, by managing the causes of the provincials, to fit themselves for more important ones at Rome. Such an advocate was Tertullus, whom the Jews employed to accuse Paul before Felix (*Acts xxiv. 1*); for although Πηγάρι, the term applied to him, signifies primarily an *orator* or *speaker*, yet it also denotes a pleader or advocate (*Kuinoel, Comment. and Bloomfield, Recens. Synopt. ad Act. xxiv. 2*) [*Accuser*].

ADYTUM, that which is inaccessible or impenetrable; and hence considered as descriptive of the holy of holies in the temple of Jerusalem, and of the innermost chambers, or penetralia, of other edifices accounted sacred, and of the secret places to which the priests only were admitted. It is used metaphorically by ecclesiastical writers, and employed to signify the heart and conscience of a man, and sometimes the deep, spiritual meaning of the Divine word.—H. S.

ÆGYPT. [EGYPT.]

ÆLIA CAPITOLINA. [JERUSALEM.]

ÆNON (Αἰνών, from אֵין, fountain; *Buxt. Lex. Ch. Rab. Talm.* 1601), the name of a place near Salem, where John baptized (*John iii. 23*); the reason given, 'because there was much water there,' would suggest that he baptized at the springs from which the place took its name. On the situation of Ænon nothing certain has been determined, although Eusebius places it eight Roman miles south of Scythopolis (Bethshan), and fifty-three north-east of Jerusalem.

ÆRÆ. [CHRONOLOGY.]

ÆTHIOPIA. [ÆTHIOPIA.]

AFFINITY is relationship by marriage, as distinguished from *consanguinity*, which is relationship by blood. Marriages between persons thus related, in various degrees, which previous usage, in different conditions of society, had allowed, were forbidden by the law of Moses. These degrees are enumerated in Lev. xviii. 7, *sq.* The examples before the law are those of Cain and Abel, who, as the necessity of the case required, married their own sisters. Abraham married Sarah, the daughter of his father by another wife; and Jacob married the two sisters Leah and Rachel. In the first instance, and even in the second, there was an obvious consanguinity, and only the last offered a previous relationship of affinity merely. So also, in the prohibition of the law, a consanguinity can be traced in what are usually set down as degrees of affinity merely. The degrees of real affinity interdicted are, that a man shall not (nor a woman in the corresponding relations) marry—1. his father's widow (not his own mother); 2. the daughter of his father's wife by another husband; 3. the widow of his paternal uncle; 4. nor his brother's widow if he has left children by her; but, if not, he was bound to marry her to raise up children to his deceased brother [LEVIRATE LAW]. The other restrictions are connected with the condition of polygamy, and they prohibit a man from having—1. a mother and her daughter for wives at the same time; 2. or two sisters for wives at the same time. These prohibitions, although founded in Oriental notions, adapted to a particular condition of society, and connected with the peculiarities of the Levitical marriage law, have been imported wholesale into our canon law. The fitness of this is doubted by many: but as, apart from any moral questions, the prohibited marriages are such as few would, in the present condition of European society, desire to contract, and such as would be deemed repugnant to good taste and correct manners, there is little real matter of regret in this adoption of the Levitical law. Indeed, the objections to this adoption have rested chiefly upon one point; and that happens to be a point in which the law itself happens to have been egregiously misunderstood. This is in the injunction which, under permitted polygamy, forbade a man to have two sisters at once; an injunction which has been construed, under the Christian law, which allows but one wife, to apply equally to the case of a man marrying the sister of a deceased wife. The law itself, however, is so plain, that it is difficult to conceive how its true object—concerning which nearly all commentators are agreed—could have been thus interpreted. It is rendered in our version, 'Neither shalt thou take a wife to her sister, to vex her, to uncover her nakedness, *beside the other in her lifetime.*' Clear as this seems, it is still clearer if, with Gesenius and others, we take the word צַרְרָה, rendered *to vex*, to mean *to rival*, as in the Sept., Arabic, and Vulgate. The Targum of Jonathan, the Mishna, and the celebrated Jewish commentators Jarchi and Ben Gerson, are satisfied that *two sisters at once* are intended; and there seems an obvious design to prevent the occurrence of such unseemly jealousies and contentions between sister-wives as embittered the life of Jacob—the father of the twelve tribes. The more recondite sense has been extracted, with rather

ungentle violence to the principles of Hebrew construction, by making 'vex her' the antecedent of 'in her lifetime,' instead of 'take her sister to her, in her lifetime.' Under this view it is explained, that the married sister should not be 'vexed' in her lifetime by the prospect that her sister might succeed her. It may be safely said that such an idea would never have occurred in the East, where unmarried sisters are far more rarely than in Europe brought into such acquaintance with the husband of the married sister as to give occasion for such 'vexation' or 'rivalry' as this. Yet, this view of the matter, which is completely exploded among sound biblical critics, has received the sanction of several Christian Councils (*Concil. Illiber.* can. 61; *Aurat.* can. 17; *Aucer.* can. 30); and is perhaps not calculated to do much harm, except under peculiar circumstances, and except as it may prove a snare to some sincere but weak consciences. It may be remarked, that in those codes of law which most resemble that of Moses on the general subject, no prohibition of the marriage of two sisters *in succession* can be found.

AFFIRMATIVES. Among the Jews the formula of assent or affirmation was אָמֵן אָמֵן אָמֵן, *σὺ εἶπας, thou hast said, or, thou hast rightly said.* It is stated by Aryda and others that this is the prevailing mode in which a person expresses his assent, at this day, in Lebanon, especially when he does not wish to assert anything in express terms. This explains the answer of our Saviour to the high-priest Caiaphas (*Matt.* xxvi. 64), when he was asked whether he was the Christ, the son of God, and replied *σὺ εἶπας* (see also *Matt.* xxvi. 25). Instances occur in the Talmud; thus, 'A certain man was asked, "Is Rabbi dead?" He answered, "Ye have said:" on which they rent their clothes'—taking it for granted from this answer that it was so (*T. Hieros. Kilaim* xxxii. 2). All readers even of translations are familiar with a frequent elegance of the Scriptures, or rather of the Hebrew language, in using an affirmative and negative together, by which the sense is rendered more emphatic: sometimes the negative first, as Ps. cxviii. 17, 'I shall not die, but live,' &c.; sometimes the negative first, as Isa. xxxviii. 1, 'Thou shalt die, and not live.' In John i. 20, there is a remarkable instance of emphasis produced by a negative being placed between two affirmatives—*καὶ ὠμολόγησε, καὶ οὐκ ἠρνήσατο, καὶ ὠμολόγησεν*—'And he confessed, and denied not, but confessed, I am not the Christ.'

AFRICA. This 'quarter of the world' is not mentioned as such by any general name in Scripture, although some of its regions are indicated. It is thought by some, however, that Africa, or as much of it as was then known, is denoted by 'the land of Ham' in several of the Psalms. But we are inclined to think that the context rather restricts this designation to Egypt. Whether Africa was really 'the land of Ham,' that is, was peopled by the descendants of Ham, is quite another question [HAM].

AGABUS ('Αγαβος; either from the Hebrew אָגַב, *a locust*, or אָבַב, *to love*), the name of 'a prophet,' supposed to have been one of the seventy disciples of Christ. He, with others, came from Judæa to Antioch, while Paul and

Barnabas (A.D. 43) were there, and announced an approaching famine, which actually occurred the following year. Some writers suppose that the famine was general; but most modern commentators unite in understanding that the large terms of the original, "Ὅλην τὴν οἰκουμένην, ἀπλῶς τοῦ ὅλου κόσμου, nor even to the whole Roman empire, but, as in Luke ii. 1, to Judea only. Statements respecting four famines, which occurred in the reign of Claudius, are produced by the commentators who support this view; and as all the countries put together would not make up a tenth part of even the Roman empire, they think it plain that the words must be understood to apply to that famine which, in the fourth year of Claudius, overspread Palestine. The poor Jews, in general, were then relieved by the Queen of Adiabene, who sent to purchase corn in Egypt for them (Joseph. *Antiq.* xx. 2, 6); and for the relief of the Christians in that country contributions were raised by the brethren at Antioch, and conveyed to Jerusalem by Paul and Barnabas (Acts xi. 27-30). Many years after, this same Agabus met Paul at Cæsarea, and warned him of the sufferings which awaited him if he prosecuted his journey to Jerusalem.

AGAG (אָגָג; Sept. Ἀγάγ), the name of two kings of the Amalekites, and perhaps a common name of all their kings, like Pharaoh in Egypt (comp. Num. xxiv. 7; 1 Sam. xv. 8, 9, 20, 32). The first of these passages would imply that the king of the Amalekites was, then at least, a greater monarch, and his people a greater people, than is commonly imagined [AMALEKITES]. The latter references are to that king of the Amalekites who was spared by Saul, contrary to the solemn vow of devotion to destruction, whereby the nation, as such, had of old precluded itself from giving any quarter to that people (Exod. xvii. 11; Num. xiv. 45). Hence, when Samuel arrived in the camp of Saul, he ordered Agag to be brought forth. He came 'pleasantly,' deeming secure the life which the king had spared. But the prophet ordered him to be cut in pieces; and the expression which he employed—'As thy sword hath made women childless, so shall thy mother be childless among women'—indicates that, apart from the obligations of the vow, some such example of retributive justice was intended, as had been exercised in the case of Adonibezek; or, in other words, that Agag had made himself infamous by the same treatment of some prisoners of distinction (probably Israelites) as he now received from Samuel. The unusual mode in which his death was inflicted strongly supports this conclusion.

AGAGITE, used as a Gentile name for Amalekite in Est. iii. 1, 10; viii. 3, 5.

AGAPE, AGAPĒ (ἀγάπη, ἀγάπαι), the Greek term for love, used by ecclesiastical writers (most frequently in the plural) to signify the social meal of the primitive Christians, which generally accompanied the Eucharist. Much learned research has been spent in tracing the origin of this custom; but though considerable obscurity may rest on the details, the general historical connection is tolerably obvious. It is true that the *ἔρανοι* and *ἐραπιαί*, and other similar institutions of Greece and Rome, presented some points of resemblance which facilitated both the adoption and

the abuse of the Agapæ by the Gentile converts of Christianity; but we cannot consider them as the direct models of the latter. If we reflect on the profound impression which the transactions of 'the night on which the Lord was betrayed' (1 Cor. xi. 23) must have made on the minds of the apostles, nothing can be conceived more natural, or in closer accordance with the genius of the new dispensation, than a wish to perpetuate the commemoration of his death in connection with their social meal (Neander, *Leben Jesu*, p. 613; *History of the Planting, &c. of the Christian Church*, vol. i. 27, Edinb. 1812). The primary celebration of the Eucharist had impressed a sacredness on the previous repast (comp. ἐσθιόντων αὐτῶν, Matt. xxvi. 26; Mark xiv. 22, with μετὰ τὸ δειπνῆσαι, Luke xxii. 20; 1 Cor. xi. 25); and when in this consideration we add the ardent faith and love of the new converts on the one hand, and the loss of property with the disruption of old connections and attachments on the other, which must have heightened the feeling of brotherhood, we need not look further to account for the institution of the Agapæ, at once a symbol of Christian love and a striking exemplification of its benevolent energy. However soon its purity was soiled, at first it was not undeserving of the eulogy pronounced by the great orator of the church—ἔθος κάλλιστον καὶ χρησιμώτατον καὶ γὰρ ἀγάπης ὑπόθεσις ἦν, καὶ πενίας παραμυθία, καὶ πλούτου σωφρονισμὸς, καὶ ταπεινοφροσύνης διδασκαλία. 'A custom most beautiful and most beneficial; for it was a supporter of love, a solace of poverty, a moderator of wealth, and a discipline of humility!'

Thus the common meal and the Eucharist formed together one whole, and were conjointly denominated δείπνον τοῦ κυρίου, δείπνον κυριακόν, and ἀγάπη. They were also signified (according to Mosheim, Neander, and other eminent critics) by the phrases κλώντες ἄρτον (Acts ii. 46), κλάσις τοῦ ἄρτου (Acts ii. 42), κλάσαι ἄρτον (Acts xx. 7). We find the term ἀγάπαι thus applied once, at least, in the New Testament (Jude 12), 'These are spots in your feasts of charity' (ἐν ταῖς ἀγάπαις ὑμῶν). The reading in 2 Pet. ii. 13, is of doubtful authority; 'Spots and blemishes, living luxuriously in their Agapæ' (ἐντροφῶντες ἐν ταῖς ἀγάπαις αὐτῶν); but the common reading is, ἐν ταῖς ἀπάταις αὐτῶν, 'in their own deceivings.' The phrase ἀγάπην ποιεῖν was early employed in the sense of celebrating the Eucharist; thus in the epistle of Ignatius to the church at Smyrna (ἐκκλησία τῆ οὐσῆ ἐν Σμύρνῃ), § viii. οὐκ ἐξόν ἐστὶν χωρὶς τοῦ ἐπισκόπου, οὔτε βαπτίζειν, οὔτε ἀγάπην ποιεῖν. In § vii. ἀγαπᾶν appears to refer more especially to the Agapæ.

By ecclesiastical writers several synonyms are used for the Agapæ, such as συμπόσια (Balsamon, ad Can. xxvii. *Concil. Laodicen.*); κοιναὶ τράπεζαι, εὐωχία, κοιναὶ ἐστιασεῖς, κοινὰ συμπόσια (Chrysostom); δείπνα κοινὰ (Œcumenius); σοσιστία καὶ συμπόσια (Zonaras).

Though the Agapæ usually preceded the Eucharist, yet they are not alluded to in Justin Martyr's description of the latter (*Apol.* i. § 65, 67); while Tertullian, on the contrary, in his account of the Agapæ, makes no distinct mention of the Eucharist. 'The nature of our *Cæna*,' he says, 'may be gathered from its name, which is the Greek term for love (*dilectio*). However much it may cost us, it is real gain to incur such expense

in the cause of piety: for we aid the poor by this refreshment; we do not sit down to it till we have first tasted of prayer to God (*non prius discumbitur, quam oratio ad Deum prægustetur*); we eat to satisfy our hunger; we drink no more than befits the temperate; we feast as those who recollect that they are to spend the night in devotion; we converse as those who know that the Lord is an ear-witness. After water for washing hands, and lights have been brought in, every one is required to sing something to the praise of God, either from the Scriptures or from his own thoughts; by this means, if any one has indulged in excess, he is detected. The feast is closed with prayer. Contributions or oblations of provisions and money were made on these occasions, and the surplus was placed in the hands of the presiding elder (*ὁ προϊστάς*—compare 1 Tim. v. 17, *οἱ προϊστάτες πρεσβύτεροι*), by whom it was applied to the relief of orphans and widows, the sick and destitute, prisoners and strangers (Justin. *Apol.* i. 67).

Allusions to the *κυριακὸν δεῖπνον* are to be met with in heathen writers. Thus Pliny, in his celebrated epistle to the emperor Trajan, after describing the meeting of the Christians for worship, represents them as assembling again at a later hour, ‘*ad capiendum cibum, promiscuum tamen et innoxium.*’ By the phrase ‘*cibum promiscuum*’ (Augustine remarks) we are not to understand merely food partaken in common with others, but common food, such as is usually eaten; the term *innoxium* also intimates that it was perfectly wholesome and lawful, not consisting, for example, of human flesh (for, among other odious imputations, that of cannibalism had been cast upon the Christians; which, to prejudiced minds, might derive some apparent support from a misinterpretation of our Lord’s language in John vi. 53, ‘*Unless ye eat the flesh and drink the blood of the Son of man*’), nor of herbs prepared with incantations and magical rites. Lucian also, in his account of the philosopher Peregrinus, tells us that when imprisoned on the charge of being a Christian, he was visited by his brethren in the faith, who brought with them *δειπνα ποικίλα*, which is generally understood to mean the provisions which were reserved for the absent members of the church at the celebration of the Lord’s Supper. Gesner remarks, on this expression, ‘*Agapas, offerente unoquoque aliquid, quod una consumere; hinc ποικίλα, non à luxu.*’

From the passages in the Epistles of Jude and Peter, already quoted, and more particularly from the language of Paul in 1 Cor. xi., it appears that at a very early period the Agapæ were perverted from their original design: the rich frequently practised a selfish indulgence, to the neglect of their poorer brethren: *ἐκαστος τὸ ἴδιον δεῖπνον προλαμβάνει* (1 Cor. xi. 21); *i.e.* the rich feasted on the provisions they brought, without waiting for the poorer members, or granting them a portion of their abundance. They appear to have imitated the Grecian mode of entertainment called *δειπνον ἀπὸ σπυρίδος* (see Xenophon’s *Memorabilia*, iii. 14; Neander’s *History of the Planting of the Christian Church*, vol. i. (English transl.), p. 292).

On account of these and similar irregularities, and probably in part to elude the notice of their persecutors, the Christians, about the middle of

the second century, frequently celebrated the Eucharist by itself and before daybreak (*antelucanis cœtibus*) (Tertullian, *De Cor. Militis*, § 3). From Pliny’s Epistle it also appears that the Agapæ were suspected by the Roman authorities of belonging to the class of Hætæriæ (*ἑταῖραι*), unions or secret societies, which were often employed for political purposes, and as such denounced by the imperial edicts; for he says (referring to the ‘*cibum promiscuum,*’ &c.) ‘*quod ipsum facere desiisse post edictum meum, quo secundum mandata tua Hætæriæ esse vetueram*’ (Plin. *Ep.* 10, al. 97).

At a still later period the Agapæ were subjected to strict regulation by various councils. Thus by the 28th canon of the Council of Laodicea it was forbidden to hold them in churches: *ἐπι τοὺς δεῖν ἐν τοῖς κυριακοῖς ἢ ἐν ταῖς ἐκκλησίαις τὰς λεγομένας ἀγάπας ποιεῖν, καὶ ἐν τῷ οἴκῳ τοῦ Θεοῦ ἕσθιεν καὶ ἀκούβιτρα (accubitus) στρωννύειν.* At the Council of Carthage (A.D. 397) it was ordered (Can. 29) that none should partake of the Eucharist unless they had previously abstained from food: ‘*Ut sacramenta altaris non nisi à jejuniis hominibus celebrentur;*’ but it is added, ‘*excepto uno die anniversario, quo cœna domini celebratur.*’ This exception favours the supposition that the Agapæ were originally held in close imitation of the Last Supper, *i.e.* before, instead of after, the Eucharist. The same prohibition was repeated in the sixth, seventh, and ninth centuries, at the Council of Orleans (Can. 12), A.D. 533; in the Trullanian Council at Constantinople, A.D. 692; and in the council held at Aix-la-Chapelle, A.D. 816. Yet these regulations were not intended to set aside the Agapæ altogether. In the Council of Gangra in Paphlagonia (about A.D. 360) a curse was denounced (*ἀνδθεμα ἔστω*) on whoever despised the partakers of the Agapæ or refused to join in them. When Christianity was introduced among the Anglo-Saxons by Austin (A.D. 596), Gregory the Great advised the celebration of the Agapæ, in booths formed of the branches of trees, at the consecration of churches.

Besides the Eucharistic Agapæ, three other kinds are mentioned by ecclesiastical writers: 1. *Agapæ natalivæ*, held in commemoration of the martyrs (Theodoret, *Evang. Verit.* viii. pp. 923-924, edit. Schulz); 2. *Agapæ connubiales*, or marriage-feasts (Greg. Naz. *Epist.* i. 14); 3. *Agapæ funerales*, funeral feasts (Greg. Naz. *Carm. X.*), probably similar to the *περὶδειπνον* or *νεκρὶδειπνον* of the Greeks.

In modern times social meetings bearing a resemblance to the Agapæ, and, in allusion to them, termed Love-feasts, have been regularly held by the Church of the United Brethren, or Moravians, and the Wesleyan Methodists; also in Scotland, by the followers of Mr. Robert Sandeman.

(The following works may be consulted: Haller’s *Notes and Discourses*, vol. iii. disc. 6, 1736; Auguste, *Handbuch der Christlichen Archæologie*, Leipz. 1836-1837; Gieseler, *Lehrbuch der Kirchengeschichte*, Bonn, 1831-1840 (this work has been translated in America, but is not yet completed in the original); Neander, *Allgemeine Geschichte*, &c., Hamburg, 1825-1840; Drescher, *De Veterum Christianorum Agapis*, Giessen, 1824; Bruns, *Canones Apostolorum et Concilii*

iv.-vii., Berolini, 1839; Sniceri *Thesaurus*, s. v. ἀγάθη, κλάσις.—J. E. R.

AGATE (אֶבֶן; Sept. ἀγάθη; Vulg. *achates*), a precious or rather ornamental stone, which was one of the in the pectoral of the high-priest (Exod. xxviii. 19; xxxix. 12). The word *agate*, in-
deed, occurs also in Isa. liv. 12, and Ezek. xxvii. 6, in our translation; but in the original the word in these texts is altogether different, being אֶבֶן כִּכְרִי [ΚΑΙΚΚΩ]. It seems not to have been questioned that some stone of the agate kind is intended. This stone is popularly known in this country under the name of Scotch pebble. Theophrastus describes the agate as 'an elegant stone, which took its name from the river Achates (now the Drillo in the Val di Noto) in Sicily, and was sold at a great price' (καλὸς καὶ λίθος καὶ ὁ Ἀχάτης ὁ ἀπὸ τοῦ Ἀχάτου ποταμοῦ τοῦ ἐν Συκελίᾳ καὶ πωλεῖται τίμιος, 58). This, no doubt, means that the stone was first found by the Greeks in the Achates. But it must have been known long before in the East; and, in fact, there are few countries in which agates of some quality or other are not produced. The finest are those of India; they are plentiful, and sometimes fine, in Italy, Spain, and Germany; but those found in this country are seldom good.

We have no evidence that agates were found in Palestine. Those used in the desert were doubtless brought from Egypt. Pliny says that those found in the neighbourhood of Thebes were usually red, veined with white. He adds that these, as well as most other agates, were deemed to be effectual against scorpions; and gives some curious accounts of the pictorial delineations which the variegations of agates occasionally assumed. Many such instances are produced by later authors. Agate is one of the numerous modifications of form under which silicea presents itself, almost in a state of purity, forming 98 per cent. of the entire mineral. The siliceous particles are not so arranged as to produce the transparency of rock crystal, but a semi-pellucid, sometimes almost opaque substance, with a resinous or waxy fracture; and the various shades of colour arise from minute quantities of iron. The same stone sometimes contains parts of different degrees of translucency, and of various shades of colour; and the endless combinations of these produce the beautiful and singular internal forms, from which, together with the high polish they are capable of receiving, agates acquire their value as precious stones. Agates are usually found in detached rounded nodules in that variety of the trap rocks called amygdaloid or mandelstein, and occasionally in other rocks. Some of the most marvellous specimens on record were probably merely fancied, and possibly some were the work of art, as it is known that agates may be artificially stained. From Pliny we learn that in his time agates were less valued than they had been in more ancient times (*Hist. Nat.* xxxvii. 10). The varieties of the agate are numerous, and are now, as in the time of Pliny, arranged according to the colour of their ground. The Scripture text shows the early use of this stone for engraving; and several antique agates, engraved with exquisite beauty, are still preserved in the cabinets of the curious.

AGE. [CHRONOLOGY; ETERNITY; GENERATION; LONGEVITY.]

AGE, OLD. The strong desire of a protracted life, and the marked respect with which aged persons were treated among the Jews, are very often indicated in the Scriptures. The most striking instance which Job can give of the respect in which he was once held, is that *even* old men stood up as he passed them in the streets (Job xxix. 8), the force of which is illustrated by the injunction in the law, 'Before the hoary head thou shalt stand up, and shalt reverence the aged' (Lev. xix. 30). Similar injunctions are repeated in the Apocrypha, so as to show the deportment expected from young men towards their seniors in company. Thus, in describing a feast, the author of *Ecclesiasticus* (xxxii. 3, 7) says, 'Speak thou that art the elder, for it becometh thee. Speak, young man, if there be need of thee, and yet scarcely, when thou art twice asked.'

The attainment of old age is constantly promised or described as a blessing (Gen. xv. 15; Job v. 26), and communities are represented as highly favoured in which old people abound (Isa. lxx. 20; Zech. viii. 4, 9), while premature death is denounced as the greatest of calamities to individuals, and to the families to which they belong (1 Sam. ii. 32); the aged are constantly supposed to excel in understanding and judgment (Job xii. 29; xv. 10; xxxii. 9; 1 Kings xii. 6, 8), and the mercilessness of the Chaldeans is expressed by their having 'no compassion' upon the 'old man, or him who stooped for age' (2 Chron. xxxvi. 17).

The strong desire to attain old age was necessarily in some degree connected with or resembled the respect paid to aged persons; for people would scarcely desire to be old, were the aged neglected or regarded with mere sufferance.

Michaelis, carrying out a hint of Montesquieu, fancies that veneration for old age is 'peculiarly suitable to a democracy,' and, consequently, 'to the republican circumstances of the Israelites.' He adds, 'In a monarchy or aristocracy, it is birth and office alone which give rank. The more pure a democracy is, the more are all on an equal footing; and those invested with authority are obliged to bear that equality in mind. Here great actions confer respect and honour; and the right discharge of official duties, or the arrival of old age, are the only sources of rank. For how else can rank be established among those who have no official situation, and are by birth perfectly equal' (*Mos. Recht.*, art. cxl.). This is ingenious, and partly true. It would perhaps be wholly so, if, instead of connecting it with 'republican circumstances,' the respect for age were rather regarded in connection with a certain state of society, short of high civilization, in which the sources of distinction, from whatever causes, are so limited, that room is left for the natural condition of age itself to be made a source of distinction. Of all marks of respect that to age is most willingly paid; because every one who does homage to age, may himself, eventually, become an object of such homage. We almost invariably observe that where civilization advances, and where, in consequence, the claims to respect are multiplied, the respect for old age in itself, diminishes; and, like other conditions, it is estimated by the positive qualities which it exhibits. In the East, at present, this respect is manifested *under every* form of government. In the United States the aged are certainly not treated with *more* consideration than under the monarchical and

aristocratical governments of Europe. Professor C. Stowe (in *Am. Bib. Repos.*), who had unusual means of comparison, says they are there treated with *less*; and this seems to prove satisfactorily, that it is rather the condition of civilization than the condition of government, which produces the greater or less respect for age.

Attention to age was very general in ancient times; and is still observed in all such conditions of society as those through which the Israelites passed. Among the Egyptians, the young men rose before the aged, and always yielded to them the first place (Herod. ii. 80). The youth of Sparta did the same, and were silent—or, as the Hebrews would say, laid their hand upon their mouth—whenever their elders spoke. At Athens, and in other Greek states, old men were treated with corresponding respect. In China deference for the aged, and the honours and distinctions awarded to them, form a capital point in the government (*Mém. sur les Chinois*, vol. i. p. 450); and among the Moslems of Western Asia, whose usages offer so many analogies to those of the Hebrews, the same regard for seniority is strongly shown. Among the Arabs, it is very seldom that a youth can be permitted to eat with men (Lamé, *Arabian Nights*, c. xi. note 26). With the Turks, age, even between brothers, is the object of marked deference (Urquhart, *Spirit of the East*, ii. 471).

In all such instances, which might be accumulated without number, we see the respect for age providentially implanted the most strongly in those states of social existence in which some such sentiment is necessary to secure for men of decayed physical powers, that safety and exemption from neglect, which are ensured to them in higher conditions of civilization by the general rather than the particular and exemptive operation of law and softened manners.

AGMON (אָמוֹן) occurs in Job xl. 21; xli. 2; Isa. ix. 14; xix. 15; lviii. 5; in the first of which passages it is translated in our authorized version by *flag*; in the second by *hook*; in the two next by *rush*; and in the last by *bulrush*. As no plant is known under this name in the Hebrew or cognate languages, its nature has been sought for by tracing the word to its root, and by judging of its nature from the context. Thus אָמוֹן *agom* is said to mean a lake or pool of water, also a reed; and in Arabic أجْمَان, pronounced *ijam*, is translated reed-bed, cane-bed. *Agom* is also considered to be derived from the same root as אָמוֹן *goma*, the papyrus. Some have even concluded that both names indicate the same thing, and have translated them by *juncus*, or *rush*.

Celsius is of opinion that in all the above passages *agmon* should be translated by *arundo*, or reed. Dr. Harris (art. 'Reed') has suggested that in Job xli. 2, instead of 'Canst thou put an *hook* into his nose,' we should read 'Canst thou tie up his mouth with a *rush rope*,' as had previously been suggested by others (Celsius, *Hiero-Bot.* vol. i. 467); and that in ver. 20 we should read 'out of his nostrils goeth smoke, and the *rushes* are kindled before it,' instead of 'as out of a seething pot or caldron,' as in the authorized version.

Lobo, in his *Voyage d' Abyssinie*, speaking of the Red Sea, says, 'Nous ne l'avons pas jamais vue rouge, que dans les lieux où il y a beaucoup de Gouemon.' 'Il y a beaucoup de cette herbe dans la Mer rouge.' What this herb is does not elsewhere appear. Forskal applies the name of *ghobeibe* to a species of arundo, which he considered closely allied to *A. phragmites*, the plant which Celsius conceived to be the *agmon* of Scripture. M. Bové, in his *Voyage Botanique en Egypte*, observed, especially on the borders of the Nile, quantities of *Saccharum ægyptiacum* and of *Arundo ægyptiaca*, which is, perhaps, only a variety of *A. donax*, the cultivated Spanish or Cyprus reed, or, as it is usually called in the south of Europe, Canna and Cana. In the neighbourhood of Cairo he found *Poa cynosuroides* (the *koosha*, or *cusa*, or sacred grass of the Hindoos), which, he says, serves 'aux habitans pour faire des cordes, chauffer leurs fours, et cuire des briques et poteries. Le *Saccharum cylindricum* est employé aux mêmes usages.' The Egyptian species of arundo is probably the *A. isiaca* of Delile, which is closely allied to *A. phragmites*, and its uses may be supposed to be very similar to those of the latter. This species is often raised to the rank of a genus under the name of *phragmites*, so named from being employed for making partitions, &c. It is about six feet high, with annual stems, and is abundant about the banks of pools and rivers, and in marshes. The panicle of flowers is very large, much subdivided, a little drooping and waving in the wind. The plant is used for thatching, making screens, garden fences, &c.; when split it is made into string, mats, and matches. It is the *gemeine rohr* of the Germans, and the *Canna or Cana palustre* of the Italians and Spaniards.

Any of the species of reed here enumerated will suit the different passages in which the word *agmon* occurs; but several species of *saccharum*, growing to a great size in moist situations, and reed-like in appearance, will also fulfil all the conditions required, as affording shelter for the behemoth or hippopotamus, being convertible into ropes, forming a contrast with their hollow stems to the solidity and strength of the branches of trees, and when dry easily set on fire; and when in flower their light and feathery inflorescence may be bent down by the slightest wind that blows.—J. F. R.

AGONY (Ἄγωγία), a word generally denoting *contest*, and especially the contests by wrestling, &c. in the public games; whence it is applied metaphorically to a severe *struggle* or *conflict* with pain and suffering. *Agony* is the actual struggle with present evil, and is thus distinguished from *anguish*, which arises from the reflection on evil that is past. In the *New Testament* the word is only used by Luke (xx. 44), and is employed by him with terrible significance to describe the fearful struggle which our Lord sustained in the garden of Gethsemane. The circumstances of this mysterious transaction are recorded in Matt. xxvi. 36-46; Mark xiv. 32-42; Luke xx. 39-48; Heb. v. 7, 8. None of these passages, taken separately, contains a full history of our Saviour's agony. Each of the three Evangelists has omitted some particulars which the others have recorded, and all are very brief. The passage in Hebrews is only an incidental notice. The three Evangelists appear to have had the

same design, namely, to convey to their readers an idea of the intensity of the Lord's distress; but they compass it in different ways. Luke alone notices the agony, the bloody sweat, and the appearance of an angel from heaven strengthening him. Matthew and Mark alone record the change which appeared in his countenance and manner, the complaint which he uttered of the overpowering sorrows of his soul, and his repetition of the same prayer. All agree that he prayed for the removal of what he called 'this cup,' and are careful to note that he qualified this earnest petition by a preference of his Father's will to his own.

All the circumstances of this wonderful mental conflict have been minutely and ably examined by Dr. Lewis Mayer, of New York, in the *Am. Bib. Repository* for April, 1841. We are necessitated to confine our attention to the most essential points, the cause and nature of this agony.

Jesus himself intimates the cause of his overwhelming distress in the prayer, 'If it be possible, let this cup pass from me;' the cup which his Father had appointed for him; and the question is, what does he mean by 'this cup.' Doddridge and others think that he means the instant agony, the trouble that he then actually endured. But this is solidly answered by Dr. Mayer, who shows, by reference to John xviii. 18, that the cup respecting which he prayed was one that was then before him, which he had not yet taken up to drink, and which he desired, if possible, that the Father should remove. It could, therefore, be no other than the scene of suffering upon which he was about to enter. It was the death which the Father had appointed for him—the death of the cross—with all the attending circumstances which aggravated its horror; that scene of woe which began with his arrest in the garden, and was consummated by his death on Calvary. Jesus had long been familiar with this prospect, and had looked to it as the appointed termination of his ministry (Matt. xvi. 21; xvii. 9-12; xx. 17, 19, 28; Mark x. 32-34; John x. 18; xii. 32, 33). But when he looked forward to this destination, as the hour approached, a chill of horror sometimes came over him, and found expression in external signs of distress (John xii. 27; comp. Luke xii. 49, 50). But on no occasion did he exhibit any very striking evidence of perplexity or anguish. He was usually calm and collected; and if at any time he gave utterance to feelings of distress and horror, he still preserved his self-possession, and quickly checked the desire which nature put forth to be spared so dreadful a death. It is, therefore, hardly to be supposed that the near approach of his sufferings, awful as they were, apart from everything else, could alone have wrought so great a change in the mind of Jesus and in his whole demeanour, as soon as he had entered the garden. It is manifest that something more than the cross was now before him, and that he was now placed in a new and hitherto untried situation. Dr. Mayer says: 'I have no hesitation in believing that he was here put upon the trial of his obedience. It was the purpose of God to subject the obedience of Jesus to a severe ordeal, in order that, like gold tried in the furnace, it might be an act of more perfect and illustrious virtue; and for this end he permitted him to be assailed by the fiercest tempta-

tion to disobey his will and to refuse the appointed cup. In pursuance of this purpose, the mind of Jesus was left to pass under a dark cloud, his views lost their clearness, the Father's will was shrouded in obscurity, the cross appeared in ten-fold horror, and nature was left to indulge her feelings, and to put forth her reluctance.'

Dr. Mayer admits that the sacred writers have not explained what that was, connected in the mind of Jesus with the death of the cross, which at this time excited in him so distressing a fear. 'Pious and holy men have looked calmly upon death in its most terrific forms. But the pious and holy man has not had a world's salvation laid upon him; he has not been required to be absolutely perfect before God; he has known that, if he sinned, there was an advocate and a ransom for him. But nothing of this consolation could be presented to the mind of Jesus. He knew that he must die, as he had lived, without sin; but if the extremity of suffering should so far prevail as to provoke him into impatience or murmuring, or into a desire for revenge, this would be sin; and if he sinned, all would be lost, for there was no other Saviour. In such considerations may probably be found the remote source of the agonies and fears which deepened the gloom of that dreadful night.' Under another head [BLOODY SWEAT] will be found the considerations suggested by one of the remarkable circumstances of this event.

AGORA (*ἄγορά*), a word of frequent occurrence in the New Testament: it denotes generally any place of public resort in towns and cities where the people came together; and hence more specially it signifies, 1. A public place, a broad street, &c., as in Matt. xi. 16; xx. 3; xxiii. 7; Mark vi. 56; xii. 38; Luke vii. 32; xi. 43; xx. 46. 2. A forum or market-place, where goods were exposed for sale, and assemblies or public trials held, as in Acts xvi. 19; xvii. 17. In Mark vii. 4, it is doubtful whether *ἀγορά* denotes the market itself, or is put for that which is brought from the market; but the known customs of the Jews suggest a preference of the former signification.

AGORAIOS (*ἄγοραίος*), a Greek word signifying the things belonging to, or persons frequenting, the *Agora*. In Acts xix. 38, it is applied to the days on which public trials were held in the forum; and in ch. xvii. 5, it denotes idlers, or persons lounging about in the markets and other places of public resort. There is a peculiar force in this application of the word, when we recollect that the market-places or bazaars of the East were, and are at this day, the constant resort of unoccupied people, the idle, and the newsmongers.

AGRAMMATOS (*ἀγράμματος*), a Greek word meaning *unlearned, illiterate*. In Acts iv. 13, the Jewish literati apply the term to Peter and John, in the same sense in which they asked, with regard to our Lord himself, 'How knoweth this man letters, having never learned' (John vii. 15). In neither case did they mean to say that they had been altogether without the benefits of the common education, which consisted in reading and writing, and in an acquaintance with the sacred books; but that they were not learned men, had not sat at the feet of any of the great doctors of the law, and had not been

instructed in the mysteries and refinements of their peculiar learning and literature.

AGRARIAN LAW. To this, or some such heading, belongs the consideration of the peculiar laws by which the distribution and tenure of land were regulated among the Hebrews; while the modes in which the land was cultivated belong to **AGRICULTURE.**

It has been the custom to regard the Hebrews as a pastoral people until they were settled in Palestine. In a great degree they doubtless were so; and when they entered agricultural Egypt, the land of Goshen was assigned to them expressly because that locality was suited to their pastoral habits (Gen. xlvii. 4-6). These habits were substantially maintained; but it is certain that they became acquainted with the Egyptian processes of culture; and it is more than probable that they raised for themselves such products of the soil as they required for their own use. We may, indeed, collect that the portion of their territory which lay in the immediate vicinity of the Nile was placed by them under culture (Deut. xi. 10), while the interior, with the free pastures of the desert beyond their immediate territory, sufficed abundantly for their cattle (1 Chron. vii. 21). This partial attention to agriculture was in some degree a preparation for the condition of cultivators, into which they were destined eventually to pass. While the Israelites remained in a state of subjection in Egypt, the maintenance of their condition as shepherds was highly instrumental in keeping them distinct and separate from the Egyptians, who were agriculturists, and had a strong dislike to pastoral habits (Gen. xli. 34). But when they became an independent and sovereign nation, their separation from other nations was to be promoted by inducing them to devote their chief attention to the culture of the soil. A large number of the institutions given to them had this object of separation in view. Among these, those relating to agriculture—forming the agrarian law of the Hebrew people—were of the first importance. They might not alone have been sufficient to secure the end in view; but no others could have been effectual without them; for, without such attention to agriculture as would render them a self-subsisting nation, a greater degree of intercourse with the neighbouring and idolatrous nations must have been maintained than was consistent with the primary object of the Mosaic institutions. The commonest observation suffices to show how much less than others agricultural communities are open to external influences, and how much less disposed to cultivate intercourse with strangers.

It was, doubtless, in subservience to this object, and to facilitate the change, that the Israelites were put in possession of a country already in a state of high cultivation (Deut. vi. 11). And it was in order to retain them in this condition, to give them a vital interest in it, and to make it a source of happiness to them, that a very peculiar agrarian law was given to them. In stating this law, and in declaring it to have been in the highest degree wise and salutary, regard must be had to its peculiar object with reference to the segregation of the Hebrew people: for there are points in which this and other Mosaic laws were unsuited to general use, some by the very circumstances

which adapted them so admirably to their special object. When the Israelites were numbered just before their entrance into the land of Canaan, and were found (exclusive of the Levites) to exceed 600,000 men, the Lord said to Moses: 'Unto these the land shall be divided for an inheritance, according to the number of names. To many thou shalt give the more inheritance, and to the few thou shalt give the less inheritance; to every one shall his inheritance be given according to those that were numbered of him. Notwithstanding the land shall be divided by lot: according to the names of the tribes of their fathers shall they inherit' (Num. xxvi. 33-54). This equal distribution of the soil was the basis of the agrarian law. By it provision was made for the support of 600,000 yeomanry, with (according to different calculations) from sixteen to twenty-five acres of land to each. This land they held independent of all temporal superiors, by direct tenure, from Jehovah their sovereign, by whose power they were to acquire the territory, and under whose protection they were to enjoy and retain it. 'The land shall not be sold for ever, for the land is mine, saith the Lord: ye are strangers and sojourners with me' (Lev. xxv. 23). Thus the basis of the constitution was an equal agrarian law. But this law was guarded by other provisions equally wise and salutary. The accumulation of debt was prevented, first, by prohibiting every Hebrew from accepting of interest from any of his fellow-citizens (Lev. xxv. 35, 36); next, by establishing a regular discharge of debts every seventh year; and, finally, by ordering that no lands could be alienated for ever, but must, on each year of Jubilee, or every seventh Sabbatic year, revert to the families which originally possessed them. Thus, without absolutely depriving individuals of all temporary dominion over their landed property, it re-established, every fiftieth year, that original and equal distribution of it, which was the foundation of the national polity; and as the period of this reversion was fixed and regular, all parties had due notice of the terms on which they negotiated; so that there was no ground for public commotion or private complaint.

This law, by which landed property was released in the year of Jubilee from all existing obligations, did not extend to houses in towns, which, if not redeemed within one year after being sold, were alienated for ever (Lev. xv. 29, 30). This must have given to property in the country a decided advantage over property in cities, and must have greatly contributed to the essential object of all these regulations, by affording an inducement to every Hebrew to reside on and cultivate his land. Further, the original distribution of the land was to the several tribes according to their families, so that each tribe was, so to speak, settled in the same county, and each family in the same barony or hundred. Nor was the estate of any family in one tribe permitted to pass into another, even by the marriage of an heiress (Num. xxvii.); so that not only was the original balance of property preserved, but the closest and dearest connections of affinity attached to each other the inhabitants of every vicinage.

It often happens that laws in appearance similar have in view entirely different objects. In Europe the entailment of estates in the direct line is designed to encourage the formation of large

properties. In Israel the effect was entirely different, as the entail extended to all the small estates into which the land was originally divided, so that they could not legally be united to form a large property, and then entailed upon the descendants of him by whom the property was formed. This division of the land in small estates among the people, who were to retain them in perpetuity, was eminently suited to the leading objects of the Hebrew institutions. It is allowed on all hands that such a condition of landed property is in the highest degree favourable to high cultivation, and to increase of population, while it is less favourable to pasturage. The two first were objects which the law had in view, and it did not intend to afford undue encouragement to the pastoral life, while the large pastures of the adjacent deserts and of the commons secured the country against such a scarcity of cattle as the division of the land into small heritages has already produced in France.

For this land a kind of quit-rent was payable to the sovereign proprietor, in the form of a tenth or tithe of the produce, which was assigned to the priesthood [TIENES]. The condition of military service was also attached to the land, as it appears that every freeholder (Deut. xx. 5) was obliged to attend at the general muster of the national army, and to serve in it, at his own expense (often more than repaid by the plunder), as long as the occasion required. In this direction, therefore, the agrarian law operated in securing a body of 600,000 men, inured to labour and industry, always assumed to be ready, as they were bound, to come forward at their country's call. This great body of national yeomanry, every one of whom had an important stake in the national independence, was officered by its own hereditary chiefs, heads of tribes and families (Comp. Exod. xviii. and Num. xxxi. 14); and must have presented an insuperable obstacle to treacherous ambition and political intrigue, and to every attempt to overthrow the Hebrew commonwealth and establish despotic power. Nor were these institutions less wisely adapted to secure the state against foreign violence, and at the same time prevent offensive wars and remote conquests. For while this vast body of hardy yeomanry were always ready to defend their country, when assailed by foreign foes, yet, being constantly employed in agriculture, attached to domestic life, and enjoying at home the society of the numerous relatives who peopled their neighbourhood, war must have been in a high degree alien to their tastes and habits. Religion also took part in preventing them from being captivated by the splendour of military glory. On returning from battle, even if victorious, in order to bring them back to more peaceful feelings after the rage of war, the law required them to consider themselves as polluted by the slaughter, and unworthy of appearing in the camp of Jehovah until they had employed an entire day in the rites of purification (Num. xix. 13-16; xxxi. 19). Besides, the force was entirely infantry; the law forbidding even the kings to multiply horses in their train (Deut. xvii. 16); and this, with the ordinance requiring the attendance of all the males three times every year at Jerusalem, proved the intention of the legislator to confine the natives within the limits of the Promised Land, and rendered long and distant

wars and conquests impossible without the virtual renunciation of that religion which was incorporated with their whole civil polity, and which was, in fact, the charter by which they held their property and enjoyed all their rights (Graves's *Lectures on the Pentateuch*, lect. iv.; Lowman's *Civil Gov. of the Heb.* c. iii. iv.; Michaelis, *Mos. Recht*, i. 210, sqq.).

AGRICULTURE. The antiquity of agriculture is indicated in the brief history of Cain and Abel, when it tells us that the former was a 'tiller of the ground,' and brought some of the fruits of his labour as an offering to God (Gen. iv. 2, 3), and that part of the ultimate curse upon him was: 'when thou tillest the ground, it shall not henceforth yield to thee her strength' (iv. 12). Of the actual state of agriculture before the deluge we know nothing. It must have been modified considerably by the conditions of soil and climate, which are supposed by many to have undergone some material alterations at the flood. Whatever knowledge was possessed by the old world was doubtless transmitted to the new by Noah and his sons; and that this knowledge was considerable is implied in the fact that one of the operations of Noah, when he 'began to be a husbandman,' was to plant a vineyard, and to make wine with the fruit (Gen. ix. 2). There are few agricultural notices belonging to the patriarchal period, but they suffice to show that the land of Canaan was in a state of cultivation, and that the inhabitants possessed what were at a later date the principal products of the soil in the same country. It is reasonable therefore to conclude that the modes of operation were then similar to those which we afterwards find among the Jews in the same country, and concerning which our information is more exact.

In giving to the Israelites possession of a country already under cultivation, it was the Divine intention that they should keep up that cultivation, and become themselves an agricultural people; and in doing this they doubtless adopted the practices of agriculture which they found already established in the country. This may have been the more necessary, as agriculture is a practical art; and those of the Hebrews who were acquainted with the practices of Egyptian husbandry had died in the wilderness; and even had they lived, the processes proper to a hot climate and alluvial soil, watered by river inundation, like that of Egypt, although the same in essential forms, could not have been altogether applicable to so different a country as Palestine.

As the nature of the seasons lies at the root of all agricultural operations, it should be noticed that the variations of sunshine and rain, which with us extend throughout the year, are in Palestine confined chiefly to the latter part of autumn and the winter. During all the rest of the year the sky is almost uninterruptedly cloudless, and rain very rarely falls. The autumnal rains usually commence at the latter end of October or beginning of November, not suddenly, but by degrees, which gives opportunity to the husbandman to sow his wheat and barley. The rains continue during November and December, but afterwards they occur at longer intervals; and rain is rare after March, and almost never occurs as late as May. The cold of winter is not severe; and as the ground is never frozen, the labours of the hus-

bandman are not entirely interrupted. Snow falls in different parts of the country, but never lies long on the ground. In the plains and valleys the heat of summer is oppressive, but not in the more elevated tracts. In these high grounds the nights are cool, often with heavy dew. The total absence of rain in summer soon destroys the verdure of the fields, and gives to the general landscape, even in the high country, an aspect of drought and barrenness. No green thing remains but the foliage of the scattered fruit-trees, and occasional vineyards and fields of millet. In autumn the whole land becomes dry and parched; the cisterns are nearly empty; and all nature, animate and inanimate, looks forward with longing for the return of the rainy season. In the hill country the time of harvest is later than in the plains of the Jordan and of the sea-coast. The barley harvest is about a fortnight earlier than that of wheat. In the plain of the Jordan the wheat harvest is early in May; in the plains of the coast and of Esdraelon, it is towards the latter end of that month; and in the hills, not until June. The general vintage is in September, but the first grapes ripen in July; and from that time the towns are well supplied with this fruit (Robinson, *Biblical Researches*, ii. 96-100).

SOIL, &c.—The geological characters of the soil in Palestine have never been satisfactorily stated; but the different epithets of description which travellers employ, enable us to know that it differs considerably, both in its appearance and character, in different parts of the land; but wherever soil of any kind exists, even to a very slight depth, it is found to be highly fertile. As parts of Palestine are hilly, and as hills have seldom much depth of soil, the mode of cultivating them in terraces was anciently, and is now, much employed. A series of low stone walls, one above another, across the face of the hill, arrest the soil brought down by the rains, and afford a series of levels for the operations of the husbandman. This mode of cultivation is usual in Lebanon, and is not unfrequent in Palestine, where the remains of terraces across the hills, in various parts of the country, attest the extent to which it was anciently carried. This terrace cultivation has necessarily increased or declined with the population. If the people were so few that the valleys afforded sufficient food for them, the more difficult culture of the hills was neglected; but when the population was too large for the valleys to satisfy with bread, then the hills were laid under cultivation.

In such a climate as that of Palestine, water is the great fertilizing agent. The rains of autumn and winter, and the dews of spring, suffice for the ordinary objects of agriculture; but the ancient inhabitants were able, in some parts, to avert even the aridity which the summer droughts occasioned, and to keep up a garden-like verdure, by means of aqueducts communicating with the brooks and rivers (Ps. i. 3; lxv. 10; Prov. xxi. 1; Isa. xxx. 25; xxxii. 2, 20; Hos. xii. 11). Hence springs, fountains, and rivulets were as much esteemed by husbandmen as by shepherds (Josh. xv. 19; Judg. i. 15). The soil was also cleared of stones, and carefully cultivated; and its fertility was increased by the ashes to which the dry stubble and herbage were occasionally reduced by being burned over the surface of the ground (Prov. xxiv. 31; Isa. vii. 23; xxxii. 13). Dung, and, in the neighbour-

hood of Jerusalem, the blood of animals, were also used to enrich the soil (2 Kings ix. 37; Ps. lxxxiii. 10; Isa. xxv. 10; Jer. ix. 22; Luke xiv. 34, 35).

That the soil might not be exhausted, it was ordered that every seventh year should be a sabbath of rest to the land: there was to be no sowing or reaping, no pruning of vines or olives, no vintage or gathering of fruits; and whatever grew of itself was to be left to the poor, the stranger, and the beasts of the field (Lev. xxv. 1-7; Deut. xv. 1-10). But such an observance required more faith than the Israelites were prepared to exercise. It was for a long time utterly neglected (Lev. xxvi. 34, 35; 2 Chron. xxxvi. 21), but after the Captivity it was more observed. By this remarkable institution the Hebrews were also trained to habits of economy and foresight, and invited to exercise a large degree of trust in the bountiful providence of their Divine King.

FIELDS.—Under the term *דגן* *dagan*, which we translate 'grain' and 'corn,' the Hebrews comprehended almost every object of *field* culture. Syria, including Palestine, was regarded by the ancients as one of the first countries for corn (Pliny, *Hist. Nat.* xviii. 7). Wheat was abundant and excellent; and there is still one bearded sort, the ear of which is three times as heavy, and contains twice as many grains, as our common English wheat (Irby and Mangles, p. 472). Barley was also much cultivated, not only for bread, but because it was the only kind of corn which was given to beasts; for oats and rye do not grow in warm climates. Hay was not in use; and therefore the barley was mixed with chopped straw to form the food of cattle (Gen. xxiv. 25, 32; Judg. xix. 19, &c.) Other kinds of field culture were millet, spelt, various species of beans and peas, pepperwort, cummin, cucumbers, melons, flax, and, perhaps, cotton. Many other articles might be mentioned as being now cultivated in Palestine; but, as their names do not occur in Scripture, it is difficult to know whether they were grown there in ancient times, or not.

Anciently, as now, in Palestine and the East the arable lands were not divided into fields by hedges, as in this country. The ripening products therefore presented an expanse of culture unbroken, although perhaps variegated, in a large view, by the difference of the products grown. The boundaries of lands were therefore marked by stones as landmarks, which, even in patriarchal times, it was deemed a heinous wrong to remove (Job xxiv. 2); and the law pronounced a curse upon those who, without authority, removed them (Deut. xix. 14; xxvii. 17). The walls and hedges which are occasionally mentioned in Scripture belonged to orchards, gardens, and vineyards.

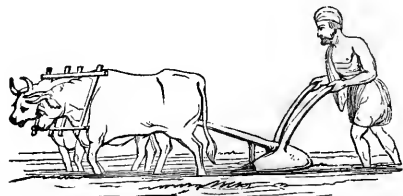

AGRICULTURAL OPERATIONS.—Of late years much light has been thrown upon the agri-

cultural operations and implements of ancient times, by the discovery of various representations on the sculptured monuments and painted tombs of Egypt. As these agree surprisingly with the notices in the Bible, and, indeed, differ little from what we find employed in Syria and Egypt, it is very safe to receive them as guides on the present subject.

Ploughing.—This has always been a light and superficial operation in the East. At first, the ground was opened with pointed sticks; then, a kind of hoe was employed; and this, in many parts of the world, is still used as a substitute for

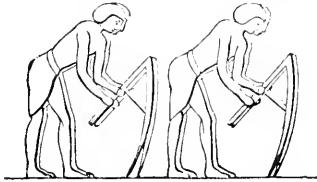

the plough. But the plough was known in Egypt and Syria before the Hebrews became cultivators (Job i. 14). In the East, however, it has always been a light and insignificant implement. At first, it was little more than a stout branch of a tree, from which projected another limb, shortened and pointed. This, being turned into the ground, made the furrow; while at the farther end of the larger branch was fastened a transverse yoke, to which the oxen were harnessed. Afterwards a handle to guide the plough was added. Thus the plough consisted of—1. the pole; 2. the point or share; 3. the handle; 4. the yoke. The Syrian plough is, and doubtless was, light enough for a man to carry in his hand (Russell's *Nat. Hist. of Aleppo*, i. 73). We annex a figure of the ancient Egyptian plough, which had the most resemblance

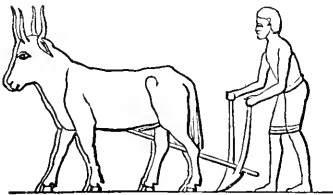

to the one now used (as figured in p. 89), and the comparison between them will probably suggest a fair idea of the plough which was in use among the Hebrews. The following cut (from Mr. Fellows' work on Asia Minor) shows the parts of a

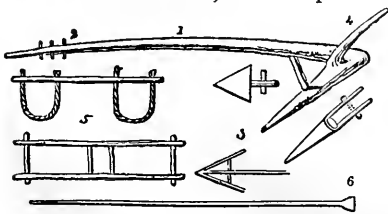

1. The plough. 2. The pole. 3. Shares (various).
4. Handle. 5. Yokes. 6. Ox-goad.

still lighter plough used in Asia Minor and Syria, with but a single handle, and with dif-

ferent shares according to the work it has to execute.

The plough was drawn by oxen, which were sometimes urged by a scourge (Isa. x. 26; Nahum iii. 2); but oftener by a long staff, furnished at one end with a flat piece of metal for clearing the plough, and at the other with a spike for goading the oxen. This ox-goad might be easily used as a spear (Judg. iii. 31; 1 Sam. xiii. 21). Sometimes men followed the plough with hoes to break the clods (Isa. xxviii. 24); but in later times a kind of harrow was employed, which appears to have been then, as now, merely a thick block of wood, pressed down by a weight, or by a man sitting on it, and drawn over the ploughed field.

Sowing.—The ground, having been ploughed as soon as the autumnal rains had mollified the soil, was fit, by the end of October, to receive the seed; and the sowing of wheat continued, in different situations, through November into December. Barley was not generally sown till January and February. The seed appears to have been sown and harrowed at the same time; although sometimes it was ploughed in by a cross furrow.



Ploughing in the Seed.—The Egyptian paintings illustrate the Scriptures by showing that in those soils which needed no previous preparation by the hoe (for breaking the clods) the sower followed the plough, holding in the left hand a basket of seed, which he scattered with the right hand, while another person filled a fresh basket. We also see that the mode of sowing was what we call 'broad-cast,' in which the seed is thrown loosely over the field (Matt. xiii. 3-8). In Egypt, when the levels were low, and the water had continued long upon the land, they often dispensed with the plough altogether; and probably, like the present inhabitants, broke up the ground with hoes, or simply dragged the moist mud with bushes after the seed had been thrown upon the surface. To this cultivation without ploughing, Moses probably alludes (Deut. xi. 10), when he tells the Hebrews that the land to which they were going was *not* like the land of Egypt, where they 'sowed their seed and watered it with their foot as a garden of herbs.' It seems however that even in Syria, in sandy soils, they sow without ploughing, and then plough down the seed (Russell's *N. H. of Aleppo*, i. 73, &c.). It does not appear that any instrument resembling our *harrow* was known; the word rendered to *harrow*, in Job xxxix. 10, means literally

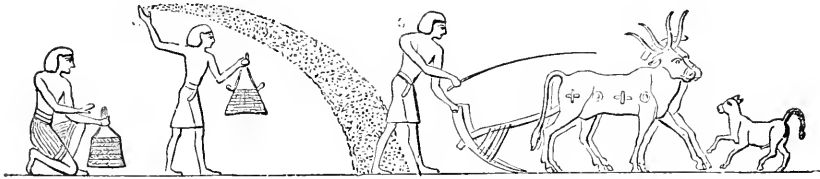

to break the clods, and is so rendered in Isa. xxviii. 24; Hos. x. 11; and for this purpose the means used have been already indicated. The passage in Job, however, is important. It shows that this breaking of the clods was not always by the hand, but that some kind of instrument was drawn by an animal over the ploughed field, most probably the rough log which is still in use.

Harvest.—It has been already mentioned that the time of the wheat harvest in Palestine varies, in different situations, from early in May to late in June; and that the barley harvest is about a fortnight earlier than that of wheat. Among the Israelites, as with all other people, the harvest was a season of joy, and as such is more than once alluded to in Scripture (Ps. cxxvi. 5; Isa. ix. 13).

Reaping.—Different modes of reaping are indicated in Scripture, and illustrated by the Egyptian monuments. In the most ancient times, the corn was plucked up by the roots, which continued

cal of straw, they generally followed the former method; while the Israelites, whose lands derived benefit from the burnt stubble, used the latter; although the practice of cutting off the ears was also

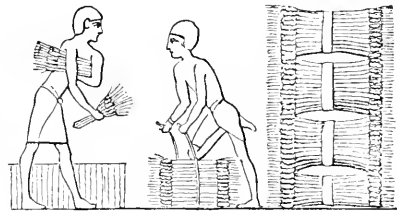

known to them (Job xxiv. 24). Cropping the ears short, the Egyptians did not generally bind them into sheaves, but removed them in baskets. Sometimes, however, they bound them into double sheaves; and such as they plucked up were bound into single long sheaves. The Israelites appear generally to have made up their corn into sheaves (Gen. xxxvii. 7; Lev. xxiii. 10-15; Ruth ii. 7, 15; Job xxiv. 10; Jer. ix. 22; Mich. iv. 12), which were collected into a heap, or removed in a cart (Amos ii. 13) to the threshing-floor. The carts were probably similar to those which are still employed for the same purpose. The sheaves were never made up into shocks, as with us, although the word occurs in our translation of Judg. xv. 5; Job v. 26; for the original term signifies neither a shock composed of a few sheaves standing temporarily in the field, nor a stack of many sheaves in the home yard, properly thatched, to stand for a length of time; but a heap of sheaves laid loosely together, in order to be trodden out as quickly as possible, in the same way as is done in the East at the present day (Brown, *Antiq. of the Jews*, ii. 591).

to be the practice with particular kinds of grain after the sickle was known. In Egypt, at this day, barley and dourra are pulled up by the roots. The choice between these modes of operation was probably determined, in Palestine, by the consideration pointed out by Russell (*N. H. of Aleppo*, i. 74), who states that 'wheat, as well as barley in general, does not grow half as high as in Britain; and is therefore, like other grain, not reaped with the sickle, but plucked up by the roots with the hand. In other parts of the country, where the corn grows ranker, the sickle is used.' When the sickle was used, the wheat was either cropped off under the ear or cut close to the ground. In the former case, the straw was afterwards plucked up

With regard to sickles, there appear to have been two kinds, indicated by the different names *chermesh* (חרמש) and *meggol* (מגול); and the former occurs only in the Pentateuch (Deut. xvi. 9; xxiii. 20), and the latter only in the Prophets (Jer. ii. 16; Joel i. 17), it would seem that the one was the earlier and the other the later instrument. But as we observe two very different kinds of sickles in use among the Egyptians, not only at the same time, but in the same field (see the cut, p. 92), it may have been so with the Jews also. The figures of these Egyptian sickles probably mark the difference between them. One was very much like our common reaping-hook, while the other had more resemblance in its shape to a scythe, and in the Egyptian examples appears to have been toothed. This last is probably the same as the Hebrew *meggol*, which is indeed rendered by *scythe* in the margin of Jer. i. 16. The reapers were the owners and their children, men-

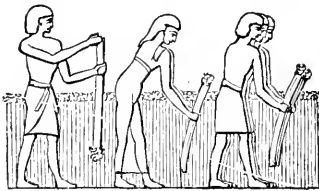

for use; in the latter, the stubble was left and burnt on the ground for manure. As the Egyptians needed not such manure, and were economi-

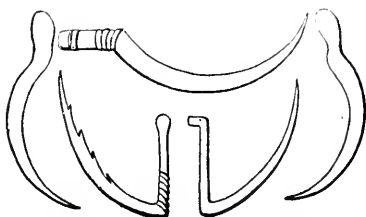

servants and women-servants, and day-labourers (Ruth ii. 4, 6, 21, 23; John iv. 36; James v. 4). Refreshments were provided for them, especially drink, of which the gleaners were allowed to partake (Ruth ii. 9). So in the Egyptian harvest-scenes, we perceive a provision of water in skins, hung against trees, or in jars upon stands, with the reapers drinking, and gleaners applying to share the draught. Among the Israelites, gleanings



were one of the stated provisions for the poor: and for their benefit the corners of the field were left unreaped, and the reapers might not return for a forgotten sheaf. The gleaners, however, were to obtain in the first place the express permission of the proprietor or his steward (Lev. xix. 9, 10; Deut. xxiv. 19; Ruth ii. 2, 7).

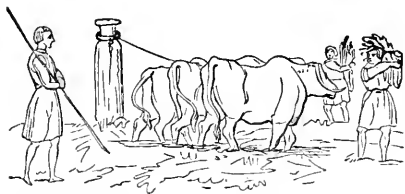

Threshing.—The ancient mode of threshing, as described in Scripture and figured on the Egyptian monuments, is still preserved in Palestine. Formerly the sheaves were conveyed from the field to the threshing-floor in carts; but now they are borne, generally, on the backs of camels and asses. The threshing-floor is a level plot of ground, of a circular shape, generally about fifty feet in diameter, prepared for use by beating down the earth till a hard floor is formed (Gen. i. 10; Judg. vi. 37; 2 Sam. xxiv. 16, 24). Sometimes several of these floors are contiguous to each other. The sheaves are spread out upon them; and the grain is trodden out by oxen, cows, and young cattle, arranged five abreast, and driven in a circle, or rather in all directions, over the floor. This was the common mode in the Bible times; and Moses forbade that the oxen thus employed should be muzzled to prevent them from tasting the corn (Deut. xxv. 4; Isa. xxviii. 28). *Flaits*, or sticks, were only used in threshing small quantities, or for the lighter kinds of grain (Ruth ii. 17; Isa. xxviii. 27). There were, however, some kinds of thresh-

ing-machines, which are still used in Palestine and Egypt. One of them, represented in the annexed figure, is very much used in Palestine. It

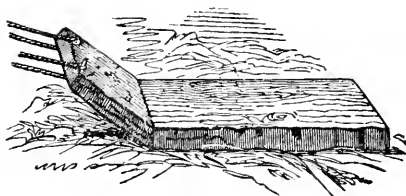

is composed of two thick planks, fastened together side by side, and bent upwards in front. Sharp fragments of stone are fixed into holes bored in the bottom. This machine is drawn over the corn by oxen—a man or boy sometimes sitting on it to increase the weight. It not only separates the grain, but cuts the straw and makes it fit for fodder (2 Kings xiii. 7). This is, most probably, the *Charutz* (חרוץ), or 'corn-drag,' which is mentioned in Scripture (Isa. xxviii. 27; xli. 15; Amos i. 3, rendered 'threshing instrument'), and would seem to have been sometimes furnished with iron points instead of stones. The Bible also notices a machine called a *Moreg*, מורג (2 Sam. xxiv. 22; 1 Chron. xxi. 23; Isa. xli. 15), which is unquestionably the same which bears in Arabic

the name of *Noreg*. This is explained by Freytag (from the Kamoss Lex.) by—'tribulum, instrumentum, quo fruges in area tentatur (in Syria), sive ferreum, sive ligneum.' This machine is not now often seen in Palestine; but is more used in some parts of Syria, and is common in Egypt. It is a sort of frame of wood, in which are inserted three wooden rollers, armed with iron teeth, &c. It bears a sort of seat or chair, in which the driver sits to give the benefit of his weight. It is generally drawn over the corn by two oxen, and separates the grain, and breaks up the straw even more effectually than the drag. In all these processes, the corn is occasionally turned by a fork; and, when sufficiently threshed, is thrown up by the same fork against the wind to separate the grain, which is then gathered up and winnowed.

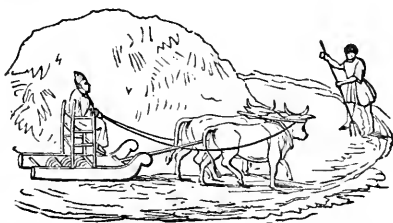

Winnowing.—This was generally accomplished by repeating the process of tossing up the grain against the wind with a fork (Jer. iv. 11, 12), by which the broken straw and chaff were dispersed while the grain fell to the ground. The grain afterwards passed through a sieve to separate the bits of earth and other impurities. After this, it underwent a still further purification, by being tossed up with wooden scoops or short-handed shovels.

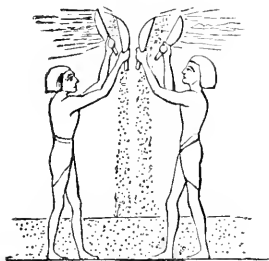

such as we see in Egyptian paintings (Isa. xxx. 21; Jahn, *Biblisches Archiologie*, b. i. ch. i. kap. 4; Winer, *Biblisches Realwörterbuch*, s. v. 'Ackerbau'; Paulsen, *Ackerbau d. Morgenländer*; Surenhusius, *Mischma*, part i.; Ugolini, *De Re Rustica Vett. Hebræorum*, in *Thesaurus*, t. xxix.; Norberg, *De Agricult. Orientali*, in *Opusc. Acad.* iii.; Reynier, *De l'Economie Publique et Rurale des Arabes et des Juifs*; Brown, *Antiquities of the Jews*; Robinson, *Biblical Researches in Palestine*; Wilkinson, *Ancient Egyptians*; *Description de l'Égypte, Antiquités, and Etat Moderne*; Rosellini, *Monumenti dell' Egitto*. Information respecting the actual products and agriculture of Palestine, collected from numerous travellers, may be seen in Kitto's *Pictorial History of Palestine, Physical History*, 'History of the Months.')

AGRIELAIA (Ἀγριελαία; New Test. ἀγριέλαιος). The wild olive-tree is mentioned by St. Paul in Romans xi. 17, 21. Here different opinions have been entertained, not only with respect to the plant, but also with respect to the explanation of the metaphor. One great difficulty has arisen from the same name having been applied to different plants. Thus by Dioscorides (*De Mater. Med.* i. 137) it is stated that the Ἀγριελαία, or wild olive-tree, is by some called Cotinus, and by others, the Ethiopic olive. So, in the notes to Theoph. ed Boda Stapel, p. 224, we read, 'Sed hic κότυνος lego cum Athenæo, id est oleaster. Est vero alius cotinus, frutex, de quo Plinius, xvi. 18. Est et in Apennino frutex qui vocatur Cotinus, ad lineamenta modo conchylii colore insignis.' Hence the wild olive-tree has been confounded with *rhus cotinus*, or Venetian sumach, with which it has no point of resemblance. Further confusion has arisen from the present *Eleagnus angustifolia* of botanists having been at one time called *Olea sylvestris*. Hence it has been inferred that the Ἀγριελαία is this very Eleagnus, *E. angustifolia*, or the narrow-leaved Oleaster-tree of Paradise of the Portuguese. In many points it certainly somewhat resembles the true olive-tree—that is, in the form and appearance of the leaves, in the oblong-shaped fruit (edible in some of the species), also in an oil being expressed from the kernels; but it will not explain the present passage, as no process of grafting will enable the Eleagnus to bear olives of any kind.

If we examine a little further the account given by Dioscorides of the Ἀγριελαία, we find in i. 141, *Περὶ δακρύου ἐλαίας Αἰθιοπικῆς*, that our olives and wild olives exude tears—that is, a gum or resin, like the Ethiopic olive. Here it is important to remark that the wild olive of the Grecians is distinguished from the wild olive of

Ethiopia. What plant the latter may be, it is not perhaps easy to determine with certainty; but Arabian authors translate the name by *zait-al-Soudan*, or the olive of Ethiopia. Other synonyms for it are *louz-al-bur*, or wild almond; and *badam kohee*, i. e. mountain almond. Under the last name the writer has obtained the kernels of the apricot in Northern India, and it is given in Persian works as one of the synonyms of the *bur-kookh*, or apricot, which was originally called apricock and præcocia, no doubt from the Arabic *bur-kookh*. The apricot is extensively cultivated in the Himalayas, chiefly on account of the clear beautiful oil yielded by its kernels, on which account it might well be compared with the olive-tree. But it does not serve better than the Eleagnus to explain the passage of St. Paul.

From the account of Dioscorides, however, it is clear that the Ethiopic was distinguished from the wild, and this from the cultivated olive; and as the plant was well known both to the Greeks and Romans, there was no danger of mistaking it for any other plant except itself in a wild state, that is, the true Ἀγριελαία, Oleaster, or *Olea europæa*, in a wild state. That this is the very plant alluded to by the Apostle seems to be proved from its having been the practice of the ancients to graft the wild upon the cultivated olive tree. Thus Pliny (*Hist. Nat.* xvii. 18) says, 'Aricia peculiare quidem in oleastro est inserere. Quadam æternitate consensescunt proxima adoptioni virga emissa, atque ita alia aurore ex eadem juvenescunt: iterumque et quoties opus sit, ut avis eadem oliveta constant. Inseritur autem oleaster calamo, et inoculatione.' In the 'Pictorial Bible' this practice has already been adduced as explaining the text; and Theophrastus and Columella (*De Re Rust.* v. 9) also refer to it. The apostle, therefore, in comparing the Romans to the wild olive tree grafted on a cultivated stock, made use of language which was most intelligible, and referred to a practice with which they must have been perfectly familiar.—J. F. R.

AGRIPPA [HERODIAN FAMILY]. Although of the two Herods, father and son, who also bore the name of Agrippa, the latter is best known by his Roman name, it seems proper to include him with the other members of the Herodian dynasty, under the name which he bore among his own people.

AGUR (אגור), the author of the sayings contained in Prov. xxx., which the inscription describes as composed of the precepts delivered by 'Agur, the son of Jakel,' to his friends 'Ithiel and Ucal.' Beyond this everything that has been stated of him, and of the time in which he lived, is pure conjecture. Some writers have regarded the name as an appellative, but differ as to its signification. The Vulgate has 'Verba Congregantis filii Vomentis.' Most of the fathers think that Solomon himself is designated under this name; and if the word is to be understood as an appellative, it may be as well to look for its meaning in the Syriac, where, according to Bar Bahlul, in Castell. אגור means *qui sapientia studiis se applicat*. The Septuagint omits the chapter ascribed to Agur, as well as the nine first verses of the following chapter.

AH (אח, brother) or rather Ach, is frequently found, according to the inadequate representation

of the guttural which is followed in our Version, as the first syllable of compound Hebrew proper names. The observations already offered in the article *Ah* may be referred to for some illustration of the metaphorical use of the term *brother* in such combinations, as well as for the law of their construction, whenever the two members are nouns of which one is dependent as a genitive on the other.—J. N.

AHAB (אָחָב, *father's brother*; Sept. Ἀχαάβ), son of Omri, and the sixth king of Israel, who reigned twenty-one years, from B.C. 918 to 897. Ahab was, upon the whole, the weakest of all the Israelitish monarchs; and although there are occasional traits of character which show that he was not without good feelings and dispositions, the history of his reign proves that weakness of character in a king may sometimes be as injurious in its effects as wickedness. Many of the evils of his reign may be ascribed to the close connection which he formed with the Phœnicians. There had long been a beneficial commercial intercourse between that people and the Jews; and the relations arising thence were very close in the times of David and Solomon. After the separation of the kingdoms, the connection appears to have been continued by the nearer kingdom of Israel, but to have been nearly, if not quite, abandoned by that of Judah. The wife of Ahab was Jezebel, the daughter of Ethbaal, or Ithobaal, king of Tyre. She was a woman of a decided and energetic character, and, as such, soon established that influence over her husband which such women always acquire over weak, and not unfrequently also over strong, men. Ahab, being entirely under the control of Jezebel, sanctioned the introduction, and eventually established the worship of the Phœnician idols, and especially of the sun-god Baal. Hitherto the golden calves in Dan and Bethel had been the only objects of idolatrous worship in Israel, and they were intended as symbols of *JEHOVAH*. But all reserve and limitation were now abandoned. The king built a temple at Samaria, and erected an image, and consecrated a grove to Baal. A multitude of the priests and prophets of Baal were maintained. Idolatry became the predominant religion; and Jehovah, with the golden calves as symbolical representations of him, were viewed with no more reverence than Baal and his image. So strong was the tide of corruption, that it appeared as if the knowledge of the true God was soon to be for ever lost among the Israelites. But a man suited to this emergency was raised up in the person of Elijah the prophet, who boldly opposed himself to the regal authority, and succeeded in retaining many of his countrymen in the worship of the true God. The greater the power which supported idolatry, the more striking were the prophecies and miracles which directed the attention of the Israelites to Jehovah, and brought disgrace on the idols, and confusion on their worshippers. At length the judgment of God on Ahab and his house was pronounced by Elijah, who announced that, during the reign of his son, his whole race should be exterminated. Ahab died of the wounds which he received in a battle with the Syrians, according to a prediction of Micaiah, which the king disbelieved, but yet endeavoured to avert by dis-

guising himself in the action (1 Kings xvi. 29, xxii. 40).

2. **AHAB** and **ZEDEKIAH**. The names of two false prophets, who deceived the Israelites at Babylon. For this they were threatened by Jeremiah, who foretold that they should be put to death by the king of Babylon in the presence of those whom they had beguiled; and that in following times it should become a common malediction to say, 'The Lord make thee like Ahab and Zedekiah, whom the king of Babylon roasted in the fire' (Jer. xxix. 21, 22).

AHALIM (אָהָלִים) and **AHALOTH** (אָהָלוֹת), usually translated **ALOES**, occur in several passages of the Old Testament, as in Psalm xlv. 8, 'All thy garments smell of myrrh, and *ahaloth*, and cassia;' Prov. vii. 17, 'I have perfumed my bed with myrrh, with cinnamon and *ahalim*;' Canticles, iv. 14, 'Spikenard and saffron, calamus and cinnamon, with all trees of frankincense, myrrh and *ahaloth*, with all the chief spices.' From the articles which are associated with *ahaloth* and *ahalim* (both names indicating the same thing), it is evident that it was some odoriferous substance, probably well known in ancient times. Why these words have been translated 'aloes,' not only in the English, but in most of the older versions, it may not be easy to ascertain; but there is little doubt that the odoriferous *ahaloth* of the above passages ought not to be confounded with the bitter and nauseous aloes famed only as a medicine. The latter, no doubt, has some agreeable odour, which of the best quality from the island of Socotra, and when freshly-imported pieces are first broken; some not unpleasant odour may also be perceived when small pieces are burnt. But common aloes is usually disagreeable in odour and nauseous in taste, and could never have been employed as a perfume. Its usual name in Arabia, *sibbar*, has no resemblance to its European name. The earliest notice of aloes seems to be that of Dioscorides, iii. 25; the next that of Pliny (*Nat. Hist.* xxvii. 5). Both describe it as being brought from India, whence also probably came its name, which is *elca* in Hindue.

The oldest and most complete account with which we are acquainted of the fragrant and aromatic substances known to the ancients is that given in the first twenty-eight chapters of the first book of Dioscorides. There, along with Iris, Acorum, Cyperum, Cardamomum, several Nards, Asarum, Phu, Malabathrum, Cassia, Cinnamon, Costus, Schœnus, Calamus aromaticus, Balsamum, Aspalathus, Crocus, &c., mention is also made of *Agallochum*, which is described as a wood brought from India and Arabia. In this list, which we shall afterwards have frequent occasion to refer to, we find *Agallochum* associated with most of the same substances which are mentioned along with it in the above passages of Scripture, whereas the author describes the true aloë in a very different part of his work. Subsequently to the time of Dioscorides, we find *Agallochum* mentioned by Orobasius, Ætius, and P. Ægina; but they add nothing to the first description. The Arabs, however, as Rhases, Serapion, and Avicenna, were well acquainted with this substance, of which they describe several varieties, mostly named from the places where they were produced,

and give other particulars respecting it, besides quoting Dioscorides and previous authors of their own country. In the Latin translation of Avicenna these descriptions appear under *Agallochum*, *Xilaloe*, and *Lignum aloes*; but in the Arabic

edition of the same author, under **اغلاخون**

Aghlajoon, **اغالوخي** Aghalookhi, but most fully

under **عود** 'Aod, pronounced *ood*. This is one

instance, and many others might be adduced, of the Arabs describing the same thing under two names, when they found a substance described by the Greeks—that is, Galen and Dioscorides, under one name, and were themselves acquainted with it under another. In the Persian works on *Materia Medica* (*vide* ABATTACHIM) we are informed that *agallokhee* is the Greek name of this substance, and that the Hindee name of one kind, by them called *aod-i-hindee*, is *aggur*. Having thus traced a substance which was said to come from India to the name by which it is known in that country, the next process would perhaps naturally have been to procure the substance, and trace it to the plant which yielded it. We, however, followed the reverse method; having first obtained the substance called *Aggur*, we traced it, through its Asiatic synonyms, to the *Agallochum* of Dioscorides, and, as related in the *Illustr. of Himalayan Botany*, p. 171, obtained in the bazaars of Northern India three varieties of this far-famed and fragrant wood—1. *aod-i-hindee*; 2. a kind procured by commerce from Surat, which, however, does not appear to differ essentially from the third, *aod-i-kinaree*, which was said to come from China, and is, no doubt, the *aleamericum* of Avicenna.

In the north-western provinces of India *aggur* is said to be brought from Surat and Calcutta. Garcias ab Horto (*Clusius, Exotic. Hist.*), writing on this subject near the former place, says that it is called 'in Malacca *garro*, selectissimum autem Calambac.' Dr. Roxburgh, writing in Calcutta, states that *uogoro* is the Sanscrit name of the incense or aloe-wood, which in Hindee is called *uogor*, and in Persian *aod-hindee*; and that there is little or no doubt that the real *calambac* or *agallochum* of the ancients is yielded by an immense tree, a native of the mountainous tracts east and south-east from Silhet, in about 24° of N. latitude. This plant, he says, cannot be distinguished from thriving plants exactly of the same age of the *Garro de Malacca* received from that place, and then in the Botanic Garden of Calcutta. He further states that small quantities of *agallochum* are sometimes imported into Calcutta by sea from the eastward; but that such is always deemed inferior to that of Silhet (*Flora Ind.* ii. 423).

The *Garro de Malacca* was first described by Lamarck from a specimen presented to him by Sonnerat as that of the tree which yielded the *bois d'aigle* of commerce. Lamarck named this tree *Aquilaria Malaccensis*, which Cavanilles afterwards changed unnecessarily to *A. ovata*. As Dr. Roxburgh found that his plant belonged to the same genus, he named it *Aquilaria Agallochum*, but it is printed *Agallocha* in his *Flora Indica*, probably by an oversight. He is of opinion that the *Agallochum secundarium* of

Rumphius (*Amb.* ii. 34, t. 10), which that author received under the name of *Agallochum malaccense*, also belongs to the same genus, as well as the *Sinfoo* of Kämpfer (*Aman. Exot.* p. 903), and the *Ophispermum sinense* of Loureiro.



[*Aquilaria Agallochum*.]

These plants belong to the Linnæan class and order *Decandria monogynia*, and the natural family of *Aquilarinæ*; at all events, we have two trees ascertained as yielding this fragrant wood—one, *Aquilaria Agallochum*, a native of Silhet; and the other, *A. ovata* or *malaccensis*, a native of Malacca. The missionary Loureiro, in his description of the Flora of Cochou-China, describes a third plant, which he names *Aloerylum*, 'idem est ac lignum aloë,' and the species *A. Agallochum*, represented as a large tree growing in the lofty mountains of Champava belonging to Cochou-China, about the 13th degree of N. lat., near the great river 'Lavum': 'Omnes veri aloes ligni species ex hac arbore procedunt, etiam pretiosissima, quæ dici solet Calambac.' This tree, belonging to the class and order *Decandria monogynia* of Linnæus, and the natural family of *Leguminosæ*, has always been admitted as one of the trees yielding *Agallochum*. But as Loureiro himself confesses that he had only once seen a mutilated branch of the tree in flower, which, by long carriage, had the petals, anthers, and stigma much bruised and torn, it is not impossible that this may also belong to the genus *Aquilaria*, especially as his tree agrees in so many points with that described by Dr. Roxburgh, as already observed by the latter in his *Hist. Flor. Ind.* l. c. Rumphius has described and figured a third plant, which he named *arbor excæcans*, from 'Blindhout,' in consequence of its acrid juice destroying sight—whence the generic name of *Excæcaria*; the specific one of *agallochum* he applied, because its wood is similar to and often substituted for *agallochum*: 'Lignum hoc tantum habet cum *agallocho* similitudinem.' And he states that it was sometimes exported as such to Europe, and even to China. This tree, the *Excæcaria agallochum*, of the Linnæan class and order *Dioecia triandria*, and the natural family of *Euphorbiacæ*, is also very common in the delta of the Ganges, where it is called *Geria*; 'but the wood-cutters of the Sunder-

bunds,' Dr. Roxburgh says, 'who are the people best acquainted with the nature of this tree, report the pale, white, milky juice thereof to be highly acrid and very dangerous.' The only use made of the tree, as far as Dr. Roxburgh could learn, was for charcoal and firewood. Agallochum of any sort is, he believed, never found in this tree, which is often the only one quoted as that yielding agila-wood; but, notwithstanding the negative testimony of Dr. Roxburgh, it may, in particular situations, as stated by Rumphius, yield a substitute for that fragrant and long-famed wood.

Having thus traced the agallochum of commerce to the trees which yield it, it is extremely interesting to find that the Malay name of the substance, which is *agila*, is so little different from the Hebrew; not more, indeed, than may be observed in many well-known words, where the hard *g* of one language is turned into the aspirate in another. It is therefore probable that it was by the name *agila* (*aghil*, in Rosenmüller, *Bibl. Bot.* p. 234) that this wood was first known in commerce, being conveyed across the Bay of Bengal to the island of Ceylon or the peninsula of India, which the Arab or Phœnician traders visited at very remote periods, and where they obtained the early-known spices and precious stones of India. It is not a little curious that Captain Hamilton (*Account of E. Indies*, i. 68) mentions it by the name of *agala*, an odoriferous wood at Muscat. We know that the Portuguese, when they reached the eastern coast from the peninsula, obtained it under this name, whence they called it *pao d'aguila*, or eagle-wood; which is the origin of the generic name *Aquilaria*.

The term *agila*, which in Hebrew we suppose to have been converted into *ahel*, and from which were formed *ahalim* and *ahaloth*, appears to have been the source of its confusion with aloes. Sprengel has observed that the primitive name seems to be preserved in the Arabic appellations **اللوة** and **الليه**, which may be read *alloeh* (or *alloet*) and *allieh*. These come extremely near **ايلوا** *aelwa*, pronounced *elwa*—the Hindoo name of the medical aloes. Hence the two names became confounded, and one of them applied to two very different substances. But it was soon found necessary to distinguish the agallochum by the term **ευλαόχην**, which has been translated into lign-aloes. That the name aloes was considered to be synonymous with *ahalim*, at an early period, is evident, as 'the Chaldee translation of the Psalms and Canticles, the old Latin version of the Proverbs and Canticles, and the Syriac translation, have all rendered the Hebrew word by aloes' (Rosenmüller, *l. c.* p. 234). There can be little or no doubt that the same odoriferous *agila* is intended in the passage of John xix. 39. When the body of our Saviour was taken down from the cross, Nicodemus, we are told, brought myrrh and aloes for the purpose of winding it in linen clothes with these spices. But the quantity (100 lbs.) used has been objected to by some writers, and therefore Dr. Harris has suggested, that, 'instead of **εκατόν**, it might originally have been **δεκατόν**, 10 lbs. weight.' It is well known, however, that very large quantities of spices were occasionally used at the funerals of Jews. But before object-

ing to the quantity of this expensive wood, disputants should have ascertained the proportions in which it was mixed with the myrrh, an article sufficiently abundant and of moderate price, because easily obtained by the Arabians from the opposite coast of Africa. Dr. Harris has, moreover, objected, that 'the Indian lign-aloes is so odoriferous and so agreeable, that it stands in no need of any composition to increase or moderate its perfume.' But this very excellence makes it better suited for mixing with less fragrant substances, and, however large the quantity of these substances, like the broken vase, 'the scent of the roses will hang round it still.'

The only passage where there is any difficulty is that in which there is the earliest mention of the *ahalok* (Num. xxiv. 6). Here Balaam, referring to the flourishing condition of the Israelites, says, 'as the trees of *ahalim*, which the Lord hath planted, and as cedar trees beside the waters.' Whether the expression is here to be understood literally, or merely as a poetical form, is doubtful, especially as authorities differ as to the true reading; some versions, as the Septuagint, Vulgate, Syriac, and Arabic, having 'tents' instead of 'lign-aloes,' from which it would seem that, in place of **אֵילֹהִים**, *ahalim*, they had found in their copies **אֵהָלִים**, *ahalim* (Rosenmüller, p. 235).

In Arabian authors numerous varieties of agallochum are mentioned. These are enumerated by various writers (Cels. *Herobot.* p. 113). Persian authors mention only three:—1. *Aod-i-hindee*, that is, the Indian; 2. *Aod-i-chinee*, or Chinese kind (probably that from Cochin-China); while the third, or *Sumunduree*, a term generally applied to things brought from sea, may have reference to the inferior variety from the Indian islands. In old works, such as those of Bauhin and Ray, three kinds are also mentioned:—1. Agallochum prestantissimum, also called *Calambac*; 2. A. officinarum, or *Palo de Aquilla* of Linschoten; 3. A. sylvestre, or *Aquilla brava*. But besides these varieties, obtained from different localities, perhaps from different plants, there are also distinct varieties, obtainable from the same plant. Thus in a MS. account by Dr. Roxburgh, to which we have had access, and where, in a letter, dated 8th Dec., 1808, from R. K. Dick, esq., judge and magistrate at Silhet, it is stated that four different qualities may be obtained from the same tree:—1st. *Ghurkee*, which sinks in water, and sells from 12 to 16 rupees per seer of 2 lbs.; 2nd. *Doim*, 6 to 8 rupees per seer; 3rd. *Siniula*, which floats in water, 3 to 4 rupees; and 4th, *Choorum*, which is in small pieces, and also floats in water, from 1 to 1½ rupee per seer (the three last names mean only 2nd, 3rd, and 4th kinds); and that sometimes 80 lbs. of these four kinds may be obtained from one tree. All these *tuggur*-trees, as they are called, do not produce the *Aggur*, nor does every part of even the most productive tree. The natives cut into the wood until they observe dark-coloured veins yielding the perfume: these guide them to the place containing the *aggur*, which generally extends but a short way through the centre of the trunk or branch. An essence, or attur, is obtained by bruising the wood in a mortar, and then infusing it in boiling water, when the attur floats on the

surface. Early decay does not seem incident to all kinds of agallochum, for we possess specimens of the wood gorged with fragrant resin (*Illustr. Him. Bot.* p. 173) which show no symptoms of it; but still it is stated that the wood is sometimes buried in the earth. This may be for the purpose of increasing its specific gravity. A large specimen in the Museum of the East India House displays a cancellated structure, in which the resinous parts remain, the rest of the wood having been removed, apparently by decay.—J. F. R.

AHASUERUS (אַחַשְׁוֵרֶשֶׁת), or ACHASHVEROSIR, is the name, or rather the *title*, of four Median and Persian monarchs mentioned in the Bible. The earlier attempts of Simonis and others to derive this name from the Persian *achash* are unworthy of notice. Hyde (*De Relig. Vet. Pers.* p. 43) more boldly proposed to disregard the Masoretic punctuation, and to read the consonants, *Acsuares*, so as to correspond with Ὀξυδάρης, a Persian royal title. Among those who assume the identity of the names Achashverosh and Xerxes, Grotefend believes he has discovered the true orthography of Xerxes in the arrowhead inscriptions of Persepolis. He has deciphered signs representative of the sounds *khshhêrshê*, and considers the first part of the word to be the Zend form of the later *shah*, 'king' (Heeren's *Ideen*, i. 2, 350). Gesenius (also in his *Thesaurus*) assents to this, except that (as Reland had done before) he takes the first part of the word to be the original form of *sh'r*, a lion, and the latter to be that of *shah*. The Hebrew Achashverosh might thus be a modification of *khshhêrshê*: the prosthetic aleph being prefixed (as even Scaliger suggested), and a new vowel being inserted between the first two sounds, merely to obviate the difficulty which, as is well known, all Syro-Arabbians find in pronouncing two consonants *before* a vowel. One of the highest authorities in such questions, however, A. F. Pott (*Etymol. Forschungen*, i. p. lxxv.), considers Xerxes to be a compound of the Zend *csathra*, king (with loss of the *t*), and *csahya*, also meaning king, the original form of *shah*; and suggests that Achashverosh—its identity with Xerxes, as he thinks, not being established—may be the Pelivi *huzvaresh*, 'hero' (from *hu*, 'good,' and *zour*, 'strength'), corresponding to ἀφῆος, which Herodotus (vi. 98) says is the true sense of *Xerxes*. Jahn, indeed, first proposed the derivation from *zvaresh* (in his *Archäol.* ii. 2, 244); but then he still thought that the first part of the name was *achash*—a modern Persian word, which only seems to denote *price*, *value*. Lastly, it deserves notice that the *kethib*, in Esther x. 1, has אַחַשְׁוֵרֶשֶׁת, pointed *Achashresh*; and that the Syriac version always (and sometimes the Arabic also, as in Dan. ix. 1) writes the name *Achshiresh*. Ilgen adopts the *kethib* as the authentic consonants of the name; but changes the vowels to *Achshâresh*, and modifies his etymology accordingly.

The first Ahasuerus (Sept. Ἀσσοβρος, Theodotion, Ξέρξης) is incidentally mentioned, in Dan. ix. 1, as the father of Darius the Mede. It is generally agreed that the person here referred to is the Astages of profane history. See the article DARIUS.

The second Ahasuerus (Sept. Ἀσσοβρος) occurs in Ezra iv. 6, where it is said that in the beginning of his reign the enemies of the Jews

wrote an accusation against them, the result of which is not mentioned. The whole question, as to the Persian king here meant, depends on the light in which the passage of this chapter, from ver. 6 to 24, is regarded. The view which Mr. Howes seems to have first proposed, and which Dr. Hales adopted in his *Analysis of Chronology*, proceeds on the theory that the writer of this chapter, after mentioning the interruption to the building of the temple from the time of Cyrus down to that of Darius, king of Persia (ver. 1-5), is led, by the association of the subject, to enter into a detail of the hindrances thrown in the way of building and fortifying the city (after the temple had been completed), under the successors of Darius Hystaspis (ver. 6-23); and that, after this digressive anticipation of events posterior to the reign of Darius, he returns (in ver. 24) to the history of the building of the temple under that prince. This view necessarily makes the Achashverosh and Artachshasta of ver. 6 and 7 to be the successors of Darius Hystaspis, i. e. to be Xerxes and Artaxerxes Longimanus. The main argument on which this theory rests, seems to be the circumstance that, in the whole passage, there is no mention whatever of the temple; but, on the contrary, that the setting up the walls of the rebellious city forms the sole ground of complaint: so that the passage must refer to what occurred after the temple was finished (see the extract from Howes in the *Pictorial Bible*, *ad loc.*).

There are, however, some objections against the conclusiveness of this reasoning; for, first, even assuming the object of the enemies of the Jews, in this accusation, to have been to hinder the building of the temple, it is yet easy to conceive how the omission of all mention of the temple might be compatible with their end, and dependent on the means they were obliged to employ. They could only obtain their object through the Persian king; they therefore used arguments likely to weigh with him. They appealed to motives of state policy. Accordingly, they sought to alarm his jealousy lest the rebellious city should become strong enough to resist tribute, and refuse to allow the transit of his armies; they drew attention to the rebuilding of the defences, as the main point of the argument; and said nothing about the temple, because that would be a matter of secondary importance in the only point of view in which the subject would appear to the Persian king. But, secondly, it has been shown by a minute inquiry by Trendelenburg (in Eichhorn's *Einleit. in die Apocryph. Schrift.* p. 351), that the first book of the apocryphal Esdras is principally a free, but in parts continuous, translation of the canonical Ezra. It is, therefore, remarkable that the author of Esdras, who has taken this very account of the accusation from Ezra, was so far from discerning the omission of the temple, and the conclusion that Mr. Howes has drawn from it, that *his* letter (ii. 16-30) states, that 'The Jews, being come into Jerusalem, that rebellious city, do build the market-place, and repair the walls of it, and do lay the foundation of the temple And forasmuch as the things pertaining to the temple are now in hand, we think it meet not to neglect such a matter.' Josephus also (*Antiq.* xi. 2), conformably to his general adherence, in this part, to the apocryphal Esdras, both uses, in *his* letter, the same terms about the reconstruction of the temple being

then commenced, and even tells the whole story as referring to *Cambyses*, which makes it clear that he understood the passage of the immediate successor of Cyrus. Thirdly, it is even probable, *a priori*, that the rebuilding of the temple and of the city itself would, to a certain extent, necessarily go on together. The Jews must have had sufficient time and need, in the fifteen years between the accession of Cyrus and that of Darius Hystaspis, to erect some buildings for the sustenance and defence of the colony, as well as for carrying on the structure of the temple itself. As we read of 'coiled houses' in Haggai i. 4, they may have built defences sufficient to give a colour to the statements of the letter; and enough to free a critic from the necessity of transferring the passage in Ezra to the time of Artaxerxes Longimanus, solely because it speaks of the erection of the walls. Moreover, as Ezra (ix. 9) speaks of God having enabled the Jews to repair the temple, and of his having 'given them a wall in Jerusalem,' we find that, when the temple was finished (and no evidence shows how long before that), they actually had built a wall. Josephus also (*Antiq.* xi. 4, 4) mentions even 'strong walls with which they had surrounded the city' before the temple was completed. (It is worth while to remark that Dr. Hales, speaking of this wall of Ezra, endeavours, consistently with his theory, to make it 'most probably mean the fence of a shepherd's fold, here figuratively taken for their establishment in their own land.' But any lexicon will show that רָוַן means a fence, a wall, generally; and that it is only limited by the context to mean the wall of a garden, the fence of a fold.) Again, it is assumed that Nehemiah shows that the walls of the city were not built until his time. Not such, nor the same, as he erected, granted. But—to borrow a remark of J. D. Michaelis—when we read in Neh. i. 2, of the Jews who returned to Persia, and who answered Nehemiah's inquiry after the fate of the colony, by informing him that 'the wall of Jerusalem is broken down and the gates thereof burned with fire,' is it possible that they can refer to the destruction of the walls by Nebuchadnezzar, 144 years before? Was such news so long in reaching Nehemiah? Is it not much easier to believe that the Jews, soon after their return, erected some defences against the hostile and predatory clans around them; and that, in the many years which intervene between the books of Nehemiah and Ezra (of which we have no record), there was time enough for those tribes to have burnt the gates and thrown down the walls of their imperfect fortifications? Lastly, the view of Mr. Howes seems to require peculiar philological arguments, to reconcile the construction of the digression with the ordinary style of Hebrew narrative, and to point out the particles, or other signs disjunctive, by which we may know that ver. 24 is to be severed from the preceding. Nor is it altogether a trivial objection to his theory, that no scholar appears to have entertained it before himself. The nearest approach to it has been made by Vitringa, who, in his *Hypotyposi Temporum* (cited in Michaelis's *Adnot. Ueberior.*), suggests, indeed, that ver. 6 refers to Xerxes, but explains all the rest of the passage as applying to Cambyses.

If the arguments here adduced are satisfactory, the Ahasuerus of our passage is the immediate

successor of Cyrus—the frantic tyrant Cambyses, who came to the throne B.C. 529, and died after a reign of seven years and five months; and the discrepancy between Ezra and the apocryphal Esdras and Josephus—both of whom leave out ver. 6, and mention only the king of whom the detailed story of the letter is related, whom the one calls *Artaxerxes*, and the other *Cambyses*—may be reconciled, by supposing that they each make the reigns of Cambyses and of the impostor Smerdis into one.

The *third* Ahasuerus (Sept. Ἀρταξέρξης) is the Persian king of the book of Esther. The chief facts recorded of him there, and the dates of their occurrence, which are important in the subsequent inquiry, are these: In the *third* year of his reign he made a sumptuous banquet for all his nobility, and prolonged the feast for 180 days. Being on one occasion merry with wine, he ordered his queen Vashti to be brought out, to show the people her beauty. On her refusal to violate the decorum of her sex, he not only indignantly divorced her, but published an edict concerning her disobedience, in order to insure to every husband in his dominions the rule in his own house. In the *seventh* year of his reign he married Esther, a Jewess, who however concealed her parentage. In the *twelfth* year of his reign, his minister Haman, who had received some slights from Mordecai the Jew, offered him 10,000 talents of silver for the privilege of ordering a massacre of the Jews in all parts of the empire on an appointed day. The king refused this immense sum, but acceded to his request; and couriers were despatched to the most distant provinces to enjoin the execution of this decree. Before it was accomplished, however, Mordecai and Esther obtained such an influence over him, that he so far annulled his recent enactment as to despatch other couriers to empower the Jews to defend themselves manfully against their enemies on that day; the result of which was, that they slew 800 of his native subjects in Shushan, and 75,000 of them in the provinces.

Although almost every Medo-Persian king, from Cyaxares I. down to Artaxerxes III. (Ochus), has in his turn found some champion to assert his title to be the Ahasuerus of Esther, yet the present inquiry may reasonably be confined within much narrower limits than would be requisite for a discussion of all the rival claims which have been preferred. A succinct statement, principally derived from Justi's ingenious *Versuch über den König Ahasuerus* (in Eichhorn's *Repertorium*, xv. 1-38), will suffice to show that Darius Hystaspis is the earliest Persian king in whom the plainest marks of identity are not evidently wanting; that Darius Hystaspis himself is, nevertheless, excluded on less obvious, but still adequate grounds; and that the whole question lies, and with what preponderance of probability, between Xerxes and his successor Artaxerxes Longimanus.

As Ahasuerus reigned from India to Ethiopia (*Esth.* i. 1), and imposed a tribute (not necessarily for the first time) on the land and isles of the sea (x. 1); and laid the disobedience of Vashti before the seven princes which see the king's face, and sit first in the kingdom (i. 14); it is argued that these three circumstances concur, according to the testimony of profane history,

exclude all the predecessors of Darius Hystaspis. For Darius was the first Persian king who subdued India, which thenceforth formed the twentieth province of his empire; and, as for Ethiopia, Cambyses, who first invaded it, only obtained a partial conquest there (Herod. iv. 44; iii. 25, 94). Darius was also the first who imposed a stated tribute on the different provinces of the empire, as, from the times of Cyrus, the revenue depended on the voluntary gifts of the people (Herod. iii. 89). Lastly, the seven princes, and their privilege of seeing the king's face, are traced to the events attending the elevation of Darius to the throne: when the seven conspirators who slew the usurper Smerdis stipulated, before ever it was decided which of their number should obtain the crown, that all the seven should enjoy special privileges, and, among others, this very one of seeing the king at any time without announcement (Herod. iii. 84). This is confirmed by the fact, that although the Persian counsellors of the time anterior to Darius are often mentioned (as when Cambyses laid before them a question parallel to that about Vashti, Herod. iii. 31), yet the definite number *seven* does not occur; whereas, after Darius, we find the seven counsellors both in Esther, and again in the reign of Artaxerxes Longimanus (Ezra vii. 14). (It is an oversight to appeal to this account of the seven conspirators, in order to find the precise number of *seven* princes. For the narrative in Herodotus shows that, as Darius was chosen king from among the seven, there could only be *six* persons to claim the privilege of seeing the king's face; not to insist that Otanes, who made a separate demand for himself, and who withdrew from the party before those stipulations were made, may possibly have reduced the number of privileged counsellors to *six*.)

But neither can it be Darius Hystaspis himself, although he possesses all these marks of agreement with the person intended in the book of Esther. For, first, not only can none of the names of the seven conspirators, as given either by Herodotus or by Ctesias, be brought to accord with the names of the seven princes in Esther; but, what is of greater importance, it is even more difficult to find the name of Darius himself in Achashverosh. For, notwithstanding the diverse corruptions to which proper names are exposed when transmitted through different foreign languages, there is yet such an agreement between the Zend name found by Grotefend in the cuneiform inscriptions, and the *Darius* of the Greeks, and *Darjävêsh* (the name by which Darius Hystaspis is undoubtedly designated elsewhere in the Old Testament), that the genuineness of this title is open to less suspicion than that of almost any other Persian king. It would, therefore, be inexplicable that the author of the book of Esther above all others should not only not call him by the authentic name of sacred as well as profane history, but should apply to him a name which has been shown to be given, in almost all contemporary books of the Old Testament, to other Persian kings. Secondly, the moral evidence is against him. The mild and just character ascribed to Darius renders it highly improbable that, after favouring the Jews from the second to the sixth year of his reign, he should become a senseless tool in the hands of Haman, and consent to their extirpation. Lastly, we read of his

marrying two daughters and a granddaughter of Cyrus, and a daughter of Otanes—and these only; would Darius have repudiated one of these for such a trifle, when his peculiar position, as the first king of his race, must have rendered such alliances indispensable?

It only remains now to weigh the evidence against Artaxerxes, in order to lead more cogently to the only alternative left—that it is Xerxes. As Artaxerxes allowed Ezra to go to Jerusalem with a colony of exiles in the seventh year of his reign (Ezra vii. 1-7); and as he issued a decree in terms so exceedingly favourable to the religious as well as civil interests of the Jews (giving them liberal grants and immunities, speaking of their law as the law of the God of heaven, and threatening punishment to whoever would not do the law of God and of the king, Ezra vii. 11-26): how could Haman, *six years afterwards*, venture to describe the Jews to him as a people whom, on the very account of their law, it was not for the king's profit to suffer? And how could Haman so directly propose their extermination, in the face of a decree so signally in their favour, and so recently issued by the same king? especially as the laws of the Medes and Persians might not be altered! Again, as Artaxerxes (assuming always that *he* is the Artachshast of Ezra vii. 1, and not Xerxes, as is nevertheless maintained by J. D. Michaelis, Jahn, and De Wette) was capable of such liberality to the Jews in the seventh year of his reign, let us not forget that, if he is the Ahasuerus of the book of Esther, it was in that same year that he married the Jewess. Now, if—by taking the first and tenth months in the seventh year of the king (the dates of the departure of Ezra, and of the marriage of Esther) to be the first and tenth months of the *Hebrew year* (as is the usual mode of notation; see Hitzig, *Die zu Kleinen Propheten*, note to Haggai i. 1), and not the first and tenth from the period of his *accession*—we assume that the departure of Ezra took place *after* his marriage with her, his clemency might be the effect of her influence on his mind. Then we have to explain how he could be induced to consent to the extirpation of the Jews in the twelfth year of his reign, notwithstanding that her influence still continued—for we find it evidently at work in the twelfth year. But if, on the other hand, his indulgence to Ezra was *before* his marriage, then we have even a greater difficulty to encounter. For then Artaxerxes must have acted from his own unbiassed lenity, and his purposed cruelty in the twelfth year would place him in an incongruous opposition with himself. As we, moreover, find Artaxerxes again propitious to their interests, in the twentieth year of his reign—when he allowed Nehemiah to return to Jerusalem—it is much easier to believe that he was also favourably disposed to them in the twelfth. At any rate, it would be allowing Esther a long time to exercise an influence on his disposition, if his clemency in the twentieth year was due to her, and not to his own inclination. Besides, the fact that neither Ezra nor Nehemiah gives the least hint that the liberal policy of Artaxerxes towards them was owing to the influence of their countrywoman, is an important negative point in the scale of probabilities. In this case also there is a serious difficulty in the name. As Artaxerxes is called

Artachshast in Ezra and Nehemiah, we certainly might expect the author of the book of Esther to agree with them in the name of a king whom they all had had such occasion to know. Nor is it, perhaps, unimportant to add, that Norberg asserts, on the authority of native Persian historians, that the *mother* of Bahman, *i. e.* Artaxerxes Longimanus, was a *Jeveess* (*Opuscula Acad.* iii. 218). This statement would agree excellently with the theory that *Xerxes* was Ahasuerus. Lastly, the joint testimony borne to his clemency and magnanimity by the acts recorded of him in Ezra and Nehemiah, and by the accordant voice of profane writers (Plutarch, *Artaxerxes*; Diodor. Sic. xi. 71; Ammian. Marcell. xxx. 8), prevents us from recognising Artaxerxes in the debauched, imbecile, and cruel tyrant of the book of Esther.

On the ground of moral resemblance to that tyrant, however, every trait leads us to Xerxes. The king who scourged and fettered the sea; who beheaded his engineers because the elements destroyed their bridge over the Hellespont; who so ruthlessly slew the eldest son of Pythius because his father besought him to leave him one sole support of his declining years; who dishonoured the remains of the valiant Leonidas; and who bequilted the shame of his defeat by such a course of sensuality, that he publicly offered a reward for the inventor of a new pleasure—is just the despot to divorce his queen because she would not expose herself to the gaze of drunken revellers; is just the despot to devote a whole people, his subjects, to an indiscriminate massacre; and, by way of preventing that evil, to restore them the right of self-defence (which it is hard to conceive how the first edict ever could have taken away), and thus to sanction their slaughtering thousands of his other subjects.

There are also remarkable coincidences of date between the history of Xerxes and that of Ahasuerus. In the third year of his reign the latter gave a grand feast to his nobles, which lasted 180 days (Esth. i. 3); the former, in *his* third year, also assembled his chief officers to deliberate on the invasion of Greece (Herod. vii. 8). Nor should we wonder to find no nearer agreement in the two accounts than is expressed in the mere fact of the nobles being assembled. The two relations are quite compatible: each writer only mentioning that aspect of the event which had interest for him. Again, Ahasuerus married Esther at Shushan, in the seventh year of his reign: in the same year of *his* reign, Xerxes returned to Susa with the mortification of his defeat, and sought to forget himself in pleasure;—not an unlikely occasion for that quest for fair virgins for the harem (Esth. ii. 2). Lastly, the tribute imposed on the land and isles of the sea also accords with the state of his revenue exhausted by his insane attempt against Greece. In fine, these arguments, negative and affirmative, render it so highly probable that Xerxes is the Ahasuerus of the book of Esther, that to demand more conclusive evidence, would be to mistake the very nature of the question.

The fourth Ahasuerus (*Ἀσούπιος*) is mentioned in Tobit xiv. 15, in connection with the destruction of Nineveh. That circumstance points out Cyaxares I. as the person intended (Herod. i. 106).

—J. N.

AHAVA (אָהַוָּה; Sept. Ἄουε, Ezra viii. 21 31, and Ἐυεῖ, verse 15), the river by which the Jewish exiles assembled their second caravan under Ezra, when returning to Jerusalem. It would seem from ch. viii. 15, that it was designated from a town of the same name: 'I assembled them at the river that flows towards Ahava.' In that case, it could not have been of much importance in itself; and possibly it was no other than one of the numerous canals with which Babylonia then abounded. This is probably the true reason that Biblical geographers have failed to identify it. Some have sought the Ahava in the Lycus or Little Zab, finding that this river was anciently called Adiaba or Diaba. But these names would, in Hebrew characters, have no resemblance to אָהַוָּה; and it is exceedingly unlikely that the rendezvous for a Palestine caravan should have been north-east of the Tigris in Assyria, with the two great rivers, Tigris and Euphrates, between them and the plains they were to traverse. It is not so clear, however, that Rosenmuller is right in supposing that it probably lay to the south-west of Babylonia, because that was in the direction of Palestine. It is too much forgotten by him and other writers, that caravan routes seldom run in straight lines between two places. In this case, a straight line would have taken the caravan through the whole breadth of a desert seldom traversed but by the Arabs; and to avoid this, the usual route for large caravans lay, and still lies, north-west through Mesopotamia, much above Babylonia; and then, the Euphrates being crossed, the direction is south-west to Palestine. The greater probability, therefore, is, that the Ahava was one of the streams or canals of Mesopotamia communicating with the Euphrates, somewhere in the north-west of Babylonia.

AHAZ (אֲחָז, *possessor*; Sept. Ἀχαζ; Joseph. Ἀχάζης), son of Jotham, and eleventh king of Judah, who reigned sixteen years, from *n. c.* 775 to 759. Ahaz was the most corrupt monarch that had hitherto appeared in Judah. He respected neither Jehovah, the law, nor the prophets; he broke through all the restraints which law and custom had imposed upon the Hebrew kings, and had regard only to his own depraved inclinations. He introduced the religion of the Syrians into Jerusalem, erected altars to the Syrian gods, altered the temple in many respects after the Syrian model, and at length ventured to shut it up altogether. Such a man could not exercise that *faith* in Jehovah, as the political head of the nation, which ought to animate the *courage* of a Hebrew king. Hence, after he had sustained a few repulses from Pekah and Rezin, his allied foes, when the Edomites had revolted from him, and the Philistines were making incursions into his country, notwithstanding a sure promise of divine deliverance, he called Pul, the king of Assyria, to his aid [ASSYRIA]. He even became tributary to that monarch, on condition of his obliging Syria and Israel to abandon their design of destroying the kingdom of Judah; and thus afforded to Tiglath-pilezer, the successor of Pul, an opportunity of conquering Syria, Israel beyond the Jordan, and Galilee. It would be wrong, however, to say that this would not have occurred but for the application of Ahaz; for the Assyrians were then prepared to

extend their empire west of the Euphrates, and would assuredly have done so without the immediate occasion which that application offered. The Assyrians, as might be expected, acted only with a view to their own interests, and afforded Ahaz no real assistance; on the contrary, they drove him to such extremities that he was scarcely able, with all the riches of the temple, of the nobility, and of the royal treasury, to purchase release from his troublesome protectors. He died at the age of thirty-six (2 Kings xvi.; 2 Chron. xxviii.; Isa. vii.; Jahn, *Biblisches Archæologie*, ii. 185; iii. 145; Hales, *Analysis*, ii. 417-419).

1. AHAZIAH (אֲחִזְיָהוּ and אֲחִזְיָהוּ, whom *Jehovah sustains*; Sept. Ὀχοφίας), son and successor of Ahab, and seventh king of Israel. He reigned two years, B.C. 897-895. It seems that Jezebel exercised over her son the same influence which had guided her husband; and Ahaziah pursued the evil courses of his father. The most signal public event of his reign was the revolt of the Moabites, who took the opportunity of the defeat and death of Ahab to discontinue the tribute which they had paid to the Israelites. Ahaziah became a party in the attempt of Jehoshaphat, king of Judah, to revive the maritime traffic by the Red Sea; in consequence of which the enterprise was blasted, and came to nothing (2 Chron. xx. 35-37). Soon after, Ahaziah, having been much injured by a fall from the roof-gallery of his palace, had the infatuation to send to consult the oracle of Baal-zebub, the god of Ekron, respecting his recovery. But the messengers were met and sent back by Elijah, who announced to the king that he should rise no more from the bed on which he lay (1 Kings xxii. 51, to 2 Kings i. 50).

2. AHAZIAH, otherwise JEHOAHAZ, son of Jehoram by Athaliah, daughter of Ahab and Jezebel, and sixth king of Judah. He reigned but one year (B.C. 885), and that ill, suffering himself in all things to be guided by the wicked counsels of his idolatrous mother, Athaliah. He cultivated the connections which had unhappily grown up between the two dynasties, and which had now been cemented by marriage. Hence he joined his uncle Jehoram of Israel in an expedition against Hazael, king of Damascus-Syria, for the recovery of Ramoth-Gilead; and afterwards paid him a visit while he lay wounded in his summer palace of Jezreel. The two kings rode out in their several chariots to meet Jehu; and when Jehoram was shot through the heart, Ahaziah attempted to escape, but was pursued, and being mortally wounded, had only strength to reach Megiddo, where he died. His body was conveyed by his servants in a chariot to Jerusalem for interment (2 Kings ix. 22-28). In 2 Chron. xxii. 7-9, the circumstances are somewhat differently stated; but the variation is not substantial, and requires no particular notice. It appears from that passage, however, that Jehu was right in considering Ahaziah as included in his commission to root out the house of Ahab. He was Ahab's descendant (grandson by the mother's side) both in blood and character; and his presence in Jezreel at the time of Jehu's operations is considered as an arrangement of Providence for accomplishing his doom.

AHIAH (אֲחִיאָהוּ, *frater Jehovæ*, i. e. *friend of God*; Sept. Ἀχιά, 1 Sam. viii. 3), son of Abitub, and high-priest in the reign of Saul, and brother and predecessor of the Ahimelech whom Saul slew for assisting David. Seeing that Ahimelech, a son of Abitub, was also high-priest in the same reign (1 Sam. xxii. 1), some have thought that both names belonged to the same person; but this seems less likely than the explanation which has just been given.

AHIAH, one of the two secretaries of Solomon (1 Kings iv. 3). Two other persons of this name occur in 1 Sam. xiv. 3; 1 Chron. viii. 7.

AHIAM, one of David's thirty heroes (2 Sam. xxiii. 33).

AHIEZER, the hereditary chief or prince of the tribe of Dan at the time that the Israelites quitted Egypt (Num. i. 12).

AHIHUD, a prince of the tribe of Asher, who, with the other chiefs of tribes, acted with Joshua and Eleazer in dividing the Promised Land (Num. xxxiv. 27).

AHIJAH (same name as AHIAH), a prophet residing in Shiloh in the times of Solomon and Jeroboam. He appears to have put on record some of the transactions of the former reign (2 Chron. ix. 29). It devolved on him to announce and sanction the separation of the ten tribes from the house of David, as well as the foundation (1 Kings xi. 29-39), and, after many years, the subversion of the dynasty of Jeroboam (1 Kings xv. 7-11) [JEROBOAM].

AHIKAM, one of the four persons of distinction whom Josiah sent to consult Huldah, the prophetess (2 Kings xxii. 12-14). Ahikam and his family are honourably distinguished for their protection of the prophet Jeremiah (Jer. xxvi. 29; xxxix. 14).

AHIMAAZ (אֲחִימָאז, *brother of anger*, i. e. *irascible*; Sept. Ἀχίμαζ), son and successor of Zadok, who was joint high-priest in the reign of David, and sole high-priest in that of Solomon. His history chiefly belongs to the time of David, to whom he rendered an important service during the revolt of Absalom. David having refused to allow the ark of God to be taken from Jerusalem when he fled thence, the high-priests, Zadok and Abiathar, necessarily remained in attendance upon it; but their sons, Ahimaz and Jonathan, concealed themselves outside the city, to be in readiness to bear off to David any important information respecting the movements and designs of Absalom which they might receive from within. Accordingly, Hushai having communicated to the priests the result of the council of war, in which his own advice was preferred to that of Abiathar [ABSALOM], they instantly sent a girl (probably to avoid suspicion) to direct Ahimaz and Jonathan to speed away with the intelligence. The transaction, however, was witnessed and betrayed by a lad, and the messengers were so hotly pursued that they took refuge in a dry well, over which the woman of the house placed a covering, and spread thereon parched corn. She told the pursuers that the messengers had passed on in haste; and when all was safe, she released them, on which they made their way to David (2 Sam. xv. 24-37; xvii. 15-21). As may be inferred from his being chosen for this service, Ahimaz was swift of foot. Of this we

have a notable example soon after, when, on the defeat and death of Absalom, he prevailed on Joab to allow him to carry the tidings to David. Another messenger, Cush, had previously been despatched, but Ahimaaz outstripped him, and first came in with the news. He was known afar off by the manner of his running, and the king said, 'He is a good man, and cometh with good tidings;' and this favourable character is justified by the delicacy with which he waived that part of his intelligence concerning the death of Absalom, which he knew would greatly distress so fond a father as David (2 Sam. xviii. 19-33).

AHIMAN, one of three famous giants, of the race of Anak, who dwelt at Hebron when the Hebrew spies explored the land (Num. xiii. 22).

AHIMELECH (אֲחִיעֶזֶק, *brother of the king, i. e. the king's friend*; Sept. Ἀβιμέλεχ; Cod. Alex. Ἀχιμέλεχ), son of Ahitub, and brother of Abiah, who was most probably his predecessor in the high-priesthood [AHIAH]. When David fled from Saul, he went to Nob, a city of the priests in Benjamin, where the tabernacle then was; and by representing himself as on pressing business from the king, he obtained from Ahimelech, who had no other, some of the sacred bread which had been removed from the presence-table. He was also furnished with the sword which he had himself taken from Goliath, and which had been laid up as a trophy in the tabernacle (1 Sam. xxi. 1-9). These circumstances were witnessed by Doeg, an Edomite in the service of Saul, and were so reported by him to the jealous king as to appear acts of connivance at, and support to, David's imagined disloyal designs. Saul immediately sent for Ahimelech and the other priests then at Nob, and laid this treasonable offence to their charge; but they declared their ignorance of any hostile designs on the part of David towards Saul or his kingdom. This, however, availed them not; for the king commanded his guard to slay them. Their refusal to fall upon persons invested with so sacred a character might have brought even Saul to reason; but he repeated the order to Doeg himself, and was too readily obeyed by that malignant person, who, with the men under his orders, not only slew the priests then present, eighty-six in number, but marched to Nob, and put to the sword every living creature it contained. The only priest that escaped was Abiathar, Ahimelech's son, who fled to David, and afterwards became high priest (1 Sam. xxii.) [ABIATHAR].

AHINADAB, one of the twelve officers who, in as many districts into which the country was divided, raised supplies of provisions in monthly rotation for the royal household. Ahinadab's district was the southern half of the region beyond the Jordan (1 Chron. vi. 23).

AHINOAM (אֲחִינוֹם, *brother of grace*; Sept. Ἀχινάμ), a woman of Jezreel, one of the wives of David, and mother of Amnon. She was taken captive by the Amalekites when they plundered Ziklag, but was recovered by David (1 Sam. xxv. 43; xxvii. 3; xxx. 5; 2 Sam. ii. 2; iii. 2).

AHIO (אִיּוֹ, *brotherly*; Sept., as an appellation, *his* [Uzzah's] *brothers—οἱ ἀδελφοὶ αὐτοῦ*), one of the sons of Abinadab, who, with his brother Uzzah, drove the new cart on which the ark was

placed when David first attempted to remove it to Jerusalem. Ahio went before to guide the oxen, while Uzzah walked by the cart (2 Sam. vi. 3, 4. [UZZAH.]

AHIRA, chief of the tribe of Naphtali when the Israelites quitted Egypt (Num. i. 15).

AHISHAR, the officer who was 'over the household' of King Solomon (1 Kings iv. 6). This has always been a place of high importance and great influence in the East.

AHITHOPHEL (אֲחִיתופֶּל, *brother of foolishness, i. e. foolish*; Sept. Ἀχίτοφελ), the very singular name of a man who, in the time of David, was renowned throughout all Israel for his worldly wisdom. He is, in fact, the only man mentioned in the Scriptures as having acquired a reputation for political sagacity among the Jews; and they regarded his counsels as oracles (2 Sam. xvi. 23). He was of the council of David; but was at Giloh, his native place, at the time of the revolt of Absalom, by whom he was summoned to Jerusalem; and it shows the strength of Absalom's cause in Israel that a man so capable of foreseeing results, and estimating the probabilities of success, took his side in so daring an attempt (2 Sam. xv. 12). The news of his defection appears to have occasioned David more alarm than any other single incident in the rebellion. He earnestly prayed God to turn the sage counsel of Ahithophel 'to foolishness' (probably alluding to his name); and being immediately after joined by his old friend Hushai, he induced him to go over to Absalom with the express view that he might be instrumental in defeating the counsels of this dangerous person (xv. 31-37). Psalm lv. is supposed to contain (12-14) a further expression of David's feelings at this treachery of one whom he had so completely trusted, and whom he calls 'My companion, my guide, and my familiar friend.' The detestable advice which Ahithophel gave Absalom to appropriate his father's harem, committed him absolutely to the cause of the young prince, since after that he could hope for no reconciliation with David (2 Sam. xvi. 20-23). His proposal as to the conduct of the war undoubtedly indicated the best course that could have been taken under the circumstances; and so it seemed to the council, until Hushai interposed with his plausible advice, the object of which was to gain time to enable David to collect his resources [ABSALOM]. When Ahithophel saw that his counsel was rejected for that of Hushai, the far-seeing man gave up the cause of Absalom for lost; and he forthwith saddled his ass, returned to his home at Giloh, deliberately settled his affairs, and then hanged himself, and was buried in the sepulchre of his fathers, B.C. 1023 (ch. xvii.). This is the only case of suicide which the Old Testament records, unless the last acts of Samson and Saul may be regarded as such.

1. AHITUB (אֲחִיתוּב, *brother of goodness or benignity, i. e. benign*; Sept. Ἀχίτοβ), son of Phinehas, and grandson of the high-priest Eli. His father Phinehas having been slain when the ark of God was taken by the Philistines, he succeeded his grandfather Eli B.C. 1141, and was himself succeeded by his son Ahiah about B.C. 1093.

3. AHITUB was also the name of the father of Zadok, who was made high-priest by Saul after the death of Ahimelech (2 Sam. viii. 17; 1 Chron. vi. 8). There is not the slightest ground for the notion that this Ahitub was ever high-priest himself—indeed, it is historically impossible.

AHOLAH and AHOLIBAH (אָהוֹלָה and אָהוֹלִיבָה), two fictitious or symbolical names adopted by Ezekiel (xxiii. 4) to denote the two kingdoms of Samaria (Israel) and Judah. There is a significant force in these names which must be noted. AHOLAH, אָהוֹלָה, is usually rendered 'a tent,' but more properly, *tentorium suum* (habet illa), 'she has her own tent or temple,' signifying that she has a tent or tabernacle of her, own or of human invention. AHOLIBAH, אָהוֹלִיבָה, means 'my tent, i. e. temple, is in her,' that is to say—I, Jehovah, have given her a temple and religious service. They are both symbolically described as lewd women, adulteresses, prostituting themselves to the Egyptians and the Assyrians, in imitating their abominations and idolatries; wherefore Jehovah abandoned them to those very people for whom they showed such inordinate and impure affection. They were carried into captivity, and reduced to the severest servitude. But the crime of Aholibah was greater than that of Aholah, for she possessed more distinguished privileges, and refused to be instructed by the awful example of her sister's ruin. The allegory is an epitome of the history of the Jewish church.

AHOLIAB, of the tribe of Dan, a skilful artificer appointed along with Bezaleel to construct the Tabernacle (Exod. xxxv. 34).

AHUZZATH (אֲחֻצַּתְיָא, *a possession*), the 'friend' of Abimelech II., king of Gerar, who attended him on his visit to Isaac (Gen. xxvi. 26). In him occurs the first instance of that unofficial but important personage in ancient Oriental courts, called 'the king's friend,' or favourite. Several interpreters, following the Chaldee and Jerome, take *Ahuzzath* to be an appellative, denoting a *company of friends*, who attended Abimelech. The Sept. has Ὁρχιστὸς ὁ νυμφαγωγὸς αὐτοῦ.

AI (אֵי, Josh. vii. 2; אֵי, Gen. xii. 8; in Neh. xi. 31, אֵי; in Isa. x. 28, אֵי; Sept. Ἀγγαί, Ἀγγαί, and Γαί; Vulg. *Hai*), a royal city of the Canaanites, which lay east of Bethel. It existed in the time of Abraham, who pitched his tent between it and Bethel (Gen. xii. 8; xiii. 3); but it is chiefly noted for its capture and destruction by Joshua (vii. 2-5; viii. 1-29). This, as a military transaction, is noticed elsewhere [AMBUCADE]. At a later period Ai was rebuilt, and is mentioned by Isaiah (x. 28), and also after the captivity. The site was known, and some scanty ruins still existed in the time of Eusebius and Jerome (*Onomast.* in *Agai*), but Dr. Robinson was unable to discover any certain traces of either. He remarks (*Bib. Researches*, ii. 313), however, that its situation with regard to Bethel may be well determined by the facts recorded in Scripture. That Ai lay to the east of Bethel is distinctly stated; and the two cities were not so far distant from each other but that the men of Bethel mingled in the pursuit of

the Israelites when they feigned to flee before the king of Ai, and thus both cities were left defenceless (Josh. viii. 17); yet they were not so near but that Joshua could place an ambush on the west (or south-west) of Ai, without its being observed by the men of Bethel, while he himself remained behind in a valley to the north of Ai (Josh. viii. 4, 11-13). A little to the south of a village called Deir Diwan, and one hour's journey from Bethel, the site of an ancient place is indicated by reservoirs hewn in the rock, excavated tombs, and foundations of hewn stone. This, Dr. Robinson inclines to think, may mark the site of Ai, as it agrees with all the intimations as to its position. Near it, on the north, is the deep Wady el-Mutyâh, and towards the south-west other smaller wadys, in which the ambuscade of the Israelites might easily have been concealed.

AIL (אֵיל; Sept. κπλος; *decr.*, generically, according to Dr. Shaw):

AJAL (אָיָל; Sept. ἔλαφος; *hart*, in Deut. xii. 15; Ps. xlii. 1; Isa. xxxv. 6):

AJALAH (אָיָלָה; Sept. στέλεχος; *hind*, in Gen. xlix. 21; 2 Sam. xxii. 34; Job xxxix. 1; Ps. xviii. 31; Prov. v. 19; Cant. ii. 7; Jer. xiv. 5; Habak. iii. 19).



[Cervus barbarus.]

The *hart* and *hind* of our versions and of the older comments; but this interpretation is generally rejected by recent writers, who either suppose different species of antelope to be meant, or, with Dr. Shaw, consider the term to be general for several species of deer taken together. Sir J. G. Wilkinson believes Ajal to be the Ethiopian oryx, with nearly straight horns. In the article ANTELOPE it will be shown under what terms the Oryges appear to be noticed in the Bible, and at present we only observe that an Ethiopian species could not well be meant where the clean animals fit for the food of Hebrews are indicated, nor where allusion is made to suffering from thirst, and to high and rocky places as the refuge of females, or of both, since all the species of oryx inhabit the open plains, and are not remarkable for their desire of drinking; nor can either of these propensities be properly ascribed to the true antelopes, or gazellæ, of Arabia and Syria, all being residents of the plain and the desert; like the oryges, often

seen at immense distances from water, and unwilling to venture into forests, where their velocity of flight and delicacy of structure impede and destroy them. Taking the older interpretation, and reviewing all the texts where hart and hind are mentioned, we find none where these objections truly apply. Animals of the stag kind prefer the security of forests, are always most robust in rocky mountain covers, and seek water with considerable anxiety; for of all the light-footed ruminants, they alone protrude the tongue when hard pressed in the chace. Now, comparing these qualities with several texts, we find them perfectly appropriate to the species of these genera alone. Ajal appears to be a mutation of a common name with *ελαφος*; and although no great stress should be laid on names which, more particularly in early times, were used without much attention to specific identity, yet we find the Chaldee Ajal and Sarmatic Jelen strictly applied to stag. Hence the difficulty lay in the modern denial that ruminants with branched deciduous horns existed in the south-west of Asia and Egypt; and Cuvier for some time doubted, notwithstanding Virgil's notice, whether they were found in any part of Africa; nevertheless, though not abundant where water is rare, their existence from Morocco to the Nile and beyond it cannot be denied; and it is likely that an Asiatic species still appears sometimes in Syria, and, no doubt, was formerly common there.

The first species here referred to is now known by the name of *Cervus Barbarus*, or Barbary stag, in size between our red and fallow deer, distinguished by the want of a bisantler, or second branch on the horns, reckoning from below, and by a spotted livery, which is effaced only in the third or fourth year. This species is figured on Egyptian monuments, is still occasionally seen about the Natron lakes west of the Nile, and, it seems, was observed by a reverend friend in the desert east of the Dead Sea, on his route from Cairo towards Damascus. We take this to be the Igal or Ajal of the Arabs, the same which they accuse of eating fish—that is, the ceps, lizards, and snakes, a propensity common to other species, and similarly ascribed to the Virginian and Mexican deer.

The other is the Persian stag, or Maral of the Tabitar nations, and Gewazen of Armenia, larger than the stag of Europe, clothed with a heavy mane, and likewise destitute of bisantlers. We believe this species to be the Soëgur of Asiatic Turkey, and Mara of the Arabs, and therefore residing on the borders of the mountain forests of Syria and Palestine. One or both of these species were dedicated to the local *bona Jea* on Mount Libanus—a presumptive proof that deer were found in the vicinity.

Of the hind it is unnecessary to say more than that she is the female of the stag, or hart, and that in the manners of these animals the males always are the last to hurry into cover.*—C. H. S.

* In Gen. xlix. 21, Bochart's version appears to be preferable to our present translation—

'Naphtali is a hind let loose; he giveth goodly words'; this, by a slight alteration of the punctuation in the Hebrew, he renders 'Naphtali is a spreading tree, shooting forth beautiful branches.' In Ps. xxix. 9, instead of 'The voice of the Lord

AIN (אֵן, usually *En* in the English version), the Hebrew word for a *fountain*, which signification it also bears in Arabic, Syriac, and Ethiopic. It chiefly attracts notice as combined with the proper names of various places; and in all such cases it points to some remarkable or important fountain near or at the spot. Thus, אֵן גֵּדִי, *En-gedi*, 'fountain of kids' [EN-GEDI]; אֵן גַּנִּים, *En-gannim* (Josh. xv. 31), 'fountain of the gardens'; אֵן דּוֹר, *En-dor*, 'house-fountain' [*jons habitations*, Gesenius] [EN-DOR]; אֵן חֲדָדָה, *En-haddah* (Josh. xix. 21), 'sharp, i. e. 'swift fountain'; אֵן מִשְׁפָּט, *En-mishpat* (Gen. xiv. 7), 'fountain of judgment'; there also called אֵן קַק, but proleptically, as that name appears to have originated at a later period (Num. xx. 13), [KADESH]; אֵן עֵגְלַיִם, *En-eglam*, 'fountain of two calves' (Ezek. xlvi. 10) [EN-EGLAIM]; אֵן שֵׁמֶשׁ, *En-shemesh* (Josh. xv. 7), 'fountain of the sun'; אֵן רֹגֵל, *En-rogel* (2 Sam. xvii. 17, &c.), literally 'fountain of the foot,' which is construed in the Targum 'fuller's fountain,' because the fullers there trod the cloths with their feet; others, 'fountain of the spy' [EN-ROGEL]. There are other names with which אֵן is thus used in composition; but these are the most important. In one case אֵן occurs alone as the name of a place in the north-east of Palestine (Gesenius, *Thesaur.* in אֵן). In the plural it only occurs in the New Testament (John iii. 23) as *Ænon* (Αἰνών), or fountains, as in our *Fountains Abbey* in Yorkshire.

AIR (ἀήρ), the atmosphere, as opposed to the ether (αἰθήρ), or higher and purer region of the sky (Acts xxii. 24; 1 Thess. iv. 17; Rev. ii. 2; xvi. 17). The phrase εἰς ἅερα λαλεῖν—to speak into the air (1 Cor. xiv. 9), is a proverbial expression to denote speaking in vain, like *ventis verba profundere* in Latin (Lucret. iv. 929), and a similar one in our own language; and εἰς ἅερα δρέμειν, to beat the air (1 Cor. ix. 26), denotes acting in vain, and is a proverbial allusion to an abortive stroke into the air in pugilistic contests. The later Jews, in common with the Gentiles, especially the Pythagoreans, believed the air to be peopled with spirits, under the government of a chief, who there held his seat of empire (Philo 31, 28; Diog. Laert. viii. 32). These spirits were supposed to be powerful, but malignant, and to incite men to evil. That the Jews held this opinion is plain from the Rabbinical citations of Lightfoot, Wetstein, &c. Thus in *Pirke Aboth* 83. 2, they are described as *filling the whole air*, arranged in troops, in regular subordination. The early Christian fathers entertained the same belief (Ignat. *Ad Ephes.* § 13), which has indeed come down to our own times. It is to this notion that St. Paul is supposed to allude in Eph. ii. 2, where Satan is called ἀρχὼν τῆς ἐξουσίας τοῦ ἁέρος, 'prince of the power (i. e. of those who exercise the power) of the air.' Some, however, explain ἀήρ here by *darkness*, a sense which it bears also in profane writers. But the apostle no doubt speaks according to the notions entertained by most of those to whom he wrote, without expressing the

maketh the hind to calve, and discovereth the forests,' Bishop Lowth gives, 'The voice of the Lord striketh the oak, and discovereth the forests,' which is also an improvement.

extent of his own belief (see Lightfoot, Whitby, Koppe, Wetstein, and Bloomfield, *in loc.*).

AJALON (אֵיָלֹן; Sept. Αἰαλών), a town and valley in the tribe of Dan (Josh. xix. 42), which was given to the Levites (Josh. xxi. 24; 1 Chron. vi. 69). It was not far from Bethshemesh (2 Chron. xxviii. 18), and was one of the places which Rehoboam fortified (2 Chron. xi. 10), and among the strongholds which the Philistines took from Ahaz (2 Chron. xxviii. 18). But the town, or rather the valley to which the town gave name, derives its chief renown from the circumstance that when Joshua, in pursuit of the five kings, arrived at some point near Upper Beth-horon, looking back upon Gibeon and down upon the noble valley before him, he uttered the celebrated command: 'Sun, stand thou still on Gibeon, and thou moon, in the valley of Ajalon' (Josh. x. 12). From the indications of Jerome, who places Ajalon two Roman miles from Nicopolis, on the way to Jerusalem, joined to the preservation of the ancient name in the form of Yálo, Dr. Robinson (*Bibl. Researches*, iii. 63) appears to have identified the valley and the site of the town. From a house-top in Beit Ur (Beth-horon) he looked down upon a broad and beautiful valley, which lay at his feet, towards Ramleh. This valley runs out west by north through a tract of hills, and then bends off south-west through the great western plain. It is called Merj Ibn 'Omeir. Upon the side of the long hill which skirts the valley on the south, a small village was perceived, called Yálo, which cannot well be any other than the ancient Ajalon; and there can be little question that the broad wady to the north of it is the valley of the same name.

AKKO. [GOLAN.]

AKRABBIM (מַעְלֵה עַקְרָבִים, *Scorpion height*; Sept. Ἀνάβασις Ἀκραβίμ), an ascent, hill, or chain of hills, which, from the name, would appear to have been much infested by scorpions and serpents, as some districts in that quarter certainly were (Deut. viii. 15; comp. Volney, ii. 256). It was one of the points which are only mentioned in describing the frontier-line of the Promised Land southward (Judg. i. 36). Shaw conjectures that Akrabim may probably be the same with the mountains of Akabah, by which he understands the easternmost range of the μέλανα ὄρη, 'black mountains' of Ptolemy, extending from Paranto Judæa. This range has lately become well known as the mountains of Edom, being those which bound the great valley of Arabia on the east (*Travels*, ii. 120). More specifically, he seems to refer Akrabim to the southernmost portion of this range, near the fortress of Akabah, and the extremity of the eastern gulf of the Red Sea; where, as he observes, 'from the badness of the roads, and many rocky passes that are to be surmounted, the Mohammedan pilgrims lose a number of camels, and are no less fatigued than the Israelites were formerly in getting over them.' Burckhardt (*Syria*, p. 509) reaches nearly the same conclusion, except that he rather refers 'the ascent of Akrabim,' to the acclivity of the western mountains from the plain of Akabah. This ascent is very steep, 'and has probably given to the place its name of Akabah, which means a cliff, or steep declivity.' The probability of this identification depends upon the

question, whether the south-eastern frontier of Judah would be laid down so far to the south in the time of Moses and Joshua. If so, the identification is fair enough; but if not, it is of no weight or value in itself. The apparent analogy of names can be little else than accidental, when the *signification* in the two languages is altogether different.

AKROTHINION (Ἀκροθίνιον). This Greek word, which occurs in Heb. vii. 4, means the *best of the spoils*. The Greeks, after a battle, were accustomed to collect the spoils into a heap, from which an offering was first made to the gods: this was the ἀκροθίνιον (Xenoph. *Cyrop.* vii. 5, 35; Herodot. viii. 121, 122; Pind. *Nem.* 7, 58). In the first-cited case, Cyrus, after the taking of Babylon, first calls the magi, and commands them to choose the ἀκροθίνια of certain portions of the ground for sacred purposes.

ALABASTER (Ἀλάβαστρον). This word occurs in the New Testament only in the notice of the 'alabaster box,' or rather vessel, of 'ointment of spikenard, very precious,' which a woman broke, and with its valuable contents anointed the head of Jesus, as he sat at supper in Bethany in the house of Simon the leper (Matt. xxvi. 7; Mark xiv. 3). At Alabastron, in Egypt, there was a manufactory of small pots and vessels for holding perfumes, which were made from a stone found in the neighbouring mountains. The Greeks gave to

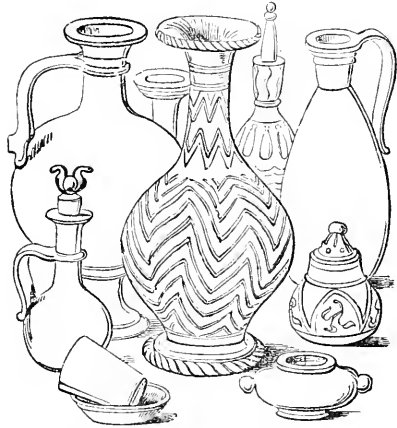

these vessels the name of the city from which they came, calling them *alabastrons*. This name was eventually extended to the stone of which they were formed: and at length the term *alabastra* was applied without distinction to all perfume vessels, of whatever materials they consisted. Theocritus speaks of golden alabastra, Συρίω μύρω χρύσει' ἀλάβαστρα (*Idyl.* xv. 114); and perfume vessels of different kinds of stone, of glass, ivory, bone, and shells, have been found in the Egyptian tombs (Wilkinson, iii. 379). It does not, therefore, by any means follow that the alabastron which the woman used at Bethany was really of alabaster: but a probability that it was such arises from the fact that vessels made of this stone were deemed peculiarly suitable for the most costly and powerful perfumes (Plin. *Hist. Nat.* xiii. 2; xxxvi. 8, 24). The woman is said

to have 'broken' the vessel; which is explained by supposing that it was one of those shaped somewhat like a Florence oil-flask, with a long and narrow neck; and the mouth being curiously and firmly sealed up, the usual and easiest way of getting at the contents was to break off the upper part of the neck.

The alabastra were not usually made of that white and soft gypsum to which the name of alabaster is now for the most part confined. Dr. John Hill, in his useful notes on Theophrastus sets this matter in a clear light:—'The *alabastrum* and *alabastrites* of naturalists, although by some esteemed synonymous terms, and by others confounded with one another, are different substances. The *alabastrum* is properly the soft stone [the common "alabaster"] of a gypseous substance, burning easily into a kind of plaster; and the *alabastra*, the hard, bearing a good polish, and approaching the texture of marble. This stone was by the Greeks called also sometimes *onyx*, and by the Latins *marmor onychites*, from its use in making boxes to preserve precious ointments; which boxes were commonly called, "onyxes" and "alabasters." Thus Dioscoride, ἀλαβαστρίτης ὁ καλούμενος ὄνυξ. And hence have arisen a thousand mistakes in the later authors, of less reading, who have misunderstood Pliny, and confounded the onyx marble, as the alabaster was frequently called, with the precious stone of that name.'

This is now better understood. It is apprehended that, from certain appearances common to both, the same name was given not only to the common alabaster, called by mineralogists *gypsum*, and by chemists *sulphate of lime*; but also to the *carbonate of lime*, or that harder stone from which the alabastra were usually made, and which was often distinguished by the name of onyx alabaster, on account of the approach of its colour to that of the human finger-nails.

ALAH (אלה), the name of a tree, which, both in its singular and plural form, occurs often in the Scriptures. It is variously rendered in ancient and modern versions—as *oak*, *terebinth*, *teyl* (linden) *tree*, *elm*, and even *plain*. This has occasioned more of apparent perplexity than now really belongs to the subject. In the masculine singular (אלה) it occurs only in Gen. xiv. 6, in connection with Paran, or as *El-Paran*. This the Sept. renders by *terebinth* (τερεβίνθου τῆς Φαράν); Aquila, Symmachus, and Theodotion by 'oak,' *quercus*; and the Samaritan, Onkelos, Kimchi, Jerome, &c., by 'plain,' which is also adopted in the margin of our Bibles. The primary import of the word is *strength*, *power*; whence some hold that it denotes any mighty tree, especially the terebinth and the oak. But the oak is *not* a mighty tree in Palestine; and as it possesses its own distinct name [ALLON], which is shown, by the apposition of the names in Isa. vi. 13, and Hos. iv. 13, to denote a different tree from *alah*, one can have little hesitation in restricting the latter to the terebinth. Indeed, this conclusion has not been much questioned since it was shown by Celsius (*Hierobotan.* ii. 34-58) that the terebinth was most probably denoted by the Hebrew *alah*;

that the terebinth is the *but'm* بطم of the Arabs;

and that the Arabian *but'm* is frequent in Palestine. The first position is of course incapable of absolute proof; the second has been confirmed by Forskal and Ehrenberg; and the third is attested by a host of travellers, who speak of it under both names. Celsius exhibits the testimonies which existed in his time: to which those of Forskal, Hasselquist, and Dr. Robinson may now be added. The last-named traveller gives the best account of the tree as it is found in Palestine. At the point where the roads from Gaza to Jerusalem, and from Hebron to Ramleh, cross each other, and about midway between the two last-named towns, this traveller observed an immense *but'm*-tree, the largest he saw anywhere in Palestine. 'This species (*Pistacia Terebinthus*) is, without doubt,' he adds, 'the terebinth of the Old Testament; and under the shade of such a tree Abraham may well have pitched his tent at



[*Pistacia Terebinthus*.]

Mamre. The *but'm* is not an evergreen, as is often represented; but its small feathered lancet-shaped leaves fall in the autumn, and are renewed in the spring. The flowers are small, and followed by small oval berries, hanging in clusters from two to five inches in length, resembling much the clusters of the vine when the grapes are just set. From incisions in the trunk there is said to flow a sort of transparent balsam, constituting a very pure and fine species of turpentine, with an agreeable odour, like citron or jessamine, and a mild taste, and hardening gradually into a transparent gum. In Palestine nothing seems to be now known of this product of the *but'm*. The tree is found also in Asia Minor (many of them near Smyrna), Greece, Italy, the south of France, Spain, and in the north of Africa; and is described as not usually rising to the height of more than twenty feet. It often exceeded that size as we saw it in the mountains; but here in the plains it was very much larger.

In Palestine and the neighbouring countries the terebinth seems to be regarded with much the same distinction as the oak is in our northern lati-

tudes. The tree is long-lived; and it is certain that there were in the country ancient terebinths, renowned for their real or supposed connection with scriptural incidents. Thus, about the time of Christ, there was at Mamre, near Hebron, a venerable terebinth, which a tradition, old in the time of Josephus, alleged to be that (rendered 'plain' in our version of Gen. xiii. 18) under which Abraham pitched his tent; and which, indeed, was believed to be as old as the creation of the world (Joseph. *Bell. Jud.* iv. 9, 7). The later tradition was content to relate that it sprang from the staff of one of the angels who appeared there to Abraham (Gen. xviii. 2). Having, from respect to the memory of the patriarch, and as one of the spots consecrated by the presence of 'commissioned angels,' become a place of great resort and pilgrimage both of Jews and Christians, the Phœnicians, Syrians, and Arabians were attracted to it with commercial objects; and it thus became a great fair. At this fair thousands of captive Jews were sold for slaves by order of Hadrian in A.D. 135 (Jerome, *Comm. in Zech.* xi. 4, *De Locis Heb.* 87; Hegeſipp. iv. 17; Sozom. *Hist. Eccles.* ii. 4, 5; Nicoph. viii. 30; Reland, *Palæst.* p. 714). Being a place of such heterogeneous assemblage, great abominations and scandals, religious and moral, arose, to which a stop was at length put by Eusebians of Cæsarea and the other bishops of Palestine, who, by order of Constantine, cast down all the pagan altars, and built a church by or under the tree. It is said that the tree dried up in the reign of Theodosius the Younger; but that the still vital trunk threw off shoots and branches, and produced a new tree, from which Brocard (vii. 64), Salignac (x. 5), and other old travellers declare that they brought slips of the new and old wood to their own country. Zuallart, who alleges that some of its wood was given to him by the monks at Jerusalem, candidly admits the difficulty of believing the stories which were told of its long duration: but he satisfies himself with the authority of the authors we have mentioned, and concludes that God may have specially interfered to preserve it, with other old memorials, for his own glory and for our instruction (*Voyage de Jérusalem*, iv. 1). The tree was accidentally destroyed by fire in 1616 A.D. (Mariti, p. 520).

ALCIMUS, or JACIMUS (*Ἀλκιμος ἢ καὶ Ἰάκιμος*, Joseph. *Antiq.* xii. 9. 3, Græcised forms of Eliakim and Joachim—names often interchanged in Hebrew), an usurping high-priest of the Jews in the time of Judas Maccabæus [MACCABEES; PRIESTS, HIGH].

ALEXANDER THE GREAT. This mighty king is named in the opening of the first book of Maccabees, and is alluded to in the prophecies of Daniel. These, however, are not the principal reasons for giving his name a place in this work: he is chiefly entitled to notice here because his military career permanently affected the political state of the Jewish people, as well as their philosophy and literature. It is not our part, therefore, to detail even the outlines of his history, but to point out the causes and nature of this great revolution, and the influence which, formally through Alexander, Greece has exerted over the religious history of the West.

The conquest of Western Asia by Greeks was so thoroughly provided for by predisposing causes,

as to be no mere accident ascribable to Alexander as an individual. The wars which were carried



on between Greece and Persia in the reigns of Darius, Xerxes, and Artaxerxes—from B.C. 490 to B.C. 419—sufficiently showed the decisive superiority in arms which the Greeks possessed, though no Greek as yet aspired to the conquest of Persia. Brave freemen, attached to their own soil, would not risk abandoning it for ever for the satisfaction of chasing their foe out of his home. But after the convulsions of the Peloponnesian War (B.C. 431-404) had filled Greece with exiles, whose sole trade was that of soldiers, a devoted standing army could be had for money. By the help of such mercenaries, Cyrus, younger brother of Artaxerxes II., attempted to seize the crown of Persia (B.C. 401); and although he was himself slain, this, in its results (which cannot be here properly detailed), did but show more signally that Greeks might force their way to the very palace of the great king, just as they afterwards triumphantly retreated through the heart of his empire. Soon after this, Agesilaus, king of Sparta, appears to have had serious designs of founding a Spartan province in Asia Minor, where he met with easy success; but he was recalled by troubles at home (B.C. 394). About the year B.C. 374, Jason, the chief man of Phœræ, in Thessaly, and virtually monarch of the whole province, having secured the alliance of Macedon, seriously meditated the conquest of the Persian empire; and he (or his son) might probably have effected it, had he not been assassinated, B.C. 370. The generation who heard of that event witnessed the rise of Macedon to supremacy under the great Philip, whose reign reached from B.C. 359 to B.C. 336. He too had proposed to himself the invasion and conquest of Persia as the end of all his campaigns and the reward of all his labours; and he too was suddenly taken off by the assassin's dagger. He was succeeded by his greater son, for whom it was reserved to accomplish that of which Grecian generals had now for seventy years dreamed. It seems therefore clear that Greece was destined to overflow into Asia, even without Alexander; for Persia was not likely to have such a series of able monarchs, and such an exemption from civil wars, as alone could have hindered the event. The personal genius of the Macedonian hero, however, determined the form and the suddenness of the conquest; and, in spite of his premature death, the policy which he pursued seems to have left some permanent effects. It is indeed possible that, in regard to the toleration of Oriental cus-

toms and religions, no other policy than his could have held the empire together. Since the Romans in Asia and the British in India have followed the same procedure, any other Greek conquerors of Persia might have done the same had Alexander never existed. Be this as it may, it is certain that his conciliatory policy was copied by his successors for at least a century and a half.

His respectful behaviour to the Jewish high-priest has been much dwelt on by Josephus (*Antiq.* xi. 8, 4-6), a writer whose trustworthiness has been greatly overrated. Special reasons for questioning the story may be found in Thirlwall (*Hist. of Greece*, vi. 206): but in fact, as it evidently rests on mere tradition, even a knowledge of human nature, and of the particular author, justifies large deductions from the picturesque tale. Some of the results, however, can hardly be erroneous, such as, that Alexander guaranteed to the Jews, not in Judæa only, but in Babylonia and Media, the free observance of their hereditary laws, and on this ground exempted them from tribute every seventh (or sabbatical) year. From the Romans in later times they gained the same indulgence, and it must no doubt have been enjoyed under the Persian king also, to whom they paid tribute at the time of Alexander's invasion. It is far from improbable then that the politic invader affected to have seen and heard the high-priest in a dream (as Josephus relates), and showed him great reverence, as to one who had declared 'that he would go before him and give the empire of Persia into his hand.' The profound silence observed concerning Judæa by all the historians of Alexander, at any rate proves that the Jews passed over without a struggle from the Persian to the Macedonian rule.

Immediately after, he invaded and conquered Egypt, and showed to its gods the same respect as to those of Greece. Almost without a pause he founded the celebrated city of Alexandria (B.C. 332), an event which, perhaps more than any other cause, permanently altered the state of the East, and brought about a direct interchange of mind between Greece, Egypt, and Judæa. Sidon had been utterly ruined by Artaxerxes Ochus (B.C. 351), and Tyre, this very year, by Alexander: the rise of a new commercial metropolis on the Mediterranean was thus facilitated; and when the sagacious Ptolemy became master of Egypt (B.C. 323), that country presently rose to a prosperity which it never could have had under its distant and intolerant Persian lords. The Indian trade was diverted from its former course up the Euphrates into the channel of the Red Sea; and the new Egyptian capital soon became a centre of attraction for Jews as well as Greeks. Under the dynasty of the Ptolemies the Hellenic race enjoyed such a practical ascendancy (though on the whole to the benefit of the native Egyptians) that the influx of Greeks was of course immense. At the same time, owing to the proximity of the Egyptian religion, both the religion and the philosophy of the Greeks assumed here a modified form, and the monarchs, who were accustomed to tolerate and protect Egyptian superstition, were naturally very indulgent to Jewish peculiarities. Alexandria therefore became a favourite resort of the Jews, who here lived under their own laws, administered by a governor (*ἐθνάρχης*) of their own

nation; but they learned the Greek tongue, and were initiated more or less into Greek philosophy. Their numbers were so great as to make them a large fraction of the whole city; and out of their necessities arose the translation of the Old Testament into Greek. The close connection which this Egyptian colony maintained with their brethren in Palestine produced various important mental and spiritual effects on the latter [*ESSENES*]. The most accessible specimen of rhetorical morality produced by the Hebrew culture of Greek learning is to be seen in the book called the Wisdom of Solomon: the most elaborate development of Hebrew Platonism is contained in the works of Philo. In the writing called the Third Book of the Maccabees is a sufficiently unfavourable specimen of an attempt at rhetorical history by a mind educated in the same school. How deep an impress has been left on the Christian Church by the combination of Greek and Hebrew learning which characterized Alexandria, it needs many pages for the ecclesiastical historian to discuss. The Grecian cities afterwards built in northern Palestine [*DECAPOLIS*] seem to have exerted little spiritual influence on the south; for a strong repulsion existed in the strictly Jewish mind against both Samaria and Galilee.

The tolerant policy of Alexander was closely followed by his great successor Seleucus, who admitted the Jews to equal rights with Macedonians in all his new cities, even in his capital of Antioch (*Joseph. Antiq.* xii. 3, 1); and similar or greater liberality was exercised by the succeeding kings of that line, down to Antiochus Epiphanes [*ANTIOCHUS*]. It can scarcely be doubted that on this to a great extent depended the remarkable westward migration of the Jews from Media and Babylon into Asia Minor, which went on silently and steadily until all the chief cities of those parts had in them the representatives of the twelve tribes. This again greatly influenced the planting of Christianity, the most favourable soil for which, during the time of its greatest purity, was in a Greek population which had previously received a Jewish culture. In passing we may remark, that we are unable to find the shadow of a reason for the popular assumption that the modern European Jews are descendants of the *two* more than of the other *ten* or eleven tribes.

The great founder of Alexandria died in his thirty-second year, B.C. 323. The empire which he then left to be quarrelled for by his generals comprised the whole dominions of Persia, with the homage and obedience of Greece superadded. But on the final settlement which took place after the battle of Ipsus (B.C. 301), Seleucus, the Greek representative of Persian majesty, reigned over a less extended district than the last Darius. Not only were Egypt and Cyprus severed from the eastern empire, but Palestine and Cæleſyria also fell to their ruler, placing Jerusalem for nearly a century beneath an Egyptian monarch. On this subject, see further under *ANTIOCHUS*.

The word Alexander means *the helper* or *rescuer of men*, denoting military prowess. It is Homer's ordinary name for Paris, son of Priam, and was borne by two kings of Macedon before the great Alexander. The history of this conqueror is known to us by the works of Arrian and Quintus Curtius especially, besides the general sources for all Greek history. Neither of these

authors wrote within four centuries of the death of Alexander; but they had access to copious contemporary narratives since lost.—F. W. N.

2. ALEXANDER, surnamed BALAS, from his mother Bala, a personage who figures in the history of the Maccabees and in Josephus. His extraction is doubtful; but he professed to be the



natural son of Antiochus Epiphanes, and in that capacity, out of opposition to Demetrius Soter, he was recognised as king of Syria by the king of Egypt, by the Romans, and eventually by Jonathan Maccabæus, on the part of the Jews. The degree of strength and influence which the Jewish chief possessed, was sufficient to render his adhesion valuable to either party in the contest for the throne. As he was obliged to take a side, and had reason to distrust the sincerity of Demetrius, Jonathan yielded to the solicitations of Alexander, who, on arriving at Ptolemais, sent him a purple robe and a crown of gold, to induce him to espouse his cause (1 Macc. x. 18). Demetrius was not long after slain in battle, and Balas obtained possession of the kingdom. He then sought to strengthen himself by a marriage with the king of Egypt's daughter. This marriage was celebrated at Ptolemais, and was attended by Jonathan, who received marks of high consideration from the Egyptian (Ptolemy Philome' or) and Syrian kings (1 Macc. 51-56; Joseph. *Antiq.* xiii. 4). Prosperity ruined Alexander; he soon abandoned himself to voluptuousness and debauchery, leaving the government in the hands of ministers whose misrule rendered his reign odious. This encouraged Demetrius Nicator, the eldest son of the late Demetrius Soter, to appear in arms, and claim his father's crown. Alexander took the field against him; and in the brief war that followed, although his father-in-law Ptolemy (who had his own designs upon Syria) abandoned his cause, Jonathan remained faithful to him, and rendered him very important services, which the king rewarded by bestowing on him a golden chain, such as princes only wore, and by giving him possession of Ekron (*Ἐκκράων*). The defection of the Egyptian king, however, was fatal to the cause of Balas; he was defeated in a pitched battle, and fled with 500 cavalry to Abæ in Arabia, and sought refuge with the emir Zabdiel. The Arabian murdered his confiding guest in the fifth year of his reign over Syria, and sent his head to Ptolemy, who himself died the same year, B.C. 145. Balas left a young son, who was eventually made king of Syria by Tryphon, under the name of Antiochus Theos (1 Macc. xi. 13-18; Joseph. *Antiq.* xiii. 4).

3. ALEXANDER JANNÆUS, the first prince of the Maccabæan dynasty who assumed the title of king [MACCABEES].

4. ALEXANDER, son of Herod the Great and Mariamne [HERODIAN FAMILY].

5. ALEXANDER, a Jew of Ephesus, known only from the part he took in the uproar about Diana, which was raised there by the preaching of Paul. As the inhabitants confounded the Jews and Jewish Christians, the former put forward Alexander to speak on their behalf, but he was unable in the tumult to obtain a hearing (Acts xix. 33). Some suppose that this person is the same with 'Alexander the coppersmith,' of 2 Tim. iv. 14, but this is by no means probable: the name of Alexander was in those times very common among the Jews.

6. ALEXANDER, a coppersmith or brazier (mentioned in 1 Tim. i. 20; 2 Tim. iv. 14), who with Hymenæus and others broached certain heresies touching the resurrection, for which they were excommunicated by St. Paul. These persons, and especially Alexander, appear to have maligned the faith they had forsaken, and the character of the apostle. As every Jew learned some trade, it has been imagined that Alexander was really a man of learning, and not an artizan, although acquainted with the brazier's craft. But we are not aware that it was usual to designate a literate person by the name of the trade with which he was acquainted, although this may possibly have been the case when a man bore a name so common, and so undistinguishing as that of Alexander.

ALEXANDRE, or SALOME, wife of Alexander JANNÆUS [MACCABEES].

ALEXANDRIA (*Ἀλεξάνδρεια*, 3 Macc. iii. 1, 21), the chief maritime city, and long the metropolis of Lower Egypt. As this city owed its foundation to Alexander the Great, the Old Testament canon had closed before it existed; nor is it often mentioned in the Apocrypha, or in the New Testament. But it was in many ways most importantly connected with the later history of the Jews—as well from the relations which subsisted between them and the Ptolemies, who reigned in that city, as from the vast numbers of Jews who were settled there, with whom a constant intercourse was maintained by the Jews of Palestine. It is perhaps safe to say that, from the foundation of Alexandria to the destruction of Jerusalem, and even after, the former was of all foreign places that to which the attention of the Jews was most directed. And this appears to have been true even at the time when Antioch first, and afterwards Rome, became the seat of the power to which the nation was subject.

Alexandria is situated on the Mediterraneanean, twelve miles west of the Canopic mouth of the Nile, in 31° 13' N. lat. and 25° 53' E. long. It owes its origin to the comprehensive policy of Alexander, who perceived that the usual channels of commerce might be advantageously altered; and that a city occupying this site could not fail to become the common emporium for the traffic of the eastern and western worlds, by means of the river Nile, and the two adjacent seas, the Red Sea and the Mediterranean; and the high prosperity which, as such, Alexandria very rapidly attained, proved the soundness of his judgment, and exceeded any expectations which even he could have entertained. For a long period Alexandria was the greatest of known cities; for Nineveh and Babylon had fallen, and Rome had not yet risen to pre-eminence; and even when

Rome became the mistress of the world, and Alexandria only the metropolis of a province, the latter was second only to the former in wealth, extent, and importance; and was honoured with the magnificent titles of the second metropolis of the world, the city of cities, the queen of the East, a second Rome (Diod. Sic. xvii.; Strab. xvii.; Ammian. Marcell. xxii.; Hegesipp. iv. 27; Joseph. *Bell. Jud.* iv. 11, 5).

The city was founded in B.C. 332, and was built under the superintendence of the same architect (Dinocrates) who had rebuilt the Temple of Diana at Ephesus. As a foreign city, not mentioned at all in the Old Testament, and only accidentally in the New (Acts vi. 9; xviii. 24; xxvii. 6), it is introduced into this work only on account of its connection with the history and condition of the

Jewish people. To the facts resulting from it bearing on that connection, our notice must therefore be limited, without entering into those descriptions of the ancient or of the modern city which are given in general and geographical cyclopædias. It may suffice to mention that the ancient city appears to have been of seven times the extent of the modern. If we may judge from the length of the two main streets (crossing each other at right angles) by which it was intersected, the city was about four miles long by one and a half wide: and in the time of Diodorus it contained a free population of 300,000 persons, and altogether probably 600,000, if we double the former number, as Mannert suggests, in order to include the slaves. The port of Alexandria is described by Josephus (*Bell. Jud.* iv. 10, 5); and his description is in perfect conformity with the best modern accounts.

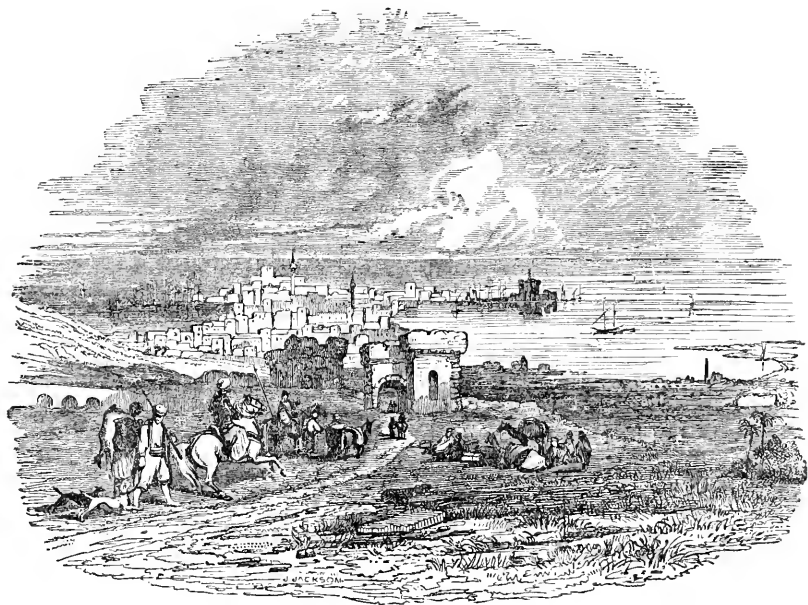

It was secure, but difficult of access; in consequence of which, a magnificent pharos, or lighthouse, was erected upon an islet at the entrance, which was connected with the mainland by a dyke. This pharos was accounted one of the 'seven' wonders of the world. It was begun by Ptolemy Soter, and completed under Ptolemy Philadelphus, by Sostratus of Cnidus, B.C. 283. It was a square structure of white marble, on the top of which fires were kept constantly burning for the direction of mariners. It was erected at a cost of 800 talents, which, if Attic, would amount to 165,000*l.*, if Alexandrian, to twice that sum. It was a wonder in those times, when such erections were almost unknown; but, in itself, the Eddystone lighthouse is, in all probability, ten times more wonderful.

The business of working out the great design of Alexander could not have devolved on a more fitting person than Ptolemy Soter. From his first arrival in Egypt, he made Alexandria his resi-

dence: and no sooner had he some respite from war, than he bent all the resources of his mind to draw to his kingdom the whole trade of the East, which the Tyrians had, up to his time, carried on by sea to Elath, and from thence, by the way of Rhinocorura, to Tyre. He built a city on the west side of the Red Sea, whence he sent out fleets to all those countries to which the Phœnicians traded from Elath. But, observing that the Red Sea, by reason of rocks and shoals, was very dangerous towards its northern extremity, he transferred the trade to another city, which he founded at the greatest practicable distance southward. This port, which was almost on the borders of Ethiopia, he called, from his mother, Berenice; but the harbour being found inconvenient, the neighbouring city of Myos Hormos was preferred. Thither the products of the east and south were conveyed by sea; and were from thence taken on camels to Coptus, on the Nile, where they were again shipped for Alexandria, and from that city were

dispersed into all the nations of the west, in exchange for merchandise which was afterwards exported to the East (Strabo, xxii. p. 805; Plin. *Hist. Nat.* vi. 23). By these means, the whole trade was fixed at Alexandria, which thus became the chief mart of all the traffic between the East and West, and which continued to be the greatest emporium in the world for above seventeen centuries, until the discovery of the passage by the Cape of Good Hope opened another channel for the commerce of the East.

Alexandria became not only the seat of commerce, but of learning and the liberal sciences. This distinction also it owed to Ptolemy Soter, himself a man of education, who founded an academy, or society of learned men, who devoted themselves to the study of philosophy, literature, and science. For their use he made a collection of choice books, which, by degrees, increased under his successors until it became the finest library in the world, and numbered 700,000 volumes (Strab. xvii. p. 794; Euseb. *Chron.*) It sustained repeated losses, by fire and otherwise, but these losses were as repeatedly repaired; and it continued to be of great fame and use in those parts, until it was at length burnt by the Saracens when they made themselves masters of Alexandria in A.D. 642. Undoubtedly the Jews at Alexandria shared in the benefit of these institutions, as the Christians did afterwards; for the city was not only a seat of heathen, but of Jewish, and subsequently of Christian learning. The Jews never had a more profoundly learned man than Philo, nor the Christians men more erudite than Origen and Clement; and if we may judge from these celebrated natives of Alexandria, who were remarkably intimate with the heathen philosophy and literature—the learning acquired in the Jewish and Christian schools of that city must have been of that broad and comprehensive character which its large and liberal institutions were fitted to produce. It will be remembered that the celebrated translation of the Hebrew Scriptures into Greek [SEPTUAGINT] was made, under every encouragement from Ptolemy Philadelphus, principally for the use of the Jews in Alexandria, who knew only the Greek language; but partly, no doubt, that the great library might possess a version of a book so remarkable, and, in some points, so closely connected with the ancient history of Egypt. The work of Josephus against Apion affords ample evidence of the attention which the Jewish Scriptures excited.

At its foundation Alexandria was peopled less by Egyptians than by colonies of Greeks, Jews, and other foreigners. The Jews, however much their religion was disliked, were valued as citizens; and every encouragement was held out by Alexander himself and by his successors in Egypt, to induce them to settle in the new city. The same privileges as those of the first class of inhabitants (the Greeks) were accorded to them, as well as the free exercise of their religion and peculiar usages: and this, with the protection and security which a powerful state afforded against the perpetual conflicts and troubles of Palestine, and with the inclination to traffic, which had been acquired during the Captivity, gradually drew such immense numbers of Jews to Alexandria, that they eventually formed a very large portion of its vast population, and at the same time constituted a

most thriving and important section of the Jewish nation. The Jewish inhabitants of Alexandria are therefore often mentioned in the later history of the nation; and their importance as a section of that nation would doubtless have been more frequently indicated, had not the Jews of Egypt thrown off their ecclesiastical dependence upon Jerusalem and its temple, and formed a separate establishment of their own, at On or Heliopolis [ON; ONIAS]. This left them less inducement or occasion than they would otherwise have had to mix themselves up with the affairs of the parent country: but they were not wanting in becoming patriotism; and they were on more than one occasion involved in measures directed against the Jews as a nation, and occasionally experienced some effects of that anger in the ruling powers, or of exasperation in the populace, of which the Jews in Palestine were the primary objects, or which resulted from the course which they had taken.

The inhabitants of Alexandria were divided into three classes: 1. The Macedonians, the original founders of the city; 2. the mercenaries who had served under Alexander; 3. the native Egyptians. Through the favour of Alexander and Ptolemy Soter, the Jews were admitted into the first of these classes, and this privilege was so important that it had great effect in drawing them to the new city (Hecateus, in Joseph. *Contra Apion.* l. ii.; *Bell. Jud.* ii. 36; Q. Curt. iv. 8). These privileges they enjoyed undisturbed until the time of Ptolemy Philopator, who, being exasperated at the resistance he had met with in attempting to enter the temple at Jerusalem, wreaked his wrath upon the Jews of Alexandria, on his return to Egypt. He reduced to the third or lowest class all but such as would consent to offer sacrifices to the gods he worshipped; but of the whole body only 300 were found willing to abandon their principles in order to preserve their civil advantages. The act of the general body in excluding the 300 apostates from their congregations was so represented to the king as to move his anger to the utmost, and he madly determined to exterminate all the Jews in Egypt. Accordingly, as many as could be found were brought together, and shut up in the spacious hippodrome of the city, with the intention of letting loose 500 elephants upon them; but the animals refused their horrid task, and, turning wildly upon the spectators and the soldiers, destroyed large numbers of them. This, even to the king, who was present, seemed so manifest an interposition of Providence in favour of the Jews, that he not only restored their privileges, but loaded them with new favours. This story, as it is omitted by Josephus and other writers, and only found in the third book of Maccabees (ii.-v.), is considered doubtful.

The dreadful persecution which the Jews of Alexandria underwent in A.D. 39, shows that, notwithstanding their long establishment there, no friendly relations had arisen between them and the other inhabitants, by whom in fact they were intensely hated. This feeling was so well known, that at the date indicated, the Roman governor Avilius Flaccus, who was anxious to ingratiate himself with the citizens, was persuaded that the surest way of winning their affections was to withdraw his protection from the Jews, against whom the emperor was already exaspe-

rated by their refusal to acknowledge his right to divine honours, which he insanely claimed, or to admit his images into their synagogues. The Alexandrians soon found out that they would not be called to account for any proceedings they might have recourse to against the Jews. The insult and bitter mockery with which they treated Herod Agrippa when he came to Alexandria, before proceeding to take possession of the kingdom he had received from Caligula, gave the first intimation of their dispositions. Finding that the governor connived at their conduct, they proceeded to insist that the emperor's images should be introduced into the Jewish synagogues; and on resistance being offered, they destroyed most of them, and polluted the others by introducing the imperial images by force. The example thus set by the Alexandrians was followed in other cities of Egypt, which contained at this time about a million of Jews; and a vast number of oratories—of which the largest and most beautiful were called synagogues—were all either levelled with the ground, consumed by fire, or profaned by the emperor's statues (Philo, *In Flacc.* p. 968-1009, ed. 1640; *De Leg.* ix.; Euseb. *Chron.* 27, 28).

Flaccus soon after declared himself openly, by publishing an edict depriving the Jews of the rights of citizenship, which they had so long enjoyed, and declaring them aliens. The Jews then occupied two out of the five quarters (which took their names from the five first letters of the alphabet) into which the city was divided; and as they were in those times, before centuries of oppression had broken their spirit, by no means remarkable for their submission to wrongous treatment, it is likely that they made some efforts towards the maintenance of their rights, which Philo neglects to record, but which gave some kind of pretence for the excesses which followed. At all events, the Alexandrians, regarding them as abandoned by the authorities to their mercy, openly proceeded to the most violent extremities. The Jews were forcibly driven out of all the other parts of the city, and confined to one quarter; and the houses from which they had been driven, as well as their shops and warehouses, were plundered of all their effects. Impoverished, and pent up in a narrow corner of the city, where the greater part were obliged to lie in the open air, and where the supplies of food were cut off, many of them died of hardship and hunger; and whoever was found beyond the boundary, whether he had escaped from the assigned limits, or had come in from the country, was seized and put to death with horrid tortures. So likewise, when a vessel belonging to Jews arrived in port, it was boarded by the mob, pillaged, and then burnt, together with the owners.

At length king Herod Agrippa, who stayed long enough in Alexandria to see the beginning of these atrocities, transmitted to the emperor such a report of the real state of affairs as induced him to send a centurion to arrest Flaccus, and bring him a prisoner to Rome. This put the rioters in a false position, and brought some relief to the Jews; but the tumult still continued, and as the magistrates refused to acknowledge the citizenship of the Jews, it was at length agreed that both parties should send delegates, five on each side, to Rome, and refer the decision of the controversy to the em-

peror. At the head of the Jewish delegation was the celebrated Philo, to whom we owe the account of these transactions; and at the head of the Alexandrians was the noted Apion. The latter chiefly rested their case upon the fact that the Jews were the only people who refused to consecrate images to the emperor, or to swear by his name. But on this point the Jewish delegates defended themselves so well, that Caligula himself said, 'These men are not so wicked as ignorant and unhappy, in not believing me to be a god!' The ultimate result of this appeal is not known, but the Jews of Alexandria continued to be harassed during the remainder of Caligula's reign; and their alabarch Alexander Lysimachus (brother of Philo) was thrown into prison, where he remained till he was discharged by Claudius, upon whose accession to the empire the Alexandrian Jews betook themselves to arms. This occasioned such disturbances that they attracted the attention of the emperor, who, at the joint entreaty of Herod and Agrippa, issued an edict conferring on the Jews of Egypt all their ancient privileges (Philo, *In Flacc.* Op. p. 1019-1043; Joseph. *Antiq.* xviii. 10; xix. 4). The state of feeling in Alexandria which these facts indicate, was very far from being allayed when the revolt of the Jews in Palestine caused even those of the nation who dwell in foreign parts to be regarded as enemies, both by the populace and the government. In Alexandria, on a public occasion, they were attacked, and those who could not save themselves by flight were put to the sword. Only three were taken alive, and they were dragged through the city to be consigned to the flames. At this spectacle the indignation of the Jews rose beyond all bounds. They first assailed the Greek citizens with stones, and then rushed with lighted torches to the amphitheatre, to set it on fire and burn all the people who were there assembled. The Roman prefect Tiberius Alexander, finding that milder measures were of no avail, sent against them a body of 17,000 soldiers, who slew about 50,000 of them, and plundered and burned their dwellings (Joseph. *Bell. Jud.* ii. 18. 7; comp. *Matt.* xxiv. 6).

After the close of the war in Palestine, new disturbances were excited in Egypt by the Sicarii, many of whom had fled thither. They endeavoured to persuade the Jews to acknowledge no king but God, and to throw off the Roman yoke. Such persons as opposed their designs and tendered wiser counsels to their brethren, they secretly assassinated, according to their custom. But the principal Jews in Alexandria having in a general assembly earnestly warned the people against these fanatics, who had been the authors of all the troubles in Palestine, about 600 of them were delivered up to the Romans. Several fled into the Thebaid, but were apprehended and brought back. The most cruel tortures which could be devised had no effect in compelling them to acknowledge the emperor for their sovereign; and even their children seemed endowed with souls fearless of death, and bodies incapable of pain. Vespasian, when informed of these transactions, sent orders that the Jewish temple in Egypt should be destroyed. Lupus the prefect, however, only shut it up, after having taken out the consecrated gifts: but his successor Paulinus stripped it completely, and excluded the Jews entirely from it. This was in A.D. 75, being the 343rd year from its erection by Onias.

St. Mark is said to have introduced the Christian religion into Alexandria, which early became one of the strongholds of the true faith. The Jews continued to form a principal portion of the inhabitants, and remained in the enjoyment of their civil rights till A.D. 415, when they incurred the hatred of Cyril the patriarch, at whose instance they were expelled, to the number of 40,000, and their synagogues destroyed. However, when Amrou, in A.D. 640, took the place for the caliph Omar, he wrote to his master in these terms:—'I have taken the great city of the west, which contains 4000 palaces, 4000 baths, 400 theatres, 12,000 shops for the sale of vegetable food, and 40,000 tributary Jews.' From that time the prosperity of Alexandria very rapidly declined; and when, in 969, the Fatemite caliphs seized on Egypt and built New Cairo, it sunk to the rank of a secondary Egyptian city. The discovery of the passage to the East by the Cape, in 1497, almost annihilated its remaining commercial importance; and although the commercial and maritime enterprises of Mehemet Ali have again raised it to some distinction, Alexandria must still be accounted as one of those great ancient cities whose glory has departed. When Benjamin of Tudela visited the place (*Itin.* i. 158, ed. Asher), the number of Jews was not more than 3000, and does not now exceed 500 (J. A. St. John, *Egypt*, ii. 384). The whole population at the present time (1843) is between 36,000 and 40,000, of whom 4876 are foreigners (Hogg's *Visit to Alexandria*, i. 101).

ALEXANDRIUM, a castle built by Alexander Jannæus on a mountain near Coreæ (Κορέα), one of the principal cities of northernmost Judea towards Samaria. The princes of the founder's family were mostly buried here; and hither Herod carried the remains of his sons Alexander and Aristobulus (who were maternally of that family), after they had been put to death at Sebaste (Joseph. *Antiq.* xiii. 24; xiv. 6, 10, 27; xvi. 2, *et uli.*). The situation of Coreæ, which determines that of the castle, is not known; but Dr. Robinson (*Bib. Researches*, iii. 83) conjectures that he may have found it in the modern Kuriyzet, which is about eight miles S. by E. from Nabulus (Shechem). But this place, we imagine, is too far north to have been within even the northernmost limits of Judea.

ALGUM (אֲלֻגִּים), or ALMUG TREES (אֲלֻגִּים). These are, no doubt, two forms of the same word, as they occur in passages referring to the same events, and differ only in the transposition of letters. In 1 Kings x. 11, it is said, 'And the navy also of Hiram, that brought gold from Ophir, brought in from Ophir great plenty of almug-trees and precious stones. And the king made of the almug-trees pillars for the house of the Lord, and for the king's house, harps also and psalteries for singers.' In the parallel passages of 2 Chron. ix. 10, 11, the word algum is substituted for almug, and it is added, 'There were none such seen before in the land of Judah.' As no similar name has yet been discovered which is applicable to any kind of wood from the countries whence the almug-trees are supposed to have been brought, various conjectures have been formed respecting them. It is necessary first to settle whence these trees were

brought. To us there appears no doubt that Ophir was to the southward of the Red Sea, and was most probably in some part of India (*Pictorial Bible*, ii. 349-366). The products brought from thence, such as gold, precious stones, ivory, apes, and peacocks, were all procurable only from that country. Even tin, obtained at a later period from Tartessus, was probably first procured from an earlier Tarshish, as it is abundant in Temaserim, the Malayan peninsula, the island of Banca, &c. Its uses were well known to the Indians, who received it also in exchange when brought to them by the Red Sea, as it no doubt was, at the time when the Periplus of the Erythrean Sea was written.

Various trees have been attempted to be identified with the almug. These it is unnecessary to enumerate at length, as only a few of them seem deserving of attention. The Greek translator of the book of Kings explains the Hebrew word by *ἔϋλα ἀπελεκητα*, 'unhewn wood'; but in both the places in Chronicles it is rendered *ἔϋλα πύκινα*, 'pine-wood.' This is also the interpretation of the old Latin version at 2 Chron. ii. 8; but in the two other passages that version gives it the acceptance of 'thyme-wood' (*Ligna thymia*). The thyme-wood which is mentioned in Rev. xviii. 12, is no doubt the *Lignum thymum*, which was also called citrinum, citron-wood. It was highly valued by the Romans, and employed by them for the doors of their temples and the images of their gods. This wood was obtained from the north of Africa, where the tree producing it has recently been rediscovered. If algum-wood was brought from the north coast of Africa, there certainly does not appear any tree more worthy to be considered as such than *Thuya articulata*, or *Callitris quadrivalvis* [THYME WOOD]. From the passage of 2 Chron. ii. 8:—'Send me also cedar-trees, fir-trees, and almug-trees out of Lebanon,' it has been inferred that this might be one of the pine tribe procurable in that mountain: but in the parallel passage in 1 Kings v. 8, only timber of cedar and timber of fir are mentioned. On this Rosenmüller observes, 'that the addition of "almug" in the book of Chronicles appears to have been the interpolation of a transcriber' (*Bibl. Eoet.* p. 245). If the almug had been a tree of Lebanon, we should have a difficulty in understanding how, after the time of Solomon, 'there came no such almug-trees, nor were such seen unto this day' (1 Kings x. 12).

We feel satisfied, however, that almug-trees were brought from southern regions by the Red Sea; and it could not have been more difficult to convey them from thence to the Mediterranean than it must have been to transport timber from Joppa to Jerusalem. If we consider the great deficiency of timber on the coasts both of Arabia and of Egypt—a deficiency which, from the general dryness of the soil and climate, must have been experienced in remote ages, as well as at the present time—we should expect that, where we have notices of so much shipping, there must early have been established a trade in timber. Forskal particularly mentions the importation of timber-woods from India into Arabia. Of the kinds enumerated, it has been shown that *saj*, *abnoos*, and *shisham* are teak, ebony, and sissoo (*Essay on Hindoo Medicine*, p. 128). Forskal also mentions

the Teak as imported into Egypt: 'Carina navis fundatur Ligno saj ساج ex India allato,' p. lvi.

Having been brought from so great a distance, and thought sufficiently remarkable to be worthy of special record, it is reasonable to suppose that almug-trees possessed properties not common in the timber usually met with in Palestine, whether in appearance, in colour, or in odour. Several Indian trees have been enumerated as likely to have been the almug. Of these, bukkum, or sapan wood (*Cæsalpinia sappan*), much used in dyeing, belongs to the same genus as the Brazil-wood of South America, but its nearest locality is the eastern side of the Bay of Bengal. The teak, highly valued from its indestructible nature, great size, and strength, might be more reasonably adduced, because more easily procurable, from the greater accessibility of the Malabar coast; but being a coarse-grained wood, it might not be so well suited for musical instruments. If one of the pine tribe be required, none is more deserving of selection than the deodar (*deo*, god; *dar*, wood: *Pinus deodara*), as it grows to a large size, yields excellent timber, which is close-grained and fragrant; but the tree is found only in very inaccessible situations.

Others have been in favour of sandal-wood, but have confounded with the true and far-famed kind what is called red sandal-wood, the product of *Pterocarpus santalinus*, as well as of *Adecanthera pavonina*. But there are two kinds of fragrant sandal-wood, the yellow and the white, both mentioned in old works on *Materia Medica*. Both these are thought by some to be the produce of the same tree, the younger and outer layers of wood forming the white, while the centre layers become coloured, and form the yellow.

Recent investigations confirm the opinion of Garcias, that the yellow and white sandal-woods are the produce of different trees, both of which, however, belong to the same genus, *Santalum*. M. Gaudichaud has described the species, which he has named *S. Freycinetianum*, as that yielding the yellow sandal-wood so much valued by the Chinese, and obtained by them from the Feejee, Marquesas, and Molucca Islands.

But the most common sandal-wood is that which is best known and most highly esteemed in India. It is produced by the *Santalum album*, a native of the mountainous parts of the coast of Malabar, where large quantities are cut for export to China, to different parts of India, and to the Persian and Arabian gulfs. The outer parts of this tree are white and without odour; the parts near the root are most fragrant, especially of such trees as grow in lilly situations and stony ground. The trees vary in diameter from 9 inches to a foot, and are about 25 or 30 feet in height, but the stems soon begin to branch. This wood is white, fine-grained, and agreeably fragrant, and is much employed for making rosaries, fans, elegant boxes and cabinets. The Chinese use it also as incense both in their temples and private houses, and burn long slender candles formed by covering the ends of sticks with its sawdust mixed with rice-paste.

As sandal-wood has been famed in the East from very early times, it is more likely than any other to have attracted the notice of, and been desired by, more northern nations. We do not,

however, trace it by its present or any similar name at a very early period in the writings of



[*Santalum album*.]

Greek authors: it may, however, have been confounded with agila-wood, or agalocholum, which, like it, is a fragrant wood and used as incense. Sandal-wood is mentioned in early Sanscrit works, and also in those of the Arabs. Actuarius is the earliest Greek author that expressly notices it, but he does so as if it had been familiarly known. In the *Periplus of Arrian* it is mentioned as one of the articles of commerce obtainable at Omana, in Gedrosia, by the name *Ἐύλα Σαγάλινα*, which Dr. Vincent remarks may easily have been corrupted from *Σανδάλινα*. As it was produced on the Malabar coast, it could easily be obtained by the merchants who conveyed the cinnamon of Ceylon and other Indian products to the Mediterranean. That sandal-wood has often been employed in buildings is evident from J. Barb, 'Viaggio alla Persia: 'La porta della camera ora de sandali entarsiata con file d'oro,' &c. The Hindoo temple of Sommat, in Guzarat, which was plundered and destroyed by Mahomed of Ghizni, had gates made of sandal-wood. These were carried off by the conqueror, and afterwards formed the gates of his tomb, whence, after 800 years, they were taken by the British conquerors of Ghizni, and brought back to India in 1842.

That sandal-wood, therefore, might have attained celebrity, even in very early ages, is not at all unlikely; that it should have attracted the notice of Phœnician merchants visiting the west coast of India is highly probable; and also that they should have thought it worthy of being taken as a part of their cargo on their return from Ophir. That it is well calculated for musical instruments, the author is happy to adduce the opinion of Professor Wheatstone, who says, 'I know no reason why sandal-wood should not have been employed in ancient days for constructing musical instruments. It is not so employed at present, because there are many much cheaper woods which present a far handsomer appearance. Musical instruments would appear very unfinished to modern taste unless varnished or French-polished, and it would be worse than useless to treat fragrant woods in this way. Formerly perhaps it might have been

more the fashion to delight the senses of smell and hearing simultaneously than it is with us, in which case odoriferous woods would be preferred for things so much handled as musical instruments are.—J. F. R.

ALISGEMA (*Ἀλισγημα*), a Hellenistic word, which occurs in Acts xv. 20 (comp. ver. 29 and I Cor. viii.), with reference to meat sacrificed to idols, and there means *defilement, pollution*. The Apostle in these passages alludes to the customs of the Gentiles, among whom—after a sacrifice had been concluded and a portion of the victim had been assigned to the priests—it was usual to hold a sacrificial feast in honour of the god, on which occasion they ate the residue of the flesh. This feast might take place either in the temple or in a private house. But there were many who, from need or avarice, salted and laid up the remnants for future use (Theoph. Char. c. x.), or even gave them to the butchers to sell in the shambles (Shoettg. *Hör. Heb. ad Act.* xv. 20; I Cor. viii.). This flesh, having been offered to idols, was held in abomination by the Jews; and they considered not only those who had been present at these feasts, but also those who ate the flesh which had been offered up, when afterwards exposed for sale in the shambles, as infected by the contagion of idolatry. The council at Jerusalem, therefore, at the suggestion of St. James, directed that converts should refuse all invitations to such feasts, and abstain from the use of all such meat, that no offence might be given to those Christians who had been Jews. See more largely Kuinoel, *ad Act.* xv. 20.

ALLEGORY (*Ἀλληγορία*). This word is found in the Authorized Version of Gal. iv. 21, but it does not actually exist as a noun in the Greek Testament, nor even in the Septuagint. In the passage in question Saint Paul cites the history of the free-born Isaac and the slave-born Ishmael, and in proceeding to apply it spiritually says, *ἀτινά ἐστιν ἀλληγορούμενα*, which does not mean, as in the A.V., 'which things are an allegory,' but 'which things are allegorized.' This is of some importance; for in the one case the Apostle is made to declare a portion of Old Testament history an allegory, whereas in truth he only speaks of it as allegorically applied. *Allegories* themselves are, however, of frequent occurrence in Scripture, although that name is not there applied to them.

An ALLEGORY has been sometimes considered as only a lengthened *metaphor*; at other times, as a *continuation of metaphors*. But the nature of allegory itself, and the character of allegorical interpretation, will be best understood by attending to the origin of the term which denotes it. Now the term 'Allegory,' according to its original and proper meaning, denotes a representation of one thing which is intended to excite the representation of another thing. Every allegory must therefore be subjected to a *twofold* examination: we must first examine the *immediate representation*, and then consider what *other representation* it is intended to excite. In most allegories the immediate representation is made in the form of a narrative; and, since it is the object of the allegory itself to convey a moral, not an historic truth, the narrative itself is commonly fictitious. The *immediate* representation is of no further value than as it leads to the *ultimate*

representation. It is the application or the moral of the allegory which constitutes its worth.

Since, then, an allegory comprehends two distinct representations, the interpretation of an allegory must comprehend two distinct operations. The first of them relates to the immediate representation, and the second to the ultimate representation. The immediate representation is understood from the words of the allegory; the ultimate representation depends upon the immediate representation applied to the proper end. In the interpretation, therefore, of the former, we are concerned with the interpretation of *words*; in the interpretation of the latter, we are concerned with the *things signified* by the words. Now, whenever we speak of allegorical interpretation, we have always in view the ultimate representation, and, consequently, are then concerned with the interpretation of things. The interpretation of the words, which attaches only to the immediate representation, or the plain narrative itself, is commonly called the *grammatical* or the *literal* interpretation; although we should speak more correctly in calling it the *verbal* interpretation, since even in the plainest narratives, even in narratives not designed for moral application, the use of words is never restricted to their mere *literal* senses. Custom, however, having sanctioned the use of the term 'literal,' instead of the term 'verbal' interpretation, to mark the opposition to allegorical interpretation, we must understand it accordingly. But whatever be the term, whether verbal or literal, which we employ to express the interpretation of the words, it must always be borne in mind that the allegorical interpretation is the interpretation of things—of the things signified by the words, not of the words themselves.

Bishop Marsh, from the fifth of whose *Lectures on the Criticism and Interpretation of the Bible*, these principles are derived, proceeds, in that Lecture, to apply them to a few of the Scriptural examples. Every parable is a kind of allegory; and therefore the parable of the sower (Luke viii. 5-15), being especially clear and correct, is taken as the first example. In this we have a plain narrative, a statement of a few simple and intelligible facts, such, probably, as had fallen within the observation of the persons to whom our Saviour addressed himself. When he had finished the narrative, or the immediate representation of the allegory, he then gave the explanation or ultimate representation of it; that is, he gave the allegorical interpretation of it. And that the interpretation was an interpretation, not of the words, but of the things signified by the words, is evident from the explanation itself: 'The seed is the word of God; those by the wayside are they that hear,' &c. (v. 11, &c.) The impressive and pathetic allegory addressed by Nathan to David affords a similar instance of an allegorical narrative accompanied with its explanation (2 Sam. xii. 1-14). Allegories thus accompanied, constitute a kind of simile, in both parts of which the words themselves are construed either literally or figuratively, according to the respective use of them; and then we institute the comparison between the things signified in the former part, and the things signified in the latter part.

But allegorical narratives are frequently left to explain themselves, especially when the resem-

blance between the immediate and ultimate representation is sufficiently apparent to make an explanation unnecessary. Of this kind we cannot have a more striking example than that beautiful one contained in the 80th Psalm: 'Thou broughtest a vine out of Egypt,' &c.

The use of allegorical interpretation is not, however, confined to mere allegory, or fictitious narratives, but is extended also to history, or real narratives. And in this case the grammatical meaning of a passage is called its *historical* meaning, in contradistinction to its *allegorical* meaning. There are two different modes in which Scripture history has been thus allegorized. According to one mode, facts and circumstances, especially those recorded in the Old Testament, have been applied to other facts and circumstances, of which they have been described as *representative*. According to the other mode, these facts and circumstances have been described as mere *emblems*. The former mode is warranted by the practice of the sacred writers themselves; for when facts and circumstances are so applied, they are applied as *types* of those things to which the application is made. But the latter mode of allegorical interpretation has no such authority in its favour, though attempts have been made to procure such authority. For the same things are there described not as types or as real facts, but as mere *ideal* representations, like the immediate representations in allegory. By this mode, therefore, history is not *treated* as allegory, but *converted* into allegory. That this mode of interpretation cannot claim the sanction of St. Paul, from his treatment of the history of Isaac and Ishmael, has already been shown: the consideration, however, of the allegorical modes of dealing with the real histories of Scripture is a different subject from that of allegories and their interpretation, and belongs to another place [INTERPRETATION, BIBLICAL].

ALLELUIA. [HALLELUJAH.]

ALLIANCES. From a dread lest the example of foreign nations should draw the Israelites into the worship of idols, they were made a peculiar and separate people, and intercourse and alliance with such nations were strongly interdicted (Lev. xviii. 3, 4; xx. 22, 23). The tendency to idolatry was in those times so strong, that the safety of the Israelites lay in the most complete isolation that could be realized; and it was to assist this object that a country more than usually separated from others by its natural boundaries was assigned to them. It was shut in by the sea on the west, by deserts on the south and east, and by mountains and forests on the north. Among a people so situated we should not expect to hear much of alliances with other nations.

By far the most remarkable alliance in the political history of the Hebrews is that between Solomon and Hiram king of Tyre. It is in a great degree connected with considerations which belong to another head [COMMERCE]. But it may primarily be referred to a partial change of feeling which originated in the time of David, and which continued to operate among his descendants. During his wanderings he was brought into contact with several of the neighbouring princes, from some of whom he received sympathy and support, which, after he ascended the throne, he gratefully remembered (2 Sam. x. 2). There was probably

more of this friendly intercourse than the Scripture has had occasion to record. Such timely aid, combined with the respect which his subsequently victorious career drew from foreign nations, must have gone far to modify in him and those about him that aversion to strangers which the Hebrews generally had been led to entertain. He married the daughter of a heathen king, and had by her his favourite son (2 Sam. iii. 3); the king of Moab protected his family (1 Sam. xxii. 3, 4); the king of Ammon showed kindness to him (2 Sam. x. 2); the king of Gath showered favours upon him (1 Sam. xxvii.; xxviii. 1, 2); the king of Hamath sent his own son to congratulate him on his victories (2 Sam. viii. 15); in short, the rare power which David possessed of attaching to himself the good opinion and favour of other men, extended even to the neighbouring nations, and it would have been difficult for a person of his disposition to repel the advances of kindness and consideration which they made. Among those who made such advances was Hiram, king of Tyre; for it eventually transpires that 'Hiram was ever a lover of David' (1 Kings v. 2); and it is probable that other intercourse had preceded that relating to the palace which Hiram's artificers built for David (2 Sam. v. 11). The king of Tyre was not disposed to neglect the cultivation of the friendly intercourse with the Hebrew nation which had thus been opened. He sent an embassy to condole with Solomon on the death of his father, and to congratulate him on his accession (1 Kings v. 1). The plans of the young king rendered the friendship of Hiram a matter of importance, and accordingly 'a league' was formed (1 Kings v. 12) between them: and that this league had a reference not merely to the special matter then in view, but was a general league of amity, is evinced by the fact that more than 250 years after, a prophet denounces the Lord's vengeance upon Tyre, because she 'remembered not the brotherly covenant' (Amos i. 9). Under this league large bodies of Jews and Phœnicians were associated, first in preparing the materials for the Temple (1 Kings v. 6-18), and afterwards in navigating the Red Sea and the Indian Ocean (1 Kings ix. 26-28): and this increasing intercourse with the heathen appears to have considerably weakened the sentiment of separation, which, in the case of the Hebrews, it was of the utmost importance to maintain. The disastrous consequences of even the seemingly least objectionable alliances may be seen in the long train of evils, both to the kingdom of Israel and of Judah, which ensued from the marriage of Ahab with Jezebel, the king of Tyre's daughter [ARAB; JEZEBEL]. These consequences had been manifested even in the time of Solomon; for he formed matrimonial alliances with most of the neighbouring kingdoms, and to the influence of his idolatrous wives are ascribed the abominations which darkened the latter days of the wise king (1 Kings xi. 1-8).

The prophets, who were alive to these consequences, often raised their voices against such dangerous connections (1 Kings xx. 38; 2 Chron. xvi. 7; xix. 2; xxv. 7, &c.; Isa. vii. 17): but it was found a difficult matter to induce even the best kings to place such absolute faith in Jehovah, the Head of their state, as to neglect altogether those human resources and alliances by which other nations strengthened themselves against their

enemies. The Jewish history, after Solomon, affords examples of several treaties with different kings of Syria, and with the kings of Assyria and Babylon. Asa, one of the most pious monarchs that ever sat on the throne of Judah, finding his kingdom menaced and his frontier invaded, sent to Benhadad, who reigned in Damascus, the most costly presents, reminding him of the league which had long subsisted between them and their fathers, and conjuring him not to succour the enemies of Judah, nor renounce the obligations of their old alliance (1 Kings xv. 16-20). Attacked by another king of Israel, whom another king of Damascus protected, Ahaz implored the king of Assyria for aid, and with the treasures of the temple and the palace purchased a defensive alliance (2 Kings xvi. 5, &c.; 2 Chron. xviii. 16, &c.). In later times, the Maccabees appear to have considered themselves unrestrained by any but the ordinary prudential considerations in contracting alliances; but they confined their alliances to distant states, which were by no means likely ever to exercise that influence upon the religion of the people which was the chief object of dread. The most remarkable alliances of this kind in the whole Hebrew history are those which were contracted with the Romans, who were then beginning to take a part in the affairs of Western Asia. Judas claimed their friendly intervention in a negotiation then pending between the Jews and Antiochus Eupator (2 Macc. xi. 31, *sq.*); and two years after he sent ambassadors to the banks of the Tiber to propose a treaty of alliance and amity. By the terms of this treaty the Romans ostensibly threw over the Jews the broad shield of their dangerous protection, promising to assist them in their wars, and forbidding any who were at peace with themselves to be at war with the Jews, or to assist directly or indirectly those who were so. The Jews, on their part, engaged to assist the Romans to the utmost of their power in any wars they might wage in those parts. The obligations of this treaty might be enlarged or diminished by the mutual consent of the contracting parties. This memorable treaty, having been concluded at Rome, was graven upon brass and deposited in the Capitol (1 Macc. viii. 22-28; Josephus, *Antiq.* xii. 10: other treaties with the Romans are given in lib. xiii.).

Anterior to the Mosaic institutions, such alliances with foreigners were permitted, or at least tolerated. Abraham was in alliance with some of the Canaanitish princes (Gen. xiv. 13); he also entered into a regular treaty of alliance, being the first on record, with the Philistine king Abimelech (ch. xxi. 22, *sq.*), which was renewed by their sons (ch. xxvi. 26-30). This primitive treaty is a model of its kind: instead of minute stipulations, it leaves all details to the honest interpretation of the contracting parties. Abimelech says: 'Swear unto me here by God that thou wilt not deal falsely with me, nor with my son, nor with my son's son; but according to the kindness that I have done unto thee, thou shalt do unto me, and unto the land wherein thou hast sojourned.' Even after the law, it appears, from some of the instances already adduced, that such alliances with distant nations as could not be supposed to have any dangerous effect upon the religion or morals of the people, were not deemed to be interdicted. The treaty with the Gibeonites is a re-

markable proof of this. Believing that the ambassadors came from a great distance, Joshua and the elders readily entered into an alliance with them; and are condemned for it only on the ground that the Gibeonites were in fact their near neighbours (Josh. ix. 3-27).

From the time of the patriarchs, a covenant of alliance was sealed by the blood of some victim. A heifer, a goat, a ram, a turtle dove, and a young pigeon, were immolated in confirmation of the covenant between the Lord and Abraham (Gen. xv. 9). The animal or animals sacrificed were cut in two (except birds, ver. 10), to typify the doom of perjurers. This usage often recurs in the prophets, and there are allusions to it in the New Testament (Jer. xxxiv. 18; Dan. xiii. 55; Matt. xxiv. 51; Luke xii. 46). The perpetuity of covenants of alliance thus contracted is expressed by calling them 'covenants of salt' (Num. xviii. 19; 2 Chron. xiii. 5), salt being the symbol of incorruption. The case of the Gibeonites affords an exemplary instance, scarcely equalled in the annals of any nation, of scrupulous adherence to such engagements. The Israelites had been absolutely cheated into the alliance; but, having been confirmed by oaths, it was deemed to be inviolable (Josh. ix. 19). Long afterwards, the treaty having been violated by Saul, the whole nation was punished for the crime by a horrible famine in the time of David (2 Sam. xxi. 1, *sqq.*). The prophet Ezekiel (xvii. 13-16) pours terrible denunciations upon king Zedekiah, for acting contrary to his sworn covenant with the king of Babylon. In this respect the Jews were certainly most favourably distinguished among the ancient nations; and, from numerous intimations in Josephus, it appears that their character for fidelity to their engagements was so generally recognised after the Captivity, as often to procure for them highly favourable consideration from the rulers of Western Asia and of Egypt.

ALLON (אֵלֹן; Sept. *Bálavos*; Vulg. *Quercus*; Auth. Vers. OAK). The Hebrew word, thus pointed, as it occurs in Gen. xxxv. 8; Josh. xix. 32; Isa. ii. 13; vi. 13; xlv. 14; Hos. iv. 13; Amos ii. 9; Zech. xi. 2, was understood by the ancient translators, and has been supposed by most interpreters, to denote the oak, and there is no reason to disturb this conclusion. In our version other words are also rendered by 'oak,' particularly *Alah* (אֵלֶה), which more probably denotes the terebinth-tree [אַלְמִי]. The oak is, in fact, less frequently mentioned in the original than in the A. V., where it occurs so often as to suggest that the oak is as conspicuous and as common in Palestine as in this country. But in Syria oaks are by no means common, except in hilly regions, where the elevation gives the effect of a more northern climate; and even in such circumstances it does not attain the grandeur in which it often appears in our latitudes. Indeed, Syria has not the species (*Quercus robur*) which forms the glory of our own forests. The 'oaks of Bashan' are in Scripture mentioned with peculiar distinction (Isa. ii. 3; Ezek. xxvii. 6; Zech. xi. 2), as if in the hills beyond the Jordan the oaks had been more abundant and of larger growth than elsewhere. This is the case even at the present day. In the hilly regions of Bashan and Gilead, Burckhardt repeatedly mentions forests of thick oaks—thicker than any

forests he had seen in Syria. He speaks gratefully of the shade thus afforded; and doubtless it was the presence of oaks which imparted to the scenery that European character which he notices (*Syria*, 265, 348). On that side of the river a thick oak-forest occurs as far south as the vicinity of Amman, the capital of the Ammonites (p. 356). Oaks of low stature are frequent in the hills and plains near the sources of the Jordan (pp. 45, 312, 315); and some of large dimensions are found in different parts of the country, beside the natural reservoirs of water fed by springs (pp. 193, 315). On



[Branch of *Quercus Ægilops*.]

the lower slopes of Lebanon low oak-trees are numerous, and the inhabitants employ their branches in the construction of the flat roofs of their dwellings (pp. 4, 7, 18, 193, 312, &c.). Next to Burckhardt, Lord Lindsay is the traveller who makes the most frequent mention of oaks in Palestine. He confirms their existing abundance in the countries of Bashan and Gilead. He calls them 'noble prickly oaks,' and 'evergreen oaks,' and notices a variety of the latter with a broader leaf than usual (*Travels*, ii. 122, 124, 127).

But oak-trees are by no means wanting on the west of the Jordan, in the proper Land of Canaan. Lord Lindsay describes the hills of southern Judæa about Hebron as covered to the top with low shrubs of the prickly oak. Fine park scenery, composed chiefly of prickly and evergreen oaks, occurs between Samaria and Mount Carmel. The same trees abound on the southern prolongations of that mountain, and on the banks of the Kishon. The thick woods which cover Mount Tabor are composed chiefly of oaks and pistachio-trees; and oaks are found in the valleys which trend from that mountain (Lindsay, ii. 51, 77, 85). Hasselquist found groves of the Kermes oak (*Q. coccifera*) in the valleys beyond the plain of Acre, on the road to Nazareth (*Travels*, p. 153).

From the above and other notices we collect that the species of oak found in Palestine, and probably all comprehended under the word *ALLON*, are—1. The Evergreen Oak (*Quercus ilex*), which is met with not only in Western Asia, but in Northern Africa and Southern Europe. This is a tall but not wide-spreading tree; and the timber,

being very hard, is much used for purposes in which compactness and durability are required. 2. The Holly-leaved Montpellier Oak (*Q. græmuntia*), another evergreen, which may be inserted on the authority of Pococke. This tree also, as its name imports, is a native of Southern Europe, and is markedly distinguished from the former by its numerous straggling branches and the thick underdown of its leaves. 3. The Hairy-cupped Oak (*Q. crinata*), so called from the bristly appearance of the calyx. It grows to a considerable size, and furnishes an excellent timber, much used by the Turks in the building of ships and houses. But although this species exists in Syria, it is much more common in Asia Minor. 4. The Great Prickly-cupped Oak (*Q. Ægilops* or *Valonia*), which takes its name from its large prickly calyx. This species is common in the Levant, where it is a handsome tree, which it is not in our ungenial climate, though it has long been cultivated. The wood of this species is of little worth; but its acorns form the valonia of commerce, of which 150,000 cwt. are yearly imported into this country for the use of tanners. 5. The Kermes Oak (*Q. coccifera*) takes its name from an insect (*kermes*, of the genus *coccus*) which adheres to the branches of this bushy evergreen shrub, in the form of small reddish balls about the size of a pea. This affords a crimson dye, formerly celebrated, but now superseded by cochineal. This dye was used by the ancient Hebrews; for the word תולת, which denotes a worm, and particularly the kermes worm, denotes also the dye prepared from it (Isa. i. 18; Lam. iv. 5), and is accordingly rendered κόκκινον in those passages where it occurs.

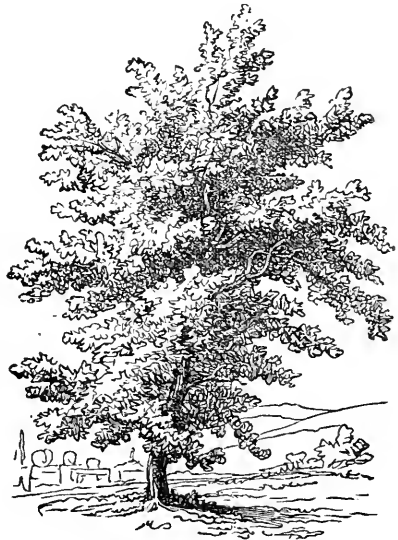

[*Quercus Ægilops* or *Valonia*.]

From the hints of travellers there appear to be some other species of oaks in Palestine, but their information is not sufficiently distinct to enable us to identify them.

ALLON-BACHUTH (the oak of weeping), a

place in Bethel, where Rebekah's nurse was buried (Gen. xxxv. 8).

ALMON (אַלְמוֹן; Sept. Ἀλμών, *v. r.* Γάμαλα), one of the three cities which belonged to the priests in the tribe of Benjamin (Josh. xxi. 18). It is supposed to be the same as the Alemeth of 1 Chron. vi. 60. Jarchi and Kimchi identify it with Baharim, which name the Targum (2 Sam. iii. 16) renders by Almeth—both words signifying 'youth.' The site is unknown.

ALMON-DIBLATHAIM, one of the stations of the Israelites on their way from Mount Hor to the plains of Moab, round by Mount Seir (Num. xxxiii. 46).

ALMOND-TREE. [Luz.]

ALMS (ἐλεημοσύνη). The English word is an abridged form of the Greek, brought down in several successive corruptions, still to be found in the Anglo-Saxon and early English dialects: thus the Saxon translation of the original term is (Matt. vi. 4) *ælmessan*; Luther's, *almosen*; Wiclif's, *almesse*; Crammer's, *almose*; Tyndale's, *almes*. The Greek word is derived from ἔλεος, pity or mercy; and hence comes to denote our manifestation of pity, namely, benefactions to the needy—'an almese-deede,' as it is translated in the Rheims version of the New Testament. The primary meaning of 'alms' does not, as is the case in its Greek original, appear on the face of the word, and the derivative signification only remains in the English term; so that a word which properly signified merciful feelings and merciful actions towards the indigent has, in process of time, been restricted to one particular kind of charitable deeds, denoting now scarcely anything more than giving money to beggars. This departure from the etymological meaning of the original word should be carefully borne in mind by those who undertake to expound such passages of Scripture as bear on the subject.

The regulations of the Mosaic law respecting property, and its benign spirit towards the poor, went far to prevent the existence of penury as a permanent condition in society, and, consequently, by precluding beggary, to render the need of almsgiving unnecessary. Poverty, however, considered as a state of comparative want, Moses seems to have contemplated as a probable event in the social frame which he had established; and accordingly, by the appointment of specific regulations, and the enjoining of a general spirit of tender-heartedness, he sought to prevent destitution and its evil consequences. The law which he promulgated in this matter is found in Lev. xxv. 35: 'And if thy brother be waxen poor, and fallen into decay with thee, then shalt thou relieve him.' The benignity and largeness of spirit of the legislator appear in the concluding words—'Yea, though he be a stranger or a sojourner, that he may live with thee.' The whole of the chapter may be advantageously consulted. The consideration by which this merciful enactment is recommended has peculiar force, 'I am the Lord your God, which brought you forth out of the land of Egypt to give you the land of Canaan, and to be your God.' The spirit of the Hebrew legislator on this point is forcibly exhibited in Deut. xv. 7 *et seq.*: 'If there be among you a poor man . . . thou shalt open thine hand wide unto him. . . . Beware that thine eye

be not evil against thy poor brother, and thou givest him nought; and he cry unto the Lord against thee, and it be sin unto thee. Thou shalt surely give him, and thine heart shall not be grieved when thou givest unto him: because that for this the Lord thy God shall bless thee in all thy works.' The great antiquity of the practice of benevolence towards the poor is shown in the very beautiful passage which is found in Job xxix. 13 *et seq.* The phrase, 'father to the poor,' there given to the venerable patriarch, involves higher praise even than Cicero's 'pater patriæ.' How high the esteem was in which this virtue continued to be held in the time of the Hebrew monarchy may be learnt from Psalm xli. 1—'Blessed is he that considereth the poor; the Lord will remember him in time of trouble.' See also Psalm cxii. 9; Prov. xiv. 31. The progress of social corruption, however, led to the oppression of the poor, which the prophets, after their manner, faithfully reprobated (Isaiah lviii. 3): where, among other neglected duties, the Israelites are required to deal their bread to the hungry, and to bring the outcast poor to their house. See also Isaiah x. 2; Amos ii. 7; Jer. v. 28; Ezek. xxii. 29.

However favourable to the poor the Mosaic institutions were, they do not appear to have wholly prevented beggary; for the imprecation found in Psalm cix. 10, 'Let his children be vagabonds and beg,' implies the existence of beggary as a known social condition. Begging naturally led to almsgiving, though the language of the Bible does not present us with a term for 'alms' till the period of the Babylonish captivity, during the calamities attendant on which the need probably introduced the practice. צְדָקָה corresponds with the Greek ἐλεημοσύνη, signifying originally that which is right, just,—and thence, derivatively, mercy and merciful deeds; and affords an interesting illustration of the gentle spirit of the Mosaic religion, since the ideas of justice and mercy are represented as springing from the same radical conception. In Psalm cxlv. 7, occurs, perhaps, the earliest passage in which the word clearly signifies love or mercy. 'They shall abundantly utter the memory of thy great goodness, and shall sing of thy righteousness;' where the parallelism shows that by צְדָקָה 'mercy' is intended. In Daniel, however, iv. 27, we find the word actually rendered ἐλεημοσύνη in the Septuagint—though 'righteousness' is retained in our version. The ensuing member of the sentence puts the meaning beyond a question—'O king, break off thy sins by righteousness and thine iniquities by showing mercy to the poor, if it may be a lengthening of thy tranquillity.' A new idea is here presented, namely, that of merit and purchase, which is found more forcibly expressed in the Greek version ἁμαρτίας σου ἐν ἐλεημοσύναις λύτρωσαι. Almsgiving had come to be regarded as a means of conciliating God's favour and of warding off evil. At a still later period this idea took a firm seat in the national mind, and alms-deeds were regarded as a mark of distinguished virtue (Tobit ii. 15; iv. 11). That begging was customary in the time of the Saviour is clear from Mark x. 46, 'Blind Bartimeus sat by the wayside begging;' and Acts iii. 2, 'A lame man was laid daily at the gate of the temple, called Beautiful, to ask alms.' Comp. verse 10. And that it was usual for

the worshippers, as they entered the temple, to give relief, appears from the context, and particularly from the fine answer to the lame man's entreaty, made by the apostle Peter. The general spirit of Christianity, in regard to succouring the needy, is nowhere better seen than in 1 John iii. 17:—

Whoso hath this world's good, and seeth his brother have need, and shutteth up his bowels from him, how dwelleth the love of God in him? With the faithful and conscientious observance of the 'royal law' of love, particular manifestations of mercy to the poor seem to be left by Christianity to be determined by time, place, and circumstances; and it cannot be supposed that a religion, one of whose principles is 'that, if any would not work, neither should he eat' (2 Thess. iii. 10), can give any sanction to indiscriminate almsgiving, or intend to encourage the crowd of wandering, idle beggars with which some parts of the world are still infested. The emphatic language employed by the Lord Jesus Christ and others (Luke iii. 11; vi. 30; xi. 41; xii. 33; Matt. vi. 1; Acts ix. 37; x. 2, 4) is designed to enforce the general duty of a merciful and practical regard to the distresses of the indigent—a duty which all history shows men have been lamentably prone to neglect; while the absence of ostentation and even secrecy, which the Saviour enjoined in connection with almsgiving, was intended to correct actual abuses, and bring the practice into harmony with the spirit of the Gospel. In the inimitable reflections of Jesus on the widow's mite (Mark xii. 42) is found a principle of great value, to the effect that the magnitude of men's offerings to God is to be measured by the disposition of mind whence they proceed; a principle which cuts up by the very roots the idea that merit attaches itself to almsgiving as such, and increases in proportion to the number and costliness of our alms-deeds.

One of the earliest effects of the working of Christianity in the hearts of its professors was the care which it led them to take of the poor and indigent in the 'household of faith.' Neglected and despised by the world, cut off from its sympathies, and denied any succour it might have given, the members of the early churches were careful not only to make provision in each case for its own poor, but to contribute to the necessities of other though distant communities (Acts xi. 29; xxiv. 17; 2 Cor. ix. 12). This commendable practice seems to have had its Christian origin in the deeply interesting fact (which appears from John xiii. 29) that the Saviour and his attendants were wont, notwithstanding their own comparative poverty, to contribute out of their small resources something for the relief of the needy.—

J. R. B.

ALOE. [AHALIM].

ALPHA (A), the first letter of the Greek alphabet, corresponding to the Hebrew א, *Aleph*. Both the Hebrews and the Greeks employed the letters of their alphabets as numerals, and A (*Alpha* or *Aleph*) therefore denoted *one* or *the first*. Hence our Lord says of himself, that he is (α Α) *Alpha* and (ω Ω) *Omega*, i. e. the first and the last, the beginning and the ending, as he himself explains it (Rev. i. 8, 11; xxi. 6; xxii. 13).

ALPHABET. The origin of alphabetical writing belongs to a period long antecedent to the

date of any historical testimonies, or ancient monuments, which have come down to us. This want of documentary evidence, however, has left a wider field for conjecture; and a mistaken and sometimes disingenuous zeal for the honour of the Scriptures has not only led many learned men to ascribe the invention of letters to Adam, Seth, Enoch, and Noah, but to produce copies of the very alphabets they employed. Several such alphabets, derived chiefly from Bonaventura, Hepburn, Roccha, and Athanasius Kircher, may be seen in Bangii *Cælum Orientis* (or, according to the new title which was subsequently prefixed to it, *Exercitationes de Ortu et Progressu Litterarum*), Hafnia, 1657, p. 99, sqq. Our own time also has produced an attempt to prove, from the astrological character of the Hebrew alphabet—i. e. from its representing the relations of the zodiac and seven planets—that it was discovered, probably by Noah, on the 7th Sept. B.C. 3446 (Seyffart's *Unser Alphabet ein Abbild des Thierkreises*, Leips. 1834).

The earliest and surest data, however, on which any sound speculation on this subject can be based, are found in the genuine palæographical monuments of the Phœnicians; in the manifest derivation of all other Syro-Arabian and almost all European characters from that type, and in the testimony which history bears to the use and transmission of alphabetical writing.

The true principles of comparative Syro-Arabian palæography are a discovery of almost modern date. Bochart, Bernard, and others, in their early attempts, did not even possess the Phœnician alphabet at all, but only the *Samaritan* of printed books or of the Hasmonæan coins; for Rhenferd was the first that produced the genuine alphabet, in 1705. Besides, there was a very general prejudice that our present square Hebrew character was the primitive type (a list of some of the champions of which opinion is given in Carpvov's *Crit. Sæc.* p. 227); and the want of documents long concurred with that notion in hindering any important effort in the right direction. It was reserved for Kopp to make (in his *Bilder und Schriften der Vorzeit*, Mannheim, 1819) the first systematic representation of the genealogy of ancient Syro-Arabian alphabets. The latter portion of his second volume contains elaborate tabular views of the characters of a wide ethnographical circle, arranged according to their proximity to the parent type; and, by the breadth of his comparison, as well as by his deductions from the laws affecting the art of writing, he first succeeded in establishing a number of new and unexpected truths, which have had a permanent influence on all subsequent inquiries. Lastly, Gesenius, who possesses infinite philological advantages over Kopp, and who has also long devoted a more exclusive attention to Phœnician remains, has recently given accurate copies of the complete collection of them ever published, and has illustrated the characters and the language of the monuments themselves, and the general subject of palæography, with great learning and acumen: *Scripturæ Linguaeque Phœnicæ Monumenta*, P. III., Lips. 1837—to which this article has many obligations.

Seventy-seven inscriptions and numerous coins—found chiefly at Tyre and Sidon, at Malta and Cyprus, in Sicily, the north of Africa, and on the



ALPHABETS

NAME	PHENICIAN	HEBREW on Coins	SAMARITAN	ARAMAIC on Egyptian Monuments	PALMYRENE	SQUARE HEBREW	RABBINIC	SYRIAC PESHITO
Aleph	𐤀 𐤁	א	𐤀	𐤀 𐤁	𐤀 𐤁	א	א	ܐ
Beth	𐤂 𐤃	ב	𐤂	ב	𐤂	ב	ב	ܒ
Gimel	𐤄 𐤅	ג	𐤄	ג	𐤄	ג	ג	ܓ
Daloth	𐤆 𐤇	ד	𐤆	ד	𐤆	ד	ד	ܕ
He	𐤈	ה	𐤈	ה	𐤈	ה	ה	ܗ
Waw	𐤉 𐤊	ו	𐤉	ו	𐤉	ו	ו	ܘ
Sajin	𐤋	ז	𐤋	ז	𐤋	ז	ז	ܙ
Cheth	𐤌 𐤍	ח	𐤌	ח	𐤌	ח	ח	ܚ
Teth	𐤎	ט	𐤎	ט	𐤎	ט	ט	ܛ
Jod	𐤏 𐤐	י	𐤏	י	𐤏	י	י	ܝ
Caph	𐤑 𐤒 𐤓	כ	𐤑	כ	𐤑 𐤒	כ	כ Final 𐤑	ܟ Final 𐤑
Lamed	𐤔 𐤕 𐤖	ל	𐤔	ל	𐤔	ל	ל	ܠ
Mem	𐤗 𐤘 𐤙	מ	𐤗	מ	𐤗	מ	מ Final 𐤗	ܡ Final 𐤗
Nun	𐤚 𐤛	נ	𐤚	נ	𐤚	נ	נ Final 𐤚	ܢ Final 𐤚
Samech	𐤜 𐤝	ס	𐤜	ס	𐤜 𐤝	ס	ס	ܣ
Ajin	𐤞 𐤟	ע	𐤞	ע	𐤞	ע	ע	ܥ
Phe	𐤠	פ	𐤠	פ	𐤠 𐤡	פ	פ Final 𐤠	ܦ Final 𐤠
Zade	𐤢 𐤣	צ	𐤢	צ	𐤢	צ	צ Final 𐤢	ܘ Final 𐤢
Zoph	𐤤 𐤥	ק	𐤤	ק	𐤤	ק	ק	ܩ
Resch	𐤦 𐤧	ר	𐤦	ר	𐤦 𐤧	ר	ר	ܪ
Sin		ש				ש		
Schin	𐤨 𐤩 𐤪	ס	𐤨	ס	𐤨	ש	ש	ܫ
Taw	𐤫 𐤬	ת	𐤫	ת	𐤫	ת	ת	ܬ

ALPHABETS.

NISCHI ARABIC		ETHIOPIIC	ARMENIAN	COPTIC
Elif	ا	Hoi U	Ա u Aip	Α α Alpha
Be	ب	Lawi Λ	Բ p Bjen	Β β Vīda
Te	ت	Haut ϑ	Գ q Kim	Γ γ Gamma
The	ث	Mai Ϟ	Դ ? Ta	Δ δ Dalda
Gjim	ج	Saut W	Ե e Jetsch	Ε ε Ei
Hha	ح	Res Z	Զ z Za	Ζ ζ Zīda
Kha	خ	Sat ρ	Է e E	Η η Hīda
Dal	د	Schaat ρ̄	Ը e Jeth	Θ θ Thīda
Dsal	ذ	Kaf ϕ	Թ θ She	Ι ι Janda
Re	ر	Beth ϖ	Խ b Ini	Κ κ Kabba
Ze	ز	Thawi ϗ	Լ l Lium	Λ λ Lanta
Sin	س	Tjawi ϗ̄	Խ lu Che	Υ υ Mi
Schin	ش	Harm ϗ̇	Ծ d Dsa	Ϩ ϩ Xi
Sad	ص	Nahas ϗ̈	Կ k Gjen	Ο ο O
Ddad	ض	Gnahas ϗ̉	Լ l Tsa	Π π Pi
Ta	ط	Alph ρ̇	Ղ z Glad	Ρ ρ Ro
Tza	ظ	Kaf ρ̈	Ճ d Dste	Σ σ Sima
Ain	ع	Chaf ρ̉	Ծ j Hi	Τ τ Dau
r-Ghain	غ	Waw ϑ̇	Կ b No	Υ υ He
Fe	ف	Am U	Շ z Sha	Ϙ ϙ Phi
Kaf	ق	Zai H	Ո n Wo	Ϝ ϝ Chi
Kef	ك	Jai H̄	Չ n Tsha	Ψ ϣ Ebsi
Lam	ل	Jaman P	Պ u Be	Ϟ ϟ O
Mim	م	Dent P̄	Պ̄ u Sa	Ϡ ϡ Fei
Nun	ن	Djent P̄̄	Պ̄̄ u Wjev	Ϣ ϣ Giangia
He	ه	Geml ϗ̇	Պ̄̄̄ u Diun	Ϥ ϥ Scīma
Wau	و	Tait M	Պ̄̄̄̄ u Re	Ϸ ϸ Scēi
Je	ي	Tschait M̄	Պ̄̄̄̄̄ e Tzo	Ϲ Ϻ Hori
		Pait ρ̇	Պ̄̄̄̄̄̄ e Ppiur	ϻ ϼ Chei
		Tzadai ρ̈	Պ̄̄̄̄̄̄̄ e Khe	Ͻ Ͽ Dei Ligatur
		Zappa ρ̉	Պ̄̄̄̄̄̄̄̄ e Apun	Ͽ α So
		Af ρ̊	Պ̄̄̄̄̄̄̄̄̄ e Fe	
		Psa ρ̋	Պ̄̄̄̄̄̄̄̄̄̄ e	

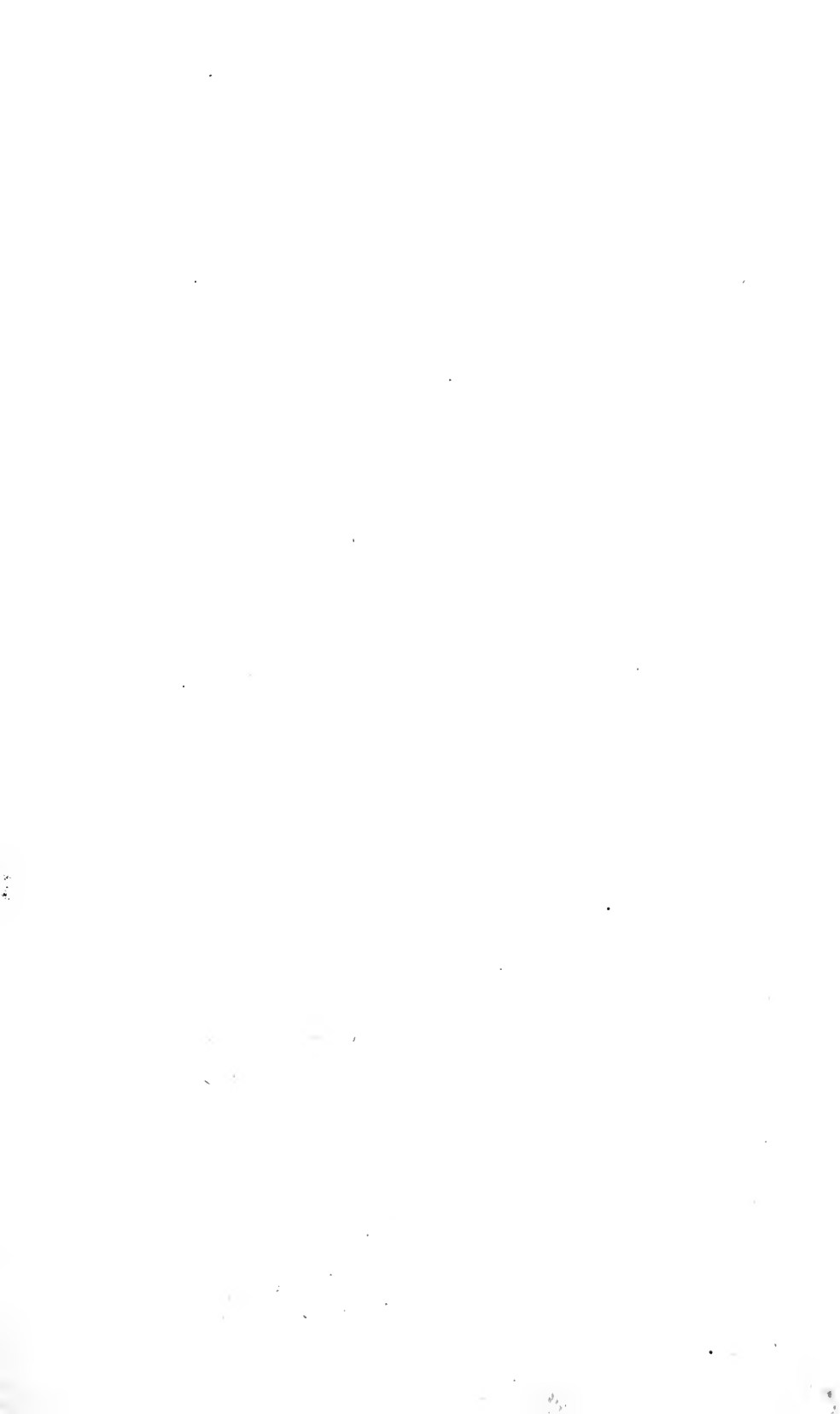

coast of Spain—have preserved to us the earliest form of that alphabet from which all others have been derived. These remains themselves belong generally to the period between Alexander the Great and the reign of Augustus; yet one is supposed to belong to the year B.C. 394, and the latest to be of the year A.D. 203. They are thus much later than the oldest Greek inscriptions; but that, nevertheless, does not affect their claim of preserving the most ancient known form of the primitive alphabet.

The characters of this alphabet, as seen on these monuments, are remarkable for their very angular and comparatively complex shape. This is an evidence of their antiquity; as this is just that feature which the tachygraphy and softer writing-materials of later times would naturally tend to obliterate. They also approach nearer to rude resemblances of the physical objects after which they are named, than those in any other Syro-Arabian alphabet, and, as another confirmation, resemble most their nearest descendant, the oldest Greek letters. This alphabet may be said to consist solely of consonants; as in it $\text{׀} \text{ׂ} \text{׃}$ do not, except under the very narrowest limitations, possess the power of denoting the place and quality of a vowel, as they do in Hebrew. The mode of writing is, to use a technical term, in every respect much more *defective* than in Hebrew, especially in the middle of a word. There are no vestiges of vowel-points nor of final letters. Words are chiefly written continuously, yet sometimes with intervals, and with a rudimental interpunction. The use of diacritical marks seems to have been known; and that of abbreviations is very frequent. The course of the writing is from right to left, and there are no traces of the alternate or *βοστροφηδόν* order. This alphabet was evidently invented, or first used, by a people speaking a Syro-Arabian language; as an alphabet consisting so exclusively of consonants is possible only in that family of language in which the vowels express merely the accidental part, the modifications and relations of the idea, and not its essence. It is, moreover, fully adequate to denote all the sounds of their speech; for it distinguishes that remarkable series of gutturals which is peculiar to the Syro-Arabians; and is able to express every sound without compound letters, to which other nations, who adapted Phœnician characters to their own native sounds, have been obliged to have recourse. The names of the twenty-two characters and the order of their arrangement can only be gathered (but then with considerable certainty) from the Hebrew and Greek alphabets. The names are evidently Syro-Arabian; and, as they appear in Hebrew, belong, as to their form, to a period anterior to the development of that language as we find it in the earliest books of the Old Testament: and, as they appear in the Greek, they have undergone modifications which (although some have considered them to betray signs of the Aramaic *status emphaticus*) are explained by Gesenius to be chiefly the effect of an influence, which is seen in other words (גבל , גבלה ; מלל , מללה) which the Greeks derived from the Phœnicians.

In tracing the derivation of all other alphabets from this type, the records of the intercourse of nations with each other and of their gradual acquisition of the arts of civilization furnish indeed an

important evidence; but the *eye*, especially when trained in the school of such observation, is alone qualified to test the truth of even historical deductions on such a subject. It is, therefore, only the attentive view of accurate plates which will enable the reader fully to understand the following genealogical table of alphabets, which is taken from Gesenius. To give it entire is, nevertheless, the shortest way of laying before the student the results of a tedious inquiry; and will, at the same time, secure the opportunity of subsequent reference, by which the treatment of the several Syro-Arabian languages, under their respective heads, may be materially facilitated.

The lines which run between the different names are intended to mark the channel, and sometimes the distinct yet convergent channels, through which any given character has been derived. Thus, to give an illustration, the square Hebrew of our printed books is shown to descend from the old Aramaean of Egypt, but to be modified by the influence of the Palmyrene.

This primitive alphabet underwent various changes in its transmission to cognate and alien nations. The former class will be incidentally noticed when treating of the Syro-Arabian languages separately. Among the latter, those modifications which were necessary to adapt it to the Greek language are the most remarkable. The ancient Greek alphabet is an immediate descendant of the Phœnician; and its letters correspond, in name, figure, and order, to those of its prototype. Even the course of the writing, from right to left, was at first observed in short inscriptions; and then half retained in the *βοστροφηδόν*. But as the characters were reversed in the alternate lines of the *βοστροφηδόν*, and the order from left to right became at length the standard one, the systematic reversal of the characters became the law. This of itself was a striking departure from the Phœnician mode of writing. A more important change was produced by the nature of the language. The Greeks found the numerous gutturals superfluous, and at the same time felt the indispensable necessity of characters to denote their vowels. Accordingly, they converted *Aleph*, *He*, *Jod*, and *Ain* into A, E, I, O. This last transmutation (which is the only surprising one) is accounted for by Gesenius, on the ground that the Phœnician *Ain* leaned so much to the O sound, that it was written in Phœnician inscriptions to express that vowel (in cases when it arose from the fusion of the sounds A and L), and that the Greeks, when writing a Phœnician word in their own way, represented it by O, as $\text{Βωλαθής} = \text{בעלתִי}$. Moreover, the LXX. appear to have felt the same influence, as Μωχά for מעכה , Gen. xxii. 24 (*Vide Gesenii Monumenta*, p. 431). *Cheth* also became the rough breathing, and subsequently was appropriated to the long E.

The two alphabets correspond as follows:

Ν	Α	Ϛ	Θ	Υ	Ο
β	Β	ϛ	Ι	Ϝ	Π
γ	Γ	κ	Κ	ϝ	—
δ	Δ	λ	Λ	ρ	Κόππα
η	Ε	μ	Μ	ρ	Ρ
ι	Ζ Βαί	ν	Ν	σ	Ξ Σαυ
ι	Ζ	δ	Σίγμα	η	Τ
η	Η				

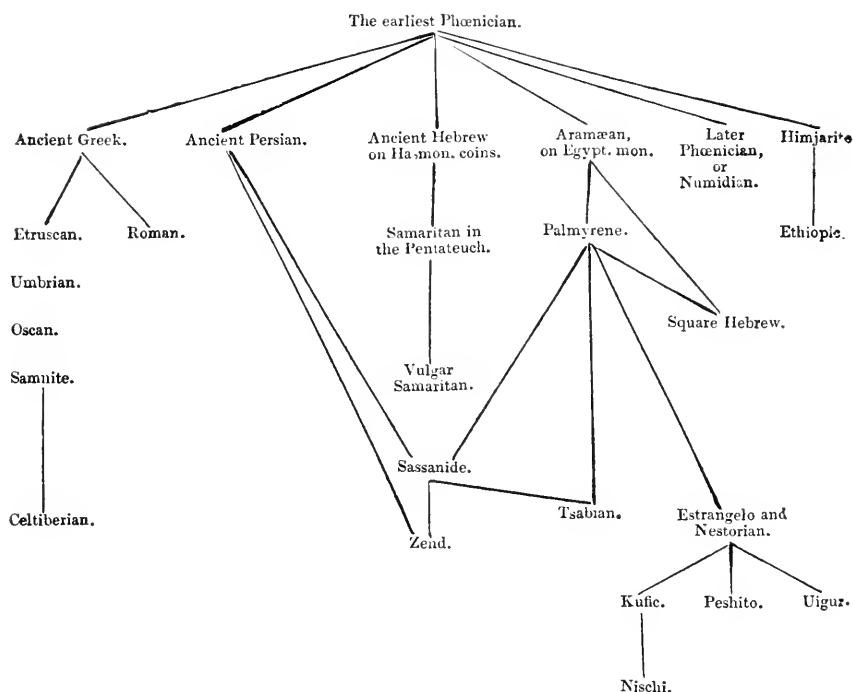

There is evidence that the Greeks received all these letters (except Tsade), because they continued to employ them as numerals, after they had ceased to use them as letters. The loss of Tsade, however, affected the numerical value of all letters below its place in the series. They subsequently rejected three letters in writing: *βαι*, the Roman F; *κόππα*, the Roman Q; and one of the sibilants. Gesenius explains the last case thus: The ancient alphabet had adopted Zeta for Zain, Sigma properly for Samech, and San for Shin. As the sound *sh* was disagreeable to the ear of the Greeks, it was dropped. Having thus no need of two characters to express their single S, the two letters gradually coalesced, and were indiscriminately called Sigma and San. But the S retained the position of the Shin, and not of the Samech; and when *Xi* was introduced, it usurped the place of the Samech. He also thinks that, in the statement of Pliny (*Hist. Nat.* vii. 56), about sixteen or eighteen Cadmean letters, the first number is decidedly too small; but finds some ground for the eighteen of Aristotle, in the facts that the Greeks rejected three, and so rarely used Z, that the actual number of current letters was reduced to that amount.

The historical testimonies respecting the use and transmission of letters disagree much as to the nation to which the discovery is to be ascribed. There are, however, only three nations which can compete for the honour—the Babylonians, the Phœnicians, and the Egyptians. Many eminent men, among whom are Kopp and Hoffmann, support the Babylonian claim to the priority of use. The chief arguments, as stated by them

(*Bilder und Schriften*, ii. 147; *Gram. Syr.* p. 61), are based on the very early civilization of Babylon; on numerous passages which attribute the discovery to the *Σύροι*, Syri, and *Χαλδαῖοι* (quoted in Hoffmann, *l. c.*); and especially on the existence of a Babylonian brick containing an inscription in characters resembling the Phœnician. To these arguments Gesenius has replied most at length in the article *Palæographie*, in Ersch and Gruber's *Allgemeine Encyclopædie*. He especially endeavours to invalidate the evidence drawn from the brick (of which Kopp possessed an inaccurate transcript, and was only able to give an unsatisfactory interpretation), and asserts that the characters are Phœnician, but by no means those of the most antique shape. He considers the language of the inscription to be Aramaic; and maintains that the only conclusion which can fairly be drawn from the existence of such an inscription there, is, that during the time of the Persian kings the Babylonians possessed a common alphabet almost entirely agreeing with the Phœnician. And, indeed, as this inscription only contains seven letters, its claim to originality is not a matter of much moment; for, in the only practical question of palæography, the Phœnician alphabet still continues to be, to us at least, the primitive one. He also objects that it is, in itself, improbable that the alphabet was invented by the Aramaeans, on the ground that, in their dialect, as far as it is known to us, *ʾ ʿ ʿ ʿ* are very weak and indistinct; whereas the existence of such letters in the primitive alphabet at all, is an evidence that they were well marked consonants, at least to the

people who felt the necessity of denoting them by separate signs.

Nearly an equal number of ancient authorities might be cited as testimonies that the discovery of letters was ascribed to the Phœnicians and to the Egyptians (see Walton's *Prolegomena*, ii. 2). And, indeed, there is a view, suggested by Gesenius (*Palæographie*, l. c.), by which their rival claims might, to a certain extent, be reconciled:—that is, by the supposition that the hieroglyphical was, indeed, the earliest kind of all writing; but that the Phœnicians, whose commerce led them to Egypt, may have borrowed the first germ of alphabetical writing from the *phonetic* hieroglyphs. There is at least a remarkable coincidence between the Syro-Arabian alphabet and the phonetic hieroglyphs, in that in both the figure of a material object was made the sign of that sound with which the name of the object began. To follow this further would lead beyond the object of this article. But, if this

theory were true, it would still leave the Phœnicians the possibility of having actually developed the first alphabetical writing; and that, together with the fact that the earliest monuments of the Syro-Arabians have preserved *their* characters, and the unanimous consent with which ancient writers ascribe to them the transmission of the alphabet to the Greeks (Herod. v. 58; Diod. Sic. v. 74), may make the probabilities preponderate in their favour [WRITING; WRITING-MATERIALS].—J. N.

ALPHABETICAL SOUNDS. In connection with the subject of the Hebrew and Greek alphabets, we may be allowed to enter on some considerations which are seldom duly developed in the grammars of either language; and which will besides throw some light on the Greek spelling of Hebrew names.

Let us first request the reader to bestow a little study on the following table of consonants:—

	EXPLOSIVE.		CONTINUOUS.				
	Thin.	Fall.	Thin.	Full.	Liquid.	Nasal.	
Labial . .	<i>p</i>	<i>b</i>	<i>f</i>	<i>v</i>	<i>w</i>	<i>m</i>	(1)
Dental or Palatal	{ ת <i>t</i> ט	<i>d</i>	<i>θ</i>	<i>ð</i>	<i>l</i>	<i>n</i>	(2)
Guttural or Palatal	{ כ <i>k</i> פ	<i>g</i>	<i>χ</i> ח	<i>γ</i> ג	Softest German <i>ch</i> or <i>g</i>	<i>ng</i>	(3)
Aspirate .	<i>h</i>	<i>y</i>	ה <i>h</i>	ה? ח <i>hh</i>	<i>y</i>	French <i>n</i>	(4)
Sibilant or Vibratory			{ <i>s</i> ש <i>sh</i> שׁ ז	<i>z</i> French <i>j</i>	} <i>r</i>		(5)

The names annexed to the left-hand of the rows are not perfectly satisfactory. To 'Labial' no objection can be made. Neither 'Dental' nor 'Palatal' fitly describes the second row, in which the sounds are produced by *contact* (more or less slight and momentary) of the tongue with the teeth, gums, or palate; while the third row, on the contrary, does not need contact. The term 'Guttural' is apt, improperly, to give the idea of a roughness which does not exist in *k* and *g*. The soft palatal sounds of *χ*, *γ*, *ch*, cannot be named absolutely 'Palatals,' without confounding them with those of the row above. The word 'Aspirate' (or breathing) has in English been generally appropriated to a 'rough' breathing; and it is against our usage to conceive of the liquid *y* as a *breathing* at all.

Those consonants are called *explosive* on which the voice cannot dwell when they terminate a word; as *ap*, *ak*, *ad*. At their end a rebound of the organs takes place, giving the sound of an

obscure vowel; as *appè* for *ap*: for if this final sound be withheld, but half of the consonant is enunciated. The Latins, following the Greeks, called these 'Mutes.' Or the contrary, we name those *continuous* the sound of which can be indefinitely prolonged, as *afff...*, *asss...*

For the names *thin* and *full*, others say sharp and flat; or hard and soft; or surd and sonant; or whispering and vocal. It would appear that in whispering the two are merged in one; for instance, *p* cannot be distinguished from *b*, nor *z* from *s*. Yet the 'Aspirates' (or fourth row) will not *strictly* bear this test.

By the Greek letters *θ*, *ð*, *χ*, *γ*, we understand the sounds given to them by the modern Greeks; in which *θ* = English *th* in *thin*; *ð* = English *th* in *that*; *χ* = German or Irish *ch*; *γ* = Dutch *g*. To conceive of the last sound, when we know that of *χ*, it is only requisite to consider that the following proportion strictly holds:—*g* (hard) : *k* :: *γ* : *χ*. At the same time, *γ* and *χ* have a double

pronunciation, rougher and smoother, as *ch* in German has. When their roughness is much exaggerated, they give the Arabic sounds خ (*kha*) and ح (*ghain*), which last is the consonant *gh* heard in gargling. As for the softer sounds, when their softness is exaggerated, the χ passes through the softest German *ch* into a mere *y*; while the γ is gradually merged in the soft imperfect *r* of lispers, and finally in *w*.

But the fourth row, or the 'Aspirates,' yet more urgently need explanation to an Englishman. The *explosive* aspirates come under the general head of what is called the Soft Breathing in Greek grammar (although ψ in the Arab mouth is far enough from *soft*), while the *continuous* aspirates are Rough Breathings. Moreover, ψ is a fuller and stronger N , just as π is a fuller and stronger η ; and although the relation does not seem to be precisely that of *b* : *p*, or *d* : *t*, it is close enough to justify our tabular arrangement. As for π , it is rather softer than our English *h*; and ρ , or *hh*, is the *Irish h*, a wheezing sound. The consonant N is the hiatus heard between the vowels in the Greek word ἦριε , and ψ is the same sound exaggerated by a compression of the throat. The last is, in short, a jerking hiatus, such as a stuttering man often prefixes to a vowel-sound, when with effort he at length utters it. That N , ψ , are explosive, and η , ρ , continuous, is evident on trial. It is also clear that the hiatus N readily softens itself into the liquid *y*. Just so, for the name מַלְאָכָה (*Mal'ak'el*) the Sept. reads Μαλελεηλ , where the ϵ before $\eta\lambda$ is in fact meant for an English *y*. On this ground we have put *y* into the fourth row.

It is important to observe *how* the consonants of different nations differ. For instance, the German *p* and *b* are *intermediate* to the English *p* and *b*, so as to be difficult to our ears to distinguish, and the Armenians have two different *p*'s. So the English *h* is intermediate in strictness to η and ρ , if at least we assume that these Hebrew

letters had the sound of the Arabic ح and خ . Now this is a general phenomenon, in comparing the Indo-European with the Syro-Arabian sounds. Our *k* is between the two Hebrew or Arab *k*'s; our *t* is between their two *t*'s; and so on. To explain this, observe that we may execute a *t* in various ways; first, by slapping the tongue flat against the teeth, as an Irishman or man of Cumberland does when he says *water*; secondly (what is rather less broad), by slightly touching the root of the teeth, as a Frenchman or Italian does; thirdly, by touching only the gums, which is the English method; fourthly, by touching the palate, or by pressing on the gums with a muscular jerk. One or other of the last is the Hebrew ט , the Arab ط ; hence some call it a palatal, others a strong *t*. In touching the palate, the throat is involuntarily opened, and a guttural sound is imparted to the letter *and* to the following vowel; for which reason it has been also called a guttural *t*. The other method, of pressing the tongue firmly, but not on the palate, is an Armenian *t*, but perhaps not the true Syro-Arabian.

What we have here to insist on is, that differences which with us are provincialisms, with

them constitute differences of elementary sounds. To a Hebrew, ת differs from ט , or ד from פ , as decidedly as with us *p* from *b*. On the other hand, *t* and *th* (thin), as *d* and *th* (full), which with us have an elementary distinction, are but euphonic variations in Hebrew.

After this, we have to explain that ד was originally sounded forwarder on the palate than English *k*, as פ was far backwarder, at the root of the tongue. So ט was probably forwarder, and צ certainly backwarder than our *s*, each of them being nevertheless, a kind of *s*. That צ was not *ts* is seen by צַלַּח , צַיִן , מְצַרִים , &c. &c., which are written Σελλαδ , Σιών , Μεσραῖν , &c. &c. in the Sept., as well as from the analogy of the

Arabic ص . The *ts* pronunciation is a late invention, as is the *ng* sound, which has been arbitrarily assigned to ג . Nevertheless, out of ג the Greeks made τύρος , which is contrary to the analogy of Σιδών for Σιδῶν ; yet the adjective *Sarranus*, instead of *Tyrius*, used by Virgil, may prove that *Sarr* or *Sour* was in ancient, as in modern days, the right pronunciation of *Tyre*. In English we have the double sound *s* and *sh*, which is illustrative of ת and ט , ד and פ , &c., to which modification it is closely analogous. For *sh* is only a modified *s*, being formed with the broad or central part of the tongue, instead of the tip. In this action the forepart of the tongue forms itself into a sort of cup, the whole rim of which comes near to the palate while the breath rushes between. On the contrary, in sounding צ , only a single transverse section of the tongue approaches the palate; but this section is far back, and the lips are protruded and smacked, so as to constitute a mouthing *s*. Farther, the alliance of *r* to *s*, so strongly marked in the Greek and Latin languages, justifies our arranging them in one row. The *r* is formed by a vibration along the tongue, which bears some analogy to the rush of the breath along its surface, on which the *s* and *sh* depend. The Armenians have a twofold *r*, of which one, if we mistake not, is related to the other, as our *sh* to *s*.

The Hebrews were commonly stated to have given two sounds to each of the letters פ ב ת ד נ כ ך ג ז ז so as to produce the twelve sounds, *pf*, *bv*, *t* θ , *d* δ , *k* χ , *g* γ ; but it is now generally admitted that it was not so originally. The Greeks (at least provincially), even in early days, pronounced βῆρα , *Vêta*, as they now also say *Ghamma*, *Dhelta*; and the Italians for Latin *b* sometimes have *v*, sometimes *b*. The Hebrew corruption was however so early as constantly to show itself in the Sept.; indeed, as a general rule, we must regard the thin consonants פ ת כ as having assumed the *continuous*, instead of the *explosive*, pronunciation; *i. e.* they were become *f*, θ , χ . Thus פִּשְׁטָן , פִּתְּוֹל , פִּנְנָן are written φισῶν , σοβέλ , Χαναάν , in spite of the *dagesh lene* by which the later Masorites directed the initial letters to be sounded *P*, *T*, *K*. Yet there is no immovable rule. Thus the פְּתִים is in the same book variously rendered Χερτεῖμ and Κιτῖων (I Macc. i. 1, and viii. 5). It will be observed that a decidedly dental *t* is very near to *th*, and a *k*, very mincing and forward in the mouth, easily melts into *ky*, as in the Turkish language, and thence into soft χ . In this way, θ and χ having been adopted for ת and ד , τ and κ were left as the general representatives of ט and פ . It

is well known that the Ephraimites at an early period said *s*, at least in some words, for *sh*, as in the celebrated tale of Shibboleth; but this corruption went on increasing after the orthography had been fixed, so that it became requisite to denote by a dot many a ש *sh*, the sound of which had degenerated into ס *s*. It is rather perplexing to find ד occupy the same place in the Hebrew alphabet as Ξ in the Greek, a fact which perhaps still needs elucidation.

But we must turn to an important subject—the tendency of aspirates to degenerate into vowels. The muscular language of barbarians seems to love aspirates; in fact, a vowel energetically sounded is itself an aspirate, as an aspirate softened is a vowel. Let it be noticed in passing that an over-vocalised language is by no means soft. Such a word as *ἰηε* has of necessity strong hiatuses between the vowels, which hiatuses, although not written in Western languages, are virtually consonantal aspirates; in which respect an English representation of some barbarous languages is very misleading. The Hebrew spelling of Greek names often illustrates this; for example, *Antiochus* is אַנְטִיּוֹכּוֹס, where the central א indicates the hiatus between *i* and *o*. That the letters ה (final), י, י, from the earliest times were used for the long vowels A, I, U, seems to be beyond doubt. At a later period perhaps, א was used for another A: the Greeks adopted ψ for O, and finally φ for a long E. It is probable that a corruption in the Hebrew pronunciation of ה and פ had already come in when the Sept. adopted the spelling of proper names which we find. As for ה, it is the more remarkable that the Greek aspirate should not have been used for it; for both in Greece and in Italy the *h* sound must have been very soft, and ultimately had been lost. So we find in the Sept. אָבֵל for אֵבֶל *Hebel*, אֲשֶׁר for אִשֶׁר *Hoshé'a*; and even the rougher and stronger aspirate פ often vanishes. Thus עֲרֹאֲךָ for עֲרֹחַךָ *Hhendok*; פֹּאֲבֹבֹת for פֹּאֲבֹבֹת *Reh-hobot*, &c. Sometimes however the פ becomes כ, as in *Χάμ* for אֲחָ, *Χαλαχ* for אֲחָלָךְ; which may possibly indicate that פ, at least in proper names, occasionally retained the two sounds of Arabic *ahh* and *kh*. The ψ was of necessity omitted in Greek, since, at least when it was between two vowels, no nearer representation could be made than by leaving a hiatus. Where it has been denoted by Greek γ, as in *Γόμορρα*, *Γαιδάδ*, *Σηγώρ*, there is no doubt that it had the force of the Arabic ġ (ghain), whether or not this sound ever occurred in Hebrew except in proper names.

Respecting the vowels, we may add that it is now historically established, alike in the Syro-Arabian and in the Indo-European languages, that the sounds *e* and *o* (pronounced as in *maid* and *boat*) are later in time than those of *ā*, *ī*, *ū*, and are in fact corruptions of the diphthongs *ai*, *au*. Hence, originally, three long vowels, *ā*, *ī*, *ū*, with three vowel-points for the same when short, appeared to suffice. On the four very short vowels of Hebrew a needless obscurity is left in our grammars by its not being observed that we have the same number in the English language, really distinct; as in *suddēn* (or *castlē*), *contrāry*, *nobōdy*, *bēneath*; although it is probable

that with ה the vowel was clearer and sharper than in any short English *a*. We have even the *furtive vowel* of which the Hebrew grammars speak; namely, when a word ends in *r*, preceded by a long accented vowel or diphthong. In this case, a very short *a* is heard in true English speech, but not in Irish, before the *r*, as in *beer*, *shore*, *flour* (whence the orthography *flower*, *boocer*, &c.), which corresponds to the Hebrew פִּרְיָ, פִּרְיָ. The Arabs have it also when the final letter is *p*.—F. W. N.

1. ALPHÆUS (Ἀλφαῖος), father of James the Less (Matt. x. 3; Luke vi. 15), and husband of Mary, the sister of our Lord's mother (John xix. 25); for which reason James is called 'the Lord's brother' [BROTHER]. By comparing John xix. 25, with Luke xxiv. 10, and Matt. x. 3, it appears that Alphæus is the same person as Cleophas; Alphæus being his Greek, and Cleophas his Hebrew or Syriac name, according to the custom of the provinces or of the time, when men had often two names, by one of which they were known to their friends and countrymen, and by the other to the Romans or strangers. Possibly, however, the double name in Greek arises, in this instance, from a diversity in pronouncing the פ in his Aramaean name, אֲפֵיָ, a diversity which is common also in the Septuagint (see *Kuinoel in Joan. xix. 25*) [NAMES].

2. ALPHÆUS, the father of the evangelist Levi or Matthew (Mark ii. 14).

ALTAR (מִזְבֵּחַ from מָצַח, to slay (a victim), but used also for the altar of incense; Sept. generally θυσιαστήριον, sometimes βωμός). The first altar we read of in the Bible was that erected by Noah on leaving the ark. According to a Rabbinical legend, it was partly formed from the remains of one built by Adam on his expulsion from Paradise, and afterwards used by Cain and Abel, on the identical spot where Abraham prepared to offer up Isaac (Zohar, *In Gen. fol. 51, 3, 4*; Targum, Jonathan, Gen. viii. 20). Mention is made of altars erected by Abraham (Gen. xii. 7; xiii. 4; xxii. 9); by Isaac (xxvi. 25); by Jacob (xxxiii. 20; xxxv. 1, 3); by Moses (Exod. xvii. 15). After the giving of the law, the Israelites were commanded to make an altar of earth (מִזְבֵּחַ אֶרֶץ); they were also permitted to employ stones, but no iron tool was to be applied to them. This has been generally understood as an interdiction of sculpture, in order to guard against a violation of the second commandment. Altars were frequently built on high places (בְּמוֹת, בְּמוֹת, בְּמוֹת); the word being used not only for the elevated spots, but for the sacrificial structures upon them. Thus Solomon built an high place for Chemosh (1 Kings xi. 7), and Josiah brake down and burnt the high place, and stamped it small to powder (2 Kings xxiii. 15); in which passage בְּמוֹת is distinguished from מִזְבֵּחַ. This practice, however, was forbidden by the Mosaic law (Deut. xii. 13; xvi. 5), except in particular instances, such as those of Gideon (Judg. vi. 26) and David (2 Sam. xxiv. 18). It is said of Solomon 'that he loved the Lord, walking in the statutes of David, his father, only he sacrificed and burnt incense on the high places' (1 Kings iii. 3). Altars were sometimes built on the roofs of houses: in 2 Kings xxiii. 12, we read of the altars that were on the top of the upper chamber of Ahaz. In the taber-

nacle, and afterwards in the temple, two altars were erected, one for sacrifices, the other for incense: the table for the shew-bread is also sometimes called an altar.

1. The altar of burnt-offering (מזבח העולה) belonging to the tabernacle was a hollow square, five cubits in length and breadth, and three cubits in height; it was made of Shittim-wood [שִׁטִּים], and overlaid with plates of brass. In the middle there was a ledge or projection, כרכב, *deambulacrum*, on which the priest stood while officiating; immediately below this, a brass grating was let down into the altar to support the fire, with four rings attached, through which poles were passed, when the altar was removed. Some critics have supposed that this grating was placed perpendicularly, and fastened to the outward edge of the כרכב, thus making the lower part of the altar larger than the upper. Others have imagined that it extended horizontally beyond the כרכב, in order to intercept the coals or portions of the sacrifice which might accidentally fall off the altar. Thus the Targumist Jonathan says, 'Quod si cadat frustum aut pruna ignis ex altari, cadat super craticulam nec peringat ad terram; tum capient illud sacerdotes ex craticula et reponent in altari.' But for such a purpose (as Dr. Bähr remarks) a grating seems very unsuitable. As the priests were forbidden to go up by steps to the altar (Exod. xx. 26), a slope of earth was probably made rising to a level with the כרכב. According to the Jewish tradition this was on the south side, which is not improbable; for on the east was 'the place of the ashes' (מקום הרטין), Lev. i. 16, and the laver of brass was probably near the western side, so that only the north and south sides were left. Those critics who suppose the grating to have been perpendicular or on the outside, consider the injunction in Exod. xx. 24, as applicable to this altar, and that the inside was filled with earth; so that the boards of Shittim-wood formed merely a case for the real altar. Thus Jarchi, on Exod. xxvii. 5, says, 'Altare terreum est hoc ipsum æneum altare, cuius concavum terrâ implebatur cum castra metarentur.'

In Exod. xxvii. 3, the following utensils are mentioned as belonging to the altar, all of which were to be made of brass. (1) סירות *siroth*, pans or dishes to receive the ashes that fell through the grating. (2) יעים *yaim*, shovels (*forcipes*, Vulg.) for cleaning the altar. (3) מזרקות *misrakoth* (*basons*, Auth. Vers.; *φιάλα*, Sept.; *patera sacrificia*, Gesenius), vessels for receiving the blood and sprinkling it on the altar. (4) מזלגות *mizlagoth* ('*flesh-hooks*,' Auth. Vers.; *κρέγγαι*, Sept.; *fuscinulæ*, Vulg.), large forks to turn the pieces of flesh or to take them off the fire (see 1 Sam. ii. 13). (5) מחתות *machthoth* ('*fire-pans*,' Auth. Vers.; *τὸ πυρσείον*, Sept.); the same word is elsewhere translated *censers*, Num. xvi. 17; but in Exodus xxv. 38, '*snuff-dishes*;' ὑποθήματα, Sept.

2. The altar of burnt-offering in Solomon's temple was of much larger dimensions, 'twenty cubits in length and breadth, and ten in height' (2 Chron. iv. 1), and was made entirely of brass. It is said of Asa that he renewed (הרץ), that is, either repaired (in which sense the word is evidently used in 2 Chron. xxiv. 4) or reconsecrated (ἐρεκαίνισε, Sept.) the altar of the Lord that was

before the porch of the Lord (2 Chron. xv. 8). This altar was removed by king Ahaz (2 Kings xvi. 14; it was 'cleansed' (בטהר), ἀγγίζω) by Hezekiah; and in the latter part of Manasseh's reign was rebuilt (כתיב ויבן; כריי kerî).

3. Of the altar of burnt-offering in the second temple, the canonical scriptures give us no information excepting that it was erected before the foundations of the temple were laid (Ezra iii. 3, 6) on the same place where it had formerly been built, ἐφ' οὗ καὶ πρότερον ἦν ἀνωκοδομημένον τόπου (Joseph. *Antiq.* xi. 4. 1). From the Apocrypha, however, we may infer that it was made, not of brass, but of unhewn stone, for in the account of the restoration of the temple service by Judas Maccabæus, it is said, 'They took whole stones (λίθους ἀλοκλήρους), according to the law, and built a new altar according to the former' (1 Macc. iv. 47). When Antiochus Epiphanes pillaged Jerusalem, Josephus informs us that he left the temple bare, and took away the golden candlesticks and the golden altar [of incense] and table [of shew-bread], and the altar of burnt-offering, τὰ θυσιαστήρια (*Antiq.* xii. 5. 4).

4. The altar of burnt-offering erected by Herod is thus described by Josephus (*De Bell. Jud.* v. 5. 6): 'Before this temple stood the altar, fifteen cubits high, and equal both in length and breadth, each of which dimensions was fifty cubits. The figure it was built in was a square, and it had corners like horns (κερατοειδείς προανέχων γωνίας), and the passage up to it was by an insensible acclivity from the south. It was formed without any iron tool, nor did any iron tool so much as touch it at any time.' The dimensions of this altar are differently stated in the Mishna. It is there described as a square 32 cubits at the base; at the height of a cubit it is reduced 1 cubit each way, making it 30 cubits square; at 5 cubits higher it is similarly contracted, becoming 28 cubits square, and at the base of the horns, 26 cubits; and allowing a cubit each way for the *deambulacrum*, a square of 24 cubits is left for the fire on the altar. Other Jewish writers place the *deambulacrum* 2 feet below the surface of the altar, which would certainly be a more suitable construction. The Mishna states, in accordance with Josephus, that the stones of the altar were unhewn, agreeably to the command in Exod. xx. 25; and that they were whitewashed every year at the Passover and the feast of tabernacles. On the south side was an inclined plane, 32 cubits long and 16 cubits broad, made likewise of unhewn stones. A pipe was connected with the south-west horn, through which the blood of the victims was discharged by a subterranean passage into the brook Kedron. Under the altar was a cavity to receive the drink-offerings, which was covered with a marble slab, and cleansed from time to time. On the north side of the altar several iron rings were fixed to fasten the victims. Lastly, a red line was drawn round the middle of the altar to distinguish between the blood that was to be sprinkled above and below it.

II. The second altar belonging to the Jewish Cultus was the altar of incense, מזבח המקטור, מזבח הקטרת or θυσιαστήριον θυμιάματος, Sept.; θυμιατήριον, Josephus; called also the golden altar (Num. iv. 11) מזבח הזהב. It was placed between the table of shew-bread

and the golden candlestick, in the most holy place.

1. This altar in the tabernacle was made of Shittim-wood overlaid with gold plates, one cubit in length and breadth, and two cubits in height. It had horns (Lev. iv. 7) of the same materials; and round the flat surface was a border (קֶרֶן, *crowns*, Auth. Vers.; *στρεπτήν στεφάνην χρυσῆν*, Sept.) of gold, underneath which were the rings to receive 'the staves (שִׁטִּים, *σκυτάλαι*) made of Shittim-wood, overlaid with gold to bear it withal' Exod. xxx. 1-5; Joseph. *Antiq.* iii. 6. 8).

2. The altar in Solomon's Temple was similar, but made of cedar (1 Kings vi. 20; vii. 48; 1 Chron. xxix. 18) overlaid with gold.

3. The altar in the second temple was taken away by Antiochus Epiphanes (1 Macc. i. 23), and restored by Judas Maccabæus (1 Macc. iv. 49). On the arch of Titus there appears no altar of incense; it is not mentioned in Heb. ix., nor by Joseph. *Antiq.* xiv. 4. 4 (*vide* Tholuck *On the Hebrews*, vol. ii. p. 8; *Biblical Cabinet*, vol. xxxix.) (Winer's *Realwörterbuch*, articles 'Altar,' 'Brandopfer altar,' 'Raucheraltar;' Bähr's *Symbolik des Mosaischen Cultus*, bd. i. Heidelberg, 1837).—J. E. R.

ALTARS, FORMS OF. In the preceding article the reader is furnished with all the positive information which we possess respecting the altars mentioned in Scripture; but as, with regard to material objects so frequently named as altars, we feel a desire to have distinct images in the mind, some further remarks respecting the forms which they probably bore, may not be unacceptable.

The direction to the Israelites, at the time of their leaving Egypt, to construct their altars of unhewn stones or of earth, is doubtless to be understood as an injunction to follow the usage of their patriarchal ancestors; and not to adopt the customs, full of idolatrous associations, which they had seen in Egypt, or might see in the land of Canaan. As they were also strictly enjoined to destroy the altars of the Canaanites, it is more than probable that the direction was levelled against such usages as those into which that people had fallen. The conclusion deducible from this, that the patriarchal altars were of unhewn stones or of earth, is confirmed by the circumstances under which they were erected, and by the fact that they are always described as being 'built.' The provision that they *might* be made of earth, applies doubtless to situations in which stones could not be easily obtained, as in the open plains and wildernesses. Familiar analogies lead to the inference that the largest stones that could be found in the neighbourhood would be employed to form the altar; but where no large stones could be had, that heaps of smaller ones might be made to serve.

As these altars were erected in the open air, and were very carefully preserved, there is at least a strong probability that some of those ancient monuments of unhewn stone, usually called Druidical remains, which are found in all parts of the world, were derived from the altars of primitive times. These are various in their forms; and their peculiar uses have been very much disputed. It is admitted, however, that some of them must have been altars; but the difficulty is, to determine whether these altars are to be sought in the Crom-

lechs or the Kistvaens. In another work (*Pictorial Hist. of Palestine*, Supp. Notes to b. iii. chs. i. iii. iv.) the whole subject is largely examined in its scriptural relations; and the author, through a mass of authority and illustration, there reaches the conclusion that the arguments preponderate in favour of the opinion that the Cromlechs are the representatives of the primitive altars, and that the Kistvaens (stones disposed in a chest-like form) are analogous to the arks of the Jewish ritual and of some of the pagan religions [ARK].

Cromlechs, as is well known, are somewhat in the form of a table, one large stone being supported, in a horizontal or slightly inclined position, upon three or more, but usually three stones, set upright. That they were used as altars is

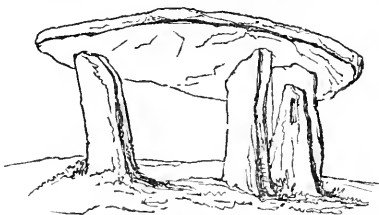

almost instinctively suggested to every one that views them; and this conclusion is strengthened when, as is often the case, we observe a small circular hole through which probably the rope was run by which the victims, when slaughtered, were bound to the altar, as they were to the angular projections or 'horns' of the Jewish altar (Ps. cxviii. 27). It was natural that where a sufficiency of large stones could not be found, heaps of smaller ones should be employed; and that, when practicable, a large flat stone would be placed on the top, to give a proper level for the fire and the sacrifice. Such are the cairn-altars, of which many still remain; but as they are sometimes found in places where stones of large size might have been obtained, it seems that in later times such altars had a special appropriation; and Toland (*Hist. B. Druids*, 101) shows that the sacred fires were burned on them, and sacrifices offered to Bel, Baal, or the Sun.



The injunction that there should be no ascent by steps to the altar appears to have been imperfectly understood. There are no accounts or figures of altars so elevated in their fabric as to require such steps for the officiating priests; but when altars are found on rocks or hills, the ascent to them is sometimes facilitated by steps cut in the rock. This, therefore, may have been an indirect way of preventing that erection of altars in high places which the Scriptures so often reprobate.

It is usually supposed, however, that the effect of this prohibition was, that the tabernacle altar,

like most ancient altars, was so low as to need no ascent; or else that some other kind of ascent was provided. The former is Calmet's view, the latter Lamy's. Lamy gives a sloping ascent, while Calmet merely provides a low standing-board for the officiating priest. The latter is probably right, for the altar was but three cubits high, and was designed to be portable. There is one error in these and other figures of the Jewish altars composed from the descriptions; namely, with regard to the 'horns,' which were placed at the corners, called 'the horns of the altar' (Exod. xxvii. 2; xxix. 12; 1 Kings ii. 28), and to which the victims were tied at the time of sacrifice. The word horn (קֶרֶן *keren*) was applied by the Jews as an epithet descriptive

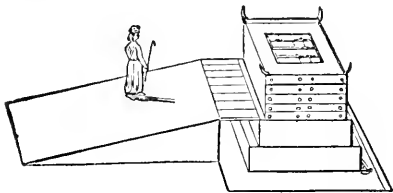

of any point projecting in any direction after the manner of a horn (not necessarily like a horn in shape); and there is no reason to doubt that the horns of the successive altars of burnt-offerings resembled those corners projecting upwards which are seen in many ancient altars. These are shown in the view now given (from the *Pictorial Bible*), which, although substantially the same, is, in this and other respects, a considerable improvement upon that of Calmet.

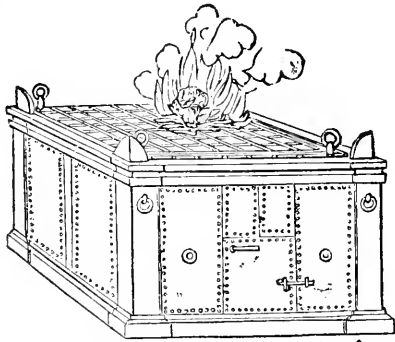

By the time of Solomon it appears to have been understood that the interdiction of steps of ascent did not imply that the altar was to be low, but rather that it was to be high, and that only a particular mode of ascent was forbidden. The altar of the temple was not less than ten cubits high, and some means of ascent must have been provided. The usual representations of Solomon's altar are formed chiefly from the descriptions of that in Herod's temple given by Josephus and the Rabbins; and although this last was almost one-third higher and larger than the other, it was doubtless upon the same model. The altar of the first temple had been seen, and could be described, by many of those who were present when that of the second temple was erected; and the latter was

known to those by whom Herod's altar was built. Very different figures, however, have been formed from these descriptions.

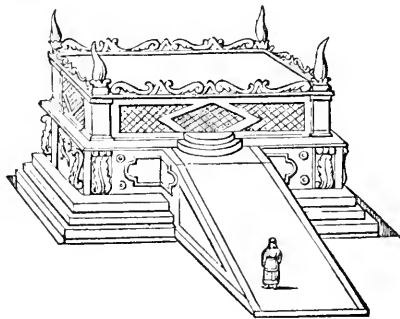

The first figure is taken from Calmet's original work, and exhibits the form which, with slight variation, is also preferred by Bernard Lamy, and by Prideaux (*Connection*, i. 200). It is excellently conceived; but is open to the objection that the slope, so far from being 'insensible,' as Josephus describes it, is steep and inconvenient; and yet, on the other hand, a less steep ascent to an object so elevated must have been inconveniently extended.

Calmet gives the above only as in accordance with the Rabbinical descriptions. His own view of

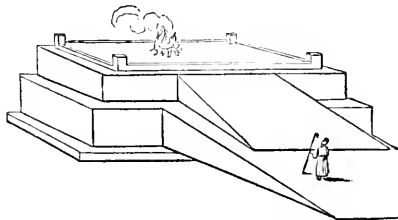

the matter is conveyed in the annexed figure. This is certainly a very handsome altar in itself, but it would be scarcely possible to devise one more unsuitable for the actual, and occasionally extensive, services of the Jewish altar. None of these objections apply to the next figure, derived from Surenhusius (*Mishna*, tom. ii. p. 261), which, for

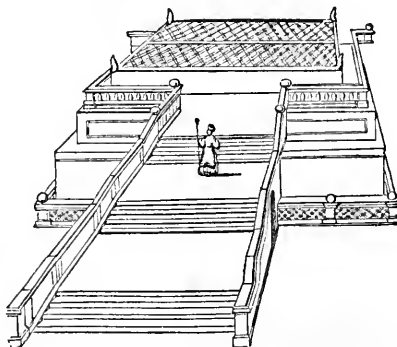

use and effect, far exceeds any other representation that has hitherto been attempted. An ascent

by an inclined plane to an altar so high as that of Solomon must either have been inconveniently steep, or have had an unseemly extension—objections obviated by the provision of three ascents, of four steps each, conducting to successive platforms. In the description of Ezekiel's temple, 'steps' (מַעְלֹת) are placed on the east side of the altar (Ezek. xliii. 17); and as it is generally supposed that the details of that description agree with those of Solomon's temple, it is on that authority the steps are introduced. If they actually existed, it may be asked how this was consistent with the law, which forbade steps altogether. The obvious answer is, that, as public decency was the ostensible ground of the prohibition (Exod. xx. 26), it might be supposed that it was not imperative if steps could be so disposed that decency should not be violated; and that, if a law may be interpreted by the reason of its enactment, this law could only be meant to forbid a *continuous* flight of steps, and not a broken ascent. If it is still urged against this view that, according to Josephus, the ascent in the temple of Herod was by an insensible slope, an answer is found in the fact, that, at the time of its erection, a mode of interpreting the law according to the dead letter, rather than the spirit, had arisen; and we have no doubt that even had it been then known that steps actually existed in Solomon's altar, or in that of the second temple, this would have been regarded as a serious departure from the strict letter of the law, not to be repeated in the new altar. In a similar way the student of the Bible may account for some other discrepancies between the temples of Solomon and Ezekiel, and that of Herod.

namely, that all the Oriental altars are square or oblong, whereas those of Greece and Rome are more usually round; and that, upon the whole, the Hebrew altars were in accordance with the general Oriental type. In all of them we observe bases with corresponding projections at the top; and in some we find the true model of the 'horns,' or prominent and pointed angles.

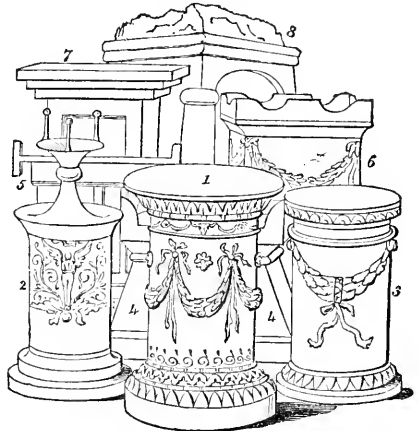

1, 2, 3. Greek. 4. Egyptian. 5. Babylonian. 6. Roman. 7, 8. Persian.

Not regarding the *table of shew-bread* as an altar, an account of it is reserved for the proper head; and other articles afford information respecting the uses and privileges of the altars of burnt-offering and of incense [ASYLUM; CENSER; INCENSE; SACRIFICE].

ALTAR AT ATHENS. St. Paul, in his admired address before the judges of the Areopagus at Athens, declares that he perceived that the Athenians were in all things too superstitious,* for that, as he was passing by and beholding their devotions, he found an altar, inscribed, 'TO THE UNKNOWN GOD;' and adds, with unexpected force, 'Him whom ye worship without knowing (*ὃν οὐκ ἠγνοοῦντες εἰσεβέετε*), I set forth unto you' (Acts xvii. 22, 23). The questions suggested by the mention of an altar at Athens, thus inscribed 'to the unknown God,' have engaged much attention; and different opinions have been, and probably will continue to be, entertained on the subject.

The principal difficulty arises from this, that the Greek writers, especially such as illustrate the Athenian antiquities, make mention of many altars dedicated *ἀγνώστοις Θεοῖς*, to the unknown gods, but not of any one dedicated *ἀγνώστῳ Θεῷ*, to the unknown god. The passage

* *Δεισιδαιμονοστέρους*—a word that only occurs here, and is of ambiguous signification, being capable of a good, bad, or indifferent sense. Most modern, and some ancient, expositors hold that it is here to be taken in a good sense (*very religious*), as it was not the object of the apostle to give needless offence. This explanation also agrees best with the context, and with the circumstances of the case. A man may be 'very religious,' though his religion itself may be false.

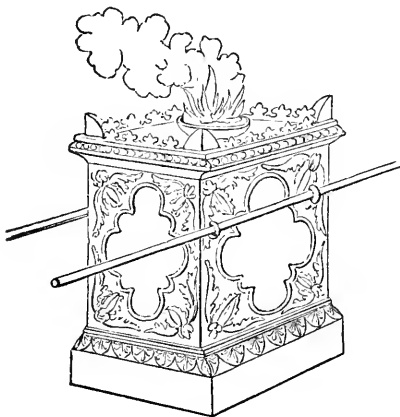

THE ALTAR OF INCENSE, being very simple in its parts and uses, has been represented with so little difference, except in some ornamental details, that one of the figures designed from the descriptions may suffice. It is the same as the one inserted in the *Pictorial Bible* (Exod. xxx.); and, as to the corners ('horns'), &c., is doubtless more accurate than those given by Calmet and others.

It is not our object to describe the altars of other nations; but, to supply materials for comparison and illustration, a group of the altars of the principal nations of Oriental and classical antiquity is here introduced. One obvious remark occurs

in Lucian (*Philopat.* § 9), which has often been appealed to as evidence that there existed at Athens an altar dedicated, in the singular, to the unknown God, ἀγνώστῳ Θεῷ, is of little worth for the purpose. For it has been shown by Eichhorn, and Niemeyer (*Interp. Orat. Paul. Ath. in Areop. hab.*), that this witty and profane writer only repeats the expression of St. Paul, with the view of casting ridicule upon it, as he does on other occasions. The other passages from Greek writers only enable us to conclude that there were altars at Athens dedicated to many unknown gods (Pausan. i. 1; Philostrate. *Vit. Ap.* vi. 3). It has also been supposed that the allusion may be to certain anonymous altars, which were erected by the philosopher Epimenides, in the time of a terrible pestilence, as a solemn expiation for the country (Diog. Laert. *Vit. Epimen.* i. 29). Dr. Doddridge, among others, dwells much on this. But it is a strong objection to the view which he has taken, that the sacrifices on these altars were to be offered not ἀγνώστῳ Θεῷ, but τῷ προσήκοντι Θεῷ, i. e. to the God to whom this affair appertains, or the God who can avert the pestilence, whoever he may be; and such, no doubt, would have been the inscription, if there had been any. But these altars are expressly said to have been βεταμοὶ ἀνόνημοι, i. e. anonymous altars, evidently not in the sense of altars inscribed to the unknown God, but altars without any name or inscription.

Now, since the ancient writers tell us that there were at Athens many altars inscribed to the unknown gods, Erasmus, Le Clerc, Brodæus, and many others, have maintained that St. Paul changed the plural number into the singular in accommodation to his purpose. Of this opinion was Jerome (*Comment. in Tit.* i. 12), who testifies that this inscription (which, he says, had been read by him) was, Θεοῖς Ἀσίας καὶ Ἑυρώπης καὶ Λιβύης, Θεοῖς ἀγνώστοις καὶ ξένοις, 'To the gods of Asia, Europe, and Africa; to the unknown and strange gods.' Bretschneider, relying on this authority, supposes (*Lex. N. T.*, s. v. ἄγνωστος) the inscription to have been ἀγνώστοις Θεοῖς, i. e. to the gods of foreign nations, unknown to the Athenians; indicating that either foreigners might sacrifice upon that altar to their own gods, or that Athenians, who were about to travel abroad, might first by sacrifice propitiate the favour of the gods of the countries they were about to visit. He quotes the sentiment of Tertullian: 'I find, indeed, altars prostituted to unknown gods, but idolatry is an Attic tenet; also to uncertain gods, but superstition is a tenet of Rome.' To the view that such was the inscription which Paul noticed, and that he thus accommodated it to his immediate purpose, it has been very justly objected that, if this interpretation be admitted, the whole strength and weight of the apostle's argument are taken away; and that his assertion might have been convicted of falsity by his opponents. Therefore, while admitting the authorities for the fact, that there were altars inscribed to the unknown gods, they contend that St. Paul is at least equally good authority, for the fact that one of these altars, if not more, was inscribed in the singular, to the unknown God. Chrysostom (*In Acta Ap.*), who objects strongly to the preceding hypothesis, offers the conjecture that the Athenians, who were a people exceedingly

superstitious, being apprehensive that they might have overlooked some divinity and omitted to worship him, erected altars in some part of their city inscribed to the unknown God; whence St. Paul took occasion to preach to the Acreopagites Jehovah as a God, with respect to them truly unknown; but whom they yet, in some sort, adored without knowing him. Similar to this in essential import is the conjecture of Eichhorn (*Allgem. Biblioth.* iii. 414) to which Niemeyer subscribes, that there were standing at Athens several very ancient altars, which had originally no inscription, and which were afterwards not destroyed, for fear of provoking the anger of the gods to whom they had been dedicated, although it was no longer known who these gods were. He supposes, therefore, that the inscription ἀγνώστῳ Θεῷ, to an [some] unknown God, was placed upon them; and that one of these altars was seen by the apostle, who, not knowing that there were others, spoke accordingly. To this we may add the notion of Kuinoël (*Comm. in Act. xvii.* 23), who considers it proved that there were several altars at Athens on which the inscription was written in the plural number; and believes that there was also one altar with the inscription in the singular, although the fact has been recorded by no other writer. For no argument can be drawn from this silence, to the discredit of a writer, like St. Paul, of unimpeached integrity. The altar in question, he thinks, had probably been dedicated ἀγνώστῳ Θεῷ, on account of some remarkable benefit received, which seemed attributable to some God, although it was uncertain to whom.

It would be improper to dismiss this subject without noticing the opinion of Augustine, who had no doubt that the Athenians, under the appellation of the unknown God, really worshipped the true one. Others besides him have thought that the God of the Jews was the real object of this altar, he being a powerful God, but not fully known to them, as the Jews never used his name in speech, but substituted 'THE LORD' for 'JEHOVAH.' One of the warmest modern advocates of Augustine's opinion is Dr. Hales, who, among a multitude of other matters, irrelevant to his 'Chronology,' but interesting in themselves, has critically examined this subject (vol. iii. pp. 519-531). Alluding to the alleged fact that Athens was colonized from Sais in Egypt, where there was a temple to Neith, the Egyptian goddess of wisdom, on which was the famous inscription, Ἐγὼ εἶμι ΠΑΝ Τὸ γέγενοσ, καὶ ἄν, καὶ εἰσόμενον καὶ τῶν ἐμῶν πέπλον οὐδέτις πω θνητὸς ἀπεκάλυψεν.—I am ALL that has been, and is, and shall be; and my veil no mortal hath yet uncovered,' he seems disposed to connect this inscription with the one on the Athenian altar, and to refer both to that remote 'unknowable' WISDOM, far beyond all known causes, whom the heathen dimly guessed at under obscure metaphors and recondite phrases; but whom the Hebrews knew under the name of Jehovah.

But there is no end of these hypotheses; and we are content to rest in the conclusion of Professor Robinson (*Add. in Am. Edit. of Calmet*): 'So much at least is certain, that altars to an unknown god or gods existed at Athens. But the attempt to ascertain definitively whom the Athenians worshipped under this appellation must ever remain fruitless for want of sufficient

data. The inscription afforded to Paul a happy occasion of proclaiming the Gospel; and those who embraced it found indeed that the being whom they had thus "ignorantly worshipped," was the one only living and true God.'

ALUKAH (אַלֻכָּה; Sept. Βδέλλα; Vulg. *Sanguisuga*; A. V. 'Horse-leech') occurs only in Prov. xxx. 15 (genus, *vermes*; order, *intestinata*, Linn. Viviparous, brings forth only one offspring at a time: many species). 'The horse-leech' is properly a species of leech discarded for medical purposes on account of the coarseness of its bite. There is no ground for the distinction of species made in the English Bible.

Although the Hebrew word is translated *leech* in all the versions, there has been much dispute whether that is its proper meaning. Against the received translation, it has been urged that, upon an examination of the context in which it occurs, the introduction of the leech seems strange: that it is impossible to understand what is meant by its 'two daughters,' or *three*, as the Septuagint, Syriac, and Arabic versions assign to it; and that, instead of the incessant craving apparently attributed to it, the leech drops off when filled. In order to evade these difficulties it has been attempted, but in vain, to connect the passage either with the preceding or subsequent verse. It has also been attempted to give a different sense to the Hebrew word. But as it occurs nowhere besides, in Scripture, and as the root from which it would seem to be derived is never used as a verb, no assistance can be obtained from the Scriptures themselves in this investigation. Recourse is therefore had to the Arabic. The following is the line of criticism pursued by the learned Bochart (*Hierozoicon*, a Rosenmüller, iii. 785, &c.). The Arabic word for leech is *alakah*, which is derived from a verb signifying to hang or to adhere to. But the Hebrew word, *alukah*, he would derive from another Arabic root, *alukh*, which means 'fate, heavy misfortune, or impending calamity'; and hence he infers that *alukah* properly means destiny, and particularly the necessity of dying which attaches to every man by the decree of God. He urges that it is not strange that offspring should be ascribed to this divine appointment, since, in Prov. xxvii. 1, offspring is attributed to time, a day—'Thou knowest not what a day may bring forth.' And the Hebrews call events the children of time. We also speak of the womb of time. Thus, then, Bochart considers that destiny, or the divine decree concerning death, is here personified and represented as having, 'two daughters crying, give, give'; namely, הַשְׁמָד, Hades, or the state of departed souls, and the grave. He cites Prov. xxvii. 20, as a parallel passage: 'Hell (*sheol*) and the grave are never full,' which the Vulgate renders 'infernus est perditio.' Hence he supposes that *sheol* and the *grave* are the two daughters of Alukah or Destiny; each cries 'give' at the same moment—the former asks for the soul, and the latter for the body of man in death; both are insatiable, for both involve all mankind in one common ruin. He further thinks that both these are called daughters, because each of the words is of the feminine, or, at most, of the common gender; and in the 16th verse, the grave (*sheol*) is specified as one of the 'things that are

never satisfied.' In further confirmation of this view, Bochart cites rabbinical writers, who state that by the word *alukah*, which occurs in the Chaldee paraphrase on the Psalms, they understand destiny to be signified; and also remark that it has two daughters—Eden and Gehenna, Paradise and Hell—the former of whom never has enough of the souls of the righteous, the latter of the souls of the wicked.

In behalf of the received translation, it is urged that it is scarcely credible that all the ancient translators should have confounded *alukah* with *alakah*; that it is peculiarly unlikely that this should have been the case with the Septuagint translator of the book of Proverbs, because it is believed that 'this ranks next to the translation of the Pentateuch for ability and fidelity of execution'; and that the author of it must have been well skilled in the two languages (Horne's *Introduction*, ii. 43: ed. 1828). It is further pleaded that the application of Arabic analogies to Hebrew words is not decisive; and finally, that the theory proposed by Bochart is not essential to the elucidation of the passage. In the preceding verse the writer (not Solomon—see verse 1) speaks of 'a generation, whose teeth are as swords, and their jaw-teeth as knives to devour the poor from off the earth, and the needy from among men;' and then, after the abrupt and picturesque style of the East, especially in their proverbs, which is nowhere more vividly exemplified than in this whole chapter, the leech is introduced as an illustration of the covetousness of such persons, and of the two distinguishing vices of which it is the parent, avarice and cruelty. May not also the 'two daughters' of the leech, crying, Give, give,' be a figurative description of the two lips of the creature (for these it has, and perfectly formed), which are a part of its very complicated mouth? It certainly is agreeable to the Hebrew style to call the offspring of inanimate things *daughters*, for so branches are called daughters of trees (Gen. xlix. 22—margin). A similar use of the word is found in Eccles. xii. 4, 'All the daughters of music shall be brought low,' meaning the lips, front teeth, and other parts of the mouth. It is well remarked by Professor Paxton, that 'this figurative application of the entire genus is sufficient to justify the interpretation. The leech, as a symbol, in use among rulers of every class and in all ages, for avarice, rapine, plunder, rapacity, and even assiduity, is too well known to need illustration' (Plau. *Epidic.* art. 2; Cicero, *ad Attic.*; Horace, *Ars Poet.* 476; Theocritus, *Pharmaceut.*; &c. &c.).—J. F. D.

ALUSH (אַלֻשׁ; Sept. Αιλουός), one of the places at which the Hebrews rested on their way to Mount Sinai (Num. xxxiii. 13). It was between Dophkah and Rephidim. The Jewish Chronology (*Seder Olam Rabba*, c. 5, p. 27) makes it twelve miles from the former and eight from the latter station. The Targum of Jonathan calls it 'a strong fort'; and it is alleged (upon an interpretation of Exod. xvi. 30) that in Alush the Sabbath was instituted, and the first Sabbath kept.

AMALEK (אַמֻלֵּק), a son of Eliphaz (the first-born of Esau) by his concubine Timna: he

was the chieftain, or Emir (אֶלֶם, Sept. ἡγεμών, Auth. *V. Duke*), of an Idumæan tribe (Gen. xxxvi. 16).

AMALEKITES, the name of a nation inhabiting the country to the south of Palestine between Idumæa and Egypt, and to the east of the Dead Sea and Mount Seir. 'The Amalekites dwell in the land of the south' (בְּאֶרֶץ הַנֶּגֶב, Num. xiii. 29.). 'Saul smote the Amalekites from Havilah until thou comest to Shur, that is over against Egypt' (1 Sam. xv. 7). 'David went up and invaded the Geshurites, and Gezrites, and the Amalekites, for those nations were of old the inhabitants of the land as thou goest to Shur, even unto the land of Egypt' (1 Sam. xxvii. 8). In 1 Chron. iv. 42, it is said that the sons of Simeon went to Mount Seir and smote the rest of the Amalekites that were escaped. According to Josephus (*Antiq.* iii. 2, §1) the Amalekites inhabited Gobolitis (גִּבּוֹלִיטַי, Ps. lxxiii. 8; Γέβαλα, Γάβαλα, Stephanus Byz.; Γεβαληνή, Γαβαληνή, Euseb.) and Petra, and were the most warlike of the nations in those parts: *ὅς τε τὴν Γοβολίτιν καὶ τὴν Πέτραν κατοικοῦντες, ὁ καλοῦνται μὲν Ἀμαληκίται, μαχημῶτατοι δὲ τῶν ἐκείσε ἐθνῶν ὑπῆρχον*. In another passage he says, 'Aliphaz had five legitimate sons, Theman, Omer, Saphus, Gotham, and Kanaz; for Amalek was not legitimate, but by a concubine, whose name was Thamna. These dwell in that part of Idumæa called Gobolitis, and that called Amalekitis, from Amalek' (*Antiq.* ii. 1); and elsewhere he speaks of them as 'reaching from Pelusium of Egypt to the Red Sea' (*Antiq.* vi. 7). We find, also, that they had a settlement in that part of Palestine which was allotted to the tribe of Ephraim. Abdon, one of the judges of Israel, was buried in Pirathon, in the land of, Ephraim, in the mount of the Amalekites, בְּהַר הָעִמְלֵקִי. In Deborah's triumphal ode it is said *מוֹנֵי אֶפְרַיִם שָׂרְעִים בְּעַמְלֵק*, 'out of Ephraim was there a root of them against Amalek' (Auth. Vers.), which Ewald (*Die Poetischen Bücher des Alten Bundes*, &c., Göttingen, 1839, Band. i. 129) translates '*Von Ephraim die, deren Wurzel ist in Amalek*,' 'of Ephraim those whose root is in Amalek,' i. e. the Ephraimites who dwell in the mount of the Amalekites. On comparing this text and Joshua xvi. 10, 'they drove not out the Canaanites that dwell in Gezer (בְּנֵזֶר), but the Canaanites dwell among the Ephraimites unto this day'—with 1 Sam. xxvii. 8, 'David invaded the Geshurites, and Gezrites, and the Amalekites,' &c.,—it seems probable that the Gezrites (גִּזְרִי) were the inhabitants of Gezer (גִּזְרָה) (v. Gesenius); but in that case David must have marched northward instead of southward, and the southern position of the Amalekites is expressly stated. The first mention of the Amalekites in the Bible is Gen. xiv. 7; Chedorlaomer and his confederates returned and came to En-mishpat, which is Kadesh, and smote all the country of the Amalekites, and also the Amorites that dwell in Hazezon-tamar.' From this passage it has been inferred that the Amalekites existed as an independent nation at that time, and were, therefore, totally distinct from the descendants of the son of Eliphaz. On the other hand, it has been remarked that while several other nations are specified ('the Rephaims, the Zuzims, the Emims,' v. 5, 'the Horites,' v. 6, and 'the

Amorites,' v. 7), the phrase 'all the country of the Amalekites' (בְּכָל־שְׂדֵה הָעִמְלֵקִי) may have been used by the sacred historian to denote the locality not then, but long afterwards, occupied by the posterity of Amalek (Hengstenberg's *Die Authentie des Pentateuches*, Band ii. 305). The LXX. appear to have read בְּכָל־שְׂדֵה, all the princes, instead of בְּכָל־שְׂדֵה, all the country, κατέκοψαν πάντας τοὺς ἄρχοντας Ἀμαλήκ; a reading which, if correct, would be in favour of the former supposition. Origen says (*In Numer Homil.* xix.), *interfecerunt omnes principes Amalek*, Rufinus's Latin version. After starting the question, whether this name belonged to two nations, without attempting to settle it, he turns off to its allegorical interpretation (*Opera*, κ. 230, Berol. 1840). The Amalekites were the first assailants of the Israelites after their passage through the Red Sea (Exod. xvii.). In v. 13 it is said 'Joshua discomfited Amalek and his people with the edge of the sword.' Amalek may here be employed as the name of the chief of the tribe, as Pharaoh was the name of the successive kings of Egypt, and in this case the words must mean the prince and his army. But if 'Amalek' stand for the nation, 'his people' must mean their confederates. It has been thought improbable that in so short a period the descendants of Esau's grandson could have been sufficiently numerous and powerful to attack the host of Israel; but within nearly the same period the tribe of Ephraim had increased so that it could muster 40,500 men able to bear arms, and Manasseh 32,200; and admitting in the case of the Israelites an extraordinary rate of increase (Exod. i. 12, 20), still, if we consider the prostrating influence of slavery on the national character, and the absence of warlike habits, it is easy to conceive that a comparatively small band of marauders would be a very formidable foe to an undisciplined multitude, circumstanced as the Israelites were, in a locality so adapted to irregular warfare. It appears too that the attack was made on the most defenceless portion of the host. 'Remember (said Moses) what Amalek did unto thee by the way when ye were come forth out of Egypt; how he met thee by the way and smote the hindmost of thee, even all that were feeble behind thee (הַנְּחִישִׁים); Sept. κοινῶτες, Vulg. *lassi*), when thou wast faint and weary' (Deut. xxv. 17). In Balaam's prophecy (Num. xxiv.) Amalek is denominated 'the first of the nations,' רִאשִׁית נַוִּים. The Targumists and several expositors, both Jewish and Christian, have taken this to mean 'the first of the nations that warred against Israel' (Marg. reading, Auth. Vers.). But it appears more agreeable to the antithetical character of Oriental poetry to interpret it of the rank held by the Amalekites among the surrounding nations, their pre-eminence as a warlike tribe, here contrasted with their future downfall and extinction. Or if we understand the term רִאשִׁית, of priority in time, of the antiquity of the nation, this would become a striking contrast with 'his latter end' (אַחֲרֵיתוֹ). In the Pentateuch the Amalekites are frequently mentioned in connection with the Canaanites (Num. xiv. 25, 43, 45), and, in the book of Judges, with the Moabites and Ammonites (Judg. iii. 13), with the Midianites (Judg. vi. 3; vii. 12: 'The Midianites, and the Amalekites, and all the children of the East lay along in the valley לְבָא

grasshoppers for multitude; and their camels were without number, as the sand by the sea-side for multitude'); with the Kerites, 1 Sam. xv. 6. By divine command, as a retribution for their hostility to the Israelites on leaving Egypt (1 Sam. xv. 2), Saul invaded their country with an army of 210,000 men, and 'utterly destroyed (הררים), strangely taken for a proper name in the Sept.: πάντα τὸν λαὸν καὶ Τεγμῶ ἀπέκτεινεν) all the people with the edge of the sword;' but he preserved their king Agag alive, and the best of the cattle, and by this act of disobedience forfeited the regal authority over Israel. Josephus states the number of Saul's army to be 400,000 men of Israel and 30,000 of Judah. He also represents Saul as besieging and taking the cities of the Amalekites, 'some by warlike machines, some by mines dug underground, and by building walls on the outside; some by famine and thirst, and some by other methods' (*Antiq.* vi. 7, § 2). About twenty years later they were attacked by David during his residence among the Philistines (1 Sam. xxvii.). It is said 'that he smote the land and left neither man nor woman alive;' this language must be taken with some limitation, for shortly after the Amalekites were sufficiently recovered from their defeat to make reprisals, and burnt Ziklag with fire (1 Sam. xxx.). David, on his return from the camp of Achish, surprised them while celebrating their success, 'eating, and drinking, and dancing,' and 'smote them from twilight even unto the evening of the next day, and there escaped not a man of them save 400 young men which rode upon camels, and fled' (1 Sam. xxx. 17). At a later period, we find that David dedicated to the Lord the silver and gold of Amalek and other conquered nations (2 Sam. viii. 12). The last notice of the Amalekites as a nation is in 1 Chron. iv. 43, from which we learn that in the days of Hezekiah, king of Judah, 500 men of the sons of Simeon 'went to Mount Seir, and smote the rest of the Amalekites that were escaped.'

In the book of Esther, Haman is called the Agagite, and was probably a descendant of the royal line (Num. xxiv. 7; 1 Sam. xv. 8). Josephus says that he was by birth an Amalekite (*Antiq.* xi. 6, § 5).

The editor of Calmet supposes that there were no less than three distinct tribes of Amalekites.—1. Amalek the ancient, referred to in Gen. xiv.; 2. A tribe in the region east of Egypt, between Egypt and Canaan (Exod. xvii. 8; 1 Sam. xv. &c.); 3. Amalek, the descendants of Eliphaz. No such distinction, however, appears to be made in the Biblical narrative; the national character is everywhere the same, and the different localities in which we find the Amalekites may be easily explained by their habits, which evidently were such as belong to a warlike nomade people. Le Clerc was one of the first critics who advocated the existence of more than one Amalek. Hengstenberg infers from 1 Chron. iv. 42, 43, that in a wider sense Amalekites might be considered as belonging to Idumæa, and urges, in behalf of the descent of the Amalekites from the son of Eliphaz, the improbability that a people who acted so conspicuous a part in the Israelitish history should have their origin concealed, and be, as he terms it, 'ἀνεπαλόγγτος, contrary to the whole plan of the Pentateuch' (v. *Die Authentie,*

&c., ii. 303). Arabian writers mention *عماليق*, *عماليق*, *عماليق*, *Amalika*, *Amalik*, *Inlik*, as an aboriginal tribe of their country, descended from Ham (Abulfeda says from Shem), and more ancient than the Ishmaelites. They also give the same name to the Philistines and other Canaanites, and assert that the Amalekites who were conquered by Joshua passed over to North Africa. Philo (*Vita Moysis*, i. 39) calls the Amalekites who fought with the Israelites on leaving Egypt, Phœnicians (*Φοίνικες*). The same writer interprets the name Amalek as meaning 'a people that licks up or exhausts:' ὁ Ἄμαλῆκ, ὃς ἐρμηνεύεται λαὸς ἐκλείχων (*Legis Allegor.* iii. 66, *Lib. de Migr. Abr.* 26, *Cong. erud. grat.* 11).—J. E. R.

1. AMANA (אֲמָנָה), a mountain mentioned in Cant. iv. 8. Some have supposed it to be Mount Amanus in Cilicia, to which the dominion of Solomon is alleged to have extended northward. But the context, with other circumstances, leaves little doubt that this Mount Amana was rather the southern part or summit of Anti-Libanus, and was so called perhaps from containing the sources of the river Amana [ABANA].

2. AMANA, a river of Damascus [ABANA].

1. AMARIAH (אֲמָרְיָהּ, *word of Jehovah*; Sept. Ἀμαρία, Ἀμαρίας), mentioned in 1 Chron. vi. 7, in the list of the descendants of Aaron by his eldest son Eleazer. He was the son of Meraioth and the father of Ahitub, who was (not the grandson and successor of Eli of the same name, but) the father of that Zadok in whose person Saul restored the high-priesthood to the line of Eleazer. The years during which the younger line of Itamar enjoyed the pontificate in the persons of Eli, Ahitub, and Abimelech (who was slain by King Saul at Nob) doubtless more than cover the time of Amariah and his son Ahitub; and it is therefore sufficiently certain that they never were high-priests in fact, although their names are given to carry on the direct line of succession to Zadok.

2. AMARIAH, high-priest at a later period, the son of Azariah, and also father of a second Ahitub (1 Chron. vi. 11). In like manner, in the same list, there are three high-priests bearing the name of Azariah.

3. AMARIAH, great-grandfather of the prophet Zephaniah (*Zeph.* i. 1).

1. AMASA (אֲמָסָא, *a burden*; Sept. Ἀμασαφ), son of Abigail, a sister of king David. As his name does not occur prior to Absalom's rebellion (2 Sam. xvii. 25), he must have been neglected by David in comparison with Joab and Abishai, the sons of his other sister Zeruiah, who had before then been raised to great power and influence. This apparent estrangement may perhaps be connected with the fact that Abigail had married an Ishmaelite called Jether, who was the father of Amasa. This is the more likely, as the fact is pointedly mentioned (1 Chron. ii. 17), or covertly indicated (2 Sam. xvii. 25) whenever the name of Abigail occurs, whereas we are quite ignorant who was the husband of the other sister, Zeruiah, and father of her distinguished sons. We may thus form a conjecture of the grounds on which Amasa joined Absalom, and obtained the command of the rebel army. He was defeated

by his cousin Joab, who commanded the army of David. This transaction appears to have made David sensible of the neglect with which Amasa had been treated; and he eventually offered him not only pardon, but the command of the army in the room of Joab (2 Sam. xix. 13), whose overbearing conduct had become intolerable to him, and to whom he could not entirely forgive the death of Absalom. David, however, was too good a soldier himself to have made this offer, had not Amasa, notwithstanding his defeat, displayed high military qualities during his command of Absalom's army. But on the breaking out of Sheba's rebellion, Amasa was so tardy in his movements (probably from the reluctance of the troops to follow him), that David despatched Abishai with the household troops in pursuit of Sheba, and Joab joined his brother as a volunteer. When they reached 'the great stone of Gibeon,' they were overtaken by Amasa with the force he had been able to collect. Joab thought this a favourable opportunity of getting rid of so dangerous a rival, and immediately executed the treacherous purpose he had formed. He saluted Amasa, asked him of his health, and took his beard in his *right* hand to kiss him, while with the unheeded *left* hand he smote him dead with his sword. Joab then put himself at the head of the troops, and continued the pursuit of Sheba; and such was his popularity with the army, that David was unable to remove him from the command, or call him to account for this bloody deed: B.C. 1022 [ABNER; ABSALOM; JOAB].

2. AMASA, a chief of Ephraim, who, with others, vehemently resisted the retention as prisoners of the persons whom Pekah, king of Israel, had taken captive in a successful campaign against Ahaz, king of Judah (2 Chron. xxviii. 12).

AMASAI, the principal leader of a considerable body of men from the tribes of Judah and Benjamin, who joined David at Ziklag. The words with which David received them indicate some apprehension, which was instantly dissipated by a fervent declaration of attachment from Amasai (1 Chron. xii. 16-18).

AMATH, EMATH, or HAMATH, a city of Syria; the same with Emesa on the Orontes [HAMATH].

AMATHITIS, the district in Syria of which Amath or Hamath on the Orontes was the capital (1 Macc. xii. 25) [HAMATH].

AMATHUS (*Ἀμαθούς*), a fortified town beyond the Jordan, which the *Onomast.* (s. v. *Æmeth*) places 21 Roman miles south of Pella. It was taken by Alexander Jannæus (*Joseph. Bell. Jud.* i. 4, 2; *Antiq.* xiii. 13, 5), and its importance is shown by the fact that Gabinius made it the seat of one of the five jurisdictions (*συνέδρια*) into which he divided the country (*Antiq.* xiv. 5, 4; *Bell. Jud.* i. 8, 5). Josephus elsewhere (*Antiq.* xvii. 10, 6) mentions that a palace was burnt *ἐν Ἀμαθοῖς* on the Jordan, which was probably the same place.

1. AMAZIAH (אֲמַזְיָהּ, *strength of Jehovah*; Sept. *Ἀμεζίας*; Vulg. *Amasias*), son of Joash, and eighth king of Judah. He was 25 years old when he began to reign, and he reigned 29 years—from B.C. 838 to B.C. 809. He commenced his sovereignty by punishing the murderers of his father; and it is mentioned that he respected the law of Moses, by not including the children in the doom

of their parents, which seems to show that a contrary practice had previously existed. In the twelfth year of his reign Amaziah attempted to reimpose upon the Edomites the yoke of Judah, which they had cast off in the time of Jehoram. The strength of Edom is evinced by the fact that Amaziah considered the unaided strength of his own kingdom unequal to this undertaking, and therefore hired an auxiliary force of 100,000 men from the king of Israel for 100,000 talents of silver. This is the first example of a mercenary army that occurs in the history of the Jews. It did not, however, render any other service than that of giving Amaziah an opportunity of manifesting that he knew his true place in the Hebrew constitution, as the viceroy and vassal of the king JEHOVAH [KING]. A prophet commanded him, in the name of the Lord, to send back the auxiliaries, on the ground that the state of alienation from God in which the kingdom of Israel lay, rendered such assistance not only useless but dangerous. The king obeyed this seemingly hard command, and sent the men home, although by doing so he not only lost their services, but the 100,000 talents, which had been already paid, and incurred the resentment of the Israelites, who were naturally exasperated at the indignity shown to them. This exasperation they indicated by plundering the towns and destroying the people on their homeward march.

The obedience of Amaziah was rewarded by a great victory over the Edomites, ten thousand of whom were slain in battle and ten thousand more savagely destroyed by being hurled down from the high cliffs of their native mountains. But the Edomites afterwards were avenged; for among the goods which fell to the conqueror were some of their idols, which, although impotent to deliver their own worshippers, Amaziah betook himself to worship. This proved his ruin. Puffed up by his late victories, he thought also of reducing the ten tribes under his dominion. In this attempt he was defeated by king Joash of Israel, who carried him a prisoner to Jerusalem. Joash broke down great part of the city wall, plundered the city, and even laid his hands upon the sacred things of the temple. He, however, left Amaziah on the throne, but not without taking hostages for his good behaviour. The disasters which Amaziah's infatuation had brought upon Judah probably occasioned the conspiracy in which he lost his life. On receiving intelligence of this conspiracy he hastened to throw himself into the fortress of Lachish; but he was pursued and slain by the conspirators, who brought back his body 'upon horses' to Jerusalem for interment in the royal sepulchre (2 Kings xiv.; 2 Chron. xxiv.).

2. AMAZIAH, the priest of the golden calves at Bethel, in the time of Jeroboam II. He complained to the king of Amos's prophecies of coming evil, and urged the prophet himself to withdraw into the kingdom of Judah and prophesy there (Amos vii. 10-17).

AMBASSADOR. The relations of the Hebrews with foreign nations were too limited to afford much occasion for the services of ambassadors. Still, the long course of their history affords some examples of the employment of such functionaries, which enable us to discover the position which they were considered to occupy. Of ambassadors resident at a foreign court they had, of course, no notion; all the embassies of which we

and being 'extraordinary,' or for special services and occasions, such as to congratulate a king on his accession or victories, or to condole with him in his troubles (2 Sam. viii. 15; x. 2; 1 Kings v. 1), to remonstrate in the case of wrong (Judg. xi. 12), to solicit favours (Num. xx. 14), or to contract alliances (Josh. ix. 3, *sqq.*; 1 Macc. viii. 17).

The notion that the ambassador represented the person of the sovereign who sent him, or the dignity of the state from which he came, did not exist in ancient times in the same sense as now. He was a highly distinguished and privileged messenger, and the inviolability of his person (2 Sam. x. 1-5) was rather that of our heralds than of our ambassadors. It may have been owing, in some degree, to the proximity of all the nations with which the Israelites had intercourse, that their ambassadors were intrusted with few if any discretionary powers, and could not go beyond the letter of their instructions. In general their duty was limited to the delivering of a message and the receiving of an answer; and if this answer was such as required a rejoinder, they returned for fresh instructions, unless they had been authorized how to act or speak in case such an answer should be given.

The largest act performed by ambassadors appears to have been the treaty of alliance contracted with the Gibeonites (Josh. ix.), who were supposed to have come from 'a far country;' and the treaty which they contracted was in agreement with the instructions with which they professed to be furnished. In allowing for the effect of proximity, it must be remembered that the ancient ambassadors of other nations, even to countries distant from their own, generally adhered to the letter of their instructions, and were reluctant to act on their own discretion. Generals of armies must not, however, be confounded with ambassadors in this respect.

AMBER. [CHASML.]

AMBIDEXTER, one who can use the left hand as well as the right, or, more literally, one whose hands are both right hands. It was long supposed that both hands are naturally equal, and that the preference of the right hand, and comparative incapacity of the left, are the result of education and habit. But it is now known that the difference is really physical (see Bell's *Bridgewater Treatise on the Hand*), and that the ambidexterous condition of the hands is not a natural development.

The capacity of equal action with both hands was highly prized in ancient times, especially in war. Among the Hebrews this quality seems to have been most common in the tribe of Benjamin, as all the persons noticed as being endowed with it were of that tribe. By comparing Judg. iii. 15, xx. 16, with 1 Chron. xii. 2, we may gather that the persons mentioned in the two former texts as 'left-handed,' were really ambidexters. In the latter text we learn that the Benjamites who joined David at Ziklag were 'mighty men, helpers of the war. They were armed with bows, and could use both the right hand and the left in hurling [slinging] and shooting arrows out of a bow.' There were thirty of them; and as they appear to have been all of one family, it might almost seem as if the greater commonness of this power among the Benjamites arose from its being a hereditary peculiarity of certain families in that tribe. It may

also partly have been the result of cultivation; for although the left hand is not naturally an equally strong and ready instrument as the right hand, it may doubtless be often rendered such by early and suitable training.

AMBUSCADE and AMBUSH, in military phraseology, are terms used promiscuously, though it is understood that the first more properly applies to the act, and the second to the locality, of a stratagem which consists mainly in the concealment of an army, or of a detachment, where the enemy, if he ventures, in ignorance of the measure, within the sphere of its action, is suddenly taken at a disadvantage, and liable to be totally defeated. The principles which must guide the contrivers of an ambuscade have been nearly the same in all ages; embracing concealment from the observation of an enemy so as to create no suspicion; a position of advantage in case of being attacked by superior forces, and having the means of retreating, as well as of issuing forth to attack, without impediment, when the proper moment is arrived. The example of Joshua at the capture of Ai shows the art to have been practised among the Jews on the best possible principles. The failure of a first attempt was sure to produce increased confidence in the assailed, who, being the armed, but not disciplined, inhabitants of a strong place, were likely not to be under the control of much caution. Joshua, encamping within sight, but with a valley intervening, when he came up to make a false attack, necessarily appeared to disadvantage, the enemy being above him, and his retreat towards his own camp rendered difficult by its being likewise above him on the other side, and both sides no doubt very steep, as they are in general in the hills near Libanus. His men therefore fled, as directed, not towards the north, where the camp was, but eastward, towards the plain and desert; while in the hills, not behind, but on the west side, lay the ambuscade, in sufficient force alone to vanquish the enemy. This body of Israelites had not therefore the objectionable route to take from behind the city, a movement that must have been seen from the walls, and would have given time to close the gates, if not to warn the citizens back; but, rising from the woody hills, it had the shortest distance to pass over to come down directly to the gate; and, if an accident had caused failure in the army of Joshua, the detachment could not itself be intercepted before reaching the camp of the main body; while the citizens of Ai, pursuing down hill, had little chance of returning up to the gates in time, or of being in a condition to make an effectual onset. This example, as a military operation, may be cited as perfect in all its details. In the attempt to surprise Shechem (Judg. ix. 30, *sqq.*) the operation, so far as it was a military manoeuvre, was unskillfully laid, although ultimately successful in consequence of the party spirit within, and the intelligence which Abimelech maintained in the fortress.—C. H. S.

AMEN (אָמֵן; New Test. Ἀμήν). This word is strictly an adjective, signifying 'firm,' and, metaphorically, 'faithful.' Thus in Rev. iii. 14, our Lord is called 'the amen, the faithful and true witness.' In Isa. lxxv. 16, the Heb. has 'the God of amen,' which our version renders 'the God of truth,' i. e. of *fidelity*. In its ad-

verbal sense amen means *certainly, truly, surely*. It is used in the beginning of a sentence by way of emphasis—rarely in the Old Test. (Jer. xxviii. 6), but often by our Saviour in the New, where it is commonly translated ‘*verily*.’ In John’s gospel alone it is often used by him in this way double, *i. e.* ‘*verily, verily*.’ In the end of a sentence it often occurs singly or repeated, especially at the end of hymns or prayers, as ‘*amen and amen*’ (Ps. xli. 14; lxxii. 19; lxxxix. 53). The proper signification of it in this position is to confirm the words which have preceded, and invoke the fulfilment of them: ‘*so be it, fiat*; Sept. *γένοιτο*. Hence in oaths, after the priest has repeated the words of the covenant or imprecation, all those who pronounce the *amen* bind themselves by the oath (Num. v. 22; Deut. xxvii. 15, 17; Neh. v. 13; viii. 6; 1 Chron. xvi. 36; comp. Ps. cvi. 48).

AMETHYST (אֶמֶתֶשֶׁת; Sept. *Ἀμέθυστος*; Vulg. *Amethystus*), a precious stone, mentioned in Scripture as the ninth in the breastplate of the high-priest (Exod. xxviii. 19; xxxix. 12); and the twelfth in the foundations of the New Jerusalem (Rev. xxi. 20). The concurrence of various circumstances leave little doubt that the stone anciently known as the *amethyst* is really denoted by the Hebrew word; and as the stone so called by the ancients was certainly that which still continues to bear the same name, their identity may be considered as established.

The transparent gems to which this name is applied are of a colour which seems composed of a strong blue and deep red; and according as either of these prevails, exhibit different tinges of purple, sometimes approaching to violet, and sometimes declining even to a rose colour. From these differences of colour the ancients distinguished five species of the amethyst: modern collections afford at least as many varieties, but they are all comprehended under two species, the *Oriental Amethyst* and the *Occidental Amethyst*. These names, however, are given to stones of essentially different natures; which were, no doubt, anciently confounded in the same manner. The Oriental amethyst is very scarce, and of great hardness, lustre, and beauty. It is in fact a rare variety of the adamantine spar, or corundum. Next to the diamond, it is the hardest substance known. It contains about 90 per cent. of alumine, a little iron, and a little silica. Of this species, emery, used in cutting and polishing glass, &c., is a granular variety. To this species also belongs the sapphire, the most valuable of gems next to the diamond; and of which the Oriental amethyst is merely a violet variety. Like other sapphires, it loses its colour in the fire, and comes out with so much of the lustre and colour of the diamond, that the most experienced jeweller may be deceived by it.

The more common, or Occidental amethyst, is a variety of quartz, or rock crystal, and is found in various forms in many parts of the world, as India, Siberia, Sweden, Germany, Spain; and even in England very beautiful specimens of tolerable hardness have been discovered. This also loses its colour in the fire.

Amethysts were much used by the ancients for rings and cameos; and the reason given by

Pliny—because they were easily cut—‘*sculpturæ faciles*’ (*Hist. Nat.* xxxvii. 9), shows that the Occidental species is to be understood. The ancients believed that the amethyst possessed the power of dispelling drunkenness in those who wore or touched it, and hence its Greek name (‘*ab a privativo et μέθω ebrius sum*’—Martini, *Excurs.* p. 158). In like manner, the Rabbins derive its Jewish name from its supposed power of procuring dreams to the wearer. אֶמֶתֶשֶׁת signifying ‘*to dream*’ (Brückmann, *Abhandlung von der Edelsteine*; Hill’s *Theophrastus*, notes; Bochart, *Hieroz.*; Hillier, *Tract. de xii. Gemmis in Pector. Pontif. Hebræorum*; Winer, *Biblisches Realwörterbuch*; Rosenmüller, *Mineralogy*, &c. of the Bible).

1. AMINADAB (עֲמִי נָדִיב, *famulus principis*; Sept. *Ἀμιναδάβ*), one of the ancestors of David and of Christ (Matt. i. 4). He was the son of Aram, and the father of Naasson, and of Elisheba, who became the wife of Aaron (Exod. vi. 23).

2. AMINADAB, in Cant. vi. 12. The chariots of this Aminadab are mentioned as proverbial for their swiftness. Of himself we know nothing more than what is here glanced at, from which he appears to have been, like Jehu, one of the most celebrated charioteers of his day. In many MSS. the Hebrew term is divided into two words עֲמִי נָדִיב, *Ami nadib*; in which case, instead of the name of a person, it means ‘*of my willing*,’ or ‘*loyal people*.’ This division has been followed in the Syriac, by the Jews in their Spanish version, and by many modern translators; but, taken in this way, it is difficult to assign any satisfactory meaning to the passage. See *Good’s Song of Songs*, note on vi. 12.

AMIR (אִמִּיר; Sept. ἔπ’ ἄκρον μετεώρου in Isa. xvii. 6, and οἱ Ἀμορδαῖοι in ver. 9; Vulg. *summitate rami*; Auth. Vers. ‘*uppermost bough*’). The word occurs only in Isa. xvii. 6, 9. It has been usual to derive it from the Arabic *أمير*, and to take its signification from *أمير*, which means a general, or Emir, and hence, in the present text, the higher or upper branches of a tree. Gesenius admits



that this interpretation is unsatisfactory; and Lee, who regards it as very fanciful, endeavours (*Lex. in voce*) to establish that it denotes the caul or sheath in which the fruit of the date-palm is enveloped. According to this view he translates the verse thus: ‘*Two or three berries in the head (or upper part) of the caul (or pod, properly sheath), four or five in its fissures.*’ On this he remarks: ‘*עֲמִי* signifies any fissure, and is also applied to those of rocks. If, therefore, the word *אִמִּיר* signifies this caul or pod, the word *עֲמִי*, in the following context, applies well to its opening, but is quite unintelligible in any other sense.’ This is at least ingenious; and if it be admitted as a sound interpretation of a passage confessedly difficult, this text is to be regarded as affording the only

scriptural allusion to the fact that the fruit of the date-palm is, during its growth, contained in a sheath, which rends as the fruit ripens, and at first partially, and afterwards more fully, exposes its precocious contents [PALM].

AMMAN. [RABBAIL.]

AMMON. [No AMMON.]

AMMONITES (אֲמֹנִים, אֲמֹנִי; Sept. *οἱ Ἀμμων, Ἀμμωνῖται*), the descendants of the younger son of Lot (Gen. xix. 38). They originally occupied a tract of country east of the Amorites, and separated from the Moabites by the river Arnon. It was previously in the possession of a gigantic race called Zamzummins (Deut. ii. 20), 'but the Lord destroyed them before the Ammonites, and they succeeded them and dwelt in their stead.' The Israelites, on reaching the borders of the Promised Land, were commanded not to molest the children of Ammon, for the sake of their progenitor Lot. But, though thus preserved from the annoyance which the passage of such an immense host through their country might have occasioned, they showed them no hospitality or kindness; they were therefore prohibited from 'entering the congregation of the Lord' (i. e. from being admitted into the civil community of the Israelites) 'to the tenth generation for ever' (Deut. xxiii. 3). This is evidently intended to be a perpetual prohibition, and was so understood by Nehemiah (Neh. xiii. 1). The first mention of their active hostility against Israel occurs in Judges iii. 13: 'The king of Moab gathered unto him the children of Ammon and Amalek, and went and smote Israel.' About 140 years later we are informed that the children of Israel forsook Jehovah and served the gods of various nations, including those of the children of Ammon, and the anger of Jehovah was kindled against them, and he sold them into the hands of the Philistines and of the children of Ammon. The Ammonites crossed over the Jordan, and fought with Judah, Benjamin, and Ephraim, so that 'Israel was sore distressed.' In answer to Jephthah's messengers (Judg. xi. 12), the king of Ammon charged the Israelites with having taken away that part of his territories which lay between the rivers Arnon and Jabok, which, in Joshua xiii. 25, is called 'half the land of the children of Ammon,' but was in the possession of the Amorites when the Israelites invaded it; and this fact was urged by Jephthah, in order to prove that the charge was ill-founded. Jephthah 'smote them from Aroer to Minnith, even twenty cities, with a very great slaughter' (Judg. xi. 33; Joseph. *Antiq.* v. 7). The Ammonites were again signally defeated by Saul (b.c. 1095) (1 Sam. xi. 11), and, according to Josephus, their king Nahash was slain (*Antiq.* vi. 5). His successor, who bore the same name, was a friend of David, and died some years after his accession to the throne. In consequence of the gross insult offered to David's ambassadors by his son Hanun (2 Sam. x. 4; Joseph. *Antiq.* vii. 6), a war ensued, in which the Ammonites were defeated, and their allies the Syrians were so daunted 'that they feared to help the children of Ammon any more' (2 Sam. x. 19). In the following year David took their metropolis, Rabbah, and great abundance of spoil, which is probably mentioned by anticipation in 2 Sam. viii.

12 (2 Sam. x. 14; xii. 26-31; Joseph. *Antiq.* vii. 7). In the reign of Jehoshaphat (b.c. 896) the Ammonites joined with the Moabites and other tribes belonging to Mount Seir,* to invade Judah; but, by the divine interposition, were led to destroy one another. Jehoshaphat and his people were three days in gathering the spoil (2 Chron. xx. 25). The Ammonites 'gave gifts' to Uzziah (2 Chron. xxvi. 8), and paid a tribute to his son Jotham for three successive years, consisting of 100 talents of silver, 1000 measures of wheat, and as many of barley. When the two and a half tribes were carried away captive, the Ammonites took possession of the towns belonging to the tribe of Gad (Jerem. xlix. 1). 'Bands of the children of Ammon' and of other nations came up with Nebuchadnezzar against Jerusalem (b.c. 607), and joined in exulting over its fall (Ezek. xxv. 3, 6). Yet they allowed some of the fugitive Jews to take refuge among them, and even to intermarry (Jer. xl. 11; Neh. xiii. 13). On the return of the Jews from Babylon the Ammonites manifested their ancient hostility by deriding and opposing the rebuilding of Jerusalem (Neh. iv. 3, 7, 8). Both Ezra and Nehemiah expressed vehement indignation against those Jews who had intermarried with the heathen, and thus transgressed the divine command (Deut. vii. 3; Ezra x.; Neh. xiii. 25). Judas Maccabæus (b.c. 164) fought many battles with the Ammonites, and took Jazer with the towns belonging to it: τῆν Ἰαζήρ καὶ τὰς θυγατέρας αὐτῆς. Justin Martyr affirms that in his time the Ammonites were numerous: Ἀμμωνῖται ἔστι νῦν πολλὸν πλῆθος (*Dial. cum Tryph.* § 119). Origen speaks of their country under the general denomination of Arabia. Josephus says that the Moabites and Ammonites were inhabitants of Cœle-Syria (*Antiq.* i. 11, § 5).

Their national idol was Molech or Milcom, whose worship was introduced among the Israelites by the Ammonitish wives of Solomon (1 Kings xi. 5, 7); and the high places built by that sovereign for this 'abomination' were not destroyed till the reign of Josiah (b.c. 610) (2 Kings xxiii. 13).

Besides Nahash and Hanun, an Ammonitish

* In 2 Chron. xx. 1, it is said, 'It came to pass after this also, that the children of Moab and the children of Ammon, and with them [other] beside the Ammonites, came against Jehoshaphat to battle.' Auth. Vers. כְּהַעֲמוֹנִים would be correctly translated 'part (or some) of the Ammonites,' as in Exod. xvii. 5, מִכֹּזְבִי, 'some of the elders'; 2 Sam. xi. 17; Gen. xxxiii. 15, מִבְּנֵי הָעָם, 'some of the people.' But as the children of Ammon had already been mentioned, a doubt arises as to the correctness of the present reading. As the inhabitants of Mount Seir are joined with the Moabites and Ammonites, in verses 10, 22, 23, possibly the word מִזְהַדְמוֹת, 'some of the Edomites,' stood in the original text, or, by a slight transposition of two letters, we may read מִזְהַמְעֹנִים, 'some of the Mebunims;' Sept. ἐκ τῶν Μιναιῶν, a tribe mentioned in 2 Chron. xxvi. 7, ἐπὶ τοὺς Μιναιῶς. In the 8th verse, for 'the Ammonites gave gifts,' the Sept. reads ἔδωκαν οἱ Μιναιῶι δῶρα; v. Maurer, *Commentarius Grammaticus Criticus in Vet. Test.*, Lips. 1835, i. 210.

king Baalis (בַּעַלִים; Sept. Βελεισά and Βελισά) is mentioned by Jeremiah (xl. 14). Sixteen manuscripts read בַּעַלִים, Baalim; and Josephus, Βαάλειμ (*Antiq. x. 9, § 3*).

In the writings of the prophets terrible denunciations are uttered against the Ammonites on account of their rancorous hostility to the people of Israel; and the destruction of their metropolis, Rabbah, is distinctly foretold (Zeph. ii. 8; Jer. xlix. 1-6; Ezek. xxv. 1-5, 10; Amos i. 13-15). These passages will be more properly noticed under the article RABBATH.—J. E. R.

AMNON (אַמְנֹן, *faithful*), the eldest son of David, by Ahinoam of Jezreel. He was born at Hebron, about B.C. 1056. He is only known for his atrocious conduct towards his half-sister Tamar, which his full-brother Absalom revenged two years after, by causing him to be assassinated while a guest at his table, in B.C. 1032 (2 Sam. xiii.) [ABSALOM].

AMOMUM (ἀμμων). This word is only found in Rev. xviii. 13, and is even there omitted in some MSS., probably from the homœoteleuton. It denoted an odoriferous plant or seed, used in preparing precious ointment. It differed from the modern amomum of the druggists, but the exact species is not known (see Schleusner's and Robinson's Greek Lexicons).

AMON (אַמֹן, Jer. xlvi. 25) is the name of an Egyptian god, in whom the classical writers unanimously recognise their own Zeus and Jupiter. The primitive seat of his worship appears to have been at Meroë, from which it descended to Thebes, and thence, according to Herodotus (ii. 54), was transmitted to the Oasis of Siwah and to Dodona; in all which places there were celebrated oracles of this god. His chief temple



and oracle in Egypt, however, were at Thebes, a city peculiarly consecrated to him, and which is probably meant by the No and No Amon of the prophets. He is generally represented on Egyptian monuments by the seated figure of a man with a ram's head, or by that of an entire ram, and of a blue colour. In honour of him, the inhabitants of the Thebaid abstained from the flesh of sheep, but they annually sacrificed a ram to him and dressed his image in the hide. A religious reason for that ceremony is assigned by Herodotus (ii. 42); but Diodorus (iii. 72) ascribes his wearing horns to a more trivial cause. There appears to

be no account of the manner in which his oracular responses were given; but as a sculpture at Qarnâq, which Creuzer has copied from the *Description d'Égypte*, represents his portable tabernacle mounted on a boat and borne on the shoulders of forty priests, it may be conjectured, from the resemblance between several features of that representation and the description of the oracle of Jupiter Ammon in Diodorus, xvii. 50, that his responses were communicated by some indication during the solemn transportation of his tabernacle.

As for the power which was worshipped under the form of Amon, Macrobius asserts (*Saturnal. i. 21*) that the Libyans adored the setting sun under that of their Ammon; but he points to the connection between the ram's horns of the god and Aries in the Zodiac. Jablonski, however, has endeavoured to show that Amon represented the sun at the vernal equinox (*Pantheon, i. 165, sqq.*). This again has been questioned by Jomard (in the *Descript. d'Égypte*), who maintains that the ancient vernal equinox was in Taurus, and considers Amon to denote the overflow of the Nile at the autumnal equinox. The precise ground of this objection is not apparent; for the Egyptian year was movable, and in every 119 years the vernal equinox must have fallen in a different sign of the Zodiac (Ideler, *Handbuch der Chronologie, i. 94*). But Creuzer (*Symbolik, ii. 205*) still adheres to Jablonski's opinion; and the fact that Amon bears some relation to the sun seems placed beyond doubt by enchorial inscriptions, in which *Amon Ra* is found, *Ra* meaning *sun* (Kosegarten, *De Prisca Egyptiorum Literatura, p. 31*). F. S. de Schmidt also, in his essay *De Zodiaci Origine Egyptia, p. 33, sqq.* (inserted in his *Opuscula quibus Res Egyptiacæ illustrantur, Carlsruhe, 1765*), endeavours by other arguments to prove the connection between Amon and Aries. In doing this he points out the coincidence of the festival of Amon, and of the sacrifice of the ram, with the period and with the kind of offering of the Jewish Passover, as if the appointment of the Paschal lamb was in part intended to separate the Jews more entirely from the Egyptians. For this he not only cites the passage of Tacitus, *caso ariete velut in contumeliam Hammonis* (*Hist. v. 4*), but adduces an extract to the same effect from Rabbi Abrah. Seba; Bähr, however (in his *Symbolik des Mosaischen Cultus, ii. 641*), when objecting to Baur's attempt to draw a similar parallel between the festival of Amon and the Passover, justly remarks that the Hebrew text, besides allowing the Paschal offering to be a *kid*, always distinguishes between a male lamb and a *ram*, and that the latter is not the sacrifice of the Passover (*Ibid. p. 296*).

The etymology of the name is obscure. Eustathius says that, according to some, the word means *shepherd*. Jablonski proposed an etymology by which it would signify *producing light*; and Champollion, in his latest interpretation, assigned it the sense of *hidden*. There is little doubt that the pointed Hebrew text correctly represents the Egyptian name of the god, and, besides what may be gathered from the forms of the name in the classical writers, Kosegarten argues that the enchorial Amn was pronounced Amon, because names in which it forms a part are so written in Greek, as Ἀμωναρόθηρ. Moreover, Ἀμῶν and

Ἀμόν are found in Iamblicus and Plutarch; and the latter expressly says that the Greeks changed the native name into Ἀμμων.

There is no reason to doubt that the name of this god really occurs in the passage 'Behold, I will visit Amon of No,' in Jer. xlvi. 25. The context and all internal grounds are in favour of this view. The Sept. has rendered it by Ἀμμών, as it has also called No, in Ezek. xxx. 14, Διόσπολις. The Peshito likewise takes it as a proper name, as מִן does not exist in Syriac in the signification which it bears as a pure Hebrew word. The Targum of Jonathan and the Vulgate, however, have rendered the passage 'the multitude of Alexandria.' The reason of their taking מִן to mean 'multitude' may perhaps be found in the fact that, in Ezek. xxx. 15, we read הַרְמון, which does bear that sense. Nevertheless, modern scholars are more disposed to emend the latter reading by the former, and to find Amon, the Egyptian god, in both places.—J. N.

AMON (אֲמוֹן, *artificer*), son of Manasseh, and fourteenth king of Judah, who began to reign B.C. 644, and reigned two years. He appears to have derived little benefit from the instructive example which the sin, punishment, and repentance of his father offered; for he restored idolatry, and again set up the images which Manasseh had cast down. He was assassinated in a court conspiracy; but the people put the regicides to death, and raised to the throne his son Josiah, then but eight years old (2 Kings xxi. 19-26; 2 Chron. xxxiii. 21-25).

AMORITES (הַמְּאֹרִי; Sept. Ἀμορῆται), the descendants of one of the sons of Canaan: מְאֹרִי; Sept. τὸν Ἀμορῆταιον; Auth. Vers. the Emorite. They were the most powerful and distinguished of the Canaanitish nations. We find them first noticed in Gen. xiv. 7—'the Amorites that dwelt in Hazezon-tamar,' הַצִּצְנִן תְּמָר, *the cutting of the palm-tree*, afterwards called Engedi, עֵינֵי גֵדִי, *fountain of the kid*, a city in the wilderness of Judæa not far from the Dead Sea. In the promise to Abraham (Gen. xv. 21), the Amorites are specified as one of the nations whose country would be given to his posterity. But at that time three confederates of the patriarch belonged to this tribe; Mamre, Aner, and Eshcol (Gen. xiv. 13, 24). When the Israelites were about to enter the promised land, the Amorites occupied a tract on both sides of the Jordan. That part of their territories which lay to the east of the Jordan was allotted to the tribes of Reuben, Gad, and half the tribe of Manasseh. They were under two kings—Sihon, king of Heshbon (frequently called king of the Amorites), and Og, king of Bashan, who 'dwelt at Ashtaroth [and] in [at] Edrei,' בְּעִשְׂתָּרֹת בְּאֲדָרַעִי (Deut. i. 4, compared with Josh. xii. 4; xiii. 12). Before hostilities commenced messengers were sent to Sihon, requesting permission to pass through his land; but Sihon refused, and came to Jahaz and fought with Israel; and Israel smote him with the edge of the sword, and possessed his land from Amon (Modjeb) unto Jabbok (Zerka) (Num. xxi. 24). Og also gave battle to the Israelites at Edrei, and was totally defeated. After the capture of Ai, five kings of the Amorites, whose dominions lay within the allotment of the tribe of Judah, leagued together to wreak vengeance on the Gibeonites for having made a separate peace

with the invaders. Joshua, on being apprised of their design, marched to Gibeon and defeated them with great slaughter (Josh. x. 10). Another confederacy was shortly after formed on a still larger scale; the associated forces are described as 'much people, even as the sand upon the seashore in multitude, with horses and chariots very many' (Josh. xi. 4). Josephus says that they consisted of 300,000 armed foot-soldiers, 10,000 cavalry, and 20,000 chariots (*Antiq.* v. 1). Joshua came suddenly upon them by the waters of Merom (the lake Samachonites of Josephus, *Antiq.* v. 6, § 1, and the modern Bahrat-al-Hule), and Israel smote them until they left none remaining (Josh. xi. 8). Still, after their severe defeats, the Amorites, by means of their war-chariots and cavalry, confined the Danites to the hills, and would not suffer them to settle in the plains: they even succeeded in retaining possession of some of the mountainous parts 'The Amorites would (יָצָא) *obstinaverunt se*, J. H. Michaelis) dwell in Mount Heres in Aijalon, and in Shaalbm, yet the hand of the house of Joseph prevailed, so that they became tributaries. And the coast of the Amorites was from the going up to Akrabim, מַעְלֵה עֶקְרָבִים (*the steep of Scorpions*) from the rock and upwards' (Judg. i. 34-36). It is mentioned as an extraordinary circumstance that in the days of Samuel there was peace between Israel and the Amorites (1 Sam. vii. 14). In Solomon's reign a tribute of bond-service was levied on the remnant of the Amorites and other Canaanitish nations (1 Kings ix. 21; 2 Chron. viii. 8).

A discrepancy has been supposed to exist between Deut. i. 44, and Num. xiv. 45, since in the former the *Amorites* are said to have attacked the Israelites, and in the latter the *Amalekites*; the obvious explanation is, that in the first passage the Amalekites are not mentioned, and the Amorites stand for the Canaanites in the second passage. From the language of Amos (ii. 9) it has been inferred that the Amorites in general were men of extraordinary stature, but perhaps the allusion is to an individual, Og, king of Bashan, who is described by Moses as being the last 'of the remnant of the giants.' His bedstead was of iron, 'nine cubits in length and four cubits in breadth' (Deut. iii. 21). Though the Gibeonites in Josh. ix. 7, are called *Hivites*, yet in 2 Sam. xxi. 2, they are said to be 'of the remnant of the *Amorites*,' probably because they were descended from a common stock, and were in subjection to an Amoritish prince, as we do not read of any king of the Hivites.—J. E. R.

AMOS (עָמוֹס), *carried, or a burden*; one of the twelve minor prophets, and a contemporary of Isaiah and Hosea. Gesenius conjectures that the name may be of Egyptian origin, and the same as Amasis or Amosis, which means *son of the moon* (v. Gesenii *Thesaur. s. v.* עָמוֹס and מִשָּׁח). He was a native of Tekoah, about six miles S. of Bethlehem, inhabited chiefly by shepherds, to which class he belonged, being also a dresser of sycamore-trees. Though some critics have supposed that he was a native of the kingdom of Israel, and took refuge in Tekoah when persecuted by Amaziah; yet a comparison of the passages Amos i. 1; vii. 14, with Amaziah's language vii. 12, leads us to

believe that he was born and brought up in that place. The period during which he filled the prophetic office was of short duration, unless we suppose that he uttered other predictions which are not recorded. It is stated expressly that he prophesied in the days of Uzziah, king of Judah, and in the days of Jeroboam, the son of Joash, king of Israel, two years before the earthquake (Amos i. 1). As Jeroboam died in the fifteenth year of Uzziah's reign, this earthquake, to which there is an allusion in Zechariah (xiv. 5), could not have happened later than the seventeenth year of Uzziah. Josephus indeed (*Antiq.* ix. 10) and some other Jewish writers represent the earthquake as a mark of the divine displeasure against Uzziah (in addition to his leprosy) for usurping the priest's office. This, however, would not agree with the sacred narrative, which informs us that Jotham, his son, acted as regent during the remainder of his reign, was twenty-five years old when he became his successor, and consequently was not born till the twenty-seventh year of his father's reign. As Uzziah and Jeroboam were contemporaries for about fourteen years, from B.C. 798 to 784, the latter of these dates will mark the period when Amos prophesied.

In several of the early Christian writers, Amos the prophet is confounded with Amoz (אַמוֹז), the father of Isaiah. Thus Clement of Alexandria (*Strom.* i. 21, § 118), *προφητεύουσι δὲ ἐν αὐτοῦ Ἀμὸς καὶ Ἡσαΐας ὁ υἱὸς αὐτοῦ*: this mistake arose from their ignorance of Hebrew, and from the name Ἀμὸς being applied to both in the Septuagint. In our Authorized Version the names are, as above, correctly distinguished, though, strange to say, some commentators have asserted that the two individuals are named alike.

When Amos received his commission, the kingdom of Israel, which had been 'cut short' by Hazael (2 Kings x. 33) towards the close of Jehu's reign, was restored to its ancient limits and splendour by Jeroboam the Second (2 Kings xiv. 25). But the restoration of national prosperity was followed by the prevalence of luxury, licentiousness, and oppression, to an extent that again provoked the divine displeasure, and Amos was called from the sheep-folds to be the harbinger of the coming judgments. Not that his commission was limited entirely to Israel. The thunder-storm (as Rückert poetically expresses it) rolls over all the surrounding kingdoms, touches Judah in its progress, and at length settles upon Israel. Chap. i.; ii. 1-5, form a solemn prelude to the main subject; nation after nation is summoned to judgment, in each instance with the striking idiomatic expression (similar to that in Proverbs xxx. 15, 18, 21, and to the *τρίς καὶ τετράκις, the terque quaterque* of the Greek and Roman poets), 'For three transgressions—and for four—I will not turn away the punishment thereof.' Israel is then addressed in the same style, and in chap. iii. (after a brief rebuke of the twelve tribes collectively) its degenerate state is strikingly portrayed, and the denunciations of divine justice are intermingled, like repeated thunder-claps, to the end of chap. vi. The seventh and eighth chapters contain various symbolical visions, with a brief historical episode (vii. 10-17). In the ninth chapter the majesty of Jehovah and the terrors of his justice are set forth with a sublimity of diction which

rivals and partly copies that of the royal Psalmist (comp. vers. 2, 3, with Ps. cix., and ver. 6 with Ps. civ.). Towards the close the scene brightens, and from the eleventh verse to the end the promises of the divine mercy and returning favour to the chosen race are exhibited in imagery of great beauty taken from rural life.

The allusions in the writings of this prophet are numerous and varied; they refer to natural objects, as in iii. 4, 8; iv. 7, 9; v. 8; vi. 12; ix. 3: to historical events, i. 9, 11, 13; ii. 1; iv. 11; v. 26: to agricultural or pastoral employments and occurrences, i. 3; ii. 13; iii. 5, 12; iv. 2, 9; v. 19; vii. 1; ix. 9, 13, 15: and to national institutions and customs, ii. 8; iii. 15; iv. 4; v. 21; vi. 4-6, 10; viii. 5, 10, 14.

Some peculiar expressions occur; such as 'cleanness of teeth,' a parallelism to 'want of bread,' vi. 6. 'God of Hosts' is found only in Amos and the Psalms. 'The high places of Isaac,' vii. 9; 'the house of Isaac,' vii. 16. 'He that createth the wind,' iv. 13. In the orthography there are a few peculiarities, as מְתַבֵּב for מְתַעֵב, vi. 8; בּוֹשֵׁטִים for בּוֹשְׁטִים, v. 11; יִשְׁחַק for יִשְׁחַק (found also in Ps. cv., and Jerem. xxxiii.).

The evidence afforded by the writings of this prophet that the existing religious institutions both of Judah and Israel (with the exception of the corruptions introduced by Jeroboam) were framed according to the rules prescribed in the Pentateuch, and the argument hence arising for the genuineness of the Mosaic records, are exhibited very lucidly by Dr. Hengstenberg in the second part of his *Beiträge zur Einleitung ins Alte Testament* (Contributions to an Introduction to the Old Testament)—*Die Authentie des Pentateuches* (The Authenticity of the Pentateuch), i. p. 83-125.

The canonicity of the book of Amos is amply supported both by Jewish and Christian authorities. Philo, Josephus, and the Talmud include it among the minor prophets. It is also in the catalogues of Melito, Jerome, and the 60th canon of the Council of Laodicea. Justin Martyr, in his *Dialogue with Trypho* (§ 22), quotes a considerable part of the 5th and 6th chapters, which he introduces by saying, *ἀκούσατε πῶς περὶ τούτων λέγει διὰ Ἀμὸς ἐνὸς τῶν δώδεκα*—'Hear how he speaks concerning these by Amos, one of the twelve.' There are two quotations from it in the New Testament: the first (v. 25, 26) by the proto-martyr Stephen, Acts vii. 42; the second (ix. 11) by the apostle James, Acts xv. 16.—J. E. R.

AMOSIS, an Egyptian monarch, the founder of the eighteenth dynasty, who ascended the throne in B.C. 1575. The period of his accession, and the change which then took place in the reigning family, strongly confirm the opinion of his being the 'new king who knew not Joseph' (Exod. i. 8); and if it be considered that he was from the distant province of Thebes, it is reasonable to expect that the Hebrews would be strangers to him, and that he would be likely to look upon them with the same distrust and contempt with which the Egyptians usually regarded foreigners (Wilkinson's *Anc. Egyptians*, i. 48; also Sharpe's *Early Hist. of Egypt*, pp. 12, 48) [EGYPT].

AMPHIPOLIS (Ἀμφίπολις), a city of Greece, through which Paul and Silas passed on their way from Philippi to Thessalonica (Acts xvii. 1). It

was situated on the left bank of the river Strymon, just below its egress from the lake Keikine (now Takino), and about three miles above its influx into the sea. This situation upon the banks of a navigable river, a short distance from the sea, with the vicinity of the woods of Keikine, and the gold-mines of Mount Pangæus, rendered Amphipolis a place of much importance, and an object of contest between the Thracians, Athenians, Lacedæmonians, and Macedonians, to whom it successively belonged. It has long been in ruins; and a village of about one hundred houses, called Jeni-keui, now occupies part of its site (Thucyd. i. 100; iv. 102, sq.; Herod. vii. 117; Diod. Sic. xvi. 8; Appian. iv. 104, sq.; Plin. iv. 17; Liv. xlv. 29; Cellar. *Notit.* i. 1053, sq.).

AMRAM, son of Kobath, of the tribe of Levi. He married his father's sister Jochebad, by whom he had Aaron, Miriam, and Moses. He died in Egypt, at the age of 137 years (Exod. vi.).

AMRAPHEL, king of Shinar, one of the four kings who invaded Palestine in the time of Abraham (Gen. xiv. 1, 2, sq.) [ABRAHAM; CHE-DORLAOMER].

AMULET (probably from the Arabic *حالة*, a pendant; Isa. iii. 20, לחשים; Talm. קסעוֹת). From the earliest ages the Orientals have believed in the influences of the stars, in spells, witchcraft, and the malign power of the evil eye; and to protect themselves against the maladies and other evils which such influences were supposed to occasion, almost all the ancient nations wore amulets (Plin. *Hist. Nat.* xxx. 15). These amulets consisted, and still consist, chiefly of tickets inscribed with sacred sentences (Shaw, i. 365; Lane's *Mod. Egypt.* ii. 365), and of certain stones (comp. Plin. *Hist. Nat.* xxxvii. 12, 31) or pieces of metal (Richardson, *Dissertation*; D'Arvieux, iii. 208; Chardin, i. 243, sqq.; iii. 205 sqq.; Niebuhr, i. 65; ii. 162). Not only were persons thus protected, but even houses were, as they still are, guarded from supposed malign influences by certain holy inscriptions upon the doors.

schedules being noticed elsewhere [MEZUZOTH], we here limit our attention to personal amulets. By this religious appropriation the then all-pervading tendency to idolatry were in this matter obviated, although in later times, when the tendency to idolatry had passed away, such written scrolls degenerated into instruments of superstition.

The לחשים of Isa. iii. 20 (Sept. περιδέξια; Vulg. *inaures*; Auth. Vers. *earrings*), it is now allowed, denote amulets, although they served also the purpose of ornament. They were probably precious stones, or small plates of gold or silver, with sentences of the law or magic formulæ inscribed on them, and worn in the ears, or suspended by a chain round the neck. 'Earrings' is not perhaps a bad

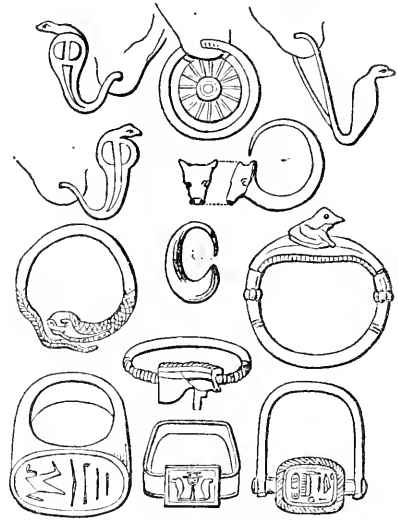

[Egyptian Ring and Earring Amulets.]

translation. It is certain that earrings were sometimes used in this way as instruments of superstition, and that at a very early period, as in Gen. xxxv. 4, where Jacob takes away the earrings of his people along with their false gods. Earrings, with strange figures and characters, are still used as charms in the East (Chardin, in Harmer, iii. 314). Augustin speaks strongly against earrings that were worn as amulets in his time (*Epist.* 75, *ad Pos.*). Schroeder, however, deduces from the Arabic that these amulets were in the form of serpents, and similar probably to those golden amulets of the same form which the women of the pagan Arabs wore suspended between their breasts, the use of which was interdicted by Mohammed (Schroeder, *De Vestitu Mulierum*, cap. xi. pp. 172, 173; Grotefend, art. *Amulette*, in Ersch and Gruber's *Encyclop.*; Rosenmüller, *ad Isa.* iii. 20; Gesenius, *ad eund.*; and in his *Thesaurus*, art. לחשים).

That these *lechashim* were charms inscribed on silver and gold was the opinion of Aben Ezra. The Arabic has *bozes* of amulets, manifestly concluding that they were similar to those ornamental little cases for written charms which are still used by Arab women. This is represented in the first figure of cut 1. Amulets of this kind

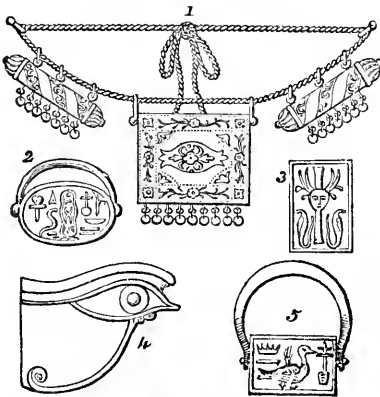

1. Modern Oriental. 2, 3, 4, 5 Ancient Egyptian.

The previous existence of these customs is implied in the attempt of Moses to turn them to becoming uses, by directing that certain passages extracted from the law should be employed (Exod. xiii. 9, 16; Deut. vi. 8; xi. 18). The door-

are called *hhegab*, and are specially adapted to protect and preserve those written charms, on which the Moslems, as did the Jews, chiefly rely. The writing is covered with waxed cloth, and enclosed in a case of thin embossed gold or silver, which is attached to a silk string, or a chain, and generally hung on the right side, above the girdle, the string or chain being passed over the left shoulder. In the specimen here figured there are three of these *hhegabs* attached to one string. The square one in the middle is almost an inch thick, and contains a folded paper; the others contain scrolls. Amulets of this shape, or of a triangular form, are worn by women and children; and those of the latter shape are often attached to children's head-dress (Lane's *Modern Egyptians*, ii. 365).

The superstitions connected with amulets grew to a great height in the later periods of the Jewish history. 'There was hardly any people in the whole world,' says Lightfoot (*Hor. Hebr. ad Matt.* xxiv. 24), 'that more used or were more fond of amulets, charms, mutterings, exorcisms, and all kinds of enchantments. . . . The amulets were either little roots hung about the neck of sick persons, or, what was more common, bits of paper (and parchment), with words written on them, whereby it was supposed that diseases were either driven away or cured. They wore such amulets all the week, but were forbidden to go abroad with them on the Sabbath, unless they were 'approved amulets,' that is, were prescribed by a person who knew that at least three persons had been cured by the same means. In these amulets mysterious names and characters were occasionally employed, in lieu of extracts from the law. One of the most usual of these was the cabalistic hexagonal figure known as "the shield of David" and "the seal of Solomon"' (Bartolocc. *Bibliotheca Rabbinica*, i.

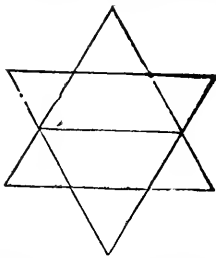

376; Lakemacher, *Observatt. Philol.* ii. 143, *egg.*). The reputation of the Jews was so well established in this respect, that even in Arabia, before the time of Mohammed, men applied to them when they needed charms of peculiar virtue (*Mischat-ul-Masabih*, ii. 377).

ANAB (אנב), one of the cities in the mountains of Judah, from which Joshua expelled the Anakim (Josh. xi. 21; xv. 15). From Main (the Maon of Scripture) Dr. Robinson (*Researches*, ii. 195) observed a place of this name, distinguished by a small tower.

ANAH (אנח; Sept. 'Ard), son of Zibeon the Hivite, and father of Esau's wife Aholibamah (*Gen.* xxxvi. 24). While feeding asses in the desert he discovered 'warm springs' (*aque calidæ*), as the original אֲנַחִי is rendered by Jerome, who states that the word had still this signification

in the Punic language. Gesenius and most modern critics think this interpretation correct, supported as it is by the fact that warm springs are still found in the region east of the Dead Sea. The Syriac has simply 'waters,' which Dr. Lee seems to prefer. Most of the Greek translators retain the original as a proper name *Iaquêmu*, probably not venturing to translate. The Samaritan text, followed by the Targums, has 'Emims,' *giants*. One version of 'mules' is now generally abandoned, but is supported by the Arabic and Veneto-Greek versions.

ANAKIM (אֲנָכִים), or BENEI-ANAK (בְּנֵי אֲנָכִים) and BENEI-ANAKIM (בְּנֵי אֲנָכִים), a wandering nation of southern Canaan, descended from Anak, whose name it bore (Josh. xi. 21). It was composed of three tribes, descended from and named after the three sons of Anak—Ahiman, Sesai, and Talmai. When the Israelites invaded Canaan, the Anakim were in possession of Hebron, Debir, Anak, and other towns in the country of the south. Their formidable stature and appearance alarmed the Hebrew spies; but they were eventually overcome and expelled by Caleb, when the remnant of the race took refuge among the Philistines (*Num.* xiii. 23; *Deut.* ix. 2; *Josh.* xi. 21; xiv. 12; *Judg.* i. 20). This favours the opinion of those who conclude that the Anakim were a tribe of Cushite wanderers from Babel, and of the same race as the Philistines, the Phœnicians, the Philitine, and the Egyptian shepherd-kings.

ANAMME/LECH (אֲנַמְמֵלֶחַ, 2 Kings xvii. 31) is mentioned, together with Adrammelech, as a god of the people of Sepharvaim, who colonized Samaria. He was also worshipped by the sacrifice of children by fire. No satisfactory etymology of the name has been discovered. Hyde (*Rel. Vet. Persar.* p. 128) considers the first part of the word to be the Aramaean אֲנַמְמֵ *or* אֲנַמְמֵ *sheep*, and the latter to be *king* (although, from his rendering the compound *Peeus Rex*, it is not at all clear in what relation he considered the two elements to stand to each other). He takes the whole to refer to the constellation Cepheus, or to that part of it in which are the stars called by the Arabs the shepherd and the sheep (*ar Râ'i wal Ganam*), which Ulug Beg terms the stars of the flock (*Kawâkib ul Firq*). This theory is erroneously stated both by Gesenius and Winer (by the former in his *Thesaurus*, and by the latter in his *Realwörterbuch*), who make out that the constellation Cepheus itself is called by the Arabs the shepherd and his sheep. Hyde certainly does not say so; and al Qazwîni (in Ideler's *Untersuchungen über die Sternnamen*, p. 42) expressly assigns the name of 'the shepherd' to the star in the left foot of Cepheus; that of 'the sheep' (*al Agnâm*, as he calls it) to those between his feet; and that of 'the flock' to the one on his right shoulder. The most that can be said of Hyde's theory is, that it is not incompatible with the astrology of the Assyrians. Gesenius, in the etymology he proposes, considers the first part of the name to be the Arabic *çanam*, 'image,' with a change of 'ç' into 'ç', which is not unusual in Aramaic (see Ewald's *Hebr. Grammar*, §. 106). The latest etymology proposed is that by Benfey (*Monatsnamen einiger älter Völker*, p. 188), who suggests that the first part of the word may be

an abbreviation of the name of the Persian goddess *Anahit*, or of that of the Ized *Aniran*. The same obscurity prevails as to the form under which the god was worshipped. The Babylonian Talmud states that his image had the figure of a horse; but Kimchi says that of a pheasant, or quail (Carpov's *Apparatus*, p. 516).—J. N.

ANANIAS, son of Nebedæus, was made high-priest in the time of the procurator Tiberius Alexander, about A.D. 47, by Herod, king of Chalcis, who for this purpose removed Joseph, son of Camydus, from the high-priesthood (Joseph. *Antiq.* xx. 5, 2). He held the office also under the procurator Cumanus, who succeeded Tiberius Alexander. Being implicated in the quarrels of the Jews and Samaritans, Ananias was, at the instance of the latter (who, being dissatisfied with the conduct of Cumanus, appealed to Ummidius Quadratus, president of Syria), sent in bonds to Rome, to answer for his conduct before Claudius Cæsar. The emperor decided in favour of the accused party. Ananias appears to have returned with credit, and to have remained in his priest-hood until Agrippa gave his office to Ismael, the son of Tabi (*Antiq.* xx. 8, 8), who succeeded a short time before the departure of the procurator Felix, and occupied the station also under his successor Festus. Ananias, after retiring from his high-priesthood, 'increased in glory every day' (*Antiq.* xx. 1, 2), and obtained favour with the citizens, and with Albinus, the Roman procurator, by a lavish use of the great wealth he had hoarded. His prosperity met with a dark and painful termination. The assassins (*sicarii*), who played so fearful a part in the Jewish war, set fire to his house in the commencement of it, and compelled him to seek refuge by concealment; but being discovered in an aqueduct, he was captured and slain (*Antiq.* xx. 9, 2; *Bell. Jud.* ii. 17, 9).

It was this Ananias before whom Paul was brought, in the procuratorship of Felix (Acts xxiii.). The noble declaration of the apostle, 'I have lived in all good conscience before God until this day,' so displeased him, that he commanded the attendant to smite him on the face. Indignant at so unprovoked an insult, the apostle replied, 'God shall smite thee, thou whited wall: ' a threat which the previous details serve to prove wants not evidence of having taken effect. Paul, however, immediately restrained his anger, and allowed that he owed respect to the office which Ananias bore. After this hearing Paul was sent to Cæsarea, whither Ananias repaired, in order to lay a formal charge against him before Felix, who postponed the matter, detaining the apostle meanwhile, and placing him under the supervision of a Roman centurion (Acts xxiv.).—J. R. B.

ANANIAS, a Christian belonging to the infant church at Jerusalem, who, conspiring with his wife Sapphira to deceive and defraud the brethren, was overtaken by sudden death, and immediately buried. The Christian community at Jerusalem appear to have entered into a solemn agreement, that each and all should devote their property to the great work of furthering the gospel and giving succour to the needy. Accordingly they proceeded to sell their possessions, and brought the proceeds into the common stock of the church. Thus Barnabas (Acts iv. 36, 37) 'having land, sold it, and brought the money,

and laid it at the apostles' feet.' The apostles then had the general disposal, if they had not also the immediate distribution, of the common funds. The contributions, therefore, were designed for the sacred purposes of religion (Acts v. 1-11).

As all the members of the Jerusalem church had thus agreed to hold their property in common, for the furtherance of the holy work in which they were engaged, if any one of them withheld a part, and offered the remainder as the whole, he committed two offences—he defrauded the church, and was guilty of falsehood: and as his act related not to secular but to religious affairs, and had an injurious bearing, both as an example, and as a positive transgression against the Gospel while it was yet struggling into existence; Ananias lied not unto man, but unto God, and was guilty of a sin of the deepest dye. Had Ananias chosen to keep his property for his own worldly purposes, he was at liberty, as Peter intimates, so to do; but he had in fact alienated it to pious purposes, and it was therefore no longer his own. Yet he wished to deal with it in part as if it were so, showing at the same time that he was conscious of his misdeed, by presenting the residue to the common treasury as if it had been his entire property. He wished to satisfy his selfish cravings, and at the same time to enjoy the reputation of being purely disinterested, like the rest of the church. He attempted to serve God and Mammon. The original, *ενοσπίρατο*, is much more expressive of the nature of his misdeed than our common version, 'kept back' (part of the price). The Vulgate renders it 'fraudavit'; and both Wiclif and the Rheims version employ a corresponding term, 'defraudid,' 'defrauded.' In the only other text of the New Testament where the word is found (Tit. ii. 10), it is translated 'purloining.' It is, indeed, properly applied to the conduct of persons who appropriate to their own purposes money destined for public uses.

It is the more important to place the crime of Ananias and his wife in its true light, because unjust reflections have been cast upon the apostle Peter (Wolfenb. *Fragm. Zweek Jesu*, p. 256) for his conduct in the case. Whatever that conduct may have been, the misdeed was of no trivial kind, either in itself or in its possible consequences. If, then, Peter reproves it with warmth, he does no more than nature and duty alike required; nor does there appear in his language on the occasion any undue or uncalled for severity. He sets forth the crime in its naked heinousness, and leaves judgment in the hands of Him to whom judgment belongs.

With strange inconsistency on the part of those who deny miracles altogether, unbelievers have accused Peter of cruelly smiting Ananias and his wife with instant death. The sacred narrative, however, ascribes to Peter nothing more than a spirited exposure of their aggravated offence. Their death, the reader is left to infer, was by the hand of God; nor is any ground afforded in the narrative (Acts v. 1-11) for holding that Peter was in any way employed as an immediate instrument of the miracle.

That the death of these evil-doers was miraculous seems to be implied in the record of the transaction, and has been the general opinion of the church. An attempt, however (*Ammon. Krit. Journ. d. Theol. Lit.* i. 249), has been made to explain the fact

by the supposition of apoplexy, caused by the shame and disgrace with which the guilty pair were suddenly overwhelmed at the detection of their baseness. If such an hypothesis might account for the death of Ananias, it could scarcely suffice to explain that of his wife also; for that two persons should be thus taken off by the same physical cause is, in the circumstances, in the highest degree improbable. A mathematical calculation of the doctrine of chances in the case would furnish the best exposure of this anti-supernatural explanation.

The view now given may serve also to show how erroneous is the interpretation of those who, like Tertullian, have maintained that the words of Peter were a species of excommunication which the chief of the apostles fulminated against Ananias and his wife. The thunders of a corrupt church find no sanction in the sacred record.

The early Christian writers were divided as to the condition of Ananias and Sapphira in the unseen world. Origen, in his treatise on Matthew, maintains that, being purified by the punishment they underwent, they were saved by their faith in Jesus. Others, among whom are Augustin and Basil, argue that the severity of their punishment on earth showed how great their criminality had been, and left no hope for them hereafter:—*pariter et vitam perdidierunt et salutem.*—J. R. B.

ANANIAS, a Christian of Damascus (Acts ix. 10; xxii. 12), held in high repute, to whom the Lord appeared in a vision, and bade him proceed to 'the street which is called Straight, and inquire in the house of Judas for one called Saul of Tarsus: for, behold, he prayeth.' Ananias had difficulty in giving credence to the message, remembering how much evil Paul had done to the saints at Jerusalem, and knowing that he had come to Damascus with authority to lay waste the church of Christ there. Receiving, however, an assurance that the persecutor had been converted, and called to the work of preaching the Gospel to the Gentiles, Ananias went to Paul, and, putting his hands on him, bade him receive his sight, when immediately there fell from his eyes as it had been scales; and, recovering the sight which he had lost when the Lord appeared to him on his way to Damascus, Paul, the new convert, arose, and was baptized, and preached Jesus Christ.

Tradition represents Ananias as the first that published the Gospel in Damascus, over which place he was subsequently made bishop; but having roused, by his zeal, the hatred of the Jews, he was seized by them, scourged, and finally stoned to death in his own church.—J. R. B.

ANAPHA (ΑΝΑΦΑ; Sept. *χαράδριος*; Vulg. *caradryon* and *caradrium*; Eng. Vers. heron, Lev. xi. 19, and Deut. xiv. 18), an unclean bird, but the particular bird denoted by the Hebrew word has been much disputed. The kite, woodcock, curlew, peacock, parrot, crane, lapwing, and several others have been suggested. Since the word occurs but twice, and in both instances is isolated, no aid can be derived from a comparison of passages.

Recourse has consequently been had to etymology. The root *anaph* signifies to breathe, to snort, especially from *anger*, and thence, figuratively, *to be angry*. Parkhurst observes that 'as the heron is remarkable for its *angry* disposition,

especially when *hurt* or *wounded*, this bird seems to be most probably intended.' But this equally applies to a great number of different species of birds. Bochart supposes it may mean the *mountain falcon*, called *ἀνοραία* by Homer (*Odys.* i. 320), because of the similarity of the Greek word to the Hebrew. But if it meant *any* kind of *eagle* or *hawk*, it would probably have been reckoned with one or other of those species mentioned in the preceding verses. Perhaps, under all the circumstances, the *traditional* meaning is most likely to be correct, which it will now be attempted to trace.

The Septuagint renders the Hebrew word by *χαράδριος*. Jerome, who, though professing to translate from the Hebrew, was no doubt well acquainted with the Septuagint, adhered to the same word in a Latin form, *caradryon* and *caradrium*. The Greek and Roman writers, from the earliest antiquity, refer to a bird which they call *charadrius*. It is particularly described by Aristotle (*Hist. An.* vii. 7), and by *Ælian* (*Hist. An.* xv. 26). The latter naturalist derives its name from *χαράδρα*, a hollow or chasm, especially one which contains water, because, he says, the bird frequents such places. It is, moreover, certain, that by the Romans the *charadrius* was also called *icterus*, which signifies the jaundice, from a notion that patients affected with that disease were cured by looking at this bird, which was of a yellow colour (Pliny, xxiv.; Cæsar, *Annel.* iii. 5), and by the Greeks, *χλωπίων*; and in allusion to the same fabulous notion, *ΐκτερος* (Aristotle, *Hist. An.* ix. 13, 15, and 22; *Ælian*, *Hist. An.* iv. 47). These writers concur in describing a bird, sometimes of a yellow colour, remarkable for its voracity (from which circumstance arose the phrase *χαράδριου βλος*, applied to a glutton), migratory, inhabiting watery places, and especially mountain torrents and valleys.

Now, it is certain that the name *charadrius* has been applied by ornithologists to the same species of birds from ancient times down to the present age. Linnæus, under Order iv. (consisting of waders or shore birds), places the genus *Charadrius*; in which he includes all the numerous species of *plovers*. The ancient accounts may be advantageously compared with the following description of the genus from Mr. Selby's *British Ornithology*, ii. 230: 'The members of this genus are numerous, and possess a wide geographical distribution: species being found in every quarter of the globe. They visit the east about April. Some of them, during the greater part of the year, are the inhabitants of open districts and wide wastes, frequenting both dry and moist situations, and only retire toward the coasts during the severity of winter. Others are continually resident upon the banks and about the mouths of rivers (particularly where the shore consists of small gravel or shingle). They live on worms, insects, and their larvæ. The flesh of many that live on the coasts is unpalatable.'

The same writer describes one 'species, *charadrius pluvialis*, called the *golden plover* from its colour,' and mentions the well-known fact that this species, in the course of moulting, turns completely black. Analogous facts respecting the *charadrius* have been established by observations in every part of the globe, viz. that they are gregarious and migratory. The habits of the majority are

littoral. They obtain their food along the banks of rivers and the shores of lakes; 'like the gulls, they beat the moist soil with their pattering feet, to terrify the incumbent worms, yet are often found in deserts, in green and sedge meadows, or on *upland moors*.' Their food consists chiefly of mice, worms, caterpillars, insects, toads, and frogs; which of course places them among the class of birds ceremonially *unclean*.

On the whole, the preponderance of evidence derived from an unbroken chain of well ascertained facts, seems in favour of the conclusion that the Hebrew word *anapha* designates the numerous species of the *plover* (may not this be the genus of birds alluded to as the fowls of the mountain, Ps. l. 11: Isa. xviii. 6?). Various species of the genus are known in Syria and Palestine, as the *C. pluvialis* (golden plover, of

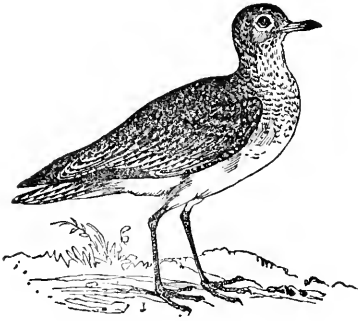

[*Charadrius pluvialis*—winter plumage.]

which a figure is here given), *C. ædicnemus* (stone-curlew), and *C. spinosus* (lapwing). (Kiito's *Physical Hist. of Palestine*, p. 106.) And, in connection with some of the preceding remarks, it is important to observe that in these species a yellow colour is more or less marked.—J. F. D.

ANATHEMA (*ἀνάθεμα*), literally anything laid up or suspended (from *ἀνατίθημι*, to lay up), and hence anything laid up in a temple, set apart as sacred. In this general sense the form employed is *ἀνάθημα*, a word of not unfrequent occurrence in Greek classic authors, and found once in the N. T., Luke xxi. 5. The form *ἀνάθεμα*, as well as its meaning, appears to be peculiar to the Hellenistic dialect (Valckenaer, *Schol.* tom. i. p. 593). The distinction has probably arisen from the special use made of the word by the Greek Jews. In the Septuagint, *ἀνάθεμα* is the ordinary rendering of the Hebrew word *חֵרֶם*, *cherem* (although in some instances it varies between the two forms, as in Lev. xxvii. 28, 29), and in order to ascertain its meaning it will be necessary to inquire into the signification of this word.

We find that the *חֵרֶם* was a person or thing consecrated or devoted irrevocably to God, and that it differed from anything merely vowed or sanctified to the Lord in this respect, that the latter could be redeemed (Lev. xxvii. 1-27), whilst the former was irreclaimable (Lev. xxvii. 21, 28): hence, in reference to living creatures, the devoted thing, whether man or beast, must be put to death (Lev. xxvii. 29). The prominent idea, therefore, which the word conveyed was that

of a person or thing devoted to destruction, or accursed. Thus the cities of the Canaanites were anathematized (Num. xxi. 2, 3), and after their complete destruction the name of the place was called Hormalah (הַרְמָלָה; Sept. *ἀνάθεμα*). Thus, again, the city of Jericho was made an anathema to the Lord (Josh. vi. 17), that is, every living thing in it (except Rahab and her family) was devoted to death; that which could be destroyed by fire was burnt, and all that could not be thus consumed (as gold and silver) was for ever alienated from man and devoted to the use of the sanctuary (Josh. vi. 24). The prominence thus given to the idea of a *thing accursed* led naturally to the use of the word in cases where there was no reference whatever to consecration to the service of God, as in Deut. vii. 26, where an idol is called *חֵרֶם*, or *ἀνάθεμα*, and the Israelites are warned against idolatry lest they should be anathema like it. In these instances the term denotes the object of the curse, but it is sometimes used to designate the curse itself (*e. g.* Deut. xx. 17, Sept.; comp. Acts xxiii. 14), and it is in this latter sense that the English word is generally employed.

In this sense, also, the Jews of later times use the Hebrew term, though with a somewhat different meaning as to the curse intended. The *חֵרֶם* of the Rabbins signifies excommunication or exclusion from the Jewish church. The more recent Rabbinical writers reckon three kinds or degrees of excommunication, all of which are occasionally designated by the generic term *חֵרֶם* (Elias Levita, in *Sepher Tisbi*). The first of these, *נָדוּי*, is merely a temporary separation or suspension from ecclesiastical privileges, involving, however, various civil inconveniences, particularly seclusion from society to the distance of four cubits. The person thus excommunicated was not debarred entering the temple, but instead of going in on the right hand, as was customary, he was obliged to enter on the left, the usual way of departure: if he died whilst in this condition there was no mourning for him, but a stone was thrown on his coffin to indicate that he was separated from the people and had deserved stoning. Buxtorf (*Lex. Chald., Talm. et Rabbin.*, col. 1304) enumerates twenty-four causes of this kind of excommunication: it lasted thirty days and was pronounced without a curse. If the individual did not repent at the expiration of the term (which, however, according to Buxtorf, was extended in such cases to sixty or ninety days), the second kind of excommunication was resorted to. This was called simply and more properly *חֵרֶם*. It could only be pronounced by an assembly of at least ten persons, and was always accompanied with curses. The formula employed is given at length by Buxtorf (*Lex.* col. 828). A person thus excommunicated was cut off from all religious and social privileges: it was unlawful either to eat or drink with him (compare I Cor. v. 11). The curse could be dissolved, however, by three common persons, or by one person of dignity. If the excommunicated person still continued impenitent, a yet more severe sentence was, according to the later Rabbins, pronounced against him, which was termed *שְׁמֵתָא* (Elias Levita, in *Tisbi*). It is described as a complete excision from the church and the giving up of the individual to the judgment of God and to

final perdition. There is, however, reason to believe that these three grades are of recent origin. The Talmudists frequently use the terms by which the first and last are designated interchangeably, and some Rabbinical writers (whom Lightfoot has followed in his *Horæ Hebr. et Talm.*, ad 1 Cor. v. 5) consider the last to be a lower grade than the second; yet it is probable that the classification rests on the fact that the sentence was more or less severe according to the circumstances of the case; and though we cannot expect to find the three grades distinctly marked in the writings of the N. T., we may not improbably consider the phrase ἀποσυνάγαγον ποιῶν, John xvi. 2 (comp. ix. 22; xii. 42), as referring to a lighter censure than is intended by one or more of the three terms used in Luke vi. 22, where perhaps different grades are intimated. The phrase παραδίδουαι τῷ σατανᾷ (1 Cor. v. 5; 1 Tim. i. 20) has been by many commentators understood to refer to the most severe kind of excommunication. Even admitting the allusion, however, there is a very important difference between the Jewish censure and the formula employed by the Apostle. In the Jewish sense it would signify the delivering over of the transgressor to final perdition, whilst the Apostle expressly limits his sentence to the 'destruction of the flesh' (i. e. the depraved nature), and resorts to it in order 'that the spirit may be saved in the day of the Lord Jesus.'

But whatever diversity of opinion there may be as to the degrees of excommunication, it is on all hands admitted that the term אָרֵר, with which we are more particularly concerned as the equivalent of the Greek ἀνάθεμα, properly denotes, in its Rabbinical use, an excommunication accompanied with the most severe curses and denunciations of evil. We are therefore prepared to find that the *anathema* of the N. T. always implies execration; but it yet remains to be ascertained whether it is ever used to designate a judicial act of excommunication. That there is frequently no such reference is very clear: in some instances the individual denounces the anathema on himself, unless certain conditions are fulfilled. The noun and its corresponding verb are thus used in Acts xxiii. 12, 14, 21, and the verb occurs with a similar meaning in Matt. xxvi. 74; Mark xiv. 71. The phrase 'to call Jesus anathema' (1 Cor. xii. 3) refers not to a judicial sentence pronounced by the Jewish authorities, but to the act of any private individual who execrated him and pronounced him accursed. That this was a common practice among the Jews appears from the Rabbinical writings. The term, as it is used in reference to any who should preach another gospel 'Let him be anathema' (Gal. i. 8, 9), has the same meaning as, let him be accounted execrable and accursed. In none of these instances do we find any reason to think that the word was employed to designate specifically and technically excommunication either from the Jewish or the Christian church. There remain only two passages in which the word occurs in the N. T., both presenting considerable difficulty to the translator. With regard to the first of these (Rom. ix. 3) Grotius and others understand the phrase ἀνάθεμα εἶναι ἀπὸ τοῦ Χριστοῦ to signify excommunication from the Christian church whilst most of the fathers, together

with Tholuck, Rückert, and a great number of modern interpreters, explain the term as referring to the Jewish practice of excommunication. On the other hand, Deyling, Olshausen, De Wette, and many more adopt the more general meaning of accursed. The great difficulty is to ascertain the extent of the evil which Paul expresses his willingness to undergo; Chrysostom, Calvin, and many others understand it to include final separation, not indeed from the love, but from the presence of Christ; others limit it to a violent death; and others, again, explain it as meaning the same kind of curse as that under which the Jews then were, from which they might be delivered by repentance and the reception of the Gospel (Deylingii *Observatt. Sacra*, P. II. p. 495 and *sqq.*). It would occupy too much space to refer to other interpretations of the passage, or to pursue the investigation of it further. There seems, however, little reason to suppose that a judicial act of the Christian Church is intended, and we may remark that much of the difficulty which commentators have felt seems to have arisen from their not keeping in mind that the Apostle does not speak of his wish as a possible thing, and their consequently pursuing to all its results what should be regarded simply as an expression of the most intense desire.

The phrase ἀνάθεμα μαρὸν ἀθὰ (1 Cor. xvi. 22) has been considered by many to be equivalent to the אָרֵר of the Rabbins, the most severe form of excommunication. This opinion is derived from the supposed etymological identity of the Syriac phrase אָרֵר אָרֵר, 'the Lord cometh,' with the Hebrew word which is considered by these commentators to be derived from אָרֵר אָרֵר, 'the Name (i. e. Jehovah) cometh.' This explanation, however, can rank no higher than a plausible conjecture, since it is supported by no historical evidence. The Hebrew term is never found thus divided, nor is it ever thus explained by Jewish writers, who, on the contrary, give etymologies different from this (Buxtorf, *Lex.* col. 2466). It is moreover very uncertain whether this third kind of excommunication was in use in the time of Paul; and the phrase which he employs is not found in any Rabbinical writer (Lightfoot, *Horæ Hebr. et Talm.*, on 1 Cor. xvi. 22*). The literal meaning of the words is clear, but it is not easy to understand why the Syriac phrase is here employed, or what is its meaning in connection with anathema. Lightfoot supposes that the Apostle uses it to signify that he pronounced this anathema against the Jews. However this may be, the supposition that the anathema, whatever be its precise object, is intended to designate excommunication from the Christian church, as Grotius and Augusti understand it, appears to rest on very slight grounds: it seems preferable to regard it, with Lightfoot, Olshausen, and most other commentators, as simply an expression of detestation. Though, however, we find little or no evidence of the use of the word anathema in the N. T. as

* Augusti (*Handbuch der Christl. Archæol.* vol. iii. p. 11) has fallen into a strange mistake in appealing to Buxtorf and Lightfoot in support of this interpretation: the former speaks very doubtfully on the subject, and the express object of the latter is to controvert it.

the technical term for excommunication, it is certain that it obtained this meaning in the early ages of the church; for it is thus employed in the apostolic canons, in the canons of various councils, by Chrysostom, Theodoret, and other Greek fathers (Suiceri *Thesaurus Eccl. sub vocc. ἀνάθεμα* and ἀφορισμός).—F. W. G.

ANATHOTH (אֲנָתוֹת; Sept. Ἀναθώθ), one of the towns belonging to the priests in the tribe of Benjamin, and as such a city of refuge (Josh. xxi. 18; Jer. i. 1). It occurs also in 2 Sam. xxiii. 27; Ezra ii. 23; Neh. vii. 27; but is chiefly memorable as the birthplace and usual residence of the prophet Jeremiah (Jer. i. 1; xi. 21-23; xxix. 27), whose name it seems to have borne in the time of Jerome, 'Anathoth, quæ hodie appellatur Jeremiæ' (*Onomast. s. v. Anathoth*). The same writer (*Comment. in Jer. i. 1*) places Anathoth three Roman miles north of Jerusalem, which correspond with the twenty stadia assigned by Josephus (*Antiq. x. 7. 3*). Professor Robinson appears to have discovered this place in the present village of *Anata*, at the distance of an hour and a quarter from Jerusalem. It is seated on a broad ridge of hills, and commands an extensive view of the eastern slope of the mountainous tract of Benjamin; including also the valley of the Jordan, and the northern part of the Dead Sea. It seems to have been once a walled town and a place of strength. Portions of the wall still remain, built of large hewn stones, and apparently ancient, as are also the foundations of some of the houses. It is now a small and very poor village. From the vicinity a favourite kind of building-stone is carried to Jerusalem. Troops of donkeys are met with employed in this service, a hewn stone being slung on each side; the larger stones are transported on camels (Robinson, *Researches*, ii. 109; Raumer's *Palästina*, p. 169).

ANCHOR. [SHIP.]

ANDREW (Ἀνδρέας), one of the twelve apostles. His name is of Greek origin, but was in use amongst the Jews, as appears from a passage quoted from the Jerusalem Talmud by Lightfoot (*Harmony*, Luke v. 10). He was a native of the city of Bethsaida in Galilee, and brother of Simon Peter. He was at first a disciple of John the Baptist, and was led to receive Jesus as the Messiah in consequence of John's expressly pointing him out as 'the Lamb of God' (John i. 36). His first care, after he had satisfied himself as to the validity of the claims of Jesus, was to bring to him his brother Simon. Neither of them, however, became at that time stated attendants on our Lord; for we find that they were still pursuing their occupation of fishermen on the sea of Galilee when Jesus, after John's imprisonment, called them to follow him (Mark i. 14, 16). Very little is related of Andrew by any of the evangelists: the principal incidents in which his name occurs during the life of Christ are, the feeding of the five thousand (John vi. 9); his introducing to our Lord certain Greeks who desired to see him (John xii. 22); and his asking, along with his brother Simon and the two sons of Zebedee, for a further explanation of what our Lord had said in reference to the destruction of the temple (Mark xiii. 3). Of his subsequent history and labours we have no authentic record. Tradition assigns Scythia (Euseb. iii. 1, 71),

Greece (Theodoret, i. 1425), and Thrace (Hippolytus, ii. 30) as the scenes of his ministry: he is said to have suffered crucifixion at Patrae in Achaia, on a cross of the form called *Crux decussata* (X), and commonly known as 'St. Andrew's cross' (Winer's *Bibl. Realwörterbuch*, sub voce). His relics, it is said, were afterwards removed from Patrae to Constantinople. An apocryphal book, bearing the title of 'The Acts of Andrew,' is mentioned by Ensebins, Epiphanius, and others. It is now completely lost, and seems never to have been received except by some heretical sects, as the Encratites, Origenians, &c. This book, as well as a 'Gospel of St. Andrew,' was declared apocryphal by the decree of Pope Gelasius (Jones, *On the Canon*, vol. i. p. 179 and *sqq.*) [ACTS, SPURIOUS; GOSPELS, SPURIOUS].—F. W. G.

1. ANDRONICUS (Ἀνδρονίκος), the regent-governor of Antioch in the absence of Antiochus Epiphanes, who, at the instigation of Menelaus, put to death the deposed high-priest Onias; for which deed he was himself ignominiously slain on the return of Antiochus (2 Macc. iv.) B.C. 169 [ONIAS].

2. ANDRONICUS, a Jewish Christian, the kinsman and fellow-prisoner of Paul (Rom. xvi. 7).

1. ANER (אָנֶר; Sept. Ἀνάν), ESHCOL, and MAMRE, three Canaanitish chiefs in the neighbourhood of Hebron, who joined their forces with those of Abraham in pursuit of Chedorlaomer and his allies, who had pillaged Sodom and carried Lot away captive (Gen. xiv. 24). These chiefs did not, however, imitate the disinterested conduct of the patriarch, but retained their portion of the spoil [ABRAHAM].

2. ANER, a city of Manasseh, given to the Levites of Kohath's family (1 Chron. vi. 70).

ANETHON (ἀνηθον) occurs in Matt. xxiii. 23, where it is rendered *anise*, 'Woe unto you—for ye pay tithes of mint and *anise* and cummin.' By the Greek and Roman writers it was employed to designate a plant used both medicinally and as an article of diet. The Arabian translators of the Greek medical authors give as its synonyme

شَبْت *shabit*, the name applied in eastern countries to an umbelliferous plant with flattened fruit commonly called 'seed,' which is surrounded with a dilated margin. In Europe the word has always been used to denote a similar plant, which is familiarly known by the name of Dill. Hence there is no doubt that in the above passage, instead of 'anise,' ἀνηθον should have been translated 'dill;' and it is said to be rendered by a synonymous word in every version except our own.

The common dill, or *anethum graveolens*, is an annual plant, growing wild among the corn in Spain and Portugal; and on the coast of Italy, in Egypt, and about Astracan. It resembles *fennel*, but is smaller, has more glaucous leaves, and a less pleasant smell: the fruit or seeds, which are finely divided by capillary segments, are elliptical, broader, flatter, and surrounded with a membranous disk. They have a warm and aromatic taste, owing to the presence of a pale yellow volatile oil, which itself has a hot taste and a peculiar penetrating odour.

The error in translation here pointed out is not of very great consequence, as both the *anise* and the *dill* are umbelliferous plants, which are

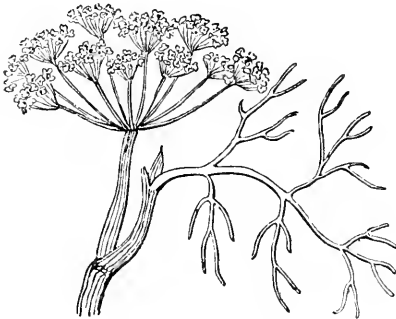

[*Anethum graveolens.*]

found cultivated in the south of Europe. The seeds of both are employed as condiments and carminatives, and have been so from very early times; but the *anethon* is more especially a genus of eastern cultivation, since either the *dill* or another species is reared in all the countries from Syria to India, and known by the name *shubit*; while the *anise*, though known, appears to be so only by its Greek name *ἀνισον*. Rosenmüller, moreover, says, 'In the tract *Massroth* (of Tithes), cap. iv. § 5, we read, "The seed, the leaves, and the stem of *dill* (שֵׁבִיט *shaboth*) are, according to Rabbi Eliezer, subject to tithing," which indicates that the herb was eaten, as is indeed the case with the eastern species in the present day; and, therefore, to those acquainted with the cultivated plants of eastern countries, the dill will appear more appropriate than anise in the above passage.

ANGELS (ἄγγελοι, used in the Sept. and New Test. for the Hebrew מַלְאָכִים; sing. מַלְאָךְ), a word signifying both in Hebrew and Greek *messengers*, and therefore used to denote whatever God employs to execute his purposes, or to manifest his presence or his power. In some passages it occurs in the sense of an ordinary messenger (Job i. 14; I Sam. xi. 3; Luke vii. 4; ix. 52): in others it is applied to prophets (Isa. xliiii. 19; Hag. i. 13; Mal. iii.): to priests (Eccl. v. 5; Mal. ii. 7): to ministers of the New Testament (Rev. i. 20). It is also applied to impersonal agents; as to the pillar of cloud (Exod. xiv. 19): to the pestilence (2 Sam. xxiv. 16, 17; 2 Kings xix. 30): to the winds ('who maketh the winds his angels,' Ps. civ. 4): so likewise, plagues generally, are called 'evil angels' (Ps. lxxviii. 49), and Paul calls his thorn in the flesh an 'angel of Satan' (2 Cor. xii. 7).

But this name is more eminently and distinctively applied to certain spiritual beings or heavenly intelligences, employed by God as the ministers of His will, and usually distinguished as *angels of God* or *angels of Jehovah*. In this case the name has respect to their official capacity as 'messengers,' and not to their nature or condition. The term 'spirit,' on the other hand (in Greek πνεῦμα, in Hebrew רוּחַ), has reference to the nature of angels, and characterizes them as incorporeal and invisible essences. But

neither the Hebrew רוּחַ nor the Greek πνεῦμα, nor even the Latin *spiritus*, corresponds exactly to the English *spirit*, which is opposed to matter, and designates what is immaterial; whereas the other terms are not opposed to matter, but to body, and signify not what is immaterial, but what is incorporeal. The modern idea of spirit was unknown to the ancients. They conceived spirits to be incorporeal and invisible, but not immaterial, and supposed their essence to be a pure air or a subtle fire. The proper meaning of πνεῦμα (from πνέω, I blow, I breathe) is air in motion, wind, breath. The Hebrew רוּחַ is of the same import; as is also the Latin *spiritus*, from spiro, I blow, I breathe. When, therefore, the ancient Jews called angels *spirits*, they did not mean to deny that they were endued with bodies. When they affirmed that angels were incorporeal, they used the term in the sense in which it was understood by the ancients;—that is, as free from the impurities of gross matter. The distinction between 'a natural body' and 'a spiritual body' is indicated by St. Paul (1 Cor. xv. 44); and we may, with sufficient safety, assume that angels are spiritual bodies, rather than pure spirits in the modern acceptance of the word.

It is disputed whether the term *Elohim* אֱלֹהִים is ever applied to angels, but the inquiry belongs to another place [Elohim]. It may suffice here to observe that both in Ps. viii. 5, and xxvii. 7, the word is rendered by *angels* in the Sept. and other ancient versions; and both these texts are so cited in Heb. i. 6; ii. 7, that they are called *Beni-Elohim*, בְּנֵי אֱלֹהִים, *Sons of God*. In the Scriptures we have frequent notices of spiritual intelligences, existing in another state of being, and constituting a celestial family, or hierarchy, over which Jehovah presides. The Bible does not, however, treat of this matter professedly and as a doctrine of religion, but merely adverts to it incidentally as a fact, without furnishing any details to gratify curiosity. It speaks of no obligations to these spirits, and indicates no duties to be performed towards them. A belief in the existence of such beings is not, therefore, an essential article of religion, any more than a belief that there are other worlds besides our own: but such a belief serves to enlarge our ideas of the works of God, and to illustrate the greatness of his power and wisdom (Mayer, *Am. Bib. Repos.* xii. 360). The practice of the Jews, of referring to the agency of angels every manifestation of the greatness and power of God, has led some to contend that angels have no real existence, but are mere personifications of unknown powers of nature: and we are reminded that, in like manner, among the Gentiles, whatever was wonderful, or strange, or unaccountable, was referred by them to the agency of some one of their gods. Among the numerous passages in which angels are mentioned, there are, however, a few which cannot, without improper force, be reconciled with this hypothesis. It may be admitted that the passages in which angels are described as speaking and delivering messages, might be interpreted of forcible or apparently supernatural suggestions to the mind: but they are sometimes represented as performing acts which are wholly inconsistent with this notion (Gen. xvi. 7-12; Judg. xiii. 1-21; Matt. xxviii. 2-4); and if Matt. xx. 30, stood alone in its testimony, it ought to

settle the question. Christ there says, that 'in the resurrection they neither marry nor are given in marriage, but are as the angels of God.' The force of this passage cannot be eluded by the hypothesis [ACCOMMODATION] that Christ mingled with his instructions the erroneous notions of those to whom they were addressed, seeing that he spoke to Sadducees, who did *not* believe in the existence of angels (Acts xxiii. 8). So likewise, the passage in which the high dignity of Christ is established, by arguing that he is superior to the angels (Heb. i. 4. *sqq.*), would be without force or meaning if angels had no real existence.

That these superior beings are very numerous is evident from the following expressions, Dan. vii. 10, 'thousands of thousands,' and 'ten thousand times ten thousand;' Matt. xxvi. 53, 'more than twelve legions of angels;' Luke ii. 13, 'multitude of the heavenly host;' Heb. xii. 22, 23, 'myriads of angels.' It is probable, from the nature of the case, that among so great a multitude there may be different grades and classes, and even natures—ascending from man towards God, and forming a chain of being to fill up the vast space between the Creator and man—the lowest of his intellectual creatures. This may be inferred from the analogies which pervade the chain of being on the earth whereon we live, which is as much the divine creation as the world of spirits. Accordingly the Scripture describes angels as existing in a society composed of members of unequal dignity, power, and excellence, and as having chiefs and rulers. It is admitted that this idea is not clearly expressed in the books composed before the Babylonish captivity; but it is developed in the books written during the exile and afterwards, especially in the writings of Daniel and Zechariah. In Zech. i. 11, an angel of the highest order, *one who stands before God*, appears in contrast with angels of an inferior class, whom he employs as his messengers and agents (comp. iii. 7). In Dan. x. 13, the appellation *שר הראשון*, and in xii. 1, *שר הנרון*, are given to Michael. The Grecian Jews rendered this appellation by the term *ἀρχάγγελος*, *Archangel*, which occurs in the New Testament (Jude 9; 1 Thess. iv. 16), where we are taught that Christ will appear to judge the world *ἐν φωνῇ ἀρχαγγέλου*. This word denotes, as the very analogy of the language teaches, a chief of the angels, one superior to the other angels, like *ἀρχιερεύς*, *ἀρχιστράτηγος*, *ἀρχισυνάγωγος*. The opinion, therefore, that there were various orders of angels, was not peculiar to the Jews; but was held by Christians in the time of the apostles, and is mentioned by the apostles themselves. The distinct divisions of the angels, according to their rank in the heavenly hierarchy, which we find in the writings of the later Jews, were either almost or wholly unknown in the apostolical period. The appellations *ἀρχαί*, *ἐξουσίαι*, *δυνάμεις*, *θρόνοι*, *κυριότητες*, are, indeed, applied in Eph. i. 21, Col. i. 16, and elsewhere, to the angels; not, however, to them exclusively, or with the intention of denoting their particular classes; but to them in common with all beings possessed of might and power, *visible* as well as *invisible*, on *earth* as well as in heaven.

In the Scriptures angels appear with bodies, and in the human form; and no intimation is anywhere given that these bodies are not real, or that they are only assumed for the time and then laid

aside. It was manifest indeed to the ancients that the matter of these bodies was not like that of their own, inasmuch as angels could make themselves visible and vanish again from their sight. But this experience would suggest no doubt of the reality of their bodies: it would only intimate that they were not composed of gross matter. After his resurrection, Jesus often appeared to his disciples, and vanished again before them; yet they never doubted that they saw the same body which had been crucified, although they must have perceived that it had undergone an important change. The fact that angels always appeared in the human form, does not, indeed, prove that they really have this form; but that the ancient Jews believed so. That which is not pure spirit must have some form or other: and angels *may* have the human form; but other forms are possible. The question as to the food of angels has been very much discussed. If they do eat, we can know nothing of their actual food; for the manna is manifestly called 'angels' food' (Ps. lxxviii. 25; Wisd. xvi. 20), merely by way of expressing its excellence. The only real question, therefore, is whether they feed at all or not. We sometimes find angels, in their terrene manifestations, eating and drinking (Gen. xviii. 8; xix. 3); but in Judg. xiii. 15, 16, the angel who appeared to Manoah declined, in a very pointed manner, to accept his hospitality. The manner in which the Jews obviated the apparent discrepancy, and the sense in which they understood such passages, appear from the apocryphal book of Tobit (xii. 19), where the angel is made to say: 'It seems to you, indeed, as though I did eat and drink with you; but I use invisible food which no man can see.' This intimates that they were supposed to simulate when they appeared to partake of man's food; but that yet they had food of their own, proper to their natures. Milton, who was deeply read in the 'angelical' literature, derides these questions:—

'So down they sat

And to their viands fell: (nor seemingly
The angel, nor in mist (the common gloss
Of theologians), but with keen dispatch
Of real hunger, and concoctive heat
To transubstantiate: what redounds
Transpires through spirits with ease.'

Par. Lost, v. 433-439.

The same angel had previously satisfied the curiosity of Adam on the subject, by stating that 'Whatever was created, needs

To be sustained and fed.'

If this dictum were capable of proof, except from the analogy of *known* natures, it would settle the question. But if angels do *not* need it; if their spiritual bodies are inherently *incapable* of waste or death, it seems not likely that they gratuitously perform an act designed, in all its known relations, to promote growth, to repair waste, and to sustain existence.

The passage already referred to in Matt. xxii. 30, teaches by implication that there is no distinction of sex among the angels. The Scripture never makes mention of female angels. The Gentiles had their male and female divinities, who were the parents of other gods. But in the Scriptures the angels are all males: and they appear to be so represented, not to mark any distinction of sex, but because the masculine is the more honourable

gender. Angels are never described with marks of age, but sometimes with those of youth (Mark xvi. 5). The constant absence of the features of age indicates the continual vigour and freshness of immortality. The angels never die (Luke xx. 36). But no being besides God himself has essential immortality (1 Tim. vi. 16): every other being therefore is mortal in itself, and can be immortal only by the will of God. Angels, consequently, are not eternal, but had a beginning. As Moses gives no account of the creation of angels in his description of the origin of the world, although the circumstance would have been too important for omission had it then taken place, there is no doubt that they were called into being before, probably very long before the acts of creation which it was the object of Moses to relate.

The preceding considerations apply chiefly to the *existence and nature* of angels. Some of their *attributes* may be collected from other passages of Scripture. That they are of superhuman intelligence is implied in Mark xiii. 32: 'But of that day and hour knoweth no man, not even the angels in heaven.' That their power is great, may be gathered from such expressions as 'mighty angels' (2 Thes. i. 7); 'angels, powerful in strength' (Ps. ciii. 20); 'angels who are greater [than man] in power and might.' The moral perfection of angels is shown by such phrases as 'holy angels' (Luke ix. 26); 'the elect angels' (2 Tim. v. 21). Their felicity is beyond question in itself, but is evinced by the passage (Luke xx. 36) in which the blessed in the future world are said to be *ἰσάγγελοι, καὶ ὡς τοῦ θεοῦ*, 'like unto the angels, and sons of God.'

The *ministry* of angels, or that they are employed by God as the instruments of His will, is very clearly taught in the Scriptures. The very name, as already explained, shows that God employs their agency in the dispensations of His Providence. And it is further evident, from certain actions which are ascribed wholly to them (Matt. xiii. 41, 49; xxiv. 31; Luke xvi. 22); and from the Scriptural narratives of other events, in the accomplishment of which they acted a visible part (Luke i. 11, 26; ii. 9, sq.; Acts v. 19, 20; x. 3, 19; xii. 7; xxvii. 23), that their agency is employed principally in the guidance of the destinies of man. In those cases also in which the agency is concealed from our view, we may admit the probability of its existence; because we are told that God sends them forth 'to minister to those who shall be heirs of salvation' (Heb. i. 14; also Ps. xxxiv. 8, 91; Matt. xviii. 10). But the angels, when employed for our welfare, do not act independently, but as the instruments of God, and by His command (Ps. ciii. 20; civ. 4; Heb. i. 13, 14): not unto them, therefore, are our confidence and adoration due, but only unto Him (Rev. xix. 10; xxii. 9) whom the angels themselves reverently worship.

Guardian Angels.—It was a favourite opinion of the Christian fathers that every individual is under the care of a particular angel, who is assigned to him as a guardian. They spoke also of two angels, the one good, the other evil, whom they conceived to be attendant on each individual: the good angel prompting to all good, and averting ill; and the evil angel prompting to all ill, and averting good (*Hermas*, ii. 6). The Jews (except-

ing the Sadducees) entertained this belief, as do the Moslems. The heathen held it in a modified form—the Greeks having their tutelary *dæmon*, and the Romans their *geniuses*. There is, however, nothing to support this notion in the Bible. The passages (Ps. xxxiv. 7; Matt. xviii. 10) usually referred to in support of it, have assuredly no such meaning. The former, divested of its poetical shape, simply denotes that God employs the ministry of angels to deliver his people from affliction and danger; and the celebrated passage in Matthew cannot well mean anything more than that the infant children of believers, or, if preferable, the least among the disciples of Christ, whom the ministers of the church might be disposed to neglect from their apparent insignificance, are in such estimation elsewhere, that the angels do not think it below their dignity to minister to them [SATAN] (Storr and Flatt's *Lehrbuch der Ch. Dogmatik*, § xlvi.iii.; Dr. L. Mayer, *Scriptural Idea of Angels*, in *Ann. Bib. Repository*, xii. 356-388; Moses Stuart's *Sketches of Angelology* in Robinson's *Bibliotheca Sacra*, No. I.; Merheim, *Hist. Angelor. Spec.*; Schelthess, *Engelwecht*, &c.).

ANGLING. The word *תִּקְהָה*, which the Auth. Vers. renders 'angle,' in Isa. xix. 8; Heb. i. 15, is the same that is rendered 'hook,' in Job xli. 1, 2. In fact, 'angling' is described as 'fishing with a hook.' The Scripture contains several allusions to this mode of taking fish. The first of these occurs as early as the time of Job:—'Canst thou draw out leviathan with an hook; or his tongue [palate, which is usually pierced by the hook] with a cord [line], which thou lettest down? Canst thou put a hook into his nose, or bore his jaw through with a thorn?' (Job xli. 1, 2). This last phrase obviously refers to the thorns which were sometimes used as hooks, and which are long after mentioned as *בְּסִירוֹת דִּינָה*, i. e. with the thorns of fishing (Amos iv. 2), in the Auth. Vers. 'fish-hooks.'

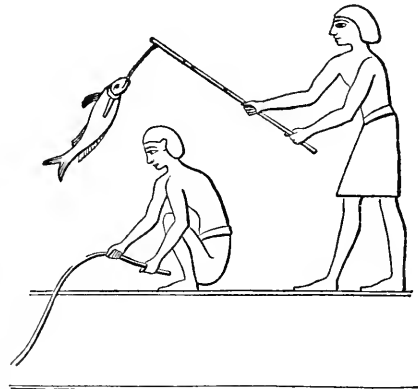

Of the various passages relating to this subject, the most remarkable is that which records, as an important part of the 'burden of Egypt,' that 'the fishers also shall mourn; and all they that cast angle [the hook] into the brooks shall lament, and they that spread nets upon the waters shall languish' (Isa. xix. 8). In this poetical description of a part of the calamities which were to befall Egypt, we are furnished with an account of the

various modes of fishing practised in that country, which is in exact conformity with the scenes depicted in the old tombs of Egypt [FISHING]. Angling appears to have been regarded chiefly as an amusement, in which the Egyptians of all ranks found much enjoyment. 'Not content with the abundance afforded by the Nile, they constructed within their ground spacious sluices or ponds for fish (Isa. xix. 10), like the *vivaria* of the Romans, where they fed them for the table, where they amused themselves by angling, and by the dexterous use of the *bident*. These favourite occupations were not confined to young persons, nor thought unworthy of men of serious habits; and an Egyptian of consequence is frequently represented in the sculptures catching fish in a canal or lake, with the line, or spearing them as they glided past the bank. Sometimes the angler posted himself in a shady spot at the water's edge, and having ordered his servant to spread a mat upon the ground, he sat upon it as he threw the line; and some, with higher notions of comfort, used a chair for the same purpose. The rod was



short, and apparently of one piece; the line usually single, though instances occur of a double line, each furnished with its own hook. The fishermen generally used the net in preference to the line, but on some occasions they used the latter, seated or standing on the bank. It is, however, probable that there were people who could not afford the expense of nets; and the use of the line is generally confined in like manner, at the present day, to the poorer classes, who depend upon skill or good fortune for their subsistence' (Wilkinson's *Anc. Egyptians*, iii. 54).

This last was doubtless the state of many in ancient Palestine, and probably furnished the only case in which angling was there practised, as we find no instance of it for mere amusement. The fish caught in the lake of Tiberias were, some time since, taken exclusively with the rod and line, in the absence of boats upon that water; and probably this is the case still. The Egyptian hooks were of bronze, as appears from the specimens that have been found. Insects, natural or artificial, were not used in angling, ground bait being exclusively employed: and the float does not appear to have been known.

ANIMAL FOOD. [FOOD.]

ANKLETS. This word does not occur in Scripture, but the ornament which it denotes is clearly indicated by 'the tinkling (or *jingling*) ornaments about the feet,' mentioned in

the curious description of female attire which we find in Isa. iii. Even in the absence of special notice, we might very safely conclude that an ornament to which the Oriental women have always been so partial was not unknown to the Jewish ladies. In Egypt anklets of gold have been found, which are generally in the shape of simple rings, often however in that of snakes, and sometimes inlaid with enamel or even precious stones. The sculptures show that they were worn by men as well as women (Wilkinson's *Anc. Egyptians*, iii. 375). Their present use among the women of Arabia and Egypt sufficiently illustrates the Scriptural allusion. The Koran (xxiv. 31) forbids women 'to make a noise with their feet,' which, says Mr. Lane (*Mod. Egyptians*, i. 221), 'alludes to the practice of knocking together the anklets, which the Arab women in the time of the prophet used to wear, and which are still worn by many women in Egypt.' Elsewhere (ii. 361) the same writer states, 'Anklets of solid gold and silver, and of the form here sketched (like fig. 3), are worn by some ladies, but are more uncommon than they formerly were. They are of course very heavy, and, knocking together as the woman walks, make a ringing noise.' He thinks that in the text referred to (Isa. iii. 16) the prophet alludes to this kind of anklet, but admits that the description may apply to another kind, of which he thus speaks further on (ii. 368): 'Anklets of solid silver are worn by the wives of some of the richer peasants, and of the sheykhs of villages. Small ones of iron are worn by many children. It was also a common custom among the Arabs for girls or young women to wear a string of bells on their feet. I have seen many little girls in Cairo with small round bells attached to their anklets. Perhaps it is to the sound of ornaments of this kind, rather than of the more common anklet, that Isaiah alludes' (see also Chardin, tom. i. 133, 148, 194). These belled anklets occur also in India among the several sorts which the dancing-girls employ. It is right to add that the anklets which the present writer has himself seen in use among the

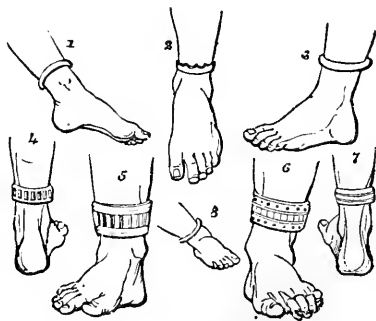

1, 2, 5, 6, 7. Ancient Oriental. 3, 4, 8. Modern Oriental.

Arab women in the country of the Tigris and Euphrates are not usually solid, but hollow, so that, in striking against each other, they emit a much more sharp and sonorous sound than solid ones.

1. ANNA ('*Anna*), wife of Tobit, whose his-

tory is contained in the apocryphal book named after him (Tob. i. 9, &c.).

2. ANNA, an aged widow, daughter of Phanuel, of the tribe of Asher. She had married early, but after seven years her husband died, and during her long widowhood she daily attended the morning and evening services of the Temple. Anna was eighty-four years old when the infant Jesus was brought to the Temple by his mother, and entering as Simeon pronounced his thanksgiving, she also broke forth in praise to God for the fulfilment of his ancient promises (Luke ii. 36, 37).

ANNUNCIATION. This word, like many others, has obtained a particular signification in theological writings. As a general term, it expresses the communication of important intelligence by chosen messengers of Heaven; but it became, at an early period of Christianity, restricted to the announcement of the blessed Virgin's miraculous conception. The first formal mention that we meet with of its being commemorated among the festivals of the church, is in the decrees of the Council of Trullo, convened at the close of the seventh century. By one of the acts of this assembly it is ordered to be observed, though occurring in the solemn season of Lent, like the Sabbath and the Lord's day. So highly was it regarded at this time, that authors speak of it as the crown of all festivals, as exhibiting the beginning and head of our salvation. Sermons attributed to St. Athanasius and other fathers have been referred to as proving the observance of the day long before the seventh century; but the best critics consider these discourses as spurious.

The effect of the solemn announcement upon the mind of the blessed Mary was doubtless deep and permanent. It is conjectured by some that her hastening to Elisabeth was the consequence of an eager desire to prove at once the reality of the angelic visitation. The pious writers who have hazarded this opinion seem to have forgotten that such a notion represents the Virgin as more wanting in faith than Zacharias himself, and that it can scarcely be made to agree with the beautiful and devout sentiment, 'Behold the handmaid of the Lord: Be it unto me according to thy word!'—H. S.

ANOINTING. The practice of anointing with perfumed oils or ointments appears to have been very common among the Hebrews, as it was among the ancient Egyptians. The practice, as to its essential meaning, still remains in the East; but perfumed waters are now far more commonly employed than oils or ointments.

In the Scriptures three kinds of anointing are distinguishable:—1. For consecration and inauguration; 2. For guests and strangers; 3. For health and cleanliness. Of these in order.

1. *Consecration and Inauguration.*—The act of anointing appears to have been viewed as emblematical of a particular sanctification; of a designation to the service of God; or to a holy and sacred use. Hence the anointing of the high-priests (Exod. xxix. 29; Lev. iv. 3), and even of the sacred vessels of the tabernacle (Exod. xxx. 26, &c.); and hence also, probably, the anointing of the king, who, as 'the Lord's anointed,' and, under the Hebrew constitution, the viceroy of Jehovah, was undoubtedly invested with a sacred

character. This was the case also among the Egyptians, among whom the king was, *ex officio*, the high-priest, and as such, doubtless, rather than in his secular capacity, was solemnly anointed at his inauguration.

The first instance of anointing which the Scriptures record is that of Aaron, when he was solemnly set apart to the high-priesthood. Being first invested with the rich robes of his high office, the sacred oil was poured in much profusion upon his head. It is from this that the high-priest, as well as the king, is called 'the Anointed' (Lev. iv. 3; v. 16; vi. 15; Ps. cxxxiii. 2). In fact, anointing being the principal ceremony of regal inauguration among the Jews, as crowning is with us, 'anointed,' as applied to a king, has much the same signification as 'crowned.' It does not, however, appear that this anointing was repeated at every succession, the anointing of the founder of the dynasty being considered efficient for its purpose as long as the regular line of descent was undisturbed: hence we find no instance of unction as a sign of investiture in the royal authority, except in the case of Saul, the first king of the Jews, and of David, the first of his line; and, subsequently, in those of Solomon and Joash, who both ascended the throne under circumstances in which there was danger that their right might be forcibly disputed (1 Sam. xix. 21; 2 Sam. ii. 4; v. 1-3; 1 Chron. xi. 1, 2; 2 Kings xi. 12-20; 2 Chron. xxiii. 1-21). Those who were induced into the royal office in the kingdom of Israel appear to have been inaugurated with some peculiar ceremonies (2 Kings ix. 13). But it is not clear that they were anointed at all; and the omission (if real) is ascribed by the Jewish writers to the want of the holy anointing oil which could alone be used on such occasions, and which was in the keeping of the priests of the Temple in Jerusalem. The private anointing which was performed by the prophets (2 Kings ix. 3; comp. 1 Sam. x. 1) was not understood to convey any abstract right to the crown; but was merely a symbolical intimation that the person thus anointed should eventually ascend the throne.

As the custom of inaugural anointing first occurs among the Israelites immediately after they left Egypt, and no example of the same kind is met with previously, it is fair to conclude that the practice and the notions connected with it were acquired in that country. 'With the Egyptians, as with the Jews,' the investiture to any sacred office, as that of king or priest, was confirmed by this external sign; and as the Jewish lawgiver mentions the ceremony of pouring oil upon the head of the high-priest *after* he had put on his entire dress, with the mitre and crown, the Egyptians represent the anointing of their priests and kings *after* they were attired in their full robes, with the cap and crown upon their heads (cut 1). Some of the sculpturers introduce a priest pouring oil over the monarch' (Wilkinson's *Anc. Egyptians*, iv. 280).

2. The anointing of our Saviour's feet by 'the woman who was a sinner' (Luke vii. 38), led to the remark that the host himself had neglected to anoint his head (v. 46); whence we learn that this was a mark of attention which those who gave entertainments paid to their guests. As this is the only direct mention of the custom, the Jews are supposed by some to have borrowed

It from the Romans at a late period, and Wetstein and others have brought a large quantity of Latin erudition to bear on the subject. But the careful reader of the Old Testament knows that the custom was an old one, to which there are various

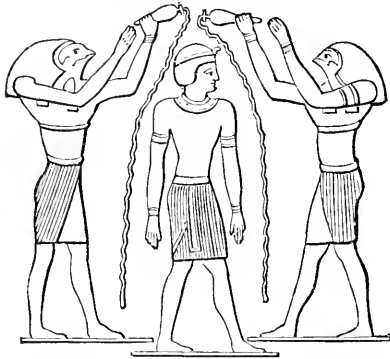

indirect allusions. The circumstances connected with feasts and entertainments are indeed rarely intimated; nor would the present direct reference to this custom have transpired but for the remarks which the act of the woman in anointing the feet of Jesus called forth. Such passages, however, as Ps. xxiii. 5; Prov. xxi. 7; xxvii. 9; Wisd. ii. 7; as well as others in which the *enjoyments* of oil and wine are coupled together, may be regarded as containing a similar allusion. It is, therefore, safer to refer the origin of this custom among the Hebrews to their nearer and more ancient neighbours the Egyptians, than to the Romans or the Greeks, who themselves had probably derived it from the same people. Among the Egyptians the antiquity of the custom is evinced by their monuments, which offer in this respect analogies more exact than classical antiquity, or modern usage, can produce. With them the custom of anointing was not confined to the appointment of kings and priests to the sacred offices they held. It was the ordinary token of welcome to guests in every party at the house of a friend; and in Egypt, no less than in Judæa, the metaphorical expression "anointed



with the oil of gladness" was fully understood, and applied to the ordinary occurrences of life.

It was customary for a servant to attend every guest as he seated himself (cut 2), and to anoint his head' (Wilkinson's *Anc. Egyptians*, iv. 279; ii. 213).

3. It is probable, however, that the Egyptians, as well as the Greeks and Jews, anointed themselves at home, before going abroad, although they expected the observance of this etiquette on the part of their entertainer. That the Jews thus anointed themselves, not only when paying a visit, but on ordinary occasions, is shown by many passages, especially those which describe the omission of it as a sign of mourning (Deut. xxviii. 40; Ruth iii. 3; 2 Sam. xiv. 2; Dan. x. 3; Amos vi. 6; Mic. vi. 15; Esth. ii. 12; Ps. civ. 15; Isa. lxi. 3; Eccles. ix. 8; Cant. i. 3; iv. 10; also Jud'ith x. 3; Sus. 17; Eccelus. xxxix. 26; Wisd. ii. 7). One of these passages (Ps. civ. 15, 'oil that maketh the face to shine') shows very clearly that not only the hair but the skin was anointed. In our northern climates this usage may not strike us as a pleasant one, but as the peculiar usages of most nations are found, on strict examination, to be in accordance with the peculiarities of their climate and condition, we may be assured that this Oriental predilection for external unction must have arisen from a belief that it contributed materially to health and cleanliness. Niebuhr states that 'in Yemen the anointing of the body is believed to strengthen and protect it from the heat of the sun, by which the inhabitants of this province, as they wear but little clothing, are very liable to suffer. Oil, by closing up the pores of the skin, is supposed to prevent that too copious transpiration which enfeebles the frame; *perhaps, too, these Arabians think a glistening skin a beauty.* When the intense heat comes in, they always anoint their bodies with oil.'

Anointing the Sick.—The Orientals are indeed strongly persuaded of the sanative properties of oil; and it was under this impression that the Jews anointed the sick, and applied oil to wounds (Ps. cix. 18; Isa. i. 6; Mark vi. 13; Luke x. 34; James v. 14). Anointing was used in sundry disorders, as well as to promote the general health of the body. It was hence, as a salutary and approved medicament, that the seventy disciples were directed to 'anoint the sick' (Mark vi. 13); and hence also the sick man is directed by St. James to send for the elders of the church, who were 'to pray for him, anointing him with oil in the name of the Lord.' The Talmudical citations of Lightfoot on Matt. vi. 16, show that the later Jews connected charms and superstitious mutterings with such anointings, and he is therefore probably right in understanding this text to mean—'It is customary for the unbelieving Jews to use anointing of the sick joined with a magical and enchanting muttering; but how infinitely better is it to join the pious prayers of the elders of the church to the anointing of the sick.' Niebuhr assures us that at Sana (and doubtless in other parts of Arabia) the Jews, as well as many of the Moslems, have their bodies anointed whenever they feel themselves indisposed.

Anointing the Dead.—The practice of anointing the bodies of the dead is intimated in Mark xiv. 8, and Luke xxiii. 56. This ceremony was performed after the body was washed, and was designed to check the progress of corruption.

Although, from the mode of application, it is called anointing, the substance employed appears to have been a solution of odoriferous drugs. This (together with the laying of the body in spices) was the only kind of embalment in use among the Jews [BURIAL, EMBALMING].

The composition of the Jewish ointments and perfumes is noticed elsewhere [PERFUMES].

ANT (מְלֵאָה); Sept. *Μύμηξ*; Vulg. *Formica*; fifth order of insects; *Hymenoptera*, Linn.; occurs Prov. vi. 6; xxx. 25). Ants have only lately become the subjects of accurate observation. The investigations of Latreille, Gould, Geer, Huber, and Kirby and Spence, have dissipated many erroneous notions respecting them, and revealed much interesting information concerning their domestic polity, language, migrations, affections, passions, virtues, wars, diversions, &c. The following facts are selected as relevant to Scriptural illustration. Ants dwell together in societies; and although they have 'no guide, overseer, or ruler,' yet they have all one soul, and are animated by one object—their own welfare, and the welfare of each other. Each individual strenuously pursues his own peculiar duties; and regards (except in the case of females), and is regarded by, every other member of the republic with equal respect and affection. They devote the utmost attention to their young. The egg is cleaned and licked, and gradually expands under this treatment, till the worm is hatched, which is then tended and fed with the most affectionate care. They continue their assiduity to the pupa, or chrysalis, which is the third transformation. They heap up the pupæ, which greatly resemble so many grains of wheat, or rather rice, by hundreds in their spacious lodges, watch them in an attitude of defence, carry them out to enjoy the radiance of the sun, and remove them to different situations in the nest, according to the required degree of temperature; open the pupa, and at the precise moment of the transformation, disenthral the new-born insect of its habiliments.

The most prevalent and inexcusable error, however, respecting ants, has been the belief that they hoard up grains of corn, chiefly wheat, for their supply during winter, having first bitten out the germ to prevent it from growing in their nests. The learned Bochart has collected an immense array of the most eminent authors and naturalists of antiquity (Jewish, Greek, Roman, and Arabian), who all gravely propound this assertion. The same assertion is made in a letter published by the French Academy, and afterwards inserted by Mr. Addison in the *Guardian*, No. 156. He adds, 'any one may make the experiment, and even see that there is no germ in their corn.' Notwithstanding that this notion has been completely exploded during the last hundred years, with regard to European ants, the belief of it constitutes, to this hour, one of our popular errors. Even Solomon himself, whose renowned attainments in natural history included the knowledge of insects (1 Kings iv. 33), has been inconsiderately supposed to have sanctioned the same opinion in the two passages in his writings which refer to the ant. The mistake has no doubt arisen from the great similarity, both in shape, size, and colour, before mentioned, of the pupa or chrysalis of the ant to a grain of corn, and from the ants being ob-

served to carry them about, and to open the cuticle to let out the enclosed insect. Læwenhoeck was the first who distinguished, with precision, the precise forms which the ant assumes in the several stages of its development, from the egg to the larva, from the larva to the pupa, and thence to the perfect insect. Swammerdam renewed the inquiry, and discovered the encasement of all the parts of the future ant, and showed that it appeared in such different forms only from the nature of its envelopes, each of which, at its proper period, is cast off. It is now also ascertained beyond a doubt that no European ants, hitherto properly examined, feed on corn, or any other kind of grain. Bonnet found that, however long they had been kept without food, they would not touch corn. Nor do they attack the roots or stems of corn, nor any other vegetable matter. Nor has any species of ant been yet found with food of any kind laid up in its nest. The truth is, that ants are chiefly carnivorous, preying indiscriminately on all the soft parts of other insects, and especially the viscera; also upon worms, whether dead or alive, and small birds or animals. If unable to drag their booty to the nest, they make an abundant meal upon it, and, like the bee, disgorge it, upon their return home, for the use of their companions; and they appear able to retain at pleasure the nutritious juices unchanged for a considerable time. Ants are also extremely fond of saccharine matter, which they obtain from the exudation of trees, or from ripe fruits, &c.; but their favourite food is the saccharine exudation from the body of the aphides, or plant-lice. Every one must have observed these insects on the rose-tree, &c. Each different species of vegetable has its peculiar species of aphid (Reaumur, vi. 566). The aphides insert their tube or sucker between the fibres of vegetables, where they find a most substantial nutriment. This nutriment they retain a considerable time, if no ant approaches them. The ant has the talent of procuring it from the aphides at pleasure. It approaches the aphid, strikes it gently and repeatedly with its antennæ, when it instantly discharges the juice by two tubes, easily discerned to be standing out from its body. These creatures are the *milch kine* of the ants. By a remarkable coincidence, which M. Huber justly considers too much to be ascribed to chance, the aphides and the ants become torpid at the same degree of cold (27 deg. Fahr.), and revive together at the same degree of warmth. He says, 'I am not acquainted with any ants to whom the art of obtaining from the pucerons (aphides) their subsistence is unknown. We might even venture to affirm that these insects are made for their use' (Huber, *Natural History of Ants*, p. 210, &c.).

It is highly probable that the exotic ants subsist by similar means. The accounts given us of the termites, or ants, inhabiting the hottest climates, clearly show that they are carnivorous. Bosman, in his description of Guinea, says that they will devour a sheep in one night, and that a fowl is amusement to them only for an hour. In these situations living animals often become their victims. An Italian missionary at Congo relates that a cow in a stall had been known to be devoured by these devastators (*Encyclopædia Britannica*, 7th ed. art. 'Ant'). In the *Introduction*

to *Entomology*, by Kirby and Spence, some diffidence is expressed (ii. 46) respecting the inference that no exotic ants have magazines of provisions, till their habits shall have been 'more accurately explored.' Still, are we not in possession of sufficient data to form a strong presumption in regard to the ants of *Palestine*, to which Solomon of course alludes in his writings? The ants of the Holy Land certainly have to encounter a degree of cold quite as severe as ever occurs in England (*Physical Hist. of Palestine*, 210, 216). Is it not highly probable that the ants at such times become torpid, and need no magazine of provisions? And since we learn from the same authority (p. 31) that there are intervals, even in the depth of winter, when the sun shines, and there is no wind, when it is perfectly warm, sometimes almost hot, in the open air, may not the ants of Palestine and their food revive together at such times, as is the case in our own country, where ants may often be seen pursuing their avocations over the snow? With regard to Solomon's words respecting the ant, Kirby and Spence are of opinion 'that if they are properly considered it will be found that the interpretation which seems to favour the ancient error respecting ants has been fathered upon them rather than fairly deduced from them. He does not affirm that the ant, which he proposes to the sluggard as an example, laid up in her magazine stores of grain against winter, but that, with considerable prudence and foresight, she makes use of *proper seasons* to collect a supply of provisions sufficient for her purposes. There is not a word in them implying that she stores up grain or other provisions. She prepares her bread and gathers her food (namely, such food as is suited to her) in summer and harvest (that is, when it is most plentiful), and thus shows her wisdom and prudence by using the advantages offered to her.' A brief examination of the passages (Prov. vi. 6; xxx. 25) with reference to their context, will serve to confirm these observations. In the preceding verses, Solomon has cautioned his readers against incurring dangerous responsibilities on behalf of another. Should this have inadvertently been done, he advises the surety to give no sleep to his eyes, nor slumber to his eyelids, till he has delivered himself from his rash engagement. He then adds, 'Go to the ant, thou sluggard, consider her ways, and be wise: which having no guide, overseer, or ruler, provideth her meat in the summer, and gathereth her food in the harvest.' The sense is thus ably given by Dr. Hammond: 'As in the matter just mentioned the least delay is pernicious, so in all things else sluggishness, or negligence of those things which concern us most nearly, should ever be avoided; and if we need any instructor on this head, we may go to one of the least and meanest of creatures.' The moral, then, intended in Solomon's allusion to the ant, is simply to avail one's self of the *favourable time without delay*. The description which follows, of the sluggard sleeping, evidently during the day, the proper season of activity, and of the consequences of his vice, agrees with this interpretation. The other passage (xxx. 25), probably by a different writer, also considers the ant simply as the symbol of *diligence*.

The peculiar use of the terms *summer and harvest*, among the Jews, may have contributed

to the erroneous interpretation. The Jews had no word to signify spring or autumn. They spoke only of summer and winter: by the former they designated the *whole* of the more genial time of the year, and by the latter the whole of the less favourable. Hence Solomon uses summer and harvest as synonymous terms (Prov. x. 5; xxvi. 1: see also Jer. viii. 28; Matt. xxiv. 32). In the same way the Romans employed *estas* and *messis*, and the Greeks *θέρω* and *θερίζω*.—J. F. D.

ANTEDILUVIANS, the name given collectively to the people who lived before the Deluge. The interval from the Creation to that event is not less, even according to the Hebrew text, than 1657 years, being not more than 691 years shorter than that between the Deluge and the birth of Christ, and only 167 years less than from the birth of Christ to the present time, and equal to about two-sevenths of the whole period from the Creation. By the Samaritan and Septuagint texts (as adjusted by Hales) a much greater duration is assigned to the antediluvian period—namely, 2256 years, which nearly equals the Hebrew interval from the deluge to the birth of Christ, and much exceeds the interval from the birth of Christ to the present time.

All our authentic information respecting this long and interesting period is contained in 49 verses of Genesis (iv. 16, to vi. 8), more than half of which are occupied with a list of names and ages, invaluable for chronology, but conveying no particulars regarding the primeval state of man. The information thus afforded, although so limited in extent, is, however, eminently suggestive, and large treatises might be, and have been, written upon its intimations. Some additional information, though less direct, may be safely deduced from the history of Noah and the first men after the Deluge; for it is very evident that society did not begin afresh after that event; but that, through Noah and his sons, the new families of men were in a condition to inherit, and did inherit, such sciences and arts as existed before the Flood. This enables us to understand how settled and civilized communities were established, and large and magnificent works undertaken, within a few centuries after the Deluge.

In the article 'ADAM' it has been shown that the father of men was something more than 'the noble savage,' or rather the grown-up infant, which some have represented him. He was an instructed man;—and the immediate descendants of a man so instructed could not be an ignorant or uncultivated people. It is not necessary indeed to suppose that they possessed at first more cultivation than they required; and for a good while they did not stand in need of that which results from, or is connected with, the settlement of men in organized communities. They probably had this before the Deluge, and at first were possessed of whatever knowledge or civilization their agricultural and pastoral pursuits required. Such were their pursuits from the first; for it is remarkable that of the strictly savage or hunting condition of life there is not the slightest trace before the Deluge. After that event, Nimrod, although a hunter (Gen. x. 9), was not a savage, and did not belong to hunting tribes of men. In fact, savagism is not discoverable before the Confusion of Tongues, and was in all likelihood a degeneracy from a state of cultivation.

eventually produced in particular communities by that great social convulsion. At least that a degree of cultivation was the primitive condition of man, from which savagism in particular quarters was a degeneracy, and that he has not, as too generally has been supposed, worked himself up from an original savage state to his present position, has been powerfully argued by Dr. Philip Lindsley (*Am. Bib. Repos.*, iv. 277-298; vi. 1-27), and is strongly corroborated by the conclusions of modern ethnographical research; from which we learn that, while it is easy for men to degenerate into savages, no example has been found of savages rising into civilization but by an impulse from without, administered by a more civilized people; and that, even with such impulse, the *vis inertiae* of established habits is with difficulty overcome. The aboriginal traditions of all civilized nations describe them as receiving their civilization from without—generally through the instrumentality of foreign colonists: and history affords no example of a case parallel to that which must have occurred if the primitive races of men, being originally savage, had civilized themselves.

All that was peculiar in the circumstances of the antediluvian period was eminently favourable to civilization. The respected contributor [J. P. S.], to whose article [ADAM] we have already referred, remarks, in a further communication, that 'The longevity of the earlier seventeen or twenty centuries of human existence is a theme containing many problems. It may be here referred to for the purpose of indicating the advantages which must necessarily have therefrom accrued to the mechanical arts. In pottery, mining, metallurgy, cloth-making, the applications of heat and mixtures, &c., it is universally known that there is a tact of manipulation which no instruction can teach, which the possessor cannot even describe, yet which renders him powerful and un-failing within his narrow range, to a degree almost incredible; and when he has reached his limit of life he is confident that, had he another sixty or seventy years to draw upon, he could carry his art to a perfection hitherto unknown. Something like this must have been acquired by the antediluvians; and the paucity of objects within their grasp would increase the precision and success within the range.'

By reason of their length of life, the antediluvians had also more encouragement in protracted undertakings, and stronger inducements to the erection of superior, more costly, more durable, and more capacious edifices and monuments, public and private, than exist at present. They might reasonably calculate on reaping the benefit of their labour and expenditure. The earth itself was probably more equally fertile, and its climate more uniformly healthful, and more auspicious to longevity, and consequently to every kind of mental and corporeal exertion and enterprise, than has been the case since the great convulsion which took place at the Deluge.

But probably the greatest advantage enjoyed by the antediluvians, and which must have been in the highest degree favourable to their advancement in the arts of life, was the uniformity of language. Nothing could have tended more powerfully to maintain, equalize, and promote whatever advantages were enjoyed, and to prevent

any portion of the human race from degenerating into savage life.

Of the actual state of society and of the arts before the Deluge some notice has occurred in a previous article [ADAM], and other particulars will be found in the articles relating to these subjects.

The opinion that the old world was acquainted with *astronomy*, is chiefly founded on the ages of Seth and his descendants being particularly set down (Gen. v. 6, *sqq.*), and the precise year, month, and day being stated in which Noah and his family, &c. entered the ark, and made their egress from it (Gen. vii. 11; viii. 13). The distinctions of day and night, and the lunar month, were of course observed; and the thirteenth rotation of the moon, compared with the sun's return to his primary position in the heavens, and the effects produced on the earth by his return, would point out the year. The variation between the rotations of the moon and sun easily became discoverable from the difference which in a very few years would be exhibited in the seasons; and hence it may be supposed that, although the calculations of time might be by lunar months or revolutions, yet the return of vegetation would dictate the solar year. The longevity of the antediluvian patriarchs, and the simplicity of their employments, favour this conjecture, which receives additional strength from the fact that the Hebrew for *year*, שנה, implies an *iteration*, a return to the same point, a repetition; and it is also remarkable that the Indians, Chinese, Babylonians, Egyptians, Greeks, and other nations, all deduce their origin from personages said to be versed in astronomy.

The knowledge of *zoology*, which Adam possessed, was doubtless imparted to his children; and we find that Noah was so minutely informed on the subject as to distinguish between clean and unclean beasts, and that his instructions extended to birds of every kind (Gen. vii. 2-4). A knowledge of some essential principles in *botany* is shown by the fact that Adam knew how to distinguish 'seed-bearing herb' and 'tree in which is a seed-bearing fruit,' with 'every green herb' (Gen. i. 29, 30). The trees of life and of knowledge are the only ones mentioned before the Fall; but in the history of Noah the vine, the olive, and the wood of which the ark was made (Gen. vi. 14; viii. 11; ix. 20), are spoken of in such a manner as clearly to intimate a knowledge of their qualities. With *mineralogy* the antediluvians were at least so far acquainted as to distinguish metals; and in the description of the garden of Eden gold and precious stones are noticed (Gen. ii. 12).

That the antediluvians were acquainted with *music* is certain; for it is expressly said that Jubal (while Adam was still alive) became 'the father of those who handle the כִּנּוּר *kinnur* and the חֲגָב *hugab*.' The *kinnur* was evidently a stringed instrument resembling a lyre; and the *hugab* was without doubt the pandæan pipe, composed of reeds of different lengths joined together. This clearly intimates considerable progress in the science; for it is not probable that the art of playing on wind and on stringed instruments was discovered at the same time; we may rather suppose that the principles of harmony, having been discovered in the one, were by analogy transferred to the other; and that Jubal,

by repeated efforts, became the first performer on the harp and the pipe [Music].

Our materials are too scanty to allow us to affirm that the antediluvians possessed the means of communicating their ideas by writing or by hieroglyphics, although tradition, and a hint or two in the Scriptures, might support the assertion. With respect to *poetry*, the story of Lamech and his wives (Gen. iv. 19-24) is evidently in verse, and is most probably the oldest specimen of Hebrew poetry extant; but whether it was written before or after the Flood is uncertain, although the probability is that it is one of those previously existing documents which Moses transcribed into his writings.

With regard to *architecture*, it is a singular and important fact that Cain, when he was driven from his first abode, built a city in the land to which he went, and called it Enoch, after his son. This shows that the descendants of Adam lived in houses and towns from the first, and consequently affords another confirmation of the argument for the original cultivation of the human family. What this 'city' was is not mentioned, except in the term itself; and as that term is in the early Scriptures applied to almost every collection of human habitations, we need not attach any very exalted ideas to it in this instance. But if we take into view the requisites necessary to enable Noah to erect so stupendous a fabric as the ark must have been [ARK, NOAH'S], it will not be difficult to conceive that the art of building had reached considerable advancement before the Deluge; nor can one reflect on the building of Babel without a conviction that it must have been through the great patriarchs who lived in the old world that so much knowledge was obtained as to lead to the attempt of erecting a fabric whose summit was intended to reach the clouds. It is not likely that the builders would, by their own intuitive genius, be equal to a task which they certainly were not inspired by Heaven to execute.

The *metallurgy* of the antediluvians has been noticed in 'ADAM;' and to what is there said of *agriculture* we shall only add a reference to the case of Noah, who, immediately after the Flood, became a husbandman, and planted a vineyard. He also knew the method of fermenting the juice of the grape; for it is said he drank of the wine, which produced inebriation (Gen. ix. 20, 21). This knowledge he doubtless obtained from his progenitors anterior to the destruction of the old world.

Pasturage appears to have been coeval with husbandry. Abel was a keeper of sheep, while his brother was a tiller of the ground (Gen. iv. 2); but there is no necessity for supposing that Cain's husbandry excluded the care of cattle. The class of tent-dwelling pastors—that is, of those who live in tents that they may move with their flocks and herds from one pasture-ground to another—did not originate till comparatively late after the Fall; for Jabal, the seventh from Adam in the line of Cain, is said to have been the 'father' or founder of that mode of life (Gen. iv. 20). It is doubtful whether the manufacture of cloth is involved in the mention of tents, seeing that excellent tent-coverings are even at this day made of skins; and we know that skins were the first articles of clothing used by fallen man (Gen.

iii. 21). The same doubt applies to the garment with which the sons of Noah covered their inebriated father (Gen. ix. 23). But, upon the whole, there can be little doubt that, in the course of so long a period, the art of manufacturing cloths of hair and wool, if not of linen or cotton, had been acquired.

It is impossible to speak with any decision respecting the form or forms of government which prevailed before the Deluge. The slight intimations to be found on the subject seem to favour the notion that the particular governments were patriarchal, subject to a general theocratical control—God himself *manifestly* interfering to uphold the good and check the wicked. The right of property was recognised, for Abel and Jabal possessed flocks, and Cain built a city. As ordinances of religion sacrifices certainly existed (Gen. iv. 4), and some think that the Sabbath was observed; while some interpret the words, 'Then men began to call upon the name of the Lord' (Gen. iv. 26) to signify that public worship then began to be practised. From Noah's familiarity with the distinction of clean and unclean beasts (Gen. vii. 2), it would seem that the Levitical rules on this subject were by no means new when laid down in the code of Moses.

Marriage, and all the relations springing from it, existed from the beginning (Gen. ii. 23-25); and although polygamy was known among the antediluvians (Gen. iv. 19), it was most probably unlawful; for it must have been obvious that, if more than one wife had been necessary for a man, the Lord would not have confined the first man to one woman. The marriage of the sons of Seth with the daughters of Cain appears to have been prohibited, since the consequence of it was that universal depravity in the family of Seth so forcibly expressed in this short passage, 'All flesh had corrupted its way upon the earth' (Gen. vii. 11). This sin, described *Orientially* as an intermarriage of 'the sons of God' with 'the daughters of men' (Gen. vi. 2), appears to have been in its results one of the grand causes of the Deluge; for if the family of Seth had remained pure and obedient to God, he would doubtless have spared the world for their sake; as he would have spared Sodom and Gomorrah had ten righteous men been found there, and as he would have spared his own people the Jews, had they not corrupted themselves by intermarriages with the heathen.

A contributor [J. P. S.] suggests that even the longevity of the antediluvians may have contributed to this ruinous result:—'There was also, probably, a great waste of time. Vastly more time was upon their hands than was needful for clearing woodlands, draining swamps, and other laborious and tedious processes, in addition to their ordinary agriculture and care of cattle; so that the temptations to idleness were likely to be very strong; and the next step would be to licentious habits and selfish violence. The ample leisure possessed by the children of Adam might have been employed for many excellent purposes of social life and religious obedience, and undoubtedly it was so employed by many; but to the larger part it became a snare and the occasion of temptations, so that "the wickedness of man became great, the earth was corrupt before God, and was filled with violence."'

It will be seen that many of the topics only slightly touched upon in this article will fall to be considered more largely under other heads. (*Critica Biblica*, iv. 14-20; P. Lindsley, D.D., *On the Primitive State of Mankind*, in *Am. Bib. Repos.* iv. 277-298; vi. 1-27; see also *Ant. U. Hist.* i. 142-201).

ANTELOPE (אֲנֶלֹפִים, *Jachmur*; אֲנֶלֹ, *Theo*, *Teo*; דִּישׁוֹן, *Dishon*, *Pygarg*; תְּסֵבִי, *Tsebi*, *Dorcas*). Although this word does not occur in our version of the Scriptures, yet there can be no doubt that in the Hebrew text several ruminants to which it is applicable are indicated under different denominations. In scientific nomenclature, the term antelope, at first applied to a single species, has gradually become general, and is now the designation of a tribe, or even of a family of genera, containing a great many species. According to present usage it embraces some species that are of considerable size, so as to be invariably regarded by the natives as having some affinity to cattle, and others delicate and rather small, that may be compared with young deer, to which, in truth, they bear a general resemblance. The origin of the word is involved in great obscurity. In the *Hexæmeron* of Eustathius, bishop of Antioch, who wrote in the reign of Constantine, we first find the name Ἀνθόλοψ applied to an animal, which he describes as 'very swift, and hunted with difficulty. It had long horns in the shape of saws, with which it sawed trees of considerable size. When thirsty, it approached the Euphrates, and gambled along its banks among brambles, wherein it was sometimes entangled, and then could be caught and slain.'

It may be doubted whether the word *antholops* was, in the beginning of the fourth century of our era, a local Asiatic Greek paraphrase of the Arabic

غزال *gazal*, purporting a similar allusion to fine or blooming eyes; although the fact, if established, would prove that the Grecian residents in Asia viewed the greater antilopidae of our systems as belonging typically to the gazelle family, as we do now. Certain it is, however, that in the Greek and Latin writers of the middle and later ages, we find the same name, but so variously inflected that we are justified in concluding that it was drawn from some other source than the bishop's *Hexæmeron*; for it is written *antalops*, *analops*, *aptalos*: in Albertus Magnus, *calopus* and *panthalops*, which, though evidently Alexandrian Greek, Bochart would make the Coptic name for unicorn. Towards the close of the fourteenth century English heralds introduced the name, and 'tricked out' their antelope as a supporter of the armorial bearings and cognizance of a younger branch of the Plantagenet family; and although the figures are monstrous, they bear clear indications of being derived at first from the saw-horned, and soon after from a real oryx.

In order to explain somewhat more fully the station of antelopes among the families of ruminants, and point out more strictly the species we have to notice, as well as the general characters of the order, it may be desirable to give a short definition of ruminants, and thereby obviate the necessity of again recurring to them when other species of this section come under consideration.

Ruminating animals are possessed of the singular faculty of chewing their food a second time, by means of the peculiar structure of their stomachs—a structure which enables them to force it back again into the mouth after a first deglutition. For this purpose, all ruminants have four stomachs, whereof the three first are so disposed that the aliments can enter at will into any one of them, the œsophagus being placed at the point of their communication. The first and largest is the *paunch*, externally appearing as twofold, but internally divided into four slight partitions. In this is received the fodder simply broken by a first mastication, in which state it is transmitted into the second stomach, *bonnet*, or *honeycomb bag*, the walls of which are internally shaped like the cells of a honeycomb. Here the herbage is imbibed, and compressed, by its globular form, into small masses, or balls, which are thus prepared to be forced upwards again into the mouth for a second trituration—a process always going on when cattle lie down, and are seen grinding their cheek teeth. After this it descends into the third stomach (*manplies*), which is the smallest, and is longitudinally furnished with folds, somewhat resembling the leaves of a book: from thence it passes into the fourth (*the red*), next in size to the paunch, and pear-shaped, the *stomach* properly so called, where the process of digestion is accomplished. All ruminants, moreover, are distinguished by cloven feet, by the want of incisor teeth in the upper jaw, and by all the grinders being furrowed like ridges on millstones.

This abstract of the characters of ruminating animals is here given because the faculty of chewing the cud, or rumination, cannot exist without the foregoing apparatus; because that apparatus is found, without exception, to belong to all the species having bisulcate feet and the modified dentition before noticed, and belongs to no other class or genus of mammalia. The numerous species of the order are distributed into three grand divisions, viz., 1st. those without horns, like the camel* and the musk; 2nd. those with deciduous horns, or such as are shed yearly, and replaced by a new growth, like the stag; and, 3rd. those which have persistent horns, consisting of a bony core, upon which a horny sheath is fixed, which grows by annual additions of the substance at the base, such as antelopes, goats, sheep, and oxen or neat cattle.

The antelopes, considered as a family, may be distinguished from all others by their uniting the light and graceful forms of deer with the permanent horns of goats, excepting that in general their horns are round, annulated, and marked with striae, slender, and variously inflected, according to the subdivision or group they belong to. They have usually large, soft, and beautiful eyes, tear-pits beneath them, and round tails. They are often provided with tufts of hair, or brushes, to protect the fore-knees from injury; they have inguinal pores; and are distinguished by very great powers of speed. Among the first of the subordinate groups is the subgenus oryx, already named, consisting of five or six species, whereof we have to notice at least three.

* The camel, although it has cloven feet partially united by a common sole, and is armed with several false molars, is still a true ruminant.

The **JACHMUR** (יַחְמוּר, Deut. xiv. 5; 1 Kings iv. 23) is not, as in our Auth. Vers., 'the fallow-deer,' but the *Oryx leucoryx* of the moderns, the true oryx of the ancients, and of Niebuhr, who quotes R. Jona, and points out the Chaldaic *jachmura*, and Persian *kutzkohi* (probably a mistake for *maskandos*), and describes it as a great goat. The eastern Arabs still use the

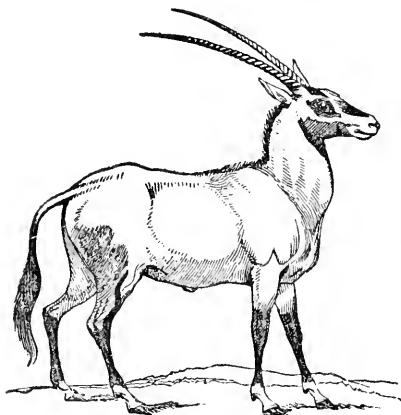

[The Jachmur. *Oryx leucoryx*.]

name *jachmur*, although, according to the usage of Oriental nomenclature respecting these animals, the terms *abu* (father) and *bahr* (desert, valley) are generally made parts of generic appellations, which, in the case of the larger antelopes, are commonly associated with *gau* or *bu* (cow or ox), forming the terms *gau-bahreïn*, *bekr-el-wash*, *el-walrus*, *el-bukrus*, *abu-harb*, *abu-bahr*; and, particularly west of the Nile, *mahatz*, *targea*; while collectively, *buggera-el-almoor* is used. Most of these denominations, albeit they are laxly applied by the Arabs, show that the animals so named are considered to be more nearly allied to the bovine species than to the gazelles of the country; and the fact of their universal application to the great antelopes, from the Ganges to Morocco, is sufficient to establish the general conclusion, that, in the earliest ages, similar notions led the Hebrews to adopt similar terms; and that, when the Scriptures notice wild oxen, or wild cattle, we are in reality to understand not a bovine, but an antilopine animal, and not always the same species, excepting perhaps in one case, which will be noticed under the word **BULL**.

The *Oryges* are all about the size of the stag of Europe, or larger, with long, annulated, slender horns, rising in continuation of the plane of the forehead, slightly divergent, regularly but not greatly curved, entirely straight or lyrated, and from three feet to three feet eight inches in length. The head is rather clumsy, and more or less pied with black and white; the neck ewed, or arched, like that of the camel; the carcass bulky, compared with the legs, which are slender, firm, and capable of sustaining great action; the tail extends only to the heel, or hough; the hair on the shoulders and neck is invariably directed forwards, thus, no doubt, keeping the animal cool in flight.

The *Leucoryx*, as the name implies, is white, having a black mark down the nose, black cheeks and jowl, the legs, from the elbow and heel to the pastern joints, black, and the lower half of the thighs usually, and often the lower flank, bright rufous; hence the epithet *hommar*, הַמֶּר (rubere, to redden). The species now resides in pairs, in small families, and not unfrequently singly, on the mountain-ranges along the sandy districts, in the desert of eastern Arabia, and on the banks of the Lower Euphrates; and may extend as far eastward as the west bank of the Indus, feeding on shrubby acacias, such as *tortilis* and *Ehrenbergi*. It was, no doubt, formerly, if not at present, found in Arabia Petraea, and in the eastern territories of the people of Israel; and from the circumstance of the generic name of wild cow or bull being common to this, as to other allied species, it was equally caught with nets and with the noose, and styled תַּא (tao, to, theo). To this species may be referred more particularly some of the notions respecting unicorns, since the forehead being narrow, and the horns long and slender, if one be broken off near the root, the remaining one stands so nearly on the medial line, that, taken in connection with its white-coloured hair, to uncritical inspection, a single-horned animal might appear to be really present. By nature vicious and menacing, from what may be observed in the Egyptian paintings of the industry which imposture exercised, we may conclude that human art, even in early ages, may have contributed to make artificial unicorns; and most probably those seen by some of the earlier European travellers were of this kind.



[*Oryx tao*, or Nubian oryx.]

יָאֵר, Deut. xiv. 5; Isa. li. 20, (*Oryx tao*, the Nubian oryx, Ham. Smith.) is either a species or a distinct variety of *leucoryx*. The male, being nearly four feet high at the shoulder, is taller than that of the *leucoryx*; the horns are longer, the body comparatively lighter, and every limb indicative of vigour and elasticity: on the forehead there is a white spot, distinctly marked by the particular direction of the hair turning downwards before the inner angle of the eye to near the mouth, leaving the nose rufous, and forming a kind of letter A.

Under the eye, towards the cheek, there is a darkish spot, not very distinct; the limbs, belly, and tail are white; the body mixed white and red, most reddish about the neck and lower hams. It is possible that the name *tao* or *teo* is connected with the white spot on the chaffron. This species resides chiefly in the desert west of the Nile, but is most likely not unknown in Arabia; certain it is, that both are figured on Egyptian monuments, the leucoryx being distinguished by horns less curved, and by some indication of black on the face. Here, then, we have a second wild bove; but there is still a third referable to the antilopidae, though not an oryx, but most likely belonging to the genus *damalis* and the acronotine group of Griffith's Cuvier. It is the *Antelope defassa* of Sir J. Wilkinson, which we would place by the side of *acronotus bubalis*, if it be not the same, as might be inferred from the figures at Beni Hassan,* in which the elevated withers are very conspicuous, where it is represented actually caught by the noose or lazzo. If the two oryges were not anciently distinguished as

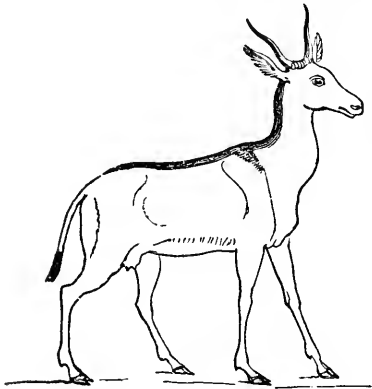

[Antelope defassa of Wilkinson. Acronotus defassa.]

species, then *tao*, *theo*, would apply to the present, the name indicating the spinal cross; but in that case, it must have existed in early ages as far north at least as the borders of Palestine, which is by no means improbable. This last species would answer completely to the description of wild bull, while there can be no doubt that, in the dialects of some provinces of that country, the oryges of Arabia may still be denominated *reem*, even when bearing both horns; and all are sufficiently vicious, energetic, and capable of mischief, to justify the characters assigned to them in poetical phraseology, agreeably to the amplifying spirit of Aramæan nations.

Oryx addax may have been known to the Hebrews by the name of דִּישׁוֹן, *dishon*. It is three feet seven inches at the shoulder, has the

* Wilkinson's *Anc. Egyptians*, vol. iii. p. 18, cut 327. In cut 328, No. 3 appears to be *A. Bubalis*, and No. 4, *defassa*, distinguished by lunate, cow-like horns, and a black cross on the shoulders and spine. *A. Bubalis* still comes occasionally to the Nile, and all the ruminants of the wilderness are at times liable to migrate from famine caused by drought or locusts.

same structure as the others, but is somewhat higher at the creap: it has a coarse beard under

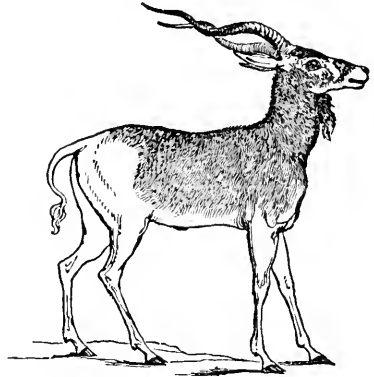

[Oryx addax. Dishon or Pygarg.]

the gullet, a black scalp and forehead, divided from the eyes and nose by a white bar on each side, passing along the brows and down the face to the cheek, and connected with one another between the eyes. The general colour of the fur is white, with the head, neck, and shoulders more or less liver-colour grey; but what distinguishes it most from the others are the horns, which in structure and length assimilate with those of the other species, but in shape assume the spiral flexures of the Indian antelope. The animal is figured on Egyptian monuments, and may be the *pygarg* or *dishon*, uniting the characters of a white rump with strepsicerotine horns, and even those which Dr. Shaw ascribes to his 'lidmee.'

We have now to notice the second group of antilopidae, classified under the subgenus *gazella*, whereof at least one species, but more probably four or five, still inhabit the uplands and deserts of Egypt, Arabia, and the eastern and southern borders of Palestine. They are named in the Greek

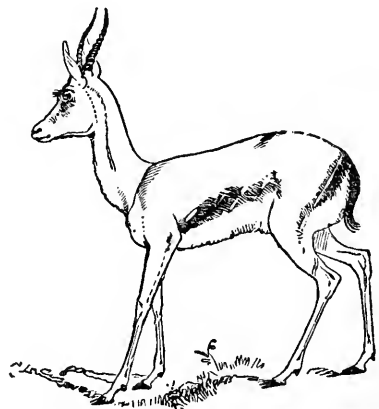

[Gazeb or Dorcas. Ariel or Gazella Arabica.]

Δορκας, *dorcas*, and in the Hebrew צִבְי / *tsibi*, both terms being applicable to the whole group; and the Hebrew name is by distant nations now used for

allied species which are unknown in Arabia and Syria. Thus the Bechuana Hottentots give the name of *tsébi*, and the Caffres that of *teshe*, to the *gazella euchores* or springbok of the Cape. The term *dorcas* was apparently generalized so as to include the roebuck of Europe, which was certainly not, as in our translation, the *tsébi* of Scripture. It appears from Hermolaus that neither Aristotle nor Dioscorides confounded such distinct genera, and that they used the term *dorcæ* for the species with persistent horns, and *dorcæ* for the roebuck, whose horns are annually renewed. This confusion, created by the classical grammarians of antiquity, was further increased by schoolmen and sportsmen constantly confounding fallow-deer with roebuck till within the seventeenth century, as is plainly perceptible in the writings of Gesner, that mine of zoological lore, not sufficiently consulted by Scriptural commentators. The Biblical species clearly included in the section gazella are *Antelope dorcas*, Linn., *Ariel* or *A. Arabica*, Licht.; more remotely, *A. kevelia*, *A. corinna*, auctor.; and for Eastern Arabia, *A. cora*, Ham. Smith; while *A. subgutturosa*, Guldenst., may be claimed for the north-eastern countries, where the species exists both in Asia Minor and Armenia, and therefore on the borders of Syria. All these species are nearly allied, the largest not measuring more than two feet in height at the shoulder, and the least, the corinna, not more than about twenty inches. They are graceful and elegant in form, with limbs exceedingly slender, and have large and soft eyes, lyrated horns, black, wrinkled, and striated—most robust in *subgutturosa* and *kevelia*, most slender in *corinna*, and smallest in *cora*. Their livery is more or less buff and dun, white beneath, with small tufts of hair or brushes on the fore-knees: they have all a dark streak passing from each ear through the eyes to the nostrils, and a band of the same colour from the elbow of the fore-leg along the sides to the flank, excepting the corinna, whose markings are more rufous and general colours lighter. Most, if not all, have a feeble bleating voice, seldom uttered, are unsurpassed in graceful timidity, gregarious in habit, and residents on the open deserts, where they are unceasingly watchful, and prepared to flee with such speed, that greyhounds are liable to be killed by over exertion in the chase. Of the species here enumerated, all, but more especially *A. Arabica*, *A. dorcas*, and *A. cora*, must have been designated by the terms *dorcas* and *tsébi*, and the Arabic *tsébi*; generically, *Gazal*. The Chaldee *tabitha*, and Persic *zæbegat*, may refer more immediately to *A. subgutturosa*, the *ahu* of Kæmpfer, *tséiran* of modern Persia, and *gairou* of the Turks.

One or other of these, according to geographical localities, occurs in the Authorized Version under the name of *roe*; in Deut. xii. 15, 22; xiv. 5; xv. 22; 1 Kings iv. 23; 1 Chron. xii. 8; 2 Sam. ii. 8; Prov. vi. 5; vii. 3; viii. 14; Isa. xiii. 14; *dorcas*, Eccles. xxvii. 20.—C. H. S.

ANTHROPOMORPHISM, a term in theology used to denote that figure whereby words derived from human objects are employed to express something which relates to the Deity. As a finite being can have no intuitive knowledge of an infinite, so no language of rational creatures can fully express the nature of God and render it comprehensible. All further knowledge of

God must be communicated by words used to express ourselves intelligibly concerning human and other terrestrial objects. Such words and phrases have their foundation in a resemblance, which, according to our conceptions, exists between the Deity and mankind. This resemblance, when essential, is such as regards the pure perfections of our minds, that is, such as are unaccompanied with any imperfection, as reason, liberty, power, life, wisdom, and goodness. Those expressions afford an analogical knowledge, from whence arise analogical phrases, which are absolutely necessary whenever we speak of God, and would acquire or communicate some knowledge of his perfections. Such analogical expressions must, however, be understood *properly*, although they give no immediate and intuitive, but only a symbolical knowledge of the Deity. In this sense it is that in Gen. ii. 16; iii. 9; vi. 13; xii. 1; xv.; xvii.; xviii.; Exod. iii. 4, 5—*speech is immediately* ascribed to the Deity while addressing Adam, Noah, Abraham, and Moses. The Deity is also in this sense said to speak *mediately* to man, viz. by his messengers. But although the speech here ascribed to the Deity is to be understood in a different manner from the language of men, it is not to be understood in such instances figuratively, or in the anthropomorphic sense, but *really* and *properly*. 'Either,' says St. Augustin, 'immutable truth speaks to man ineffably of itself to the minds of rational creatures, or speaks by a mutable creature, either by spiritual images to our minds, or by corporeal voices to the bodily senses.' But God speaks not *properly*, but *anthropopathically*, when his decrees and their execution are described in human methods, or in the form of dialogues and conversations, as in the phrase (Gen. i. 2) 'Let there be light, and there was light.' 'This,' says Maimonides, 'is to be understood of the will, not the speech;' and, in like manner, St. Augustin, 'This was performed by the intellectual and eternal, not by the audible and temporal word' (*City of God*, ch. vii.).

Anthropomorphic phrases, generally considered, are such as ascribe to the Deity mixed perfections and human imperfections. These phrases may be divided into three classes, according to which we ascribe to God:—

1. Human actions (*ἀνθρωποποιήσις*).
2. Human affections, passions, and sufferings (anthropopathy).
3. Human form, human organs, human members (anthropomorphism).

A rational being, who receives impressions through the senses, can form conceptions of the Deity only by a consideration of his own powers and properties. Anthropomorphic modes of thought are therefore unavoidable in the religion of mankind; and although they can furnish no other than corporeal or sensible representations of the Deity, they are nevertheless true and just when we guard against transferring to God qualities pertaining to the human senses. It is, for instance, a *proper* expression to assert that God *knows* all things; it is improper, that is, tropical or anthropomorphic, to say that He *sees* all things. Anthropomorphism is thus a species of *accommodation* (which see), inasmuch as by these representations the Deity as it were lowers himself to the comprehension of men. And it is

altogether consonant to his wisdom and benevolence in communicating divine revelations to address mankind in language adapted to their inferior capacities. Therefore it is that this figure is called by the Fathers *Divine Economy* (Theodoret, *Dialog.* 2) and *Condescension* (Gregory of Nazianzus, *Orat.* 1).

'Divine affections,' says Tertullian, 'are ascribed to the Deity by means of figures borrowed from the human form, not as if he were endued with corporeal qualities: when eyes are ascribed to him, it is denoted that he sees [viz. knows] all things; when ears, that he hears all things; the speech denotes the will; nostrils, the perception of prayer; hands, creation; arms, power; feet, immensity; for he has no members, and performs no office for which they are required, but executes all things by the sole act of his will. How can he require eyes, who is light itself? or feet, who is omnipresent? How can he require hands, who is the silent creator of all things? or a tongue, to whom to think is to command. Those members are necessary to men, but not to God, inasmuch as the counsel of men would be inefficacious unless his thoughts put his members in motion;—but not to God, whose operations follow his will without effort.'

In the same manner human affections, as grief, repentance, anger, revenge, jealousy, &c., are ascribed to the Deity. These affections are not, properly speaking, in the mind of God, who is infinitely happy and immutable, but are ascribed to him anthropopathically by way of similitude. For instance, when God forgives the penitent what he had denounced against the wicked who continue in sin, he is said to act as men do in similar cases. Thus St. Augustin observes, 'By repentance is signified a change of events. For as a man when he repents bewails the crime which he had committed, so, when God alters anything unexpectedly, that is, beyond man's expectation, he, figuratively, is said to have repented of the punishment when man repents of the sin' (Ps. cx.). Thus also, when ignorance is ascribed to the Deity (Gen. iv. 9), the same Father remarks, 'He inquires, not as if really ignorant, but as a judge interrogates a prisoner;' and Luther, in reference to the passage (Ps. ii. 4) where laughter is ascribed to the Deity, thus observes, 'Not that God laughed as men do, but to point out the absurdity of men's undertaking impossibilities; meaning, that the matter was as ridiculous as it would be for a fool with a long stick to attempt to thrust the sun out of the firmament, and to rejoice as if he had performed his task to admiration' (*Works*, ii. Ep. ps. 37).

Anthropomorphic phrases are found throughout the whole Scriptures of the Old and New Testaments. In the infancy of mankind conceptions derived from the human senses were universal, and the Deity is constantly spoken of in anthropomorphic phrases. We find these ideas more pure after the times of Moses, who forbade the making of any representation of the Deity (see DECALOGUE). The conceptions of men became still less sensual in the times of the Prophets, who propounded still clearer notions of the sublime perfections of the Deity. But even under the Christian dispensation anthropomorphic modes of expression were unavoidable; for although Christianity imparts purer and more spiritual

sentiments than the former revelations, the inspired teachers could not express themselves without the aid of images derived from human objects, if they would make their communications in regard to divine things intelligible to their hearers, who were habituated to the anthropomorphic expressions of the Old Testament. Such a mode of teaching was therefore indispensable in itself, and tended to promote the instruction and enlightenment of mankind; 'the attention was more easily kept up among the sensuous hearers and readers of the sayings and writings of Jesus and his apostles; the truths, figuratively presented, made a deeper impression on the mind; it introduced variety into the discourse; the affections were moved, and religious instruction the more readily communicated' (see Seiler's *Biblical Hermeneutics*, part i. sect. 2, § 54-62, London, 1835, and Glass's *Philologia Sacra*).—W. W.

ANTICHRIST. The meaning attached to this word has been greatly modified by the controversies of various churches and sects. In Scripture, however, and the early Christian writers, it has an application sufficiently distinct from partial interpretations. Antichrist, according to St. John, is the ruling spirit of error, the enemy of the truth of the Gospel as it is displayed in the divinity and holiness of Christ. This is the primary meaning of the term, and we are led at once to consider it as the proper title of Satan. But the same apostle speaks of the existence of many antichrists; whence we learn that it is applicable to any being who opposes Christ in the high places of spiritual wickedness. St. Paul speaks of 'the man of sin' as not yet revealed, and it is supposed by most interpreters that *antichrist* is to be understood as the object alluded to by the apostle; but if we attend strictly to his words, the antichrist of whom he spoke must have been then, and at the time when he was writing, 'opposing and exalting himself above all that is called God,' although awaiting some distant season for the open display of his power and wickedness. Justin Martyr, in his *Dialogue with Trypho*, describes him as exercising his wrath against Christians with especial fury in the period immediately preceding the Second Advent. Cyril of Jerusalem represents him as reigning three years and six months preparatory to the entire destruction of his dominion at the second coming of Christ. The same Father says that he will deceive both Jews and Gentiles; the former, by representing himself as the Messiah; the latter, by his magical arts and incantations. St. Chrysostom observes, on the passage in the Second Epistle to the Thessalonians, that antichrist will not lead men to idolatry, but will rather abolish the worship of false gods as well as that of the true God, commanding the world to worship himself alone as the only Deity.

These views of the early writers, as well as the expressions of Scripture, have been perverted by many men of warm imaginations to the worst purposes of controversy. The effects of general corruption have often been charged upon offices and individuals; and the appellation of *antichrist* as readily applied to them as if it had actually been coupled in Scripture with their name and titles.—H. S.

ANTILEGOMENA (*ἀντιλεγόμενα*, *contradicted or disputed*), an epithet applied by the early

Christian writers to denote those books of the New Testament which, although known to all the ecclesiastical writers, and sometimes publicly read in the churches, were not for a considerable time admitted to be genuine, or received into the canon of Scripture. These books are so denominated in contradistinction to the *Homologoumena*, or universally acknowledged writings. The following is a catalogue of the *Antilegomena*:—*The Second Epistle of St. Peter*.—*The Epistle of St. James*.—*The Epistle of St. Jude*.—*The Second and Third Epistles of St. John*.—*The Apocalypse, or Revelation of St. John*.—*The Epistle to the Hebrews*.

The earliest notice which we have of this distinction is that contained in the *Ecclesiastical History* of Eusebius, the learned bishop of Caesarea, who flourished A.D. 270-340. He seems to have formed a triple, or, as it appears to some, a quadruple division of the books of the New Testament, terming them—1, the *homologoumena* (received); 2, the *antilegomena* (controverted); 3, the *notha* (spurious); and, 4, those which he calls the *utterly spurious*, as being not only spurious in the same sense as the former, but also *absurd* or *impious*. Among the *spurious* he reckons the *Acts of Paul*, the *Shepherd of Hermas*, the *Revelation of Peter*, the *Epistle of Barnabas*, and the *Instructions of the Apostles*. He speaks doubtfully as to the class to which the *Apocalypse* belongs, for he himself includes it among the *spurious*: he then observes that some reject it, while others reckon it among the *acknowledged* writings (*homologoumena*). Among the *spurious* writings he also enumerates the *Gospel according to the Hebrews*. He adds, at the same time, that all these may be classed among the *antilegomena*. His account is consequently confused, not to say contradictory. Among the *utterly spurious* he reckons such books as the heretics brought forward under pretence of their being genuine productions of the apostles, such as the so-called *Gospels of Peter, Thomas, and Matthias*, and the *Acts of Andrew, John, and the other apostles*. These he distinguishes from the *antilegomena*, as being works which not one of the ancient ecclesiastical writers thought worthy of being cited. Their style he considers so remote from that of the apostles, and their contents so much at variance with the genuine doctrines of Scripture, as to show them to have been the inventions of heretics, and not worthy of a place even among the *spurious* writings. These latter he has consequently been supposed to have considered as the compositions of orthodox men, written with good intentions, but calculated by their titles to mislead the ignorant, who might be disposed to account them as apostolical productions, to which honour they had not even a dubious claim. (See Eusebius, *Hist. Eccles.* iii. 5, 25.)

The same historian has also preserved the testimony of Origen, who, in his *Commentary on St. John* (cited by Eusebius), observes: 'Peter, upon whom the church of Christ is built, against which the gates of hell shall not prevail, has left one epistle undisputed; it may be, also, a second, but of this there is some doubt. What shall we say of him who reclined on the breast of Jesus, John, who has left one Gospel, in which he confesses that he could write so many that the whole world could not contain them? He also wrote the *Apocalypse*, being commanded to conceal, and

not to write, the voices of the seven thunders. He has also left us an epistle consisting of very few lines (*στίχοι*); it may be also a second and third are from him, but all do not concur in their genuineness; both together do not contain an hundred *stichoi*' (for the signification of this word, see *Christian Remembrancer*, vol. iii. p. 465, *et seq.*). And again, in his *Homilies*, 'The epistle with the title "*To the Hebrews*," has not that peculiar style which belongs to an apostle who confesses that he is but *rude in speech*, that is, in his phraseology. But that this epistle is more pure Greek in the composition of its phrases, every one will confess who is able to discern the difference of style. Again, it will be obvious that the ideas of the apostle are admirable, and not inferior to any of the books acknowledged to be apostolical. Every one will confess the truth of this who attentively reads the apostle's writings. . . . I would say, that the thoughts are the apostle's, but that the diction and phraseology belong to some one who has recorded what the apostle has said, and as one who has noted down at his leisure what his master dictated. If, then, any church considers this epistle as coming from Paul, let him be commended for this, for neither did these eminent men deliver it for this without cause: but who it was that really wrote the epistle God only knows. The account, however, that has been current before our time is, according to some, that Clement, who was bishop of Rome, wrote the epistle; according to others, that it was written by Luke, who wrote the *Gospel* and the *Acts*.' (Euseb. *Hist. Eccles.* vi. 25.)

Upon other occasions Origen expresses his doubts in regard to the *antilegomena*, as, where, in his commentary on St. John's Gospel, he speaks of the reputed (*φερούμεν*) *Epistle of James*, and in his commentary on Matthew, where he uses the phrase, 'If we acknowledge the Epistle of Jude; and of the Second and Third Epistles of John he observes that 'all do not acknowledge them as *genuine*;' by which epithet, we presume, he means, written by the persons to whom they are ascribed. It is remarkable that Eusebius (ii. 23; iii. 25) classes the Epistle of James, the Acts of Paul, the Shepherd of Hermas, and the Epistle of Barnabas, at one time with the *spurious*, and at another with the *antilegomena*. By the word *spurious*, in this instance at least, he can mean no more than that the genuineness of such books was disputed; as for instance the *Gospel of the Hebrews*, which was received by the Ebionites as a genuine production of the evangelist Matthew. This is the work of which Jerome made a transcript, as he himself informs us, from the copy preserved by the zeal of Pamphilus in the Caesarean Library. He also informs us that he translated it into Greek, and that it was considered by most persons as the original Gospel of St. Matthew (*Dialog. contra Pelag.* iii. 2, and *Comment. in Matt.* xii.). Whether the Shepherd of Hermas was ever included among the *antilegomena* seems doubtful. Eusebius informs us that 'it was disputed, and consequently not placed among the *homologoumena*. By others, however, it is judged most necessary, especially to those who need an elementary introduction: hence we know that it has been already in public use in our churches, and I have also understood, by tradition, that some of the most ancient writers have made use

of it' (iii. 3). Origen speaks of *The Shepherd* as 'commonly used by the church, but not received as divine by the unanimous consent of all.' He therefore cites it, not as authority, but simply by way of illustration (lib. x. in *Epist. ad Roman.*).

Eusebius further informs us that in his own time there were some in the church of Rome who did not regard the Epistle to the Hebrews as the production of the apostle Paul (vi. 25; iii. 3). Indeed, it was through the influence of Jerome that the church of Rome, at a much later period, was with much difficulty brought to acknowledge it as canonical. 'The most ancient Latin or Western church did not rank it among the canonical writings, though the epistle was well known to them, for Clement of Rome has quoted from it many passages. It is true that some Latin writers in the fourth century received it, among whom was Jerome himself; yet even in the time of Jerome the Latin church had not placed it among the canonical writings' (Marsh's *Michaelis*, vol. iv. p. 266). 'The reputed Epistle to the Hebrews,' says Jerome, 'is supposed not to be Paul's on account of the difference of style, but it is believed to have been written by Barnabas, according to Tertullian, or by Luke the evangelist; according to others, by Clement, afterwards bishop of the Roman church, who is said to have reduced to order and embellished Paul's sentiments in his own language; or at least that Paul, in writing to the Hebrews, had purposely omitted all mention of his name, in consequence of the odium attached to it, and wrote to them eloquently in Hebrew, as a Hebrew of the Hebrews, and that what he thus eloquently wrote in Hebrew was still more eloquently written in Greek, and that this was the cause of the difference in style' (*Ex Catalog.*). And again, in his epistle to Dardanus: 'I must acquaint our people that the epistle which is inscribed "To the Hebrews" is acknowledged as the apostle Paul's, not only by the churches of the East, but by all the Greek ecclesiastical writers, although most [of the Latins?] conceive it to be either written by Barnabas or Clement, and that it matters nothing by whom it was written, as it proceeds from a churchman (*ecclesiastici viri*), and is celebrated by being daily read in the churches. But if the custom of the Latins does not receive it among the canonical Scriptures, nor the Greek churches the Apocalypse of St. John, I, notwithstanding, receive them both, not following the custom of the present age, but the authority of ancient writers, not referring to them as they are in the habit of doing with respect to apocryphal writings, and citations from classical and profane authors, but as canonical and ecclesiastical.' 'Peter also,' says Jerome, 'wrote two epistles called Catholic; the second of which is denied by most, on account of the difference of style' (*Ex Catalog.*). Jude is rejected by most in consequence of the citation from the apocryphal book of Enoch. Notwithstanding, it has authority by use and antiquity, and is accounted among the Holy Scriptures' (*Ibid.*); and in his *Letter to Paulinus*: 'Paul wrote to seven churches, but the Epistle to the Hebrews is by most excluded from the number; and in his commentary on Isaiah, he observes that 'the Latin usage does not receive the Epistle to the Hebrews among the canonical books.'

Contemporary with St. Jerome was his antagonist Rufinus, who reckons *fourteen* epistles of Paul, two of Peter, one of James, three of John, and the Apocalypse.

It seems doubtful whether, antecedent to the times of Jerome and Rufinus, any councils, even of single churches, had settled upon the canon of Scripture, and decided the question respecting the antilegomena, for the removal of doubts among their respective communities; for it seems evident that the general or œcumenical Council of Nice, which met in the year 325, formed no catalogue. The first catalogue, indeed, which has come down to us is that of an anonymous writer of the third century. He reckons thirteen epistles of St. Paul, accounts the Epistle to the Hebrews the work of an Alexandrian Marcionite, mentions the Epistle of Jude, two of John, and the Revelations of John and Peter, saying with respect to them, that 'some among us are opposed to their being read in the church' (see Hugg's *Introduction*, sect. xiv.). But soon after the Council of Nice, public opinion turned gradually in favour of the antilegomena, or controverted books; for we then find them for the first time cited without any marks of doubt as to their canonicity. Thus, in the year 348, Cyril of Jerusalem enumerates fourteen epistles of Paul and seven Catholic epistles. Gregory of Nazianzus, who, according to Cave (*Historia Literaria*), was born about the time of the Nicene Council, and died in 389, enumerates all the books now received, except the Apocalypse.

Epiphanius, who was chosen bishop of Constantia in A.D. 367 or 368, and composed his Catalogue of Ecclesiastical Writers in 392, cites, in his *Panarium*, the different books of the New Testament in a manner which shows that he received all that are in the present canon. Of the Apocalypse he says that it was 'generally or by most received;' and, speaking of the Alogians, who rejected all John's writings, he observes, 'If they had rejected the Apocalypse only, it might have been supposed that they had acted from a nice critical judgment, as being circumspect in regard to an apocryphal or mysterious book: but to reject all John's writings was a sign of an anti-Christian spirit.' Amphilochius also, bishop of Iconium, in Lycaonia, who was contemporary with Epiphanius, and is supposed to have died soon after the year 394, after citing the fourteen epistles of Paul, in his *Iambics*, adds, 'But some say the Epistle to the Hebrews is spurious, not speaking correctly, for it is a genuine gift. Then the Catholic Epistles, of which some receive seven, others only three, one of James, one of Peter, one of John; while others receive three of John, two of Peter, and Jude's. The Revelation of John is approved by some, while many say it is spurious.'

The eighty-fifth of the *Apostolical Canons*, a work falsely ascribed to Clement of Rome, but written at latest in the fourth century, enumerates *fourteen* Epistles of St. Paul, one of Peter, three of John, one of James, one of Jude, two of Clement, and the (so called) *Apostolical Constitutions*, among the canonical books of Scripture. This latter book, adds the pseudo-Clement, it is not fit to publish before all, 'because of the mysteries contained in it.'

The first council that is supposed to have

given a list of the canonical books is the much agitated Council of Laodicea, supposed to have been held about the year 360 or 364, by thirty or forty bishops of Lydia and the neighbouring parts; but the 59th article, which gives a catalogue of the canonical books, is not generally held to be genuine. Its genuineness, indeed, has been questioned by both Roman Catholic and Protestant historians. In his Introduction to the Old Testament, Jahn refers to this canon as the work of 'an anonymous framer.' Among the canonical books included in the pretended 59th canon of this council are the seven Catholic epistles, viz., one of James, two of Peter, three of John, one of Jude, fourteen of Paul, in the following order, viz.: Romans, 1 and 2 Corinthians, Galatians, Ephesians, Philippians, Colossians, 1 and 2 Thessalonians, Hebrews, 1 and 2 Timothy, Titus, and Philemon. The Apocalypse is not named.

We now come to the times of Jerome and Augustin, whose opinions had great influence in settling the canon of Scripture. We have already seen Jerome's sentiments on this subject; and in regard to the books of the New Testament Augustin entertained the same views. He was present in the year 393 at the Council of Hippo, which drew up a catalogue of all the books of Scripture, agreeing in all points, so far as the New Testament was concerned, with the canon universally received, with the exception perhaps of the Hebrews, for the ancient doubt still appears through the wording of the acts of this council. They commence with enumerating only *thirteen* epistles of Paul, and then add 'one, by the same author, to the Hebrews.' They then mention *two* of Peter, three of John, one of James, and the Apocalypse, with a proviso that the churches beyond the sea be consulted with respect to this canon. And to the same effect the Council of Carthage, held in the year 397, having adopted the same catalogue, the bishops assembled in council add: 'But let this be known to our brother and fellow-priest (consacerdoti) Boniface [bishop of Rome], or to the other bishops of those parts, that we have received those [books] from the Fathers to be read in the church.' The same catalogue is repeated in the Epistle of Innocent I., bishop of Rome, to St. Exupere, bishop of Toulouse, in the year 404, which, by those who acknowledge its genuineness, is looked upon as a confirmation of the decrees of Hippo and Carthage. It was still more formally confirmed in the Roman synod presided over by Pope Gelasius in 494, 'if, indeed,' to use the words of the learned Roman Catholic Jahn, '*the acts of this synod are genuine*' (see his Introduction). But, however this may be, the controversy had now nearly subsided, and the antilegomena were henceforward put on a par with the acknowledged books, and took their place beside them in all copies of the Scriptures. Indeed, subsequently to the eras of the councils of Hippo and Carthage, we hear but a solitary voice raised here and there against the genuineness of the *antilegomena*. Theodore, bishop of Mopsuestia, for instance, the celebrated Syrian commentator and preacher, who died about A.D. 428, is accused by Leo of Byzantium of having 'abrogated and antiquated the Epistle of St. James, and afterwards other Catholic epistles' (see Canisii *Theaurus*, i. p. 577). And Cosmas Indicopleustes, so called from the voyage

which he made to India about the year 535 to 547, in his *Christian Topography*, has the following observations in reference to the authority of these books: 'I forbear to allege arguments from the Catholic epistles, because from ancient times the church has looked upon them as of doubtful authority. . . . Eusebius Pamphilus, in his *Ecclesiastical History*, says that at Ephesus there are two monuments, one of John the Evangelist, and another of John, an Elder, who wrote two of the Catholic epistles, the second and third inscribed after this manner, "The Elder to the elect lady," and "The Elder to the beloved Gaius," and both he and Irenæus say that but two are written by the apostles, the first of Peter, and the first of John. . . . Among the Syrians are found only the three before mentioned, viz., the Epistle of James, the Epistle of Peter, and the Epistle of John; they have not the rest. It does not become a perfect Christian to confirm anything by doubtful books, when the books in the Testament acknowledged by all (homologoumena) have sufficiently declared all things to be known about the heavens, and the earth, and the elements, and all Christian doctrine.'

The most ancient Greek manuscripts which have come down to our times contain the *antilegomena*. From this circumstance it is extremely probable that the copies from which they were transcribed were written after the controversies respecting their canonicity had subsided. The Alexandrian manuscript in the British Museum contains all the books now commonly received, together with some others, with a table of contents, in which they are cited in the following order:—'Seven Catholic Epistles, fourteen of Paul, the Revelation of John, the First Epistle of Clement, the Second Epistle of Clement, and the Psalms of Solomon (which latter have, however, been lost from the MS.)' It is observable that Eusebius classes the First Epistle of Clement among the Homologoumena, or universally received books; but by this he probably meant no more than that it was acknowledged by all to be the genuine work of Clement. The Alexandrian manuscript is now generally believed to have been written either in the fourth or early in the fifth century. The order of all the epistles is the same as in our modern Bibles, except that the Epistle to the Hebrews is placed after the Second Epistle to the Thessalonians. In the Vatican manuscript B, which in respect of antiquity disputes the precedence with the Alexandrian, the Apocalypse is wanting, but it contains the remaining *antilegomena*.

The Syrian canon of the New Testament did not include all the *antilegomena*. All the manuscripts of the Syrian version (the Peschito, a work of the second century) which have come down to us omit the Second Epistle of Peter, the Second and Third of John, that of Jude, and the Apocalypse. Nor are these books received to this day either by the Jacobite or Nestorian Christians. These are all wanting in the Vatican and Medicean copies, written in the years 548 and 586, and in the beautiful manuscript of the Peschito, preserved in the British Museum, which is most accurately described by the Rev. J. Forshall, in the catalogue of the Oriental Manuscripts, and the writing of which was concluded at the monastery of Bethkoki, A.D. 768. It is written

on 197 leaves of vellum, in the Estrangelo character.

In the inquiring age immediately preceding the Reformation the controversy respecting the *antilegomena* was revived, especially by Erasmus and Cardinal Cajetan; by the latter, however, upon principles so questionable as to expose him to the charge of assailing the authority of the Epistle to the Hebrews with the same weapons which the emperor Julian had employed to impugn the authority of St. Matthew's Gospel. The doubts thus raised were in a great measure silenced by the decree of the Council of Trent, although there have not been wanting learned Roman Catholic divines since this period who have ventured to question at least the Pauline authorship of the Epistle to the Hebrews. It is well known that Luther, influenced in this instance not so much by historico-critical as by dogmatical views, called the Epistle of St. James 'an epistle of straw' (*Epistola straminea*). He also wished the *antilegomena* to be distinguished from the other books in his translation of the Bible. In consequence of this, the Epistle to the Hebrews, the Epistles of James and Jude, and the Apocalypse have no numbers attached to them in the German copies of the Bible up to the middle of the seventeenth century: and it is observed by M. Tholuck (*Commentary on Hebrews, in Biblical Cabinet*), that 'the same plan should have been adopted with respect to 2nd Peter and 2nd and 3rd John, but it did not seem proper to detach them from the *Homologumena* which belonged to them. Thus he wished at the same time to point out what were the 'right noble chief books of Scripture.' We are informed by Father Paul Sarpi (*History of the Council of Trent*, book ii. chap. xliii. tom. i. p. 235; and chap. xlvii. p. 240) that one of the charges collected from the writings of Luther in this council was, 'that no books should be admitted into the canon of the Old Testament which were not in the canon of the Jews, and that from the New should be excluded the Epistle to the Hebrews, the Epistle of James, the Second Epistle of Peter, the Second and Third of John, and the Apocalypse.' M. Tholuck states that the 'Evangelical churches, both Lutheran and Reformed, adopted the same canon with respect to the New Testament as that of the Council of Trent' (*Comment. on Heb.* vol. i. Introd. chap. i. § 3, and note *b*). Some, or all, of the *antilegomena* have been again impugned in recent times, especially in Germany, as the reader will find noticed under their several heads.—W. W.

ANTI-LIBANUS. [LEBANON.]

ANTIOCH (*Ἀντιόχεια*). Two places of this name are mentioned in the New Testament. 1. A city on the banks of the Orontes, 300 miles north of Jerusalem, and about 30 from the Mediterranean. It was situated in the province of Seleucia, called Tetrapolis (*Τετραπόλις*), from containing the four cities, Antioch, Seleucia, Apamea, and Laodicea: of which the first was named after Antiochus, the father of the founder; the second after himself; the third after his wife Apamea, and the fourth in honour of his mother. The same appellation (*Tetrapolis*) was given also to Antioch, because it consisted of four townships or quarters, each surrounded by a separate wall, and all four by a common wall. The first was built by Seleucus Nicator, who peopled it

with inhabitants from Antiochia; the second by the settlers belonging to the first quarter; the

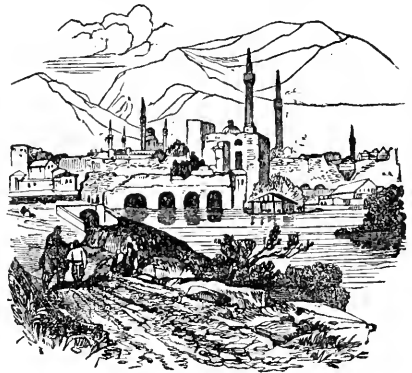

third by Seleucus Callinicus; and the fourth by Antiochus Epiphanes (Strabo, xvi. 2; iii. 354). It was the metropolis of Syria (*Antiochiam, Syriae caput*. Tac. *Hist.* ii. 79), the residence of the Syrian kings (the Seleucidae) (1 Macc. iii. 37; vii. 2), and afterwards became the capital of the Roman provinces in Asia. It ranked third, after Rome and Alexandria, among the cities of the empire (Joseph. *De Bell. Jud.* iii. 2, § 4), and was little inferior in size and splendour to the latter, or to Seleucia (Strabo, xvi. 2; vol. iii. p. 355, ed. Tauch.). Its suburb Daphne was celebrated for its grove and fountains (Strabo, xvi. 2; vol. iii. p. 356, ed. Tauch.), its asylum (*ἄσυλον τόπον*, 2 Macc. iv. 33) and temple dedicated to Apollo and Diana. 'The temple and the village were deeply bosomed in a thick grove of laurels and cypresses which reached as far as a circumference of ten miles, and formed in the most sultry summers a cool and impenetrable shade. A thousand streams of the purest water, issuing from every hill, preserved the verdure of the earth and the temperature of the air' (Gibbon, ch. xxiii.). Hence Antioch was called Epidaphnes (*Ἀντιόχεια τῇ ἐπὶ Δάφνῃ*, Joseph. *Antiq. Jud.* xvii. 2; *Epidaphnes cognominata*, Plin. *Hist. Nat.* v. 18). It was very populous; within 150 years after its erection the Jews slew 100,000 persons in it in one day (1 Macc. xi. 47). In the time of Chrysostom the population was computed at 200,000, of whom one-half, or even a greater proportion, were professors of Christianity (*τὸ πλεόν τῆς πόλεως χριστιανόν*, Chrysos. *Adv. Jud. Orat.* t. i. p. 588; *Hom. in S. Ignat.* t. ii. p. 597; *In Matt. Hom.* 85, t. vii. p. 810). Chrysostom also states that the church at Antioch maintained 3000 poor, besides occasionally relieving many more (*In Matt. Hom.* t. vii. p. 658). Cicero speaks of the city as distinguished by men of learning and the cultivation of the arts (*Pro Archia*, 3). A multitude of Jews resided in it. Seleucus Nicator granted them the rights of citizenship, and placed them on a perfect equality with the other inhabitants (Joseph. *Antiq.* xii. 3, § 1). These privileges were continued to them by Vespasian and Titus—an instance (Josephus remarks) of the equity and generosity of the Romans, who, in opposition to the wishes of the Alexandrians and Antiocheans, protected the

Jews, notwithstanding the provocations they had received from them in their wars. They were also allowed to have an Archon or Ethnarch of their own (Joseph. *De Bell. Jud.* vii. 3). Antioch is called *libera* by Pliny (*Hist. Nat.* v. 18), having obtained from Pompey the privilege of being governed by its own laws. This fact is commemorated on a coin bearing the inscription, **ANTIOXEON ΜΗΤΡΟΠΟΛΙΣ ΑΥΤΟΝΟΜΟΥ**.

The Christian faith was introduced at an early period into Antioch, and with great success (Acts xi. 19, 21, 24). The name 'Christians' was here first applied to its professors (Acts xi. 26). Antioch soon became a central point for the diffusion of Christianity among the Gentiles, and maintained for several centuries a high rank in the Christian world. A controversy which arose between certain Jewish believers from Jerusalem and the Gentile converts at Antioch respecting the permanent obligation of the rite of circumcision was the occasion of the first apostolic council or convention (Acts xv.). Antioch was the scene of the early labours of the apostle Paul, and the place whence he set forth on his first missionary labours (Acts xi. 26; xiii. 2). Ignatius was the second bishop or overseer of the church, for about forty years, till his martyrdom in A.D. 107. In the third century three councils (the last in A.D. 269) were held at Antioch relative to Paul of Samosata, who was bishop there about A.D. 260 (Neander's *Allgemeine Geschichte*, &c. i. 3, p. 1013; Gieseler's *Lehrbuch*, i. 242; Moshemii *Commentarii*, p. 702). In the course of the fourth century a new theological school was formed at Antioch, which aimed at a middle course in Biblical Hermeneutics, between a rigorously literal and an allegorical method of interpretation. Two of its most distinguished teachers were the presbyters Dorotheus and Lucian, the latter of whom suffered martyrdom in the Dioclesian persecution, A.D. 312 (Neander's *Allgemeine Geschichte*, i. 3, p. 1237; Gieseler's *Lehrbuch*, i. 272; Lardner's *Credibility*, pt. ii. ch. 55, 58). Libanius (born A.D. 314), the rhetorician, the friend and panegyrist of the emperor Julian, was a native of Antioch (Lardner's *Testimonies of Ancient Heathens*, ch. 49; Gibbon's *Decline and Fall*, &c. ch. 24). It had likewise the less equivocal honour of being the birthplace of his illustrious pupil, John Chrysostom (born A.D. 347; died A.D. 407) (Lardner's *Credibility*, pt. ii. ch. 118; Neander's *Allgemeine Geschichte*, ii. 3, pp. 1440-56).

As the ecclesiastical system became gradually assimilated to the political, the churches in those cities which held the highest civil rank assumed a corresponding superiority in relation to other Christian communities. Such was the case at Rome, Alexandria, and Antioch, and, in the course of time, at Constantinople and Jerusalem, where the term Exarch was applied to the resident bishop, but shortly exchanged for that of Patriarch (Neander, *Allg. Gesch.* ii. 1, p. 346-51). At the present time there are three prelates in Syria who claim the title of patriarchs of Antioch, namely: (1) the patriarch of the Greek church; (2) of the Syrian Monophysites; (3) of the Maronites (Murdoch's *Mosheim*, edited by Soames, p. 304-11).

Few cities have undergone and survived greater vicissitudes and disasters than Antioch.

In A.D. 260 Sapor, the Persian king, surprised and pillaged it, and multitudes of the inhabitants were slain or sold as slaves. It has been frequently brought to the verge of utter ruin by earthquakes (A.D. 340, 391, 396, 458, 526, 528) by that of A.D. 526 no less than 250,000 persons were destroyed, the population being swelled by an influx of strangers to the festival of the Ascension. The emperor Justinian gave forty-five centuries of gold (180,000*l.*) to restore the city. Scarcely had it resumed its ancient splendour (A.D. 540) when it was again taken and delivered to the flames by Chosroes. In A.D. 658 it was captured by the Saracens. Its 'safety was ransomed with 300,000 pieces of gold, but the throne of the successors of Alexander, the seat of the Roman government in the East, which had been decorated by Cæsar with the titles of free and holy and inviolate, was degraded under the yoke of the caliphs to the secondary rank of a provincial town' (Gibbon, ch. 51). In A.D. 975 it was retaken by Nicephorus Phocas. In A.D. 1080 the son of the governor Philaretus betrayed it into the hands of Soliman. Seventeen years after the Duke of Normandy entered it at the head of 300,000 Crusaders; but as the citadel still held out, the victors were in their turn besieged by a fresh host under Kerbogha and twenty-eight emirs, which at last gave way to their desperate valour (Gibbon, ch. 55). In A.D. 1268 Antioch was occupied and ruined by Boadochar or Bibars, sultan of Egypt and Syria; this first seat of the Christian name being dispeopled by the slaughter of 17,000 persons, and the captivity of 100,000. About the middle of the fifteenth century the three patriarchs of Alexandria, Antioch, and Jerusalem convoked a synod, and renounced all connection with the Latin church.

Antioch at present belongs to the Pashalic of

Haleb (Aleppo), and bears the name of **انطاكية**

Antakia. The inhabitants are said to have amounted to twenty thousand before the earthquake of 1822, which destroyed four or five thousand. On the south-west side of the town is a precipitous mountain-ridge, on which a considerable portion of the old Roman wall of Antioch is still standing, from 30 to 50 feet high and 15 feet in thickness. At short intervals 400 high square towers are built up in it, containing a staircase and two or three chambers, probably for the use of the soldiers on duty. At the east end of the western hill are the remains of a fortress, with its turrets, vaults, and cisterns. Toward the mountain south-south-west of the city some fragments of the aqueducts remain. After heavy rains antique marble pavements are visible in many parts of the town; and gems, carnelians, and rings are frequently found. The present town stands on scarcely one-third of the area enclosed by the ancient wall, of which the line may be easily traced; the entrance to the town from Aleppo is by one of the old gates, called Bab Bablous, or Paul's gate, not far from which the members of the Greek church assemble for their devotions in a cavern dedicated to St. John (Madox's *Excursions*, ii. 74; Monro's *Summer Ramble*, ii. 140-143).—J. E. R.

2. **ANTIOCH** in (or near) *Pisidia* (**Ἀντιόχεια τῆς Πισιδίας**), being a border city, was considered at different times as belonging to different pro-

vinces. Ptolemy places it in Pamphylia, and Strabo in Phrygia. It was founded by Seleucus Nicator, and its first inhabitants were from Magnesia on the Meander. After the defeat of Antiochus (III.) the Great by the Romans, it came into the possession of Eumenes, king of Pergamos, and was afterwards transferred to Amyntas. On his death the Romans made it the seat of a proconsular government, and invested it with the privileges of a *Colonia Juris Italici*, which included a freedom from taxes and a municipal constitution similar to that of the Italian towns (Ulpianus, lib. 50: *In Pisidia juris Italici est Colonia Antiochenstum*). When Paul and Barnabas visited this city (Acts xiii. 14), they found a Jewish synagogue and a considerable number of proselytes (*οἱ φοβούμενοι τὸν Θεόν*, v. 16; *τῶν σεβομένων προσήλυτων*, v. 43; *τὰς σεβομένας γυναῖκας*, v. 50), and met with great success among the Gentiles (v. 48), but, through the violent opposition of the Jews, were obliged to leave the place, which they did in strict accordance with their Lord's injunction (v. 51, compared with Matt. x. 14; Luke ix. 5).

Till within a very recent period Antioch was supposed to have been situated where the town of *Ak-Sheker* now stands; but the researches of the Rev. F. Arundell, British chaplain at Smyrna in 1833, confirmed by the still later investigations of Mr. Hamilton, secretary of the Geographical Society, have determined its site to be adjoining the town of Yalobatch; and consequently that Ak-Sheker is the ancient Philomelion described by Strabo (xii. 8.; vol. iii. p. 72, ed. Tauch.). 'In Phrygia Paroreia is a mountainous ridge stretching from east to west; and under this on either side lies a great plain, and cities near it; to the north Philomelion, and on the other side Antioch, called Antioch near Pisidia: the one is situated altogether on the plain; the other on an eminence, and has a colony of Romans.' According to Pliny, Antioch was also called *Cæsarea* (*Insident verticem Pisidæ, quondam Solymi appellati, quorum colonia Cæsarea, eadem Antiochia*, v. 24). Mr. Arundell observed the remains of several temples and churches, besides a theatre and a magnificent aqueduct; of the latter twenty-one arches still remained in a perfect state. Mr. Hamilton copied several inscriptions, all, with one exception, in Latin. Of one the only words not entirely effaced were *ANTIOCHEÆ CAESARI*.

Antioch was noted in early times for the worship of Men Arceus, or Lunus. Numerous slaves and extensive estates were annexed to the service of the temple; but it was abolished after the death of Amyntas (Strabo, xii. 8.; iii. 72). Arundell's *Discoveries in Asia Minor*, London, 1834, i. 268-312; Hamilton's *Researches in Asia Minor, Pontus, and Armenia*, London, 1842, i. 472-474; ii. 437-439; 'Laborde's work on *Syria and Asia Minor* contains a good view of the aqueduct'—*Coins of Antioch*, v. Calmet's *Plates*, vii.—J. E. R.

ANTIOCHUS. Of the many kings who bore this name, Antiochus, called Epiphanes, has the chief claim on our attention in a Biblical Cyclopædia, since in the Books of Maccabees and in the prophecies of Daniel his person is so prominent. Nevertheless, it will be our business to set forth, not that which readers of the Bible can gather for themselves, but such preliminary and

collateral information as will tend to throw light on the position of the Jews towards the Syrian monarchy.

The name Antiochus may be interpreted *he who withstands, or lasts out*; and denotes military prowess, as do many other of the Greek names. It was borne by one of the generals of Philip, whose son, Seleucus, by the help of the first Ptolemy, established himself (B.C. 312) as ruler of Babylon. The year 312 is in consequence the era from which, under that monarchy, time was computed, as, for instance, in the Books of Maccabees. For eleven years more the contest in Asia continued, while Antigonos (the 'one-eyed') was grasping at universal supremacy. At length, in 301, he was defeated and slain in the decisive battle of Ipsus, in Phrygia. Ptolemy, son of Lagus, had meanwhile become master of southern Syria; and Seleucus was too much indebted to him to be disposed to eject him by force from this possession. In fact, the three first Ptolemies (B.C. 323-222) looked on their extra-Egyptian possessions as their sole guarantee for the safety of Egypt itself against their formidable neighbour, and succeeded in keeping the mastery, not only of Palestine and Cœle-Syria, and of many towns on that coast, but of Cyrenæ and other parts of Libya, of Cyprus, and other islands, with numerous maritime posts all round Asia Minor. A permanent fleet was probably kept up at Samos (Polyb. v. 35, 11), so that their arms reached to the Hellespont (v. 34, 7); and for some time they ruled over Thrace (xviii. 34, 5). Thus Syria was divided between two great powers, the northern half falling to Seleucus and his successors, the southern to the Ptolemies; and this explains the titles 'king of the north' and 'king of the south,' in the 11th chapter of Daniel. The lines dividing them was drawn somewhat to the north of Damascus, the capital of Cœle-Syria.

The first Seleucus built a prodigious number of cities with Greek institutions, not, like Alexander, from military or commercial policy, but to gratify ostentation, or his love for Greece. This love, indeed, led him to fix his capital, not at Babylon, where Alexander would have placed it, but in the north of Syria (see *ANTIOCH*); and in extreme old age his life fell a sacrifice to his romantic passion for revisiting his native Macedonia. To people his new cities was often a difficult matter; and this led to the bestowal of premiums on those who were willing to become citizens. Hence we may account for the extraordinary privileges which the Jews enjoyed in them all, having equal rights with Macedonians. At the same time (whether from the example which Alexander had set or from the force of circumstances) that age displayed remarkable tendencies to religious fusion everywhere; inasmuch that—if, with Josephus, we may trust to the letter in the 1st book of Maccabees (xii. 21)—even the Lacedæmonians put in their claim to be regarded as children of Abraham. [See *SPARTA*, on the authenticity of this correspondence.] But there was still another cause which recommended the Jews to the Syrian kings. A nation thus diffused through their ill-compacted empire, formed a band most useful to gird its parts together. To win the hearts of the Jews, was to win the allegiance of a brave brotherhood, who would be devoted to their protector, and who could never make common cause with any

spirit of local independence. For this reason Antiochus the Great, and doubtless his predecessors also, put peculiar trust in Jewish garrisons. In a letter which Josephus has transcribed (*Antiq.* xii. 3, 4) he orders the removal of 2000 Jews of Mesopotamia and Babylonia, with all their goods, into Lydia and Phrygia, for garrison service: and although the authenticity of the letter may be suspicious, it at any rate proves the traditional belief that the earlier kings of the house of Seleucus had transported troops of Jewish families westward for military purposes.



[Antiochus the Great.]

Again: through the great revolution of Asia, the Hebrews of Palestine were now placed nearly on the frontier of two mighty monarchies; and it would seem that the rival powers *bid* against one another for their good will—so great were the benefits showed upon them by the second Ptolemy. Even when a war broke out for the possession of Cœle-Syria, under Antiochus the Great and the fourth Ptolemy (B.C. 218, 217), though the people of Judæa, as part of the battlefield and contested possession, were exposed to severe suffering, it was not the worse for their ultimate prospects. Antiochus at least, when at a later period (B.C. 198) left master of southern Syria, did but take occasion to heap on the Jews and Jerusalem new honours and exemptions (*Joseph. Antiq.* xii. 3, 3). In short, in days in which no nation of those parts could hope for political independence, there was none which seemed so likely as the Hebrew nation to enjoy an honourable social and religious liberty.

The Syrian empire, as left by Antiochus the Great to his son, was greatly weaker than that which the first Seleucus founded. Scarcely, indeed, had the second of the line begun to reign (B.C. 280) when four sovereigns in Asia Minor established their complete independence:—the kings of Pontus, Bithynia, Cappadocia, and Pergamus. In the next reign—that of Antiochus Theos—the revolt of the Parthians under Arsaces (B.C. 250) was followed speedily by that of the distant province of Bactriana. For thirty years together the Parthians continued to grow at the expense of the Syrian monarchy. The great Antiochus passed a life of war (B.C. 223-187). In his youth he had to contend against his revolted satrap of Media, and afterwards against his kinsman Achæus, in Asia Minor. We have already noticed his struggles in Cœle-Syria against the Ptolemies. Besides this, he was seven years engaged in successful campaigns against the Parthians and the king of Bactriana; and, finally, met unexpected and staggering reverses in war with the Romans, so that his last days were inglorious and his resources thoroughly broken. Respecting the reign of his son, Seleucus Philopator

(B.C. 187-176), we know little, except that he left his kingdom tributary to the Romans (*Livy*, xiii. 6) [see also SELEUCUS PHILOPATOR]. In Daniel, xi. 20, he is named *a raiser of taxes*, which shows what was the chief direction of policy in his reign. De Wette renders the words rather differently ('der einen eintreiber die Krone des Reiches [Judæa] durchziehen lässt'), yet perhaps with the same general meaning. Seleucus having been assassinated by one of his courtiers, his brother Antiochus Epiphanes hastened to occupy the vacant throne, although the natural heir, Demetrius, son of Seleucus, was alive, but a hostage at Rome. In Daniel, xi. 21, it is indicated that he gained the kingdom *by flatteries*; and there can be no doubt that a most lavish bribery was his chief instrument. According to the description in *Livy* (xli. 20), the magnificence of his largesses had almost the appearance of insanity.

A prince of such a temper and in such a position, whose nominal empire was still extensive, though its real strength and wealth were departing, may naturally have conceived, the first moment that he felt pecuniary need, the design of plundering the Jewish temple. At such a crisis, the advantage of the deed might seem to overbalance the odium incurred; yet, as he would convert every Jew in his empire into a deadly enemy, a second step would become necessary—



[Antiochus Epiphanes.]

to crush the power of the Jews, and destroy their national organization. The design, therefore, of prohibiting circumcision and their whole ceremonial, would naturally ally itself to the plan of spoliation, without supposing any previous enmity against the nation on his part. Just then, however, a candidate for the high-priesthood gave an impetus to this course of events, by setting the example of assuming Greek manners in the hope of gaining the king's favour; as is narrated in the 1st book of Maccabees. We have written enough to show how surprising to the Jews must have been the sudden and almost incredible change of policy on the part of the rulers of Syria; and how peculiarly aggravated enmity Antiochus Epiphanes must in any case have drawn on himself. Instead of crushing his apparently puny foes, he raised up heroes against himself [MACCABEES], who, helped by the civil wars of his successors, at length achieved the deliverance of their people; so that in the 170th year of the Seleucidæ (B.C. 143) their independence was formally acknowledged, and they began to date from this period (1 Macc. xiii. 42) as a new birth of their nation. Whether Antiochus Epiphanes committed all the atrocities alleged in the *second* book of Maccabees may be doubted; but having started amiss, with no principle to guide or restrain him, it is certain

that he was capable of adding cruelty to iniquity, to whatever amount the necessity of the moment might prompt. The intensity of Tacitus's hatred of the Jews is lamentably displayed in his remarks on this king, *Hist.* v. 8: 'Rex Antiochus, demere superstitionem et mores Græcorum dare adnixus, quominus *teterrimam gentem in melius mutaret*, Parthorum bello prohibitus est.'

The change of policy, from conciliation to cruel persecution, which makes the reign of Epiphanes an era in the relation of the Jews to the Syrian monarchy, has perhaps had great permanent moral results. It is not impossible that perseverance in the conciliating plan might have sapped the energy of Jewish national faith: while it is certain that persecution kindled their zeal and cemented their unity. Jerusalem, by its sufferings, became only the more sacred in the eyes of its absent citizens; who vied in replacing the wealth which the sacrilegious Epiphanes had ravished. According to 1 Maccab. vi. 1-16, this king died shortly after an attempt to plunder a temple at Elymais; and Josephus follows that account. Appian (*Syr.* 66) adds that he actually plundered it. Strabo, however (xvi. 1), and Justin (xxxii. 2) tell the story of Antiochus the Great, and represent him as losing his life in the attempt. Polybius and Diodorus decide nothing, as the fragments which notice the deed ascribe it merely to 'the king Antiochus.' Nevertheless, Josephus appeals to Polybius as agreeing with him; and the editors of Polybius so understand the matter. On the whole, it would appear that this attempt is rightly assigned to Epiphanes: it is not likely to have been two events, though the stories do not agree as to the name of the deity of the temple. We ought, however, to add, that Winer (*Real-Wörterbuch*) is disposed to believe that father and son both ended their lives with the same act; and this view of the case is also taken in Dr. W. Smith's *Dictionary of Greek and Roman Biography*.

An outline of the deeds of the kings of Syria in war and peace, down to Antiochus Epiphanes, is presented in the 11th chapter of Daniel; in which Epiphanes and his father are the two principal figures. Nothing but ignorance or a heated imagination can account for some modern expositors referring that chapter to the events of the eighteenth century after Christ. The wars and treaties of the kings of Syria and Egypt from B.C. 280 to B.C. 165 are described so minutely and so truly, in vv. 6-36, as to force all reasonable and well-informed men to choose between the alternatives,—either that it is a most signal and luminous prediction, or that it was written after the event.

Besides Antiochus Epiphanes, the book of Maccabees mentions his son, called Antiochus Eupator, and another young Antiochus, son of Alexander Balas, the usurper; both of whom were murdered at a tender age. In the two last chapters of the book a fourth Antiochus appears,—called by the Greeks *Sidetes*, from the town of Sida, in Pamphylia. This is the last king of that house, whose reputation and power were not unworthy of the great name of Seleucus. In the year B.C. 134 he besieged Jerusalem, and having taken it next year, after a severe siege, he pulled down the walls, and reduced the nation once more to subjection, after only ten years' independence. His moderation and regard for their religious feelings are contrasted by Josephus with the impiety of Epiphanes (*Antiq.*

xiii. 8, 2-31). It is remarkable that, though the beginning of his quarrel with the Jewish high-priest is narrated in the first book of Maccabees, the story is cut short abruptly.

The most compact and unbroken account of the kings of this dynasty is to be found in Appian's book (*De Rebus Syriacis*), at the end. The dates of the following table are taken from Clinton's *Fasti Hellenici*, vol. iii. Appendix, ch. iii. :—

1. Seleucus Nicator, B.C. 312—280.
2. Antiochus Soter, his son, 280—261.
3. Antiochus Theus, his son, 261—247.
4. Seleucus Callinicus, his son, 247—226.
5. (Alexander, or) Seleucus Ceraunus, his son, 226—223.
6. Antiochus the Great, his brother, 223—187.
7. Seleucus Philopator, his son, 187—176.
8. Antiochus Epiphanes, his brother, 176—164.
9. Antiochus Eupator, his son (a minor), 164—162.
10. Demetrius Soter, son of Seleucus Philopator, 162—150.
11. Alexander Balas, a usurper, who pretends to be son of Antiochus Epiphanes, and is acknowledged by the Romans, 152—146.
- [12. Antiochus Theus, or Alexander (a minor), son of the preceding. He is murdered by the usurper Trypho, who contests the kingdom till 140.]
12. Demetrius Nicator, son of Demetrius Soter, reigns 146—141, when he was captured by the Parthians.
13. Antiochus Sidetes, his brother, 141—128.*

F. W. N.

ANTIPAS (*Ἀντίπας*), a person named as 'a faithful witness,' or martyr, in Rev. ii. 13.

2. ANTIPAS, or HEROD-ANTIPAS. [HERODIAN FAMILY.]

ANTIPATER. [HERODIAN FAMILY.]

ANTIPATRIS (*Ἀντιπατρῖς*), a city built by Herod the Great, on the site of a former place called Caphar-saba (*Χαβάρ(α)βὰ* or *Καφαρσαβῆ*, *Joseph. Antiq.* xiii. 15. 1). The spot was well watered, and fertile; a stream flowed round the city, and in its neighbourhood were groves of large trees (*Antiq.* xvi. 5. 2). Caphar-saba was 120 stadia from Joppa; and between the two places Alexander Balas drew a trench, with a wall and wooden towers, as a defence against the approach of Antiochus (*Antiq.* xiii. 15. 1; *De Bell. Jud.* i. 4. 7). Antipatris also lay between Cæsarea and Lydia, its distance from the former place being twenty-six Roman miles (*Itin. Hieros.* p. 600). These circumstances indicate that Antipatris was in the midst of a plain, and not at Arsuf, where the Crusaders supposed they had found it (*Will. Tyr.* ix. 19; xiv. 16; *Vitruvius*, c. 23; *Brocard*, c. 10; comp. *Reland, Palæst.* pp. 569, 570). On the road from Ramlah to Nazareth, north of Ras-el Ain, Prokesch (*Reise ins Heilige Land*, Wien, 1831) came to a place called Kafir Saba; and the position which Brighaus assigns to this town in his map is almost in exact agreement with the position assigned to Antipatris in the *Itin. Hieros.* Perceiving this, Professor Raumer (*Palästina*, pp. 144, 462) happily conjectured that this Kafir

* Kings of the same family reigned in Antioch until Pompey reduced Syria to the form of a Roman province, B.C. 63.

Saba was no other than the reproduced name of Capbar-saba, which, as in many other instances, has again supplanted the foreign, arbitrary, and later name of Antipatris. This conjecture has been confirmed by Professor Robinson, who gives Keft Saba as the name of the village in question (*Researches*, iii. 46-48). St. Paul was brought from Jerusalem to Antipatris by night, on his route to Cæsarea (Acts xxiii. 31).

ANTIQUITIES, a term the meaning of which is somewhat arbitrary and unsettled, but, as limited to the nations and people with whom the Bible has to do, may be considered as embracing whatever relates to the religious, political, social, domestic, and individual life, not only of the Hebrew race, but also of those kingdoms, tribes, and persons that were connected with, or more or less influenced by, the chosen people. With the exception of history and biography, the science of Biblical antiquities comprises whatever institutions, laws, customs, observances, rites and ceremonies—in a word, every influence which tended to give ‘form and pressure’ to the Israelitish nation in the several stages of its development prior to the capture of Jerusalem by the Romans, and to the Christian church during the earlier ages. An accurate knowledge of the subjects embraced under Biblical antiquities is of the greatest importance to a divine, as being indispensable to a correct and complete acquaintance with the subject matter, the modes of thought, life, and action presented in those books and writings, which, as an expositor of the divine oracles, he is called on first to understand himself, and then to expound to others. Godwyn, in the dedication of his work on the subject, well remarks, ‘That many have no better acquaintance with Christ and his apostles, is because they are such strangers with Moses and Aaron. Were customs antiquated thoroughly known, many difficulties in Scripture would appear elegancies, and the places which now through obscurity dishearten the reader would then become sweet invitements to an unwearied assiduity in perusing the sacred oracles.’

The Scriptures themselves are the great source whence a knowledge of Hebrew and Christian antiquities may be drawn; and whoever wishes to have an accurate and a thorough acquaintance with the subject must, with this express purpose in view, make the holy record the object of a careful, sustained, and systematic study. To such an effort it is that scholars owe in the main the views they have formed and the treatises they have written. An intelligent student of the Old and New Testaments may gain no inconsiderable acquaintance with Biblical antiquities, even unaided by the researches of theological scholars. Much of the Old Testament is, in the best sense of the term, picture writing; and the history of the Saviour carries us into the very bosom of domestic life. The knowledge which is acquired from these sources is peculiarly valuable, from the stamp of truth which every part of it bears. Few, however, have the disposition, the leisure, or the ability for the requisite study; and therefore the aid of the scholar and divine is desirable, if not indispensable.

But besides what may be learned from the Scriptures themselves, much remains to be known which they do not and cannot teach; for, like all other books relating to ages long bygone, they con-

tain allusions, phraseology, modes of thought and speech, which can be understood either not at all, or but imperfectly, without light derived from extraneous sources; and that the rather because the Hebrews were not a literary people, and the aim of the sacred penmen was far higher than to achieve intellectual reputation.

The heathen writers afford very scanty materials for illustrating Biblical antiquities, so ignorant or prejudiced were they on topics of that kind. Indirect information and undesigned testimonies may be here and there extracted from their writings, but in general they communicate no useful information except on geographical and kindred subjects. The least barren of them is the earliest prose-writer extant, Herodotus, who, in his second book and part of the third, furnishes snatches of information which may be of service, especially in conjunction with the light which recent discoveries in Egyptian antiquities have so happily thrown on the Biblical records (*The Egypt of Herodotus*, by John Kenrick, M.A., 1841; *Manners and Customs of the Ancient Egyptians*, by Sir J. G. Wilkinson, 1837, 1841).

The study of Biblical antiquities, viewed as an aid in the interpretation of the books of the Old Testament, began probably on the return from the Babylonish exile, when a lengthened past already stretched out to the Israelitish nation as they looked back towards their origin; and, from the new circumstances in which they were placed, and the new modes of thought and action to which they had become habituated, they must have found many things in their sacred books which were as difficult to be understood as they were interesting to their feelings. The ideas, views, and observations which thence resulted were held, taught, transmitted, and from age to age augmented by Jewish doctors, whose professed duty was the expounding of the law of the Fathers; and after having passed through many generations by oral communication, were at length, in the second and some subsequent centuries of the Christian era, committed to writing [TALMUD]. This source of information, as being traditional in its origin, and disfigured by ignorance, prejudice, and superstition, must, to be of any service, be used with the greatest care and discrimination. It seems, however, to have fallen into somewhat undue depreciation, but has been successfully employed by recent writers in delineating a picture of the age in which our Lord appeared (*Das Jahrhundert des Heils*, durch A. F. Gfrörer, Stuttgart, 1838). In the first century Josephus wrote two works of unequal merit, on *The Jewish War*, and *The Antiquities of the Jews*, which, notwithstanding some credulity and bad faith on the part of the author, afford valuable information, particularly in relation to the manners, customs, and opinions of his own times. Had another work of which the writer speaks (preface to the *Antiquities*) come down to these days, which appears to have been a sort of philological treatise on the Mosaic laws and institutions, giving probably, after the manner of Michaelis in his *Mosaisches Recht*, the rationale of the several observances enjoined, some considerable light might have been thrown on the antiquities of the nation; though the known propensity of Josephus to the allegorical method of interpretation diminishes the regret experienced at its loss. The works of Philo, the celebrated Alexan-

Christian teacher, which were also produced in the first century, have their value too much abated by his love of the same allegorical method; which he was led to pursue mainly by his desire to bring the mind of the Hebrew nation into harmony with Oriental, and especially Grecian, systems of philosophy, of which Philo was a diligent student and a great admirer.

Little advantage is to be gained by the study of writers among the modern Jews; for till a very recent period no sound intellectual activity was found among this singular and most interesting race. Inspired, however, by the spirit of the eighteenth century, Mendelssohn opened to his fellow-believers a new era, and introduced a manner of thinking and writing which prepared the way for many valuable Jewish productions, and gave an impulse to the mind of 'the nation,' the best outward results of which are only beginning to be seen.

The study of classical antiquity, which commenced at the revival of letters, was not without an influence on Biblical archæology; but this branch of knowledge is chiefly indebted for its most valuable results to the systematic study of the Bible, and the cultivation of the long-neglected Hebrew language, which the interests of the Reformation both needed and called forth. It was not, however, till within the last century that the intelligent spirit which had been applied to the examination of classical antiquity in Germany, so directed the attention of Oriental scholars to the true way of prosecuting and developing a knowledge of Hebrew and Christian antiquities, as to bring forth treatises on the subject which can be regarded as satisfactory in the present advanced state of general scholarship.

In no one thing has the mental activity of recent times contributed more to the science of Biblical antiquities than by leading well-informed travellers to penetrate into Eastern countries, especially Syria, since, by communicating to the world the fruits of their enterprise, they have been enabled to present to no small extent a picture of what these lands and their inhabitants must have been of old, permanence being one of the chief characteristics of the Oriental mind. From Shaw (*Travels in Barbary and the Levant*) and Harmer (*Observations on various Passages of Scripture*) down to the invaluable work recently published by Professor Robinson (*Biblical Researches in Palestine*, 1841), a numerous series of publications have been put forth, which have contributed to throw very great light on Jewish and Christian antiquity.

The earliest treatise in the English language expressly on the subject of Jewish antiquities was written by Th. Godwyn, B.D. (*Moses and Aaron, Civil and Ecclesiastical Rites used by the Ancient Hebrews observed*, &c. 4to. 1614). This work passed through many editions in England; was translated into Latin by J. H. Reiz (1679); furnished with a preface and two dissertations by Witsius (1690); was illustrated, amended, and enlarged by Hottinger (1710); and further annotated on by Carpzovius, 1748. Considering the age in which it appeared, Godwyn's work well deserved the reputation which it gained; and for a condensed, but accurate and learned view of the subject on which it treats, may be still studied with advantage. In 1724-5, Thomas Lewis gave

to the public his *Origines Hebrææ, or Antiquities of the Hebrew Republic*, 4 vols. 8vo., which is a very elaborate and carefully compiled treatise, composed of materials drawn from the best authorities, both Jewish and Christian. A work of much value, as affording fuller views on some topics, and written in an easy style, is a posthumous publication by Dr. Jennings, entitled *Jewish Antiquities, or a Course of Lectures on the three First Books of Godwyn's Moses and Aaron*, London, 1766; edited, with a preface of some value, by Philip Furneaux. Fleury's work (Dr. Adam Clarke's edition) on *The Manners of the Ancient Israelites, containing an Account of the peculiar Customs, Laws, Policy, and Religion of the Israelites*, offers a pleasing and useful introduction to the study of the Old Testament Scriptures. A valuable and (for ordinary purposes) complete treatise may be found by the English student in *Biblical Antiquities*, by John Jahn, D.D., translated by T. C. Upham; reprinted from the American translation, at Oxford in 1836, and at London in 1841. Those who wish to enter more fully into the subject may consult the original, of which the foregoing is an abridgment (*Biblisches Archæologie*). A carefully compiled and well-written work may be found in *The Antiquities of the Jews from authentic Sources, and their Customs illustrated by Modern Travels*, by W. Brown, D.D. 2 vols. 8vo. Lond. 1820. Much important matter is presented in *Academical Lectures on the Jewish Scriptures and Antiquities*, by J. G. Palfrey, D.D. LL.D. 2 vols. 8vo. Boston (U. S.), 1840.

Without attempting to enumerate the several works which German scholars have produced on the subject, we may mention as worthy of special attention, G. L. Bauer's *Kurzgefasstes Lehrbuch der Hebr. Alterthümer des A. u. N. T.*; the second edition, by E. F. K. Rosenmüller, Leipsic, 1835, should be obtained; J. Mt. A. Scholz's *Handbuch der Bibl. Archæologie*, Bonn u. Wien, 1834. De Wette (*Lehrbuch der Hebr. Jüdisch. Archæologie*, Leips. 1830) has also published a work on the subject which has reached a second edition, and possesses no few of the excellencies which characterize the writings of its accomplished author.

Helon's Pylgrimage to Jerusalem may serve as a connecting link between Jewish and Christian antiquities, being almost equally useful for both, as it presents a picture of Judaism in the century which preceded the advent of our Saviour. The English translation (by the Rev. John Kenrick, M.A.) from the German original is accompanied by valuable notes and a preface, in which may be found a brief outline of the sources of Biblical archæology. The work is conceived and executed in the form of a story or novel, and possesses no ordinary interest, independently of its high theological value, as affording a living picture of the customs, opinions, and laws of the Jewish people. In French there is a somewhat similar work by M. de Montbron, under the unsuitable title of *Essais sur la Littérature des Hébreux*, 4 tomes, 12mo. Paris, 1819, in which a number of short tales illustrative of ancient Hebrew usages and opinions, are prefaced by a large and elaborate Introduction, and followed by a great number of learned and curious notes.

Among the fathers of the Christian church, Jerome, who was long resident in Palestine, has left in various works very important information

respecting the geography, natural history, and customs of the country. Most of the fathers, indeed, furnish, directly or indirectly, valuable notices respecting Christian antiquity, and in a body constitute the source whence for the most part writers and scholars of later ages have drawn their materials. The reader may with advantage consult *Some Account of the Writings and Opinions of Clement of Alexandria*, by John, Bishop of Lincoln, 1835; also, *Some Account of the Writings and Opinions of Justin Martyr*, by the same, Cambridge, 1829. A useful compendium, as giving specimens of the writings, and therein views of the opinions, manners, rites, and observances of the early Christian church, may be found in *Bibliothèque Choisie des Pères de l'Eglise Grecque et Latine*, par M. N. S. Guillon, Paris, 1828.

For a long period after the revival of learning the subject of Christian antiquities received no specific attention, but was treated more or less summarily in general histories of the Church of Christ; as, for instance, in the great Protestant work, *Ecclesiast. Historia per aliquot viros in urbe Magdeburg*, 1559-74; and on the part of the Catholics, by Baronius, *Annales Ecclesiast. à Christo nato ad annum 1198* (Rom. 1558). If any exception is to be made to this general statement, it is on behalf of Roman Catholic writers, whose works, however, are too inaccurate and prejudiced to be of any great value in these times. The first general treatise on Christian antiquity proceeded from the pen of an English divine, Jos. Bingham, *Origines Ecclesiasticæ, or the Antiquities of the Christian Church*, London, 1708-22, 10 vols. 8vo.; which was translated into Latin by Grischow (1738), and into German (1778). The writer was, from an early period of his life, a diligent student of Christian antiquity, as exhibited in the writings of the fathers; and having filled his mind with the copious materials which he there met with, he undertook 'to give such a methodical account of the antiquities of the Christian church, as others have done of the Greek and Roman and Jewish antiquities; not by writing an historical or continued chronological account of all transactions as they happened in the church, but by reducing the ancient customs, usages, and practices of the church under certain proper heads. 'I was moved with a sort of emulation to see so many learned men employed in publishing the antiquities of Greece and Rome, whilst we had nothing that could be called a complete collection of the antiquities of the church' (Preface, ed. London, 1834). The work corresponds in no slight degree to the learning, care, and time bestowed upon it; but, besides being somewhat in the rear of the learning of the day, it has its value diminished by the High Church notions of the writer, as well as by the strength of his prejudices against the Roman Catholics. A useful compendium, written in a liberal spirit, and compiled chiefly from German sources, has lately been published in this country (*A Manual of Christian Antiquities*, by Rev. J. E. Riddle, M.A. London, 1839), in which (Preface, § 2, and Appendix H) may be found a concise but detailed account of the literature of Christian antiquities. A more complete catalogue of works, embracing each particular branch, is given in Winer's valuable book, *Handbuch der*

Theologischen Literatur, 2 vols. 8vo. Leipzig, 1838. Among the best Continental treatises on the general subject of Christian antiquities may be mentioned those of Augusti, *Handbuch d. Christl. Archæol.*, Leipzig, 1836-7, 3 vols. 8vo.; Böhmner, *Die Christl.-kirchl. Alterthum Wissenschaft*, Bresl. 1836, 8vo.; Siegel, *Handbuch der Christl. kirchl. Alterthümer*, Leipzig, 1836-7, 3 vols. 8vo.

—J. R. B.

ANTONIA, a fortress in Jerusalem, on the north side of the area of the temple, often mentioned by Josephus in his account of the later wars of the Jews. It was originally built by the Maccabees, under the name of Baris, and was afterwards rebuilt with great strength and splendour by the first Herod. In a more particular description, Josephus states (*De Bell. Jud.* v. 5. 8) that the fortress stood upon a rock or hill 50 cubits high, at the north-west corner of the temple area, above which its wall rose to the height of 40 cubits. Within it had the extent and appearance of a palace, being divided into apartments of every kind, with galleries and baths, and broad halls or barracks for soldiers; so that, as having everything necessary within itself, it seemed a city, while in magnificence it resembled a palace. At each of the four corners was a tower. Three of these were 50 cubits high; but the fourth, at the south-east corner, was 70 cubits high, and overlooked the whole temple, with its courts. The fortress communicated with the northern and western porticoes of the temple area, and had flights of stairs descending into both, by which the garrison could at any time enter the courts of the Temple, and prevent tumults. On the north it was separated from the hill Bezetha by a deep trench, lest it should be approachable from that quarter, and the depth of the trench added much to the apparent elevation of the towers (*De Bell. Jud.* v. 4, 2).

This fortress is called ἡ παρεμβολή in the New Testament (Acts xxi. 34, 37), and is the 'castle' into which Paul was carried from the temple by the soldiers: from the stairs of which he addressed the people collected in the adjacent court (Acts xxi. 31-40). Professor Robinson (*Researches*, i. 422) conceives that the deep and otherwise inexplicable excavation called 'the pool of Bethesda' was part of the trench overlooking the north wall of this fortress; in which case, as he remarks, its extent must have been much more considerable than has usually been supposed.

APE (ἤϊϛ κορη; Gr. κῆπος, κῆβος, κῆφος; whence the Latinized name *Cephus*). In the Hebrew and Semitic cognate tongues, and in the classical languages, these names, under various modifications, designate the Simiadae, including, no doubt, species of Cercopithecus, Macacus, and Cynocephalus, or Guenons, apes, and baboons; that is, all the animals of the quadrumanous order known to the Hebrews, Arabs, Egyptians, and the classical writers. Accordingly, we find Pliny and Solinus speaking of Ethiopian Cephî exhibited at Rome: and in the upper part of the celebrated Prænestine mosaic representing the inundation of the Nile, figures of Simiadae occur in the region which indicates Nubia; among others, one in a tree, with the name KHINEN beside it, which may be taken for a Cercopithecus of the Guenon group. But in the triumphal procession of Thothmes III.

at Thebes, nations from the interior of Africa, probably from Nubia, bear curiosities and tribute, among which the Camelopardalis or Giraffe and six quadrumana may be observed. The smallest

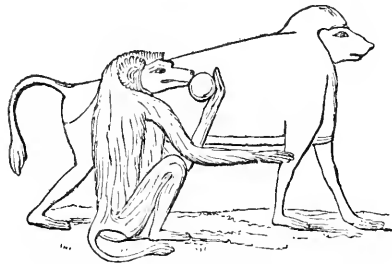
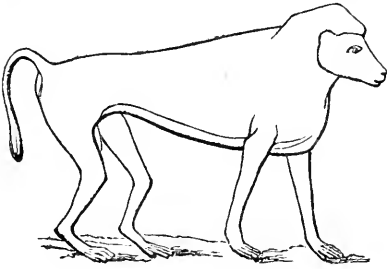

[Apes from Rosellini's Monumenti dell' Egitto.]

and most effaced animals may be apes, but the others, and in particular the three figured and coloured from careful drawings, in Plate xxi. of Rosellini's work, are undoubtedly Macaci or Cynocephali, that is, species of the genus baboon, or baboon-like apes. Naturalists and commentators, not deterred by the interminable list of errors which the practice has occasioned, are often unnecessarily anxious to assign the names of animals noticed in Scripture and in the ancient classics, to species characterized by the moderns; although the original designations are to be taken in a familiar sense, and often extend even beyond a general meaning. In the instance before us we have the futility of this practice fully exemplified; for Buffon presumed his Mona (Cercopithecus Mona) to be the Kebos of the Greeks, and not without plausibility, since the western Arabs, it seems, apply the word Moune to all long-tailed apes. Linnæus referred Cephus to his Simia Cephus, now Cercopithecus Cephus, or Moustache Guenon, of a different group; while Lichtenstein referred it to his Simia, or rather, as now arranged, Cercopithecus Diana. But as none of these are known to inhabit eastern Africa, it is more probable that the Keipen of the Prænestine mosaic is in reality the Cercopithecus Griseovirides, or Grivet of Cuvier, which, with equal pretensions in regard to form, has the advantage of being a native of Ethiopia and Nubia, and belongs, with the two last mentioned, to the group which has been called Callitrix.

But these considerations do not serve to point out the Koph of Scripture; for that animal, named only twice (1 Kings x. 22, and 2 Chron. ix. 21), is in both cases associated with תְּחִימִים, *Thoukiim*, perhaps erroneously rendered 'peacocks.' Now

neither peacocks nor pheasants are indigenous in Africa: they belong to India and the mountains of high Asia, and therefore the version 'peacocks,' if correct, would decide, without doubt, not only that Koph denotes none of the Simiada above noticed, but also that the fleet of Tarslish²⁸ visited India or the Australasian islands. Thoukiim, apparently meaning crested, indicates birds, perhaps parrots, but cannot refer to the pintado of Guinea hen, the Numidia of naturalists and the Meleagris of the ancients; nor to the Pterocles or Sandgrouse, both being familiarly known in Upper Egypt, and the last mentioned, in particular, abundant in Arabia and Palestine. The interpretation proposed by Hase, which would convert Kophim into Succim—*dwellers in caves*, is inadmissible, such a description being quite inapplicable to long-tailed monkeys. Like the whole order of quadrumana, they are constituted not for troglodyte, but arboreal life, or to be dwellers in trees; baboons alone venturing beyond woody covers in steep rocky situations, and sometimes finding shelter in clefts. For these reasons we conclude that the Hebrew *koph*, and names of the same root, were, by the nations in question, used generically in some instances and specifically in others, though the species were not thereby defined, nor on that account identical.

Baboons, we have already shown, were known to the Egyptians, and cannot well have escaped observation among the people of Palestine, since they resided close upon the great caravan-routes, which, as is well known, were frequented from the earliest antiquity by showmen exhibiting wild beasts. In Egypt, however, a baboon was the type of some abstract power in nature or in metaphysics; as such the animal was idolized, and figures of a cynocephalus were invariably placed on the summit of weighing-scales, where they still appear on the monuments.



[Macacus Arabicus.]

If there be truth, as the following authorities show, in the existence of a large ape or baboon in Yemen, and even in Mesopotamia, the untractable and brutal character of the whole genus would be sufficient to sanction the Arabic name *Saadan*, and the Hebrew שָׂדִים, *Sadim*; which indicate the satyrs of the desert, noticed in Mr. Rich's *Memoir on the Ruins of Babylon*, p. 30,

* If the voyage extended to the Spice Islands, then, indeed, both peacocks and ourang-outangs were at hand.

where they are denominated *Sied Assad*, and described as found in woody places near Semana, on the Euphrates. Thus we have the שִׁירֵי אֵשׁ, *Sayrim*, or 'hairy ones' of Levit. xvii. 7, in accordance with Pliny, who conceived satyrs to be large apes. In the Præstine mosaic, before quoted, a baboon is figured which, we are assured, had the name ΚΑΤΥΡΟΣ, or Satyrus, by its side.* The only species of ape of the baboon form known in Arabia is the *Moeko* of Edwards, noticed in our illustrated series of drawings as *Macacus Arabicus*, a species nearly allied to *Cynocephalus Hamadryas* on the one hand, and to *Mac. Silenus* on the other—all three powerful, fierce, and libidinous animals. *Mac. Arabicus* may ultimately prove to be a true baboon, and the same as *Simia cynomolgus* of Hasselquist. It is a remarkable species for stature and aspect, having the dog-like nose and approximating eyes of baboons; the skin of the face of a reddish colour; the snout, lips, and chin black; the forehead low, and the sides of the head furnished with bushy, long, white hair; the breast, arms, and shoulders similarly covered, but the loins and lower extremities of a fine chestnut; the tail of the same colour, of no great length, tufted at the end, and all the hands black. It is found from the straits of Bab-el-Mandeb, through Southern Arabia to the Euphrates, and even beyond the junction of that river with the Tigris. Like other large and formidable Simiadae, it is less solicitous about the vicinity of trees, because it is armed with powerful canines; holds its enemy firmly grasped, and fights, not singly, but assisted by the whole troop: it frequents scrubby underwood near water, but becomes more rare eastward of Yemen.† Comparing the characters of this species, we find it by configuration, colours, and manners peculiarly adapted to the purposes of idolatry in its grossest and most debasing aspect. The Hebrew people, already familiar with a similar worship in Egypt, may have copied the native tribes in the wilderness, and thus drawn upon themselves the remonstrance in Levit. xvii. 7, where the allusion to these animals is very descriptive, as is that in Isa. xiii. 21; and again, xxxiv. 14, where the image is perfect, when we picture to ourselves the 'hairy ones' lurking about the river in the juniper and liquorice jungle, as described by Mr. Rich.

It is not unlikely that the baboon idol may have had goat's horns, since we find the same attribute on rams' heads in Egypt; on lions' heads on coins of Tarsus, and on horses' and elephants' heads on medals of Syrian kings. The Greek mythologists, ignorant of the baboon figure, may have preferred an imaginary compound of man and goat to that of the cynocephalus, which they confounded with the hyæna, or, in their love of ideal beauty, may have considered it too disgusting even for an idol. Perhaps the most ancient form of the Arabian Urolalt was that of a baboon,

* This name does not occur in the copies in our possession, and, we fear, was lost in the breaking up of the mosaic, which is now preserved fragmentally in different museums.

† See Edwards's *Gleanings*, and Pennant's *History of Quadrupeds*, 4to. vol. i. p. 195. The information in the text is derived from an officer who was in the Honourable East India Company's surveying service.

male or female, the name apparently having some reference to red, and to the Indian monkey-worship (see Gesner, s. v. 'Hyæna'). Urolalt and monkey-worship are connected with a solas mythus.—C. H. S.

APELLES (Ἀπελλῆς), a Christian at Rome, whom Paul salutes in his Epistle to the Church there (Rom. xvi. 10), and calls τὸν δόκιμον ἐν Χριστῷ, 'approved in Christ,' i. e. an approved Christian. Origen doubts whether he may not have been the same person with Apollos; but this is far from likely [ἈΠΟΛΛΟΣ]. According to the old church traditions Apelles was one of the seventy disciples, and bishop either of Smyrna or Hæraclæia (Epiph. *Cont. Hæres.* p. 20; Fabrici *Lex. Evangelii*, pp. 115, 116, &c.). The name itself is notable from Horace's 'Credat Judæus Apella, non ego' (*Sat.* i. 5), by which he less probably means a circumcised Jew in general, as many think, than a particular Jew of that name, well-known at Rome.

APHARSACHITES or ΑΦΙΑΡΣΑΘΙΧΙΤΗΣ (Ἀφάρσαθιχῆν or Ἀφάρσαθιχῆν; Sept. Ἀφάρσαθαχαῖοι), the name of the nation to which belonged one portion of the colonists whom the Assyrian king planted in Samaria (Ezra iv. 9; v. 6). Schultness (*Parad.* p. 362) identifies the 'Apharsachites' with the Persian, or rather Median 'Paratacæ' of the Greek geographers (Strabo xi. 522; xv. 732; Plin. xvi. 29). This conclusion is strengthened by the fact that the A is often prosthetic in Strabo; as in xv. 764, where the names Mardi and Amardi are interchanged.

APHEK (Ἀφέκ; Sept. Ἀφέκ); the name signifies *strength*; hence a citadel or fortified town. There were at least three places so called, viz.:

1. APHEK, a city in the tribe of Asher (Josh. xiii. 4; xix. 30), called אֶפְקַי in Judg. i. 33, where we also learn that the tribe was unable to gain possession of it. This must be the same place with the Ἀφακα which Eusebius (*Constant.* iii. 55) and Sozomen (pp. 2, 5) place in Lebanon, on the river Adonis, where there was a famous temple of Venus. A village called Afka is still found in Lebanon, situated at the bottom of a valley, and may possibly mark the site of this Apek (Burckhardt, i. 70; Richter, p. 107).

2. APHEK, a town near which Benhadad was defeated by the Israelites (1 Kings xx. 26, sq.), which seems to correspond to the Aphaca of Eusebius (*Onomast.* in Ἀφακα), situated to the east of the Sea of Galilee, and which is mentioned by Burckhardt, Seetzen, and others under the name of Feik.

3. APHEK, a city in the tribe of Issachar, not far from Jezreel, where the Philistines twice encamped before battles with the Israelites (1 Sam. iv. 1; xxix. 1; comp. xxviii. 4). Either this or the first Apek, but most probably this, was the Apek mentioned in Josh. xii. 18, as a royal city of the Canaanites.

APHEKAH (Ἀפקῆ), a town in the mountains of Judah (Josh. xv. 23).

APHEREMA (Ἀφάρεμα), one of the three pararchies added to Judæa by the kings of Syria (1 Macc. xi. 34). This is perhaps the Ephraim or Ephraim mentioned in John xi. 54.

APHSES, head of the eighteenth sacerdotal family of the twenty-four into which the priests were divided by David for the service of the temple (1 Chron. xxiv. 15).

APOCRYPHA (ἀπόκρυφα, sc. βιβλία, *hidden, secreted, mysterious*), a term in theology, applied in various senses to denote certain books claiming a sacred character. The word occurs Mark iv. 22: 'There is nothing hid, which shall not be manifested, neither was anything kept secret (ἀπόκρυφον), but that it should come abroad;' also Luke viii. 17; and Col. ii. 3: 'In whom are hid (ἀπόκρυφοί) all the treasures of wisdom and knowledge.' It is first found, as denoting a certain class of books, in Clemens Alexandrinus, *Stromata*, 13, c. 4, ἐκ τινῶν ἀποκρύφων.

In the early ages of the Christian Church this term was frequently used to denote books of an uncertain or anonymous author, or of one who had written under an assumed name. Its application, however, in this sense is far from being distinct, as, strictly speaking, it would include *canonical* books whose authors were unknown or uncertain, or even *pseudepigraphal*. 'Let us omit,' says St. Augustine, 'those fabulous books of Scripture, which are called *apocryphal*, because their secret origin was unknown to the fathers. We do not deny that Enoch, the seventh from Adam, wrote something, as Jude asserts in his canonical Epistle that he did; but it is not without a purpose that they are not found in the Jewish canon preserved in the Temple. The books, therefore, which are published in his name are rightly judged by prudent men not to be his, as more recent works were given out as written by apostles, which, however, have been separated, upon diligent investigation, from the canon of Scripture, under the name of *apocryphal*.' And again: 'From such expressions as "The Book of the Wars of the Lord" men have taken occasion to forge books called *apocryphal*.' And in his book against Faustus, he says: 'Apocryphal books are not such as are of authority, and are kept secret; but they are books whose original is obscure, and which are destitute of proper testimonials, their authors being unknown, and their characters either heretical or suspected.' Origen also, on Matt. xxii. had applied the term apocryphal in a similar way: 'This passage is to be found in no canonical book' (*regulari*, for we have Origen's work only in the Latin translation by Rufinus), 'but in the *apocryphal* book of Elias' (*secretis Eliæ*). And, 'This is plain, that many examples have been adduced by the apostles and evangelists, and inserted in the New Testament, which we do not read in the canonical Scriptures which we possess, but which are found in the *Apocrypha*' (Origen, *Præf. in Cantic.*). So also Jerome, referring to the words (Eph. v. 14) 'Awake, thou that sleepest, and arise from the dead,' observes that 'the apostle cited this from *hidden* (reconditis) prophets, and such as seem to be apocryphal, as he has done in several other instances.' Epiphanius thought that this term was applied to such books as were not placed in the Ark of the Covenant, but put away in some other place (see Suicer's *Thesaurus* for the true reading of the passage in this Father). Under the term *apocryphal* have been included books of a religious character, which were in circulation among private Christians, but were not allowed to be read in the

public assemblies; such as 3 and 4 Esdras, and 3 and 4 Maccabees.

In regard to the New Testament, the term has been usually applied to books invented by heretics to favour their views, or by Catholics under fictitious signatures. Of this description were many spurious or apocryphal gospels (which see). It is probably in reference to such that Basil, Cyril of Jerusalem, and Jerome gave cautions against the reading of apocryphal books; although it is possible, from the context, that the last-named Father alludes to the books which were also called *Ecclesiastical*, and afterwards *Deutero-canonical*. The following passage from his Epistle to Læta, on the education of her daughter, will serve to illustrate this part of our subject:—'Let her first learn the Psalter, and give her hours of leisure to those holy songs. From the Proverbs of Solomon she will gather practical instruction; Ecclesiastes will teach her to despise the world; in Job she will find examples of virtue and endurance. Then let her go to the Gospels, and never lay them down. The Acts of the Apostles, with the Epistles, must be imbibed with all the ardour of her heart. When her mind is thoroughly stored with these treasures, she may commit the Prophets to her memory, together with the Heptateuch, and the books of Kings and Chronicles, with those of Esdras and Esther. The Song of Solomon she may read last without danger: if she reads it earlier, she may not discern that a spiritual union is celebrated under carnal words. All *apocryphal* books should be avoided; but if she ever wishes to read them, *not to establish the truth of doctrines, but with a reverential feeling for the truths they signify*, she should be told that they are not the works of the authors by whose names they are distinguished, that they contain much that is faulty, and that it is a task requiring great prudence to find gold in the midst of clay. The works of Cyprian should ever be in her hands. She may run over the epistles of Athanasius, and the books of Hilary, without any danger of stumbling. Let her pleasure be in such treatises and writers of such character as most evince the piety of an unwavering faith. All other authors she should read to judge of what they say, not simply to follow their instructions.' And to the same effect Philastrius:—'Among whom are the Manichees, Gnostics [&c.], who, having some *apocryphal* books under the apostles' names (*i. e.* some separate Acts), are accustomed to despise the canonical Scriptures; but these *secret* Scriptures, that is, *apocryphal*, though they ought to be read by the perfect for their morals, ought not to be read by all, as ignorant heretics have added and taken away what they wished.' He then proceeds to say that the books to which he refers are the *Acts of Andrew*, written by 'the disciples who were his followers,' &c.: *Quos conscripserunt discipuli tunc sequentes apostolum* (*Hæres.* 40).

In the *Bibliothèque Sacrée*, by the Rev. Dominican Fathers Richard and Giraud (Paris, 1822), the term is defined to signify—(1) anonymous or pseudepigraphal books; (2) those which are not publicly read, although they may be read with edification in private; (3) those which do not pass for authentic and of divine authority, although they pass for being composed by a sacred author or an apostle, as the *Epistle of Barnabas*;

and (4) dangerous books composed by ancient heretics to favour their opinions. They also apply the name 'to books which, after having been contested, are put into the canon by consent of the churches, as Tobit, &c.' And Jahn applies it in its most strict sense, and that which it has borne since the fourth century, to books which, from their inscription, or the author's name, or the subject, might easily be taken for inspired books, but are not so in reality. It has also been applied, by Jerome, to certain books not found in the Hebrew canon, but yet publicly read from time immemorial in the Christian church for edification, although not considered of authority in controversies of faith. These were also termed Ecclesiastical books, and consisted of the books of Tobit, Wisdom, Ecclesiasticus, Baruch, the two first books of Maccabees, the seven last chapters (according to Cardinal Hugo's division) of the book of Esther, and those (so called) parts of the book of Daniel which are not found in Hebrew, viz. the Song of the Children, the Speech of Azariah, the History of Susannah, and the Fable (as Jerome calls it) of Bel and the Dragon. These have been denominated, for distinction's sake, the deuterocanonical books, in as much as they were not in the original or Hebrew canon. In this sense they are called by some the Antilegomena of the Old Testament. 'The uncanonical books,' says Athanasius, or the author of the *Synopsis*, 'are divided into *antilegomena* and *apocrypha*' [DEUTERO-CANONICAL].

Of Spurious and Apocryphal Books, as distinct from *Antilegomena* or Ecclesiastical.—Among this class are doubtless to be considered the 3rd and 4th books of Esdras; and it is no doubt in reference to these that, in his letter to Vigilantius, Athanasius speaks of a work of Esdras which he says that he had never even read. Playing upon the name of Vigilantius, he adds, 'You sleep vigilantly (tu vigilans dormis), and write in your sleep; proposing to me an *apocryphal* book, which is read by you and others like you, under the name of Esdras, wherein it is written that no one should be prayed for after his death (See 4 Esdras, viii. 36-44). . . . Why take in hand what the Church does not receive? Read, if you like, all the feigned revelations of all the patriarchs and prophets, and when you have learned them, sing them in the women's weaving-shops, and propose them to be read in your taverns, that you may the more readily by them allure the unlettered rabble to drink.'

Of the same character are also the Book of Enoch, the Testament of the Twelve Patriarchs, the Assumption of Moses, &c.; which, as well as 3 and 4 Esdras, being by many considered as the fictions of Christians of the second and third centuries, it is doubtful whether they ought to be classed in the Apocrypha of the Old or of the New Testament. Origen, however, believed the New Testament to have contained citations from books of this kind written before the times of the apostles; and, in reference to such, observes, in his preface to the *Canticles*, 'This, however, is manifest, that many passages are cited either by the apostles or the evangelists, and inserted in the New Testament, which we do not read in those Scriptures of the Jews which we call canonical, but which are nevertheless found in *apocryphal* books, or are taken from them. But this will give no authority to apocryphal writings,

for the bounds which our fathers have fixed are not to be removed; and possibly the apostles and evangelists, full of the Holy Ghost, might know what should be taken out of those Scriptures and what not. But we, who have not such a measure of the Spirit, cannot, without great danger, presume to act in that manner.' Then, in his *Letter to Apianus*, he observes, that there were many things kept from the knowledge of the public, but which were preserved in the hidden or *apocryphal* books, to which he refers the passage (Heb. xi. 37), 'They were sawn asunder.' Origen probably alludes here to that description of books which the Jews called מְנִינִים, a word of the same signification with *apocrypha*, and applied to books laid aside, or not permitted to be publicly read, or considered, even when divinely inspired, not fit for indiscriminate circulation: among the latter were the first chapter of Genesis, the Song of Solomon, and our last eight chapters of the prophet Ezekiel.

The books which we have here enumerated, such as the Book of Enoch, &c., which were all known to the ancient Fathers, have descended to our times; and, although incontestably spurious, are of considerable value from their antiquity, as throwing light upon the religious and theological opinions of the first centuries. The most curious are the 3rd and 4th books of Esdras, and the Book of Enoch, which has been but recently discovered, and has acquired peculiar interest from its containing the passage cited by the apostle Jude [ENOCU]. Nor are the apocryphal books of the New Testament destitute of interest. Although the spurious Acts extant have no longer any defenders of their genuineness, they are not without their value to the Biblical student, and have been applied with success to illustrate the style and language of the genuine books, to which they bear a close analogy. The American translator of Mosheir's *Ecclesiastical History* terms them 'harmless and ingenious fictions, intended either to gratify the fancy or to silence the enemies of Christianity.'

Some of the apocryphal books have not been without their defenders in modern times. The *Apostolical Canons* and *Constitutions*, and the various *Liturgies* ascribed to St. Peter, St. Mark, &c., and published by Fabricius, in his *Codex Apocryphus Novi Testamenti*, were considered by the learned and eccentric William Whiston, and the no less learned Grabe, to be of equal authority with any of the confessedly genuine apostolic compositions (see Whiston's *Primitive Christianity* and Grabe's *Spicilegium*).

They are, however, regarded by most as originally not of an earlier date than the second century, and as containing interpolations which betray the fourth or fifth: they can, therefore, only be considered as evidence of the practice of the Church at the period when they were written. They have generally been appealed to by the learned as having preserved the traditions of the age immediately succeeding the apostolic; and, from the remarkable coincidence which is observable in the most essential parts of the so-called Apostolic Liturgies, it is by no means improbable that, notwithstanding their interpolations, they contain the leading portions of the most ancient Christian forms of worship.

Most of the apocryphal Gospels and Acts

noticed by the fathers, and condemned in the catalogue of Gelasius, which are generally thought to have been the fictions of heretics in the second century, have long since fallen into oblivion. Of those which remain, although some have been considered by learned men as genuine works of the apostolic age, yet the greater part are universally rejected as spurious, and as written in the second and third centuries. A few are, with great appearance of probability, assigned to Leucius Clarinus, supposed to be the same with Leontius and Seleucus, who was notorious for similar forgeries at the end of the third century. The authorship of the *Epistle of Barnabas* is still a matter of dispute; and there appears but too much reason to believe that there existed grounds for the charge made by Celsus against the early Christians, that they had interpolated or forged the ancient Sibylline Oracles.

In the letter of Pope Innocent I. to St. Exupere, bishop of Toulouse, written about the year 405, after giving a catalogue of the books forming the canon of Scripture (which includes five books of Solomon, Tobit, and two books of Maccabees), he observes:—‘But the others, which are written under the name of Matthias, or of James the Less, or those which were written by one Leucius under the name of Peter and John, or those under the name of Andrew by Xenocheris and Leonidas the philosopher, or under the name of Thomas; or if there be any others, you must know that they are not only to be rejected, but condemned.’ These sentiments were afterwards confirmed by the Roman Council of seventy bishops, held under Pope Gelasius, in 494, in the acts of which there is a long list of apocryphal Gospels and Acts, the greater part of which are supposed to have perished. The acts of this council, however, are not generally considered to be genuine.

But, whatever authority is to be ascribed to these documents, it cannot be denied that the early Church evinced a high degree of discrimination in the difficult task of distinguishing the genuine from the spurious books. ‘It is not so easy a matter,’ says the learned Jeremiah Jones, ‘as is commonly imagined, rightly to settle the canon of the New Testament. For my own part, I declare, with many learned men, that in the whole compass of learning I know no question involved with more intricacies and perplexing difficulties than this’ (*New and Full Method*, vol. i. p. 15). Referring to the same subject, the pious Richard Baxter had also observed, ‘Few Christians among us, for ought I find, have any better than the Popish implicit faith in this point, nor any better arguments than the Papists have to prove the Scripture to be the word of God. They have received it by tradition. Godly ministers and Christians tell them so: it is impious to doubt of it; therefore they believe it. . . . It is strange to consider how we all abhor that piece of Popery, as most injurious to God of all the rest, which resolves our faith into the authority of the Church, and yet that we do content ourselves with the same kind of faith, only with this difference—the Papists believe Scripture to be the word of God, because their Church saith so; and we, because our Church or our leaders say so. . . . Many a thousand do profess Christianity, and zealously hate the enemies thereof, upon the same grounds, to the same end, and from the same cor-

rupt principles, as the Jews did hate and kill Christ. It is the religion of the country, where every man is reproached that believes otherwise. . . . Had they been born and bred in the religion of Mahomet, they would have been as zealous for him.’ (*Saint’s Rest*, p. 2.) ‘If the question be,’ says Mr. Jones, ‘why Barnabas’s Epistle be rejected and Jude’s received—why the Gospel of Peter is excluded and the Epistle of Peter admitted into the canon as the word of God, &c., alas! how little shall we have given in answer, unless what Baxter says, “We believe as the Church does!” Mr. Jones conceives that testimony and tradition are the principal means of ascertaining whether a book be canonical or apocryphal. Inquiries of this kind, however, must of necessity be confined to the few; and it is only to those who have time and opportunity that the foregoing observations can apply. The mass of Christians, who have neither time nor other means of satisfying themselves, must confide, in questions of this kind, either in the judgment of the learned, or the testimony at least, if not the authority, of the Church; and it ought to be a matter of much thankfulness to the private Christian, that the researches of the most learned and diligent inquirers have conspired, in respect to the chief books of Scripture, in adding the weight of their evidence to the testimony of the Church Universal.

The following are the principal apocryphal (or spurious) books of the Old Testament, which have descended to our times. The greater number of them can scarcely be considered as properly belonging to the Apocrypha of the Old Testament, as they have been most probably written since the Christian era, and not before the second century:—Third and fourth Esdras, the Book of Enoch, the apocryphal book of Elias the Prophet, the third, fourth, and fifth books of Maccabees (received by the Greek Church), the Ascension of Isaiah, the Assumption of Moses, with a few others.

The best accounts of the apocryphal books will be found in Fabricii *Codex Pseudepigraphus* V. T. Hamburg and Leipzig, 1713 and 1741, and *Codex Apocryphus N. T.*, Hamburg, 1713-1722; *Auctarium Codicis Apocryphi N. T. Fabriciani*, editid And. Birch, Copenhagen, 1804. *A New and Full Method of Settling the Canon of the N. T.*, by the Rev. Jeremiah Jones, Oxford, 1726—last edition, Oxford, 1827. Du Pin, *Prolegomena*, Amst. 1701, and *Canon of the Old and New Testaments*, London, 1700; and especially *Codex Apocryphus N. T., e libris ineditis maxime Gallicanis, Germanicis, et Italicis, collectus, recensitus, notisque et prolegomenis illustratus, opera et studio T. C. Thilo*, tom. i. Lips. 1832, 8vo.: the remaining two volumes are not yet published. Vol. i. contains: 1. The history of Joseph the Carpenter, Arab. and Lat. 2. The Gospel of the Infancy. 3. The Protevangelion of James, and the Gospel of Thomas the Israelite, Greek and Lat. 4. The Gospel of the Nativity of Mary, and the History of the Nativity of Mary and the Saviour, Lat. 5. The Gospel of Marcion, collected by Dr. Hahn, from ancient Greek MSS. 6. The Gospel of Nicodemus, Gr. and Lat. 7. Apprehension and Death of Pilate, Gr. 8. The mutilated and altered Gospel of St. John, preserved in the archives of the Templars of St. John of Jerusalem in Paris,

with Griesbach's text. 9. An Apocryphal Book of the Apostle John, Lat. [ACTS, GOSPELS, EPISTLES, and REVELATIONS, *Spurious*].—W. W.

APOLLONIA (Ἀπολλωνία), a city of Macedonia, in the province of Mygdonia (Plin. iv. 17), situated between Amphipolis and Thessalonica, thirty Roman miles from the former, and thirty-six from the latter (*Itiner. Anton.*). St. Paul passed through Amphipolis and Apollonia in his way to Thessalonica (Acts xvii. 1).

APOLLONIUS. Three persons of this name occur in the history of the Maccabees.—1. APOLLONIUS, a general whom Antiochus Epiphanes sent into Judæa, and who took Jerusalem, but who was eventually defeated and slain by Judas Maccabæus, B.C. 166 (1 Macc. iii. 10, 11).—2. APOLLONIUS, governor of Cœle-Syria, and general of Demetrius Nicanor, who was defeated by Jonathan on behalf of Alexander Balas, B.C. 148 (1 Macc. x. 69-76).—3. APOLLONIUS, one of the governors left by Lysias in Judæa, after the treaty between the Jews and Antiochus Eupator (2 Macc. xii. 2) [MACCABEES].

APOLLOS (Ἀπολλῶς), a Jew of Alexandria, is described as a *learned*, or, as some understand it, an *eloquent man* (ἀνὴρ λόγιος), well versed in the Scriptures and the Jewish religion (Acts xviii. 24). About A.D. 56 he came to Ephesus, where, in the synagogues, 'he spake boldly the things of the Lord, knowing only the baptism of John' (ver. 25); by which we are probably to understand that he knew and taught the doctrine of a Messiah, whose coming John had announced, but knew not that *Jesus* was the Christ. His fervour, however, attracted the notice of Aquila and Priscilla, whom Paul had left at Ephesus; and they instructed him in this higher doctrine, which he thenceforth taught openly, with great zeal and power (ver. 26). Having heard from his new friends, who were much attached to Paul, of that apostle's proceedings in Achaia, and especially at Corinth, he resolved to go thither, and was encouraged in this design by the brethren at Ephesus, who furnished him with letters of introduction. On his arrival there he was very useful in watering the seed which Paul had sown, and was instrumental in gaining many new converts from Judaism. There was perhaps no apostle or apostolical man who so much resembled Paul in attainments and character as Apollos. His immediate disciples became so much attached to him, as well nigh to have produced a schism in the Church, some saying, 'I am of Paul;' others, 'I am of Apollos;' others, 'I am of Cephas' (1 Cor. iii. 4-7, 22). There must, probably, have been some difference in their mode of teaching to occasion this; and from the First Epistle to the Corinthians it would appear that Apollos was not prepared to go so far as Paul in abandoning the figments of Judaism, and insisted less on the (to the Jews) obnoxious position that the Gospel was open to the Gentiles. There was nothing, however, to prevent these two eminent men from being perfectly united in the bonds of Christian affection and brotherhood. When Apollos heard that Paul was again at Ephesus, he went thither to see him; and as he was there when the first Epistle to the Corinthians was written (A.D. 59), there can be no doubt that the apostle received from him his information concerning the divisions in that church, which

he so forcibly reproveth. It strongly illustrates the character of Apollos and Paul, that the former, doubtless in disgust at those divisions with which his name had been associated, declined to return to Corinth; while the latter, with generous confidence, urged him to do so (1 Cor. xvi. 12). Paul again mentions Apollos kindly in Tit. iii. 13, and recommends him and Zenas the lawyer to the attention of Titus, knowing that they designed to visit Crete, where Titus then was. Jerome is of opinion (*Comment. in loc.*) that he remained at Crete until he heard that the divisions at Corinth had been healed by means of St. Paul's letter; and that he then returned to that city, of which he afterwards became bishop. This has an air of probability; and the authority on which it rests is better than any we have for the different statements which make him bishop of Duras, of Colophon, of Iconium (in Phrygia), or of Caesarea.

APOSTLE (Gr. Ἀπόστολος, from ἀποστέλλω, to send forth). In Attic Greek the term is used to denote a *fleet*, or *naval armament*. It occurs only once in the Sept. (1 Kings xiv. 6), and there, as uniformly in the New Testament, it signifies a *person sent by another, a messenger*. It has been asserted that the Jews were accustomed to term the collector of the half-shekel, which every Israelite paid annually to the Temple, an apostle; and we have better authority for asserting that they used the word to denote one who carried about encyclical letters from their rulers. Ecumenius states that ἀποστόλους δε εἰσέτι καὶ νῦν ἔθος ἔστιν Ἰουδαίους ὀνομάζειν τοὺς ἐγκύκλια γράμματα παρὰ τῶν ἀρχόντων αὐτῶν ἀνακομιζομένους; 'It is even yet a custom among the Jews to call those who carry about circular letters from their rulers by the name of apostles.' To this use of the term Paul has been supposed to refer (Gal. i. 1) when he asserts that he was 'an apostle, not of men, neither by men'—an apostle, not like those known among the Jews by that name, who derived their authority and received their mission from the chief priests or principal men of their nation. The import of the word is strongly brought out in John xiii. 16, where it occurs along with its correlate, 'The servant is not greater than his Lord, neither *he who is sent* (ἀπόστολος) greater than he who sent him.'

The term is generally employed in the New Testament as the descriptive appellation of a comparatively small class of men, to whom Jesus Christ entrusted the organization of his church and the dissemination of his religion among mankind. At an early period of his ministry 'he ordained twelve' of his disciples 'that they should be with him.' 'These he named apostles.' Some time afterwards 'he gave to them power against unclean spirits to cast them out, and to heal all manner of disease;' and he sent them to preach the kingdom of God' (Mark iii. 14; Matt. x. 1-5; Mark vi. 7; Luke vi. 13; ix. 1). To them he gave 'the keys of the kingdom of God,' and constituted them princes over the spiritual Israel, that 'people whom God was to take from among the Gentiles, for his name' (Matt. xvi. 19; xviii. 18; xix. 28; Luke xxii. 30). Previously to his death he promised to them the Holy Spirit, to fit them to be the founders and governors of the Christian church (John xiv. 16, 17, 26; xv. 26, 27; xvi. 7-15). After his resurrection he so-

lemnly confirmed their call, saying, *Καθὼς ἀπέσταλκέ με ὁ Πατήρ, καὶ γὰρ πέμπω ὑμᾶς*—'As the Father hath sent me, so send I you;' and gave them a commission to 'preach the gospel to every creature' (John xx. 21-23; Matt. xviii. 18-20). After his ascension he, on the day of Pentecost, communicated to them those supernatural gifts which were necessary to the performance of the high functions he had commissioned them to exercise; and in the exercise of these gifts, they, in the Gospel history and in their epistles, with the Apocalypse, gave a complete view of the will of their Master in reference to that new order of things of which he was the author. They 'had the mind of Christ.' They spoke 'the wisdom of God in a mystery.' That mystery 'God revealed to them by his Spirit,' and they spoke it 'not in words which man's wisdom teacheth, but which the Holy Ghost teacheth.' They were 'ambassadors for Christ,' and besought men, 'in Christ's stead, to be reconciled to God.' They authoritatively taught the doctrine and the law of their Lord; they organized churches, and required them to 'keep the traditions,' *i. e.* the doctrines and ordinances delivered to them' (Acts ii.; 1 Cor. ii. 16; ii. 7, 10, 13; 2 Cor. v. 20; 1 Cor. xi. 2). Of the twelve originally ordained to the apostleship, one, Judas Iscariot, 'fell from it by transgression,' and Matthias, 'who had companied' with the other Apostles 'all the time that the Lord Jesus went out and in among them,' was by lot substituted in his place (Acts i. 17-26). Saul of Tarsus, afterwards termed Paul, was also miraculously added to the number of these permanent rulers of the Christian society (Acts ix.; xx. 4; xxvi. 15-18; 1 Tim. i. 12; ii. 7; 2 Tim. i. 11).

The characteristic features of this highest office in the Christian church have been very accurately delineated by M'Lean, in his *Apostolic Commission*. 'It was essential to their office—1. That they should have seen the Lord, and been eye and ear witnesses of what they testified to the world (John xv. 27). This is laid down as an essential requisite in the choice of one to succeed Judas (Acts i. 21, 22). Paul is no exception here; for, speaking of those who saw Christ after his resurrection, he adds, 'and last of all he was seen of me' (1 Cor. xv. 8). And this he elsewhere mentions as one of his apostolic qualifications: 'Am I not an apostle? have I not seen the Lord?' (1 Cor. ix. 1). So that his 'seeing that Just One and hearing the word of his mouth' was necessary to his being 'a witness of what he thus saw and heard' (Acts xxii. 14, 15). 2. They must have been immediately called and chosen to that office by Christ himself. This was the case with every one of them (Luke vi. 13; Gal. i. 1). Matthias not excepted; for, as he had been a chosen disciple of Christ before, so the Lord, by determining the lot, declared his choice, and immediately called him to the office of an apostle (Acts i. 24-26). 3. Infallible inspiration was also essentially necessary to that office (John xvi. 13; 1 Cor. ii. 10; Gal. i. 11, 12). They had not only to explain the true sense and spirit of the Old Testament (Luke xxiv. 27; Acts xxvi. 22, 23; xxviii. 23), which were hid from the Jewish doctors, but also to give forth the New Testament revelation to the world, which was to be the unalterable standard of faith and practice in all succeeding

generations (1 Pet. i. 25; 1 John iv. 6). It was therefore absolutely necessary that they should be secured against all error and mistake, by the unerring dictates of the spirit of truth. Accordingly Christ promised and actually bestowed on them the Spirit to 'teach them all things,' to 'bring all things to their remembrance whatsoever he had said to them' (John xiv. 26), to 'guide them into all truth,' and to 'show them things to come' (John xvi. 13). Their word therefore must be received, 'not as the word of men, but as it is in truth, the word of God' (1 Thes. ii. 13), and as that whereby we are to distinguish 'the spirit of truth from the spirit of error' (1 John iv. 6). 4. Another apostolic qualification was the power of working miracles (Mark xvi. 20; Acts ii. 43), such as speaking with divers tongues, curing the lame, healing the sick, raising the dead, discerning of spirits, conferring these gifts upon others, &c. (1 Cor. xii. 8-11). These were the credentials of their divine mission. 'Truly,' says Paul, 'the signs of an apostle were wrought among you in all patience, in signs and wonders and mighty deeds' (2 Cor. xii. 12). Miracles were necessary to confirm their doctrine at its first publication, and to gain credit to it in the world as a revelation from God, and by these 'God bare them witness' (Heb. ii. 4). 5. To these characteristics may be added the *universality* of their mission. Their charge was not confined to any particular visible church, like that of ordinary pastors, but, being the oracles of God to men, they had 'the care of all the churches' (2 Cor. xi. 28). They had a power to settle their faith and order as a model to future ages, to determine all controversies (Acts xvi. 4), and to exercise the rod of discipline upon all offenders, whether pastors or flock (1 Cor. v. 3-6; 2 Cor. x. 8; xiii. 10).

It must be obvious, from this scriptural account of the apostolical office, that the Apostles had, in the strict sense of the term, no successors. Their qualifications were supernatural, and their work, once performed, remains in the infallible record of the New Testament, for the advantage of the Church and the world in all future ages. They are the only authoritative teachers of Christian doctrine and law. All official men in Christian churches can legitimately claim no higher place than expounders of the doctrines and administrators of the laws found in their writings. Few things have been more injurious to the cause of Christianity than the assumption on the part of ordinary office-bearers in the Church of the peculiar prerogatives of 'the holy apostles of our Lord Jesus.' Much that is said of the latter is not at all applicable to the former; and much that admits of being applied, can be so, in accordance with truth, only in a very secondary and extenuated sense.

It is the opinion of the learned Suicer (*The-saurus*, art. Ἀπόστολος) that the appellation 'apostle' is in the New Testament employed as a general name for Christian ministers or pastors, who are 'sent by God,' in a qualified use of that phrase, to preach the word of God. But this opinion does not seem to rest on any solid foundation. It is true indeed that the word is used in this loose sense by the Fathers. Thus we find Archippus, Philemon, Apphia, the seventy disciples (Luke x. 1-17), termed apostles; and even

Mary Magdalene is said *γενέσθαι τοῖς ἀποστόλοις ἀπόστολος*, to become an apostle to the Apostles. No satisfactory evidence, however, can be brought forward of the term being thus used in the New Testament. Andronicus and Junia (Rom. xvi. 7) are indeed said to be *ἐπίσημοι ἐν τοῖς ἀποστόλοις*, 'of note among the Apostles'; but these words by no means necessarily imply that these persons were apostles; they may, and probably do, signify merely that they were persons well known and much esteemed by the Apostles. The *Συνεργοί*, the fellow-workers of the Apostles, are by Chrysostom denominated *Συναπόστολοι*.

The argument founded on 1 Cor. iv. 9, compared with ver. 6, to prove that Apollos is termed an apostle, cannot bear a close examination. The only instance in which it seems probable that the word, as expressive of an office in the Christian church, is applied to an individual whose call to that office is not made the subject of special narration, is to be found in Acts xiv. 4, 14, where Barnabas, as well as Paul, is termed an apostle. At the same time it is by no means absolutely certain that the term *apostles*, or messengers, does not in this place refer rather to the mission of Paul and Barnabas by the prophets and teachers at Antioch, under the impulse of the Holy Ghost (Acts xiii. 1-4), than to that direct call to the Christian apostleship which we know Paul received, and which, if Barnabas had received, we can scarcely persuade ourselves that no trace of so important an event should have been found in the sacred history, but a passing hint, which admits, to say the least, of being plausibly accounted for in another way. We know that on the occasion referred to, 'the prophets and teachers, when they had fasted and prayed, and laid their hands on Barnabas and Saul (*ἀπέλυσαν*), sent them away;' so that, in the sense in which we will immediately find the words occurring, they were *ἀπόστολοι*—of the prophets and teachers.

The word 'apostle' occurs once in the New Testament (Heb. iii. 1) as a descriptive designation of Jesus Christ: 'The apostle of our profession,' i. e. the apostle whom we profess or acknowledge. The Jews were in the habit of applying the term *שליח*, from *שלח*, to send, to the person who presided over the synagogue, and directed all its officers and affairs. The Church is represented as 'the house or family of God,' over which he had placed, during the Jewish economy, Moses, as the superintendent,—over which he has placed, under the Christian economy, Christ Jesus. The import of the term *apostle*, is—divinely-commissioned superintendent; and of the whole phrase, 'the apostle of our profession,' the divinely-commissioned superintendent, whom we Christians acknowledge, in contradistinction to the divinely-appointed superintendent Moses, whom the Jews acknowledged.

In 2 Cor. viii. 23, we meet with the phrase *ἀπόστολοι ἐκκλησιῶν*, rendered in our version 'the messengers of the churches.' Who these apostles were, and why they received this name, is obvious from the preceding context. The churches of Macedonia had made a liberal contribution for the relief of the impoverished and persecuted saints of Judæa, and had not merely requested the Apostle 'to receive the gift, and take on him the fellowship of ministering to the

saints,' but at his suggestion had appointed some individuals to accompany him to Jerusalem with their alms. These 'apostles or messengers of the churches' were those 'who were chosen of the churches to travel with the Apostle with this grace [gift], which was administered by him,' to the glory of their common Lord (2 Cor. viii. 1-4, 19). Theophylact explains the phrase thus: *οἱ ὑπὸ τῶν ἐκκλησιῶν πεμφθέντες καὶ χειροτονηθέντες*, 'those sent and chosen by the churches.'

With much the same meaning and reference Epaphroditus (Phil. ii. 25) is termed *ἀπόστολος*—a messenger of the Philippian Church—having been employed by them to carry pecuniary assistance to the Apostle (Phil. iv. 14-18). Theophylact's exposition is as follows:—'*Ἀπόστολόν ὑμῶν—τὸν παρ' ὑμῶν ἀποσταλέντα πρὸς με—δι' αὐτοῦ γὰρ ἦσαν στείλαντες αὐτῷ τὰ πρὸς χρεῖαν.*

It is scarcely worth while to remark that the Creed, commonly called the The Apostles', though very ancient, has no claim to the name, except as it contains apostolical doctrine. A full and satisfactory account of it will be found in Lord King's *History of the Apostles' Creed, with Critical Observations on its several Articles*. The Canons and Constitutions, called apostolical, are generally admitted to be forgeries, probably of the fifth century.

In the early ecclesiastical writers we find the term *ὁ ἀπόστολος*, 'the Apostle,' used as the designation of a portion of the canonical books, consisting chiefly of the Pauline Epistles. 'The Psalter' and 'the Apostle' are often mentioned together. It is also not uncommon with these writers to call Paul 'The Apostle,' *κατ' ἐξοχήν*.—
J. B.

APPEAL. The right of appeal to superior tribunals has generally been considered an essential concomitant of inferior judicatories. When, from the paucity of the population or any other cause, the subjects of litigation are few, justice is usually administered by the first authority in the state, from whose award no appeal can lie. But when the multiplication of causes precludes the continuance of this practice, and one or more inferior courts take cognizance of the less important matters, the right of appeal to the superior tribunal is allowed, with increasing restrictions as, in the course of time, subjects of litigation multiply, and as the people become weaned from the notion that the administration of justice is the proper function of the chief civil magistrate.

In the patriarchal times, as among the Bedouins, the patriarch or head of the tribe, that is to say, the Sheikh, administered justice; and as there was no superior power, there could be no appeal from his decisions. The only case of procedure against a criminal which occurs during the patriarchal period is that in which Judah commanded the supposed adulterous Tamar to be brought forth and burnt (Gen. xxxviii. 24). But here the woman was his daughter-in-law, and the power which Judah exercised was that which a man possessed over the females of his own immediate family. If the case had been between man and man, Judah could have given no decision, and the matter would, without doubt, have been referred to Jacob.

In the desert Moses at first judged all causes himself; and when, finding his time and strength

unequal to this duty, he, at the suggestion of Jehro, established a series of judicatories in a numerically ascending scale (Exod. xviii. 13-26), he arranged that cases of difficulty should be referred from the inferior to the superior tribunals, and in the last instance to himself. Although not distinctly stated, it appears from various circumstances that the clients had a right of appeal, similar to that which the courts had of reference. When the prospective distribution into towns, of the population which had hitherto remained in one compact body, made other arrangements necessary, it was directed that there should be a similar reference of difficult cases to the metropolitan court or chief magistrate ('the judge that shall be in those days') for the time being (Deut. xvi. 18; xvii. 8-12). That there was a concurrent right of appeal, appears from the use Absalom made of the delay of justice, which arose from the great number of cases that came before the king his father (2 Sam. xv. 2-4). These were doubtless appeal cases, according to the above direction; and M. Salvador (*Institutions de Moïse*, ii. 53) is scarcely warranted in deducing from this instance that the clients had the power of bringing their cases *directly* to the supreme tribunal.

Of the later practice, before and after the time of Christ, we have some clearer knowledge from Josephus and the Talmudists. It seems that a man could carry his case by appeal through all the inferior courts to the Grand Sanhedrim at Jerusalem, whose decision was in the highest degree absolute and final. The Jews themselves trace the origin of these later usages up to the time of Moses: they were at all events based on early principles, and therefore reflect back some light upon the intimations respecting the right of appeal which we find in the sacred books (*Mishna, de Synedr.* ch. x.; *Talm. Hieros.* ch. xviii.; *Talm. Bab.* ch. iii. and x.; Maimon. *de Synedr.* ch. x.; Selden, *de Synedr.* b. iii. ch. 10; Lewis, *Origines Hebrææ*, b. i. c. 6; Pastoret, *Législation des Hébreux*, ch. x.; Salvador, *Hist. des Institutions de Moïse*, liv. iv. ch. 2).

The most remarkable case of appeal in the New Testament belongs to another class. It is the celebrated appeal of St. Paul from the tribunal of the Roman procurator Festus to that of the emperor; in consequence of which he was sent as a prisoner to Rome (Acts xxv. 10, 11). Such an appeal having been once lodged, the governor had nothing more to do with the case: he could not even dismiss it, although he might be satisfied that the matter was frivolous, and not worth forwarding to Rome. Accordingly, when Paul was again heard by Festus and king Agrippa (merely to obtain materials for a report to the emperor), it was admitted that the apostle might have been liberated if he had not appealed to Cæsar (Acts xxvi. 32). Paul might therefore seem to have taken a false step in the matter, did we not consider the important consequences which resulted from his visit to Rome.

It may easily be seen that a right of appeal which, like this, involved a long and expensive journey, was by no means frequently resorted to. In lodging his appeal Paul exercised one of the high privileges of Roman citizenship which belonged to him by birth (Acts xxii. 28). How the rights of Roman citizenship might be

acquired by a Jewish native of Cilicia will be explained elsewhere [CITIZENSHIP]. The right of appeal connected with that privilege originated in the Valerian, Porcian, and Sempronian laws, by which it was enacted that if any magistrate should order flagellation or death to be inflicted upon a Roman citizen, the accused person might appeal to *the judgment of the people*, and that meanwhile he should suffer nothing at the hands of the magistrate until the people had judged his cause. But what was originally the prerogative of the people had in Paul's time become that of the emperor, and appeal therefore was made to *him*. Hence Pliny (*Ep.* x. 97) mentions that he had sent to Rome some Christians, who were Roman citizens, and had appealed unto Cæsar. This privilege could not be disallowed by any magistrate to any person whom the law entitled to it. Indeed, very heavy penalties were attached to any refusal to grant it, or to furnish the party with facilities for going to Rome.

APPHIA (Ἀφία), the name of a woman (Philemon 2) who is supposed by Chrysostom and Theodoret to have been the wife of Philemon.

APPII-FORUM (Ἀππίου φόρον), a market-town in Italy, 43 Roman miles from Rome (*Itiner. Anton.* p. 107), on the great road (*via Appia*) from Rome to Brundisium, constructed by Appius Claudius. The remains of an ancient town, supposed to be Appii-Forum, are still preserved at a place called Casarillo di Santa Maria, on the border of the Pontine marshes. Its vicinity to the marshes accounts for the badness of the water, as mentioned by Horace (*Sat.* i. 3, 7). When St. Paul was taken to Italy, some of the Christians of Rome, being apprised of his approach, journeyed to meet him as far as 'Appii-Forum and the Three Taverns' (ἔχρησ Ἀππίου φόρου καὶ Τριῶν Ταβερνῶν, Acts xxviii. 15). The 'Three Taverns' were eight or ten miles nearer to Rome than Appii-Forum. The probability is that some of the Christians remained at the 'Three Taverns,' where it was known the advancing party would rest, while some others went on as far as Appii-Forum to meet Paul on the road. The 'Three Taverns' was certainly a place for rest and refreshment (*Cic. ad Attic.* ii. 11, 13), perhaps on account of the bad water at Appii-Forum. It must be understood that Tres Tabernæ was, in fact, the name of a town; for in the time of Constantine, Felix, bishop of Tres Tabernæ, was one of the nineteen bishops who were appointed to decide the controversy between Donatus and Cæcilianus (*Optat. de Schism. Donat.*, l. i. p. 26). As to the tabernæ themselves, from which the place took its name, it is probable that they were *shops* for the sale of all kinds of refreshments, rather than inns or places of entertainment for travellers. The ruins of this place still exist under the same name.

APPLE, APPLE-TREE. [TAPPAUGH.]

APPLES OF SODOM. [SODOM, APPLES OF.]

AQUILA (Ἀκύλας), a Jew with whom Paul became acquainted on his first visit to Corinth; a native of Pontus, and by occupation a tent-maker. He and his wife Priscilla had been obliged to leave Rome in consequence of an edict issued by the Emperor Claudius, by which all Jews were banished from Rome (*Judeos, impulsore Chresto, assidue tumultuantes Roma expulsi*:—*Sueton. Claud.* c. 25; Neander's *History of the*

Planting of the Christian Church, vol. i. p. 231; Lardner's *Testimonies of Heathen Authors*, ch. viii.). This decree was made not by the senate, but the emperor, and lasted only during his life, if even so long. Whether Aquila and Priscilla were at that time converts to the Christian faith cannot be positively determined; Luke's expression, *προσηλθεν αυτοις*, Acts xviii. 2, as Kuinoel observes, rather implies that Paul sought their society on grounds of friendship, than for the purpose of persuading them to embrace Christianity. On the other hand, if we suppose that they were already Christians, Paul's 'joining himself to them' is highly probable; while, if they were still adherents to Judaism, they would have been less disposed than even unconverted Gentiles to form an intimacy with the Apostle. At all events, they had embraced Christianity before Paul left Corinth; for we are informed that they accompanied him to Ephesus, and meeting there with Apollos, who 'knew only the baptism of John,' they 'instructed him in the way of God more perfectly' (Acts xviii. 25, 26). From that time they appear to have been zealous promoters of the Christian cause. Paul styles them his 'helpers in Christ Jesus,' and intimates that they had exposed themselves to imminent danger on his account ('who have for my life laid down their own necks,' Rom. xvi. 3, 4), though of the time and place of this transaction we have no information. When Paul wrote his epistle to the Romans they were at Rome; but some years after they returned to Ephesus, for Paul sends salutations to them in his Second Epistle to Timothy (2 Tim. iv. 19; Lardner's *Credibility*, part ii. ch. 11). Their occupation as tent-makers probably rendered it necessary for them to keep a number of workmen constantly resident in their family, and to these (to such of them at least as had embraced the Christian faith) may refer the remarkable expression, '*the Church that is in their house*,' *την κατ' οικον αυτων εκκλησιαν* (see Biscoe, quoted in Lardner's *Credibility*, part ii. ch. 11). Origen's explanation of these words is very similar: 'Magna enim gratia in hospitalitatis officio non solum apud Deum, sed et apud homines invenitur. Quæ tamen res quoniam non solum in voluntate et proposito dominorum, sed et grato ac fideli constitit ministerio famulorum, idcirco omnes qui ministerium istud cum ipsis fideliter adimplebant, domesticam eorum nominavit Ecclesiam' (*In Ep. ad Rom. Comment.* lib. x.; *Opera*, t. vii. p. 431, ed. Berol. 1837).

Dr. Neander suggests that as Aquila would require extensive premises for his manufactory, he, perhaps, set apart one room for the use of a section of the Church in whatever place he fixed his residence, and that as his superior Christian knowledge and piety qualified him for the office of a *διδάσκαλος*, he gave religious instruction to this small assembly. The salutations to individuals which follow the expression in Rom. xvi. 5, show that they were not referred to in it, and are quite inconsistent with the supposition that the whole church met in Aquila's house. Nor is it probable that the collective body of Christians in Rome or elsewhere would alter their place of meeting on Aquila's return. The same eminent critic brings forward as an illustration of the expression the examination of Justin Martyr

before the Præfect Rusticus. 'Where do you assemble? *πὺ συνέρχεσθε*;' said the Præfect Justin replied, 'Wherever it suits each one's preference and ability: you take for granted that we all meet in the same place; but it is not so, for the God of the Christians is not circumscribed by place, but, being invisible, fills heaven and earth, and is everywhere worshipped and glorified by the faithful.' Rusticus then said: 'Tell me where you meet together, or in what place you collect your disciples?' Justin said: 'I am staying at the house of one Martinus, and I know no other place of meeting besides this (*καὶ οὐ γινώσκω ἄλλην τινὰ συνέλευσιν*), and if any one wished to come to me, I communicated to him the words of truth.' The persons who thus visited Justin might be called *ἡ κατ' οικον τοῦ Ἰουστίνου ἐκκλησία* (Neander's *Allgemeine Geschichte der Christlichen Religion und Kirche*, I. ii. pp. 402, 503; *Justini Martyris Opera*, *Append.* pars ii. p. 586, Parisii, 1742).

The Greeks call Aquila bishop and apostle, and honour him on July 12. The festival of Aquila and Priscilla is placed in the Roman Calendar, where he is denoted Bishop of Hieraclea, on July 8, (Calmet).—J. E. R.

AR (אָר; Sept. Ἄρ), the capital city of the Moabites (Num. xxi. 28; Deut. ii. 9, 18, 29), near the river Arnon (Deut. ii. 18, 24; Num. xxi. 13-15). It appears to have been burnt by King Sihon (Num. xxi. 28), and Isaiah, in describing the future calamities of the Moabites, says, 'In the night Ar of Moab is laid waste and brought to silence' (Isa. xv. 1). In his comment on this passage, Jerome states that in his youth there was a great earthquake, by which Ar was destroyed in the night-time. This he evidently regards as a fulfilment of the prediction, which, however, had probably some less remote reference. Latterly the name of the city was Græcised into Areopolis.

This city was also called Rabbah or Rabbath, and, to distinguish it from Rabbath of Ammon, Rabbath-Moab. Ptolemy calls it Rabmathon; Steph. Byzantinus, Rabathmoma; and Abulfeda (*Tab. Syr.*, p. 90), Rabbath, and also Mab. The site still bears the name of Rabbah. The spot has been visited and described by Seetzen, Burckhardt, Legh, Macmichael, and Irby and Mangles. It is about 17 miles east of the Dead Sea, 10 miles south of the Arnon (Modjeb), and about the same distance north of Kerek. The ruins of Rabbah are situated on a low hill, which commands the whole plain. They present nothing of interest except two old Roman temples and some tanks. Irby and Mangles (*Letters*, p. 457) remark, with surprise, that the whole circuit of the town does not seem to have exceeded a mile. Burckhardt says, 'half an hour in circuit,' and that no trace of walls could be found: but it is obvious from the descriptions that the city whose ruins they saw was a comparatively modern town, less important and extensive than the ancient metropolis of Moab.

ARABAH (אֲרָבָה; Sept. Ἀραβα), a Hebrew word, signifying in general a *desert plain*, or *steppe*. In the Authorized Version it is translated 'the plain,' but in the original it appears to be supplied with the article on purpose, as the proper name (הַעֲרָבָה ha-Arabah, *the Arabah*),

of the great plain or valley in its whole extent, which is partly occupied by the Jordan and its lakes, and is prolonged from the Dead Sea to the Eleanitic Gulf. The name has come down to the present day in the same form in Arabic, *el-Arabah* (العربة); but it is now restricted to the part between the lake and the gulf. The more extended application of the name by the Hebrews is successfully traced by Professor Robinson from Gesenius: 'In connection with the Red Sea and Elath' (Deut. i. 1; ii. 8). 'As extending to the lake of Tiberias' (Josh. xii. 3; 2 Sam. iv. 7; 2 Kings xxv. 4). 'Sea of the Arabah, the Salt Sea' (Josh. iii. 16; xii. 3; Deut. iv. 49). 'The *arboth* (plains) of Jericho' (Josh. v. 10; 2 Kings xxv. 5). 'Plains (*arboth*) of Moab,' *i. e.* opposite Jericho, probably pastured by the Moabites, though not within their proper territory (Deut. xxiv. 1, 8; Num. xxii. 1) [ARABIA; JORDAN, VALLEY OF].



ARABIA, an extensive region occupying the south-western extremity of Asia, between $12^{\circ} 45'$ and $34\frac{1}{2}^{\circ}$ N. lat., and $32\frac{1}{2}^{\circ}$ and 60° E. long. from Greenwich; having on the W. the Isthmus of Suez and the Red Sea (called from it the *Arabian Gulf*), which separate it from Africa; on the S. the Indian Ocean; and on the E. the Persian Gulf and the Euphrates. The boundary to the north has never been well defined, for in that direction it spreads out into interminable deserts, which meet those of Palestine and Syria on the west, and those of *Irak-Arabi* (*i. e.* Babylonia) and Mesopotamia on the east; and hence some geographers include that entire wilderness in Arabia. The form of the peninsula is that of a trapezoid, whose superficial area is estimated at four times the extent of France. It is one of the few countries of the south where the descendants of the aboriginal inhabitants have neither been extirpated nor expelled by northern invaders.

They have not only retained possession of their ancestral homes, but have sent forth colonies to all the adjacent regions, and even to more distant lands, both in Africa and Asia. 'There is no people,' says Ritter (*Erdkunde*, th. ii. p. 172), 'who are less circumscribed to the territory usually assigned to them than the Arabs; their range outstrips geographical boundaries in all directions.'

With the history of no country save that of Palestine are there connected so many hallowed and impressive associations as with that of Arabia. Here lived and suffered the holy patriarch Job; here Moses, when 'a stranger and a shepherd,' saw the burning, unconsuming bush; here Elijah found shelter from the rage of persecution; here was the scene of all the marvellous displays of divine power and mercy that followed the deliverance of Israel from the Egyptian yoke, and accompanied their journeyings to the Promised Land; and here Jehovah manifested himself in visible glory to his people. From the influence of these associations, combined with its proximity to Palestine, and the close affinity in blood, manners, and customs between the northern portion of its inhabitants and the Jews, Arabia is a region of peculiar interest to the student of the Bible; and it is chiefly in its relation to subjects of Bible study that we are now to consider it. It was well remarked by Burckhardt (who knew Arab life and character better than any other European traveller that has yet appeared) that 'the sacred historian of the children of Israel will never be thoroughly understood, so long as we are not minutely acquainted with everything relating to the Arab Bedouins and the countries in which they move and pasture.'

In early times the Hebrews included a part of what we call Arabia among the countries they vaguely designated as קֶדֶם *Kedem*, 'the East,' the inhabitants being numbered among the בְּנֵי קֶדֶם *Beni-Kedem*, 'Sons of the East,' *i. e.* Orientals. But there is no evidence to show (as is asserted by Winer, Rosenmüller, and other Bible-geographers) that these phrases are ever applied to the whole of the country known to us as Arabia. They appear to have been commonly used in speaking of those parts which lay due east of Palestine, or on the north-east and south-east; though occasionally they do seem to point to tracts which lay indeed to the south and south-west of that country, but to the east and south-east of Egypt. Hence Joseph Mede (who is followed by Bellemann, *Handbuch d. Bib. Literatur*, th. iii. p. 220) is of opinion that the phraseology took its rise at the period when the Israelites were in Egypt, and was retained by them as a mode of speech after they were settled in Canaan. That conjecture would, doubtless, considerably extend the meaning of the term; yet even then it could scarcely embrace the extreme south of Arabia, a queen in which (on the supposition of Yemen being identical with Sheba) is, in the New Testament, styled not 'a queen of the East,' but Βασιλίσσα Νότου , 'a queen of the South.' Accordingly we find that whenever the expression *kedem* has obviously a reference to Arabia, it invariably points to its northern division only. Thus in Gen. xxv. 6, Abraham is said to have sent away the sons of Hagar and Keturah to the *Eretz-Kedem—Kedemah*, *i. e.* the East

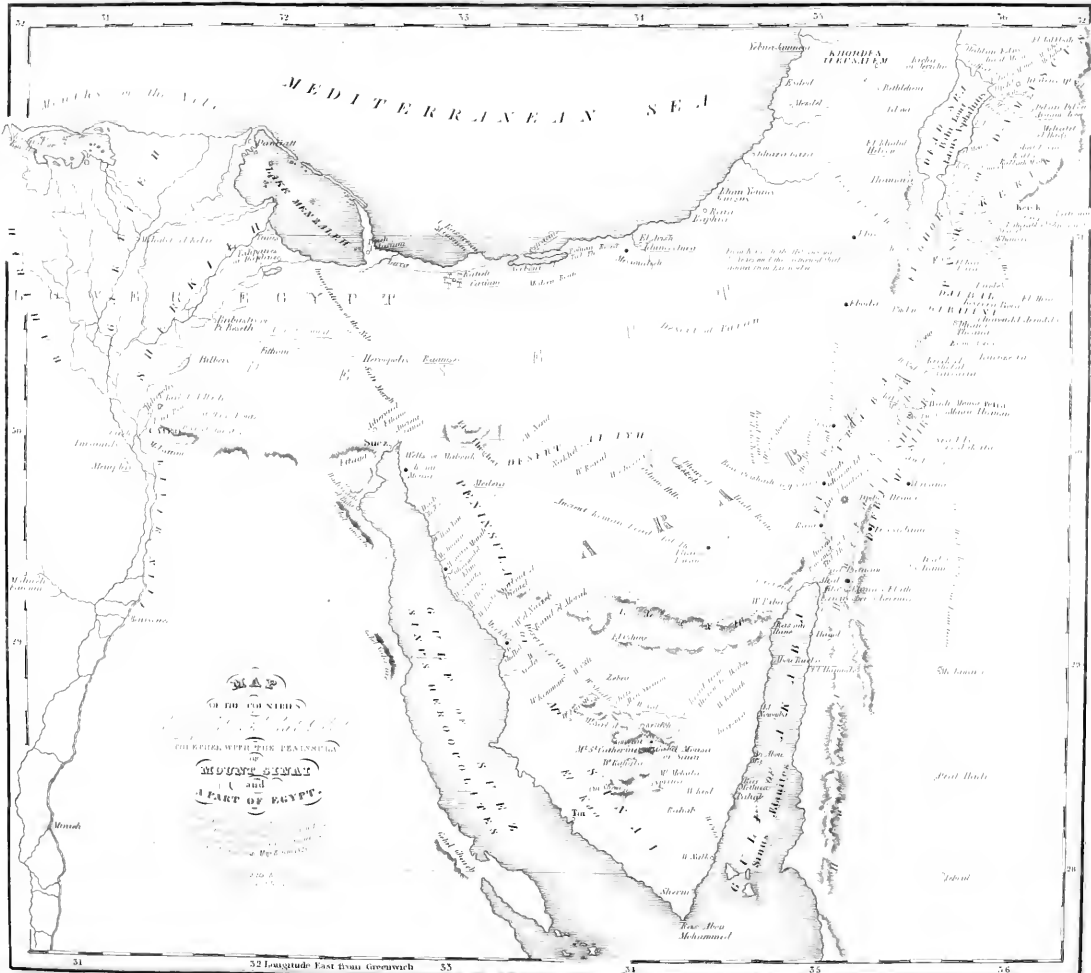

 OF THE SINAI
 THE GREAT SAND DESERT
 OF
EGYPT
 AND
 THE SINAI PENINSULA

country, eastward; and none of them, so far as we know, were located in peninsular Arabia; for the story which represents Ishmael as settling at Mecca is an unsupported native tradition. The patriarch Job is described (Job i. 3) as 'the greatest of all the men of the east,' and though opinions differ as to the precise locality of the land of Uz, all are agreed that it was in some part of Arabia, but certainly not in Arabia Felix. In the Book of Judges (vi. 3; vii. 12; viii. 10) among the allies of the Midianites and Amalekites (tribes of the north) are mentioned the 'Beni-Kedem,' which Josephus translates by *Ἀραβας*, the Arabs. In Isa. xi. 14, the parallelism requires that by 'sons of the east' we understand the *Nomades* of Desert Arabia, as corresponding to the Philistines 'on the west;' and with these are conjoined the Edomites, Moabites, and Ammonites, who were all northern Arabians. The command was given (Jer. xlix. 28) to the Babylonians 'to smite the Beni-Kedem,' who are there classed with the Kedarenes, descendants of Ishmael (comp. 1 Kings iv. 30). In more modern times a name of similar import was applied to the Arabs generally; they were called *Saracens* (*Sharakiyun*, *i. e.* Orientals) from the word *shark*, 'the east,' whence also is derived the term *sirocco*, the east wind. The name of Saracens came into use in the west in a vague and undefined sense after the Roman conquest of Palestine, but does not seem to have been adopted as a general designation till about the eighth century. It is to be remarked here that though in Scripture *Kedem* most commonly denotes Northern Arabia, it is also used of countries farther east, *e. g.* of the native country of Abraham (Isa. xli. 2; comp. Gen. xxix. 1), of Balaam (Num. xxiii. 7), and even of Cyrus (Isa. xli. 11); and, therefore, though the Magi who came to Jerusalem (Matt. ii. 1) were ἀπὸ ἀνατολῶν, 'from the east,' it does not thence follow that they were natives of Arabia.

We find the name *عرب* (*Arab*, first beginning to occur about the time of Solomon. It designated a portion of the country, an inhabitant being called Arabi, an Arabian (Isa. xlii. 20), or in later Hebrew, Arbi (Neh. ii. 19), the plural of which was Arbin (2 Chr. xxi. 16), or Arbiim (*Arabians*) (2 Chr. xvii. 11). In some places these names seem to be given to the Nomadic tribes generally (Isa. xlii. 20; Jer. iii. 2) and their country (Isa. xxi. 13). The kings of Arabia from whom Solomon (2 Chr. ix. 14) and Jehosaphat (2 Chr. xvii. 11) received gifts were, probably, Bedouin chiefs; though in the place parallel to the former text (1 Kings x. 15), instead of *Arab* we find *Ereb*, rendered in Jer. xxv. 20, 24, 'mingled people,' but which Gesenius, following the Chaldee, understands to mean 'foreign allies.' It is to be remarked, however, that in all the passages where the word *Arab* occurs it designates only a small portion of the territory known to us as Arabia. Thus in the account given by Ezekiel (xxvii. 21) of the Arabian tribes that traded with Tyre, mention is specially made of *Arab* (comp. Jer. xxv. 24). In 2 Chr. xxi. 16; xxii. 1; xxvi. 7; Neh. iv. 7, we find the Arabians classed with the Philistines, the Ethiopians (*i. e.* the Asiatic Cushites, of whom they are said to have been neighbours), the Mehumims,

the Ammonites, and Ashdodites. At what period this name *Arab* was extended to the whole region it is impossible to ascertain. From it the Greeks formed the word Ἀραβία, which occurs twice in the New Testament; in Gal. i. 17, in reference probably to the tract adjacent to Damascene Syria, and in Gal. iv. 25, in reference to the peninsula of Mount Sinai. Among the strangers assembled at Jerusalem at the Pentecost there were Ἀραβες, Arabs (Acts ii. 11), the singular being Ἀραβ.

As to the etymology of the name *Arab* various opinions have been expressed. Hezel (*Bib. Real Lex.*) and Bellermann (*Handbuch d. Bib. Liter.* th. iii. p. 219) absurdly derive it from a transposition of letters in the name of Eber, the father of Joktan; Pococke follows the native writers in thinking the name was taken from Araba, a district of Yemen, so called from Yárab, Joktan's son; some suppose that as this country was called by the Israelites *Kedem*, 'the east,' so by the Semicitic tribes who dwelt beyond the Euphrates it was termed *Arab* in the sense of 'the west;' while others derive it from the same word in the sense of 'mixed people,' or 'merchants.' But dismissing these conjectures as groundless and unsatisfactory, the most obvious etymology of the name is from עֲרָבָה *Arabah*, a *steppe*, *i. e.* a desert plain or wilderness. That was, in point of fact, the name given by the ancient Hebrews to the tract of country extending northward from Elath, on the Arabian Gulf, to the Dead Sea (Deut. i. 1; ii. 8), and even as far as the Lake of Tiberias (Josh. xii. 3). It was called *Haa-Arabah*, commonly rendered in our version by 'the plain' (hence the Dead Sea was styled the 'sea of the Arabah,' Josh. iii. 16); and it included the plains (*Arboth*) of Jericho and Moab (Josh. v. 10; Deut. xxxiv. 1, 8). In the list of the cities of Judah contained in the book of Joshua we find (xv. 61), 'in the wilderness, Beth-Arabah,' in the Hebrew בֵּית הָעֲרָבָה, *i. e.* 'the house of the plain.' It had been mentioned at v. 6, as on the northern borders; and hence, at xviii. 22, it appears also as a city of Benjamin, one of whose boundaries, it is said at v. 18, 'passed over against [the] Arabah northward, and went down into [the] Arabah.' Now it is a remarkable circumstance that the southern part of this great valley is still known by the name of *Wady-el-Arabah*, and there is no improbability in the conjecture that this designation, which was applied at so early a period as the days of Moses to one particular district, was gradually extended to the entire region. No designation, indeed, could be more comprehensive or correct; for, looking to Arabia as a whole, it may fitly be described as one vast desert of arid and barren plains, intersected by chains of rocky mountains, where the *oases*, or 'spots of living green' (probably a corruption of the Arabic word *wady*, a valley or watercourse), exist but in a very small proportion to the sterility and desolation which reign around.

The modern name, *Jeshirat-el-Arab*, *i. e.* 'the peninsula of the Arabs,' applies to the southern part of the region only. Another native appellation is *Beled-el-Arab*, *i. e.* 'the land of the Arabs;' the Persians and Turks call it *Arabistán*. Mr. Lane informs us that in Egypt the term *Arab* is now generally limited to the Bedawees, or people of the desert; but formerly it was used to designate

nate the townspeople and villagers of Arabian origin, while those of the desert were called Aarab or Aarabees: the former now call themselves *Ow-lād-el-Arab*, or sons of the Arabs.

The early Greek geographers, such as Eratosthenes and Strabo, mention only two divisions of this vast region, *Happy* and *Desert* Arabia. But after the city of Petra, in Idumæa, had become celebrated as the metropolis of a commercial people, the Nabathæans, it gave name to a third division, viz. *Arabia Petræa* (improperly translated *Stony Arabia*); and this threefold division, which first occurs in the geographer Ptolemy, who flourished in the second century, has obtained throughout Europe ever since. It is unknown, however, to native or other Eastern geographers, who reckon Arabia Deserta as chiefly belonging to Syria and to Irak-Arabi, or Babylonia, while they include a great part of what we call Arabia Petræa in Egypt.

1. ARABIA FELIX (in Gr. ἡ Ἐὐδαίμων, the *Arabia Eudæmon* of Pliny), i. e. *Happy Arabia*. The name has commonly been supposed to owe its origin to the variety and richness of the natural productions of this portion of the country, compared with those of the other two divisions. Some, however, regard the epithet 'happy' as a translation of its Arabic name

يمن *Yemen*, which, though primarily denoting the land of the *right hand*, or *south*,* also bears the secondary sense of 'happy, prosperous.' This part of Arabia lies between the Red Sea on the west and the Persian Gulf on the east, the boundary to the north being an imaginary line drawn between their respective northern extremities, Akaba and Basra or Bussora. It thus embraces by far the greater portion of the country known to us as Arabia, which, however, is very much a *terra incognita*; for the accessible districts have been but imperfectly explored, and but little of the interior has been as yet visited by any European traveller.

Arabia may be described generally as an elevated table-land, the mountain ranges of which are by some regarded as a continuation of those of Syria, but Ritter (*Erdkunde*, th. i. p. 172) views them as forming a distinct and independent *plateau*, peculiar to the country. In Arabia Felix the ridges, which are very high in the interior, slope gently on the east towards the Persian Gulf, and on the north-east towards the vast plains of the desert. On the west the declivities are steeper, and on the north-west the chains are connected with those of Arabia Petræa. Commencing our survey at the north end of the Red Sea, the first province which lies along its shore is the *Hedjaz*, which Niebuhr and others reckon as belonging to Arabia Petræa, but which the editor of Burckhardt's *Travels in Arabia* has shown to belong properly to Arabia Felix. This was the cradle of Mohammedan superstition, containing both Mecca, where the prophet was born, and

Medina, where he was buried; and hence it became the Holy Land of the Moslem, whither they resort in pilgrimage from all parts of the East. It is on the whole a barren tract, consisting chiefly of rugged mountains and sandy plains. Still more unproductive, however, is the long, flat, dreary belt, of varying width, called *Tehâma*, which runs along the coast to the south of Hedjaz, and was at no distant period covered by the sea. But next to this comes *Yemen* (the name of a particular province, as well as of the whole country), the true Arabia Felix of the ancients, 'Araby the Blest' of modern poets, and doubtless the finest portion of the peninsula. Yet if it be distinguished for fertility and beauty, it is chiefly in the way of contrast, for it is far from coming up to the expectations which travellers had formed of it. Here is Sanaa (supposed to be the *Usal* of Scripture), the seat of an imaum; Mareb, which some identify with Sheba; Mocha, the chief mart for coffee; and Aden, a place rapidly increasing in importance since taken possession of by Britain, with a view to secure her navigation of the Red Sea. Turning from the west to the south coast of the peninsula, we next come to the extensive province of *Hhadramaut* (the Hazarmaveth of the Bible), a region not unlike Yemen in its general features, with the exception of the tracts called Mahbrah and Sahar, which are dreary deserts. The south-east corner of the peninsula, between Hhadramaut and the Persian Gulf, is occupied by the important district of *Oman*, which has recently become better known to us than most other parts of Arabia Felix by the travels and researches of Lieut. Wellsted (*Travels in Arabia*, London, 1838, 2 vols. 8vo.). Oman has been in all ages famous for its trade; and the present imaum of Muscat, a politic and enterprising prince, has greatly extended it, and thereby increased and consolidated his own power by forming commercial alliances with Great Britain, the United States, and other foreign nations. Along the Persian Gulf northward stretches the province of *Lahsa*, or rather *El Haassa*, to which belong the Bahrein Islands, famous for their pearls. The districts we have enumerated all lie along the coasts, but beyond them in the south stretches the vast desert of Akhaf, or Roha-el-Khali, i. e. 'the empty abode,' a desolate and dreary unexplored waste of sand. To the north of this extends the great central province of *Nedsched* or *Nejd*. Ritter regards it as forming nearly a half of the entire peninsula. It may be described as having been the great *officina gentium* of the south, as were Scandinavia and Tartary of the north; for it is the region whence there issued at different periods those countless hordes of Arabs which overran a great part of Asia and Africa. Here too was the origin and the seat of the Wababees (so formidable until subdued in 1818 by Mehemet Ali, pasha of Egypt), their chief town being Dereveh.

The *geological* structure and *mineralogical* productions of this part of Arabia are in a great measure unknown. In the mountains about Mecca and Medina the predominant rocks are of grey and red granite, porphyry, and limestone. This is also the case in the great chain that runs southward towards Maskat; only that in the ridge that rises behind the Tehama there is found

* This phraseology may have originated in the worship of the rising sun at the Kaaba, or ancient temple of Mecca, when the worshipper had the east *before* him, the west *behind* him, the south on his *right*, and the north on his *left*: hence Syria is called *Esh-Sham*, the *left*. Yet the Hebrews had the same idiom.

schistus and basalt instead of granite. Traces of volcanic action may be perceived around Medina, as also at Aden and in many other parts of the peninsula. Hot-springs are of frequent occurrence on the Hadjee or pilgrim road to Mecca. The ancients believed that Arabia yielded both gold and precious stones, but Niebuhr doubts if this ever was the case. The most valuable ore found now is the lead of Oman: what is called the Mocha stone is a species of agate that comes from India. The native iron is coarse and brittle; at Loheia and elsewhere there are hills of fossil salt. The *botany* of Yemen was investigated by Forskål, one of the fellow-travellers of Niebuhr. Arabia Felix has always been famous for frankincense, myrrh, aloes, balsam, gums, cassia, &c.; but it is doubtful whether the last-mentioned and other articles supposed to be indigenous were not imported from India. Here are found all the fruits of temperate and warm climates, among which the *dâte*, the fruit of the palm-tree, is the most common, and is, along with the species of grain called *dhourra*, the staple article of food. But the most valuable vegetable production is coffee (Arab. *kahweh*, an old term for wine, the fruit being called *bunn*); for Yemen, if not its native country, is the *habitat* where it has reached the greatest state of perfection. Cultivation here is not confined to the plains, but is carried up the sides of the mountains, which are laid out in terraces and supplied with water by means of artificial reservoirs. In the *animal* kingdom Arabia possesses, in common with the adjacent regions, the camel (the 'living ship of the desert'), panthers, lynxes, hyænas, jackals, gazelles, asses (wild and tame), monkeys, &c. But the glory of Arabia is its *horse*. As in no other country is that animal so much esteemed, so in no other are its noble qualities of swiftness, endurance, temper, attachment to man, so finely developed. Of the insect tribes, the locust, both from its numbers and its destructiveness, is the most formidable scourge to vegetation. The Arabian seas swarm with fish, sea-fowl, and shells; coral abounds in the Red Sea, and pearls in the Persian Gulf.

2. ARABIA DESERTA, called by the Greeks $\Sigma\kappa\eta\upsilon\tau\iota\varsigma$ Ἀραβία, or ἡ Ἐρημος Ἀραβία, and by the Arabs البادية *El-Badiyah*, i. e. the Desert.

This takes in that portion of the country which lies north-east of Arabia Felix, and is bounded on the north-east by the Euphrates, on the north-west by Syria, and on the west by Palestine and Arabia Petraea. The Arabs divide this 'great wilderness' into three parts, so called from their proximity to the respective countries, viz. *Badiyah esh Sham* (Syria), *Badiyah el Jeshrah* (the peninsula, i. e. Arabia), and *Badiyah el Irak* (Babylonia). From this word Badiyah comes the name of the nomadic tribes by whom it is traversed, viz. *Bedawees* (better known to us by the French corruption of *Bedouins*), who are not, however, confined to this portion of Arabia, but range throughout the entire region. So far as it has yet been explored, Desert Arabia appears to be one continuous, elevated, interminable *steppe*, occasionally intersected by ranges of hills. Sand and salt are the chief elements of the soil, which in many places is entirely bare, but elsewhere yields stunted and tawny shrubs or thinly-scattered saline plants. That

part of the wilderness called *El Hammad* lies on the Syrian frontier, extending from the Hauran to the Euphrates, and is one immense dead and dreary level, very scantily supplied with water, except near the banks of the river, where the fields are irrigated by wheels and other artificial contrivances.

The sky in these deserts is generally cloudless, but the burning heat of the sun is moderated by cooling winds, which, however, raise fearful tempests of sand and dust. Here, too, as in other regions of the East, occasionally prevails the burning, suffocating south-east wind, called by the Arabs *El Iharrûr* (the Hot), but more commonly *Samâm*, and by the Turks *Samyeli* (both words meaning 'the Poisonous'), the effects of which, however, have by some travellers been greatly exaggerated. This is probably 'the east wind' and the 'wind from the desert' spoken of in Scripture. Another phenomenon, which is not peculiar, indeed, to Desert Arabia, but is seen there in greatest frequency and perfection, is what the French call the *mirage*, the delusive appearance of an expanse of water, created by the tremulous, undulatory movement of the vapours raised by the excessive heat of a meridian sun. It is called in Arabic *serab*, and is no doubt the Hebrew *sarab* of Isa. xxxv. 7, which our translators have rendered 'the parched ground.'

3. ARABIA ΠΕΤΡΑΙΑ (Gr. Περραιά) appears to have derived its name from its chief town *Petra* (i. e. a rock), in Heb. *Setah*; although (as is remarked by Burckhardt) the epithet is also appropriate on account of the rocky mountains and stony plains which compose its surface. It embraces all the north-western portion of the country; being bounded on the east by Desert and Happy Arabia (for we have included the Hedjaz in the latter), on the north by Palestine and the Mediterranean, on the west by Egypt, and on the south by the Red Sea. This division of Arabia has been of late years visited by a great many travellers from Europe, and is consequently much better known than the other portions of the country. Confining ourselves at present to a general outline, we refer for details to the articles *SINAI*, *EXODUS*, *EDOM*, *MOAB*, &c. Beginning at the northern frontier, there meets the elevated plain of Belka, to the east of the Dead Sea, the district of Kerak (Kir), the ancient territory of the Moabites, their kinsmen of Ammon having settled to the north of this, in Arabia Deserta. The north border of Moab was the brook Arnon, now the Wady-el-Môjib; to the south of Moab, separated from it by the Wady-el-Ahsy, lay Mount Seir, the dominion of the Edomites, or *Idumæa*, reaching as far as to Elath on the Red Sea. The great valley which runs from the Dead Sea to that point consists, first, of El-Ghor, which is comparatively low, but gradually rises by a succession of limestone cliffs into the more elevated plain of *El-Arabah*, formerly mentioned. 'We were now,' says Professor Robinson (*Biblical Researches*, vol. ii. p. 502), 'upon the plain, or rather the rolling desert, of the *Arabah*; the surface was in general loose gravel and stones, everywhere furrowed and torn with the beds of torrents. A more frightful desert it had hardly been our lot to behold. The mountains beyond presented a most uninviting and hideous aspect; precipices and naked conical peaks of chalky

and gravelly formation rising one above another without a sign of life or vegetation.' It was once believed that through this great valley the Jordan anciently flowed, before the catastrophe of the cities of 'the plain (Arabah);' but from the depressed level of the Dead Sea (recently found by Lieut. Symonds to be no less than 1337 feet below that of the Mediterranean), from the great elevation of the Arabah, the long descent northward, and the run of the watercourses in the same direction, the hypothesis is found to be no longer tenable.* The structure of the mountains of Edom on the east of the Arabah is thus described by Robinson (vol. ii. p. 551): 'At the base low hills of limestone or argillaceous rocks; then the lofty masses of porphyry, constituting the body of the mountain; above these sandstone broken up into irregular ridges and grotesque groups of cliffs; and again, farther back and higher than all, long elevated ridges of limestone without precipices. East of all these stretches off indefinitely the high plateau of the great eastern desert. The character of these mountains is quite different from those on the west of the Arabah. The latter, which seemed to be not more than two-thirds as high, are wholly desert and sterile; while these on the east appear to enjoy a sufficiency of rain, and are covered with tufts of herbs and occasional trees.' This mountainous region is divided into two districts: that to the north is called *Jebal* (i. e. mountains, the Gebal of Ps. lxxxiii. 7); that to the south *Esh-Sherah*, which has erroneously been supposed to be allied to the Hebrew 'Seir,' whereas the latter (written with a ש) means 'hairy,' the former denotes 'a tract or region.' To the district of Esh-Sherah belongs Mount Hor, the burial-place of Aaron, towering above the Wady Mousa (valley of Moses), where are the celebrated ruins of Petra (the ancient capital of the Nabathæo-Idumæans), brought to light by Seetzen and Burckhardt, and now familiar to English readers by the illustrations of Irby and Mangles, Laborde, &c. As for the mountainous tract immediately west of the Arabah, Dr. Robinson describes it as a desert limestone region, full of precipitous ridges, through which no travelled road has ever passed.

To the west of Idumæa extends the 'great and terrible wilderness' of *Et-Tih*, i. e. 'the Wandering,' so called from being the scene of the wanderings of the children of Israel. It consists of vast interminable plains, a hard gravelly soil, and irregular ridges of limestone hills. The researches of Robinson and Smith furnish new and important information respecting the geography of this part of Arabia and the adjacent peninsula of Sinai. It appears that the middle of this desert is occupied by a long central basin, extending from *Jebel-et-Tih* (i. e. the mountain of the wandering, a chain pretty far south) to the shores of the Mediterranean. This basin descends towards the north with a rapid slope, and is drained through all its length by Wady-el-Arish,

* Yet Mr. Beek, in a paper read to the Geographical Society (May 9, 1842), thinks the progress of the Jordan to the Red Sea was arrested by volcanic eruptions, which, while they formed the chasm now filled by the Dead Sea, upraised the ridge called El Saté.

which enters the sea near the place of the same name, on the borders of Egypt. 'West of this basin other wadys run by themselves down to the sea. On the east of the same central basin is another similar and parallel one between it and the Arabah (the two being separated by the chain El-Ojmeh and its continuation), drained throughout by the Wady-el-Jeráfèh, which, having its head in or near the Tih, falls into the Arabah not far from El-Mukràh. North of this last basin the tract between the Arabah and the basin of the Arish is filled up by ranges or clusters of mountains, from which, on the east, short wadys run to the Arabah, and on the west longer ones to Wady-el-Arish, until, farther north, these latter continue by themselves to the sea near Gaza.'

This description of the formation of the northern desert will enable us to form a more distinct conception of the general features of the peninsula of Sinai, which lies south of it, being formed by the two arms of the Red Sea, the Gulfs of Akaba and Suez. If the parallel of the north coast of Egypt be extended eastward to the great Wady-el-Arabah, it appears that the desert, south of this parallel, rises gradually towards the south, until on the summit of the ridge Et-Tih, between the two gulfs, it attains, according to Russegger, the elevation of 4322 feet. The waters of all this great tract flow off northward either to the Mediterranean or the Dead Sea. The Tih forms a sort of offset, and along its southern base the surface sinks at once to the height of only about 3000 feet, forming the sandy plain which extends nearly across the peninsula. After this the mountains of the peninsula proper commence, and rise rapidly through the formations of sandstone, grüstein, porphyry, and granite, into the lofty masses of St. Catherine and Um Shauer, the former of which, according to Russegger, has an elevation of 8168 Paris feet, or nearly double that of the Tih. Here the waters all run eastward or westward to the Gulfs of Akaba and Suez.

The soil of the Sinaitic peninsula is in general very unproductive, yielding only palm-trees, acacias, tamarisks (from which exudes the gum called *mannâ*), coloquintida, and dwarfish, thorny shrubs. Among the animals may be mentioned the mountain-goat (the *beden* of the Arabs), gazelles, leopards, a kind of marmot called *vober*, the *sheeb*, supposed by Col. Hamilton Smith to be a species of wild wolf-dog, &c.: of birds there are eagles, partridges, pigeons, the *katta*, a species of quail, &c. There are serpents, as in ancient times (Num. xxi. 4, 6), and travellers speak of a large lizard called *dhob*, common in the desert, but of unusually frequent occurrence here. The peninsula is inhabited by Bedouin Arabs, and its entire population was estimated by Burckhardt at not more than 4000 souls.

Though this part of Arabia must ever be memorable as the scene of the journeying of the Israelites from Egypt to the Promised Land, yet very few of the spots mentioned in Scripture can now be identified; nor after the lapse of so many centuries ought that to be occasion of surprise. According to Niebuhr, Robinson, &c. they crossed the Red Sea near Suez, but the tradition of the country fixes the point of transit eight or ten miles south of Suez, opposite the place called Ayoun Mousa, i. e. the Fountains of Mœses, where Robinson recently found seven wells, some of

which, however, were mere excavations in the sand. About 15½ hours (33 geographical miles) south-east of that is the Well of Hawârah, the *Marah* of Scripture, whose bitter water is pronounced by the Arabs to be the worst in these regions. Two or three hours south of Hawârah the traveller comes to the Wady Ghûrûndel, supposed to be the *Elim* of Moses. From the plain of El-Kaa, which Robinson takes to be the desert of Sin (not to be confounded with that of *Zin*, which belonged to the great desert of Kadesh), they would enter the Sinaitic range probably along the upper part of Wady Feiran and through the Wady-esh-Sheikh, one of the principal valleys of the peninsula. The Arabs call this whole cluster of mountains *Jebel-et-Târ*; the Christians generally designate it as ‘*Sinai*,’ and give the name of *Horeb* to a particular mountain, whereas in Scripture the names are used interchangeably. To which of the lofty peaks Moses ascended that he might receive the Law and thence publish it to the people, can only be matter of conjecture. Tradition fixed on the *Jebel Mousa*, *i. e.* ‘the mountain of Moses,’ at the foot of which is the convent of Mount Sinai, and opposite to it stands Mount St. Catharine, which is a thousand feet higher, and has on that account by some been taken for the true Sinai. Professor Robinson is inclined to identify the venerated spot with the *Râs Es-Sufsâfeh*, the highest peak on the northern brow of Horeb, which ‘raises its bold and awful front in frowning majesty’ above the extensive plain of Er-Râhah, where there was ample room for the encampment of the ‘many thousands of Israel.’ Others have thought of the *Jebel Serbâl*, a magnificent mountain, nine or ten hours north-west of the convent, and supposed by Burckhardt to be the highest of all the peaks, but since ascertained by Rûppell to be 1700 feet lower than St. Catharine.

Having now taken a rapid survey of this extensive region in its three divisions, let us advert to the people by whom it was at first settled, and by whose descendants it is still inhabited. There is a prevalent notion that the Arabs, both of the south and north, are descended from Ishmael; and the passage in Gen. xvi. 12, ‘he (Ishmael) shall dwell in the presence of all his brethren,’ is often cited as if it were a prediction of that national independence which, upon the whole, the Arabs have maintained more than any other people. But this supposition (in so far as the true meaning of the text quoted is concerned) is founded on a misconception of the original Hebrew, which runs literally, ‘he shall dwell before the faces of all his brethren,’ *i. e.* (according to the idiom above explained, in which ‘before the face’ denotes the east), the habitation of his posterity shall be ‘to the east’ of the settlements of Abraham’s other descendants. This seems also to be the import of Gen. xxv. 18, where, in reference to Ishmael, it is said in our version, ‘he died in the presence of all his brethren;’ but the true sense is, ‘the lot of his inheritance fell to him before the faces (*i. e.* to the east) of all his brethren.’ These prophecies found their accomplishment in the fact of the sons of Ishmael being located, generally speaking, to the east of the other descendants of Abraham, whether by Sarah or by Keturah.

But the idea of the southern Arabs being of the posterity of Ishmael is entirely without foundation, and seems to have originated in the tradition invented by Arab vanity, that they, as well as the Jews, are of the seed of Abraham—a vanity which, besides disfiguring and falsifying the whole history of the patriarch and his son Ishmael, has transferred the scene of it from Palestine to Mecca. If we go to the most authentic source of ancient ethnography, the book of Genesis, we there find that the vast tracts of country known to us under the name of Arabia gradually became peopled by a variety of tribes of different lineage, though it is now impossible to determine the precise limits within which they fixed their permanent or nomadic abode. We shall here exhibit a tabular view of these races in chronological order, *i. e.* according to the successive æras of their respective progenitors:—

I. HAMITES, *i. e.* the posterity of *Cush*, Ham’s eldest son, whose descendants appear to have settled in the south of Arabia, and to have sent colonies across the Red Sea to the opposite coast of Africa; and hence *Cush* became a general name for ‘the south,’ and specially for Arabian and African Ethiopia. The sons of Cush (Gen. x. 7) were Seba, Havilah, Sabtah, Raamah or Ragma (his sons, Sheba and Dedan), and Sabtheca.

II. SHEMITES, including the following:

A. *Joktanites*, *i. e.* the descendants of *Joktan* (called by the Arabs *Kachtan*), the second son of Eber, Shem’s great-grandson (Gen. x. 25, 26). According to Arab tradition *Kachtan* (whom they also regard as a son of Eber), after the confusion of tongues and dispersion at Babel, settled in Yemen, where he reigned as king. Ptolemy speaks of an Arab tribe called *Katanites*, who may have derived their name from him; and the richest Bedouins of the southern plains are the *Kahtan* tribe on the frontiers of Yemen. *Joktan* had thirteen sons, some of whose names may be obscurely traced in the designations of certain districts in Arabia Felix. Their names were Almodad, Shaleph, Hhazarmaveth (preserved in the name of the province of Hhadramaut, the Hebrew and Arabic letters being the same), Jarach, Hadoram, Usal (believed by the Arabs to have been the founder of Sanaa in Yemen), Dikla, Obal, Abimael, Sheba (father of the Sabæans, whose chief town was Mariaba or Mareb; their queen Balkis supposed to be the queen who visited Solomon*), Ophir (who gave name to the district that became so famous for its gold), Havilah, and Jobab.

B. *Abrahamites*, divided into—

(a) *Hagarenes* or *Hagarites*, so called from Hagar the mother; or otherwise termed *Ishmaelites* from her son; and yet in course of time these names appear to have been applied to different tribes, for in Psalm lxxxiii. 6, the Hagarenes are

* The honour of being the country of the queen of Sheba is also claimed by Abyssinia; but if (as Bruce informs us) there was also a Saba in African Ethiopia, and if these opposite coasts of the Red Sea formed at times but one kingdom, the two opinions are not irreconcilable.

expressly distinguished from the Ishmaelites (comp. 1 Chron. v. 10, 19, 22, and the apocryphal book of Baruch i. 35; iii. 23). The twelve sons of Ishmael (Gen. xxv. 13-15), who gave names to separate tribes, were Nebaioth (the Nabathæans in Arabia Petræa), Kedar (the Kedarenes, sometimes also used as a designation of the Bedouins generally, and hence the Jewish rabbins call the Arabic language 'the *Kedarene*'), Abdeel, Mibsam, Mishma, Dumah, Massa, Hadad or Hadar, Thema, Jetur, Naphish (the Ituræans and Naphisæans near the tribe of Gad: 1 Chron. v. 19, 20), and Kedmah. They appear to have been for the most part located near to Palestine on the east and south-east.

(B) *Keturahites*, i. e. the descendants of Abraham and his concubine Keturah, by whom he had six sons (Gen. xxv. 2): Simram, Jokshan (who, like Raamah, son of Cush, was also the father of two sons, Sheba and Dedan), Medan, Midian, Jishbak, and Shuach. Among these, the posterity of *Midian* became the best known. Their principal seat appears to have been in the neighbourhood of the Moabites, but a branch of them must have settled in the peninsula of Sinai, for Jethro, the father-in-law of Moses, was a priest of Midian (Exod. iii. 1; xviii. 5; Num. x. 29). To the posterity of Shuach belonged Bildad, one of the friends of Job.

(γ) *Edomites*, i. e. the descendants of Esau, who possessed Mount Seir and the adjacent region, called from them Idumæa. They and the Nabathæans formed in later times a flourishing commercial state, the capital of which was the remarkable city called Petra.

C. *Nahorites*, the descendants of Nahor, Abraham's brother, who seem to have peopled the land of *Uz*, the country of *Job*, and of *Buz*, the country of his friend Elihu the *Buzite*, these being the names of Nahor's sons (Gen. xxii. 21).

D. *Lotites*, viz.:

(α) *Moabites*, who occupied the northern portion of Arabia Petræa, as above described; and their kinsmen, the—

(B) *Ammonites*, who lived north of them, in Arabia Deserta.

Besides these, the Bible mentions various other tribes who resided within the bounds of Arabia, but whose descent is unknown, e. g. the Amalekites, the Kenites, the Horites, the inhabitants of Maon, Hazor, Vedan, and Javan-Meusal (Ezek. xxvii. 19), where the English version has, 'Dan also and Javan going to and fro.'

In process of time some of these tribes were perhaps wholly extirpated (as seems to have been the case with the Amalekites), but the rest were more or less mingled together by inter-marriages, by military conquests, political revolutions, and other causes of which history has preserved no record; and thus amalgamated, they became known to the rest of the world as the 'ARABS,' a people whose physical and mental characteristics are very strongly and distinctly marked. In both respects they rank very high among the nations; so much so, that some have regarded them as furnishing the *prototype*—the primitive model form—the standard figure of the human species. This was the opinion of the famous Baron de Larrey, surgeon-general of

Napoleon's army in Egypt, who, in speaking of the Arabs on the east side of the Red Sea, says (in a *Memoir for the Use of the Scientific Commission to Algiers*, Paris, 1838) 'They have a physiognomy and character which are quite peculiar, and which distinguish them generally from all those which appear in other regions of the globe.' In his dissections he found 'their physical structure in all respects more perfect than that of Europeans; their organs of sense exquisitely acute; their size above the average of men in general; their figure robust and elegant (the colour brown); their intelligence proportionate to that physical perfection, and, without doubt, superior, other things being equal, to that of other nations.'

The inhabitants of Arabia have, from remote antiquity, been divided into two great classes, viz. the *townsmen* (including villagers), and the *men of the desert*, such being, as we remarked, the meaning of the word '*Bedawees*' or Bedouins, the designation given to the 'dwellers in the wilderness.' From the nature of their country, the latter are necessitated to lead the life of *nomades*, or wandering shepherds; and since the days of the patriarchs (who were themselves of that occupation) the extensive *steppes*, which form so large a portion of Arabia, have been traversed by a pastoral but warlike people, who, in their mode of life, their food, their dress, their dwellings, their manners, customs, and government, have always continued, and still continue, almost unalterably the same. They consist of a great many separate tribes, who are collected into different encampments dispersed through the territory which they claim as their own; and they move from one spot to another (commonly in the neighbourhood of pools or wells) as soon as the stunted pasture is exhausted by their cattle. It is only here and there that the ground is susceptible of cultivation, and the tillage of it is commonly left to peasants, who are often the vassals of the Bedawees, and whom (as well as all 'townsmen') they regard with contempt as an inferior race. Having constantly to shift their residence, they live in movable tents (comp. Isa. xiii. 20; Jer. xlix. 29), from which circumstance they received from the Greeks the name of *Σκηνίται*, i. e. dwellers in tents (Strabo, xvi. p. 747; Diod. Sic. p. 254; Ammian, Marcell. xxiii. 6). The tents are of an oblong figure, not more than six or eight feet high, twenty to thirty long, and ten broad; they are made of goat's or camel's hair, and are of a brown or black colour (such were the tents of Kedar, Cant. i. 5), differing in this respect from those of the Turcomans, which are white. Each tent is divided by a curtain or carpet into two apartments, one of which is appropriated to the women, who are not, however, subject to so much restraint and seclusion as among other Mohammedans. The tents are arranged in an irregular circle, the space within serving as a fold to the cattle at night. The heads of tribes are called *sheikhs*, a word of various import, but used in this case as a title of honour; the government is hereditary in the family of each sheikh, but elective as to the particular individual appointed. Their allegiance, however, consists more in following his example as a leader than in obeying his commands; and, if dissatisfied with his government,

they will depose or abandon him. As the independent lords of their own deserts, the Bedawees have from time immemorial demanded tribute or presents from all travellers or caravans (Isa. xxi. 13) passing through their country; the transition from which to robbery is so natural, that they attach to the latter no disgrace, plundering without mercy all who are unable to resist them, or who have not secured the protection of their tribe. Their watching for travellers 'in the ways,' i. e. the frequented routes through the desert, is alluded to Jer. iii. 2; Ezra viii. 31; and the fleetness of their horses in carrying them into the 'depths of the wilderness,' beyond the reach of their pursuers, seems what is referred to in Isa. lxiii. 13, 14. Their warlike incursions into more settled districts are often noticed (e. g. Job i. 15; 2 Chron. xxi. 16; xxvi. 7). The acuteness of their bodily senses is very remarkable, and is exemplified in their astonishing sagacity in tracing and distinguishing the footsteps of men and cattle, a faculty which is known by the name of *athr*. The law of *thar*, or blood-revenge, sows the seeds of perpetual feuds; and what was predicted (Gen. xvi. 12) of the posterity of Ishmael, the 'wild-ass man' (a term most graphically descriptive of a Bedawee), holds true of the whole people. Yet the very dread of the consequences of shedding blood prevents their frequent conflicts from being very sanguinary: they show bravery in repelling a public enemy, but when they fight for plunder, they behave like cowards. Their bodily frame is spare, but athletic and active, inured to fatigue and capable of undergoing great privations; their minds are acute and inquisitive; and though their manners are somewhat grave and formal, they are of a lively and social disposition. Of their moral virtues it is necessary to speak with caution. They were long held up as models of good faith, incorruptible integrity, and the most generous hospitality to strangers; but many recent travellers deny them the possession of these qualities; and it is certain that whatever they may have been once, the Bedawees, like all the unsophisticated 'children of nature,' have been much corrupted by the influx of foreigners, and the national character is in every point of view lowest where they are most exposed to the continual passage of strangers. It is, however, no part of our present design to enter on a more minute account of this singular and interesting people; information regarding many of their peculiarities which throw light on Scripture will be found under other heads. Let every one who wishes to study Arab life in the desert consult the romance of *Antar*, translated by Hamilton, and Burckhardt's *Notes on the Bedouins*; and with respect to the manners and customs of the more settled inhabitants, many curious details will be found in Lane's *Modern Egyptians*, and in the notes to his new Translation of the *Thousand and One Nights*; for since the downfall of the Arab empire of Bagdad, Cairo has been the chief of Arabian cities, and there Arab manners exist in their most refined form. The population of the entire peninsula of Arabia has been estimated at from eleven to twelve millions, but the data are precarious.

The principal source of the wealth of ancient Arabia was its commerce. So early as the days

of Jacob (Gen. xxxvii. 28) we read of a mixed caravan of Arab merchants (Ishmaelites and Midianites) who were engaged in the conveyance of various foreign articles to Egypt, and made no scruple to add Joseph, 'a slave,' to their other purchases. The Arabs were, doubtless, the first navigators of their own seas, and the great carriers of the produce of India, Abyssinia, and other remote countries to Western Asia and Egypt. Various Indian productions thus obtained were common among the Hebrews at an early period of their history (Exod. xxx. 23, 25). The traffic of the Red Sea was to Solomon a source of great profit; and the extensive commerce of *Sabaa* (Sheba, now Yemen) is mentioned by profane writers as well as alluded to in Scripture (1 Kings x. 10-15). In the description of the foreign trade of Tyre (Ezek. xxvii. 19-24) various Arab tribes are introduced (comp. Isa. lx. 6; Jer. vi. 20; 2 Chron. ix. 14). The Nabathæo-Idumæans became a great trading people, their capital being Petra. The transit-trade from India continued to enrich Arabia until the discovery of the passage to India by the Cape of Good Hope; but the invention of steam-navigation has now restored the ancient route for travellers by the Red Sea.

The settlers in Arabia are by native writers divided into two classes: the old tribes (who belonged to the fabulous period of history, and are long since extinct); and the present inhabitants. The latter are classed either among the 'pure or genuine,' or the *Mostarabi*, the mixed or naturalized Arabs. A 'pure' Arab boasts of being descended from Kachtan (the Joktan of Scripture, Gen. x. 29), and calls himself *al Arab al Araba*, 'an Arab of the Arabs,' a phrase of similar emphasis with St. Paul's 'Hebrew of the Hebrews' (Phil. iii. 5). The mixed Arabs are supposed to be descended from Ishmael by a daughter of Modad, king of Hedjaz, the district where the Ismaelites chiefly settled. The Kachtanites, on the other hand, occupied the southern part of the peninsula, for Kachtan's great-grandson Saba gave name to a kingdom, one of whose queens (called by the Arabians Balkis) visited Solomon (1 Kings x. 1). A son of Saba was Himyar, who gave name to the famous dynasty of the *Himyarites* (improperly written *Homerites*), that seem to have reigned for many centuries over Sabæa and part of Ihdramaut. In the latter province Lieut. Wellsted recently discovered ruins called Nakab-el-Hajar ('the excavation in the rock'), consisting of a massive wall, thirty to forty feet high, flanked with square towers. Within the entrance on the face of the building he found an inscription in characters eight inches long, which Gesenius supposes to be the ancient Himyaritic writing. Arabia, in ancient times, generally preserved its independence, unaffected by those great events which changed the destiny of the surrounding nations; and in the sixth century of our æra, the decline of the Roman empire and the corruptions and distractions of the Eastern church favoured the impulse given by a wild and warlike fanaticism. Mahomet arose, and succeeded in gathering around his standard the nomadic tribes of central Arabia; and in less than fifty years that standard waved triumphant 'from the straits of Gibraltar to the hitherto unconquered regions

beyond the Oxus.' The khalifs transferred the seat of government successively to Damascus, Kufa, and Bagdad; but amid the distractions of their foreign wars, the chiefs of the interior of Arabia gradually shook off their feeble allegiance, and resumed their ancient habits of independence, which, notwithstanding the revolutions that have since occurred, they for the most part retain. At present, indeed, the authority of Mehemet Ali, the Pasha of Egypt, is acknowledged over a great portion of the northern part of Arabia, while in the south the Imam of Maskat exercises dominion over a much greater extent of country than did any of his predecessors.—N. M.

ARABIC LANGUAGE. That important family of languages, of which the Arabic is the most cultivated and most widely-extended branch, has long wanted an appropriate common name. The term *Oriental* languages, which was exclusively applied to it from the time of Jerome down to the end of the last century, and which is even now not entirely abandoned, must always have been an unscientific one, inasmuch as the countries in which these languages prevailed are only the *east* in respect to Europe; and when Sanscrit, Chinese, and other idioms of the remoter East were brought within the reach of our research, it became palpably incorrect. Under a sense of this impropriety, Eichhorn was the first, as he says himself (*Allg. Bibl. Biblioth.* vi. 772), to introduce the name *Semitic* languages, which was soon generally adopted, and which is the most usual one at the present day. Nevertheless, Stange (in his *Theolog. Symmiktika*) justly objected to this name as violating the statements of the very Mosaic account (Gen. x.) on which the propriety of its use professed to be based. For, according to that genealogical table, some nations, which in all probability did not speak a language belonging to this family, are descended from Shem; and others, which did speak such a language, are derived from Ham. Thus 'Elam and Asshur are deduced from Shem (ver. 22); and the descendants of Cush in Arabia and Ethiopia, as well as all the Canaanites, from Ham (ver. 7, *sq.*). In modern times, however, the very appropriate designation *Syro-Arabian* languages has been proposed by Dr. Prichard, in his *Physical History of Man*. This term, besides being exempt from all the above-mentioned objections on the score either of latitude or inadequacy, has the advantage of forming an exact counterpart to the name by which the only other great family of languages with which we are likely to bring the Syro-Arabian into relations of contrast or accordance, is now universally known—the *Indo-Germanic*. Like it, by taking up only the two extreme members of a whole sisterhood according to their geographical position when in their native seats, it embraces all the intermediate branches under a common band; and, like it, it constitutes a name which is not only at once intelligible, but one which in itself conveys a notion of that affinity between the sister dialects, which it is one of the objects of comparative philology to demonstrate and to apply.

Of this family, then, the Arabic forms, together with the Ethiopic, the southern branch. In it we find the full and adult development of the genius of the Syro-Arabian languages. In the

abundance of its roots, in the manifold variety of its formations, in the syntactical delicacies of its construction, it stands pre-eminent as a language among all its sisters. Every class of composition also: the wild and yet noble lyrics of the son of the desert, who had 'nothing to glory in but his sword, his guest, and his fervid tongue;' the impassioned and often sublime appeals of the Qurân; the sentimental poetry of a Mutanabbi; the artless simplicity of their usual narrative style, and the philosophic disquisition of an Ibn Chaldûn; the subtleties of the grammarian and scholiast; medicine, natural history, and the metaphysical speculations of the Aristotelian school—all have found the Arabic language a fitting exponent of their feeling and thought. And, although confined within the bounds of the Peninsula by circumstances to which we owe the preservation of its pure antique form, yet Islam made it the written and spoken language of the whole of Western Asia, of Eastern and Northern Africa, of Spain, and of some of the islands of the Mediterranean; and the ecclesiastical language of Persia, Turkey, and all other lands which receive the Mohammedan faith; in all which places it has left sensible traces of its former occupancy, and in many of which it is still the living or the learned idiom. Such is the Arabic language; so important its relations to the literary and civil history of a large portion of the human race: the more important also to us as bridging over that wide chasm which intervenes between the extinction of classical literature and the revival of that spirit to which the literature of all modern languages owes its origin. Into these general views of the Arabic language, however, it is not the province of this work to enter: an able article in the *Penny Cyclopædia*, by the late lamented Dr. Rosen, will satisfy those who desire such information. Our object here is to show the mode and the importance of its bearings upon Biblical philology.

The close affinity, and consequently the incalculable philological use, of the Arabic with regard to the Hebrew language and its other sisters, may be considered partly as a question of theory, and partly as one of fact. The former would regard the concurrent records which the Old Testament and their own traditions have preserved of the several links by which the Arabs were connected with different generations of the Hebrew line, and the evidences which Scripture offers of persons speaking Arabic being intelligible to the Hebrews; the latter would observe the demonstrable identity between them in the main features of a language, and the more subtle, but no less convincing traces of resemblance even in the points in which their diversity is most apparent.

The following are the theoretical grounds:—first, the Arabs of Jemen are derived from Qahtân, the Joktan of Gen. x. 25, whom the Arabs make the son of 'Eber (Pococke's *Specimen Hist. Arab.* p. 39, *sq.*). These form the *pure* Arabs. Then Ishmael intermarried with a descendant of the line of Qahtân, and became the progenitor of the tribes of Hig'âz. These are the *insidious* Arabs. These two roots of the nation correspond with the two great dialects into which the language was once divided: that of Jemen, under the name of the Himjarite, of which all

that has come down to us (except what may have been preserved in the Ethiopic) is a few inscriptions; and that of Hig'áz, under that of the dialect of Mudhar, or, descending a few generations in the same line, of Quraish—the dialect of the Qurán and of all their literature. Then, Abraham sent away his sons by Keturah, and they also became the founders of Arabic tribes. Lastly, the circumstance of Esau's settling in Mount Seir, where the Idumæans descended from his loins, may be considered as a still later medium by which the idioms of Palestine and Arabia preserved their harmony. Secondly, Olaus Celsius (in his *Hist. Ling. et Erudit. Arab.*) cites the fact of the sons of Jacob conversing with the Ishmaelite caravan (Gen. xxxvii. 28), and that of Moses with his father-in-law the Midianite (Exod. iv. 18). To these, however, Schelling (in his *Abhandl. v. d. Gebrauch der Arab. Sprache*, p. 14) objects that they are not conclusive, as the Ishmaelites, being merchants, might have acquired the idiom of the nations they traded with, and as Moses might owe an acquaintance with Arabic to his residence in Egypt. Nevertheless, one of Celsius's inferences derives considerable probability from the only instance of mutual intelligibility which J. D. Michaelis has adduced (in his *Beurtheilung der Mittel die ausgestorbene Hebr. Sprache zu verstehen*, p. 156), namely, that Gideon and his servant went down by night to the camp of 'Midian, Amalek, and all the Bene Qedem,' to overhear their conversation with each other, and understood what they heard (Judg. viii. 9-14). Lastly, Schultens (*Oratio de Reg. Sabæor.*, in his *Opp. Minora*) labours to show that the visit of the queen of Sheba to Solomon is a strong proof of the degree of proximity in which the two dialects then stood to each other. These late traces of resemblance, moreover, are rendered more striking by the notice of the early diversity between Hebrew and Aramaic (Gen. xxxi. 47). The instance of the Ethiopian chamberlain in Acts viii. 28, may not be considered an evidence, if Heinrichs, in his note ad loc. in *Nov. Test. edit. Kopp.*, is right in asserting that he was reading the Septuagint version, and that Philip the deacon was a Hellenist.

Thus springing from the same root as the Hebrew, and possessing such traces of affinity to so late a period as the time of Solomon, this dialect was further enabled, by several circumstances in the social state of the nation, to retain its native resemblance of type until the date of the earliest extant written documents. These circumstances were, the almost insular position of the country, which prevented conquest or commerce from debasing the language of its inhabitants; the fact that so large a portion of the nation adhered to a mode of life in which every impression was, as it were, stereotyped, and knew no variation for ages (a cause to which we may also in part ascribe the comparatively unimportant changes which the language has undergone during the 1400 years in which we can follow its history); and the great and just pride which they felt in the purity of their language, which, according to a valuable testimony of Burckhardt, a competent judge of the learned as well as the living idiom, is still a characteristic of the Bedouins (*Notes on the Bedouins*, p. 211).

These causes preserved the language from foreign influences at a time when, as the Qurán and a national literature had not yet given it its full stature, such influences would have been most able to destroy its integrity. During this interval, nevertheless, the language received a peculiarly ample development in a certain direction. The limited incidents of a desert life still allowed valour, love, generosity, and satire to occupy the keen sensibilities of the chivalrous Bedouin. These feelings found their vent in ready verse and eloquent prose; and thus, when Islam first called the Arabs into the more varied activity and more perilous collision with foreign nations, which resulted from the union of their tribes under a common interest to hold the same faith and to propagate it by the sword, the language had already received all the development which it could derive from the pre-eminently creative and refining impulses of poetry and eloquence.

However great may be the amount of resemblance between Arabic and Hebrew which a due estimate of all the theoretical grounds for the affinity, and for the diversity, between them would entitle us to assume, it is certain that a comparison of the actual state of both in their purest form evinces a degree of proximity which exceeds expectation. Not only may two-thirds of the Hebrew roots (to take the assertion of Anri-villius, in his *Dissertationes*, p. 11, ed. J. D. Michaelis) be found in Arabic under the same letters, and either in the same or a very kindred sense, provided we know that the last radical of the ה roots in Hebrew is *Waw* or *Ja* in Arabic; and that those whose first radical is *Jod* in Hebrew is *Waw* in Arabic; and that the letters

ט טע ת תע correspond to **ط** **طع**, and that

either when the latter have a diacritical point or not; but, if we allow for the changes of י into **ي**, ו into **و**, and **י** into **י**, **ו** into **و**,

ש into **ش**, ז into **ظ**, and **ז** into **س**

and **ש**, we shall be able to discover nearly

nine-tenths of the Hebrew roots in Arabic. To this great fundamental agreement in the vocabulary (the wonder of which is somewhat diminished by a right estimate of the immense disproportion between the two languages as to the number of roots) are to be added those resemblances which relate to the mode of inflexion and construction. Thus, in the verb, its two wide tenses, the mode by which the persons are denoted at the end in the Perfect, and at the beginning (with the accessory distinctions at the end) in the Imperfect, its capability of expressing the gender in the second and third persons, and the system on which the conjugations are formed; and in the noun, the correspondence in formations, in the use of the two genders, and in all the essential characteristics of construction; the possession of the definite article; the independent and affixed pronouns; and the same system of separable and attached particles—all these form so broad a basis of community and harmony between the two dialects, as could hardly be anticipated, when we consider the many centuries which separate the earliest written extant documents of each.

The diversities between them, which consist

almost entirely of fuller developments on the side of the Arabic, may be summed up under the following heads:—A much more extensive system of conjugations in the verb, the dual in both tenses, and four forms of the Imperfect (three of which, however, exist potentially in the ordinary imperfect, the jussive, and the cohortative of the Hebrew: see Ewald's *Hebr. Gram.* § 290, 293); the full series of infinitives; the use of auxiliary verbs; in the noun, the formations of the plural called *broken* or *internal* plurals, and the flexion by means of terminations analogous to three of our cases; and a perfectly defused system of metre. The most important of these differences consists in that final vowel after the last radical, by which some of the forms of the imperfect and the several cases in the noun are indicated; and it is a matter of some moment to determine whether they are to be ascribed to the genuine natural expansion of the language, or are only an attempt of the grammarians to introduce Greek inflexions into Arabic. The latter opinion has been seriously propounded by Hasse, in a paper in his *Magazin für Biblisch-Orientalische Litteratur*, i. 230; and even Ge-ni-us has expressed himself to the same effect (*Gesch. d. Hebr. Spr.* p. 95). Nevertheless, the notion springs from a forgetfulness of the fact that the date of the early poems, the *Hamasa* and the *Mu'allaqât*, is much anterior to the period when any such foreign influence as Hasse alludes to could have had effect; and from an ignorance of the absolute necessity of all those flexional vowels to preserve the *metre* of the poetry. If any productions of Arabic genius are old—if any are national in the highest sense, both as to substance and form, it is those poems. And so essential a part of their form is the metre according to which they were conceived, that it is incontestable that their metrical disposition and their existence are coeval. When Hasse, then, 'candidly admits that these terminations of case were in use as early as the second century of the Hig'ra,' he merely admits his ignorance of the fact that the earliest remains of Arabic literature, those which are older by centuries than the *Qurân*, are composed in a form which is unintelligible unless read according to the nicest distinctions of this vocalization of the final syllables. This error is, moreover, akin to a not uncommon statement, that Al Chalil, who lived in the second century of the Hig'ra (Freytag's *Darstellung d. Arab. Verskunst*, p. 18), invented the art of Prosody: which is as true as that Aristotle invented the art of Poetry, merely because he abstracted the laws of composition from the masterpieces of Greek genius.

The Arabic alphabet also presents some remarkable differences. As a representation of sounds, it contains all the Hebrew letters; but in consequence of the greater extent of the nation as a source of dialectal varieties of pronunciation, and also in consequence of the more developed and refined state of the language, the value of some of them is not exactly the same, and the characters that correspond to ח ח צ ט are used in a double capacity, and represent both halves of those sounds which exist unseparated in the Hebrew. The present order of the letters also is different, although there are evidences in their numerical value, when so used, and in the memorial words given in Ewald's *Grammatica Cri-*

tica Ling. Arab. § 67, that the arrangement was once the same in both. In a palæographical point of view, the characters have undergone many changes. The earliest form was that in the Himjarite alphabet. The first specimens of this character (which Arabic writers call *al Musnad*, i. e. *stilted*, *columnar*) were given by Seetzen in the *Fundgruben des Orients*. Since then Professor Rödiger has produced others, and illustrated them in a valuable paper in the *Zeitschrift für die Kunde des Morgenlandes*, i. 332. The letters of this alphabet have a striking resemblance to those of the Ethiopic, which were derived from them. In Northern Arabia, on the other hand, and not very long before the time of Muhammad, the Syrian character called *Estrangelo* became the model on which the Arabic alphabet called the *Kufic* was formed. This heavy, angular Kufic character was the one in which the early copies of the *Qurân* were written; and it is also found in the ancient Muhammadan coinage as late as the seventh century of the Hig'ra. From this, at length, was derived the light, neat character called *Nischi*, the one in which the Arabs continue to write at the present day, and which we have endeavoured to represent in our printed books. The introduction of this character is ascribed to Ibn Muqla, who died in the year 327 of the Hig'ra. (See the table given in the article ALPHABET.) Lastly, it is worthy of notice that all the letters of the Arabic alphabet are only consonants; that, in an unpointed text, the *long* vowels are denoted by the use of Alif, Waw, and Ja, as *matres lectionis*; and that the *short* vowels are not denoted at all, but are left to be supplied according to the *sense* in which the reader takes the words; whereas, in a pointed text, *three* points only suffice to represent the whole vocalization; the equivalents to which, according to the way in which they are expressed in this work, are *a, i, u*, pronounced as in Italian.

The manifold uses of the Arabic language in Biblical philology (exclusive of the advantages it affords for comparing the Arabic versions) may in part be gathered from the degree of its affinity to the Hebrew; and, indeed, chiefly to the Hebrew before the exile, after which period the Aramaic is the most fruitful means of illustration (Mahn, *Darstellung der Lexicographie*, p. 391). But there are some peculiarities in the relative position of the two dialects which considerably enhance the value of the aid to be derived from the Arabic. The Hebrew language of the Old Testament has preserved to us but a small fragment of a literature. In the limited number of its roots (some of which even do not occur in the primary sense), in the rarity of some formations, and in the antique rudimentary mode in which some of its constructions are denoted, are contained those difficulties which cannot receive any other illustration than that which the sister dialects, and most especially the Arabic, afford. For this purpose, the resemblances between them are as useful as the diversities. The former enable us to feel certain on points which were liable to doubt: they confirm and establish an intelligent conviction that the larger portion of our knowledge of the meaning of words, and of the force of constructions in Hebrew, is on a sure foundation; because we recognise the same in a kindred form, and in a literature so voluminous as to afford us frequent opportunities of

festing our notions by every variety of experience. The diversities, on the other hand (according to a mode of observation very frequent in comparative anatomy), show us what exists potentially in the rudimentary state, by enabling us to see how a language of the same genius has, in the further progress of its development, felt the necessity of denoting externally those relations of formation and construction which were only dimly perceived in its antique and uncultivated form. Thus, to adduce a single illustration from the Arabic cases in the noun:—The precise relation of the words *mouth* and *life*, in the common Hebrew phrases, 'I call my mouth,' and 'he smote him his life' (Ewald's *Hebr. Gram.* § 482), is easily intelligible to one whom Arabic has familiarised with the perpetual use of the so-called accusative to denote the accessory descriptions of *state*. Another important advantage to be derived from the study of Arabic, is the opportunity of seeing the grammar of a Syro-Arabian language explained by native scholars. Hebrew grammar has suffered much injury from the mistaken notions of men, who, understanding the *sense* of the written documents by the aid of the versions, have been exempted from obtaining any independent and inward feeling of the genius of the language, and have therefore not hesitated to accommodate it to the grammar of our Indo-Germanic idioms. In Arabic, however, we have a language, every branch of the philosophical study of which has been successfully cultivated by the Arabs themselves. Their own lexicographers, grammarians, and scholiasts (to whom the Jews also are indebted for teaching them the grammatical treatment of Hebrew) have placed the language before us with such elaborate explanation of its entire character, that Arabic is not only by far the most accessible of the Syro-Arabian dialects, but may even challenge comparison, as to the possession of these advantages, with the Greek itself.—J. N.

ARABIC VERSIONS. As Christianity never attained any extensive or permanent influence among the Arabs as a nation, no entire nor publicly sanctioned Arabic version of the Bible has been discovered. But, as political events at length made the Arabic language the common vehicle of instruction in the East, and that to Jews, Samaritans, and Christians, independent versions of single books were often undertaken, according to the zeal of private persons, or the interests of small communities. The following is a classified list of only the most important among them:—

I. Arabic versions formed immediately on the original texts.

A. Rabbi Saadjah Haggaön, a native of Faijûm, and rector of the academy at Sora, who died A.D. 942, is the author of a version of some portions of the Old Testament. Erpenius and Pocock, indeed, affirm that he translated the whole (Walton's *Prolegomena*, ed. Wrangham, ii. 546); but subsequent inquirers have not hitherto been able, with any certainty, to assign to him more than a version of the Pentateuch, of Isaiah, of Job, and of a portion of Hosea.

That of the Pentateuch first appeared, in Hebrew characters, in the folio Tetraglott Pentateuch of Constantinople, in the year 1546. The exact title of this exceedingly rare book is not

given by Wolf, by Masch, nor by De Rossi (it is said to be found in Adler's *Biblich-kritische Reise*, p. 221); but, according to the title of it which O. G. Tychsen cites from Rabbi Shabtai (in Eichhorn's *Repertorium*, x. 96), Saadjah's name is expressly mentioned there as the author of that Arabic version. Nearly a century later an Arabic version of the Pentateuch was printed in the Polyglott of Paris, from a MS. belonging to F. Savary de Breves; and the text thus obtained was then reprinted in the London Polyglott, with a collection of the various readings of the Constantinopolitan text, and of another MS. in the appendix. For it was admitted that Saadjah was the author of the Constantinopolitan version; and the identity of that text with that of the Paris Polyglott was maintained by Pocock (who nevertheless acknowledged frequent interpolations in the latter), and had been confirmed even by the collation which J. H. Hottinger had instituted to establish their diversity. The identity of all these texts was thus considered a settled point, and long remained so, until J. D. Michaelis published (in his *Orient. Bibl.*, ix. 155, sq.) a copy of a Latin note which Jos. Ascarri had prefixed to the very MS. of De Breves, from which the Paris Polyglott had derived its Arabic version. That note ascribed the version to 'Saidus Fajumensis, Monachus Coptites; and thus Saadjah's claim to be considered the author of the version in the Polyglotts was again liable to question. At length, however, Schmurrer (in his *Disertat. de Pentat. Arab. Polygl.* in his *Dissert. Philologico-critica*) printed the Arabic preface of that MS., proved that there was no foundation for the 'Monachus Coptites,' and endeavoured to show that Sa'id was the Arabic equivalent to the Hebrew Sa'adjah, and to re-establish the ancient opinion of the identity of the two texts. The results which he obtained appear (with the exception of a feeble attempt of O. G. Tychsen to ascribe the version to *Abu Sa'id*, in the *Repertorium*) to have convinced most modern critics; and indeed they have received much confirmation by the appearance of the version of Isaiah. This version of the Pentateuch, which is an honourable monument of the Rabbinical Biblical philology of the tenth century, possesses, in the independence of its tone, and in some peculiarities of interpretation, the marks of having been formed on the original text. It leans, of course, to Jewish exegetical authorities generally; but often follows the Sept., and as often appears to express views peculiar to its author. Carpov has given numerous examples of its mode of interpretation in his *Crit. Sacr.* p. 646, sq. It is also marked by a certain loose and paraphrastic style of rendering, which makes it more useful in an exegetical than in a critical point of view. It is difficult, however, to determine how much of this diffuseness is due to Saadjah himself. For, not only is the printed text of his version more faulty, in this respect, than a Florentine MS., some of the readings of which Adler has given in Eichhorn's *Einleit. ins A. T.*, ii. 245; but it has suffered a systematic interpolation. A comparison of the Constantinopolitan text with that of the Polyglotts shows that where the former retains those terms of the Hebrew in which action or passion is ascribed to God—the so-called *ἀνθρωποπάθειαι*—the latter has the 'Ange' of God,' or some other

mode of evading direct expressions. These interpolations are ascribed by Eichhorn to a Samaritan source; for Morinus and Hottinger assert that the custom of omitting or evading the anthropomorphisms of the Hebrew text is a characteristic of the Samaritan versions.

A version of Isaiah, which in the original MS. is ascribed to Saadjah, with several extrinsic evidences of truth, and without the opposition of a single critic, appeared under the title, *R. Saadia Phijumensis Versio Jesaia Arabica e MS. Bodley. edidit atque Glossar. instruxit, H. E. G. Paulus, fasc. ii., Jena, 1791, 8vo.* The text was copied from a MS. written in Hebrew characters, and the difficulty of always discovering the equivalent Arabic letters into which it was to be transposed, has been one source of the inaccuracies observable in the work. Gesenius (in his *Jesaias*, i. 88, sq.) has given a summary view of the characteristics of this version, and has shown the great general agreement between them and those of the version of the Pentateuch, in a manner altogether confirmatory of the belief in the identity of the authors of both.

His version of Job exists in MS. at Oxford, where Gesenius took a copy of it (*Jesaias*, p. x.).

That of Hosea is only known from the citation of ch. vi. 9, by Kimchi (Pococke's *Theolog. Works*, ii. 280).

B. The version of Joshua which is printed in the Paris and London Polyglotts, the author and date of which are unknown.

C. The version of the whole passage from 1 Kings xii. to 2 Kings xii. 16, inclusive, which is also found in the same Polyglotts. Professor Rödiger has collected the critical evidences which prove that this whole interval is translated from the Hebrew; and ascribes the version to an unknown Damascene Jew of the eleventh century. Likewise, the passage in Nehemiah, from i. to ix. 27, inclusive, as it exists in both Polyglotts, which he asserts to be the translation of a Jew (resembling that of Joshua in style), but with subsequent interpolations by a Syrian Christian. (See his work *De Origine Arabice Libror. V. T. Histor. Interpretationis*, Halle, 4to.)

D. The very close and almost slavish version of the Pentateuch, by some Mauritanian Jew of the thirteenth century, which Erpenius published at Leyden in 1622—the so-called *Arabs Erpenii*.

E. The Samaritan Arabic version of Abu Sa'ïd. According to the author's preface affixed to the Paris MS. of this version (No. 4), the original of which is given in Eichhorn's *Bibl. Biblioth.* iii. 6, Abu Sa'ïd was induced to undertake it, partly by seeing the corrupt state to which ignorant copyists had reduced the version then used by the Samaritans, and partly by discovering that the version which they used, under the belief that it was that of Abu'l Hasan of Tyre, was in reality none other than that of Saadjah Haggâôn. His national prejudice being thus excited against an accursed Jew, and the 'manifest impiety' of some of his interpretations, he applied himself to this translation, and accompanied it with notes in order to justify his renderings, to explain difficulties, and to dispute with the Jews. His version is characterized by extreme fidelity to the Samaritan text (i. e. in other words, to the Hebrew text with the differences which distinguish the Samaritan recension of it),

retaining even the order of the words, and often sacrificing the proprieties of the Arabic idiom to the preservation of the very terms of the original. It is certainly not formed on the Samaritan version, although it sometimes agrees with it; and it has such a resemblance to the version of Saadjah as implies familiarity with it, or a designed use of its assistance; and it exceeds both these in the constant avoidance of all anthropomorphic expressions. Its date is unknown, but it must have been executed between the tenth and thirteenth centuries, because it was necessarily posterior to Saadjah's version, and because the Barberini copy of it was written A. D. 1227. It is to be regretted that this version, although it would be chiefly available in determining the readings of the Samaritan Pentateuch, is still unpublished. It exists in MS. at Oxford (one of the copies there being the one cited by Castell in the Appendix to the London Polyglott), at Paris, Leyden, and at Rome, in the celebrated Barberini Triglott (the best description of which is in De Rossi's *Specimen Var. Lect. et Chald. Estheris Additamenta*, Tübingen, 1783). Portions only have been printed: the earliest by J. H. Hottinger, in his *Promptuarium*, p. 98; and the two longest by De Sacy, with an interesting dissertation, in Eichhorn's *Bibl. Biblioth.* x., and by Van Vloten, in his *Specim. Philolog. continens descript. cod. MS. Biblioth. Lugd.-Bat. Partemque Vers. Sam. Arab. Pentat.*, Leidæ, 1803.

F. A version of the Gospels, which was first printed at Rome in 1590, then in the Arabic New Testament of Erpenius in 1616, and afterwards in the Paris Polyglott (the text of which last is the one copied in that of London). The first two of these editions are derived from MSS., and the variations which distinguish the text of Paris from that of Rome are also supposed to have been obtained from a MS. The agreement and the diversity of all these texts are equally remarkable. The agreement is so great as to prove that they all represent only one and the same version, and that one based immediately on the Greek. The diversities (exclusive of errors of copyists) consist in the irregular changes which have been made in every one of these MSS., separately, to adapt it indiscriminately to the Peshito or Coptic versions. This surprising amalgamation is thus accounted for by Hug: When the prevalence of the Arabic language had rendered the Syriac and Coptic obsolete, the Syrians and Copts were obliged to use an Arabic version. They therefore took some translation in that language, but first adapted it to the Peshito and Memphitic versions respectively. As the Peshito and Coptic versions still continued to be read first in their churches, and the Arabic translation immediately afterwards, as a kind of Targum, it became usual to write their national versions and this amended Arabic version in parallel columns. This mere juxtaposition led to a further adulteration in each case. Afterwards, two of these MSS. which had thus suffered different adaptations, were brought together by some means, and mutually corrupted each other—by which a third text, the hybrid one of our Arabic version, was produced. The age of the original Arabic text is uncertain; but the circumstance of its adoption by the Syrians and Copts places it near the seventh century (Bertholdt's *Einleit.* i. 692, sq.).

G. The version of the Acts, of the Epistles of Paul, of the Catholic Epistles, and of the Apocalypse, which is found in both the Polyglotts. The author is unknown, but he is supposed to have been a native of Cyrene, and the date to be the eighth or ninth century (Bertholdt, *ibid.*).

II. Arabic versions founded on the LXX.

A. The Polyglott version of the Prophets, which is expressly said in the inscription in the Paris MS. to have been made from the Greek by an Alexandrian priest. Its date is probably later than the tenth century.

B. That of the Psalms (according to the Syrian recension) which is printed in Justiniani's *Psalt. Octaphum*. Genoa, 1516, and in *Liber. Psalmar. a Gabr. Sionita et Vict. Scialac*. Rome, 1614.

C. That version of the Psalms which is in use by the Malkites, or Orthodox Oriental Christians, made by 'Abdallah ben al Fadhil, before the twelfth century. It has been printed at Aleppo in 1706, in London in 1725, and elsewhere.

D. The version of the Psalms (according to the Egyptian recension) which is found in both the Polyglotts.

III. Arabic versions formed on the Peshito.

A. The Polyglott version of Job, of Chronicles, and (according to Rödiger, who ascribes them to Christian translators in the thirteenth and fourteenth centuries) that of Judges, Ruth, Samuel, 1 Kings i. to xi., and 2 Kings xii. 17, to xxv.

B. The version of the Psalms printed at Qashaia, near Mount Lebanon, in 1610. (The *Eindeitungen* of Eichhorn, Bertholdt, and De Wette contain ample researches, or references, for the further investigation of this extensive subject.)—J. N.

ARAD, an ancient city on the southernmost borders of Palestine, whose inhabitants drove back the Israelites as they attempted to penetrate from Kadesh into Canaan (Num. xxi. 1, where the Auth. Vers. has 'King Arad,' instead of 'King of Arad'), but were eventually subdued by Joshua, along with the other southern Canaanites (Josh. xii. 14, comp. x. 41; also Judg. i. 16). Eusebius and Jerome place Arad twenty Roman miles from Hebron, which would be equal to about eight hours with camels. This accords well with the situation of a hill called Tell 'Arad, which Dr. Robinson observed on the road from Petra to Hebron. He describes it as 'a barren-looking eminence rising above the country around.' He did not examine the spot, but the Arabs said there were no ruins upon or near it, but only a cavern. The name alone is, however, too decisive to admit a doubt that the hill marks the site of the ancient Arad.

ARADUS. [ARVAD.]

ARAM (אֲרָם, probably from אָר, *high*, *q. d.* the Highlands') was the name given by the Hebrews to the tract of country lying between Phenicia on the west, Palestine on the south, Arabia Deserta and the river Tigris on the east, and the mountain-range of Taurus on the north. Many parts of this extensive territory have a much lower level than Palestine, but it might receive the designation of 'highlands,' because it does rise to a greater elevation than that country at most points of immediate contact, and especially on the side of Lebanon. Aram, or Aramæa,

seems to have corresponded generally to the *Syria* and *Mesopotamia* of the Greeks and Romans (see those articles). We find the following divisions expressly noticed in Scripture:—1. ARAM-DAMESK, אֲרָם דַּמֶּשֶׂק, the 'Syria of Damascus' conquered by David, 2 Sam. viii. 5, 6, where it denotes only the territory around Damascus; but elsewhere 'Aram,' in connection with its capital 'Damascus,' appears to be used in a wider sense for Syria Proper (Isa. vii. 1, 8; xvii. 3; Amos i. 5). At a later period Damascus gave name to a district, the *Syria Damascena* of Pliny (v. 13). To this part of Aram the 'land of Hadrach' seems to have belonged (Zech. ix. 1). 2. ARAM-MAACHAH, אֲרָם מַעַכָּה (1 Chron. xix. 6), or simply *Maachah* (2 Sam. x. 6, 8), which, if formed from מָעַךְ, to 'press together,' would describe a country enclosed and hemmed in by mountains, in contradistinction to the next division, 'Aram-beth-Rechob,' *i. e.* Syria the wide or broad, בֵּית being used in Syriac for a 'district of country.' Aram-Maachah was not far from the northern border of the Israelites on the east of the Jordan (comp. Deut. iii. 14, with Josh. xiii. 11, 13). In 2 Sam. x. 6, the text has 'king Maachah,' but it is to be corrected from the parallel passage in 1 Chron. xix. 7, 'king of Maachah.' 3. ARAM-BETH-RECHOB, אֲרָם בֵּית רַחֲבֹה, the meaning of which may be that given above, but the precise locality cannot with certainty be determined. Some connect it with the Beth-rehob of Judg. xviii. 28, which Rosenmüller identifies with the Rehob of Num. xiii. 21, situated 'as men come to Hamath,' and supposes the district to be that now known as the *Ardh-el-Ihule* at the foot of Anti-Libanus, near the sources of the Jordan. A place called Rehob is also mentioned in Judg. i. 31; Josh. xix. 28, 30; xxi. 31; but it is doubtful if it be the same. Michaelis thinks of the Rechoboth-ha-Nahar (lit. *streets*, *i. e.* the village or town on the river Euphrates) of Gen. xxxvi. 37; but still more improbable is the idea of Bellermand and Jahn that Aram-beth-Rechob was beyond the Tigris in Assyria. 4. ARAM-ZOBAN, אֲרָם צוּבָה, or, in the Syriac form, אֲרָם צוּבָה (2 Sam. x. 6). Jewish tradition has placed Zobah at Aleppo (see the *Itinerary* of Benjamin of Tudela), whereas Syrian tradition identifies it with Nisibis, a city in the north-east of Mesopotamia. Though the latter opinion long obtained currency under the authority of Michaelis (in his *Dissert. de Syria Sobæa*, to be found in the *Comment. Soc. Gotting.* 1769), yet the former seems a much nearer approximation to the truth. We may gather from 2 Sam. viii. 3, x. 16, that the eastern boundary of Aram-Zobah was the Euphrates, but Nisibis was far beyond that river; besides that in the title of the sixtieth Psalm (supposing it genuine) Aram-Zobah is clearly distinguished from Aram-Naharaim, or Mesopotamia. It is true, indeed, that in 2 Sam. x. 16, it is said that Hadarezer, king of Zobah, brought against David 'Aramites from beyond the river;' but these were auxiliaries, and not his own subjects. The people of Zobah are uniformly spoken of as near neighbours of the Israelites, the Damascenes, and other Syrians; and in one place (2 Chron. viii. 3) Hamath is called Hamath-Zobah, as pertaining to that district. We, therefore, conclude that Aram-Zobah extended from the Euphrates west-

ward, perhaps as far north as to Aleppo. It was long the most powerful of the petty kingdoms of Aramæa, its princes commonly bearing the name of Hadadezer or Hadarezer. 5. ARAM-NAHARAIM, אַרְמֵי נַהֲרַיִם, i. e. *Aram of the Two Rivers*, called in Syriac 'Beth-Nahrin,' i. e. 'the land of the rivers,' following the analogy by which the Greeks formed the name *Μεσοποταμία*, 'the country between the rivers.' For that Mesopotamia is here designated is admitted universally, with the exception only of Mr. Tilston Beke, who, in his *Origines Biblicæ*, among many other paradoxical notions, maintains that 'Aram-Naharaim' is the territory of Damascus. The rivers which enclose Mesopotamia are the Euphrates on the west and the Tigris on the east; but it is doubtful whether the Aram-Naharaim of Scripture embraces the whole of that tract or only the northern portion of it (comp. Gen. xxiv. 10; Deut. xxiii. 4; Judg. iii. 8). A part of this region of Aram is also called *Padan-Aram*, פְּדַן אֲרָם, the plain of Aram (Gen. xxv. 20; xxviii. 2, 6, 7; xxxi. 18; xxxiii. 18), and once simply *Padan* (Gen. xlviii. 7), also *Sedeh-Aram*, שֵׁדֵי אֲרָם, the field of Aram (Hos. xii. 13), whence the 'Campi Mesopotamiæ' of Quintus Curtius (iii. 2. 3; iii. 8. 1; iv. 9. 6). But that the whole of Aram-Naharaim did not belong to the flat country of Mesopotamia appears from the circumstance that Balaam, who (Deut. xxiii. 4) is called a native of Aram-Naharaim, says (Numb. xxiii. 7) that he was brought 'from Aram, out of the mountains of the east.' The Septuagint, in some of these places, has *Μεσοποταμία Συρίας*, and in others *Συρία Παρθίων*, which the Latins rendered by Syria Interamna.

But though the districts now enumerated be the only ones expressly named in the Bible as belonging to Aram, there is no doubt that many more territories were included in that extensive region, e. g. Geshur, Hul, Arpad, Riblah, Tadmor, Hauran, Abilene, &c., though some of them may have formed part of the divisions already specified. A native of Aram was called אַרְמֵי אַרְמֵי, an Aramæan, used of a Syrian (2 Kings v. 20), and of a Mesopotamian (Gen. xxv. 20). The feminine was *Aramiah*, an Aramitess (1 Chron. vii. 14), and the plural *Aramim* (2 Kings viii. 29). It appears from the ethnographic table in the tenth chapter of Genesis (vers. 22, 23) that Aram was a son of Shem, and that his own sons were Uz, Hul, Gether, and Mash. If these gave names to districts, Uz was in the north of Arabia Deserta, unless its name was derived rather from Huz, son of Nahor, Abraham's brother (Gen. xxii. 21). Hul was probably Cœle-Syria; Mash, the Mons Masius north of Nisibis in Mesopotamia; Gether is unknown. Another Aram is mentioned (Gen. xxii. 21) as the grandson of Nahor and son of Kemuel, but he is not to be thought of here. The descent of the Aramæans from a son of Shem is confirmed by their language, which was one of the branches of the Semitic family, and nearly allied to the Hebrew. Many writers, who have copied without acknowledgment the words of Calmet, maintain that the Aramæans came from Kir, appealing to Amos ix. 7; but while that passage is not free from obscurity, it seems evidently to point, not to the aboriginal abode of the people, but to the country whence God would

recover them when banished. The prophet ha said (Amos i. 5) that the people of Aram should go into captivity to Kir (probably the country on the river Kur or Cyrus), a prediction of which we read the accomplishment in 2 Kings xvi. 9; and the allusion here is to their future restoration. Hartmann thinks Armenia obtained its name from Aram. Traces of the name of the Aramæans are to be found in the Ἀραμοὶ and Ἀραμαῖοι of the Greeks (Strabo, xiii. 4. 6; xvi. 4. 27; comp. Homer's *Iliad*, ii. 783) [see ASSYRIA]. They were so noted for idolatry, that in the language of the later Jews אַרְמֵי יִתָּן was used as synonymous with heathenism (see the *Mishna* of Surenhusius, ii. 401; Onkelos on Levit. xxv. 47). Castell, in his *Lexic. Heptaglott.* col. 229, says the same form of speech prevails in Syriac and Ethiopic. The Hebrew letters *resh* and *daleth* are so alike, that they were often mistaken by transcribers; and hence in the Old Testament אַרְמֵי *Aram* is sometimes found instead of אֲדָמֵי *Edom*, and vice versa. Thus in 2 Kings xvi. 6, according to the text, the Aramæans are spoken of as possessing Elath on the Red Sea; but the Masoretic marginal reading has 'the Edomites,' which is also found in many manuscripts, in the Septuagint and Vulgate, and it is obviously the correct reading.—N. M.

ARAMAIC LANGUAGE (אַרְמֵי, 2 Kings xviii. 26; Dan. ii. 4). The Aramaic language—that whole, of which the Chaldee and Syriac dialects form the parts—constitutes the northern and least developed branch of the Syro-Arabian family. Its cradle was probably on the banks of the Cyrus, according to the best interpretation of Amos ix. 7; but Mesopotamia, Babylonia, and Syria form what may be considered its home and proper domain. Political events, however, subsequently caused it to supplant Hebrew in Palestine; and then it became the prevailing form of speech from the Tigris to the shore of the Mediterranean, and, in a contrary direction, from Armenia down to the confines of Arabia. After obtaining such a wide dominion, it was forced, from the ninth century onwards, to give way before the encroaching ascendancy of Arabic; and it now only survives, as a living tongue, among the Syrian Christians in the neighbourhood of Mosul.

According to historical records which trace the migrations of the Syro-Arabians from the East to the South-west, and also according to the comparatively ruder form of the Aramaic language itself, we might suppose that it represents, even in the state in which we have it, some image of that aboriginal type which the Hebrews and Arabians, under more favourable social and climatical influences, subsequently developed into fulness of sound and structure. But it is difficult for us now to discern the particular vestiges of this archaic form; for, not only did the Aramaic not work out its own development of the original elements common to the whole Syro-Arabian sisterhood of languages, but it was pre-eminently exposed, both by neighbourhood and by conquest, to harsh collision with languages of an utterly different family. Moreover, it is the only one of the three great Syro-Arabian branches which has no fruits of a purely national literature to boast of. We possess no monument whatever of its own genius; not any work which may be considered the

product of the political and religious culture of the nation, and characteristic of it—as is so emphatically the case both with the Hebrews and the Arabs. The first time we see the language, it is used by Jews as the vehicle of Jewish thought; and although, when we next meet it, it is employed by native authors, yet they write under the literary impulses of Christianity, and under the Greek influence on thought and language which necessarily accompanied that religion. These two modifications, which constitute and define the so-called Chaldee and Syriac dialects, are the only forms in which the normal and standard Aramaic has been preserved to us.

It is evident, from these circumstances, that, up to a certain period, the Aramaic language has no other history than that of its relations to Hebrew. The earliest notice we have of its separate existence is in Gen. xxxi. 47, where Laban, in giving his own name to the memorial heap, employs words which are genuine Aramaic both in form and use. The next instance is in 2 Kings xviii. 26, where it appears that the educated Jews understood Aramaic, but that the common people did not. A striking illustration of its prevalence is found in the circumstance that it is employed, as the language of official communication, in the edict addressed by the Persian court to its subjects in Palestine (Ezra iv. 17). The later relations of Aramaic to Hebrew consist entirely of gradual encroachments on the part of the former. The Hebrew language was indeed always exposed, particularly in the north of Palestine, to Aramaic influences; whence the Aramaisms of the book of Judges and of some others are derived. It also had always a closer conjunction, both by origin and by intercourse, with Aramaic than with Arabic. But in later times great political events secured to Aramaic the complete ascendancy; for, on the one hand, after the deportation of the ten tribes, the repopling their country with colonists chiefly of Syrian origin generated a mixed Aramaic and Hebrew dialect (the Samaritan) in central Palestine; and on the other, the exile of the remaining two tribes exposed them to a considerable, although generally overrated, Aramaic influence in Babylon, and their restoration, by placing them in contact with the Samaritans, tended still further to dispossess them of their vernacular Hebrew. The subsequent dominion of the Seleucidæ, under which the Jews formed a portion of a Syrian kingdom, appears to have completed the series of events by which the Aramaic supplanted the Hebrew language entirely.

The chief characteristics in form and flexion which distinguish the Aramaic from the Hebrew language are the following:—As to the consonants, the great diversity between the forms of the same root as it exists in both languages, arises principally from the Aramaic having a tendency to avoid the sibilants. Thus, where ש , ז , and ז are found in Hebrew, Aramaic often uses ט , ח , and ט ; and even פ for פ . Letters of the same organ are also frequently interchanged, and generally so that the Aramaic, consistently with its characteristic roughness, prefers the harder sounds. The number of vowel-sounds generally is much smaller: the verb is reduced to a monosyllable, as are also the segolate forms of nouns. This deprives the language of some distinct forms which are marked in Hebrew; but the number and variety

of nominal formations is also in other respects much more limited. The verb possesses no vestige of the conjugation *Niphal*, but forms all its passives by the prefix נ . The third person plural of the perfect has two forms, to mark the difference of gender. The use of the imperfect with *van consequitivum* is unknown. There is an imperative mood in all the *passives*. Each of the active conjugations, *Pael* and *Aphel*, possesses two participles, one of which has a passive signification. The participle is used with the personal pronoun to form a kind of present tense. The classes of verbs ל and ל , and other weak forms, are almost indistinguishable. In the noun, again, a word is rendered *definite* by appending the vowel א to the end (the so-called *status emphaticus*); but thereby the distinction between simple feminine and definite masculines is lost in the singular. The plural masculine ends in *in*. The relation of *genitive* is most frequently expressed by the prefix ל , and that of the *object* by the preposition ל .

All these peculiarities are common to both the dialects of Aramaic, and may therefore be considered to constitute the fundamental character of the language. The statement of the points in which they differ from each other, and an account of their literary remains, of their paleographical history, and of the subordinate dialects which have been derived from them, are reserved for other articles [CHALDEE LANGUAGE].—J. N.

ARARAT (אררט) occurs nowhere in Scripture as the name of a mountain, but only as the name of a country, upon the ‘mountains’ of which the ark rested during the subsidence of the flood (Gen. viii. 4). In almost every part of the East, where there is the tradition of a deluge, the inhabitants connect the resting-place of the ‘great vessel’ with some conspicuous elevation in their own neighbourhood. Thus we are informed by the lamented Sir A. Burnes (*Travels to Bokhara*, vol. i. p. 117), that on the road to Peshawur and Cabul, the Sufued Koh, or ‘White Mountain,’ rears its crest on one side, and the towering hill of Noorgill, or Kooner, on the other. Here the Afghans believe the ark of Noah to have rested after the Deluge. Another sacred mountain in the East is Adam’s Peak, in the island of Ceylon, and it is a curious circumstance, that in Gen. viii. 4, the Samaritan Pentateuch has ‘Sarandib,’ the Arabic name of Ceylon. In the Sibylline verses it is said that the mountains of Ararat were in Phrygia; but Bochart has ingeniously conjectured that the misconception arose from the city of Apamea there having been called *Kibotos* (the Greek word for an ark), because inclosed in the shape of an ark by three rivers. Shuckford, after Sir Walter Raleigh, would place Ararat far to the east, in part of the range anciently called Caucasus and Imaus, and terminating in the Himmaleh mountains, north of India; and to this opinion a late writer (Kirby) inclines in his *Bridgewater Treatise* (p. 45). Dr. Pye Smith also, when advocating the local and partial nature of the Deluge, seeks for a less elevated mountain than the Armenian Ararat, and lays hold of this among other hypotheses (*The Relation between Scripture and Geological Science*, p. 302); whereas Kirby embraces it for the very opposite reason, viz., because, holding the universality of

the Flood, he thinks that mountain is not high enough to account for the long period that elapsed (Gen. viii. 5) before the other mountains became visible. Now it is evident that these and such-like theories have been framed in forgetfulness of what the Bible has recorded respecting the locality of Ararat. We may be unable to fix with precision where that region lay, but we can without difficulty decide that it was neither in Afghanistan nor Ceylon, neither in Asia Minor nor in Northern India.

The only other passages where 'Ararat' occurs are 2 Kings xix. 37 (Isa. xxxvii. 38) and Jer. li. 27. In the former it is spoken of as the country whither the sons of Sennacherib, king of Assyria, fled, after they had murdered their father. The apocryphal book of Tobit (i. 21) says it was εἰς τὰ ὄρη Ἀραράθ, 'to the mountains of Ararath.' This points to a territory which did not form part of the immediate dominion of Assyria, and yet might not be far off from it. The description is quite applicable to Armenia, and the tradition* of that country bears, that Sennacherib's sons were kindly received by king Paroyr, who allotted them portions of land bordering on Assyria, and that in course of time their posterity also established an independent kingdom, called Vaspurakan (Avdall's *Transl. of Chamich's Hist. of Armenia* (vol. i. p. 33, 34). The other Scripture text (Jer. li. 27) mentions Ararat, along with Minni and Ashkenaz, as kingdoms summoned to arm themselves against Babylon. In the parallel place in Isa. xlii. 2-4, the invaders of Babylonia are described as 'issuing from the mountains;' and if by *Minni* we understand the *Minyas* in Armenia, mentioned by Nicholas of Damascus (Josephus, *Antiq.* i. 3. 6), and by *Ashkenaz* some country on the *Euxine* Sea, which may have had its original name, *Axenos*, from Ashkenaz, a son of Gomer, the progenitor of the Cimmerians (Gen. x. 2, 3)—then we arrive at the same conclusion, viz., that Ararat was a mountainous region north of Assyria, and in all probability in Armenia. In Ezek. xxxviii. 6, we find Togarmah, another part of Armenia, connected with Gomer, and in Ezek. xxvii. 14, with Meshech and Tubal, all tribes of the north. With this agree the traditions of the Jewish and Christian churches, and likewise the accounts of the native Armenian writers, who inform us that Ararat was the name of one of the ancient provinces of their country, supposed to correspond to the modern pashaliks of Kars and Bayazed, and part of Kurdistan. According to the tradition preserved in Moses of Chorene, the name of Ararat was derived from Arai, the eighth of the native princes, who was killed in a battle with the Babylonians, about B.C. 1750; in memory of which the whole province was called *Aray-iarat*, i. e. the ruin of Arai.

But though it may be concluded with tolerable certainty that the land of Ararat is to be identified with a portion of Armenia, we possess no historical data for fixing on any one mountain in that country as the resting-place of the ark. Indeed it may be fairly questioned whether the phrase in Gen. viii.

4, וַתָּנָח הַתְּכָה, 'and the ark rested,' necessarily means that the ark actually *grounded* on the top of a mountain; it may merely imply that after it had been driven and tossed to and fro on the waste of waters, it at length settled, i. e. attained a measure of comparative repose, and became more stationary *over* (עַל) the mountains of

Ararat, when the waters began to subside. That this *may* be the import of the expression will be denied by none who are acquainted with the genius of the Hebrew language, and with the latitude of meaning attachable to the verb נָח, which (as is observed by Taylor in his *Concordance*) includes whatever comes under the idea of 'remaining quietly in a place without being disturbed.' A vessel enjoys more real rest when becalmed, than when she grounds on the top of a submarine mountain in a troubled sea. What gives plausibility to our conjecture is the fact that whether the 'rest' was obtained on the bosom of the now calmer deep, or by coming into contact with the dry land, it was nearly *three months* after this before 'the tops of the mountains were seen' (Gen. viii. 5); the same mountains being evidently intended as those spoken of in the previous verse, viz. the mountains of Ararat. Now, as the waters were all the while abating (v. 3), it is much easier to reconcile this latter statement with the idea of the ark being still afloat, than with the common belief that it lay on a mountain peak; besides, that by this interpretation we get rid of otherwise inexplicable difficulties. If our supposition be correct, then, for anything that appears to the contrary, the ark did not touch the earth until the waters were abated to a level with the lower valleys or plains, and, consequently, the inmates were not left upon a dreary elevation of 16,000 or 17,000 feet, never till of late deemed accessible to human footsteps, and their safe descent from which, along with all the 'living creatures' committed to their care, would have been a greater miracle than their deliverance from the flood. By this explanation also we obviate the geological objection against the mountain, now called Ararat, having been submerged, which would imply a universal deluge, whereas by the 'mountains of Ararat' may be understood some lower chain in Armenia, whose height would not be incompatible with the notion of a partial flood. Finally, we on this hypothesis solve the question:—If the descendants of Noah settled near the resting-place of the ark in Armenia, how could they be said to approach the plain of Shinar (Gen. xi. 2), or Babylonia, *from the East*? For, as we read the narrative, the precise resting-place of the ark is nowhere mentioned; and though for a time stationary 'over' the mountains of Ararat, it may, before the final subsidence of the waters, have been carried considerably to the east of them.

The ancients, however, attached a peculiar sacredness to the tops of high mountains, and hence the belief was early propagated that the ark must have rested on some such lofty eminence. The earliest tradition fixed on one of the chain of mountains which separate Armenia on the south from Mesopotamia, and which, as they also inclose Kurdistan, the land of the Kurds, obtained the name of the *Kardu*, or *Carduchian* range, corrupted into *Gordizean* and *Cordyzean*. This

* A similar tradition is reported by the Armenian historian, Moses of Chorene, but he dates the event in the reign of Skaiord, the father of Paroyr.

ARARAT.

opinion prevailed among the Chaldæans, if we may rely on the testimony of Berossus as quoted by Josephus (*Antiq.* i. 3. 6): 'It is said there is still some part of this ship in Armenia, at the mountain of the Cordyæans, and that people carry off pieces of the bitumen, which they use as amulets.' The same is reported by Abydenus (in Euseb. *Præp. Evang.* ix. 4), who says they employed the wood of the vessel against diseases. Hence we are prepared to find the tradition adopted by the Chaldee paraphrasts, as well as by the Syriac translators and commentators, and all the Syriac churches. In the three texts where 'Ararat' occurs, the *Targum* of Onkelos has קררדו *Kardu*; and, according to Buxtorf, the term 'Kardyan' was in Chaldee synonymous with 'Armenian.' At Gen. viii. 4, the Arabic of Erpenius has *Jibal-el-Karud* (the Mountain of the

Kurds), which is likewise found in the 'Book of Adam' of the Zabæans. For other proofs that this was the prevalent opinion among the Eastern churches, the reader may consult Eutychiuss, (*Annals*), and Epiphanius (*Hæres.* 18). It was no doubt from this source that it was borrowed by Mahomet, who in his Koran (xi. 46) says, 'The ark rested on the mountain Al-Judi.' That name was probably a corruption of Giordi, *i. e.* Gordiæan (the designation given to the entire range), but afterwards applied to the special locality where the ark was supposed to have rested. This is on a mountain a little to the east of Jezirah ibn Omar (the ancient Bezabde) on the Tigris. At the foot of the mountain there was a village called *Karya Thaminin*, *i. e.* the Village of the Eighty—that being the number (and not eight) saved from the flood according to the Mo

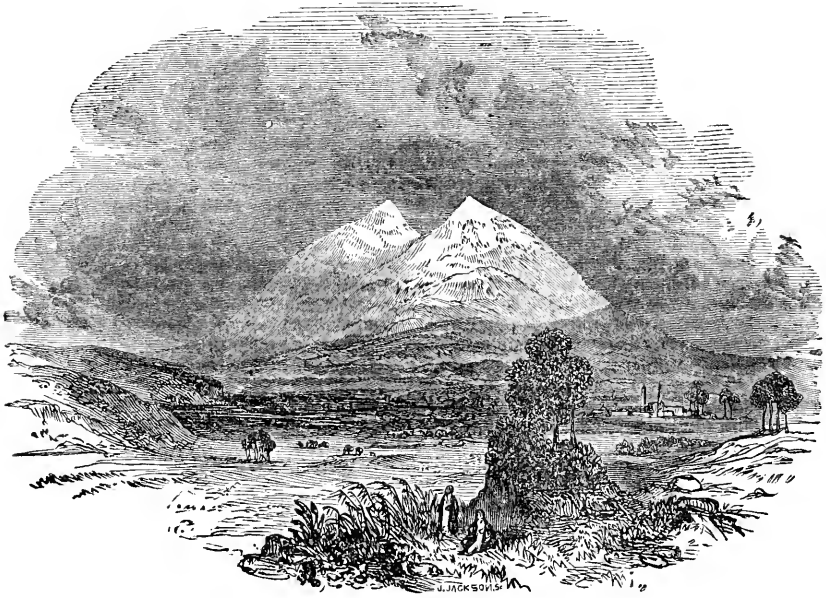

hammedan belief. The historian Elmacin mentions that the emperor Heraclius went up, and visited this as 'the place of the ark.' Here, or in the neighbourhood, was once a famous Nestorian monastery, 'the Monastery of the Ark,' destroyed by lightning in A.D. 776. The credulous Jew, Benjamin of Tudela, says that a mosque was built at Mount Judi, 'of the remains of the ark,' by the Khalif Omar. Macdonald Kinneir, in describing his journey from Jezirah along the left bank of the Tigris to Nahr Van, says, 'We had a chain of mountains running parallel with the road on the left hand. This range is called the *Juda Dag* (*i. e.* mountain) by the Turks, and one of the inhabitants of Nahr Van assured me that he had frequently seen the remains of Noah's ark on a lofty peak behind that village.' (Comp. Rich's *Kurdistan*, vol. ii. p. 124.) A French *savant*, Eugene Boré, who lately visited those parts, says the Mohammedan dervishes still maintain here a perpetually burning lamp in an ora-

tory. (*Revue Française*, vol. xii.; or the *Semeur* of October 2, 1839.)

After the disappearance of the Nestorian monastery, the tradition which fixed the site of the ark on Mount Judi appears to have declined in credit, or been chiefly confined to Mahometans, and gave place (at least among the Christians of the West) to that which now obtains, and according to which the ark rested on a great mountain in the north of Armenia—to which (so strongly did the idea take hold of the popular belief) was, in course of time, given the very name of Ararat, as if no doubt could be entertained that it was the Ararat of Scripture. We have seen, however, that in the Bible Ararat is nowhere the name of a mountain, and by the native Armenians the mountain in question was never so designated; it is by them called *Mâcis*, and by the Turks *Aghur-dagh*, *i. e.* 'The Heavy or Great Mountain.' The *Vulgate* and Jerome indeed, render Ararat by 'Armenia,' but they do not particu-

larize any one mountain. Still there is no doubt of the antiquity of the tradition of this being (as it is sometimes termed) the 'Mother of the World.' The Persians call it Kuli Nuch, 'Noah's Mountain.' The Armenian etymology of the name of the city of Nakhchevan (which lies east of it) is said to be 'first place of descent or lodging,' being regarded as the place where Noah resided after descending from the mount. It is mentioned by Josephus under a Greek name of similar import, viz. 'Ἀποβατήριον, and by Ptolemy as *Naxuana*.

The mountain thus known to Europeans as Ararat consists of two immense conical elevations (one peak considerably lower than the other), towering in massive and majestic grandeur from the valley of the Aras, the ancient Araxes. Smith and Dwight give its position N. 57° W. of Nakhchevan, and S. 25° W. of Erivan (*Researches in Armenia*, p. 267); and remark, in describing it before the recent earthquake, that in no part of the world had they seen any mountain whose imposing appearance could plead half so powerfully as this a claim to the honour of having once been the stepping-stone between the old world and the new. 'It appeared,' says Ker Porter, 'as if the hugest mountains of the world had been piled upon each other to form this one sublime immensity of earth and rocks and snow. The icy peaks of its double heads rose majestically into the clear and cloudless heavens; the sun blazed bright upon them, and the reflection sent forth a dazzling radiance equal to other suns. My eye, not able to rest for any length of time upon the blinding glory of its summits, wandered down the apparently interminable sides, till I could no longer trace their vast lines in the mists of the horizon; when an irrepressible impulse immediately carrying my eye upwards, again fixed my gaze upon the awful glare of Ararat.' To the same effect Morier writes:—'Nothing can be more beautiful than its shape, more awful than its height. All the surrounding mountains sink into insignificance when compared to it. It is perfect in all its parts; no hard rugged feature, no unnatural prominences, everything is in harmony, and all combines to render it one of the sublimest objects in nature.'

Several attempts had been made to reach the top of Ararat, but few persons had got beyond the limit of perpetual snow. The French traveller Tournefort, in the year 1700, long persevered in the face of many difficulties, but was foiled in the end. Between thirty and forty years ago the Pasha of Bayazeed undertook the ascent with no better success. The honour was reserved to a German, Dr. Parrot, in the employment of Russia, who, in his *Reise zum Ararat* (Journey to Ararat) gives the following particulars:—'The summit of the Great Ararat is in 39° 42' north lat., and 61° 55' east long. from Ferro. Its perpendicular height is 16,254 Paris feet above the level of the sea, and 13,350 above the plain of the Araxes. The Little Ararat is 12,284 Paris feet above the sea, and 9561 above the plain of the Araxes.' After he and his party had failed in two attempts to ascend, the third was successful, and on the 27th September (o. s.), 1829, they stood on the summit of Mount Ararat. It was a slightly convex, almost circular platform, about 200 Paris feet in diameter, composed of eternal

ice, unbroken by a rock or stone: on account of the immense distances, nothing could be seen distinctly. The mountain was, it is said, afterwards ascended by a Mr. Antonomoff, but the fact both of his and Parrot's having reached the top is stoutly denied by the natives, and especially by the inmates of the neighbouring convent of Echmiadzin, who have a firm persuasion that in order to preserve the ark no one is permitted to approach it. This is based on the tradition that a monk, who once made the attempt, was, when asleep from exhaustion, unconsciously carried down to the point whence he had started; but at last, as the reward of his fruitless exertions, an angel was sent to him with a piece of the ark, which is preserved as the most valuable relic in the cathedral of Echmiadzin.

Since the memorable ascent of Dr. Parrot, Ararat has been the scene of a fearful calamity. An earthquake, which in a few moments changed the entire aspect of the country, commenced on the 20th of June (o. s.), 1840, and continued, at intervals, until the 1st of September. Traces of fissures and landslips have been left on the surface of the earth, which the eye of the scientific observer will recognise after many ages. The destruction of houses and other property in a wide tract of country around was very great; fortunately, the earthquake having happened during the day, the loss of lives did not exceed fifty. The scene of greatest devastation was in the narrow valley of Akorhi, where the masses of rock, ice, and snow, detached from the summit of Ararat and its lateral points, were thrown at one single bound from a height of 6000 feet to the bottom of the valley, where they lay scattered over an extent of several miles. (See Major Voskoboinkof's Report, in the *Athenæum* for 1841, p. 157).—N. M.

ARAUNAH (אֲרָוֶנָה), or ORNAN (אֲרֹנָן), a man of the Jebusite nation, which possessed Jerusalem before it was taken by the Israelites. His threshing-floor was on Mount Moriah; and when he understood that it was required for the site of the Temple, he liberally offered the ground to David as a free gift; but the king insisted on paying the full value for it (2 Sam. xxiv. 18; 1 Chron. xxi. 18).

ARBA. [HEBRON.]

ARBELA. [BETH-ARBEL.]

ARCE, or ARKE, by change of pronunciation REKEM; the same as Petra, the capital of Arabia Petræa [PETRA].

ARCH. Arches with vaulted chambers and domed temples figure so conspicuously in modern Oriental architecture, that, if the arch did not exist among the ancient Jews, their towns and houses could not possibly have offered even a faint resemblance to those which now exist: and this being the case, a great part of the analogical illustrations of Scripture which modern travellers and Biblical illustrators have obtained from this source must needs fall to the ground. It is therefore of importance to ascertain whether the arch did or did not exist in those remote times to which most of the history of at least the Old Testament belongs. Nothing against its existence is to be inferred from the fact that no word signifying an arch can be found in the Hebrew Scriptures (for the word so rendered in

Ezek. xl. 16, has not that meaning). The architectural notices in the Bible are necessarily few and general; and we have at this day histories and other books, larger than the sacred volume, in which no such word as 'arch' occurs. There is certainly no absolute proof that the Israelites employed arches in their buildings; but if it can be shown that arches existed in Egypt at a very early period, we may safely infer that so useful an invention could not have been unknown in Palestine.

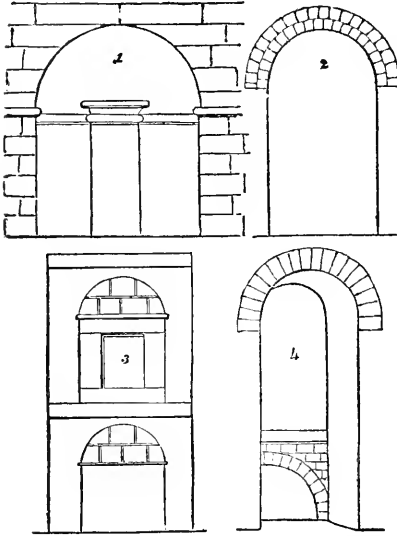

Until within these few years it was common to ascribe a comparatively late origin to the arch; but circumstances have come to light one after another, tending to throw the date more and more backward, until at length it seems to be admitted that in Egypt the arch already existed in the time of Joseph. The observations of Rosellini and of Sir J. G. Wilkinson led them irresistibly to this conclusion, which has also been recently adopted by Mr. Cockerell (*Lect. iii.*, in *Athenæum* for Jan. 28, 1843) and other architects.

It is shown by Sir J. G. Wilkinson that the arch existed in brick in the reign of Amenoph I., as early as b.c. 1540; and in stone in the time of the second Psamaticus, b.c. 600. This evidence is derived from the ascertained date of arches now actually existing; but the paintings at Beni-Hassan afford ground for the conclusion that vaulted buildings were constructed in Egypt as early as the reign of Osirtasen I., who is presumed to have been contemporary with Joseph. Indeed, although the evidence from facts does not ascend beyond this, the evidence from analogy and probability can be carried back to about b.c. 2020 (Wilkinson's *Anc. Egyptians*, ii. 116; iii. 316). Sir J. G. Wilkinson suggests the probability that the arch owed its invention to the small quantity of wood in Egypt, and the consequent expense of roofing with timber. The proofs may be thus arranged in chronological order:—

The evidence that arches were known in the

time of the first Osirtasen is derived from the drawings at Beni-Hassan (Wilkinson, ii. 117).

In the secluded valley of Dayr el Medeeneh, at Thebes, are several tombs of the early date of Amenoph I. Among the most remarkable of these is one whose crude brick roof and niche, bearing the name of the same Pharaoh, prove the existence of the arch at the remote period of b.c. 1540 (Wilkinson, *Topography of Thebes*, p. 81). Another tomb of similar construction bears the ovals of Thothmes III., who reigned about the time of the Exode (*Anc. Egyptians*, iii. 319). At Thebes there is also a brick arch bearing the name of this king (Hoskins, *Travels in Ethiopia*).

To the same period and dynasty (the 18th) belong the vaulted chambers and arched doorways (see cut, fig. 4) which yet remain in the crude brick pyramids at Thebes (Wilkinson, *Anc. Egyptians*, iii. 317).

In ancient Egyptian houses it appears that the roofs were often vaulted, and built, like the rest of the house, of crude brick; and there is reason to believe that some of the chambers in the pavilion of Rameses III. (about b.c. 1245), at Medeenet Haboo, were arched with stone, since the devices in the upper part of the walls show that the fallen roofs had this form (see cut, fig. 3).

The most ancient *actually existing* arches of stone occur at Memphis, near the modern village of Saqqara. Here there is a tomb with two large vaulted chambers, whose roofs display in every part the name and sculptures of Psamaticus II. (about b.c. 600). The chambers are cut in the limestone rock, and this being of a friable nature, the roof is secured by being, as it were, lined with an arch, like our modern tunnels.



To about the same period—that of the last dynasty before the Persian invasion—belong the remarkable doorways of the enclosures surrounding the tombs in the Assaséef, which are composed of two or more concentric semicircles of brick (fig. 2) (Wilkinson, *Anc. Egyptians*, iii. 319).

Although the oldest *stone* arch whose age has been positively ascertained does not date earlier

than the time of Psamaticus, we cannot suppose that the use of stone was not adopted by the Egyptians for that style of building previous to his reign, even if the arches in the pyramids in Ethiopia should prove not to be anterior to the same era. 'Nor does the absence of the arch in temples and other large buildings excite our surprise, when we consider the style of Egyptian monuments; and no one who understands the character of their architecture could wish for its introduction. In some of the small temples of the Oasis the Romans attempted this innovation, but the appearance of the chambers so constructed fails to please; and the whimsical caprice of Osirei (about B.C. 1385), also introduced an imitation of the arch in a temple at Abydos. In this building the roof is formed of single blocks of stone, reaching from one architrave to the other, which, instead of being placed in the usual manner, stand upon their edges, in order to allow room for hollowing out an arch in their thickness; but it has the effect of inconsistency,

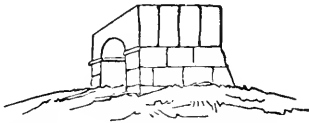

without the plea of advantage or utility.' Another imitation of the arch occurs in a building at Thebes, constructed in the style of a tomb. The chambers lie under a friable rock, and are cased with masonry, to prevent the fall of its crumbling stone; but, instead of being roofed on the principle of the arch, they are covered with a number of large blocks, placed horizontally, one projecting beyond that immediately below it, till the uppermost two meet in the centre, the inferior angles being afterwards rounded off to form the appearance of a vault (fig. 1). The date of this building is about B.C. 1500, and consequently many years after the Egyptians had been acquainted with the art of vaulting (Wilkinson, *Anc. Egyptians*, ii. 321).

Thus as the temple architecture of the Egyptians did not admit of arches, and as the temples are almost the only buildings that remain, it is not strange that arches have not oftener been found. The evidence offered by the paintings, the tombs, and the pyramids is conclusive for the existence and antiquity of arches and vaults of brick and stone; and if any remains of houses and palaces had now existed, there is little doubt that the arch would have been of frequent occurrence. We observe that Sir J. G. Wilkinson, in portraying an Egyptian mansion (*Anc. Egyptians*, ii. 131), makes the grand entrance an archway.

After this it seems unreasonable to doubt that the arch was known to the Hebrews also, and was employed in their buildings. Palestine was indeed better wooded than Egypt; but still that there was a deficiency of wood suitable for building and for roofs is shown by the fact that large importations of timber from the forests of Lebanon were necessary (2 Sam. vii. 2, 7; 1 Kings v. 6; 1 Chron. xxii. 4; 2 Chron. ii. 3; Ezra iii. 7; Cant. i. 17), and that this imported timber, although of no very high quality, was held in great estimation.

ARCHELAUS, son of Herod the Great, and his successor in Idumæa, Judæa, and Samaria (Matt. ii. 22) [HERODIAN FAMILY].

ARCHERY. [ARMS.]

ARCHIPPUS (Ἀρχιππος), a Christian minister, whom St. Paul calls his 'fellow-soldier,' in Philem. 2, and whom he exhorts to renewed activity in Col. iv. 17. From the latter reference it would seem that Archippus had exercised the office of Evangelista sometimes at Ephesus, sometimes elsewhere; and that he finally resided at Colosse, and there discharged the office of presiding presbyter or bishop when St. Paul wrote to the Colossian church. The exhortation given to him in this Epistle has, without sufficient grounds, been construed into a rebuke for past negligence.

ARCHISYNAGOGUS (Gr. ἀρχισυναγωγός, called also ἄρχων τῆς συναγωγῆς (Luke viii. 41), and simply ἄρχων (Matt. ix. 18); Heb. רִאשׁ הַכְּנֶסֶת, chief or ruler of the synagogue). In large synagogues there appears to have been a college or council of elders (עֲנִיָּוִן = πρεσβύτεροι, Luke vii. 3) to whom the care of the synagogue and the discipline of the congregation were committed, and to all of whom this title was applied (Mark v. 22; Acts xiii. 15; xviii. 8, compared with v. 17). Their duties were to preside in the public services, to direct the reading of the Scriptures and the addresses to the congregation (Vitringa, *De Synagoga Vetere*, lib. 3, part i. c. 7; comp. Acts xiii. 15), to superintend the distribution of alms (Vitr. c. 13), and to punish transgressors either by scourging (Vitr. c. 11; compare Matt. x. 17; xxii. 34; Acts xxii. 19) or by excommunication (Vitr. c. 9). In a more restricted sense the title is sometimes applied to the president of this council, whose office, according to Grotius (*Annotaciones in Matt.* ix. 18; *Luc.* xiii. 14) and many other writers, was different from and superior to that of the elders in general. Vitringa (p. 586), on the other hand, maintains that there was no such distinction of office, and that the title thus applied merely designates the presiding elder, who acted on behalf of and in the name of the whole.—F. W. G.

ARCHITECTURE. It was formerly common to claim for the Hebrews the invention of scientific architecture; and to allege that classical antiquity was indebted to the Temple of Solomon for the principles and many of the details of the art. A statement so strange, and even preposterous, would scarcely seem to demand attention at the present day; but as it is still occasionally reproduced, and as some respectable old authorities can be cited in its favour, it cannot be passed altogether in silence. The question belongs properly, however, to another head [TEMPLE]. It may here suffice to remark that temples previously existed in Egypt, Babylon, Syria and Phœnicia, from which the classical ancients were far more likely to borrow the ideas which they embodied in new and beautiful combinations of their own. But there are few notions, however untenable, which have not some apparent foundation in fact. So in the present case, it is shown, first, that a resemblance of plan and detail can be traced between certain heathen temples and the Temple at Jerusalem; and, secondly, it is alleged that this could not be owing to imita-

tion in the latter, because the *tabernacle* (of which the Temple was a sort of imitation) was a divine suggestion, being framed according to a pattern shown to Moses on the Mount (Exod. xxv. 40). This is the sole ground on which the claim made for the Hebrew architecture can be rested. But 'a pattern' is not necessarily or probably a new thing; in the usual sense it is almost always a new combination or adaptation of existing materials. And it may be shown, not only from historical probability, but from actual examples [ARK], that nothing more than this is here to be understood—nothing more than that Moses was instructed how best to apply the materials of existing sacred architecture (more especially that of Egypt) to the object in view. The pattern was necessary to make him understand how this application was to be made, and to render it clear to him what parts of existing structures should be rejected or retained. Indeed, this is proved by the Scripture itself; for David, in his charge to Solomon concerning the Temple, says 'All this the Lord made me understand in writing by his hand upon me, even all the works of this pattern' (1 Chron. xxviii. 19). Now, whatever be the meaning of this (and the authorized translation is purposely retained), it must mean nearly the same thing as in the parallel passage respecting the tabernacle. Yet it is on all hands admitted that the Temple, of which this is said, was an application and extension of ideas already existing in the tabernacle. This text, therefore, must not be taken in the sense of complete origination. And if we are forbidden to understand the terms as proving the complete originality of the Temple, by what rule of Scripture interpretation are we compelled to understand precisely similar terms as proving the complete originality of the tabernacle?

Mr. Cockerell, in one of his recent 'Lectures' (*Athenæum*, Jan 21, 1843), strongly upholds those high claims of Jewish architecture which all Biblical scholars now admit to be untenable, and which sound historians and antiquarians have long repudiated. It has therefore been deemed necessary thus particularly to refer to the matter, lest the authority of a high name in architecture should tend to revive pretensions which had almost become obsolete. Yet even Mr. Cockerell endeavours to correct one 'common error' on the subject, which, he states, is 'the attempt to trace this resemblance in the styles or the orthographic figure of the parts and orders—the mere vesture of the scheme; and the failure in straining the texts and examples (Corinthian or Doric) to a perfect correspondence . . . but the comparison of the *plans* makes the tabernacle the type of the Greek and Roman temple,' &c.

There has never in fact been any people for whom a peculiar style of architecture could with less probability be claimed than for the Israelites. On leaving Egypt they could only be acquainted with Egyptian art. On entering Canaan they necessarily occupied the buildings of which they had dispossessed the previous inhabitants; and the succeeding generations would naturally erect such buildings as the country previously contained. The architecture of Palestine, and as such, eventually that of the Jews, had doubtless its own characteristics, by which it was suited to the

climate and condition of the country; and in the course of time many improvements would no doubt arise from the causes which usually operate in producing change in any practical art. From the want of historical data and from the total absence of architectural remains, the degree in which these causes operated in imparting a peculiar character to the Jewish architecture cannot now be determined; for the oldest ruins in the country do not ascend beyond the period of the Roman domination. It does, however, seem probable that among the Hebrews architecture was always kept within the limits of a mechanical craft, and never rose to the rank of a fine art. Their usual dwelling-houses differed little from those of other Eastern nations, and we nowhere find anything indicative of exterior embellishment. Splendid edifices, such as the palace of David and the Temple of Solomon, were completed by the assistance of Phœnician artists (2 Sam. v. 11; 1 Kings v. 6, 18; 1 Chron. xiv. 1). After the Babylonish exile, the assistance of such foreigners was likewise resorted to for the restoration of the Temple (Ezra iii. 7). From the time of the Maccabæan dynasty, the Greek taste began to gain ground, especially under the Herodian princes (who seem to have been possessed with a sort of mania for building), and was shown in the structure and embellishment of many towns, baths, colonnades, theatres and castles (Joseph. *Antiq.* xv. 8. 1; xv. 19. 4; xv. 10. 3; *De Bell. Jud.* i. 4. 1). The Phœnician style, which seems to have had some affinity with the Egyptian, was not, however, superseded by the Grecian; and even as late as the Mishna (*Bava Bathra*, iii. 6), we read of Tyrian windows, Tyrian porches, &c. [House].

With regard to the instruments used by builders—besides the more common, such as the axe, saw, &c., we find incidental mention of the $\eta\lambda\eta\lambda\eta$ or compass, the $\eta\lambda\eta$ or plumb-line (Amos vii. 7), the $\eta\lambda$ or measuring-line (see the several words). Winer's *Biblisches Realwörterbuch*, art. 'Baukunst'; Steigletz's *Geschicht der Baukunst der Alten*, 1792; Hirt's *Gesch. des Bauk. bei der Alten*; Schmidt's *Bibl. Mathematicus*; Bellermann's *Handbuch*, &c.

ARCHITRICLINUS (*Ἀρχιτρικλινος*, master of the triclinium, or dinner-bed—ACCUBATION), very properly rendered in John ii. 8, 9, 'master of the feast,' equivalent to the Roman *Magister Convivi*. The Greeks also denoted the same social officer by the title of *Symposiarch* (*συμποσιαρχος*). He was not the giver of the feast, but one of the guests specially chosen to direct the entertainment, and promote harmony and good fellowship among the company. In the apocryphal *Ecclesiasticus* (xxxv. 1, 2) the duties of this officer among the Jews are indicated. He is there, however, called *ἡγούμενος*:—'If thou be made the master [of a feast], lift not thyself up, but be among them as one of the rest; take diligent care for them, and so sit down: and when thou hast done all thy office, take thy place, that thou mayest be merry with them, and receive a crown for thy well ordering of the feast.'

AREOPAGUS, an Anglicized form of the original words (*ἀρειος πάγος*), signifying, in reference to place, Mars Hill, but, in reference to persons, the Council which was held on the hill. The Council was also termed *ἡ ἐν Ἀρείῳ πάγῳ*

Βουλή (or *ἡ βουλή ἢ ἐν Ἀρείῳ πάγῳ*), the Council on Mars Hill; sometimes *ἡ ἄνω βουλή*, the Upper Council, from the elevated position where it was held; and sometimes simply, but emphatically, *ἡ βουλή*, the Council; but it retained, till a late period, the original designation of Mars Hill, being called by the Latins *Scopulus Martis*, *Curia Martis* (Juvenal, *Sat.* ix. 101), and still more literally, *Areum Judicium* (Tacit. *Annal.* ii. 55). The place and the Council are topics of interest to the Biblical student, chiefly from their being the scene of the interesting narrative and sublime discourse found in Acts xvii., where it appears that the apostle Paul, feeling himself moved, by the evidences of idolatry with which the city of Athens was crowded, to preach Jesus and the resurrection, both in the Jewish synagogues and in the market-place, was set upon by certain Epicurean and Stoic philosophers, and led to the Areopagus, in order that they might learn from him the meaning and design of his new doctrine. Whether or not the Apostle was criminally arraigned, as a setter forth of strange gods, before the tribunal which held its sittings on the hill, may be considered as undetermined, though the balance of evidence seems to incline to the affirmative. Whichever view on this point is adopted, the dignified, temperate, and high-minded bearing of Paul under the peculiar circumstances in which he was placed are worthy of high admiration, and will appear the more striking the more the associations are known and weighed which covered and surrounded the spot where he stood. Nor does his eloquent discourse appear to have been without good effect; for though some mocked, and some procrastinated, yet others believed, among whom was a member of the Council, 'Dionysius, the Areopagite,' who has been represented as the first bishop of Athens, and is said to have written books on the 'Celestial Hierarchy;' but their authenticity is questioned.

The accompanying plan will enable the reader to form an idea of the locality in which the Apostle stood, and to conceive in some measure the impressive and venerable objects with which he was environed. Nothing, however, but a minute description of the city in the days of its pride, comprising some details of the several temples, porticoes, and schools of learning which crowded on his sight, and which, whilst they taught him that the city was 'wholly given to idolatry,' impressed him also with the feeling that he was standing in the midst of the highest civilization, both of his own age and of the ages that had elapsed, can give an adequate conception of the position in which Paul was placed, or of the lofty and prudent manner in which he acted. The history in the Acts of the Apostles (xvii. 22) states that the speaker stood in the midst of Mars Hill. Having come up from the level parts of the city, where the markets (there were two, the old and the new) were, he would probably stand with his face towards the north, and would then have immediately behind him the long walls which ran down to the sea, affording protection against a foreign enemy. Near the sea, on one side, was the harbour of Peiræus, on the other that designated Phalerum, with their crowded arsenals, their busy workmen, and their gallant ships. Not far off in the ocean lay the island of Salamis, ennobled for

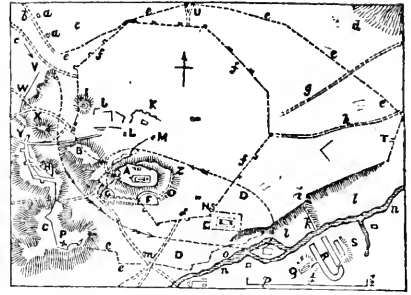

- | | |
|--------------------------------|-----------------------------------|
| A. The Acropolis. | N. Arch of Hadrian. |
| B. Areopagus. | O. Street of Tripods. |
| C. Museum. | P. Monument of Philopappus. |
| D. Hadrianopolis. | Q. Temple of Fortune. |
| E. Temple of Jupiter Olympius. | R. Panathenæic Stadium. |
| F. Theatre of Bacchus. | S. Tomb of Herodes. |
| G. Odæum of Regilla. | T. Gate of Diachares. |
| H. Pnyx. | U. Gate of Achæus. |
| I. Temple of Theseus. | V. Dipylum. |
| J. Gymnasium of Ptolemy. | W. Gate called Hippades. |
| K. Stoa of Hadrian. | X. Lycæbætus. |
| L. Gate of New Agora. | Y. Peiræic Gate. |
| M. Tower of Andronicus. | Z. Prytæneium. |
| a. Tombs. | i. Gate. |
| b. To the Academia. | k. Bridge. |
| c. Cerameicus Exterior. | l. Gardens. |
| d. Mount Achesmus. | m. Ionian Gate. |
| e. Ancient Walls. | n. River Ilissus. |
| f. Modern Walls. | o. Calithos. |
| g. Road to Marathon. | p. Scale of half an English mile. |
| h. Road to the Mesogæa. | |

ever in history as the spot near which Athenian valour chastised Asiatic pride, and achieved the liberty of Greece. The apostle had only to turn towards his right hand to catch a view of a small but celebrated hill rising within the city near that on which he stood, called the Pnyx, where, standing on a block of bare stone, Demosthenes and other distinguished orators had addressed the assembled people of Athens, swaying that arrogant and fickle democracy, and thereby making Philip of Macedon tremble, or working good or ill for the entire civilized world. Immediately before him lay the crowded city, studded in every part with memorials sacred to religion or patriotism, and exhibiting the highest achievements of art. On his left, somewhat beyond the walls, was beheld the Academy, with its groves of plane and olive-trees, its retired walks and cooling fountains, its altar to the Muses, its statues of the Graces, its temple of Minerva, and its altars to Prometheus, to Love, and to Hercules, near which Plato had his country-seat, and in the midst of which he had taught, as well as his followers after him. But the most impressive spectacle lay on his right hand, for there, on the small and precipitous hill named the Acropolis, were clustered together monuments of the highest art, and memorials of the national religion, such as no other equal spot of ground has ever borne. The Apostle's eyes, in turning to the right, would fall on the north-west side of the eminence, which was here (and all round) covered and protected by a wall, parts of which were so ancient as to be of Cyclopean origin. The western side, which alone gave access to what, from its original destination, may be termed the fort, was, during the administration of Pericles, adorned with a splendid flight of steps, and the beautiful Propylæa, with its five entrances and two flanking temples, constructed by Mnesicles of Pentelican marble, at a cost of 2012 talents. In the times of the

Roman emperors there stood before the Propylæa equestrian statues of Augustus and Agrippa. On

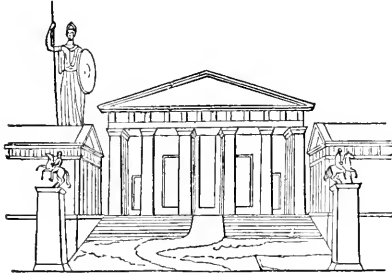

the southern wing of the Propylæa was a temple of Wingless Victory; on the northern, a Pinacotheca, or picture gallery. On the highest part of the platform of the Acropolis, not more than 300 feet from the entrance-buildings just described, stood (and yet stands, though shattered and mutilated) the Parthenon, justly celebrated throughout the world, erected of white Pentelican marble, under the direction of Callicrates, Ictinus, and Carpius, and adorned with the finest sculptures from the hand of Phidias. Northward from the Parthenon was the Erechtheum, a compound building, which contained the temple of Minerva Polias, the proper Erechtheum (called also the Cecropium), and the Pandroseum. This sanctuary contained the holy olive-tree sacred to Minerva, the holy salt-spring, the ancient wooden image of Pallas, &c., and was the scene of the oldest and most venerated ceremonies and recollections of the Athenians. Between the Propylæa and the Erechtheum was placed the colossal bronze statue of Pallas Promachos, the work of Phidias, which towered so high above the other buildings, that the plume of her helmet and the point of her spear were visible on the sea between Sunium and Athens. Moreover, the Acropolis was occupied by so great a crowd of statues and monuments, that the account, as found in Pausanias, excites the reader's wonder, and makes it difficult for him to understand how so much could have been crowded into a space which extended from the south-east corner to the south-west only 1150 feet, whilst its greatest breadth did not exceed 500 feet. On the hill itself where Paul had his station, was, at the eastern end, the temple of the Furies, and other national and commemorative edifices. The court-house of the council, which was also here, was, according to the simplicity of ancient customs, built of clay. There was an altar consecrated by Orestes to Athene Areia. In the same place were seen two silver stones, on one of which stood the accuser, on the other, the accused. Near them stood two altars erected by Epimenes, one to Insult ("Ἵβρεως, Cic. *Contumeliæ*), the other to Shamelessness ("Αυαδείας, Cic. *Impudentiæ*).

The court of Areopagus was one of the oldest and most honoured, not only in Athens, but in the whole of Greece, and, indeed, in the ancient world. Through a long succession of centuries, it preserved its existence amid changes corresponding with those which the state underwent, till at least the age of the Cæsars (Tacitus, *Ann.* ii. 55). The ancients are full of eulogies on its

value, equity, and beneficial influence; in consequence of which qualities it was held in so much respect that even foreign states sought its verdict in difficult cases. Like everything human, however, it was liable to decline, and, after Greece had submitted to the yoke of Rome, retained probably little of its ancient character beyond a certain dignity, which was itself cold and barren; and however successful it may in earlier times have been in conciliating for its determinations the approval of public opinion, the historian Tacitus (*ut supra*) mentions a case in which it was charged with an erroneous, if not a corrupt, decision.

The origin of the court ascends back into the darkest mythical period. From the first its constitution was essentially aristocratic; a character which to some extent it retained even after the democratic reforms which Solon introduced into the Athenian constitution. By his appointment the nine archons became for the remainder of their lives Areopagites, provided they had well discharged the duties of their archonship, were blameless in their personal conduct, and had undergone a satisfactory examination. Its power and jurisdiction were still further abridged by Pericles, through his instrument Ephialtes. Following the political tendencies of the state, the Areopagus became in process of time less and less aristocratical, and parted piecemeal with most of its important functions. First its political power was taken away, then its jurisdiction in cases of murder, and even its moral influence gradually departed. During the sway of the Thirty Tyrants its power, or rather its political existence, was destroyed. On their overthrow it recovered some consideration, and the oversight of the execution of the laws was restored to it by an express decree. Isocrates endeavoured by his *Ἀρεοπαγитικὸς λόγος* to revive its ancient influence. The precise time when it ceased to exist cannot be determined; but evidence is not wanting to show that in later periods its members ceased to be uniformly characterized by blameless morals.

It is not easy to give a correct summary of its several functions, as the classic writers are not agreed in their statements, and the jurisdiction of the court varied, as has been seen, with times and circumstances. They have, however, been divided into six general classes (*Real-Encyclopædie* von Pauly, *in voc.*): I. Its judicial function; II. Its political; III. Its police function; IV. Its religious; V. Its educational; and VI. (only partially) Its financial. In relation to these functions, such details only can be given here as bear more or less immediately on its moral and religious influence, and may serve to assist the student of the Holy Scriptures in forming an opinion as to the relation in which the subject stands to the Gospel, and its distinguished missionary, the apostle Paul.

Passing by certain functions, such as acting as a court of appeal, and of general supervision, which under special circumstances, and when empowered by the people, the Areopagus from time to time discharged, we will say a few words in explanation of the points already named, giving a less restricted space to those which concern its moral and religious influence. Its judicial function embraced trials for murder and

manslaughter (*φόνου δίκαι, τὰ φονικά*), and was the oldest and most peculiar sphere of its activity. The indictment was brought by the second or king-archon (*ἄρχων βασιλεύς*), whose duties were for the most part of a religious nature. Then followed the oath of both parties, accompanied by solemn appeals to the gods. After this the accuser and the accused had the option of making a speech (the notion of the proceedings of the Areopagus being carried on in the darkness of night rests on no sufficient foundation), which, however, they were obliged to keep free from all extraneous matter (*ἕξω τοῦ πράγματος*), as well as from mere rhetorical ornaments. After the first speech, the accused was permitted to go into voluntary banishment, if he had no reason to expect a favourable issue. Theft, poisoning, wounding, incendiarism, and treason, belonged also to this department of jurisdiction in the court of the Areopagus.

Its political function consisted in the constant watch which it kept over the legal condition of the state, acting as overseer and guardian of the laws (*ἐπίσκοπος καὶ φύλαξ τῶν νόμων*).

Its police function also made it a protector and upholder of the institutions and laws. In this character the Areopagus had jurisdiction over novelties in religion, in worship, in customs, in everything that departed from the traditional and established usages and modes of thought (*παρῖοι νομίμοι*), which a regard to their ancestors endeared to the nation. This was an ancient and well-supported sphere of activity. The members of the court had a right to take oversight of festive meetings in private houses. In ancient times they fixed the number of the guests, and determined the style of the entertainment. If a person had no obvious means of subsisting, or was known to live in idleness, he was liable to an action before the Areopagus; if condemned three times, he was punished with *ἀτιμία*, the loss of his civil rights. In later times the court possessed the right of giving permission to teachers (philosophers and rhetoricians) to establish themselves and pursue their profession in the city.

Its strictly religious jurisdiction extended itself over the public creed, worship, and sacrifices, embracing generally everything which could come under the denomination of *τὰ ἱερά*—sacred things. It was its special duty to see that the religion of the state was kept pure from all foreign elements. The accusation of impiety (*γραφὴ ἀσεβείας*)—the vagueness of which admitted almost any charge connected with religious innovations—belonged in a special manner to this tribunal, though the charge was in some cases heard before the court of the Heliastæ. The freethinking poet Euripides stood in fear of, and was restrained by, the Areopagus (Euseb. *Prep. Evang.* vi. 14; Bayle *s. v. Eurip.*). Its proceeding in such cases was sometimes rather of an admonitory than punitive character.

Not less influential was its moral and educational power. Isocrates speaks of the care which it took of good manners and good order (*τῆς εὐκοσμίας, εὐταξίας*). Quintilian relates that the Areopagus condemned a boy for plucking out the eyes of a quail—a proceeding which has been both misunderstood and misrepresented (*Penny Cyclop.* in voc.), but which its original narrator

approved, assigning no insufficient reason, namely, that the act was a sign of a cruel disposition, likely in advanced life to lead to baneful actions: ‘*Id signum esse perniciosissimæ mentis, multisque malo futuræ si adolevisset*’ (Quint. v. 9). The court exercised a salutary influence in general over the Athenian youth, their educators and their education.

Its financial position is not well understood; most probably it varied more than any other part of its administration with the changes which the constitution of the city underwent. It may suffice to mention, on the authority of Plutarch (*Themis.* c. 10), that in the Persian war the Areopagus had the merit of completing the number of men required for the fleet, by paying eight drachmæ to each.

In the following works corroboration of the facts stated in this article, and further details, with discussions on doubtful points, may be found:—Meursius, *Areopagus, sive de Senatu Areopagitico*, in *Thes. Gron.* t. v. p. 207; Sigonius, *De Rep. Ath.* iii. 2. p. 1568; De Canaye, *Recherches sur l'Aréopage*, pp. 273-316; *Mém. de l'Acad. des Inscr.* t. x.; Schede, *De Areop.* and Schwab *Num. quod Areop. in plebisita aut confirmanda aut rejicienda jus exerceat legitimum*, Stutt. 1818; Meier, *Von der Blutgerichtsbarkeit des Areopag.*; Matthiæ, *De Jud. Ath. in Misc. Philol.* Krebs, *de Ephetis*. Notices on the subject may also be found in the works of Tittman, Hefster, Hudtwalcker, Wachsmuth, Pauly, and Winer.—

J. R. B.

AREOPOLIS. [AR; AROER.]

ARETAS (*Ἀρέτας*; Arab. *حارث*, v. Pocock, *Spec. Hist. Arab.* p. 58, or, in another form,

حارث = *Ἡρῆπ*, Pococke, i. c. 70, 76, 77, 89),

the common name of several Arabian kings.

1. The first of whom we have any notice was a contemporary of the Jewish high-priest Jason and of Antiochus Epiphanes about b. c. 170 (2 Macc. v. 8). ‘In the end, therefore, he (Jason) had an unhappy return, being accused before *Aretas, the king of the Arabians*.’ 2. Josephus (*Antiq.* xiii. 13. 3) mentions an Aretas, king of the Arabians (called Obedas, Ὀβέδας, xiii. 13. 5), contemporary with Alexander Jannæus (died b. c. 79) and his sons. After defeating Antiochus Dionysus, he reigned over Cæle-Syria, ‘being called to the government by those that held Damascus (*καθελθὼς εἰς τὴν ἀρχὴν ὑπὸ τῶν τῆν Δαμασκὸν ἐχόντων*) by reason of the hatred they bore to Ptolemy Mennæus’ (*Antiq.* xiii. 15. 2). He took part with Hyrcanus in his contest for the sovereignty with his brother Aristobulus, and laid siege to Jerusalem, but, on the approach of the Roman general Scævus, he retreated to Philadelphia (*De Bell. Jud.* i. 6. 3). Hyrcanus and Aretas were pursued and defeated by Aristobulus at a place called Papyron, and lost above 6000 men. Three or four years after, Scævus, to whom Pompey had committed the government of Cæle-Syria, invaded Petraæ, but finding it difficult to obtain provisions for his army, he consented to withdraw on the offer of 300 talents from Aretas (Joseph. *Antiq.* xiv. 5. 1). Havercamp has given an engraving of a denarius intended to commemorate this event, on which Aretas appears in a supplicating posture, and

taking hold of a camel's bridle with his left hand, and with his right hand presenting a branch of the frankincense-tree, with this inscription, M. SCAVRVS. EX. S. C., and beneath, REX ARETAS (Joseph. *De Bell. Jud.* i. 8. 1). 3. Aretas, whose name was origin-

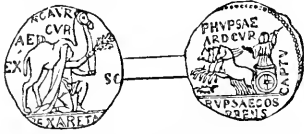

ally Æneas, succeeded Obodas (Ὀβόδας). He was the father-in-law of Herod Antipas. The latter made proposals of marriage to the wife of his half-brother Herod-Philip, Herodias, the daughter of Aristobulus their brother, and the sister of Agrippa the Great. (On the apparent discrepancy between the Evangelists and Josephus, in reference to the name of the husband of Herodias, see Lardner's *Credibility*, &c. pt. i. b. ii. ch. 5; *Works*, ed. 1835, i. 408-416.) In consequence of this, the daughter of Aretas returned to her father, and a war (which had been fomented by previous disputes about the limits of their respective countries) ensued between Aretas and Herod. The army of the latter was totally destroyed; and on his sending an account of his disaster to Rome, the emperor immediately ordered Vitellius to bring Aretas prisoner alive, or, if dead, to send his head (Joseph. *Antiq.* xviii. 5. 1). But while Vitellius was on his march to Petra, news arrived of the death of Tiberius, upon which, after administering the oath of allegiance to his troops, he dismissed them to winter-quarters and returned to Rome. It must have been at this juncture that Aretas took possession of Damascus, and placed a governor in it (ἐθάρχησεν) with a garrison. For a knowledge of this fact we are indebted to the apostle Paul. 'In Damascus the governor under Aretas the king kept the city of the Damascenes with a garrison, desirous to apprehend me; and through a window in a basket was I let down by the wall, and escaped his hands' (2 Cor. xi. 32, compared with Acts ix. 24). We are thus furnished with a chronological mark in the Apostle's history. From Gal. i. 18, it appears that Paul went up to Jerusalem from Damascus three years after his conversion. The emperor Tiberius died in A.D. 37; and as the affairs of Arabia were settled in the second year of Caligula, Damascus was then most probably reoccupied by the Romans. If, then, Paul's flight took place in A.D. 39, his conversion must have occurred in A.D. 36 (Neander's *History of the Planting of the Christian Church*, i. 107, English trans.; Lardner's *Credibility*, &c. Supplement, ch. xi.; *Works*, ed. 1835, v. 497).—

J. E. R.

ARGAZ (אָרְגָז; Sept. ῥέμα), the receptacle, called in the Authorized Version, a 'coffer' (1 Sam. vi. 8, 11, 15), which the Philistines placed beside the ark when they sent it home, and in which they deposited the golden mice and emeralds that formed their trespass-offering. Gesenius and Lee agree in regarding it as the same, or nearly the same thing, as the Arabian رجازة, *rijza*, which Jauhari describes as 'a kind of wal-

let, into which stones are put: it is hung to one of the two sides of the haudaj [a litter borne by a camel or mule] when it inclines towards the other.' Dr. Lee, however, thinks that the Hebrew word denotes the wallet itself; whereas Gesenius is of opinion that it means a *coffer* or small box, to which, from its analogous use, the same name was applied.

ARGOB (אָרְגוֹב; Sept. Ἀργόβ), a district in Bashan, east of the Lake of Gennesareth, which was given to the half-tribe of Manasseh (Deut. iii. 4, 13; 1 Kings iv. 13). The name Argob may be traced in *Ragab* or *Ragaba*, a city of the district (Joseph. *Antiq.* xiii. 18. 5; *Mishna*, tit. *Menachoth*, viii. 3), which Eusebius places 15 Roman miles west of Gerasa. Burckhardt supposed that he had found the ruins of this city in those of El Hossn, a remarkable but abandoned position on the east side of the lake (*Syria*, p. 279); but Mr. Bankes conceives this El Hossn to have been the site of Gamala (*Quarterly Review*, xxvi. 389).

1. ARIEL (אֲרִיאֵל; Sept. Ἀριάη), a word meaning 'lion of God,' and correctly enough rendered by 'lion-like,' in 2 Sam. xxiii. 20; 1 Chron. xi. 22. It was applied as an epithet of distinction to bold and warlike persons, as among the Arabians, who surmamed Ali 'The Lion of God.'

2. ARIEL. The same word is used as a local proper name in Isa. xxix. 1, 2, applied to Jerusalem—'as victorious under God'—says Dr. Lee; and in Ezek. xliv. 15, 16, to the altar of burnt-offerings. Here Gesenius and others, unsatisfied with the Hebrew, resort to the Arabic, and find the *Ari* in آفة *fire-hearth*, which, with אל *God*, supplies what they consider a more satisfactory signification. It is thus applied, in the first place, to the altar, and then to Jerusalem as containing the altar.

ARIMATHEA, the birth-place of the wealthy Joseph, in whose sepulchre our Lord was laid (Matt. xxvii. 57; John xix. 38). Luke (xxiii. 51) calls it 'a city of the Jews;' which may be



explained by 1 Macc. xi. 34, where King Demetrius thus writes—'We have ratified unto them [the Jews] the borders of Judæa, with the three governments of Aphereum, Lydda, and Ramathaim, that are added unto Judæa from the country of Samaria.' Eusebius (*Onomast.* s. v.) and Jerome (*Epit. Paulæ*) regard the Arimathea of Joseph as the same place as the Ramathaim of Samuel, and place it near Lydda or Diospolis. Hence it has by some been identified with the existing Ramleh, because of the similarity of the

name to that of Ramah (of which Ramathaim is the dual); and because it is near Lydda or Diospolis. Professor Robinson, however, disputes this conclusion on the following grounds—1. that Abulfeda alleges Ramleh to have been built after the time of Mohammed, or about A.D. 716, by Suleiman Abd-al Malik; 2. that Ramah and Ramleh have not the same signification; 3. that Ramleh is in a plain, while Ramah implies a town on a hill. To this it may be answered, that Abulfeda's statement may mean no more than that Suleiman *rebuilt* the town, which had previously been in ruins, just as Rehoboam and others are said to have *built* many towns which had existed long before their time; and that the Moslems seldom built towns but on old sites and out of old materials; so that there is not a town in all Palestine which is with certainty known to have been founded by them. In such cases they retained the old names, or others resembling them in sound, if not in signification, which may account for the difference between Ramah and Ramleh. Neither can we assume that a place called Ramah could not be in a plain, unless we are ready to prove that Hebrew proper names were *always* significant and appropriate. This they probably were not. They were so in early times, when towns were few; but not eventually, when towns were numerous, and took their names arbitrarily from one another without regard to local circumstances. Further, if Arimathea, by being identified with Ramah, was necessarily in the mountains, it could not have been 'near Lydda,' from which the mountains are seven miles distant. This matter, however, belongs more properly to another place [RAMAH; RAMATHAIM-ZOPHIM]; and it is alluded to here merely to show that Dr. Robinson's objections have not entirely destroyed the grounds for following the usual course of describing Ramleh as representing the ancient Arimathea.

Ramleh is in N. lat. $31^{\circ} 59'$, and E. long. $35^{\circ} 28'$, 8 miles S.E. from Joppa, and 24 miles N.W. by W. from Jerusalem. It lies in the fine undulating plain of Sharon, upon the eastern side of a broad low swell rising from a fertile though sandy plain. Like Gaza and Jaffa, this town is surrounded by olive-groves and gardens of vegetables and delicious fruits. Occasional palm-trees are also seen, as well as the kharob and the sycamore. The streets are few—the houses are of stone, and many of them large and well built. There are five mosques, two or more of which are said to have once been Christian churches; and there is here one of the largest Latin convents in Palestine. The place is supposed to contain about 3000 inhabitants, of whom two-thirds are Moslems, and the rest Christians, chiefly of the Greek church, with a few Armenians. The inhabitants carry on some trade in cotton and soap. The great caravan-road between Egypt and Damascus, Smyrna, and Constantinople passes through Ramleh, as well as the most frequented road for European pilgrims and travellers between Joppa and Jerusalem (Robinson, iii. 27; Raumer, p. 215). The tower, of which a figure is here given, is the most conspicuous object in or about the city. It stands a little to the west of the town, on the highest part of the swell of land; and is in the midst of a large quadrangular enclosure, which has much the appearance of having once been a

splendid khan. The tower is wholly isolated, whatever may have been its original destination.

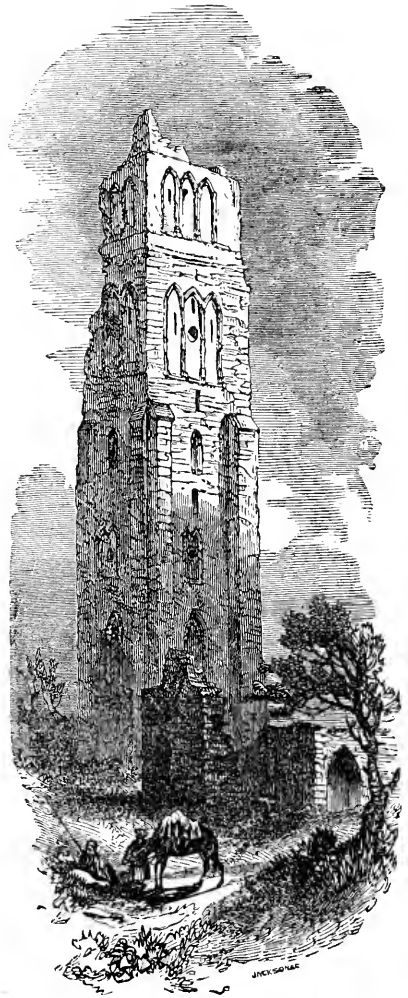

It is about 120 feet in height, of Saracenic architecture, square, and built with well-hewn stone. The windows are of various forms, but all have pointed arches. The corners of the tower are supported by tall slender buttresses; while the sides taper upwards by several stories to the top. It is of solid masonry, except a narrow staircase within, winding up to an external gallery, which is also of stone, and is carried quite round the tower a few feet below the top (Robinson, iii. 32). In the absence of any historical evidence that the enclosure was a khan, Dr. Robinson resorts to the Moslem account of its having belonged to a ruined mosque. The tower itself bears the date 718 A.H. (A.D. 1310), and an Arabian author (Mejr-ed-Din) reports the completion at Ramleh, in that year, of a minaret unique for its loftiness and grandeur, by the sultan

Egypt, Nazir Mohammed ibn Kelawan (Robinson, iii. 38; also Volney, ii. 281). Among the plantations which surrounded the town occur, at every step, dry wells, cisterns fallen in, and vast vaulted reservoirs, which show that the city must in former times have been upwards of a league and a half in extent (Volney, ii. 280).

The town is first mentioned under its present name by the monk Bernard, about A.D. 870. About A.D. 1150 the Arabian geographer Edrisi (ed. Jaubert, p. 339) mentions Ramleh and Jerusalem as the two principal cities of Palestine. The first Crusaders on their approach found Ramleh deserted by its inhabitants; and with it and Lydda they endowed the first Latin bishopric in Palestine, which took its denomination from the latter city. From the situation of Ramleh between that city and the coast, it was a post of much importance to the Crusaders, and they held possession of it generally while Jerusalem was in their hands, and long afterwards. In A.D. 1266 it was finally taken from the Christians by the Sultan Bibars. Subsequently it is often mentioned in the accounts of travellers and pilgrims, most of whom rested there on their way to Jerusalem. It seems to have declined very fast from the time that it came into the possession of the Crusaders. Benjamin of Tudela (*Itin.* p. 79, ed. Asher), who was there in A.D. 1173, speaks of it as having been formerly a considerable city. Belon (*Observat.* p. 311), in 1517, mentions it as almost deserted, scarcely twelve houses being inhabited, and the fields mostly untilled. This desertion must have occurred after 1457; for, *Le Grant Voyage de Hierusalem*, fol. xiv., speaks of it as a peopled town (though partly ruined), and of the 'seigneur de Rama' as an important personage. By 1674 it had somewhat revived, but it was still rather a large unwall'd village than a city, without any good houses, the governor himself being miserably lodged (Nau, *Voyage Nouveau*, liv. i. ch. 6). A century later it remained much in the same state, the governor being still ill-lodged, and the population scarcely exceeding 200 families (Volney, ii. 220). Its recent state must, therefore, indicate a degree of comparative prosperity, the growth of the present century.

ARISTARCHUS (Ἀριστάρχος), a faithful adherent of St. Paul, whose name repeatedly occurs in the Acts and Epistles (Acts xix. 29; xx. 4; xxvii. 2; Col. iv. 10; Philem. 24). He was a native of Thessalonica, and became the companion of St. Paul, whom he accompanied to Ephesus, where he was seized and nearly killed in the tumult raised by the silversmiths. He left that city with the Apostle, and accompanied him in his subsequent journeys, even when taken as a prisoner to Rome: indeed, Aristarchus was himself sent thither as a prisoner, or became such while there, for Paul calls him his 'fellow-prisoner' (Col. iv. 10). The traditions of the Greek church represent Aristarchus as bishop of Apamea in Phrygia, and allege that he continued to accompany Paul after their liberation, and was at length beheaded along with him at Rome in the time of Nero. The Roman martyrologies make him bishop of Thessalonica. But little reliance is to be placed on accounts which make a bishop of almost every one who happens to be named in the Acts and Epistles; and, in the case of Aristarchus, it is little likely that one who

constantly travelled about with St. Paul exercised any stationary office.

ARISTOBULUS (Ἀριστόβουλος), a person named by Paul in Rom. xvi. 10, where he sends salutations to his household. He is not himself saluted; hence he may not have been a believer, or he may have been absent or dead. Nothing certain is known respecting him. But tradition has not neglected him: it represents him as brother of Barnabas, and one of the seventy disciples, and alleges that he was ordained a bishop by Barnabas, or by Paul, whom he followed in his travels; and that he was eventually sent into Britain, where he laboured with much success, and where he at length died.

Aristobulus is a Greek name, adopted by the Romans, and in very common use among them. It was also adopted by the Jews, and was borne by several persons in the Maccabæan and Herodian families—viz. 1. ARISTOBULUS, son and successor of John Hyrcanus [MACCABEES]. 2. ARISTOBULUS, second son of Alexander Jannæus, and younger brother of Hyrcanus, with whom he disputed the succession by arms [MACCABEES]. 3. ARISTOBULUS, grandson of the preceding, and the last of the Maccabæan family, who was murdered by the contrivance of Herod the Great, B.C. 34 [MACCABEES]. 4. ARISTOBULUS, son of Herod the Great by Mariamne [HERODIAN FAMILY].

ARITHMETIC, or, as the word, derived from the Greek ἀριθμος, signifies, the science of numbers or reckoning, was unquestionably practised as an art in the dawn of civilization; since to put things, or their symbols, together (addition), and to take one thing from another (subtraction), must have been coeval with the earliest efforts of the human mind; and what are termed multiplication and division are only abbreviated forms of addition and subtraction. The origin, however, of the earliest and most necessary of the arts and sciences is lost in the shades of antiquity, since it arose long before the period when men began to take specific notice and make some kind of record of their discoveries and pursuits. In the absence of positive information we seem authorized in referring the first knowledge of arithmetic to the East. From India, Chaldea, Phœnicia, and Egypt, the science passed to the Greeks, who extended its laws, improved its processes, and widened its sphere. To what extent the Orientals carried their acquaintance with arithmetic cannot be determined. The greatest discovery in this department of the mathematics, namely, the establishment of our system of ciphers, or of figures considered as distinct from the letters of the alphabet, belongs undoubtedly not to Arabia, as is generally supposed, but to the remote East, probably India. It is to be regretted that the name of the discoverer is unknown, for the invention must be reckoned among the greatest of human achievements. Our numerals were made known to these western parts by the Arabians, who, though they were nothing more than the medium of transmission, have enjoyed the honour of giving them their name. These numerals were unknown to the Greeks, who made use of the letters of the alphabet for arithmetical purposes.

The Hebrews were not a scientific, but a religious and practical nation. What they borrowed from others of the arts of life they used without

surrounding it with theory or expanding and framing it into a system. So with arithmetic, by them called *מנה*, from a word signifying to determine, limit, and thence to number. Of their knowledge of this science little is known more than may be fairly inferred from the pursuits and trades which they carried on, for the successful prosecution of which some skill at least in its simpler processes must have been absolutely necessary; and the large amounts which appear here and there in the sacred books serve to show that their acquaintance with the art of reckoning was considerable. Even in fractions they were not inexperienced (Gesenius, *Lehrgeb.* p. 701). For figures, the Jews, after the Babylonish exile, made use of the letters of the alphabet, as appears from the inscriptions on the so-called Samaritan coins (Eckhel, *Doctr. Num.* i. iii. 468); and it is not unlikely that the ancient Hebrews did the same, as well as the Greeks, who borrowed their alphabet from the Phœnicians, neighbours of the Israelites, and employed it instead of numerals.—J. R. B.

ARK, NOAH'S (תֵּבָה *tebah*; Arab. *يَابوت*; Sept. *κιβωτός*, a chest; Joseph. *λάβραξ*, a coffer; Vulg. *arca*, Gen. vi. 14). The word here employed is different from that (אֲרוֹן *aron*) which is applied to the 'ark' of the covenant and other receptacles which we know to have been chests or coffers. But it is the same that is applied to the 'ark' in which Moses was hid (Exod. ii. 3), the only other part of Scripture in which it occurs. In the latter passage the Septuagint renders it *θίβη*, a ship, in the former, *κιβωτός*, a chest. The truth seems to be, that אֲרוֹן denotes any kind of chest or coffer: while the exclusive application of תֵּבָה to the vessels of Noah and of Moses, would suggest the probability that it was restricted to such chests or arks as were intended to float upon the water, of whatever description. The identity of the name with that of the wicker basket in which Moses was exposed on the Nile, has led some to suppose that the ark of Noah was also of wicker-work, or rather was wattled and smeared over with bitumen (Auth. Vers. 'pitch,' Gen. vi. 14). This is not impossible, seeing that vessels of considerable burthen are thus constructed at the present day; but there is no sufficient authority for carrying the analogy to this extent.

Vast labour and ingenuity have been employed by various writers, in the attempt to determine the form of Noah's ark and the arrangement of its parts. The success has not been equal to the exertion; for, on comparing the few simple facts in the Scripture narrative, every one feels how slight positive data there are for the minute descriptions and elaborate representations which such writers have given. That form of the ark which repeated pictorial representations have rendered familiar—a kind of house in a kind of boat—has not only no foundation in Scripture, but is contrary to reason. The form thus given to it is fitted for progression and for cutting the waves; whereas the ark of Noah was really destined to float idly upon the waters, without any other motion than that which it received from them. If we examine the passage in Gen. vi. 14-16, we can only draw from it the conclusion that the ark was not a boat or ship; but, as Professor Robinson describes it, 'a building in the form of a

parallelogram, 300 cubits long, 50 cubits broad, and 30 cubits high. The length of the cubit, in the great variety of measures that bore this name, it is impossible to ascertain and useless to conjecture. So far as the name affords any evidence, it also goes to show that the ark of Noah was not a regularly-built vessel, but merely intended to float at large upon the waters. We may, therefore, probably with justice, regard it as a large, oblong, floating house, with a roof either flat or only slightly inclined. It was constructed with three stories, and had a door in the side. There is no mention of windows in the side, but above, *i. e.* probably in the flat roof, where Noah was commanded to make them of a cubit in size (Gen. vi. 16). That this is the meaning of the passage seems apparent from Gen. viii. 13, where Noah removes the covering of the ark in order to ascertain whether the ground was dry; a labour unnecessary surely, had there been windows in the sides of the ark' (Add. to *Calmet's Dict.* s. v. ARK).

The purpose of this ark was, to preserve certain persons and animals from the Deluge with which God intended to overwhelm the land, in punishment for man's iniquities. The persons were eight—Noah and his wife, with his three sons and their wives (Gen. vii. 7; 2 Pet. ii. 5). The animals were, one pair of every 'unclean' animal, and seven pairs of all that were 'clean.' By 'clean,' we understand fit, and by 'unclean,' unfit for food or for sacrifice. Of birds there were seven pairs (Gen. vii. 2, 3). Those who have written professedly and largely on the subject, have been at great pains to provide for all the existing species of animals in the ark of Noah, showing how they might be distributed, fed, and otherwise provided for. But they are very far from having cleared the matter of all its difficulties; which are much greater than they, in their general ignorance of natural history, were aware of. These difficulties, however, chiefly arise from the assumption that the species of all the earth were collected in the ark. The number of such species has been vastly underrated by these writers—partly from ignorance, and partly from the desire to limit the number for which they imagined they required to provide. They have usually satisfied themselves with a provision for three or four hundred species at most. 'But of the existing mammalia considerably more than one thousand species are known; of birds, fully five thousand; of reptiles, very few kinds of which can live in water, two thousand; and the researches of travellers and naturalists are making frequent and most interesting additions to the number of these and all other classes. Of insects (using the word in the popular sense) the number of species is immense; to say one hundred thousand would be moderate; each has its appropriate habitation and food, and these are necessary to its life; and the larger number could not live in water. Also the innumerable millions upon millions of animalcules must be provided for; for they have all their appropriate and diversified places and circumstances of existence' (Dr. J. Pye Smith, *On the Relation between the Holy Scriptures and some Parts of Geological Science*, p. 135). Nor do these numbers form the only difficulty; for, as the same writer observes:—'All land animals have their

geographical regions, to which their constitutional natures are congenial, and many could not live in any other situation. We cannot represent to ourselves the idea of their being brought into one small spot, from the polar regions, the torrid zone, and all the other climates of Asia, Africa, Europe, America, Australia, and the thousands of islands, their preservation and provision, and the final disposal of them, without bringing up the idea of miracles more stupendous than any which are recorded in Scripture.

These are some of the difficulties which arise on the supposition that all the species of animals existing in the world were assembled together and contained in the ark. And if the object, as usually assumed, was to preserve the species of creatures which the Deluge would otherwise have destroyed, the provision for beasts and birds only, must have been altogether inadequate. What then would have become of the countless reptiles, insects, and animalcules to which we have already referred? and it is not clear that some provision must not also have been necessary for fishes and shell animals, many of which cannot live in fresh water, while others cannot live in salt.

The difficulty of assembling in one spot, and of providing for in the ark, the various mammalia and birds alone, even without including the otherwise essential provision for reptiles, insects, and fishes, is quite sufficient to suggest some error in the current belief. We are to consider the different kinds of accommodation and food which would be required for animals of such different habits and climates, and the necessary provision for ventilation and for cleansing the stables or dens. And if so much ingenuity has been required in devising arrangements for the comparatively small number of species which the writers on the ark have been willing to admit into it; what provision can be made for the immensely larger number which, under the supposed conditions, would really have required its shelter?

There seems no way of meeting these difficulties but by adopting the suggestion of Bishop Stillingfleet, approved by Matthew Poole, Dr. J. Pye Smith, Le Clerc, Rosenmüller, and others, namely, that, as the object of the Deluge was to sweep man from the earth, it did not extend beyond that region of the earth which man then inhabited, and that only the animals of that region were preserved in the ark. The question, as regards the universality of the Deluge, will be considered elsewhere [DELUGE]; and for the portion of the matter involved in the present inquiry, we must be content to produce the sentiments of Bishop Stillingfleet, who wrote in plain soberness long before geology was known as a science, and when, therefore, those discoveries were altogether unthought of by which, in our day, such warm controversies have been excited. The bishop expresses his belief that the Flood was universal as to mankind, and that all men, except those preserved in the ark, were destroyed; but he sees no evidence from Scripture that the whole earth was then inhabited; he does not think that it can ever be proved to have been so; and he asks, what reason there can be to extend the Flood beyond the occasion of it? He grants that, as far as the Flood extended, all the animals were destroyed; 'but,' he adds, 'I see no reason to extend the destruction of these beyond the compass of the earth which men

then inhabited; the punishment of the beasts was occasioned by, and could not but be concomitant with, the destruction of mankind. But (the occasion of the Deluge being the sin of man, who was punished in the beasts that were destroyed for his sake, as well as in himself) where the occasion was not, as where there were animals and no men, there seems no necessity for extending the Flood thither' (*Origines Sacrae*, b. iii. ch. iv.). The bishop further argues that the reason for preserving living creatures in the ark was, that there might be a stock of the tame and domesticated animals that should be immediately 'serviceable for man after the flood: which was certainly the main thing looked at in the preservation of them in the ark, that men might have all of them ready for use after the Flood; which could not have been, had not the several kinds been preserved in the ark, although we suppose them not destroyed in all parts of the world.'

As Noah was the progenitor of all the nations of the earth, and as the ark was the second cradle of the human race, we might expect to find in all nations traditions and reports more or less distinct respecting him, the ark in which he was saved, and the Deluge in general. Accordingly no nation is known in which such traditions have not been found. They have been very industriously brought together by Banier, Bryant, Faber, and other mythologists [DELUGE; NOAH]. Our present concern is only with the ark. And as it appears that an ark, that is, a boat or chest, was carried about with great ceremony in most of the ancient mysteries, and occupied an eminent station in the holy places, it has with much reason been concluded that this was originally intended to represent the ark of Noah, which eventually came to be regarded with superstitious reverence. On this point the historical and mythological testimonies (as collected in the authors to whom we have referred) are very clear and conclusive. The tradition of a deluge, by which the race of man was swept from the face of the earth, has been traced among the Chaldeans, Egyptians, Phœnicians, Assyrians, Persians, Greeks, Romans, Goths, Druids, Chinese, Hindoos, Burmese, Mexicans, Peruvians, Brazilians, Nicaraguans, the inhabitants of Western Caledonia, and the islanders of the Pacific; and among most of them also the belief has prevailed that certain individuals were preserved in an ark, ship, boat, or raft, to replenish the desolated earth with inhabitants. Nor are these traditions uncorroborated by coins and monuments of stone. Of the latter there are the sculptures of Egypt and of India; and, as hinted in a previous article [ALTAR], it is not unlikely that those of the monuments called Druidical, which bear the name of kist-vaens, and in which the stones are

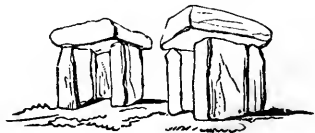

disposed in the form of a chest or house, were intended as memorials of the ark. At least, it has been shown by Davis (*Celtic Researches*) that

the ark was not only typified among the Celts by rafts and islands, but by a stone ark or chest, which is precisely the meaning of *kist* (chest) *væn*.

Being anxious to touch as lightly as possible upon the vast and curious subject of Arkite worship, we shall confine our medallic illustrations to the two famous medals of Apamea. There were six cities of this name, of which the most celebrated was that of Syria; next to it, in importance, was the one in Phrygia, called also *Kιβωτός*, *Kibotos*, which, as we have seen, means an ark or hollow vessel. This latter city was built on the river Marsyas; and there seems to have been a notion that the ark rested on the adjoining hills of Celænæ: and the Sibylline oracles, wherever they were written, also include these hills under the name of Ararat, and mention the same tradition. The medals in question belong, the one to the elder Philip, and the other to Pertinax. In the former it is extremely interesting to observe that on the front of the ark is the name of Noah, ΝΩΕ, in



Greek characters. The designs on these medals correspond remarkably, although the legends somewhat vary. In both we perceive the ark floating on the water, containing the patriarch and his wife, the dove on wing, the olive-branch, and the raven perched on the ark. These medals also represent Noah and his wife on *terra firma*, in the attitude of rendering thanks for their safety. On the pannel of the ark, in the coin of Pertinax, is the word ΝΗΤΩΝ, perhaps a provincialism for *Nḥos*, 'an island,' or *Néw*, 'to revive.' On the exergue of the same medal we read distinctly ΑΠΑΜΕΩΝ, as we do also in that of the other, the first syllable terminating the first line. The genuineness of these medals has been established beyond all question by the researches of Bryant and the critical inspection of Abbé Barthélémy. There is another medal, struck in honour of the emperor Hadrian, which bears the inscription ΑΠΑΜΕΩΝ

ΚΙΒΩΤΟΣ ΜΑΡΣΥΣΙΑ, 'the ark and the marsyas of the Apameans.' The coincidences which these medals offer are at least exceedingly curious; and they are scarcely less illustrative of the prevailing belief to which we are referring, if, as some suppose, the figures represented are those of Deucalion and Pyrrha.

ARK OF THE COVENANT (אֲרוֹן; Sept. and New Test. *κιβωτός*). The word here used for ark is, as already explained, different from that which is applied to the ark of Noah. It is the common name for a chest or coffer, whether applied to the ark in the tabernacle, to a coffin, to a mummy-chest (Gen. 1. 26), or to a chest for money (2 Kings xii. 9, 10). Our word *ark* has the same meaning, being derived from the Latin *arca*, a chest. The distinction between *aron* and the present word has already been suggested. The sacred chest is distinguished from others as אֲרוֹן אֱלֹהִים the 'ark of God' (1 Sam. iii. 3); אֲרוֹן הַבְּרִית 'ark of the covenant' (Josh. iii. 6); and אֲרוֹן הָעֵדוּת 'ark of the law' (Exod. xxv. 22). This ark was a kind of chest, of an oblong shape, made of slittim (acacia) wood, a cubit and a half broad and high, two cubits long, and covered on all sides with the purest gold. It was ornamented on its upper surface with a border or rim of gold; and on each of the two sides, at equal distances from the top, were two gold rings, in which were placed (to remain there perpetually) the gold-covered poles by which the ark was carried, and which continued with it after it was deposited in the tabernacle. The lid or cover of the ark (כַּסֵּיתָא, *λαστήριον*, *ἐπίθημα*) was of the same length and breadth, and made of the purest gold. Over it, at the two extremities, were two cherubim, with their faces turned towards each other, and inclined a little towards the lid (otherwise called the *mercy-seat*). Their wings, which were spread out over the top of the ark, formed the throne of God, the King of Israel, while the ark itself was his footstool (Exod. xxv. 10-22; xxxvii. 1-9).

This ark was the most sacred object among the Israelites: it was deposited in the innermost and holiest part of the tabernacle, called 'the holy of holies' (and afterwards in the corresponding apartment of the Temple), where it stood so that one end of each of the poles by which it was carried (which were drawn out so far as to allow the ark to be placed against the back wall), touched the veil which separated the two apartments of the tabernacle (1 Kings viii. 8). In the ark were deposited the tables of the law (Exod. xxv. 16). A quantity of manna was laid up beside the ark in a vase of gold (Exod. xvi. 32, 36; 1 Kings viii. 9); as were also the rod of Aaron (Num. xvii. 10), and a copy of the book of the law (Deut. xxxi. 26).

Nothing is more apparent throughout the historical Scriptures than the extreme sanctity which attached to the ark, as the material symbol of the Divine presence. During the marches of the Israelites it was covered with a purple pall, and borne in advance of the host (Num. iv. 5, 6; x. 33). It was before the ark, thus in advance, that the waters of the Jordan separated; and it remained in the bed of the river, with the attendant priests until the whole host had passed over; and α.

sooner was it also brought up than the waters resumed their course (Josh. iii.; iv. 7, 10, 11, 17, 18). The ark was similarly conspicuous in the grand procession round Jericho (Josh. vi. 4, 6, 8, 11, 12). It is not wonderful therefore that the neighbouring nations, who had no notion of spiritual worship, looked upon it as the God of the Israelites (1 Sam. iv. 6, 7), a delusion which may have been strengthened by the figures of the cherubim on it. After the settlement of the Jews in Palestine, the ark remained in the tabernacle at Shiloh, until, in the time of Eli, it was carried along with the army in the war against the Philistines, under the superstitious notion that it would secure the victory to the Hebrews. They were, however, not only beaten, but the ark itself was taken by the Philistines (1 Sam. iv. 3-11), whose triumph was, however, very short lived, as they were so oppressed by the hand of God, that, after seven months, they were glad to send it back again (1 Sam. v. 7). After that it remained apart from the tabernacle, at Kirjath-jearim (vii. 1, 2), where it continued until the time of David, who purposed to remove it to Jerusalem; but the old prescribed mode of removing it from place to place was so much neglected as to cause the death of Uzzah, in consequence of which it was left in the house of Obedom (2 Sam. vi. 1-11); but after three months David took courage, and succeeded in effecting its safe removal, in grand procession, to Mount Zion (ver. 12-19). When the Temple of Solomon was completed, the ark was deposited in the sanctuary (1 Kings viii. 6-9). The passage in 2 Chron. xxxv. 3, in which Josiah directs the Levites to restore the ark to the holy place, is understood by some to imply that it had either been removed by Amon, who put an idol in its place, which is assumed to have been the 'trespass' of which he is said to have been guilty (2 Chron. xxxiii. 23); or that the priests themselves had withdrawn it during idolatrous times, and preserved it in some secret place, or had removed it from one place to another. But it seems more likely that it had been taken from the holy of holies during the purification and repairs of the Temple by this same Josiah, and that he, in this passage, merely directs it to be again set in its place. What became of the ark when the Temple was plundered and destroyed by the Babylonians is not known, and all conjecture is useless. The Jews believe that it was concealed from the spoilers, and account it among the hidden things which the Messiah is to reveal. It is certain, however, from the consent of all the Jewish writers, that the old ark was not contained in the second temple, and there is no evidence that any new one was made. Indeed the absence of the ark is one of the important particulars in which this temple was held to be inferior to that of Solomon. The most holy place is therefore generally considered to have been empty in the second temple (as Josephus states, *De Bell. Jud.* v. 14); or at most (as the Rabbins allege) to have contained only a stone to mark the place which the ark should have occupied. The silence of Ezra, Nehemiah, the Maccabees, and Josephus, who repeatedly mention all the other sacred utensils, but never name the ark, seems conclusive on the subject. But notwithstanding this weight of testimony, there are writers, such as Prideaux (*Connection*, i. p. 207), who contend that the Jews

could not properly carry on their worship without an ark, and that if the original ark was not recovered after the Captivity, a new one must have been made. This matter is fully investigated in Calmet's *Dissertation sur l'Arche d'Alliance*.

We now come to consider the design and form of the ark, on which it appears to us that clear and unexpected light has been thrown by the discoveries which have of late years been made in Egypt, and which have unfolded to us the rites and mysteries of the old Egyptians. The subject may be opened in the following words, from the two volumes on the *Religion and Agriculture of the Ancient Egyptians*, which have been published by Sir J. G. Wilkinson since we first had occasion to notice this subject (see *Pictorial Hist. of Palestine*, pp. 247-250):—'One of the most important ceremonies was the "procession of shrines," which is mentioned in the Rosetta stone, and frequently occurs on the walls of the temples. The shrines were of two kinds: the one a sort of canopy; the other an ark or sacred boat, which may be termed the great shrine. This was carried with grand pomp by the priests, a certain number being selected for that duty, who supported it on their shoulders by means of long staves, passing through metal rings at the side of the sledge on which it stood, and brought it into the temple, where it was deposited upon a stand or table, in order that the prescribed ceremonies might be discharged before it. The stand was also carried in procession by another set of priests, following the shrine, by means of similar staves; a method usually adopted for carrying large statues and sacred emblems, too heavy or too important to be borne by one person. The same is stated to have been the custom of the Jews in some of their religious processions (comp. 1 Chron. xv. 2, 15; 2 Sam. xv. 24; and Josh. iii. 12), as in carrying the ark to its place, into the oracle of the house, to the most holy place, when the Temple was built by Solomon (1 Kings viii. 6). . . . Some of the arks or boats contained the emblems of Life and Stability, which, when the veil was drawn aside, were partially seen; and others presented the sacred beetle to the sun, overshadowed by the wings of two figures of the goddess Thenei, or Truth, which call to mind the cherubim of the Jews' (*Anc. Egyptians*, v. pp. 271, 275).

In reading this passage, more points of resemblance than occurred to Sir J. G. Wilkinson will strike the Biblical student, and will attract his close attention to the subject. In the above description three objects are distinguished:—1. The 'stand'; 2. The boat or 'ark'; 3. The 'canopy.' This last is not, as the extract would suggest, an alternative for the second; but is most generally seen with and in the boat. This is shown in the first cut, which exhibits all the parts together, and at rest.

The points of resemblance to the Jewish ark in the second cut are many and conspicuous: as, in the 'stand,' which, in some of its forms, and leaving out the figures represented on the sides, bears so close a resemblance to the written description of the Hebrew ark, that it may safely be taken as an authentic illustration of its form. Then the cherubim of the Hebrew ark find manifest representatives in the figures facing each other, with wings spread inwards and meeting

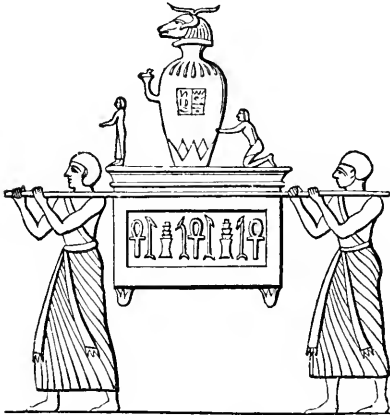
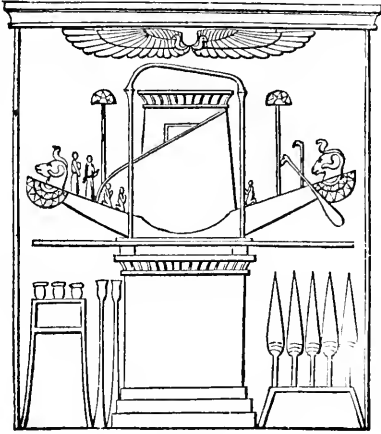

each other, which we find within a canopy or shrine which sometimes rests immediately upon this 'stand,' but more generally in the boat, which itself rests thereon. These are shown in



the annexed cut (3), in which the winged figures are, in their position, if not in their form, remarkably analogous. We direct attention also to the hovering wings above, which are very conspicuous in all such representations. This part of the subject is interesting; but, as it will obtain separate attention [CHERUBIM], we omit particular notice of it here. Other analogies occur in the persons who bear the shrine—the priests; and

in the mode of carrying it, by means of poles inserted in rings; and it is observable that, as in the Hebrew ark, these poles were not withdrawn, but remained in their place when the shrine was at rest in the temple. Such are the principal resemblances. The chief difference is, the entire absence, in the Jewish ark, of the boat, in which most of the idolatrous objects were assembled. There are, indeed, circumstances which might suggest the idea that the 'mercy-seat' was not, as commonly supposed, the lid of the ark, but such a covering or canopy as we see in the Egyptian shrines. The ground relied upon as showing that it was the lid, namely, that its dimensions were the same as those of the ark, applies equally to the canopy, the bottom of which is usually of the same dimensions as the top of the stand or chest which answers to the Jewish ark. The fact, however, that the cherubim stood upon the mercy-seat, seems to show that it was the lid, and not the canopy; and the absence of this must therefore be taken as another difference. To show the effect of these conclusions, we take the stand, as already represented (in cut 2), and we place thereon, without alteration (but without the canopy), the winged figures as they appear in

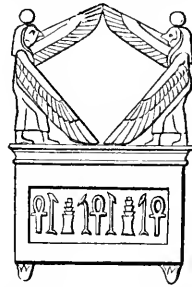

an Egyptian shrine (the same as in cut 3); and we need not point out that the representation, thus formed without any alteration of the parts, affords a most striking resemblance to one of the two forms of the ark with the cherubim above, which scholars and artists, wholly unacquainted with Egyptian antiquities, have drawn from the descriptions of the Jewish ark which we find in Exodus, as represented in the annexed cut (5).



Again, we take the same ark, and place thereon the figures of another shrine (6); and we com-

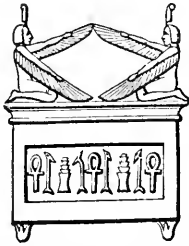

Compare this with another of the common forms of the Jewish ark as drawn from the descriptions (7).

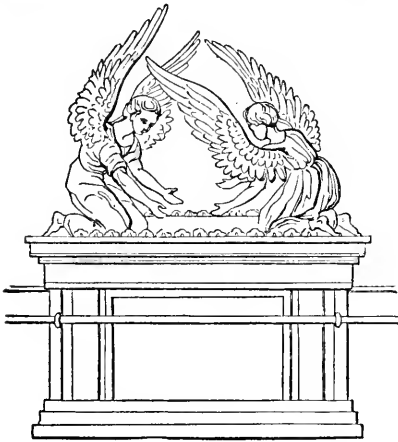

These resemblances and differences appear to us to cast a strong light, not only on the form, but on the purpose of the Jewish ark. The discoveries of this sort which have lately been made in Egypt, have added an overwhelming weight of proof to the evidence which previously existed, that the 'tabernacle made with hands,' with its utensils and ministers, bore a designed external resemblance to the Egyptian models; but purged of the details and peculiarities which were the most open to abuse and misconstruction. That the Israelites during the latter part of their sojourn in Egypt followed the rites and religion of the country, and were (at least many of them) gross idolaters, is distinctly affirmed in Scripture (Josh. xxiv. 14; Ezek. xxiii. 3, 8, 19); and is shown by their ready lapse into the worship of the 'golden calf;' and by the striking fact that they actually carried about with them one of these Egyptian shrines or tabernacles in the wilderness (Amos v. 26). From their conduct and the whole tone of their sentiments and character it appears that this stiff-necked and rebellious people were incapable (as a nation) of adhering to that simple form of worship and service which is most pleasing to God.

The parts of the Egyptian shrine which are omitted in the ark are the *boat* and the *canopy*: the boat, probably because it was not only intimately connected by its very form with the Arkite worship, to which the previous article alludes, but because

it was the part which was absolutely crowded with idolatrous images and associations; and the canopy, probably because it often shrouded the image of a god, whereas its absence made it manifest that only the symbolic cherubim rested on the ark. The parts retained were the stand or chest, which was not an object of idolatrous regard even among the Egyptians, and the winged figures, which were purely symbolical, and not idolatrous representations.

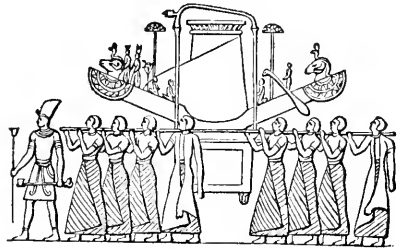

ARKITES (אַרְכִיטִים; Sept. Ἀρκαῖος), the inhabitants of Arka, mentioned in Gen. x. 17; 1 Chron. i. 15, as descended from the Phœnician or Sidonian branch of the great family of Canaan. This, in fact, as well as the other small northern states of Phœnicia, was a colony from the great parent state of Sidon. Arka, or Akra, their chief town, lay between Tripolis and Antaradus, at the western base of Lebanon (Joseph. *Antiq.* i. 6. 2; Jerome, *Quest. in Gen.* x. 15). Josephus (*Antiq.* viii. 2. 3) makes Baanah—who in 1 Kings iv. 16, is said to have been superintendent of the tribe of Asher—governor of Akra by the sea; and if, as commonly supposed, the capital of the Arkites is intended, their small state must, in the time of Solomon, have been under the Hebrew yoke. Subsequently Akra shared the lot of the other small Phœnician states in that quarter; but in later times it formed part of Herod Agrippa's kingdom. The name and site seem never to have been unknown, although for a time it bore the name of Cæsarea Lebani from having been the birth-place of Alexander Severus (Mannert, p. 391). It is repeatedly mentioned by the Arabian writers (Michaelis, *Spicil.* pt. ii. p. 23; Schultens, *Vita Saladini*; Abulfeda, *Tab. Syriae*, p. 11). It lay 32 R. miles from Antaradus, 18 miles from Tripoli, and, according to Abulfeda, a parasang from the sea. In a position corresponding to these intimations, Shaw (*Observat.* p. 270), Burckhardt (*Syria*, p. 162), and others noticed the site and ruins. Burckhardt, in travelling from the north-east of Lebanon to Tripoli, at the distance of about four miles south of the Nahr-el-kebir (Eleutherus), came to a hill called Tel-Arka, which, from its regularly flattened conical form and smooth sides, appeared to be artificial. He was told that on its top were some ruins of habitations and walls. Upon an elevation on its east and south sides, which commands a beautiful view over the plain, the sea, and the Anzeyry mountains, are large and extensive heaps of rubbish, traces of ancient dwellings, blocks of hewn stone, remains of walls, and fragments of granite columns. These are no doubt the remains of Arka; and the hill was probably the acropolis or citadel, or the site of a temple.

ARM. This word is frequently used in Scripture in a metaphorical sense to denote power. Hence, to 'break the arm' is to diminish or destroy the power (Ps. x. 15; Ezek. xxx. 21; Jer. xlviii. 25). It is also employed to denote the infinite power of God (Ps. lxxxix. 13; xlviii. 2; Isa. liii. 1; John xii. 38). In a few places the metaphor is, with great force, extended to the action of the arm, as:—'I will redeem you with a stretched out arm' (Exod. vi. 5), that is, with a power fully exerted. The figure is here taken from the attitude of ancient warriors baring and outstretching the arm for fight. Thus in Isa. lii. 10, 'Jehovah hath made bare his holy arm in the sight of all the nations.' Bishop Louth has shown, from the Sept. and other versions, that in Isa. ix. 20, 'they shall eat every one the flesh of his own arm,' similar to 'the flesh of his neighbour,' similar to Jer. xix. 9, meaning that they should harass and destroy one another. (See Wemyss's *Clavis Symbolica*, pp. 23, 24.)

ARMAGEDDON, properly 'the mountain of Megiddo,' a city on the west of the river Jordan, rebuilt by Solomon (1 Kings ix. 15). Both Abaziah and Josias died there. In the mystical language of prophecy, the word mountain represents the Church, and the events which took place at Megiddo are supposed to have had a typical reference to the sorrows and triumphs of the people of God under the gospel. 'In that day,' says Zechariah, xii. 11, 'shall there be a great mourning in Jerusalem, as the mourning of Hadadrimmon in the valley of Megiddon;' referring to the death of Josias. But the same spot witnessed, at an earlier period, the greatest triumph of Israel, when 'fought the kings of Canaan in Taanach by the waters of Megiddo' (Judg. v. 19). 'He gathered them together into a place called in the Hebrew tongue Armageddon,' is the language of the Apocalypse; and the word has been translated by some as 'the mountain of destruction,' by others as 'the mountain of the gospel;' many ingenious speculations having been employed on the passage in which it occurs, but with little satisfaction to the more sober readers of divine revelation.—H. S.

ARMENIA, a country of Western Asia, is not mentioned in Scripture under that name, but is supposed to be alluded to in the three following Hebrew designations, which seem to refer either to the country as a whole, or to particular districts. I. *Ararat* אֲרָרָט, the land upon (or over) the mountains of which the ark rested at the Deluge (Gen. viii. 4); whither the sons of Senacherib fled after murdering their father (2 Kings xix. 37; Isa. xxxvii. 38); and one of the 'kingdoms' summoned, along with Minni and Ashkenaz, to arm against Babylon (Jer. li. 27). That there was a province of Ararat in ancient Armenia, we have the testimony of the native historian, Moses of Chorene. It lay in the centre of the kingdom, was divided into twenty circles, and, being the principal province, was commonly the residence of the kings or governors. For other particulars respecting it, and the celebrated mountain which in modern times bears its name, see the article ARARAT. II. *Minni* מִנִּי is mentioned in Jer. li. 27, along with Ararat and Ashkenaz, as a kingdom called to arm itself against Babylon. The name is by some taken for a contraction of 'Armenia,' and the Chald. in the

text in Jeremiah has הוֹרְמִינִי. There appears a trace of the name Minni in a passage quoted by Josephus (*Antiq.* i. 3. 6) from Nicolas of Damascus, where it is said that 'there is a great mountain in Armenia, ὑπὲρ τῆν Μιννῶδα, called Baris, upon which it is reported that many who fled at the time of the Deluge were saved; and that one who was carried in an ark came on shore upon the top of it; and that the remains of the timber were a great while preserved. This might be the man about whom Moses, the legislator of the Jews, wrote.' Saint-Martin, in his erudite work entitled *Mémoires sur l'Arménie* (vol. i. p. 219), has the not very probable conjecture that the word 'Minni' may refer to the Manavazians, a distinguished Armenian tribe, descended from Manavaz, a son of Haik, the capital of whose country was Manavazagerd, now Melazgerd. In Ps. xlv. 8, where it is said 'out of the ivory palaces wheremy they made thee glad,' the Hebrew word rendered 'wheremy' is *minni*, and hence some take it for the proper name, and would translate 'palaces of Armenia,' but the interpretation is forced and incongruous. III. *Thogarmah* תְּהוֹגַרְמָה, in some MSS. *Thorgamah*, and found with great variety of orthography in the Septuagint and Josephus. In the ethnographic table in the tenth chapter of Genesis (ver. 3; comp. 1 Chron. i. 6) Thogarmah is introduced as the youngest son of Gomer (son of Japhet), who is supposed to have given name to the Cimmerians on the north coast of the Euxine Sea, his other sons being Ashkenaz and Riphath, both progenitors of northern tribes, among whom also it is natural to seek for the posterity of Thogarmah. The prophet Ezekiel (xxxviii. 6) also classes along with Gomer 'the house of Thogarmah and the sides of the north' (in the Eng. Vers. 'of the north quarters'), where, as also at Ezek. xxvii. 14, it is placed beside Meshech and Tubal, probably the tribes of the Moschi and Tibareni in the Caucasus. Now, though Josephus and Jerome find Thogarmah in Phrygia, Bochart in Cappadocia, the Chaldee and the Jewish rabbins in Germany, &c.; yet a comparison of the above passages leads to the conclusion that it is rather to be sought for in Armenia, and this is the opinion of Eusebius, Theodoret, and others of the fathers. It is strikingly confirmed by the traditions of that and the neighbouring countries. According to Moses of Chorene (Whiston's edition, i. 8, p. 24), and also King Wachtang's *History of Georgia* (in Klaproth's *Travels in the Caucasus*, vol. ii. p. 64), the Armenians, Georgians, Lesghians, Mingrelians, and Caucasians are all descended from one common progenitor, called Thargamos, a son of Awanan, son of Japhet, son of Noah (comp. Eusebius, *Chron.* ii. 12). After the dispersion at Babel, he settled near Ararat, but his posterity spread abroad between the Caspian and Euxine seas. A similar account is found in a Georgian chronicle, quoted by another German traveller, Guldenstedt, which states that Targamos was the father of eight sons, the eldest of whom was Aos, the ancestor of the Armenians. They still call themselves 'the house of Thorgom,' the very phrase used by Ezekiel, *בית תְּהוֹרְמָה*, the corresponding Syriac word for 'house' denoting 'land or district.' From the house or province of Thogarmah the market of Tyre was supplied with horses and mules (Ezek. xxvii. 14); and Armenia, we know, was famed

of old for its breed of horses. The Satrap of Armenia sent yearly to the Persian court 20,000 foals for the feast of Mithras (Strabo, xi. 13. 9; Xenoph. *Anabas.* iv. 5. 21; Herod. vii. 40).

The 'Αρμενία of the Greeks (sometimes aspi-rated 'Αρμενία) is the *Arminiya* or *Irminiya* of the Arabs, the *Ermenistan* of the Persians. Moses of Chorene derives the name from Armenagh, the second of the native princes; Hartmann draws it from Aram (see that article), a son of Shem, who also gave name to Aramæa or Syria; but the most probable etymology is that of Bochart, *viz.*, that it was originally מִנִּי הַר, Har-Minni or Mount Minni, *i. e.* the High-land of Minyas, or, according to Wahl (in his work on Asia, p. 807), the Heavenly Mountain (*i. e.* Ararat), for *mino* in Zend, and *myno*, *myny*, in Parsee, signify 'heaven, heavenly.' In the country itself the name Armenia is unknown; the people are called Haik, and the country Hayotz-zor, the Valley of the Haiks—from Haik, the fifth descendant of Noah by Japhet, in the traditional genealogy of the country (comp. Ritter's *Erdkunde*, th. ii. p. 711).

The boundaries of Armenia may be described generally as the southern range of the Caucasus on the north, and a branch of the Taurus on the south; but in all directions, and especially to the east and west, the limits have been very fluctuating. It forms an elevated table-land, whence rise mountains which (with the exception of the gigantic Ararat) are of moderate height, the plateau gradually sinking towards the plains of Irân on the east, and those of Asia Minor on the west. The climate is generally cold, but salubrious. The country abounds in romantic forest and mountain scenery, and rich pasture-land, especially in the districts which border upon Persia. Ancient writers notice the wealth of Armenia in metals and precious stones. The great rivers Euphrates and Tigris both take their rise in this region, as also the Araxes, and the Kur or Cyrus. Armenia is commonly divided into *Greater* and *Lesser*, the line of separation being the Euphrates; but the former constitutes by far the larger portion, and indeed the other is often regarded as pertaining rather to Asia Minor. There was anciently a kingdom of Armenia, with its metropolis Artaxata: it was sometimes an independent state, but most commonly tributary to some more powerful neighbour. Indeed at no period was the whole of this region ever comprised under one government, but Assyria, Media, Syria, and Cappadocia shared the dominion or allegiance of some portion of it, just as it is now divided among the Persians, Russians, Turks, and Kurds; for there is no doubt that that part of Kurdistan which includes the elevated basins of the lakes of Van and Oormiah anciently belonged to Armenia. The unfortunate German traveller Schulz (who was murdered by a Kurdish chief) discovered in 1827, near the former lake, the ruins of a very ancient town, which he supposed to be that which is called by Armenian historians *Shamiramakert* (*i. e.* the town of Semiramis), because believed to have been built by the famous Assyrian queen. The ruins are covered with inscriptions in the arrow-headed character; in one of them Saint-Martin thought he deciphered the words *Kishêarsha* son of *Darbioush* (Xerxes son of Darius). In later times Armenia

was the border-country where the Romans and Parthians fruitlessly strove for the mastery; and since then it has been the frequent battle-field of the neighbouring states. Towards the end of the last war between Russia and Turkey, large bodies of native Armenians emigrated into the Russian dominions, so that their number in what is termed Turkish Armenia is now considerably reduced. By the treaty of Turkomanshee (21st Feb. 1828) Persia ceded to Russia the Khanats of Erivan and Nakhshivan. The boundary-line (drawn from the Turkish dominions) passes over the Little Ararat; the line of separation between Persian and Turkish Armenia also begins at Ararat; so that this famous mountain is now the central boundary-stone of these three empires.

Christianity was first established in Armenia in the fourth century; the Armenian church has a close affinity to the Greek church in its forms and polity; it is described by the American missionaries who are settled in the country as in a state of great corruption and debasement. The total number of the Armenian nation throughout the world is supposed not to exceed 2,900,000. Their favourite pursuit is commerce, and their merchants are found in all parts of the East. For the *history* of the country, see Moses of Chorene, Father Chamich, and the *Hist. of Vartan*, translated by Neumann. For the *topography*, Morier, Ker Porter, Smith and Dwight, Southgate, &c., and especially the vols. of the *Journal of the Geographical Society*, containing the researches of Monteith, Ainsworth, and others.—N. M.

ARMENIAN LANGUAGE. The Armenian or Haikan language, notwithstanding the great antiquity of the nation to which it belongs, possesses no literary documents prior to the fifth century of the Christian era. The translation of the Bible, begun by Miesrob in the year 410, is the earliest monument of the language that has come down to us. The dialect in which this version is written, and in which it is still publicly read in their churches, is called the old Armenian. The dialect now in use—the modern Armenian—in which they preach and carry on the intercourse of daily life, not only departs from the elder form by dialectical changes in the native elements of the language itself, but also by the great intermixture of Persian and Turkish words which has resulted from the conquest and subjection of the country. It is, perhaps, this diversity of the ancient and modern idioms which has given rise to the many conflicting opinions that exist as to the relation in which the Armenian stands to other languages. Thus Cirbiéd and Vater both assert that it is an original language, that is, one so distinct from all others in its fundamental character as not to be classed with any of the great families of languages. Eichhorn, on the other hand (*Sprachenkunde*, p. 349), affirms that the learned idiom of the Armenian undoubtedly belongs to the Medo-Persian family. Whereas Pott (*Untersuchungen*, p. xxxii.) says that, notwithstanding its many points of relation to that family, it cannot strictly be considered to belong to it; and Gatterer actually classed it as a living sister of the Basque, Finnish, and Welsh languages.

As to form, it is said to be rough and full of consonants; to possess ten cases in the noun—a

number which is only exceeded by the Finnish; to have no dual; to have no mode of denoting gender in the noun by change of form, but to be obliged to append the words *man* and *woman* as the marks of sex—thus, to say *prophet-woman* for *prophetess* (nevertheless, modern writers use the syllable *ohhi* to distinguish the feminine; Wahl, *Geschichte d. Morgenl. Sprachen*, p. 100); to bear a remarkable resemblance to Greek in the use of the participle, and in the whole syntactical structure; and to have adopted the Arabian system of metre.

The history of its alphabetical character is briefly this: until the third century of our era, the Armenians used either the Persian or Greek alphabet (the letter in Syrian characters, mentioned by Diodor. xix. 23, is not considered an evidence that they wrote *Armenian* in Syrian characters, as that letter was probably Persian). In the fifth century, however, the translation of the Bible created the necessity for characters which would more adequately represent the peculiar sounds of the language. Accordingly, after a fruitless attempt of a certain Daniel, and after several efforts on his own part, Miesrob saw a hand in a dream write the very characters which now constitute the Armenian alphabet. The 38 letters thus obtained are chiefly founded on the Greek, but have partly made out their number by deriving some forms from the Zend alphabet. The order of writing is from left to right. Miesrob employed these letters in his translation of the Bible, and thus ensured their universal and permanent adoption by the nation (Gesenius; article *Palaographie*, in Ersch and Gruber).—

J. N.

ARMENIAN VERSION. The Armenian version of the Bible was undertaken in the year 410 by Miesrob, with the aid of his pupils Joannes Ecelensis and Josephus Palensis. It appears that the patriarch Isaac first attempted, in consequence of the Persians having destroyed all the copies of the Greek version, to make a translation from the Peshito; that Miesrob became his coadjutor in this work; and that they actually completed their translation from the Syriac. But when the above-named pupils, who had been sent to the ecclesiastical council at Ephesus, returned, they brought with them an accurate copy of the Greek Bible. Upon this, Miesrob laid aside his translation from the Peshito, and prepared to commence anew from a more authentic text. Imperfect knowledge of the Greek language, however, induced him to send his pupils to Alexandria, to acquire accurate Greek scholarship; and, on their return, the translation was accomplished. Moses of Chorene, the historian of Armenia, who was also employed, as a disciple of Miesrob, on this version, fixes its *completion* in the year 410; but he is contradicted by the date of the Council of Ephesus, which necessarily makes it subsequent to the year 431.

In the Old Testament this version adheres exceedingly closely to the LXX. (but, in the book of Daniel, has followed the version of Theodotus). Its most striking characteristic is, that it does not follow any known recension of the LXX. Although it more often agrees with the Alexandrine text, in readings which are peculiar to the latter, than it does with the Aldine or Complutensian text; yet, on the other hand, it also has fol-

lowed readings which are only found in the two last. Bertholdt accounts for this mixed text by assuming that the copy of the Greek Bible sent from Ephesus contained the Lucian recension, and that the pupils brought back copies according to the Hesycharian recension from Alexandria, and that the translators made the latter their standard, but corrected their version by aid of the former (*Einleit.* ii. 560). The version of the New Testament is equally close to the Greek original, and also represents a text made up of Alexandrine and Occidental readings.

This version was afterwards revised and adapted to the Peshito, in the sixth century, on the occasion of an ecclesiastical union between the Syrians and Armenians. Again, in the thirteenth century, an Armenian king Hethom or Haitho, who was so zealous a Catholic that he turned Franciscan monk, adapted the Armenian version to the Vulgate, by way of smoothing the way for a union of the Roman and Armenian churches. Lastly, the bishop Uscan, who printed the first edition of this version at Amsterdam, in the year 1666, is also accused of having interpolated the text as it came down to his time, by adding all that he found the Vulgate contained *more* than the Armenian version. The existence of the verse 1 John v. 7, in this version, is ascribed to this supplementary labour of Uscan. It is clear from what has been said, that the critical uses of this version are limited to determining the readings of the LXX. and of the Greek text of the New Testament which it represents, and that it has suffered many alterations which diminish its usefulness in that respect.—J. N.

ARMLET. Although this word has the same meaning as *bracelet*, yet the latter is practically so exclusively used to denote the ornament of the wrist, that it seems proper to distinguish by *armlet* the similar ornament which is worn on the upper arm. There is also this difference between them, that in the East bracelets are generally worn by women, and armlets only by men. The armlet, however, is in use among men only as one of the insignia of sovereign power. There are three different words which the Auth. Vers. renders by bracelet. These are, 1. אֶצְדָּה *etzadah*, which occurs in Num. xxxi. 50; 2 Sam. i. 10; and which being used with reference to men only, we take to be the *armlet*. 2. צַמִּיד *tzamid*, which is found in Gen. xxiv. 22; Num. xxxi. 50; Ezek. xvi. 11. Where these two words occur together (as in Num. xxxi. 50), the first is rendered by 'chain' and the second by 'bracelet.' 3. שִׁירָיָה *shiryah*, which occurs only in Isa. iii. 19. The first we take to mean armlets worn by men; the second, bracelets worn by women and sometimes by men;

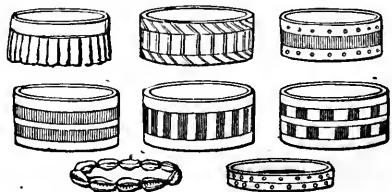

and the third, a peculiar bracelet of chain-work worn only by women. It is observable that the

two first occur in Num. xxxi. 50, which we suppose to mean that the men offered their own armlets and the bracelets of their wives. In the only other passage in which the first word occurs it denotes the royal ornament which the Amalekite took from the arm of the dead Saul, and brought with the other regalia to David. There is little question that this was such a distinguishing band of jewelled metal as we still find worn as a mark of royalty from the Tigris to the Ganges. The Egyptian kings are represented with armlets, which were also worn by the Egyptian women. These, however, are not jewelled, but of plain or enamelled metal, as was in all likelihood the case among the Hebrews. In modern times the most celebrated armlets are those which form part of the regalia of the Persian kings, and which formerly belonged to the Mogul emperors of India. These ornaments are of dazzling splendour, and the jewels in them are of such large size and immense value that the pair are reckoned to be worth a million of our money. The principal stone of the left armlet is famous in the East by the name of the *Devî-e-nur*, or *Sea of light*. It weighs 186 carats, and is considered the diamond of finest lustre in the world. The principal jewel of the left armlet, although of somewhat inferior size (116 carats) and value, is renowned as the *Tûg-e-mah*, 'Crown of the moon.' The imperial armlets, generally set with jewels, may also be observed in most of the portraits of the Indian emperors [BRACELET].

ARMON (עֲרֹמֹן); Chaldee, ܥܪܘܡܢ; Syriac, ܥܪܘܡܢ; Arabic, ܥܪܘܡܢ; Sept. πλάτανος; Vulg. *platanus*; Luth. *ahorn*; A. V. 'chestnut-tree'), a tree, which is named thrice in the Scriptures. It occurs among the 'speckled rods' which Jacob placed in the watering-troughs before the sheep (Gen. xxx. 37): its grandeur is indicated in Ezek. xxxi. 8, as well as in Eccus. xxiv. 19: it is noted for its magnificence, shooting



[*Platanus Orientalis*—Plane-tree.]

its high boughs aloft. This description agrees well with the plane-tree (*Platanus Orientalis*), which is adopted by all the ancient transla-

tors, to which the balance of critical opinion inclines, and which actually grows in Palestine. The beech, the maple, and the chestnut have been adopted, in different modern versions, as representing the Hebrew Armon; but scarcely any one now doubts that it means the plane-tree. It may be remarked that this tree is in Genesis associated with others—the willow and the poplar—whose habits agree with it; they are all trees of the low grounds, and love to grow where the soil is rich and humid. This is strikingly illustrated by the fact that Russel (*N. H. of Aleppo*, i. 47) expressly names the plane, the willow, and the poplar (along with the ash), as trees which grow in the same situations near Aleppo.

But this congruity would be lost if the chestnut were understood, as that tree prefers dry and hilly situations. There is a latent beauty also in the passage in Ezekiel, where, in describing the greatness and glory of Assyria, the prophet says, 'The Armon-trees were not like his boughs, nor any tree in the garden of God like unto him for beauty.' This not only expresses the grandeur of the tree, but is singularly appropriate from the fact that the plane-trees (*chenars*, as they are called) in the plains of Assyria are of extraordinary size and beauty, in both respects exceeding even those of Palestine. It consists with our own experience that one may travel far in Western Asia without meeting such trees, and so many together, as occur in the *chenar*-groves of Assyria and Media.

The Oriental plane-tree ranks in the Linnæan class and order *Monocia Polyandria*, and in the natural order among the *Platanaceæ*. Westernmost Asia is its native country, although, according to Professor Royle, it extends as far eastward as Cashmere. The stem is tall, erect, and covered with a smooth bark which annually falls off. The flowers are small and scarcely distinguishable: they come out a little before the leaves. The wood of the plane-tree is fine grained, hard, and rather brittle than tough; when old, it is said to acquire dark veins, and to take the appearance of walnut-wood.

In those situations which are favourable to its growth, huge branches spread out in all directions from the massive trunk, invested with broad, deeply-divided, and glossy green leaves. This body of rich foliage, joined to the smoothness of the stem, and the symmetry of the general growth, renders the plane-tree one of the noblest objects in the vegetable kingdom. It has now, and had also of old (Plin. *Nat. Hist.* xii. 1), the reputation of being the tree which most effectually excludes the sun's beams in summer, and most readily admits them in winter—thus affording the best shelter from the extremes of both seasons.

For this reason it was planted near public buildings and palaces, a practice which the Greeks and Romans adopted; and the former delighted to adorn with it their academic walks and places of public exercise. In the East, the plane seems to have been considered sacred, as the oak was formerly in Britain. This distinction is in most countries awarded to the most magnificent species of tree which it produces [TREES, SACRED]. In Palestine, for instance, where the plane does not appear to have been very common, the terebinth seems to have possessed pre-eminence [ELAH]. No one is ignorant of the celebrated story of Xerxes arresting the march of his grand army

before a noble plane-tree in Lydia, that he might render honour to it, and adorn its boughs with golden chains, bracelets, and other rich ornaments—an action misunderstood, and egregiously misrepresented by Ælian (*Var. Hist.* ii. 14).

The Oriental plane endures our own climate well, and grows to a fine tree; but not to the enormous size which it sometimes attains in the East. Several grand old plane-trees have been mentioned. Pausanias (*l. viii. c. 23*) notices a noble plane in Arcadia, the planting of which was ascribed, by tradition, to Menelaus; so that if this tradition were entitled to credit (and it claims little), it must, when he wrote, although in a sound state, have been above 1300 years old. Pliny, in his curious chapter on this tree (*Nat. Hist.* xii. 1), mentions one in Lycia, in the trunk of which had been gradually formed an immense cavern, eighty feet in circumference. L. Mutianus, thrice consul, and governor of the province, with eighteen other persons, often dined and supped commodiously within it. If nothing more were known of this L. Mutianus, we should like him for the pleasure, not unmingled with regret, with which he records the satisfaction which he occasionally derived from hearing the rain patter upon the leaves overhead, while he and his company sat dry and safe within: it was the music of their feast. Caligula also had a tree of this sort at his villa near Velitra, the hollow of which accommodated fifteen persons at dinner with a proper suite of attendants. The emperor called it 'his nest;' and it is highly probable that his friend Herod Agrippa may occasionally have been one of the fifteen birds who nested there along with him. Modern travellers also notice similar trees. Belon (*Obs. Sing.* l. ii. p. 105), La Roque (*Voy. de Syrie*, pp. 197-199), and others, mention the groves of noble planes which adorn the plain of Antioch; and the last-named traveller records a night's rest which he enjoyed under planes of great beauty in a valley of Lebanon (p. 76). That they are among the principal trees in the plantations near Aleppo has already been observed, on the authority of Russel.

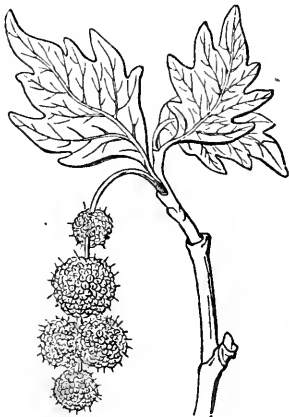

[Branch of *Platanus Orientalis*.]

Buckingham names them among the trees which line the Jabbok (*Travels in Palestine*, ii. 108). Evelyn (in his *Sylva*) seems to ascribe the intro-

duction of the plane-tree into England to the great Lord Bacon, who planted some which were still flourishing at Verulam in 1706. This was, perhaps, the first plantation of any note; but it appears from Turner's *Herbal* (published in 1551), that the tree was known and cultivated in this country before the chancellor was born. (Besides the authorities quoted, see Hiller, *Hierophyticon*, cap. 43; Celsius, *Hierobotanicon*, 512-516; and Winer's *Realwörterbuch*, in 'Ahorn').

ARMS, ARMOUR. In order to give a clear view of this subject, we shall endeavour to show succinctly, and from the best authorities now available, what were the weapons, both offensive and defensive, used by the ancient Asiatics; and then, under other proper heads, explain the composition and tactical condition of their armies; their systems of fortification; and, finally, their method of conducting sieges and battles; and their usages of war as regards spoil, captives, &c.

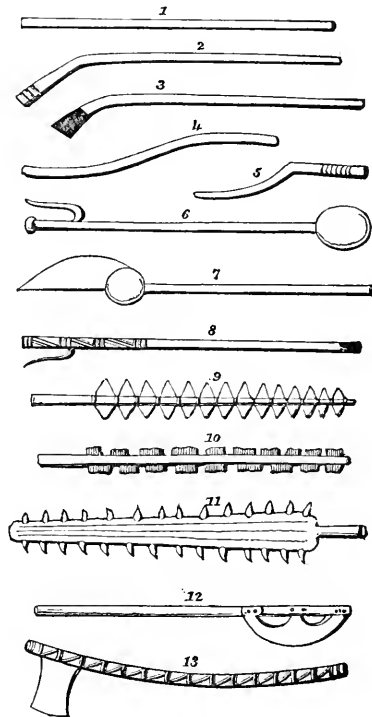

- | | |
|--|-------------------------------|
| 1, 2, 3. Clubs. | 8. Hardwood Sword. |
| 4, 5. Crooked Billets, or throwing-bats. | 9. Sharks-teeth Sword. |
| 6. Mace. | 10. Flint Sword. |
| 7. Battle-axe. | 11. Saw-fish Sword. |
| | 12, 13. Egyptian Battle-axes. |

The instruments at first employed in the chase, or to repel wild beasts, but converted by the wicked to the destruction of their fellow-men, or used by the peaceable to oppose aggression, were naturally the most simple. Among these were the club and the throwing-bat. The first consisted originally of a heavy piece of wood, variously shaped, made to strike with, and, according to its form, denominated a mace, a bar, a hammer, or a maul. This weapon was in use among the He-

brews; for, in the time of the kings, wood had already been superseded by metal; and the שֶׁבֶט *shevet barzel*, rod of iron (Ps. ii. 9), is supposed to mean a mace, or gavelcock, or crowbar. It is an instrument of great power when used by a strong arm; as when Van Amburgh, with one in his hand, compels a tiger's ferocity to submit to his will. (See Wilkinson's *Manners and Customs of the Ancient Egyptians*, vol. i. p. 327, fig. 3, 4; and mace, fig. 1, 2. The throwstick or lissan occurs p. 329.) The other was also known, if, as is probable, מַפְחִיֵּץ *maphietz* (Prov. xxv. 18) be a maul, a martel, or a war-hammer. It is likely metal was only in general use at a later period, and that a heavy crooked billet continued long to serve both as a missile and a sword. The throwstick, made of thorn-wood, is the same instrument which we see figured on Egyptian monuments. By the native Arabs it is still called *lissan*, and was anciently known among us by the name of crooked billet. These instruments, supplied with a sharp edge, would naturally constitute a battle-axe, and a kind of sword; and such in the rudest ages we find them, made with flints set into a groove, or with sharks' teeth firmly secured to the staff with twisted sinews. On the earliest monuments of Egypt, for these ruder instruments is already seen substituted a piece of metal with a steel or bronze blade fastened into a globe, thus forming a falchion-axe; and also a lunate-blade, riveted in three places to the handle, forming a true battle-axe (Wilkinson, vol. i. p. 325, 326); and there were, besides, true bills or axes in form like our own.

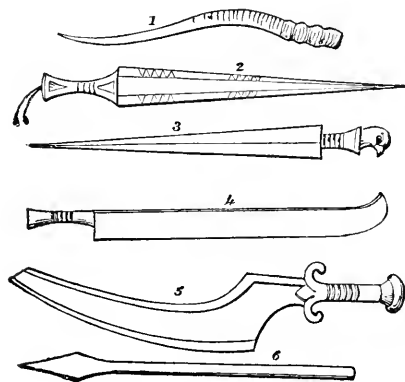

1. Horn Dagger. 4, 5. Tulwar Swords.
2, 3. Swords. 6. Quarter-pike.

Next came the dirk or poniard, which, in the Hebrew word חֶרֶב *cherev*, may possibly retain some allusion to the original instrument made of the antelope's horn, merely sharpened, which is still used in every part of the East where the material can be procured. From existing figures, the dirk appears to have been early made of metal in Egypt, and worn stuck in a girdle (Wilkinson, i. 319); but, from several texts (1 Sam. xvii. 39; 2 Sam. xx. 8; and 1 Kings xx. 11), it is evident that the real sword was slung in a belt, and that 'girding' and 'loosing the sword' were synonymous terms for commencing and ending a war. The blades were, it seems, always short (one is

mentioned of a cubit's length); and the dirk-sword, at least, was always double-edged. The sheath was ornamented and polished. In Egypt there were larger and heavier swords, more nearly like modern tulwars, and of the form of an English round-pointed table-knife. But while metal was scarce, there were also swords which might be called quarter-pikes, being composed of a very short wooden handle, surmounted by a spear-head. Hence the Latin *telum* and *ferrum* continued in later ages to be used for gladius. In Nubia, swords of heavy wood are still in use.

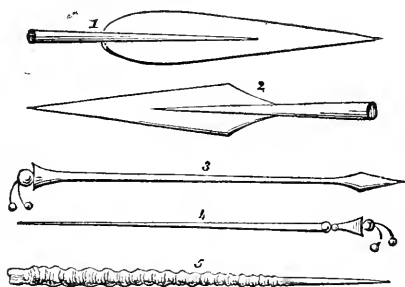

1, 2. Spear-heads. 3, 4. Darts.
5. Oryx horn spear-head.

The spear, רֶמַח *ramach*, was another offensive weapon common to all the nations of antiquity, and was of various size, weight, and length. Probably the shepherd Hebrews, like nations similarly situated in northern Africa, anciently made use of the horn of an oryx, or a leucoryx, above three feet long, straightened in water, and sheathed upon a thorn-wood staff. When sharpened, this instrument would penetrate the hide of a bull, and, according to Strabo, even of an elephant: it was light, very difficult to break, resisted the blow of a battle-axe, and the animals which furnished it were abundant in Arabia and in the desert east of Palestine. At a later period, the head was of brass, and afterwards of iron. Very ponderous weapons of this kind were often used in Egypt by the heavy infantry; and, from various circumstances, it may be inferred that among the Hebrews and their immediate neighbours, commanders in particular were distinguished by heavy spears. Among these were generally ranked the most valiant in fight and the largest in stature; such as Goliath, 'whose spear was like a weaver's beam' (1 Sam. xvii. 7), and whose spear's head weighed six hundred shekels of iron; which by some is asserted to be equal to twenty-five pounds weight. The spear had a point of metal at the but-end to fix it in the ground, perhaps with the same massy globe above it, which is still in use, intended to counterbalance the point. It was with this ferret that Abner slew Asahel (2 Sam. ii. 22, 23). The form of the head and length of the shaft differed at different times, both in Egypt and Syria, and were influenced by the fashions set by various conquering nations.

The javelins, named חַנִּית *chaneth*, and כִּרְדֹן *kedon*, may have had distinct forms: from the context, where *chaneth* first occurs, it appears to have been a species of dart carried by light troops (1 Sam. xiii. 22; Ps. iv.); while the *kedon*, which was heavier, was most likely a kind of pilum. In

most nations of antiquity the infantry, not bearing a spear, carried two darts, those lightly armed using both for long casts, and the heavy-armed only one for that purpose; the second, more ponderous than the other, being reserved for throwing when close to the enemy, or for handling in the manner of a spear. This explanation may throw light on the fact of the chaneth being named in connection with the צננה *tseenna*, or larger buckler (1 Chron. xii. 34), and may reconcile what is said of the kedon (Job xxxix. 23; xli. 29, and Josh. viii. 10). While on the subject of the javelin, it may be remarked that, by the act of casting one at David (1 Sam. xix. 9, 10), Saul virtually absolved him from his allegiance; for by the customs of ancient Asia, preserved in the usages of the Teutonic and other nations, the *Sachsen recht*, the custom of the East Franks, &c., to throw a dart at a freedman, who escaped from it by flight, was the demonstrative token of manumission given by his lord or master; he was thereby sent out of hand, manumissus, well expressed in the old English phrase 'scot-free.' But for this act of Saul, David might have been viewed as a rebel.

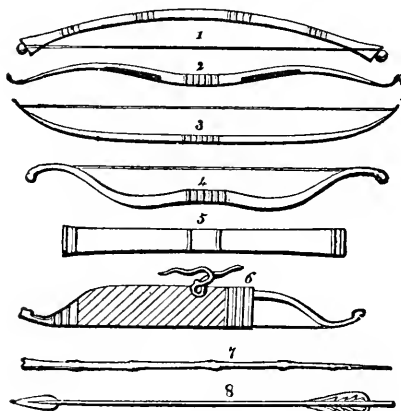

1, 2, 3, 4. Bows. 5, 6. Quivers. 7, 8. Arrows.

But the chief offensive weapon in Egypt, and, from the nature of the country, it may be inferred, in Palestine also, was the war-bow, קשתות *keshtoth*, and קשת *keseth*, the arrows being denominated חיצים *hitzim*, חץ *hitz*. From the simple implements used by the first hunters, consisting merely of an elastic reed, a branch of a tree, or rib of palm, the bow became in the course of time very strong and tall, was made of brass, of wood backed with horn, or of horn entirely, and even of ivory; some being shaped like the common English bow, and others, particularly those used by riding nations, like the buffalo horn. There were various modes of bending this instrument, by pressure of the knee, or by the foot, ררך *reer*, treading the bow, or by setting one end against the foot, drawing the middle with the hand of the same side towards the hip, and pushing the upper point forward with the second hand, till the thumb passed the loop of the string beyond the nock. The horned bows of the cavalry, shaped like those of the Chinese, occur on monuments of antiquity. They cannot be bent from their form of a Roman C to that of

what is termed a Cupid's bow , but by placing one end under the thigh; and as they are short, this operation is performed by Tahtar riders while in the saddle. This was the Parthian bow, as is proved by several Persian bas-reliefs, and may have been in use in the time of the Elamites, who were a mounted people. These bows were carried in cases to protect the string, which was composed of deer sinews, from injury, and were slung on the right hip of the rider, except when on the point of engaging. Then the string was often cast over the head, and the bow hung upon the breast, with the two nocks above each shoulder, like a pair of horns. The *hitzim*, or arrows, were likewise enclosed in a case or quiver, תלי *tele*, hung sometimes on the shoulder, and at other times on the left side; and six or eight flight-arrows were commonly stuck in the edge of the cap, ready to be pulled out and put to the string. The infantry always carried the arrows in a quiver on the right shoulder, and the bow was kept unbent until the moment of action. On a march it was carried on the shield arm, where there was frequently also a horn bracer secured below the elbow to receive the shock from the string when an arrow was discharged. The flight or long-range arrows were commonly of reed, not always feathered, and mostly tipped with flint points; but the shot or aimed arrows, used for nearer purposes, were of wood tipped with metal, about 30 inches long, and winged with three lines of feathers, like those in modern use: they varied in length at different periods, and according to the substance of the bows.

The last missile instrument to be mentioned is the sling, קלע *kala* (Job xli. 28), an improvement upon the simple act of throwing stones. It was the favourite weapon of the Benjamites, a small tribe, not making a great mass in an order of battle, but well composed for light troops. They could also boast of using the sling equally well with the left hand as with the right. The sling was made of plaited thongs, somewhat broad in the middle, to lodge the stone or leaden missile, and was twirled two or three times round before the stone was allowed to take flight,

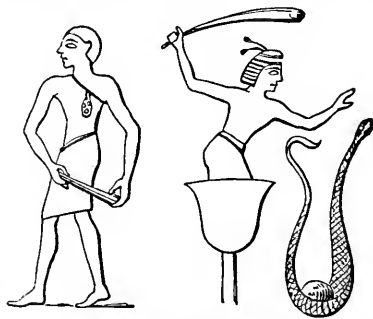

[Egyptian Slingers and Sling.]

Stones could not be cast above 400 feet, but leaden bullets could be thrown as far as 600 feet. The force as well as precision of aim which might be attained in the use of this instrument was remarkably shown in the case of David; and several nations of antiquity boasted of great skill in the practice of the sling.

All these hand-weapons were in use at different periods, not only among the Hebrews and Egyptians, but likewise in Assyria, Persia, Greece, and Macedonia; in which last country the sarissa carried by the heavy infantry of the phalanx differed from the others only in the great length of the shaft. The Roman pilum was a kind of dart, distinguished from those of other nations chiefly by its weight, and the great proportional length of the metal or iron part, which constituted one half of the whole, or from two and a half to three feet. Much of this length was hollow, and received nearly twenty inches of the shaft within it: the point was never hooked like that of common darts, because the weapon being nearly indestructible, the soldiers always reckoned upon advancing in battle and recovering it without trouble when thrown; whereas, if it had been hooked or hamate, they could not have wrenched it out of hostile shields or breast-plates without trouble and delay.

DEFENSIVE ARMS.—The most ancient defensive piece was the shield, buckler, roundel, or target, composed of a great variety of materials, very different in form and size, and therefore in all

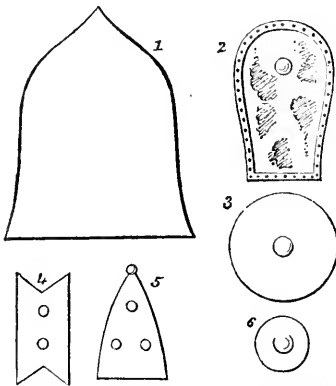

1. The Tsenna, or Great Shield. 2. Common Egyptian Shield. 3. Target. 4, 5. Ancient Shields of unknown tribes. 6. Roundel.

nations bearing a variety of names. The Hebrews used the word צֶנְנָה *tsenna*, for a great shield; defence, protection (Gen. xv. 1; Ps. xlvii. 9; Prov. xxx. 5), which is commonly found in connection with spear, and was the shelter of heavily-armed infantry; מגֵן *magin*, a buckler, or smaller shield, which, from a similar juxtaposition with sword, bow and arrows, appears to have been the defence of the other-armed infantry and of chiefs; and סוּחַרָה *sohairah*, *parma*, a roundel, which may have been appropriated to archers and slingers; and there were שְׁלֵטִים *shelatim*, and שְׁלֵטִי *shelti*, synonymous with *magin*, only different in ornament. In the more advanced eras of civilization shields were made of light wood not liable to split, covered with bull-hide of two or more thicknesses and bordered with metal: the lighter kinds were made of wicker-work or osier, similarly, but less solidly covered; or of double ox-hide cut into a round form. There were others of a single hide, extremely thick from having been boiled; their surface presented

an appearance of many folds, like round waves up and down, which might yield, but could rarely be penetrated.

We may infer that at first the Hebrews borrowed the forms in use in Egypt, and that their common shields were a kind of parallelogram, broadest and arched at the top and cut square beneath, bordered with metal, the surface being covered with raw hide with the hair on. The lighter shields may have been soaked in oil and dried in the shade to make them hard; no doubt, hippopotamus, rhinoceros, and elephant skin shields were brought from Ethiopia and purchased in the Phœnician markets; but small round hand-bucklers of whale-skin, still used by Arabian swordsmen, came from the Erythrean sea. During the Assyrian and Persian supremacy the Hebrews may have used the square, oblong, and round shields of these nations, and may have subsequently copied those of Greece and Rome. The princes of Israel had shields of precious metals: all were managed by a wooden or leather handle, and often slung by a thong over the neck. With the larger kinds a *testudo* could be formed by pressing the ranks close together; and while the outside men kept their shields before and on the flanks, those within raised theirs above the head, and thus produced a kind of surface, sometimes as close and fitted together as a pantile roof, and capable of resisting the pressure even of a body of men marching upon it.

The *tsenna* was most likely what in the feudal ages would have been called a *pavise*, for such occurs on the Egyptian monuments. This weapon was about five feet high, with a pointed arch above, and square below, resembling the feudal knight's shield, only that the point was reversed. This kind of large-sized shield, however, was best fitted for men without any other armour, when combating in open countries, or carrying on sieges; for it may be remarked in general that the military buckler of antiquity was large in proportion as other defensive armour was wanting. Shields were hung upon the battlements of walls, and, as still occurs, chiefly above gates of cities by the watch and ward. In time of peace they were covered to preserve them from the sun, and in war uncovered; this sign was poetically used to denote coming hostilities, as in Isa. xxii. 6, &c. In Europe, where the Crusaders could imitate the Saracens, but not introduce their climate, shields were carved in stone upon towers and gates, as at York, &c. The Eastern origin of this practice seems to be attested by the word *Zuine*, which, in German, still denotes a battlement, something pointed, a summit, and conveys the idea of a *pavise* with the point uppermost, a shape such as Arabian battlements often assume.

The *helmet* was next in consideration, and in the earliest ages was made of osier, or rushes, in the form of a beehive, or of a skull-cap. The skins of the heads of animals—of lions, bears, wild boars, bulls, and horses—were likewise adopted, and were adorned with rows of teeth, manes, and bristles. Wood, linen cloth in many folds, and a kind of felt, were also in early use, and helmets of these materials may be observed worn by the nations of Asia at war with the conqueror kings of Egypt, even before the departure of Israel. At that time also these kings had helmets of metal, of rounded or pointed forms, adorned with a figure

of the serpent *Kneph*; and an allied nation, perhaps the Carian, reported to have first worn a military crest, bears on the skull-cap of their brazen helmets a pair of horns with a globe in the middle—the solar arkite symbol. The nations of

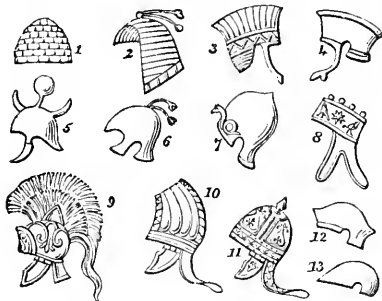

- | | |
|---------------------|------------------------------|
| 1. Of Rushes. | 8. Assyrian. |
| 2. Egyptian. | 9. Greek. |
| 3, 4. Western Asia. | 10. Ionian. |
| 5. Carian? | 11. Parthian. |
| 6, 7. Egyptian. | 12, 13. Other Asiatic tribes |

farther Asia, however, used the woollen or braided caps, still retained, and now called kaouk and fez, around which the turban is usually wound. These were almost invariably supplied with long lappets to cover the ears and the back of the head, and princes usually wore a radiated crown on the summit. This was the form of the Syrian, and probably of the Assyrian helmets, excepting that the last mentioned were of brass, though they still retained the low cylindrical shape. *כובע* *koba*, some helmet of this kind, was worn by the trained infantry, who were spearmen among the Hebrews; but archers and slingers had round skull-caps of skins, felts, or quilted stuffs, such as are still in use among the Arabs. The form of Greek and Roman helmets, both of leather and of brass, is well known; they were most likely adopted also by the Hebrews and Egyptians during their subjection to those nations, but require no further notice here.

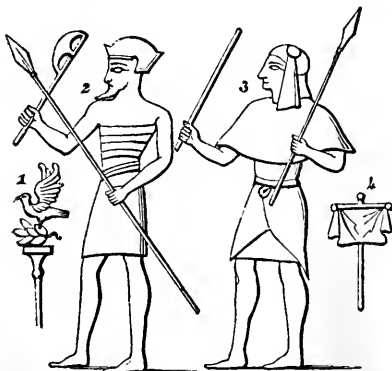

1, 2. Canaan. 3, 4. Egypt.

Body Armour.—The most ancient Persian idols are clad in shaggy skins, such as the *Aegis* of Jupiter and Minerva may have been, the type being taken from a Cyrenæan or African legend,

and the pretended red goat-skin may be supposed to have been that of a species of gnu (*Catoblepas Gorgon*, Ham. Smith), an animal fabled to have killed men by its sight, and therefore answering to the condition both of a kind of goat and of producing death by the sight alone. In Egypt cuirasses were manufactured of leather, of brass, and of a succession of iron hoops, chiefly covering the abdomen and the shoulders; but a more ancient national form was a kind of thorax, tippet, *שירי* *shereyon*, or square, with an opening in it for the head, the four points covering the breast, back, and both upper arms. This kind in particular was affected by the royal band of relatives who surrounded the Pharaoh, were his subordinate commanders, messengers, and body-guards, bearing his standards, ensign-fans, and sun-screens, his portable throne, his bow and arrows. Beneath this square was another piece, protecting the trunk of the body, and both were in general covered with a red-coloured cloth or stuff. On the oldest fictile vases a shoulder-piece likewise occurs, worn by Greek and Etruscan warriors. It covers the upper edge of the body armour, is perforated in the middle to allow the head to pass, but hangs

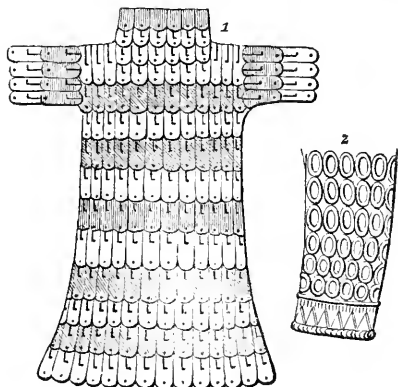

1. Egyptian tigulated. 2. Sleeve of ring-mail, Ionian.

equal on the breast and back, square on the shoulders, and is evidently of leather. (See the figure of Menelaus discovering Helen in the sack of Troy. Millin, *Mon. inédits*.) This piece of armour occurs also on the shoulders of Varangi (northmen, who were the body-guards of the Greek emperors); but they are studded with roundels or bosses, as they appear figured in mosaic or fresco on the walls of the cathedral of Ravenna, dating from the times of Justinian. The late Roman legionaries, as published by Du Choul, again wear the tippet armour, like that of the Egyptians, and one or other of the above forms may be found on figures of Danes in illuminated manuscripts of the eleventh century.

By their use of metal for defensive armour, the Carians appear to have created astonishment among the Egyptians, and therefore may be presumed to have been the first nation so protected in western Asia; nevertheless, in the tombs of the kings near Thebes, a tigulated hauberk is represented, composed of small three-coloured pieces of metal; one golden, the others reddish and green. It is this suit which

Denon represents as composed of rings set on edge; but they are all parallelograms, with the lower edge forming the segment of a circle, and each piece, beside the fastening, has a button and a vertical slit above it, giving flexibility by means of the button of each square working in the aperture of the piece beneath it. This kind of armour may be meant by the word תַּחְרָה *techera*, the closest interpretation of which appears to be *de-cussatio*, *tigulatio*, a tiling. The expression in 2 Chron. xviii. 33, may be that Ahab was struck in one of the grooves or slits in the squares of his *techera*, or between two of them where they do not overlap; or perhaps, with more probability, between the metal hoops of the trunk of the shereyon before mentioned, where the thorax overlaps the abdomen. The term קַשְׁקָסִים *kaskasim*, 'scales,' in the case of Goliath's armour, denotes the squamous kind, most likely that in which the pieces were sewed upon a cloth, and not hinged to each other, as in the *techera*. It was the defensive armour of Northern

to observe, that in estimating the meaning of Hebrew names for armour of all kinds, they are



[Parthian Horseman.]

and Eastern nations, the Persian Cataphracti, Parthians, and Sarmatians. But of true annular or ringed mail, Denon's figure being incorrect, we doubt if there is any positive evidence, excepting where rings were sewn separately upon cloth, anterior to the sculpture at Takt-i-Boostan, or the close of the Parthian era. The existence of mail is often incorrectly inferred from our translators using the word wherever flexible armour is to be mentioned. The *techera* could not well be worn without an under-garment of some density to resist the friction of metal; and this may have been a kind of sagum, the shereyon of the Hebrews, under another form—the dress Saul put upon David before he assumed the breastplate and girdle. The Roman sagum offers a parallel instance. Under that name it was worn at first à *loricâ*, then beneath it, and at last again without, but the stuff itself made into a kind of felt.

The *Cuirass* and *Corslet*, strictly speaking, were of prepared leather (*corium*), but often also composed of quilted cloths: the former in ancient times generally denoted a suit with leathern appendages at the bottom and at the shoulder, as used by the Romans; the latter, one in which the barrel did not come down below the hips, and usually destitute of leathern *vittæ*, which was nationally Greek. In later ages it always designates a breast and back piece of steel. It is, however, requisite



1, 2. Early Greek.
3. Greek.

4, 5. Roman.
6. Barbarian.

liable to the same laxity of use which all other languages have manifested; for in military matters, more perhaps than in any other, a name once adopted remains the same, though the object may be changed by successive modifications, till there remains but little resemblance to that to which the designation was originally applied. The objects above denominated appendages and *vittæ* (in the feudal ages, *lambrequins*), were straps of leather secured to the lower rim of the barrel of a suit of armour, and to the openings for arm-holes: the first were about three and a half inches in width; the second, two and a half. They were ornamented with embroidery, covered with rich stuffs and goldsmiths' work, and made heavy at the lower extremity, to cause them always to hang down in proper order; but those on the arm-holes had a slight connection, so as to keep them equal when the arm was lifted. These *vittæ* were rarely in a single row, but in general formed two or three rows, alternately covering the opening between those underneath, and then protecting the thighs nearly to the knee, and half the upper arm. In the Roman service, under the suit of armour, was the sagum, made of red serge or baize, coming down to the cap of the knee and folding of the arm, so that the *vittæ* hung entirely upon it. Other nations had always an equivalent to this, but not equally long; and in the opinion of some, the Hebrew *shereyon* served the same purpose.

The Roman and Greek suits were, with slight difference, similarly laced together on the left, or shield side; and on the shoulders were bands and clasps, comparatively narrow in those of the Romans, which covered the joinings of the breast and back pieces on the shoulders, came from behind, and were fastened to a button on each breast. At the throat the suit of armour had always a double

edging, often a band of brass or silver; in the Roman, and often in the Greek, adorned with a lion's or a Gorgon's head. It was here that, in the time of Augustus, and probably much earlier, the warriors distinguished for particular acts of valour wore insignia; a practice only revived by the moderns under the names of crosses and decorations. The Romans, it appears, had *phalæe* and *phalerae* of honour, terms which have been supposed to signify bracelets and medals; but all opinion on the subject was only conjectural previously to the discovery, on the borders of the Rhine, of a monumental bas-relief, raised by the freedman of Marcus Caelius Lembo, tribune of the (xix) 18th legion, who fell in the disastrous



overthrow of Varus. The effigy is of three-quarter length, in a full suit of armour, with a laurel crown on the head, a Gallic twisted torque round the neck; and from the lion-head shoulder-clasps of the cuirass hang two embossed bracelets, having beneath them a label with three points, from which are suspended five medals of honour; one large, on the pit of the stomach, representing a face of Medusa; and two on each side, one beneath the other; and all as far as can be seen charged with lions' faces and lions' heads in profile. The monument is now in the museum of the university at Bonn.

The girdle, or more properly the baldric or belt (*cingula* or *balteus*), was used by the Hebrews under the name of *יִזֹר* *izor*: it was of leather, studded with metal plates or bullæ; when the armour was slight, broad, and capable of being girt upon the hips; otherwise it supported the sword scarf-wise from the shoulder.

Greaves were likewise known, even so early as the time of David, for Goliath wore them. They consisted of a pair of shin-covers of brass or strong leather, bound by thongs round the calves and above the ankles. They reached only to the knees, excepting among the Greeks, whose greaves, elastic behind, caught nearly the whole leg, and were raised in front above the knees. The Hebrew word *יָנֹד* *soin*, in Isaiah ix. 5, is supposed to mean a half-greave, though the passage is altogether obscure. Perhaps the war-hoot may be explained by the war-shoe of Egypt with a metal point; and then the words might be rendered, 'For every greave of the armed foot is with confused noise and garments rolled in blood,' &c., instead of 'Every battle of the warrior,' &c. But, after all, this is not quite satisfactory.—C. H. S.

ARNON (אֲרֹנּוֹן; Sept. Ἄρον ὄρ), a river forming the southern boundary of trans-Jordanic Palestine, and separating it from the land of Moab (Num. xxi. 13, 26; Deut. ii. 24; iii. 8, 16; Josh. xii. 1; Isa. xvi. 2; Jer. xlviii. 20). Burckhardt was the first to give a satisfactory account of this river, under the name of Wady Modjeb, which it now bears. It rises in the mountains of Gilead, near Katrane, whence it pursues a circuitous course of about eighty miles to the Dead Sea. It flows in a rocky bed, and, at the part visited by Burckhardt, in a channel so deep and precipitous as to appear inaccessible; yet along this, winding among huge fragments of rock, lies the most frequented road, and, not being far from Dibon, probably that taken by the Israelites. The descent into the valley from the south took Irby and Mangles (*Letters*, p. 461) one hour and a half; the descent from the north took Burckhardt (*Syria*, p. 372) thirty-five minutes. The last-named traveller declares that he had never felt such suffocating heat as he experienced in this valley from the concentrated rays of the sun and their reflection from the rocks. The stream is almost dried up in summer; but huge masses of rock, torn from the banks, and deposited high above the usual channel, evince its fulness and impetuosity in the rainy season. Irby and Mangles suppose that it is this which renders the valley of the Arnon less shrubby than that of most other streams in the country. 'There are, however, a few tamarisks, and here and there are oleander growing about it.' Near this place the old Roman road comes down upon the stream; and here there remains a single high arch of a bridge, all the others having disappeared.

AROER (אֲרֹעַר; Sept. Ἀροῦρ), a town on the north side of the river Arnon, and therefore on the southern border of the territory conquered from the Amorites, which was assigned to the tribes of Reuben and Gad (Deut. ii. 36; Josh. xii. 2; xiii. 9). The Amorites had previously dispossessed the Ammonites of this territory; and although, in the texts cited, the town seems to be given to Reuben, it is mentioned as a Moabish city by Jeremiah (xlviii. 19). Burckhardt found the ruins of this town under the name of Araayr, on the edge of a precipice overlooking the river (*Travels in Syria*, 372). They are merely alluded to by him, and have not been noticed by other travellers. Aroer is always named in conjunction with 'the city that is in the midst of the river;' whence Dr. Mansford (*Script. Gaz.*) conjectures that, like Rabbath Ammon [which see], it consisted of two parts, or distinct cities; the one on the bank of the river, and the other in the valley beneath, surrounded, either naturally or artificially, by the waters of the river.

2. AROER, one of the towns 'built,' or probably rebuilt, by the tribe of Gad (Num. xxxii. 34). It is said in Josh. xii. 25, to be 'before Rabbath' [of Ammon]; but, as Raumer well remarks (*Palaestina*, p. 249), this could not possibly have been in the topographical sense of the words (in which *before* means *east of*), seeing that Aroer, as a town on the eastern border of Gad, must have been west of Rabbath. But to a person in Palestine Proper, or coming from the Jordan, Aroer would be *before* Rabbath in the ordinary sense; and it appears to have been thus understood by Burckhardt.

{*Syria*, 355), who, in journeying from Szalt towards Rabbath Ammon, notices a ruined site, called Ayra, as 'one of the towns built by the tribe of Gad.' This Ayra, about seven miles south-west from Szalt, is probably the same with the *Array-el-Enir*, visited by Legh (p. 216), on his way from Heshbon to Szalt, and which in Berghaus's celebrated map of Palestine is placed two German (nine English) miles W.N.W. of Rabbah. Aroer of Gad is also mentioned in Judg. xi. 33, and 2 Sam. xxiv. 5.

3. AROER, a city in the tribe of Judah (1 Sam. xxx. 28).

4. AROER, a city in the south of Judah, to which David sent presents after recovering the spoil of Ziklag (1 Sam. xxx. 26, 28). At the distance of twenty geographical miles S. by W. from Hebron, Dr Robinson came to a broad Wady where there are many pits for water, which are called 'Ararah, and which gave name to the valley. In the valley and on the western hill are evident traces of an ancient village or town, consisting only of foundations of unbewn stones, now much scattered, but yet sufficiently distinct to mark them as foundations. Small fragments of pottery are also everywhere visible. The identity of name satisfies the traveller that he had here found the Aroer of Judah.

ARPHAD, or ARPAD (אַרְפָּאָד; Sept. 'Appád), a Syrian city, having its own king, and in Scripture always associated with Hamath, the Epiphania of the Greeks (2 Kings xviii. 34; xix. 34; Isa. x. 9; xxxvi. 19). It has very commonly been confounded with the Phœnician Arvad or Aradus [ARVAD]. Michaelis and others seek Arphad in Raphanæ or Raphanæ of the Greek geographers (Ptolem. v. 15; Steph. Byzant. in 'Επιφάνεια; Joseph. *De Bell. Jud.* vii. 1. 3; vii. 5. 1), which was a day's journey west of Hamath (Mannert, vi. p. 431). Some, however, are content to find this Arphad in the Arpha which Josephus (*De Bell. Jud.* iii. 3. 6) mentions as situated on the north-eastern frontier of the northernmost province of Herod Agrippa's tetrarchy. But all these explanations are purely conjectural, and Arphad must still be numbered among unascertained Scriptural sites.

ARPHAXAD (אַרְפַּכְשָׁד; Sept. 'Αρφαξάδ), the son of Shem, and father of Salah; born one year after the Deluge, and died b.c. 1904, aged 438 years (Gen. xi. 12, &c.).

ARROW. This word is frequently used as the symbol of calamity or disease inflicted by God (Job, vi. 4; xxxiv. 6; Ps. xxxviii. 2; Deut. xxxii. 23; comp. Ezek. v. 16; Zech. ix. 14). The metaphor thus applied was also in use among the heathen: thus, Ovid—

'Non mea sunt summa leviter dstricta sagitta.
Pectora: descendit vulnus ad ossa meum.'

It derived its propriety and force from the popular belief that all diseases were immediate and special inflictions from Heaven.

Lightnings are, by a very fine figure, described as the arrows of God (Ps. xviii. 14; cxliv. 6; Habak. iii. 11; comp. Wisd. v. 21; 2 Sam. xxii. 15).

'Arrow' is occasionally used to denote some sudden or inevitable danger; as in Ps. xci. 5:—
'The arrow that flieth by day.' It is also figu-

rative of anything injurious, as a deceitful tongue (Ps. cxxix. 4; Jer. ix. 7); a bitter word (Ps. lxxv. 3); a false testimony (Prov. xxv. 18). As symbolical of oral wrong, the figure may perhaps have been derived from the darting 'arrowy tongue' of serpents.

The arrow, however, is not always symbolical of evil. In Ps. cxxvii. 4, 5, well-conditioned children are compared to 'arrows in the hands of a mighty man;' i. e. instruments of power and action. The arrow is also used in a good sense to denote the efficient and irresistible energy of the word of God in the hands of the Messiah (Ps. xlv. 6; Isa. xlv. 2, and Lowth's note thereon).—Wemyss's *Clavis Symbolica*, &c.

ARROWS. [ARMS.]

ARROWS, DIVINATION BY. [DIVINATION.]

ARTAXERXES, ARTACHSHAST (אַרְתַּחְשָׁשְׁתָּא as it is most frequently written) is the title under which more than one Persian king is mentioned in the Old Testament. The Hebrew form is a slight corruption of אֲרַתְחַשְׁתָּר, which letters De Sacy has deciphered in the inscriptions of Nakshi Rostam, and which he vocalizes *Artahshetr* (*Antiq. d. l. Perse*, p. 100). Gesenius pronounces them *Artachshatr*; and, by assuming the easy change of *r* into *s*, and the transposition of the *s*, makes Artachshast very closely represent its prototype. The word is a compound, the first element of which, *arta*—found in several Persian names—is generally admitted to mean *great*; the latter part De Sacy conceived to be the Zend *Kshethvo*, *King*, to which Gesenius and Pott assent. Thus the sense of *great warrior*, which Herodotus (vi. 98) assigned to the Greek form Artaxerxes, accords with that which etymology discovers in the original Persian title (particularly when we consider that, as the king could only be chosen from the soldier-caste—from the *Kshatriyas*—warrior and king are so far cognate terms); although Pott, according to his etymology of *Xerxes*, takes Artaxerxes to be more than equivalent to Artachshatr—to be 'magnus regum rex' (*Etym. Forsch.* i. p. lxvii.).

The first ARTACHSHAST (אַרְתַּחְשָׁשְׁתָּא, and once pointed *Artachshasta*; Sept. 'Αρθασασθά) is mentioned in Ezra iv. 7-24, as the Persian king who, at the instigation of the adversaries of the Jews, obstructed the rebuilding of the Temple, from his time to that of Darius, king of Persia. According to the arguments adduced in the art. AHASUERUS, this king is the immediate predecessor of Darius Hystaspis, and can be no other than the Magian impostor, Smerdis, who seized on the throne b.c. 521, and was murdered after a usurpation of less than eight months (Herod. iii. 61-78). Profane historians, indeed, have not mentioned him under the title of Artaxerxes; but neither do Herodotus and Justin (the latter of whom calls him *Oropasta*, i. 9) agree in his name; so that this fact is not, of itself, enough to invalidate any deductions which are in other respects sound.

As to the second ARTACHSHAST (אַרְתַּחְשָׁשְׁתָּא; Sept. 'Αρθασασθά), in the seventh year of whose reign Ezra led a second colony of the Jewish exiles back to Jerusalem (Ezra vii. 1, *sq.*), the opinions are divided between Xerxes and his son Artaxerxes Longimanus. The arguments brought forward by the advocates for Xerxes, among whom

are J. D. Michaelis, Jahn, and De Wette, are briefly as follows: That, as the preceding portion of the book of Ezra relates to Darius Hystaspis, it is most natural to expect that the next following section should refer to his successor, Xerxes; that, on the supposition that Artaxerxes is here meant, we not only have to explain how the reign of Xerxes, who had been so favourable to the Jews, is entirely omitted here, but also how the narrative can make such a tremendous leap as from the sixth year of Darius to the seventh of Artaxerxes, a period of fifty-eight years; that, on that supposition, the interval between the seventh year of his reign, when Ezra set out, allows too short a space for the affairs of the colony to have reached that state of disorder in which Nehemiah found them on his arrival at Jerusalem, in the twentieth year of his reign; and, lastly, that Josephus calls the king in question Xerxes (*Antiq. Jud.* xi. 5).

The supporters of the other alternative—that the king here meant is Artaxerxes Longimanus—among whom are J. H. Michaelis, Eichhorn, and Bertholdt, rest on the following reasons, as stated chiefly by Bertholdt: That the coherence between the several portions of the book of Ezra is by no means so strict as to make the first argument conclusive; as, even assuming that Xerxes is the person referred to, there is still a gap of thirty-six years between the end of ch. vi. and the beginning of ch. vii.; that the objection, that the interval between the arrivals of Ezra and Nehemiah in Jerusalem is too short (on the supposition that the former left Babylon in the reign of Artaxerxes) to account for the confusion in which the latter found the colony, loses its force, if we consider that the progress of the infant state was necessarily slow in its difficult position, and if we also conceive Ezra's efforts to have been more directed to reform the religious than the civil state of the Jews; that the appeal to Josephus is of no avail, as he calls the king in whose reign Nehemiah returned Xerxes also, which is decidedly incorrect, since Nehemiah went back to Persia in the thirty-second year of the king (xiii. 6), and Xerxes only reigned twenty-one years; that the Apocryphal Esdras, in its version of this history, calls the king Artaxerxes; that, in taking our Artachshast to be Artaxerxes Longimanus, we have the support of a considerable resemblance in the two names; and lastly, that (if Xerxes is the Achashverosh of the books of Esther and Ezra) we not only avoid the evil attending the other alternative—the evil of being obliged to recognise him under two widely different names in almost contemporaneous books—but also find Artaxerxes under one and the same name in the books of Ezra and Nehemiah. This last argument proceeds on the assumption that the Artachshast of whom Ezra and Nehemiah speak is the same person; and, as Ezra and Nehemiah were decidedly contemporaries (*Neh.* viii. 9), the reasons here adduced may derive some additional force from the arguments brought forward below.

The third ARTACHSHAST (the forms in the Hebrew and Sept. are the same as in the last case) is the Persian king who, in the twentieth year of his reign, considerably allowed Nehemiah to go to Jerusalem for the furtherance of purely national objects, invested him with the government of his own people, and allowed him to remain there for twelve years (*Neh.* ii. 1, sq.; v. 14). It is almost

unanimously agreed that the king here intended is Artaxerxes Longimanus, who reigned from the year 461 to 425 B.C. The date of Nehemiah's departure is, therefore, the year 444 B.C. Some few have indeed maintained (and it seems principally for the purpose of reconciling *Neh.* xiii. 25, with Josephus, *Antiq.* xi. 8) that the king here referred to is Artaxerxes Mneumon, who reigned from the year B.C. 401 to 359; and J. D. Michaelis (*Anmerk. f. Ungel.*) admits that he should not know how to refute any one who advocated that opinion. Bertholdt, however (*Einleit.* iii. 1014), endeavours to find a conclusive argument in the fact that Eliashib, who was the high-priest when Nehemiah arrived at Jerusalem (iii. 1), was the grandson of the high-priest Jeshua, who accompanied the first colony under Zerubbabel (xii. 1, 10). He argues, namely, that the three generations which elapsed between the accession of Cyrus and the arrival of Nehemiah, and which in the ordinary computation amount to ninety-nine years, tally so exactly with the ninety-two years which intervene between the first year of Cyrus and the twentieth year of Artaxerxes Longimanus, as to render it far more probable that the latter is the Artachshast of the book of Nehemiah; whereas, on the supposition that Artaxerxes Mneumon is the person meant, Eliashib and his father and grandfather must have enjoyed the high-priesthood between them for the incredible period of 154 years.—J. N.

ARTEMAS (Ἀρτεμάς). This name (which is a contraction for Artemidorus) occurs only once (*Tit.* iii. 12), as that of an esteemed disciple whom St. Paul designed to send into Crete to supply the place of Titus, whom he invited to visit him at Nicopolis. When the Epistle was written, the Apostle seems not to have decided whether he should send Artemas or Tychicus for this purpose.

ARTEMIS (Ἄρτεμις, Acts xix. 24), the Diana of the Romans, is a goddess known under various modifications, and with almost incompatible attributes. As the tutelary divinity of Ephesus, in which character alone she concerns us here, she was undoubtedly a representative of the same power presiding over conception and birth which was adored in Palestine under the name of ASHTORETH. She is therefore related to all the cognate deities of that Asiatic Juno-Venus, and partakes, at least, of their connection with the moon. Creuzer has combined a number of testimonies in order to show how her worship was introduced into Ephesus from the coasts of the Black Sea; and endeavours to point out the several Medo-Persian, Egyptian, Libyan, Scythian, and Cretan elements of which she is compounded (*Symbolik.* ii. 115, sq.).

Her earliest image, which was said to have fallen from heaven, was probably very rude, and, to judge from its representation on ancient coins, little more than a head with a shapeless trunk, supported by a staff on each side. There is some dispute as to the material of which her image was made. Most authorities say it was of ebony, the black colour being, as Creuzer thinks, symbolical. Pliny relates that Mucianus, who had seen it, affirms that it was of the wood of the vine, and that it was so old that it had survived seven restorations of the temple (*Hist. Nat.* xvi. 79). According to Xenophon, it was of gold (*Anab.*



7. 3). The later image with the full development of attributes, of which we give a representation below, is, as Creuzer says, a Pantheon of Asiatic and Egyptian deities. Even in it, however, we see how little influence Greek art had in modifying its antique rudeeness. It is still more like a mummy than a Greek statue. Some of the most significant attributes in this figure are—The turreted head, like that of Cybele; the nimbus behind it representing the moon; the zodiacal signs of the bull, the twins, and the crab on her bosom; below them, two garlands, one of flowers and the other of acorns; the numerous breasts; the lions, stags, and cows in various parts; the bees and flowers on the sides; and others described in Millin's *Galerie Mythol.* i. 26. Her priests were called Megabyzi, and were eunuchs.

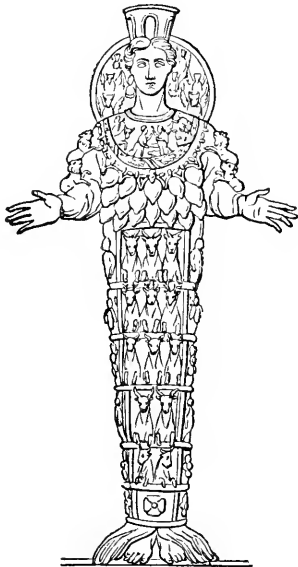

The Arabic version of the Acts renders Artemis, in the chapter cited, by *Az Zuharat*, which is the Arabic name for the planet Venus.—J. N.

ARTICLES. In the later development of languages, logical fulness and accuracy are attained at the expense of conciseness and delicacy; and, if not before, at least in this stage the small words called *articles* are uniformly produced. If we confined our view to the languages which are derived from Latin, we might easily believe that

the presence of these parts of speech is a symptom and proof that the later and logical stage is already reached: for in French, Italian, Spanish, and Portuguese, derivatives from the Latin *ille* and *unus* fulfil the part of the English *the* and *a*. Nor is the lesson taught by the Greek language apparently very different: for in its earliest extant specimens (the poems of Homer), the word δ , η , $\tau\delta$ is far oftener used as a demonstrative or relative pronoun, than as the definite article. We seem to be able to trace its growth and establishment in this later function; and we are tempted to infer from its appearing so much earlier in Greek than in Latin, that this is owing to the earlier development of logical acuteness in the Greek mind. Finally, in modern Greek, the old numeral $\epsilon\iota\varsigma$, $\epsilon\nu\delta\acute{\epsilon}\varsigma$, *one*, has given birth to a new indefinite article, $\epsilon\nu\alpha\varsigma$, perfectly analogous to the Italian *uno*, French *un*, and English *a*.

We are here perhaps in danger of building up a theory too rapidly. It is true, that in languages generally, the early and poetical style is defective in articles, while the late, prosaic, and logical style is even redundant with them. Nevertheless, we cannot safely infer a high logical cultivation, much less the attainment of the secondary stage of development, from the presence of articles in a language. Hebrew has possessed a definite article as long as it can be traced back; but it would be too much to impute it to an unusually strong and premature argumentative acuteness in the nations of Canaan, whose speech the family of Isaac adopted. That there is a germ of truth in this matter, we believe; but until the relation of the Syro-Arabian to the older languages which they supplanted is better understood, it is hazardous to engage in any of these speculations.

So much can be stated as fact. If a language has as yet no definite article, it will gradually form one out of its demonstrative pronoun, provided that it be not tied down to a fixed state by imitating classical models. Under the same circumstances, there is a tendency to generate an indefinite article out of the numeral *one*. Closely akin to the last is the use of the word that properly means *single*, in the sense of the indefinite article—a change which can be traced in the Bagdad dialect of Arabic.

In the Hebrew language the definite article, as printed in our books, appears under the form \aleph (*ha*), accompanied by a redoubling of the following consonant, if it be such a consonant as Hebrew euphony allows to be doubled. It is not to be questioned that the real word, when isolated, was \aleph (*hal*), corresponding to the Arabic \aleph (*al* or *el*), especially as the final *l* in the Arabic article also is, in numerous cases, assimilated to the consonant which follows. The Hebrews have one demonstrative form \aleph (*elle*) *these*, which approaches remarkably near to the Arabic; and there is some reason for regarding \aleph as a composite, or at least an elongated form, of which \aleph (*ku*) *he*, is the root. To this attach themselves two different consonants to denote the ideas of **THAT** and **THIS**, **L** and **DH**, which latter becomes **z** or **ð** in different dialects. The **DH** is found in pure Arabic (as, indeed, in English, strange to think!); but in Hebrew it is **z**, in Chaldee **ð**, in German **n**, in Greek **τ**; though, in these Eu-

ropean tongues the idea of THAT predominates over THIS. The *i* is found in Latin (*ille*, that); and the old Latin words *alli*, *oltra*, are thought to indicate that *yon*, *yonder*, is its primitive sense. Just so, $\text{הַלְאָ} (hāl'a)$ for *ultra*, *beyond*.

As regards the *form* of the Hebrew article, it thus appears that the root *ho* or *hu* first took to itself the terminating *l*, and then in pronunciation gradually rubbed it off again.

The radical element of the Greek article vacillates between *ho* and *to*; and a general survey of all the kindred languages makes it probable that these are mere varieties of the same root. In Latin and in Zend the *h* maintains its place throughout; in Sanscrit the Greek *ho* and *to* change into *sa* and *ta*, this relation of *h* to *s* being notoriously common. In Lithuanian only *ta* is found; and the *seo*, *dha*, of the Anglo-Saxon, sufficiently establish the connection of *sa* with *ta*; for the sound *th*, by mere lisping, naturally degenerates into either *s* or *t*, and *dh* into *z* or *d*. We are thus nearly brought to a conviction that the two elements *hu* and *dha* of the Syro-Arabian languages were, at a much earlier stage, variations of but one root. Nor is this opinion absurd; so many are the proofs of the extreme antiquity of the *material* which is so differently worked up in extant languages. In fact, the root *hu* (this) shows itself likewise in the Welsh tongue.

The Chaldee branch of the Syro-Arabian has a peculiarity of its own, in compensation for the definite article. This consists in the annexation of the vowel N at the end of nouns, to produce what is called the emphatic state; which is practically, it seems, equivalent in sense to the English *the*. Whether this termination has any etymological relation to the Hebrew article is uncertain. In Arabic, especially in its modern Syrian dialect, a very similar elongation of nouns is common, with a view of giving specification or individuality to that which was collective: as

طين (*tīn*), fig or figs; طينة (*tīna*), a fig;

سمن (*semn*), butter; سمنة (*semna*), a piece of butter. This, however, agrees more nearly to the indefinite than to the definite article; nor does its *construct* form indicate relationship to the Chaldee termination.

It belongs to grammars of the special languages to discuss the uses of the article, and only a few general remarks can find place here. The chief peculiarity in Hebrew occurs with words joined in what is technically called 'regimen' or 'construction'; in which case a *single* article between the two nouns serves to define both of them.

Thus, $\text{בֶּן הַמֶּלֶךְ} (ben hal-melk)$ means, *the son of the king*. If the Hebrews wish to join two nouns in this relation, so as to define the latter and leave the former undefined, they are forced to abandon the *construct* form, and to employ the preposition לְ , which in this case is to be rendered *of*, not *for*. Thus, 'A Psalm of David' is $\text{מִזְמוֹר לְדָוִד} (mizmor li David)$. This remark, we believe, was made first by Ewald.

The importance which some critics have given to the Greek article, in regard to the Trinitarian controversy, is truly extraordinary. Even Mr. Scholefield, as professor of Greek at Cambridge, did not

hesitate to assert that, in Ephes. v. 5, the words $\text{ἐν τῇ βασιλείᾳ τοῦ Χριστοῦ καὶ Θεοῦ}$, should be translated, 'in the kingdom of (him who is) Christ and God.' It seems to have been taken for granted, that, contrary to the practice of all other nations, the Greeks allowed themselves no latitude as to the use of the article; and this, though proof to the contrary is so close at hand, both in the New Testament and in classical writers. It is undoubtedly more perspicuous, when two nouns are in apposition or immediate connection, to repeat the article if they refer to different objects; just as we should say, *The king and general*, if one person were intended, but *the king and the general*, if they were two persons. But such rules often give way, in cases where no ambiguity is apprehended. Thus, Hebr. ix. 19, $\text{τὸ αἷμα τῶν μόσχων καὶ τράγων}$, 'the blood of the calves and goats,' for 'of the calves and the goats.' This is equally common in the classics; as in the opening words of Thucydides: 'Thucydides of Athens wrote the history of the war of the Peloponnesians and Athenians,' $\text{τὸν πόλεμον τῶν Πελοποννησίων καὶ Ἀθηναίων}$. Another rule which some have sought to establish is, that when a noun is followed by another noun in the genitive, the latter must take the article, if the former has it. But neither is this universally true; for instance, Hebr. ix. 13, $\text{εἰ γὰρ τὸ αἷμα ταύρων καὶ τράγων}$, 'for if the blood of bulls and goats, &c.'

It seems to be a general result of the history of the article, that in elevated style there is a tendency to drop it, because such style generally savours of the antique and the poetical. Thus, $\text{οὐρανοῦ καὶ γῆ παρελεύσεται}$, 'Heaven and earth shall pass away,' is more elevated than 'The heaven and the earth,' &c. But beside and in contrast to this, every language possesses numerous familiar formulas or special words, from which the article is dropped; and to become acquainted with these is always very difficult. In daily life they abound, not only after prepositions, but as nominative cases: thus, to sit at table; to travel by ship; 'No fear lest dinner cool.' A dim perception of this fact seems to have led to the universal rule (as some have wished to make it), that the article may always be omitted after a preposition.

In the above, we have naturally said little of the *indefinite* article, because it occurs but a few times in the New Testament (*μία*, one, put for *A*), and never in the Hebrew of the Old Testament. Otherwise, though of less importance to language, its history appears to be governed by the same general laws which regulate that of the definite article.—F. W. N.

ARVAD (אַרְבַּד ; *Arados*, 1 Macc. xv. 23), or, as it might be spelt, ARUAD, whence the present name Ruad, a small island and city on the coast of Syria, called by the Greeks Aradus, by which name it is mentioned in 1 Macc. xv. 23. It is a small rocky island, opposite the mouth of the river Eleutherus, to the north of Tripolis, about one mile in circumference and two miles from the shore. Strabo (xvi. p. 753) describes it as a rock rising in the midst of the waves (πέτρα περιλαστος); and modern travellers state that it is steep on every side. Strabo also describes the houses as exceedingly lofty, and they were doubtless so built, on account of the scantiness of the site: hence,

for its size, it was exceedingly populous (Pomp. Mela, l. ii. c. 7). Those of the Arvadites whom the island could not accommodate found room in the town and district of Antaradus, on the opposite coast, which also belonged to them. Arvad is *not* the same as Arpad or Arphad, as most books of Biblical Geography allege.

ARVADITES (אַרְבָּדִיִּם; Sept. Ἀρβάδιοι, Gen. x. 18; 1 Chron. i. 16), the inhabitants of the island Aradus [ARVAD], and doubtless also of the neighbouring coast. The Arvadites were descended from Arvad, one of the sons of Canaan (Gen. x. 18). Strabo (xvi. p. 731) describes the Arvadites as a colony from Sidon. They were noted mariners (Ezek. xxvii. 8, 11; Strabo, xvi. p. 754), and formed a distinct state, with a king of their own (Arrian, *Expedit. Alex.* ii. p. 90); yet they appear to have been in some dependence upon Tyre, for the prophet represents them as furnishing their contingent of mariners to that city (Ezek. xxvii. 8, 11). The Arvadites took their full share in the maritime traffic for which the Phœnician nation was celebrated, particularly after Tyre and Sidon had fallen under the dominion of the Græco-Syrian kings. They early entered into alliance with the Romans, and Aradus is named among the states to which the consul Lucius formally made known the league which had been contracted with Simon Maccabæus (1 Macc. xv. 23).

ARUBOTH. [ARABAH.]

ARUMAH, otherwise RUMAH, a city near Shechem, where Abimelech encamped (Judg. ix. 41).

ASA (אַסָּא, *healing* or *physician*; Sept. Ἀσά), son of Abijah, grandson of Rehoboam, and third king of Judah. He began to reign two years before the death of Jeroboam, in Israel, and he reigned forty-one years, from B.C. 955 to 914. As Asa was very young at his accession, the affairs of the government were administered by his mother, or, according to some (comp. 1 Kings xv. 1, 10), his grandmother Maachah, who is understood to have been a granddaughter of Absalom [MAACHAH]. She gave much encouragement to idolatry; but the young king, on assuming the reins of government, zealously rooted out the idolatrous practices which had grown up during his minority and under the preceding reigns; and only the altars in the 'high places' were suffered to remain (1 Kings xv. 11-13; 2 Chron. xiv. 2-5). He neglected no human means of putting his kingdom in the best possible military condition, for which ample opportunity was afforded by the peace which he enjoyed in the ten first years of his reign. And his resources were so well organized, and the population had so increased, that he was eventually in a condition to count on the military services of 580,000 men (2 Chron. xiv. 6-8). In the eleventh year of his reign, relying upon the Divine aid, Asa attacked and defeated the numerous host of the Cushite king Zerah, who had penetrated through Arabia Petraea into the vale of Zephathah, with an immense host, reckoned at a million of men (which Josephus reduces, however, to 90,000 infantry and 100,000 cavalry, *Antiq.* viii. 12. 1), and 300 chariots (2 Chron. xiv. 9-15). As the triumphant Judahites were returning, laden with spoil, to Jerusalem, they were met by the prophet Azariah,

who declared this splendid victory to be a consequence of Asa's confidence in Jehovah, and exhorted him to perseverance. Thus encouraged, the king exerted himself to extirpate the remains of idolatry, and caused the people to renew their covenant with Jehovah (2 Chron. xv. 1-15). It was this clear knowledge of his dependent political position, as the vice-gerent of Jehovah, which won for Asa the highest praise that could be given to a Jewish king—that he walked in the steps of his ancestor David (1 Kings xv. 11).

Nevertheless, towards the latter end of his reign the king failed to maintain the character he had thus acquired. When Baasha, king of Israel, had renewed the war between the two kingdoms, and had taken Ramah, which he was proceeding to fortify as a frontier barrier, Asa, the conqueror of Zerah, was so far wanting to his kingdom and his God as to employ the wealth of the Temple and of the royal treasures to induce the king of Syria (Damascus) to make a diversion in his favour by invading the dominions of Baasha. By this means he recovered Ramah, indeed; but his treasures were squandered, and he incurred the rebuke of the prophet Hanani, whom he cast into prison, being, as it seems, both alarmed and enraged at the effect his address was calculated to produce upon the people. Other persons (who had probably manifested their disapprobation) also suffered from his anger (1 Kings xv. 16-22; 2 Chron. xvi. 1-10). In the three last years of his life Asa was afflicted with a grievous 'disease in his feet'; and it is mentioned to his reproach that he placed too much confidence in his physicians. At his death, however, it appeared that his popularity had not been substantially impaired; for he was honoured with a funeral of unusual cost and magnificence (1 Chron. xvi. 11-14). He was succeeded by his son Jehoshaphat.

ASAHIEL (אַסָּהִיֵּל, *God's creature*; Sept. Ἀσαήλ), son of David's sister Zeruah, and brother of Joab and Abishai. He was noted for his swiftness of foot; and after the battle at Gibeon he pursued and overtook Abner, who, with great reluctance, in order to preserve his own life, slew him with a backthrust of his spear, B.C. 1055 [ABNER] (2 Sam. ii. 18-23).

ASAPH (אַסָּפָּה, *assembler*; Sept. Ἀσάφ), a Levite, son of Baruchias (1 Chron. vi. 39; xv. 17), eminent as a musician, and appointed by David to preside over the sacred choral services which he organized. The 'sons of Asaph' are afterwards mentioned as choristers of the temple (1 Chron. xxv. 1, 2; 2 Chron. xx. 14; xxix. 13; Ezra ii. 41; iii. 10; Neh. vii. 44; xi. 22); and this office appears to have been made hereditary in his family (1 Chron. xxv. 1, 2). Asaph was celebrated in after times as a prophet and poet (2 Chron. xxix. 30; Neh. xii. 16), and the titles of twelve of the Psalms (lxxiii. to lxxxiii.) bear his name. The merits of this appropriation are elsewhere examined [PSALMS].—There were two other persons named Asaph: one who occupied the distinguished post of mazkir (מַזְכִּיר) or 'recorder' to king Hezekiah (2 Kings xviii. 18; Isa. xxxvi. 3); another who was keeper of the royal forests under Artaxerxes (Neh. ii. 8).

ASCENSION. The event spoken of under this title is among those which Christians of every

age have contemplated with most profound satisfaction. It was in his ascension that Christ exhibited the perfect triumph of humanity over every antagonist, whether in itself, or in the circumstances under which it may be supposed to exist. The contemplation of this, the entrance of the Redeemer into glory, inspired the prophets of old with the noblest views of his kingdom. 'Thou hast ascended on high; thou hast led captivity captive; thou hast received gifts for men; yea, for the rebellious also, that the Lord God might dwell among them' (Ps. lxxviii. 18); and 'Lift up your heads, O ye gates; and be ye lift up, ye everlasting doors, and the king of glory shall come in' (Ps. xxiv. 9). That something of vast importance, in respect to the completion of the great scheme of salvation, was involved in this event, appears from the words of our Lord himself, 'Touch me not; for I am not yet ascended to my Father: but go to my brethren, and say unto them, I ascend unto my Father, and your Father; and to my God and your God' (John xx. 17). Nor was it till this had taken place that he poured out the grace of the Spirit upon his church, or began the higher exercises of his office as a mediating priest. In the primitive church, the feast of the Ascension, called also by St. Chrysostom the Assumption of Christ, was considered, like the solemn days of the Nativity and the Passion, as of apostolic origin. St. Chrysostom, in his homily on the subject, calls it an illustrious and refulgent day, and describes the exaltation of Christ as the grand proof of God's reconciliation to mankind (*Opp. t. ii. p. 457*).—H. S.

ASENATH (אַסְנַת; Sept. Ἀσενέθ), the daughter of Potipherah, priest of On, whom the king of Egypt bestowed in marriage upon Joseph, with the view probably of strengthening his position in Egypt by this high connection. The considerations suggested by this marriage belong to another place [JOSAPHAT]; attention is here only required to the name, which, in common with other words of foreign origin, has attracted considerable notice. No better etymology of Asenath has been proposed than that by Jablonski, who (*Panth. Egypt. i. 56, and Opusc. ii. 208*) regards the forms Asenath and Ἀσενέθ as representative of a Coptic compound *Assheneit*. The latter part of this word he takes to be the name of Neith, the titular goddess of Sais, the Athene of the Greeks; and considers the whole to mean *worshipper of Neith*. Gesenius, in his *Thesaurus*, suggests that the original Coptic form was *Asneith*, which means, *who belongs to Neith*—quæ Neithæ est. That the name refers to this goddess is the generally received opinion (in modern times, Von Bohlen alone has, in his *Genesis*, proposed an unsatisfactory Semitic etymology): it is favoured by the fact that the Egyptians, as Jablonski has shown, were accustomed to choose names expressive of some relation to their gods; and it appears liable to no stronger objection than the doubt, whether the worship of Neith existed at so early a period as that of the composition of the book of *Genesis*.

ASH. [OREN.]

ASHDOD (אַשְׁדּוֹד; Sept. Ἀζωτος), the Azotus of the Greeks and Romans, and so called in 1 Macc. iv. 15; Acts viii. 40 (see also *Plin. Hist. Nat. v. 14; Ptolem. v. 16*); a city

on the summit of a grassy hill, near the Mediterranean coast, nearly mid-way between Gaza and Joppa, being 18 geog. miles N. by E. from the former, and 21 S. from the latter; and more exactly mid-way between Askelon and Ekron, being 10 geog. miles N. by E. from the former, and S. by W. from the latter. Ashdod was a city of the Philistines, and the chief town of one of their five states (*Josh. xiii. 3; 1 Sam. vi. 17*). It was the seat of the worship of Dagon (1 Sam. v. 5; 1 Macc. xi. 4), before whose shrine in this city it was that the captured ark was deposited and triumphed over the idol (1 Sam. v. 1-9). Ashdod was assigned to Judah; but many centuries passed before it and the other Philistine towns were subdued [PHILISTINES]; and it appears never to have been permanently in possession of the Judabites, although it was dismantled by Uzziah, who built towns in the territory of Ashdod (1 Chron. xxvi. 6). It is mentioned to the reproach of the Jews after their return from captivity, that they married wives of Ashdod; the result of which was that the children of these marriages spoke a mongrel dialect, compounded of Hebrew and the speech of Ashdod (*Neh. xiii. 23, 24*). These facts indicate the ancient importance of Ashdod. It was indeed a place of great strength; and being on the usual military route between Syria and Egypt, the possession of it became an object of importance in the wars between Egypt and the great northern powers. Hence it was secured by the Assyrians before invading Egypt (*Isa. i. 1, sq.*); and at a later date it was taken by Psammetichus, after a siege of twenty-nine years, the longest on record (*Herodot. ii. 157*). The destruction of Ashdod was foretold by the prophets (*Jer. xxv. 20; Amos i. 8; iii. 9; Zeph. ii. 4; Zach. ix. 6*); and was accomplished by the Maccabees (1 Macc. v. 68; x. 77-84; xi. 4). It is enumerated among the towns which Pompey joined to the province of Syria (*Joseph. Antiq. xiv. 4. 4, De Bell. Jud. i. 7. 7*), and among the cities ruined in the wars, which Gabinus ordered to be rebuilt (*Antiq. xiv. 5. 3*). It was included in Herod's dominion, and was one of the three towns bequeathed by him to his sister Salome (*De Bell. Jud. vii. 8. 1*). The evangelist Philip was found at Ashdod after he had baptized the Ethiopian eunuch (*Acts viii. 40*). Azotus early became the seat of a bishopric; and we find a bishop of this city present at the councils of Nice, Chalcedon, A.D. 359, Seleucia, and Jerusalem, A.D. 536 (*Reland, Palestina, p. 609*).

Ashdod subsisted as a small unwallied town in the time of Jerome. It was in ruins when Benjamin of Tudela visited Palestine (*Itin. ed. Asher, i. 79*); but we learn from William of Tyre and Vitriacus that the bishopric was revived by the Latin Christians, at least titularly, and made suffragan of Treves. Sandys (*Travaux, p. 151*) describes it as 'a place of no reckoning;' and Zuallart (*Voyage, iv. p. 132*) speaks of it as an Arab village. And this seems to be its present condition, for Irby and Mangles (*p. 180*) describe it as inhabited. The site is marked by ancient ruins, such as broken arches, and partly buried fragments of marble columns: there is also what appeared to these travellers to be a very ancient khan, the principal chamber of which had obviously, at some former period, been used

as a Christian chapel. The place is still called **أسدود** *Esdud*.

ASHER (אֲשֵׁר, *happiness*; Sept. Ἀσῆρ), one of the sons of Jacob by Zilpah, the handmaid of Leah (Gen. xxx. 13; xxxv. 26), and founder of one of the twelve tribes (Num. xxvi. 44-47). Asher had four sons and one daughter (Gen. xlix. 20; Deut. xxxiii. 24). On quitting Egypt the number of adult males in the tribe of Asher was 41,500, which made it the ninth of the tribes (excluding Levi) in numbers—Ephraim, Manasseh, and Benjamin only being below it. But before entering Canaan an increase of 11,900—an increase exceeded only by Manasseh—raised the number to 53,400, and made it the fifth of the tribes in population (comp. Num. i. 40, 41; xxvi. 47). The inheritance of this tribe lay in a very fruitful country, on the sea-coast, with Lebanon north, Carmel and the tribe of Issachar south, and Zebulon and Naphtali east. It is usually stated that the whole of the Phœnician territories, including Sidon, were assigned to this tribe. But there are various considerations which militate against this conclusion (see the arguments on both sides in *Pictorial Bible*, Num. xxvi. 21; Josh. xix. 21; Judg. i. 31), and tend to show that the assigned frontier-line was drawn out to the sea south of Sidon. The strongest text for the inclusion of Sidon (Tyre was not then founded) is that in which it is mentioned to the reproach of the Asherites, that they did not drive out the Sidonians (Judg. i. 31). This Michaelis is disposed to reject as an interpolation; but J. Kitto (*Pict. Bib.* in loc.) conceives it to denote that the Asherites were unable to expel the Sidonians, who by that time had encroached southward into parts of the coast actually assigned to the Asherites; and he strengthens this by referring to the subsequent foundation of Tyre, as evincing the disposition of the Sidonians to colonize the coast south of their own proper territories. The Asherites were for a long time unable to gain possession of the territories actually assigned them, and 'dwelt among the Canaanites, the inhabitants of the land' (Judg. i. 32); and, 'as it is not usual to say of a larger number that it dwells among the smaller, the inference is, that they expelled but comparatively few of the Canaanites, leaving them, in fact, a majority of the population' (Bush, note on Judg. i. 32).

ASHES, in the symbolical language of Scripture, denote human frailty (Gen. xviii. 27), deep humiliation (Esth. iv. 1; Jonah iii. 6; Matt. xi. 21; Luke x. 13; Job xlii. 6; Dan. ix. 3). To sit in ashes was a token of grief and mourning (Job ii. 8; Lam. iii. 16; Ezek. xxvii. 30), as was also strewn them upon the head (2 Sam. xiii. 10; Isa. xli. 3) [**MOURNING**]. 'Feeding on ashes,' in Ps. cii. 9, appears to express grief, as of one with whose food the ashes with which he is covered mingle. But in Isa. xlii. 20, 'feeding on ashes,' which afford no nourishment, is judged to denote ineffectual means, labour to no purpose. Compare Hos. xii. 1.

ASHIMA (אֲשִׁימָה, 2 Kings xvii. 30; Sept. Ἀσιμαθ) is only once mentioned in the Old Testament as the god of the people of Hamath. The Babylonian Talmud, in the treatise 'Sanhedrin' (cited in Carpzov's *Apparatus*, p. 516), and the

majority of Jewish writers, assert that Ashima was worshipped under the form of a *goat without wool*; the Talmud of Jerusalem says, under that of a *lamb*. Elias Levita, a learned Rabbi of the sixteenth century, assigns the word the sense of *ape*; in which he was, in all probability, deceived by the resemblance in sound to the Latin *simia*. Jurien and Calmet have proposed other fanciful conjectures. The opinion, however, that this idol had the form of a goat appears to be the one best supported by arguments as well as by authorities. Thus Pfeiffer (in his *Dubia Vexata*, ad loc.) suggests that ashima may be brought into relation with the word אֲשִׁמָה, which the Samaritan version uses in the sense of some species of goat, as a translation of the original אֲשִׁמָה in Deut. xiv. 5. On this ground we might conjecture that the word ashima actually means a goat without wool, by deriving it from אֲשִׁמָה, which, though it usually signifies *to be guilty*, yet occurs in the sense of *to be laid waste, to be bare*, as a cognate of אֲשִׁמָה and אֲשִׁמָה: so that ashima would mean *bare, bald*. Besides, as a goat, the Egyptian god Mendes would afford an excellent parallel to Ashima; as likewise the Greek Pan (cf. Lev. xvii. 7).

It is worthy of mention that the name of this idol furnished Aben Ezra with an opportunity of displaying the inveterate hatred of the Jews against the Samaritans. In his preface to the book of Esther, he asserts that the Samaritan text of Gen. i. 1, begins with the words 'In the beginning Ashima created.' It need hardly be said that there is no trace of this reading either in the Samaritan text or version. Aben Ezra's own words are cited at length in Hottinger's *Exercit. Antimorin.* p. 40.—J. N.

ASHKENAZ (אֲשִׁכַּנַּז; Sept. Ἀσχαναζ; Gen. x. 3); and **ASCHENAZ** (Jer. li. 27), the proper name of a son of Gomer, son of Japhet, and of a tribe of his descendants. In Jeremiah it is placed with Ararat and Minni, provinces of Armenia; whence it is probable that Ashkenaz was a province of Armenia; or at least that it lay not far from it, near the Caucasus, or towards the Black Sea. The commentators have been all bound to something like this conclusion by the passage in Jeremiah, and nothing more satisfactory is now attainable. The various fanciful attempts to trace the name may be seen in Winer (*Bib. Realwört.*, s. v. 'Askenas'). The modern Jews fancy the name denotes the Germans.

ASHPENAZ, chief of the eunuchs of king Nebuchadnezzar, to whose care Daniel and his companions were consigned, and who changed their names (Dan. i. 3, 7).

ASHTAROTH (עֲשֵׁתָרוֹת; Sept. Ἀσθαρῶθ), and **ASHTAROTH-CARNAIM** (עֲשֵׁתָרוֹת קַרְנַיִם; Sept. Ἀσθαρῶθ καὶ Καρναῖν), a town of Bashan (Deut. i. 4; Josh. ix. 10) which was included in the territory of the half-tribe of Manasseh (Josh. xiii. 31), and was assigned to the Levites (1 Chron. vi. 71). It is placed by Eusebius 6 miles from Edrei, the other principal town of Bashan, and 25 miles from Bostra. The town existed in the time of Abraham (Gen. xiv. 5); and as its name of Ashtaroth appears to be derived from the worship of the moon under that name [see the following article], there is little need to look further than the crescent of that luminary and its symbolical image for an explanation of the addition CAR-

NAIM, or rather **KARNAIM**, 'horned.' In 2 Macc. xii. 26, mention is made of the temple of Atergatis (Ashtaroth) in Carnion, which is described as a strongly fortified town of difficult access, but which was taken by Judas Maccabæus, who slew 25,000 of the people therein (2 Macc. xii. 21, 26). Ashtaroth-Carnaim is now usually identified with Mezarëib, the situation of which corresponds accurately enough with the distances given by Eusebius. Here is the first castle on the great pilgrim road from Damascus to Mecca. It was built about 340 years ago by the Sultan Selim, and is a square structure, about 100 feet on each side, with square towers at the angles and in the centre of each face, the walls being 40 feet high. The interior is an open yard with ranges of warehouses against the castle wall to contain stores of provisions for the pilgrims. There are no dwellings beyond the castle, and within it only a few mud huts upon the flat roofs of the warehouses, occupied by the peasants who cultivate the neighbouring grounds. Close to this building on the north and east side are a great number of springs, whose waters at a short distance collect into a lake or pond about a mile and a half in circumference. In the midst of this lake is an island, and at an elevated spot at the extremity of a promontory advancing into the lake, stands a sort of chapel, around which are many ruins of ancient buildings. There are no other ruins. (Burckhardt, p. 242; Buckingham's *Arab Tribes*, p. 162.)

ASHTORETH (אֲשֶׁת־אֲרִיָּה, 1 Kings xi. 5; Sept. Ἀστάρη) is the name of a goddess of the Sidonians (1 Kings xi. 5, 33), and also of the Philistines (1 Sam. xxxi. 10), whose worship was introduced among the Israelites during the period of the judges (Judg. ii. 13; 1 Sam. vii. 4), was celebrated by Solomon himself (1 Kings xi. 5), and was finally put down by Josiah (2 Kings xxiii. 13). She is frequently mentioned in connection with Baal, as the corresponding female divinity (Judg. ii. 13); and, from the addition of the words, 'and all the host of heaven,' in 2 Kings xxiii. 4 (although Asherah occurs there, and not 'Ashtoreth, which will be accounted for below), it is probable that she represented one of the celestial bodies. There is also reason to believe that she is meant by the 'queen of heaven,' in Jer. vii. 18; xlv. 17; whose worship is there said to have been solemnised by burning incense, pouring libations, and offering cakes. Further, by comparing the two passages, 2 Kings xxiii. 4, and Jer. viii. 2, which last speaks of the 'sun and moon and all the host of heaven, whom they served,' we may conclude that the moon was worshipped under the names of queen of heaven and of 'Ashtoreth, provided the connection between these titles is established. This constitutes nearly the sum of all the indications in the Old Test. concerning 'Ashtoreth.

According to the testimonies of profane writers, the worship of this goddess, under different names, existed in all countries and colonies of the Syro-Arabian nations. She was especially the chief female divinity of the Phœnicians and Syrians—the Baaltis (*i. e.* בעלתִי *domina mea*, equivalent to the Greek address, Δέσποινα!) to Baal; Ἀστάρη ἢ μεγίστη, as Sanchoniaton calls her (ed. Orelli, p. 34). She was known to the Babylonians as Mylitta (*i. e.* possibly מולרתא, the

emphatic state of the feminine participle active of *Aphel, genetricis*, Herod. i. 131; to the Arabians as Alitta, or Alilat, Herod. iii. 8 (*i. e.* according to Pocock's etymology—*Specim.* p. 110)—al Ilahat, the goddess [which may, however, also mean the *crenescent moon*—see Freytag's *Lex. Ar.*]; or al Hilâl, the moon; or, according to Kleuker's suggestion, al Walid, *genetricis*. See Bergmann, *De Relig. Arab. Antëistamica*. Argentor. 1834.

p. 7). The supposed Punic name Tholath, תלת, which Münter, Hamaker, and others considered to mean *genetricis*, and to belong to this goddess, cannot be adduced here, as Gesenius has recently shown that the name has arisen from a false reading of the inscriptions (see his *Monum. Ling. Phœnic.* p. 114). But it is not at all open to doubt that this goddess was worshipped at ancient Carthage, and probably under her Phœnician name.

The classical writers, who usually endeavoured to identify the gods of other nations with their own, rather than to discriminate between them, have recognised several of their own divinities in Ashtoreth. Thus she was considered to be *Juno* (Βῆλθις ἢ Ἥρα ἢ Ἀφροδίτη, Hesychius; 'Juno sine dubitatione a Pœnis Astarte vocatur,' Augustin. *Quæst. in Jud.* xvi.); or *Venus*, especially *Venus Urania* (Cicer. *Nat. Deor.* iii. 23; Ἀστάρτη δὲ ἐστὶν ἢ παρ' Ἑλλήσιν Ἀφροδίτη προσαγορευομένη, Theodoret. *in Libr.* iii. *Reg. Quæst.* i.; and the numerous inscriptions of Bona Dea Cœlestis, Venus Cœlestis, &c., cited in Münter's *Religion der Karthager*, p. 75); or *Luna* (Οὐρανίαν Φοίνικες Ἀστροδάρχην ὀνομάζουσι, σελήνην εἶναι θέλοντες, Herodian, v. 13; Lucian *De Dea Syria*, iv.).

The fact that there is a connection between all these divinities cannot escape any student of ancient religions; but it is not easy to discover the precise link of that connection. Winer ingeniously suggests (*Bibl. Realwört.*) that Ashtoreth was confounded with Juno, because she is the female counterpart to Baal, the chief god of the Syrians—their Jupiter, as it were; and with Venus, because the same lascivious rites were common to her worship, and to that of Ashtoreth and her cognate Mylitta (Cruzer's *Symbolik*, ii. 23). But so great is the intermixture and confusion between the gods of pagan religions, 'pro diversitate nominis, non pro nominis varietate,' as Ambrose says, that Münter further identifies Ashtoreth—due allowance being made for difference of time and place—with the female Kabîr, Axiokersa, with the Egyptian Isis, with the Paphian Venus, with the Taurian and Ephesian Diana, with the Bellona of Comana, with the Armenian Anâhîd, and with the Samian, Maltesian, and Lacinian Juno. She has also been considered to be the same as the Syrian *fish-deities* [ATERGATIS].

As for the power of nature, which was worshipped under the name of Ashtoreth, Cruzer and Münter assert that it was the principle of conception and parturition—that subordinate power which is fecundated by a superior influence, but which is the agent of all births throughout the universe. As such, Münter maintains, in his *Religion der Babylonier*, p. 21, in opposition to the remarks of Gesenius in his *Jesajas*, iii. 337—that the original form under which Ashtoreth was worshipped

was the moon; and that the transition from that to the planet Venus (which we will immediately notice) was unquestionably an innovation of a later date. It is evident that the moon alone can be properly called the queen of heaven; as also that the dependent relation of the moon to the sun makes it a more appropriate symbol of that sex, whose functions as female and mother, throughout the whole extent of animated nature, were embodied in Ashtoreth [BAAL].

The rites of her worship, if we may assume their resembling those which profane authors describe as paid to the cognate goddesses, in part agree with the few indications in the Old Test., in part complete the brief notices there into an accordant picture. The cakes mentioned in Jer. vii. 18, which are called in Hebrew כִּנִּים *Kannim*, were also known to the Greeks by the name *χαβῶνες*, and were by them made in the shape of a sickle, in reference to the new moon. Among animals, the dove, the crab, and, in later times, the lion, were sacred to her; and among fruits, the pomegranate. No blood was shed on her altar; but male animals, and chiefly kids, were sacrificed to her (Tacit. *Hist.* ii. 3). Hence some suppose that the reason why Judah promised the harlot a kid, was that she might sacrifice it to Ashtoreth (see Tuch's note to Gen. xxxviii. 17). The most prominent part of her worship, however, consisted of those libidinous orgies, which Augustine, who was an eye-witness of their horrors in Carthage, describes with such indignation (*De Civit. Dei*, ii. 3). Her priests were eunuchs in women's attire (the peculiar name of whom is קְרִישִׁים, *sacri*, i. e. *cinædi*, Galli—1 Kings xiv. 24), and women (קְרִישֹׁת, *sacræ*, i. e. *meretrices*—Hos. iv. 14, which term ought to be distinguished from ordinary harlots, זֹנוֹת, who, like the Bayaderes of India, prostituted themselves to enrich the temple of this goddess. The prohibition in Deut. xxiii. 18 appears to allude to the dedication of such funds to such a purpose.

As for the places consecrated to her worship, although the numerous passages in which the authorized version has erroneously rendered אֲשֶׁרָה by *grove*, are to be deducted (as is explained below), there are yet several occasions on which *gardens* and *shady trees* are mentioned as peculiar seats of (probably, *her*) lascivious rites (Isa. i. 29; lxx. 3; 1 Kings xiv. 23; Hos. iv. 13; Jer. ii. 20; iii. 13). She also had celebrated temples (1 Sam. xxxi. 10).

As to the form and attributes with which Ashtoreth was represented, the oldest known image, that in Paphos, was a white conical stone, often seen on Phœnician remains in the figure which Tacitus describes, *l. c.* as 'Simulacrum non effigie humana; continuus orbis latiore initio tenuem inambitum, metâ modo, exurgens, et ratio in obscuro.' Münster is unwilling to consider this a Lingam symbol; nevertheless, there appears to be some room for disputing his opinion. In Canaan she was probably represented as a *cow*. It is said in the book of Tobit i. 5, that the tribes which revolted sacrificed τῆ Βῆαλ τῆ δαμάλει, where the feminine article with Βῆαλ is to be remarked. In Phœnicia, she had the head of a cow or bull, as she is seen on coins. Sanchoiathion states that 'Astarte adopted the head of a bull as a symbol of her sovereignty;' he also



accounts for the *star* which is her most usual emblem, by saying that 'when she passed through the earth, she found a fallen star, which she consecrated in Tyre (*l. c.* p. 34). At length, she was figured with the human form, as Lucian expressly testifies of the Syrian goddess—which is substantially the same as Ashtoreth; and she is so found on coins of Severus, with her head surrounded with rays, sitting on a lion, and holding a thunderbolt and a sceptre in either hand. What Kimchi says of her being worshipped under the figure of a *sheep* is a mere figment of the Rabbins, founded on a misapprehension of Deut. vii. 13. As the words עֲשֶׂר־רוֹת *there* occurring may be legitimately taken as the *loves* of the flock (*Feneres pecoris*), i. e. either the *ewes* or the *lambs*, the whole foundation of that opinion, as well as of the notion that the word *means* sheep, is unsound.

The word Ashtoreth cannot be plausibly derived from any root, or combination of roots, in the Syro-Arabian languages. The best etymology, that approved by Gesenius, deduces it from the Persian *sitârah*, *star*, with a prosthetic guttural. The latest etymology is that suggested by Sir W. Betham, in his *Etruria Celtica*, ii. 22, who resolves *Astarte* into the Irish elements: *As, out of; tar, beyond; te, deity—the goddess of long voyages!* Ashtoreth is feminine as to form; its plural Ashtaroth also occurs (and is sometimes erroneously taken to be the proper name of the goddess); but it is understood to denote a plurality of *images* (like the Greek ἑρμῶν), or to belong to that usage of the plural which is found in words denoting *lord* (Ewald's *Hebr. Gram.* § 361).

To come now to ASHERAH אֲשֶׁרָה, Judg. vi. 25): Selden was the first who endeavoured to show that this word—which in the LXX. and Vulgate is generally rendered *grove*, in which our authorized version has followed them—must in *some* places, for the sake of the sense, be taken to mean a *wooden image* of Ashtoreth (*De Diis Syris*, ii. 2). Not long after, Spencer made the same assertion (*De Leg. Hebræor.* L. ii. 16). Vitringa then followed out the same argument, in his note to Isa. xvii. 8. Gesenius, at length, has treated the whole question so elaborately in his *Thesaurus*, as to leave little to be desired, and has evinced that Asherah is a *name*, and also denotes an image of this goddess.

Some of the arguments which support this partial, or, in Gesenius's case, total rejection of the signification *grove*, for אֲשֶׁרָה, are briefly as follows. It is argued that Asherah almost always occurs with words which denote *idols* and *statues of idols*; that the verbs which are employed to express the making an Asherah, are incompatible with the idea of a *grove*, as they are

such as *to build, to shape, to erect* (except in one passage, where, however, Gesenius still maintains that the verb there used means *to erect*); that the words used to denote the destruction of an Asherah are those of *breaking to pieces, subverting*; that the *image* of Asherah is placed in the Temple (2 Kings xxi. 7); and that Asherah is coupled with Baal in precisely the same way as Ashtoreth is: comp. Judg. ii. 13; x. 6; 1 Kings xviii. 19; 2 Kings xxiii. 4; and particularly Judg. iii. 7, and ii. 13, where the plural form of both words is explained as of itself denoting *images* of this goddess. Besides, Selden objects that the signification *grove* is even incongruous in 2 Kings xvii. 10, where we read of '*settling up groves under every green tree.*' Moreover, the LXX. has rendered Asherah by *Astarte*, in 2 Chron. xv. 16 (and the Vulgate has done the same in Judges iii. 7), and, conversely, has rendered *Ashtoreth* by groves, in 1 Sam. vii. 3.

On the strength of these arguments most modern scholars assume that Asherah is a *name* for Ashtoreth, and that it denotes more especially the relation of that goddess to the planet Venus, as the lesser star of good fortune. It appears, namely, to be an indisputable fact that both Baal and Ashtoreth, although their primary relation was to the sun and moon, came in process of time to be connected, in the religious conceptions of the Syro-Arabbians, with the planets Jupiter and Venus, as the two stars of good fortune [See the article MENI]. Although the mode of transition from the one to the other is obscure, yet many kindred circumstances illustrate it. For instance, the connection between Artemis and Selene; that between *Juno* and the planet Venus, mentioned in Creuzer ii. 566; the fact that, in the Zendavesta, Anâhid is the name of the genius of the same planet; and that אַשְׁתֹּרֶת *astro* (which word is only an Aramaic form of the same *sitarah* which, as was remarked above, furnishes the best derivation for Ashtoreth) is also the name of the same planet in the religious books of the Tsaliens (Norberg's *Onomast. Cod. Nasarei*, p. 20). It is in reference to this connection, too, that a *star* is so often found among the emblems with which Ashtoreth is represented on ancient coins. Lastly, whereas the word Asherah cannot, in the sense of *grove*, be legitimately deduced from the primitive or secondary signification of any Syro-Arabian root אֶשֶׁר, as a name of the goddess of good fortune, it admits of a derivation as natural in a philological point of view, as it is appropriate in signification. The verb אֶשֶׁר means *to prosper*; and Asherah is the feminine of an adjective signifying *fortunate, happy*.—J. N.

ASIA. The ancients had no divisions of the world into parts or quarters; and hence the word Asia, in the extended modern sense, does not occur in Scripture. It does not indeed occur at all, in any sense, in the Hebrew Scriptures, but is found in the books of the Maccabees and in the New Testament. It there applies, in the *largest* sense, to that peninsular portion of Asia which, since the fifth century, has been known by the name of Asia Minor; and, in a narrower sense, to a certain portion thereof which was known as Asia Proper. Thus, it is now generally agreed,—1. that 'Asia' denotes the whole of ASIA MINOR, in the texts Acts xix. 26, 27; xx. 4, 16, 18; xxvii. 2, &c.: but, 2. that only ASIA PROPER,

the Roman or Proconsular Asia, is denoted in Acts ii. 9; vi. 9; xix. 10, 22; 2 Tim. i. 15, 1 Pet. i. 6; Rev. i. 4, 11. ASIA MINOR comprehended Bithynia, Pontus, Galatia, Cappadocia, Cilicia, Pamphylia, Pisidia, Lycaonia, Phrygia, Mysia, Troas (all of which are mentioned in the New Testament), Lydia, Ionia, Æolis (which are sometimes included under Lydia), Caria, Doris, and Lycia. ASIA PROPER, or Proconsular Asia, comprehended the provinces of Phrygia, Mysia, Caria, and Lydia (Cicero, *Pro Flacc.* 27; *Ep. Fam.* ii. 15). But it is evident that St. Luke uses the term Asia in a sense still more restricted; for in one place he counts Phrygia (Acts ii. 9, 10), and in another Mysia (xvi. 6, 7), as provinces distinct from Asia. Hence it is probable that in many, if not all, of the second set of references the word Asia denotes only Ionia, or the entire western coast, of which Ephesus was the capital, and in which the seven churches were situated. This is called Asia also by Strabo.

ASIARCHÆ (Ἀσιάρχαι, Acts xix. 31; Vulg. *Asia principes*; Tertull. *præsides sacerdotales*; Auth. Vers. 'certain of the chief of Asia'). These asiarchæ, who derived their appellation from the name of the province over which they presided (as Syriarch, 2 Macc. xii. 2, Lyciarch, Cariarch, &c.), were in Proconsular Asia the chief presidents of the religious rites, whose office it was to exhibit solemn games in the theatre every year, in honour of the gods and of the Roman emperor. This they did at their own expense (like the Roman ædiles), whence none but the most opulent persons could bear the office, although only of one year's continuance. The appointment was much as follows: at the beginning of every year (i. e. about the autumnal equinox) each of the cities of Asia held a public assembly, in order to nominate one of their citizens as asiarch. A person was then sent to the general council of the province, at some one of the principal cities, as Ephesus, Smyrna, Sardis, &c., to announce the name of the individual who had been selected. Of the persons thus nominated by the cities the council designated ten. As the Ἀσιάρχαι are repeatedly mentioned in the plural, some suppose that the whole ten presided as a college over the sacred rites (comp. Strabo, xiv. p. 649). But in Eusebius (*Hist. Eccles.* iv. 15) Polycarp is said to have suffered martyrdom when 'Philip was asiarch and Statius Quadratus proconsul of Asia;' from which and other circumstances it is deemed more probable that, as in the case of the Irenarch, the names of the ten nominated by the general council were submitted to the proconsul, who chose one of the number to be asiarch. Kuinoel (at Acts xix. 31) admits that one chosen by the proconsul was pre-eminently the asiarch, but conceives that the other nine acted as his assessors and also bore that title. Others, however, think the plurality of asiarchs sufficiently accounted for by supposing that those who had served the office continued to bear the title, as was the case with the Jewish high-priests; but the other branch of the alternative is usually preferred. Winer judiciously remarks, that in the course of time changes may have been made in the office, which our fragmentary information does not enable us to trace; and he contends that the solitary testimony of Eusebius amounts to no more than that one asiarch, Philli, then and there pre-

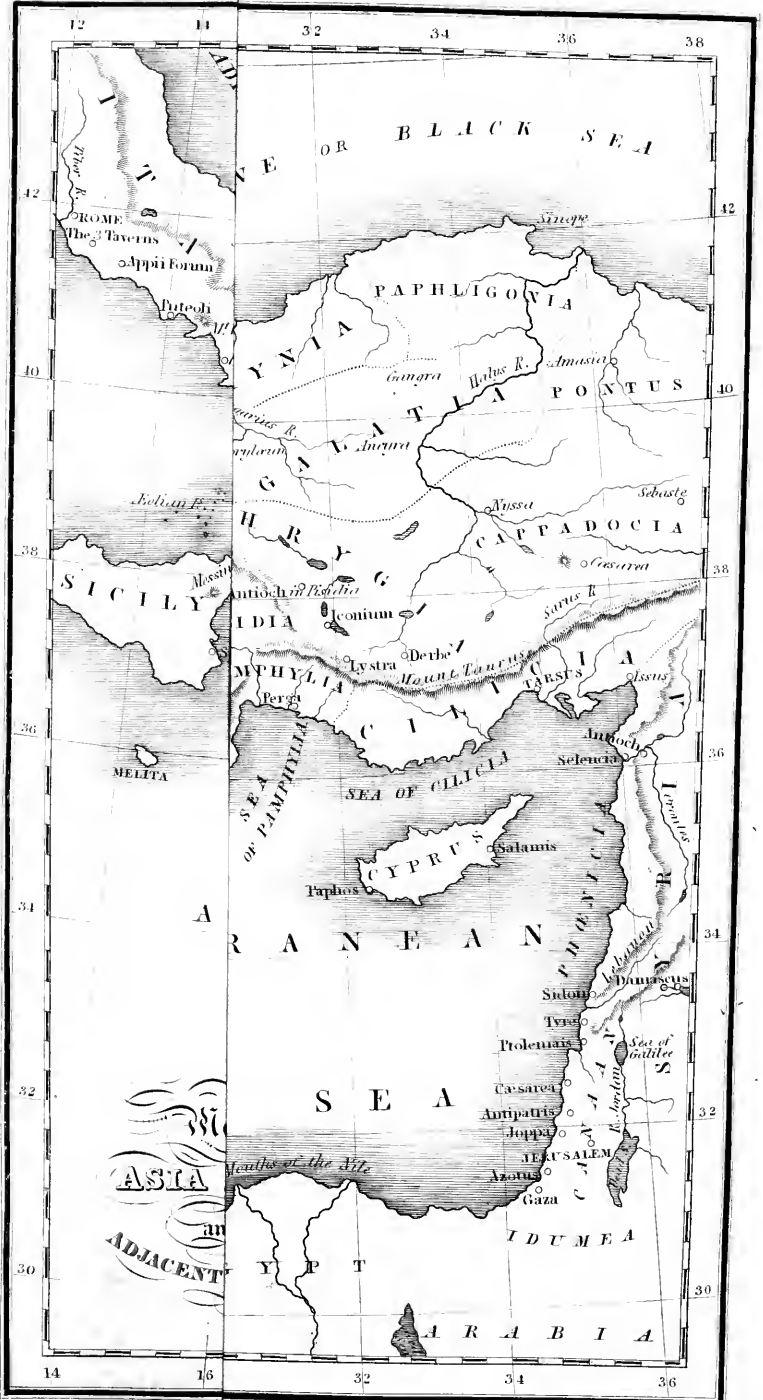

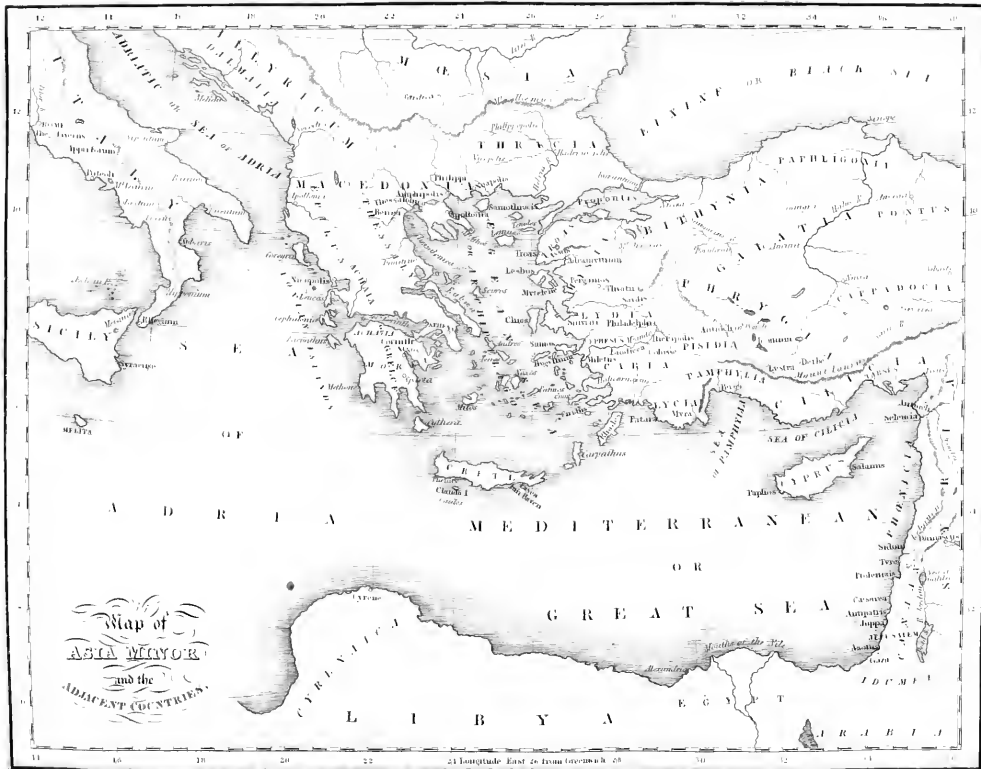

Map of
ASIA MINOR
 and the
 ADJACENT COUNTRIES.

sided at the public games, but not that the arrangements of all the games were made and provided by that one asiarh. (See Kuinoel, Hammond, Bloomfield, &c., on Acts xix. 31; and Winer's *Biblisches Realwörterbuch*, s. v. 'Asiarhæ,' with the authorities there cited.)

ASKELON (Ἰσκαλιών; Sept. Ἀσκάλων), a city of the Philistines, and the seat of one of their five states (Judg. xiv. 19; 1 Sam. vi. 17; 2 Sam. i. 20). It was situated on the Mediterranean coast, between Gaza and Ashdod, twelve geog. miles north of the former, and ten S. by W. from the latter, and thirty-seven W.S.W. from Jerusalem. It was the only one of the five great Philistine towns that was a maritime port, and stood out close to the shore. Askelon was assigned to the tribe of Judah (Josh. xiii. 13; comp. Judg. i. 18); but it was never for any length of time in possession of the Israelites. The part of the country in which it stood abounded in aromatic plants, onions, and vines (Plin. xix. 32; Strabo, xvi. p. 759; Dioscor. i. 124; Colum. xii. 10; Alex. Trall. viii. 3). It was well fortified (Joseph. *De Bell. Jud.* iii. 21; comp. Meia, i. 11), and early became the seat of the worship of Decerto (Diod. Sic. ii. 4). After the time of Alexander it shared the lot of Phœnicia and Judæa, being tributary sometimes to Egypt, and at other times to Syria (1 Macc. x. 86; xi. 60; xii. 33; Joseph. *Antiq.* xii. 4. 5). The magnificent Herod was born at Askelon, and although the city did not belong to his dominion, he adorned it with fountains, baths, and colonnades (*De Bell. Jud.* i. 12. 11); and after his death Salome, his sister, resided in a palace at Askelon, which Cæsar bestowed upon her (*Antiq.* xvii. 11. 5). It suffered much in the Jewish war with the Romans (*De Bell. Jud.* ii. 18. 5; iii. 2. 1-3); for its inhabitants were noted for their dislike of the Jews, of whom they slew 2500 who dwelt there (ii. 18. 5; iii. 2. 1). After this Askelon again revived, and in the middle ages was noted not only as a stronghold, but as a wealthy and important town (Will. Tyr. xvii. 21). As a sea-port merely it never could have enjoyed much advantage, the coast being sandy and difficult of access. The town bears a prominent part in the history of the Crusades. After being several times dismantled and re-fortified in the times of Saladin and Richard, its fortifications were at length totally destroyed by the Sultan Bibars A.D. 1270, and the port filled up with stones, for fear of future attempts on the part of the Crusaders (Wilkin. *Gesch. der Kreuz.* vii. 586). This, no doubt, sealed the ruin of the place. Sandys (*Travels*, p. 151, A.D. 1610) describes it as 'now a place of no note, more than that the Turke doth keepe there a garrison.' Fifty years after (A.D. 1660), Von Troudo found it still partially inhabited. But its desolation has long been complete, and little now remains of it but the walls, with numerous fragments of granite pillars. The situation is described as strong; the thick walls, flanked with towers, were built on the top of a ridge of rock that encircles the town, and terminates at each end in the sea. The ground within sinks in the manner of an amphitheatre (Richardson, ii. 202-204; Eli Smith, in *Missionary Herald* for 1827, p. 341). The place still bears the name of Askulan. عسقلان.

ASMODEUS (Ἀσμοδαῖος; Tob. iii. 8), a demon or evil spirit, mentioned in the Apocryphal book of Tobit as having beset Sarah, the daughter of Raguel, and killed the seven husbands whom she had married before Tobit (Tob. iii. 8; vi. 14; viii. 2, 3). The Rabbins have a number of absurd traditions respecting Asmodeus, which may be seen in the original edition of Calmet and in Lightfoot (*Ilor. Hebr.* ad Luc. xi. 15). They call him, as well as Beelzebub, 'the prince of devils,' whence the two names have been supposed to refer to the same demon. But this title they also give to 'the angel of death,' as the destroyer of all mankind: hence some derive the name Asmodeus from the Hebrew שַׁמַּאד *shama'd*, to exterminate, which identifies it with Ashmodaj and also Abaddon (see the word), the same as Apollyon, the angel of death. This is likely, and thus the story in Tobit means no more than that the seven husbands died successively on their marriage with Sarah.

ASMONEANS. [MACCABEES.]

ASNAPPER (Ἄσσηναφάρ; Sept. Ἀσσηναφάρ), the name of the king, or possibly Assyrian satrap, who sent the Cuthæan colonies into Palestine (Ezra iv. 10). Taking him for king of Assyria, he is generally identified with Esar-baddon, although some believe the name to denote Salmazer. The title מַלְכָּא וְיִקְרִיא רַבָּא (Auth. Vers. 'most noble') which is given to him belonged to the satraps.

ASPALATHUS (ἀσπάλαθος), a word which occurs only in Ecclus. xxiv. 15, of the Apocrypha, where the substance which it indicates is enumerated with other spices and perfumes to which wisdom is compared. Though this drug is not mentioned in the canonical Scriptures, it is probable that it may have been one of the substances comprehended under the general name of spices. It was no doubt one of the substances employed by the ancients as a perfume and incense, as it is described by Dioscorides (i. c. 19), as well as enumerated by Theophrastus (ix. c. 7), and by both among aromatic substances. It forms one of the ingredients of the cyphi, or compound incense made use of by the Egyptian priests, as related both by Plutarch and Dioscorides. The substance which was called aspalathus has not been very clearly ascertained, though several plants have been indicated as yielding it. *Lignum Rhodium* is sometimes considered to be one of the kinds of aspalathus described by Dioscorides, but this is a produce of the Canary Islands and of the plant called *Convolvulus scoparius*. From it the perfumers of Paris obtain *l'huile de bois de Rhodes*. By others aspalathus, which has been supposed to be the same thing as Syrian aloe, or that of Rhodes and of Candia, is thought to have been yielded by species of the genus which has been called Aspalathus, and especially by the species *A. creticus*, which is now called *Anthyllis Hermanniæ*; but there does not seem to be sufficient proof of this. Others again have held that aspalathus was a kind of agallochum [AHALIM], and Dr. Harris (sub. Lign.—aloe) seems to have thought that he got rid of a difficulty by suggesting that *ahalim*, which we have shown to be agallochum, should be rendered ASPALATHA. Arab authors, as Avicenna and Serapion, give *Dar-shi-shan* as the Arabic synonyme of aspalathus. They

quote some of their own countrymen as authorities respecting it, in addition to Galen and Dioscorides. Hence it would appear to have been a product of the East rather than of the West, as for such they usually give only the Greek name or its translation, and quote only Greek authorities. Avicenna, in addition to his description, says that some think it may be the root of Indian nard. Hence it may justly be inferred that *Dar-shishan*, which the Arabians thought to be aspalathus, must have come to them from India, or they would not have hazarded this supposition. In India the name *Dar-shishan* is applied to the bark of a tree which is called *kaephul* or *kyphul*. This tree is a native of the Himalayan mountains from Nepal to the Sutlej, and has been figured and described by Dr. Wallich, in his *Tentamen Floræ Nepalensis*, p. 59, t. 45, by the name *Myrica sapida*, in consequence of its fruit, which is something like that of the arbutus, being edible. The leaves, on being rubbed, have a pleasantly aromatic though faint smell. The bark forms an article of commerce from the hills to the plains, being esteemed in the latter as a valuable stimulant medicine. It may be seen mentioned by the name ka-i-phul in Gladwin's translation of the Persian *Ulfuz-i-Udviéh*, No. 884, as a synonyme of *Dar-sheeshan*, which is described as an aromatic bark, while at No. 157 *Dar-sheeshan* is considered to be a synonyme of *أشتلايوس ishtelayoos*, which seems

to be a corruption of aspalathus from the errors of transcribers in the diacritical points. *Kaephul* has, moreover, been long celebrated by Sanscrit authors, and it may therefore have easily formed one of the early articles of commerce from the East to the West, together with the Nard, the Costus, and the Lycium of these mountains.—J. F. R.

ASPHALTUM (חֶמָרִי *chemar*; Arab. 

chomar; Sept. ἄσφαλτος; Auth. Vers. 'pitch'). Luther, like the modern Rabbinis, erroneously translates the Hebrew by 'clay.' The Hebrew and Arabic names probably refer to the reddish colour of some of the specimens (Dioscorides, i. 99). The Greek name, whence the Latin Asphaltum, is doubtless derived from the Lake Asphaltites (Dead Sea), whence it was abundantly obtained. Usually, however, asphaltum, or compact bitumen, is of a shining black colour; it is solid and brittle, with a conchoidal fracture, altogether not unlike common pitch. Its specific gravity is from 1 to 1.6, and it consists chiefly of bituminous oil, hydrogen gas, and charcoal. It is found partly as a solid dry fossil, intermixed in layers of plaster, marl, or slate, and partly as liquid tar flowing from cavities in rocks or in the earth, or swimming upon the surface of lakes or natural wells (Burckhardt, ii. 77). To judge from Gen. xiv. 10, mines of asphaltum must have existed formerly on the spot where subsequently the Dead Sea, or Lake Asphaltites, was formed, such as Mariti (*Travels*, iv. 27) discovered on the western shore of that sea. The Palestine earth-pitch, however, seems to have had the preference over all the other sorts (Plin. xxviii. 23; Discor. i. p. 100). It was used among the ancients partly for covering boats, paying the bottoms of vessels (comp. Niebuhr, ii. p. 336; Gen. vi. 14; Exod. ii. 3; Joseph. *De Bell. Jud.* iv. 8. 4; Buckingham, *Mesopot.* p. 346), and partly as a

substitute for mortar in buildings; and it is thought that the bricks of which the walls of Babylon were built (Gen. xi. 3; Strabo, xvii. p. 743; Herod. i. 179; Plin. xxxv. 51; Ammian. Marcell. xxiii. 6; Vitruv. viii. 3; comp. Joseph. *Antiq.* i. 4. 3) had been cemented with hot bitumen, which imparted to them great solidity. In ancient Babylon asphaltum was made use of also for fuel, as the environs have from the earliest times been renowned for the abundance of that substance (Diod. Sic. ii. 12; Herod. i. 179; Dion. Cass. lxxviii. 26; Strabo, xiv. 8. 4; Plut. *Alex.* c. 35; Theodoret, *Quæst. in Genes.* 59; Ritter, *Geogr.* ii. 345; Buckingham, *Mesopot.* p. 346). Neither were the ancient Jews unacquainted with the medicinal properties of that mineral (Joseph. *De Bell. Jud.* *ibid.*)

Asphaltum was also used among the ancient Egyptians for embalming the dead. Strabo (xvi.) and many other ancient and modern writers assert, that only the asphalt of the Dead Sea was used for that purpose; but it has in more recent times been proved, from experiments made on mummies, that the Egyptians employed sluggy mineral pitch in embalming the dead. This operation was performed in three different ways: first with sluggy mineral pitch alone; second with a mixture of this bitumen and a liquor extracted from the cedar, called *cedoria*; and third with a similar mixture, to which resinous and aromatic substances were added (Häüy. *Mineral.* ii. p. 315).

Asphaltum is found in masses on the shore of the Dead Sea, or floating on the surface of its waters. Dr. Shaw (*Travels in Barbary and the Levant*) was told that this bitumen, for which the Dead Sea is so famous, rises at certain times from the bottom of the sea in large pieces of semiglobular form, which, as soon as they touch the surface, and the external air operates upon them, burst asunder in a thousand pieces, with a terrible crash, like the *pulvis fulminans* of the chemists. This, however, he continues, only occurs along the shore; for in deep water, it is supposed that these eruptions show themselves in large columns of smoke, which are often seen to rise from the lake. The fact of the ascending smoke has been much questioned by naturalists; and although apparently confirmed by the testimonies of various travellers, collected by Büsching, in his *Eräbeschreibung*, it is not confirmed by the more observant travellers of recent years. Poccocke (*Description of the East*, &c. ii. § 46) presumes that the thick clumps of asphalt collected at the bottom of the lake have been brought up by subterraneous fire, and afterwards melted by the agitation of the waters. Also Strabo (xvi. p. 764) speaks of subterraneous fires in those parts (comp. Burckhardt, *Syria*, 394).

Dr. Robinson, when in the neighbourhood, heard from the natives the same story which had previously been told to Setzen and Burckhardt, namely—that the asphaltum flows down the face of a precipice on the eastern shore of the lake, until a large mass is collected, when, from its weight or some shock, it breaks off and falls into the sea (Setzen, in *Zach's Monatl. Correspond.* xviii. 441; Burckhardt, p. 394; Robinson, ii. 229). This, however, he strongly doubts, for assigned reasons, and it is agreed that nothing of

the kind occurs on the western shore. The Professor rather inclines to receive the testimony of the local Arabs, who affirm that the bitumen only appears after earthquakes. They allege that after the earthquake of 1834 huge quantities of it were cast upon the shore, of which the Jehalin Arabs alone took about 60 kuntars (each of 93 lbs.) to market; and it was corroboratively recollectcd by the Rev. Eli Smith, that a large amount had that year been purchased at Beirut by the Frank merchants. There was another earthquake on January 1, 1837, and soon after a large mass of asphaltum (compared by one person to an island, and by another to a house) was discovered floating on the sea, and was driven aground on the western side, near Ustum. The neighbouring Arabs assembled, cut it up with axes, removed it by camels' loads, and sold it at the rate of four piastres the *rutl*, or pound; the product is said to have been about 3000 dollars. Except during these two years, the Sheik of the Jehalin, a man fifty years old, had never known bitumen appear in the sea, nor heard of it from his fathers (Robinson's *Bib. Researches*, ii. p. 230). This information may serve to illustrate the account of Josephus, that 'the sea in many places sends up black masses of asphaltum, which float on the surface, having the form and size of headless oxen' (*De Bell. Jud.* ix. 8. 4); and that of Diodorus (ii. 48), who states that the bitumen is thrown up in masses, covering sometimes two or three *plethra*, and having the appearance of islands.—E. M.

ASS (חמור *chamor*), *Equus Asinus* of Linnaeus; by some formed into a subgenus, containing that group of the Equidae which are not striped like Zebras, and have forms and characters distinguishable from true horses, such as a peculiar shape of body and limbs, long ears, an upright mane, a tail only tufted at the end, a streak along the spine, often crossed with another on the shoulders, a braying voice, &c.

Besides the ordinary term *Chamor*, the Hebrews likewise used אֲתוֹן *Athon*, אֲטוֹן *Aton*, אֲטוּן *Atun*; עִירִים *Oirim*; פָּרָא *Para*; and עֹרֹד *Orad*, *Oredia*. By these words, no doubt, though not with the strict precision of science, different species and distinct races of the group, as well as qualities of sex and age, were indicated; but the contexts in general afford only slight assistance in discriminating them; and reliance on cognate languages is often unavailing, since we find that similar words frequently point to secondary and not to identical acceptations.

1. CHAMOR we take to be the name of the common working ass of Western Asia; an animal of small stature, frequently represented on Egyptian monuments with panniers on the back, usually of a reddish colour (the Arabic Hamar and Chamara denoting red), and the same as the Turkish Hymar. It appears to be a domesticated race of the wild ass of Arabia, Mesopotamia, and Southern Persia, where it is denominated Gour: in Scripture it is distinguished by the name of עֹרֹד *Orud* (Job xxxix. 5), and in the Chaldee of Daniel, עֹרֵדִיא *Oredia* (v. 21); both terms being most likely derived from the braying voice of the animal.

In its natural state it never seeks woody, but upland pasture, mountainous and rocky retreats; and

it is habituated to stand on the brink of precipices (a practice not entirely obliterated in our own domestic races), whence, with protruded ears, it sur-

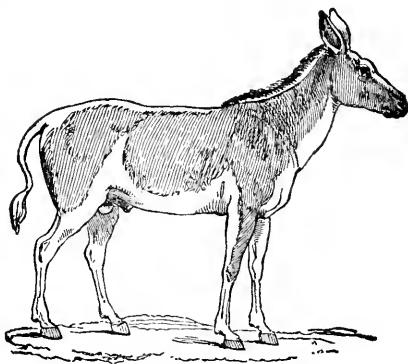

[Domestic Ass of Western Asia.]

veys the scene below, blowing and at length braying in extreme excitement. This habit is beautifully depicted by Jeremiah, when speaking of the Para (xvii. 6) and Orud (xlviii. 6), where, instead of עֹרֵר *Oror*, heath, we should read עֹרֹד *Orud*, wild ass; for there is no heath, *erica*, in Asia.

עִירִים *Oir*, *Oirim*; in the Chaldee עִילִי *Ili*; Auth. Vers. young ass, colt; but this rendering does not appear on all occasions to be correct, the word being sometimes used where the *Oirim* or *Ourim* carry loads and till the ground, which seems to afford evidence of, at least, full growth (*Isa.* xxx. 6, 24). אֲטוֹן *Aton*, *Atunuth*, is unsatisfactorily rendered 'she-ass,' unless we suppose it to refer to a breed of greater beauty and importance than the common, namely, the silver grey of Africa; which being large and indocile, the females were anciently selected in preference for riding, and on that account formed a valuable kind of property. From early ages a white breed of this race was reared at Zobeir, the ancient Bassora, and capital of the Orcheni, from which place civil dignitaries still obtain their white asses and white mules. It is now the fashion, as it was during the Parthian empire, and probably in the time of the Judges, to dapple this breed with spots of orange or crimson or of both colours together; and we agree with the Editor of the *Pictorial Bible* (note on *Judg.* v. 10) that this is the meaning of the word עֲצָחֹר *Tzachor* (chequered?); an interpretation which is confirmed by the Babylonian Sanhedrim, who, in answer to King Sapor's offer of a horse to convey the Jewish Messiah, say: 'non est tibi equus centimaculus, qualis est ejus (Messiae) asinus.' Horses and asses thus painted occur frequently in Oriental illuminated MSS., and although the taste may be puerile, we conceive that it is the record of remote conquest achieved by a nation of Central Asia mounted on spotted or clouded horses, and revived by the Parthians, who were similarly equipped. See *Introduction to Hist. of Horse and the Tangum Horse, Naturalist's Library*, vol. xii. No other primary invasion from the east by horsemen on *Tzachor* animals than that of the so-called Centaurs is recorded: their era coincides nearly with that of the Judges.

By the law of Moses the ass was declared unclean, and therefore was not used as food, excepting, as it would appear, in cases of extreme famine. This inference, however, is drawn from a case where the term 'ass's head' may be explained to mean not literally the head of an ass, but a certain measure or weight so called, as in 1 Sam. xvi. 20, where it is said that Jesse sent to Saul 'an ass of bread'; for, in our version, 'laden with' is an addition to the text. Although therefore the famine in Samaria may possibly have compelled the people to eat asses, and a head may have been very dear, still the expression may denote the measure or weight which bore the same name. The prohibition, however, had more probably an economical than a religious purpose: hunting was thus discouraged, and no horses being used, it was of importance to augment the number and improve the qualities of the ass.

As this animal was most serviceable to man, its name was held in respect rather than contempt. The slander, therefore, current among the Romans and directed against the Jews, that they adored the head of an ass in secret, may not have originated in direct malice or misinterpretation, but have arisen out of some Gnostic fancies, in which the Alexandrian Jews, who had nearly forsaken the Scriptures in search of the magical delusions of the Cabala, and new semi-Christians in that city, so deeply indulged during the first centuries of our era. Hence the Ophite sect figured in the circles of Behemoth, the last genius or Eon (?), under the name of Onoel, shaped like an ass; and there exists an engraved Abraxa, or talisman, of Gentile or Gnostic origin, bearing the whole-length form of a man in flowing robes with an ass's head, and holding an open book with the inscription, 'Deus Christianorum menenchites.' It is not likely that mere malice would engrave its spite upon amulets, although, if Jablonski be correct, the ass was held in contempt in Egypt, and therefore in Alexandria; but among the Arabs and Jews we have 'the voice of one crying in the wilderness,' a solemn allusion derived from the wild ass, almost the only voice in the desert; and in the distinguishing epithet of Mirvan II., last Omriad caliph, who was called Hymar-al-Gezeral, or wild ass of Mesopotamia—proofs that no idea of contempt was associated with the prophet's metaphor, and that, by such a designation, no insult was intended to the person or dignity of the prince. In more remote ages Tartak or Tarhak was an ass-god of the Avim, and Yauk was the Arabian name of another equine divinity, or a different name for the same Tartak, whose form may possibly be preserved to the present day in the image of the Borak, or mystical camel, which, according to the Koran, bore Mohammed, and is now carried in processions at the Nourous. It is shaped like a horse, having a white body with red legs, a peacock's tail, and a woman's instead of an ass's head.

2. פָּרָא *Para*, rendered likewise 'wild ass,' is a derivative of the same root which in Hebrew has produced פָּרָשׁ *Paras*, horse, and פָּרָשִׁים *Parasim*, horsemen, Persians, and Parthians. Though evidently a general term, the Scripture uses it in a specific sense, and seems to intend by it the horse-ass, or wild mule, which the Greeks denominated Hemionos, and the moderns Djiggetai; though we think there still remains some commixture in

the descriptions of the species and those of the Koulan, or wild ass of Northern Asia. Both are

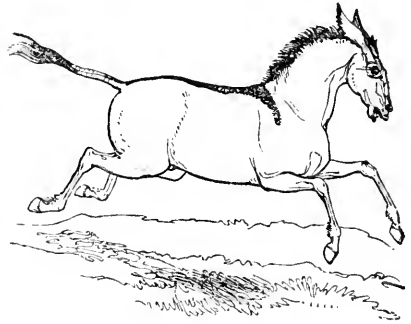

[Wild Ass.]

nearly of the same stature, and not unlike in the general distribution of colours and markings, but the Hemionos is distinguished from the other by its neighing voice and the deficiency of two teeth in the jaws. The species is first noticed by Aristotle, who mentions nine of these animals as being brought to Phrygia by Pharnaces the satrap, whereof three were living in the time of his son Pharnabazus. This was while the Onager still roamed wild in Cappadocia and Syria, and proves that it had until then been considered the same species, or that from its rarity it had escaped discrimination; but no doubt remains that it was the Gourkhur, or horse-ass, which is implied by the name Hemionos. The allusion of Jeremiah, in speaking of the Para (xiv. 6), most forcibly depicts the scarcity of food when this species, inured to the desert and to want of water, are made the prominent example of suffering.

They were most likely used in traces to draw chariots: the animals so noticed in Isa. xxi. 7 and by Herodotus are the same which Pliny, Strabo, and Arnobius make the Caramanians and Scythians employ in the same way. We claim the Para, and not the Orud, to be this species, because the Hemionos, or at least the Gourkhur, does not bray, as before noticed; and because, notwithstanding its fierceness and velocity, it is actually used at present as a domestic animal at Lucknow, where it was observed by Duvaucel. The Hemionos is little inferior to the wild horse; in shape it resembles a mule, in gracefulness a horse, and in colour it is silvery, with broad spaces of flaxen or bright bay on the thigh, flank, shoulder, neck, and head; the ears are wide like the zebra's, and the neck is clothed with a vertical dark mane prolonged in a stripe to the tuft of the tail. The company of this animal is liked by horses, and, when domesticated, it is gentle: it is now found wild from the deserts of the Oxus and Jaxartes to China and Central India. In Cutch it is never known to drink, and in whole districts which it frequents water is not to be found: and, though the natives talk of the fine flavour of the flesh, and the Gour in Persia is the food of heroes, to an European its smell is abominable. For detailed remarks on all the species of Equidæ we refer to vol. xii. of the *Naturalist's Library*, where, however, there are several typographical errors in the Hebrew names.

MULE (פָּרָד) *Pered*, a slight alteration from

Para, before referred to) occurs in 2 Sam. xiii. 29; 1 Kings i. 33; x. 25; and in other places.

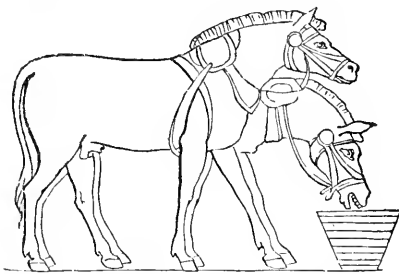

[Mules; from an Egyptian Painting.—Brit. Museum.]

This animal is sufficiently well known to require no particular description. Where, or at what period, breeding mules was first commenced is totally unknown, although, from several circumstances, Western Asia may be regarded as the locality; and the era as coinciding with that of the first kings of Israel. In the time of David, to be allowed to ride on the king's own mule was an understood concession of great, if not sovereign authority, and several years before the mention of this event all the king's sons already rode upon mules. It does not appear that the Hebrew people, at this early period at least, bred mules; they received them from Armenia, the large Persian race being considered the offspring of the Onager and mare; but the most beautiful were no doubt brought from the vicinity of Basora, as before noticed. The claim of Anah, son of Zibeon, to the discovery of breeding mules, as asserted in the Talmuds, may be regarded as an expression of national vanity. It rests on Gen. xxxvi. 24, where *יָמִים* *Jemim*, or *Ha-yimim* is rendered *mules*: but it more probably means *water*.

רֶכֶשׁ *Reches* (Esth. viii. 10, 14; 1 Kings iv. 28) we take to be one of the many names for running camels; at Herat still called *Badees*; in Arabia, Deloul, Oo Shaary, and Hedjeens used to carry expresses; or post horses, anciently *Asiandi* or *Astandi*, now *Chupper* or *Chuppaw*, which, according to Xenophon, existed in Persia in the time of Cyrus, and are still in use under different appellations over all Asia.—C. H. S.

ASSHUR, a son of Shem, who gave his name to Assyria (Gen. x. 11-22) [ASSYRIA].

ASSIDÆANS (חַסִּדִּים *chasidim*, 1 Macc. vii. 13, ἄσιδᾶις, the *pious*, or *righteous*); a name derived from the root *חסד*, a word used to denote a very good or a very bad action, but more frequently the former. As a description of a particular body of men it does not occur in the canonical Scriptures, nor in Josephus; but in the First Book of Maccabees, as above, it is applied to the body of zealous and devoted men who rose at the signal for armed resistance given by Mattathias, the father of the Maccabees, and who, under him and his successors, upheld with the sword the great doctrine of the unity of God, and stemmed the advancing tide of Grecian manners and idolatries.

The Jews at a later period gave the name of Chasidim to those pious persons who devoted themselves to a life of austerities and religious exercises, in the hope of hastening the coming of the Mes-

siah, and of making an atonement for their own sins and for the sins of others. The name of Chasidim has also been assumed by a Jewish sect which originated in Poland about a hundred years since, and which still subsists. There is an account of it in the *Penny Cyclopædia*, art. 'Assidians.' The ideas connected with this later appropriation of the term have, by an obvious association, been carried back to and connected with the Chasidim or Assidæans who joined Mattathias, and who have generally been regarded as a sect subsisting at that time. No such sect, however, is mentioned by Josephus in treating of the affairs of that period; and the texts which refer to them (1 Macc. ii. 42; vii. 13; 2 Macc. xiv. 18) afford no sufficient evidence that the Assidæans formed a sect distinct from other pious and faithful Jews. The analogous Hebrew term Chasidim occurs in various passages of Scripture appellatively for good and pious men (Ps. cxlv. 10; cxlix. 1; Isa. lvii. 1; Mic. vii. 2), but is never applied to any sect or body of men. Upon the whole, in the entire absence of collateral information, it seems the safest course to conclude that the Assidæans were a body of eminently zealous men, devoted to the Law, who joined Mattathias very early, and remained the constant adherents of him and his son Judas—not, like the mass of their supporters, rising occasionally and then relapsing into the ordinary pursuits of life. It is possible that, as Jennings conjectures (*Antiq.* p. 298), the name ἁσιδᾶις, or 'saints,' came to be applied to them by their enemies as a term of reproach, like 'Puritans' formerly in this country, and 'saints' very often in the present day.

ASSOS (Ἄσσος), a town of Lesser Mysia, or of Adramyttium, opposite the island of Lesbos, or Mitylene. Paul came hither on foot from Troas, to meet with his friends, in order to take shipping for Mitylene (Acts xx. 13, 14). It is now a miserable village, called Beiram, built high upon the rocks on the side towards the land (*Richter*, p. 465, sq.).

ASSYRIA. We must here distinguish between the *country* of Assyria, and the Assyrian *empire*. They are both designated in Hebrew by אַשּׁוּר *Ashur*, the people being also described by the same term, only that in the latter sense it is masculine, in the former, feminine. In the Septuagint it is commonly rendered by Ἄσσορ or Ἄσσυρος, and in the Vulgate by *Assur* and *Assyrii*, and seldom or never by Ἀσσυρία, or *Assyria*. Let it be noted, that the *Ashurim* (Ἀσσυρίται) of Gen. xxv. 3, were an Arab tribe; and that at Ezek. xxvii. 6, the word *ashurim* (in our version 'Ashurites') is only an abbreviated form of *teashur*, box-wood.

I. ASSYRIA PROPER was a region east of the Tigris, the capital of which was Nineveh. It derived its name from the progenitor of the aboriginal inhabitants—*Ashur*, the second son of Shem (Gen. x. 22; 1 Chron. i. 17), a different person from *Ashur*, son of Hezron, and Caleb's grandson (1 Chron. ii. 4; iv. 5). Its limits in early times are unknown; but when its monarchs enlarged their dominions by conquest, the name of this metropolitan province was extended to the whole empire. Hence, while Homer calls the inhabitants of the country north of Palestine *Arimci* (evidently the *Aramim* or *Ara-*

means of the Hebrews), the Greeks of a later period, finding them subject to the Assyrians, called the country Assyria, or (by contraction) *Syria*, a name which it has ever since borne. It is on this account that, in classical writers, the names Assyria and Syria are so often found interchanged; and a recent commentator on Isaiah is of opinion that this too is the case in Scripture; for by 'Assyria,' in Isa. xix. 23-25, he understands the prophet to mean 'Syria' (Henderson on *Isaiah*, Lond. 1840, p. 173). The same conjecture had been hazarded by Hitzig (*Begriff d. Kritik Alt. Test.* Heidelberg, 1831, p. 98); but it may be questioned whether in Hebrew 'Asshur' and 'Aram' are ever confounded. The same, however, cannot be affirmed of those parts of the Assyrian empire which lay east of the Euphrates, but west of the Tigris. The Hebrews, as well as the Greeks and Romans, appear to have spoken of them in a loose sense as being in Assyria, because in the Assyrian empire. Thus Isaiah (vii. 20) describes the Assyrians as those 'beyond the river,' i. e. east of the Euphrates, which river, and not the Tigris, is introduced at viii. 7, as an image of their power. In Gen. xxv. 18, the locality of the Ishmaelites is described as being east of Egypt, 'as thou goest to Assyria,' which, however, could only be reached through Mesopotamia or Babylonia; and this idea best reconciles the apparent incongruity of the statement in the same book (ii. 14), that the Hiddekel, or Tigris, runs 'on the east of Assyria,' i. e. of the Assyrian provinces of Mesopotamia and Babylonia; for there can be no doubt that, not only during the existence of the Assyrian monarchy, but long after its overthrow, the name of Assyria was given to those provinces, as having once formed so important a part of it. For example, in 2 Kings xxiii. 29, Nebuchadnezzar is termed the king of Assyria, though resident at Babylon (comp. Jer. ii. 18; Lament. v. 6; Judith i. 7; ii. 1); yea, in Ezra vi. 22, Darius, king of Persia, is called king of Assyria (comp. Plin. *Hist. Nat.* xiv. 19); and, on a similar principle, in 2 Macc. i. 19, the Jews are said to have been carried captive to Persia, i. e. Babylonia, because, as it had formerly been subject to the Assyrians, so it was afterwards under the dominion of Persia. (Comp. Herodotus, i. 106, 178; iii. 5; vii. 63; Strabo, ii. 84; xvi. 1; Arrian, vii.; *Expéd. Alex.* vii. 21. 2; Ammianus Marcellinus, xxiii. 20; xxiv. 2; Justin, i. 2. 13.) One writer, Dionysius Periegeta (v. 975), applies the designation of Assyria even to Asia Minor, as far as the Black Sea.

Yet, ultimately, this name again became restricted to the original province east of the Tigris, which was called by the Greeks *Ἀσσυρία* (Ptolemy, vi. 1), and more commonly *Ἀρούπια* (Strabo, xvi. p. 507), or *Ἀρούπια* (Dion Cassius, lxxviii. 28), the latter being only a dialectic variety of pronunciation, derived from the Aramæan custom of changing *s* into *t*. A trace of the name is supposed to be preserved in that of a very ancient place **أشور**

Athur, on the Tigris, from four to six hours N.E. of Mosul. Rich, in his *Residence in Kurdistan* (vol. ii. p. 129), describes the ruins as those of the 'city of Nimrod,' and states that some of the better informed of the Turks at Mosul 'said it was *Al Athur*, or *Ashur*, from which the whole country was denominated.'

According to Ptolemy, Assyria was in his day bounded on the north by Armenia, the Gordiæan or Carduchian mountains, especially by Mount Niphates; on the west by the river Tigris and Mesopotamia; on the south by Susiana, or Chuzistan, in Persia, and by Babylonia; and on the east by a part of Media, and mounts Choathiras and Zagros (Ptolemy, vi. 1; Pliny, *Hist. Nat.* v. 13; Strabo, xvi. p. 736). It corresponded to the modern Kurdistan, or country of the Kurds (at least to its larger and western portion), with a part of the pashalik of Mosul. 'Assyria,' says Mr. Ainsworth (*Researches in Assyria, Babylonia, and Chaldæa*, Lond. 1838), 'including Taurus, is distinguished into three districts: by its structure, into a district of plutonic and metamorphic rocks, a district of sedimentary formations, and a district of alluvial deposits; by configuration, into a district of mountains, a district of stony or sandy plains, and a district of low watery plains; by natural productions, into a country of forests and fruit-trees, of olives, wine, corn, and pasturage, or of barren rocks; a country of mulberry, cotton, maize, tobacco, or of barren clay, sand, pebbly or rocky plains; and into a country of date-trees, rice, and pasturage, or a land of saline plants.' The northern part is little else than a mass of mountains, which, near Julamerk, rise to a very great height, Mount Jewar being supposed to have an elevation of 15,000 feet; in the south it is more level, but the plains are often burnt up with scorching heat, while the traveller, looking northward, sees a snowy alpine ridge hanging like a cloud in mid air. On the west this country is skirted by the great river Tigris, the Hiddekel of the Hebrews (Gen. ii. 14; Dan. x. 4), the Dijlat of the Arabs, noted for the impetuosity of its current. Its banks, once the residence of mighty kings, are now desolate, covered, like those of its twin-river the Euphrates, with relics of ancient greatness, in the ruins of fortresses, mounds, and dams, which had been erected for the defence or irrigation of the country. Niebahr describes a large stone dam at the castle of Nimrod, eight leagues below Mosul, as a work of great skill and labour, and now venerable for its antiquity; and some suppose that it was from the circumstance of so many canals from the Tigris watering the country, and rendering it fruitful, that that river received the Arabic name of *Nahr-as-salam*, the River of Peace, i. e. prosperity. It leaves the high land at some distance above Tekrit, rushing with great velocity through a pass in the Hamirne mountains. In its progress along Assyria, the Tigris receives from that country, besides other rivers, two rapid mountain-streams, the Great and Little Zab (*Arab. Dhab*, i. e. Wolf), called by the Greeks the Lykos, or Wolf, and the Caprus, or Wild Boar. The greater Zab (called by the Kurds *Zerb*), used to be laid down as a different river from the Hakkary, but Dr. Grant found them to be identical; and he likewise detected an error of Kinnear, in representing the Bitlis-su as the same as the Khabûr, whereas they are different streams. (See Grant's *Nestorians*, p. 46.)

The most remarkable feature, says Ainsworth, in the vegetation of Taurus, is the abundance of trees, shrubs, and plants in the northern, and their comparative absence in the southern district. Besides the productions above enumerated, Kurdistan yields gall-nuts, gumm-arabic, mastich

manna (used as sugar), madder, castor-oil, and various kinds of grain, pulse, and fruit. An old traveller, Rauwolf, who passed by Mosul in 1574, dwells with admiration on the finely-cultivated fields, on the Tigris, so fruitful in corn, wine, and honey, as to remind him of the Assyrian Rabsshakeh's description of his native country in 2 Kings xviii. 32. Rich informs us that a great quantity of honey, of the finest quality, is produced; the bees (comp. Isa. vii. 18, 'the bee in the land of Assyria') are kept in hives of mud. The naphtha springs, on the east of the Tigris, are less productive than those in Mesopotamia, but they are much more numerous. The zoology of the mountain district includes bears (black and brown), panthers, lynxes, wolves, foxes, marmots, dormice, fallow and red deer, roebucks, antelopes, &c., and likewise goats, but not (as was once supposed) of the Angora breed. In the plains are found lions, tigers, hyænas, beavers, jerboas, wild boars, camels, &c.

Ptolemy divides Assyria into six provinces. Farthest north lay *Arrapachitis*, so called, as Rossemüller conjectures, from Arrhachad, Asshur's brother (Gen. x. 22-24; but see Vater on *Genesis*, i. 151). South of it was *Calakine*, by Strabo written *Calachene*; perhaps the Chalach of 2 Kings xvii. 6; xviii. 11. Next came *Adiabene*, so called from the above-mentioned rivers Dhab or Diab; it was so important a district of Assyria, as sometimes to give name to the whole country [ADIABENE]. In Aramæan it is called *Chadyab*, or *Hadyab*. North-east of it lay *Arbelitis*, in which was Arbel (now *Arbil*), of which see an account in Rich's *Kurdistan*, vol. ii. p. 14; and Appendix, No. i. and ii., famous for the battle in which Alexander triumphed over Darius. South of this lay the two provinces of *Apolloniatis* and *Sittakene*. The capital of the whole country was Nineveh, the Ninos of the Greeks (Herodot. i. 102), the Hebrew name being supposed to denote 'the abode of Ninos,' the founder of the empire. Its site is believed to have been on the east bank of the Tigris, opposite the modern town of Mosul, where there is now a small town called *Nebbi Yunus* (i. e. the prophet Jonah), the ruins around which were explored by Rich, and are described in his work on Kurdistan [NINEVEH]. In Gen. x. 11, 12, three other cites are mentioned along with Nineveh, viz. *Rehoboth Ir*, i. e. the city of Rehoboth, the locality of which is unknown. *Calach* (in our version *Calah*), either a place in the province of Calachene above mentioned, or the modern Hulwân, called by the Syrians Chalach; and *Resen*, 'a great city between Nineveh and Calach,' which Bochart identifies with the Larissa of Xenophon (*Anabasis*, iii. 47), and Michaelis with a place called Ressin (Rish-Ain, caput fontis?), destroyed by the Arabs A. D. 772. Rich notices an old place and convent of that name near Mosul (ii. 81). At the town of Al Kosh, N. of Mosul, tradition places the birth and burial of the prophet Nahum, and the Jews resort thither in pilgrimage to his tomb. But though he is styled an El-koshite (Nah. i. 1), his denunciations against Assyria and Nineveh were evidently uttered in Palestine; and St. Jerome fixes his birth-place at Helkesei, a village in Galilee. Still it is possible that he was the descendant of one of the Israelitish carried captive by Salmanassar, king of Assyria, 'to Chalach and to

Chabor on the river Gozan (or rather to Chabor a river of Gozan), and to the cities of the Medes' (2 Kings xvii. 6; xv. 29; xviii. 9; 1 Chron. v. 26). Of Chalach we have already spoken. In Chabor some recognise the mountain-tract in Assyria, called by Ptolemy Chaboras, in which rises the river Khabûr, which pursues a south-western course past Zaku to the Tigris; while others rather identify the river Chabor with the Khabur of Mesopotamia, which, after a similar course, joins the Euphrates at Kerkisiyeh, and is the same as the Chebar (that being the Syriac form), on the banks of which Ezekiel saw 'visions of God' (Ezek. i. 3). Indeed it may be doubted whether any of the localities specified were in Assyria Proper, with the exception of Chalach; and if with some we place it at Hulwân, then it was in Babylonian Irâk. Major Rawlinson has recently endeavoured to show that Chalach was neither at Hulwân nor at the neighbouring town of Zohab, but at a place called Sir-e-Pool-e-Zohab, eight miles S. of the latter, where he found not only Sassanian ruins and mounds like those of Babylon and Nineveh, but bas-reliefs and a royal tomb precisely like those of Persepolis. (See the *Journal of the Geograph. Soc.* vol. ix. part i. p. 35, Lond. 1839.) The country of Kir, to which the Assyrians transported the Damascene Syrians (2 Kings xvi. 9; Amos i. 5), was probably the region about the river Kur (the Cyrus of the Greeks), i. e. Iberia and Georgia.

The greater part of the country which formed Assyria Proper is under the nominal sway of the Turks, who compose a considerable proportion of the population of the towns and larger villages, filling nearly all public offices, and differing in nothing from other Osmanlis. The pasla of Mosul is nominated by the Porte, but is subject to the pasha of Bagdad; there is also a pasha at Solymaueah and Akra; a bey at Arbil, a mus-sellim at Kirkook, &c. But the aboriginal inhabitants of the country, and of the whole mountain-tract that here divides Turkey from Persia, are the *Kurds*, the Carduchii of the Greeks; from them a chain of these mountains were anciently called the Carduchian or Gordyean, and from them now the country is designated Kurdistan. Klaproth, in his *Asia Polyglotta* (Paris, 1823, 4to. p. 75), derives the name from the Persian root *kurd*, i. e. strong, brave. They are still, as of old, a barbarous and warlike race, occasionally yielding a formal allegiance, on the west, to the Turks, and, on the east, to the Persians, but never wholly subdued; indeed, some of the more powerful tribes, such as the Hakkary, have maintained an entire independence. Some of them are stationary in villages, while others roam far and wide, beyond the limits of their own country, as nomadic shepherds; but they are all, more or less, addicted to predatory habits, and are regarded with great dread by their more peaceful neighbours. They profess the faith of Islam, and are of the Soonee sect. All travellers have remarked many points of resemblance between them and the ancient Highlanders of Scotland. (See Mr. Ainsworth's second work, *Travels and Researches in Asia Minor, Mesopotamia, &c.* 2 vols. Lond. 1842.)

The Christian population is scattered over the whole region, but is found chiefly in the north. It includes Chaldæans, who form that branch of

the Nestorians that adheres to the church of Rome, a few Jacobites, or monophysite Syrians, Armenians, &c. But the most interesting portion is the ancient church of the primitive *Nestorians*, a lively interest in which has lately been excited in the religious world by the publications of the American missionaries, especially by a work entitled *The Nestorians*, by Asahel Grant, M.D. Lond. 1841. Besides the settlements of this people in the plain of Ooroomiah to the east, and in various parts of Kurdistan, where they are in a state of vassalage, there has been for ages an independent community of Nestorians in the wildest and most inaccessible part of the country. It lies at nearly equal distances from the lakes of Van and Ooroomiah, and the Tigris, and is hemmed in on every side by tribes of ferocious Kurds; but, entrenched in their fastnesses, the Nestorians have defied the storms of revolution and desolation that have so often swept over the adjacent regions; and in their character of bold and intrepid, though rude and fierce mountaineers, have so entirely maintained their independence unto the present day, as to bear among their neighbours the proud title of *Ashiret*, 'the tributeless.' The second part of Dr. Grant's work is taken up with an elaborate attempt to prove that this interesting people are the descendants of the 'lost' ten tribes of Israel. But for a satisfactory refutation of this hypothesis, we refer the reader to an able paper by Dr. E. Robinson, in the *Amer. Bibl. Reposit.* for Oct. 1841, and Jan. 1842. [ISRAEL.] Comp. an article by the Rev. J. Perkins in the same valuable Miscellany for Jan. 1841; also his *Residence in Persia*, New York, 1843; and the recent work of Ainsworth. Another peculiar race that is met with in this and the neighbouring countries is that of the Yezidees, whom Grant and Ainsworth would likewise connect with the ten tribes; but it seems much more probable that they are an offshoot from the ancient Manichees, their alleged worship of the Evil Principle amounting to no more than a reverence which keeps them from speaking of him with disrespect. (See Homies in the *Amer. Bibl. Reposit.* for April, 1842.) Besides the dwellers in towns, and the agricultural population, there are a vast number of wandering tribes, not only of Kurds, but of Arabs, Turkomans, and other classes of robbers, who, by keeping the settled inhabitants in constant dread of property and life, check every effort at improvement; and, in consequence of this, and the influence of bad government, many of the finest portions of the country are little better than unproductive wastes. A copy of a famous history of Kurdistan, entitled *Tarikh-al-Akrad* (Akrad being the collective name of the people), was procured by Mr. Rich when in the country, and is now, along with the other valuable Oriental MSS. of that lamented traveller, preserved in the British Museum.—N. M.

2. THE ASSYRIAN EMPIRE. No portion of ancient history is involved in greater obscurity than that of the empire of Assyria. In attempting to arrange even the facts deducible from Scripture, a difficulty presents itself at the outset, arising from the ambiguity of the account given of the origin of the earliest Assyrian state in Gen. x. 11. After describing Nimrod, son of Cush, 'as a mighty one in the earth,' the historian adds (ver. 10), 'And the beginning of his king-

dom (or rather, the first theatre of his dominion) was Babel, and Erech, and Accad, and Calneh, in the land of Shinar,' *i. e. Babylonia*. Then follow the words:—*מִן־הָאָרְצִים הַהֵנּוּ יָצָא אֲשׁוּר—יִבְנֶה אֶת־נִיְנוּרָה*, which may be rendered as in the English version: 'Out of that land went forth Asshur and builded Nineveh,' or (as it is in the margin) 'out of that land he (*i. e. Nimrod*) went out into Assyria and builded Nineveh.' It is objected to the latter translation, that had the writer meant to say 'to Assyria,' he would have used a preposition, or added the *locale*, and written *אֶת־אֲשׁוּרָה*. But verbs signifying 'to go to a place' are construed with the noun in the accusative; and Noldius, in his *Concordance of Hebrew Particles* (edit. Typm., p. 223), gives instances of the *locale* being sometimes omitted (comp. in Heb. 2 Sam. x. 2, with 1 Chr. xiii. 13; xix. 2). Looking at the entire context, and following the natural current of the writer's thoughts, we shall find the *second* translation yields the most congruous sense. Moses is enumerating the descendants of Ham, and it is not likely that he would interrupt the details to give an account of Asshur, a son of Shem, whose posterity are not introduced till ver. 21. Besides, in the circumstance of Asshur leaving one country to settle in another, there was nothing remarkable, for that was the case with almost all Noah's grandchildren. But if we understand it of Nimrod, both the connection and the sense will be manifest. The design obviously is to represent him as a potent monarch and ambitious conqueror. His brethren, the other sons of Cush, settled in the south, but he, advancing northward, first seized on Babylonia, and proceeding thence into Assyria (already partially colonized by the Asshurites, from whom it took its name), he built Nineveh and the other strongholds mentioned, in order to secure his conquests. This view is confirmed by a passage in Mic. v. 6, where, predicting the overthrow of Assyria by the Medes and Babylonians, the Prophet says, 'They shall devour the land of Asshur with the sword: even the land of Nimrod in the entrances thereof.' (Comp. v. 5.)

It likewise agrees with the native tradition (if we can depend on the report of Ctesias), that the founder of the Assyrian monarchy and the builder of Nineveh was one and the same person, viz. Ninus, from whom it derived its name (*q. d.* Nin's Abode), and in that case the designation of Nimrod (the Rebel) was not his proper name, but an opprobrious appellation imposed on him by his enemies. Modern tradition likewise connects Nimrod with Assyria; for while, as we have seen, the memory of Asshur is preserved in the locality of *Athur*, that place is also termed the 'city of Nimrod,' and (as the above-mentioned dam on the Tigris is styled Nimrod's Castle) Rich informs us that 'the inhabitants of the neighbouring village of Derawesh consider him as their founder.' He adds, that the village story-tellers have a book they call the '*Kisseh-Nimrud*,' or Tales of Nimrod.

It is true that the Authorized Version of Gen. x. 11 is countenanced by most of the ancient translators and by Josephus; but on the other hand, the one we have preferred is that of the Targums of Onkelos and Jerusalem, and of St. Jerome; and (among the moderns) of Bochart, Hyde, Marsham, Wells, Faber, Hales, and many

others. Yet, though Nimrod's 'kingdom' embraced the lands both of Shinar and Asshur, we are left in the dark as to whether Babylon or Nineveh became the permanent seat of government, and consequently, whether his empire should be designated that of Babylonia or that of Assyria. No certain traces of it, indeed, are to be found in Scripture for ages after its erection. In the days of Abraham, we hear of a king of Elam (*i. e.* Elymais, in the south of Persia) named Chedorlaomer, who had held in subjection for twelve years five petty princes of Palestine (Gen. xiv. 4), and who, in consequence of their rebellion, invaded that country along with three other kings, one of whom was 'Amraphel, king of Shinar.' Josephus says 'the Assyrians had then dominion over Asia;' and he styles these four kings merely commanders in the Assyrian army. It is possible that Chedorlaomer was an Assyrian viceroy, and the others his deputies; for at a later period the Assyrian boasted, 'Are not my princes altogether kings?' (Isa. x. 8). Yet some have rather concluded from the narrative, that by this time the monarchy of Nimrod had been broken up, or that at least the seat of government had been transferred to Elam. Be this as it may, the name of Assyria as an independent state does not again appear in Scripture till the closing period of the age of Moses. Balaam, a seer from the northern part of Mesopotamia, in the neighbourhood of Assyria, addressing the Kenites, a mountain tribe on the east side of the Jordan, 'took up his parable,' *i. e.* raised his oracular, prophetic chant, and said, 'Durable is thy dwelling-place! Ye in a rock puttest thou thy nest: nevertheless, wasted shall be the Kenite, until Asshur shall lead them captive.' In this verse, besides the play upon the word *ken* (the Hebrew for a nest), the reader may remark the striking contrast drawn between the permanent nature of the abode, and the transient possession of it by the occupants. The prediction found its fulfilment in the Kenites being gradually reduced in strength (comp. 1 Sam. xv. 6), till they finally shared the fate of the Transjordanite tribes, and were swept away into captivity by the Assyrians (1 Chr. v. 26; 2 Kings xvi. 9; xix. 12, 13; 1 Chr. ii. 55). But as a counterpart to this, Balaam next sees a vision of retaliatory vengeance on their oppressors, and the awful prospect of the threatened devastations, though beheld in far distant times, extorts from him the exclamation, 'Ah! who shall live when God doeth this? For ships shall come from the coast of Chittim, and shall afflict Asshur, and shall afflict Eber, but he also [the invader] shall perish for ever.'

This is not without obscurity; but it has commonly been supposed to point to the conquest of the regions that once formed the Assyrian empire, first by the Macedonians from Greece, and then by the Romans, both of whose empires were in their turn overthrown.

In the time of the Judges, the people of Israel became subject to a king of Mesopotamia, Chushan-rishathaim (Judg. iii. 8), who is by Josephus styled King of the Assyrians; but we are left in the same ignorance as in the case of Chedorlaomer, as to whether he was an independent sovereign or only a viceroy for another. The eighty-third Psalm (ver. 9), mentions Ashur as one

of the nations leagued against Israel; but as the date of that composition is unknown, nothing certain can be founded on it. The first king of Assyria alluded to in the Bible, is he who reigned at Nineveh when the prophet Jonah was sent thither (Jon. iii. 6). Hales supposes him to have been the father of Pul, the first Assyrian monarch named in Scripture, and dates the commencement of his reign *b. c.* 821. By that time the metropolis of the empire had become 'an exceeding great' and populous city, but one pre-eminent in wickedness (Jon. i. 2; iii. 3; iv. 11).

The first expressly recorded appearance of the Assyrian power in the countries west of the Euphrates is in the reign of Menahem, king of Israel, against whom 'the God of Israel stirred up the spirit of Pul (or Phul), king of Assyria' (1 Chron. v. 26), who invaded the country, and exacted a tribute of a thousand talents of silver 'that his hand' *i. e.* his favour, 'might be with him to confirm the kingdom in his hand' (2 Kings xv. 19, 20). Newton places this event in the year *b. c.* 770, in the twentieth year of Pul's reign, the commencement of which he fixes in the year *b. c.* 790. As to his name, we find the syllable *Pal, Pel,* or *Pul* entering into the names of several Assyrian kings (*e. g.* *Pilēser, Sardanapal-us*); and hence some connect it with the Persian '*bala,*' *i. e.* high, exalted, and think it may have been part of the title which the Assyrian monarchs bore. Hales conjectures that Pul may have been the second *Belus* of the Greeks, his fame having reached them by his excursions into Western Asia. About this period, we find the prophet Hosea making frequent allusions to the practice both of Israel and Judæa, to throw themselves for support on the kings of Assyria. In ch. v. 13; x. 6, our version speaks of their specially seeking the protection of a 'king Jareb,' but the original there is very obscure; and the next Assyrian monarch mentioned by name is *Tiglath-pileser*. The supposition of Newton is adopted by Hales, that at Pul's death his dominions were divided between his two sons, Tiglath-pileser and Nabonassar, the latter being made ruler at Babylon, from the date of whose government or reign the celebrated *era of Nabonassar* took its rise, corresponding to *b. c.* 747. The name of the other is variously written Tiglath and Tilgath, Pileser and Pilreser: the etymology of the first is unknown (some think it has a reference to the river Djlath, *i. e.* the Tigris). Pileser signifies in Persian 'exalted prince.' When Ahaz, king of Judah, was hard pressed by the combined forces of Pekah, king of Israel, and Reziu, king of Damascus-Syria, he purchased Tiglath-pileser's assistance with a large sum, taken out of his own and the Temple treasury. The Assyrian king accordingly invaded the territories of both the confederated kings, and annexed a portion of them to his own dominions, carrying captive a number of their subjects (2 Kings xv. 29; xvi. 5-10; 1 Chr. v. 26; 2 Chr. xxviii. 16; Isa. vii. 1-11; comp. Amos i. 5; ix. 7). His successor was *Shalman* (Hos. x. 4), *Shalmaneser* or *Salmannassar*, the Enemessar of the apocryphal book Tobit (ch. i. 2). He made Hoshea, king of Israel, his tributary vassal (2 Kings xvii. 3); but finding him secretly negotiating with So or Sobaco (the Sabakety of the monuments), king of Egypt, he laid siege to the Israelitish capital,

Samaria, took it after an investment of three years (B.C. 719), and then reduced the country of the ten tribes to a province of his empire, carrying into captivity the king and his people, and settling Cutheans from Babylonia in their room (2 Kings xvii. 3-6; xviii. 9-11). Hezekiah, king of Judah, seems to have been for a time his vassal (2 Kings xviii. 7); and we learn from the Tyrian annals, preserved by Menaider of Ephesus (as cited by Josephus, *Antiq.* x. 14. 2), that he subdued the whole of Phœnicia, with the exception of insular Tyre, which successfully resisted a siege of five years. The empire of Assyria seems now to have reached its greatest extent, having had the Mediterranean for its boundary on the west, and including within its limits Media and Kir on the north, as well as Elam on the south (2 Kings xvi. 9; xvii. 6; Isa. xx. 6). In the twentieth chapter of Isaiah (ver. 1), there is mention of a king of Assyria, *Sargon*, in whose reign Tartan besieged and took Ashdod in Philistia; and as Tartan is elsewhere spoken of (2 Kings xviii. 17) as a general of Sennacherib, some have supposed that Sargon is but another name of that monarch, while others would identify him either with Shalmaneser, or with Esarhaddon, Sennacherib's successor. But the correctness of all these conjectures may fairly be questioned; and we adhere to the opinion of Gesenius (*Comment. on Isa.* in loc.), that Sargon was a king of Assyria, who succeeded Shalmaneser, and had a short reign of two or three years. He thinks the name may be equivalent to *Ser-jauneh*, 'Prince of the Sun.' Von Bohlen prefers the derivation of *sergun*, 'gold-coloured.' His attack on Egypt may have arisen from the jealousy which the Assyrians entertained of that nation's influence over Palestine ever since the negotiation between its king So, and Hoshea, king of Israel. From many incidental expressions in the book of Isaiah we can infer that there was at this time a strong Egyptian party among the Jews, for that people are often warned against relying for help on Egypt, instead of simply confiding in Jehovah (Isa. xxx. 2; xxxi. 1; comp. xx. 5, 6). The result of Tartan's expedition against Egypt and Ethiopia was predicted by Isaiah while that general was yet on the Egyptian frontier at Ashdod (Isa. xx. 1-4); and it is not improbable that it is to this Assyrian invasion that the prophet Nahum refers when he speaks (iii. 8-10) of the subjugation of No, *i. e.* No-Ammon, or Thebes, the capital of Upper Egypt, and the captivity of its inhabitants. The occupation of the country by the Assyrians, however, must have been very transient, for in the reign of Sargon's successor, *Sennacherib*, or *Sancherib*, we find Hezekiah, king of Judah, throwing off the Assyrian yoke, and allying himself with Egypt (2 Kings xviii. 7, 21). This brought against him Sennacherib with a mighty host, which, without difficulty, subdued the fenced cities of Judah, and compelled him to purchase peace by the payment of a large tribute. But 'the treacherous dealer dealt very treacherously' (Isa. xxxiii. 1); and, notwithstanding the agreement, proceeded to invest Jerusalem. In answer, however, to the prayers of the 'good king' of Judah, the Assyrian was diverted from his purpose, partly by the 'rumour' (Isa. xxxvii. 6) of the approach of Tirhakah, king of Ethiopia, and

partly by the sudden and miraculous destruction of a great part of his army (2 Kings xviii. 13-37; xix.; Isa. xxxvi. and xxxvii.). He himself fled to Nineveh, where, in course of time, when worshipping in the temple of his god Nisroch, he was slain by his sons Adrammelech and Sharezer, the parricides escaping into the land of Armenia—a fact which is preserved in that country's traditional history [ARARAT]. Regarding the period of Sennacherib's death chronologists differ. Hales, following the apocryphal book of Tobit (i. 21), places it fifty-five days after his return from his Jewish expedition; but Gesenius (*Comment. on Isa.* p. 999) has rendered it extremely probable that it did not take place till long after. He founds this opinion chiefly on a curious fragment of Berossus, preserved in the Armenian translation of the *Chronicle* of Eusebius. It states that, after Sennacherib's brother had governed Babylon as the Assyrian viceroy, the sovereignty was successively usurped by Acises, Merodach, or Berodach Baladan (Isa. xxxix. 1; 2 Kings xx. 12), and Elibus or Belibus. But, after three years, Sennacherib regained dominion in Babylonia, and appointed as viceroy his own son Assordan, the Esarhaddon of Scripture. This statement serves to explain how there was in Hezekiah's time a king at Babylon, though, both before and after, it was subject to Assyria. The only objection to it is, that Isaiah relates the murder of Sennacherib before Merodach Baladan's embassy to Jerusalem. But to this Gesenius replies that that arrangement is followed by the prophet in order to conclude the history of the Assyrian monarch, so as not to have to return to it again. Sennacherib is obviously the king of Arabia and Assyria mentioned by Herodotus under the name of *Sanacharibos*, of whom he relates (ii. 141) that 'he attacked Egypt with a mighty army, but that on his arrival at Pelusium his camp became infested during night with so vast a number of mice, that their quivers and bows, together with what secured their shields to their arms, were gnawed in pieces; and finding themselves, in the morning, defenceless, they fled in confusion, and lost great numbers of their men. There is now to be seen (he adds) in the temple of Vulcan a marble statue of this king, having a mouse in his hand, and with this inscription, "Whoever thou art, learn from my fortune to reverence the gods."' The king of Egypt was Sethos, or So, priest of Vulcan. Prideaux and others suppose that we have here a corruption of the story of the miraculous destruction of the Assyrian army before Jerusalem, but the point is open to doubt. Gesenius is inclined to identify Sennacherib with the Sardanapalus to whom Arrian (*Exped. of Alex.* ii. 5) and Strabo (xiv. 4. 8) ascribe the erection of the cities of Anchiæ and Tarsus in Cilicia, after his successful suppression of a revolt of the Greeks there. But there is much confusion in the ancient accounts of Sardanapalus, and some have supposed that the name was a royal title, common to all the Assyrian kings, *q. d.* *Sar-dana-bala*, *i. e.* wise, exalted prince. As to the etymology of 'Sennacherib,' Von Bohlen suggests its affinity to the Persian 'Sāngerb,' *i. e.* 'splendour of the conqueror.'

Sennacherib was succeeded by his son Esarhaddon, or Assarhaddon, who had been his father's viceroy at Babylon (2 Kings xix. 37; Isa. xxxvii.

98). He is the Sacherdon, or Sarchedon, of Tobit (i. 21), and the Asaradinus of Ptolemy's Canon. Hales regards him as the first Sardanapalus. The only notice taken of him in Scripture is that he settled some colonists in Samaria (Ezra iv. 2), and as (at ver. 10) that colonization is ascribed to the 'great and noble Asnapper,' it is supposed that that was another name for Esarhaddon, but it may have been one of the great officers of his empire. It seems to have been in his reign that the captains of the Assyrian host invaded and ravaged Judah, carrying Manasseh, the king, captive to Babylon. The subsequent history of the empire is involved in almost as much obscurity as that of its origin and rise. The Medes had already shaken off the yoke, and the Chaldæans soon appear on the scene as the dominant nation of Western Asia; yet Assyria, though much reduced in extent, existed as an independent state for a considerable period after Esarhaddon. Hales, following Syncellus, makes him succeeded by a prince called Ninus (b.c. 667), who had for his successor Nebuchodonosor (b.c. 653), for the transactions of whose reign, including the expedition of his general Holofernes into Judæa, Hales relies on the apocryphal book of Judith, the authority of which, however, is very questionable. The last monarch was Sarac, or Sardanapalus II. (b.c. 636), in whose reign Cyaxares, king of Media, and Nabopolassar, viceroy of Babylon, combined against Assyria, took Nineveh, and, dividing what remained of the empire between them, reduced Assyria Proper to a province of Media (b.c. 606).

In this brief sketch of the history of the Assyrian empire, we have mainly followed the writers of the Old Testament, from whom alone any consistent account can be derived. The original sources of profane history on this subject are Herodotus and Ctesias, but every attempt to reconcile their statements with those of Scripture, or even with each other, has hitherto failed. The former fixes the duration of the Assyrian dominion in Upper Asia at 520 years (Herod. i. 95); while the latter again assigns to the Assyrian empire, from Ninus to Sardanapalus, no less a period than 1305 years (Diodor. Sicul. ii. 21). The authority of Ctesias, however, is very generally discredited (it was so even by Aristotle), though he has recently found a defender in Dr. Russell, in his *Connection of Sacred and Profane History*. The truth is (as is remarked by the judicious Heeren) that the accounts of both these historians are little better than mere traditions of ancient heroes and heroines (witness the fables about Semiramis!), without any chronological data, and entirely in the style of the East. To detail all the fanciful hypotheses which have been propounded, with the view of forming out of them a consistent and coherent narrative, forms no part of our present design. The curious in these speculations we refer to the essays of Pezron, Sevin, Freret, and Debrosse, in the *Mémoires de l'Acad. des Inscriptions*; Fourmont, *Réflexions Antiques sur les Histoires des Anciens Peuples*; Volney, *Recherches Nouvelles sur l'Hist. Ancienne*—a very valuable elucidation of the chronology of Herodotus.

The political constitution of the Assyrian empire was no doubt similar to that of other ancient states of the East, such as Chaldea and Persia.

The monarch, called 'the great king' (2 Kings xviii. 19; Isa. xxxvi. 4), ruled as a despot, surrounded with his guards, and only accessible to those who were near his person (Diod. Sicul. ii. 21, 23). Under him there were provincial satraps, called in Isa. x. 8, 'princes,' of the rank and power of ordinary kings. The great officers of the household were commonly eunuchs (comp. Gesenius on Isa. xxxvi. 2). The religion of the Assyrians was, in its leading features, the same as that of the Chaldæans, viz. the symbolical worship of the heavenly bodies, especially the planets. In Scripture there is mention of Niroch, Adramelech, Anammelech, Nebchaz, Tartak, &c., as the names of idols worshipped by the natives either of Assyria Proper or of the adjacent countries which they had subdued (see Gesenius on *Isaiah*, vol. ii. p. 317). The language did not belong to the Semitic, but to the Medo-Persian family. As Aramaic, however, was spoken by a large part of the western population, it was probably understood by the great officers of state, which accounts for Rabshakeh addressing Hezekiah's messengers in Hebrew (2 Kings xviii. 26), though the Rabbins explain the circumstance by supposing that he was an apostate Jew.—N. M.

ASTARTE. [ASHTORETH.]
 ASTRONOMY (ἀστρον and νόμος), that science which treats of the laws of the stars, or heavenly bodies, considered in reference to their magnitude, movements, and respective influence one upon another. Astronomy may be divided into empirical and scientific; the first being founded on the apparent phenomena and movements of the heavenly bodies, the second upon their real phenomena and movements. The knowledge of the ancients was limited to the first; or if they possessed any truths connected with the second, they were nothing more than bold or fortunate guesses, which were not followed out to their legitimate consequences, nor formed into a systematic whole.

The cradle of astronomy is to be found in Asia. The few and imperfect notices which have come down to these times, give a concurrent testimony in favour of this statement; and therewith agrees the fact, that the climate, the mode of life, and the occupations of the Oriental nations that were first civilized, prompted them to watch and observe the starry heavens. The Chaldæans are accounted to have excelled in astronomical knowledge.

Pliny, in his celebrated enumeration (*Hist. Nat.* vii. 57) of the inventors of the arts, sciences, and conveniences of life, ascribes the discovery of astronomy to Phœnician mariners: 'Siderum observationem in navigando Phœnices;' and in the same chapter he speaks of astronomical observations found on burnt bricks (*coctilibus laterculis*) among the Babylonians, which ascend to above 2200 years b.c. Alexander sent to Aristotle from Babylon a series of astronomical observations, extending through 1900 years. The astronomical knowledge of the Chinese and Indians goes up to a still earlier period (Plin. *Hist. Nat.* vi. 17-21). From the remote East astronomy travelled in a westerly direction. The Egyptians at a very early period had some acquaintance with it. To them is to be ascribed a pretty near determination of the length of the year, as consisting of 365 days 6 hours

(Herodotus, ii. 4). The Egyptians were the teachers of the Greeks.

Some portion of the knowledge which prevailed on the subject would no doubt penetrate to and become the inheritance of the Hebrews; who do not, however, appear to have possessed any views of astronomy which raised their knowledge to the rank of a science, or made it approach to a more correct theory of the mechanism of the heavens than that which was generally held. Nor, if the Bible is taken as the witness, do the ancient Israelites appear to have had extensive knowledge in the matter. They possessed such an acquaintance with it as tillers of the ground and herdsmen might be expected to form while pursuing their business, having, as was natural, their minds directed to those regions of the heavens which night after night brought before their eyes: accordingly, the peculiar Oriental names of the constellations are derived from circumstances connected with a nomade people. A peculiarity of the greatest importance belongs to the knowledge which the Israelites display of the heavens, namely, that it is thoroughly imbued with a religious character; nor is it possible to find in any other writings, even at this day, so much pure and elevated piety, in connection with observations on the starry firmament, as may be gathered even in single books of the Bible (Amos v. 8; Psalm xix.).

As early as the days of the patriarchs the minds of pious men were attracted and enraptured by the splendour of the skies (Gen. xxxvii. 9); and imagery borrowed from the starry world soon fixed itself firmly in human speech. The sun and moon were distinguished from other heavenly bodies, in consequence of their magnitude and their brilliancy, as being the lights of heaven and earth (Gen. i. 16); and from the course of the moon time was divided into parts, or months, of which the oldest form of the year, the lunar, was made up. Every new moon was greeted with religious festivities. While, however, the sun in his power, the moon walking in brightness, and all the stars of light conspired to excite devotion, their influence on the hearts of the ancient Israelites, who were happily instructed in a knowledge of the true God, the one Jehovah, the sole Creator of the world, stopped short of that idolatrous feeling, and was free from those idolatrous practices to which, among nations of less religious knowledge—and especially among their own neighbours, the Babylonians, for instance—it is unhappily known to have led.

As early as the time of the composition of perhaps the oldest book in the Bible, namely, that of Job, the constellations were distinguished one from another, and designated by peculiar and appropriate names (Job ix. 9; xxxviii. 31). In the Bible are found, 1. הַיְלֵל (the morning star, the planet Venus (Isa. xiv. 12; Rev. ii. 28); 2. כִּימָה (Job ix. 9; xxxviii. 35; Amos v. 8), the Pleiades; 3. כְּסִיל, Orion, a large and brilliant constellation, which stands in a line with the Pleiades. The Orientals seem to have conceived of Orion as a huge giant who had warred against God, and as bound in chains to the firmament of heaven (Job xxxviii. 31); and it has been conjectured that this notion is the foundation of the history of Nimrod (Ges. *Comment. zu Isaiah*, i. 457); 4. עֵשׂ (Job ix. 9), the Great Bear, which has still

the same name among the Arabians (Niebuhr, b. 113). In the common version No. 4 is rendered 'Arcturus,' No. 3 'Orion,' and No. 2 'Pleiades.' See Job xxxviii. 32, where the sons of Arcturus are the three stars in the tail of the Bear, which stand in a curved line to the left. 5. נָחִישׁ (Job xxvi. 13, 'the crooked serpent'), Draco, between the Great and the Little Bear; a constellation which spreads itself in windings across the heavens; 6. Διδόσκουροι (Acts xxviii. 11), Gemini, or the Twins, on the belt of the Zodiac, which is mentioned in 2 Kings xxiii. 5, under the general name of 'the planets'—מְלוּחֹת; a word which signifies dwellings, stations in which the sun tarries in his apparent course through the heavens. (Compare Gen. xxxvii. 9.) The entire body of the stars was called 'the host of heaven' כְּנֶסֶף הַשָּׁמַיִם (Isa. xl. 26; Jer. xxxiii. 22).

No trace is found in the Old Testament of a division of the heavenly bodies into planets, fixed stars, and comets; but in Jude 13, the phrase 'wandering stars' (ἀστέρες πλανῆται) is employed figuratively.

After the Babylonian exile, the Jews were compelled, even for the sake of their calendar, to attend at least to the course of the moon, which became an object of study, and delineations were made of the shapes that she assumes (*Mischna rosch hashsh.* ii. 8).

At an early period of the world the worship of the stars arose from that contemplation of them which in every part of the globe, and particularly in the East, has been found a source of deep and tranquil pleasure. 'Men by nature' 'deemed either fire or wind, or the swift air, or the circle of the stars, or the violent water, or the lights of heaven, to be the gods which govern the world;' 'with whose beauty being delighted, they took them to be gods' (Wisdom xiii. 2). Accordingly, the religion of the Egyptians, of the Chaldees, Assyrians, and the ancient Arabians, was nothing else than star-worship, although in the case of the first its origin is more thickly veiled. The sun, moon, and seven planets (those, that is, of the fixed stars which shine with especial brightness) excited most attention, and won the greatest observance. We thus find among the Babylonians Jupiter (Belus, 𐎶, Isa. lxx. 11), Venus (כְּסִיל, Isa. lxx. 11, where the first is rendered in the common version 'that troop,' the second 'that number'). Both these were considered good principles. Mercury, honoured as the secretary of heaven, is also found in Isa. xlvi. 1, 'Nebo stoopeth;' Saturn (כְּסִיל, Amos v. 26); Mars (נְרַל, 2 Kings xvii. 30): the two last were worshipped as principles of evil. The character of this worship was formed from the notions which were entertained of the good or ill which certain stars occasioned. Astrology found its sphere principally in stars connected with the birth of individuals. Thus Herodotus (ii. 82) states that among the Egyptians every day was under the influence of some god (some star), and that according to the day on which each person was born, so would be the events he would meet with, the character he would bear, and the period of his death. Astrology concerned itself also with the determination of lucky and unlucky days: so in Job iii. 3, 'Let the day perish wherein I was born;' and Gal. iv. 10, 'Ye observe days, and

months, and times, and years.' The Chaldeans, who studied the stars at a very early period, were much given to astrology, and were celebrated for their skill in that pretended science (Isa. xlvii. 13). In Daniel ii. 27; v. 11, 'the calculators of natiuities (כַּוְנָנִים) are named. Diodorus Siculus (ii. 30, 31) says of the Chaldeans, 'They assert that the greatest attention is given to the five stars called planets, which they name interpreters; so called because, while the other stars have a fixed path, they alone, by forming their own course, show what things will come to pass, thus interceding to men the will of the gods; for to those who study them carefully they foretell events, partly by their rising, partly by their setting, and also by their colour. Sometimes they show heavy winds, at others rains, at others excess of heat. The appearance of comets, eclipses of the sun, earthquakes, and, in general, anything extraordinary, has in their opinion an injurious or a beneficial effect, not only on nations and countries, but kings, and even common individuals: and they consider that those stars contribute very much of good or of ill in relation to the births of men: and in consequence of the nature of these things, and of the study of the stars, they think they know accurately the events that befall mortals.' Comets were for the most part considered heralds of evil tidings (Joseph. *De Bell. Jud.* vi. 5. 3). The Orientals of the present day hold astrology in honour (Niebuhr, p. 120); and stipendiary astrologers form a part of their court (Kämpfer, *Amoen.* p. 57, 82). On the subject of this article may be consulted Hamner, *Ueber die Sternbilder der Araber*; Ideler, *Untersuchungen über den Ursprung, &c. der Sternnamen*, Berlin, 1809; also his *Unter. über die Astron. beobacht der Alten*. Berlin, 1806; and Weidler, *Hist. Astronom.* Viteb. 714.—J. R. B.

ATAD, the person on whose threshing-floor the sons of Jacob and the Egyptians who accompanied them performed their final act of solemn mourning for Jacob (Gen. l. 11); on which account the place was afterwards called Abel-Mizraim, 'the mourning of the Egyptians.'

ATAD. [THORN].

ATAROTH (עֲטָרוֹת). Several places of this name (which means *crowns*) occur in the Scriptures. 1. *Ataroth-beth-Joab*, in the tribe of Judah (1 Chron. ii. 54). 2. *Ataroth*, on the borders of Ephraim (Josh. xvi. 2, 7), which some identify with, and others distinguish from, the *Ataroth-Addar* of the same tribe mentioned in Josh. xvi. 5; xviii. 13. 3. *Ataroth*, in the tribe of Gad, beyond the Jordan (Num. xxxii. 3, 34). 4. *Ataroth-Shophan*, in the same tribe (Num. xxxii. 35), which some identify with the preceding; but it appears more likely that the addition was used to distinguish the one from the other. Eusebius and Jerome (*Onomasticon*, s. v. *Ataroth*, Ἀταρόθ) mention two places in the tribe of Benjamin called *Ataroth*; but they do not occur in Scripture. The site of one of these appears to have been discovered by Professor Robinson (*Bib. Researches*, ii. 314) under the name of *Atara*. Another place of the same name (*Atara*) he found about six miles N. by W. of Bethel, which appears to represent the *Ataroth* of Ephraim (Josh. xvi. 2, 7). It is now a large village on the summit of a high hill (Robinson, iii. 8).

ATBACH (אֲתַבַּח) is not a real word, but a fictitious cabalistic term, denoting by its very letters the mode of changing one word into another by a peculiar commutation of letters. The system on which it is founded is this: as all the letters have a numerical value, they are divided into three classes, in the first of which every pair makes the number *ten*; in the second, *a hundred*; and in the third, *a thousand*.

Thus: אט, טא, every pair making ten.

כפ, פכ, ,, a hundred.

צ, כצ, ,, ,,

קן, נק, ,, a thousand

Three letters only cannot enter into any of these numerical combinations, ה, ו, and י. The first two are nevertheless coupled together; and the last is suffered to stand without commutation. The commutation then takes place between the two letters of every pair; and the term *Atbach* thus expresses that א is taken for ט, and ב for פ, and conversely. To illustrate its application, the obscure word מַנּוּן, in Prov. xxix. 21, may be turned by *Atbach* into כוּהָה, *testimony*. Buxtorf, *De Abbreviaturis*, s. v.

ATHBASH (אֲתַבַּשׁ) is a similar term for a somewhat different principle of commutation. In this, namely, the letters are also mutually interchanged by pairs; but every pair consists of a letter from each end of the alphabet, in regular succession. Thus, as the technical term *Athbash* shows, א and ת, and ב and שׁ, are interchangeable; and so on throughout the whole series. By writing the Hebrew alphabet twice in two parallel lines, but the second time in an inverse order, the two letters which form every pair will come to stand in a perpendicular line. This system is also remarkable on account of Jerome having so confidently applied it to the word *Sheshak*, in Jer. xxv. 26. His words are, 'Quomodo *Babel* intelligatur *Sesach*, non magnopere laborabit qui Hebrææ linguæ parvam saltem habuerit scientiam.' He then propounds the same system of commutation as that called *Athbash* (without giving it that name however, and without adducing any higher authority for assuming this mode of commutation, than the fact that it was customary to learn the Greek alphabet first straight through, and then, by way of ensuring accurate retention, to repeat it by taking a letter from each end, alternately), and makes שׁשׁ to be the same as ככל. (See Rosenmüller's *Scholia*, ad loc.) Hottinger possessed an entire Pentateuch explained on the principle of *Athbash* (*Thesaur. Philol.* p. 450).

There is also another system of less note, called *ALBAM* (אֲלַבָּם), which is only a modification of the preceding. For, in it, the alphabet is divided into halves, and one portion placed over the other in the natural order, and the pairs are formed out of those letters which would then stand in a row together.

All these methods belong to that branch of the Cabbala which is called תַּמּוּרָה, *commutation*.—J. N.

ATERGATIS (Ἀτεργάτης, or Ἀταργάτις) is the name of a Syrian goddess, whose temple (Ἀτεργατίου) is mentioned in 2 Macc. xii. 26. That temple appears, by comparing 1 Macc. v. 43, to have been situated at *Ashteroth-Karnaim*. Her worship also flourished at *Mabûg* (i. e. *Bam-*

byce, afterwards called Hierapolis) according to Pliny (*Hist. Nat.* v. 19).

There is little doubt that Atergatis is the same divinity as Derketo. Besides internal evidences of identity, Strabo incidentally cites Ctesias to that effect (xvi. p. 1132); and Pliny uses the terms 'Prodigiosa Atergatis, Græcis autem Derketo dicta' (l. c.). We read that Derketo was worshipped in Phœnicia and at Ascalon under the form of a woman with a fish's tail, or with a woman's face only and the entire body of a fish; that fishes were sacred to her, and that the inhabitants abstained from eating them in honour of her. These facts are found in Lucian (*De Dea Syria*, xiv.), and, together with a mythological account of their origin, in Diodorus (ii. 4). Further, by combining the passage in Diodorus with Herodotus (i. 105), we may legitimately conclude that the Derketo of the former is the Venus Urania of the latter. Atergatis is thus a name under which they worshipped some modification of the same power which was adored under that of Ashtoreth. That the *Ἀτεργατίων* of 2 Macc. xii. 26 was at Ashteroth-Karaim, shows also an immediate connection with Ashtoreth. Whether, like the latter, she bore any particular relation to the moon, or to the planet Venus, is not evident. Macrobius makes Adargatis to be the earth (which as a symbol is analogous to the moon), and says that her image was distinguished from that of the sun by rays 'sursum versus incluinatis, monstrando radiorum vi superne missorum enasci quæcunque terra progenerat' (*Saturnal.* i. 23). Creuzer maintains that those representations of this goddess which contain parts of a fish are the most ancient; and endeavours to reconcile Strabo's statement that the Syrian goddess of Hierapolis was Atergatis, with Lucian's express notice that the former was represented under the form of an entire woman, by distinguishing between the forms of different periods (*Symbolik*, ii. 68). This fish-form shows that Atergatis bears some relation, perhaps that of a female counterpart, to DAGON.

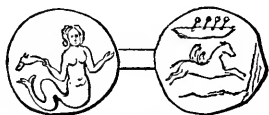

No satisfactory etymology of the word has been discovered. That which assumes that Atergatis is *אֲדַרְיַן* *addir dag*, i. e. magnificent fish, which has often been adopted from the time of Selden down to the present day, cannot be taken exactly in that sense. The syntax of the language requires, as Michaelis has already objected to this etymology (*Orient. Biblioth.* vi. 97), that an adjective placed before its subject in this manner must be the predicate of a proposition. The words therefore would mean 'the fish is magnificent' (Ewald's *Hebr. Gram.* § 554). Michaelis himself, as he found that the Syriac name of some idol of Haran was *אֲדַרְיַן*, which might mean aperture, asserts that that is the Syriac form of Derketo, and brings it into connection with the great fissure in the earth, mentioned in Lucian (l. c. xiii.), which swallowed up the waters of the flood (see his edition of Castell's *Lex. Syr.* p. 975). On the other hand, Gesenius (*Thesaur.* sub voce *דַּרְכֵּתוֹ*)

prefers considering Derketo to be the Syrian *דַּרְכֵּתוֹ*, for *דַּרְכֵּתוֹ* fish; and it is certain that such an intrusion of the Resh is not uncommon in Aramaic.—J. N.

ATHALIAH (*עֲתָלְיָהּ* or *עֲתָלְיָהּ* whom *Jehovah* remembered; Sept. *Γοθολία*), daughter of Ahab, king of Israel, doubtless by his idolatrous wife Jezebel. She is also called the daughter of Omri (2 Chron. xxii. 2), who was the father of Ahab; but by a comparison of texts it would appear that she is so called only as being his grand-daughter. Athaliah became the wife of Jehoram, the son of Jehoshaphat, king of Judah. This marriage may fairly be considered the act of the parents; and it is one of the few stains upon the character of the good Jehoshaphat that he was so ready, if not anxious, to connect himself with the idolatrous house of Ahab. Had he not married the heir of his crown to Athaliah, many evils and much bloodshed might have been spared to the royal family and to the kingdom. When Jehoram came to the crown, he, as might be expected, 'walked in the ways of the house of Ahab,' which the sacred writer obviously attributes to this marriage, by adding, 'for he had the daughter of Ahab to wife' (2 Chron. xxi. 6). This king died B.C. 885, and was succeeded by his youngest son Ahaziah, who reigned but one year, and whose death arose from his being, by blood and by circumstances, involved in the doom of Ahab's house [AHAZIAH]. Before this Athaliah had acquired much influence in public affairs, and had used that influence for evil; and when the tidings of her son's untimely death reached Jerusalem, she resolved to seat herself upon the throne of David, at whatever cost. To this end she caused all the male branches of the royal family to be massacred (2 Kings xi. 1); and by thus shedding the blood of her own grandchildren, she undesignedly became the instrument of giving completion to the doom on her father's house, which Jehu had partially accomplished, B.C. 884. One infant son of Ahaziah, however, was saved by his aunt Jehosheba, wife of the high-priest Jehoiada, and was concealed within the walls of the temple, and there brought up so secretly that his existence was unsuspected by Athaliah. But in the seventh year (B.C. 878) of her blood-stained and evil reign, the sounds of unwonted commotion and exulting shouts within the Temple courts drew her thither, where she beheld the young Joash standing as a crowned king by the pillar of inauguration, and acknowledged as sovereign by the acclamations of the assembled multitude. Her cries of 'Treason!' failed to excite any movement in her favour, and Jehoiada, the high-priest, who had organized this bold and successful attempt, without allowing time for pause, ordered the Levitical guards to remove her from the sacred precincts to instant death (2 Kings xi.; 2 Chron. xxi. 6; xxii. 10-12; xxiii.).

ATHENS. This celebrated city, as the birth-place of Plato, and through him so widely influential on Judaism and Christianity, deserves something else than a geographical notice here. We shall briefly allude to the stages of her history, and remark on some of the causes of her pre-eminent greatness in arms, arts, and intellectual subtlety.

The earlier and more obscure period of the Gre-

cian province named Attica reaches down nearly to the final establishment of democracy in it. Yet we know enough to see that the foundations of her greatness were then already laid. Even the un-fertile soil and dry atmosphere of Attica, in connection with the slender appetite of the people, have been thought as favourable to their mental development, as the fertility of the neighbouring Boeotia was injurious to its voracious inhabitants. The barrenness of the soil, moreover, prevented invaders from coveting it; so that through a course of ages the population remained unchanged, and a moral union grew up between the several districts. To a king named Theseus (whose deeds are too much mixed with fable to be narrated as history) is ascribed the credit of uniting all the country-towns of Attica into a single state, the capital of which was Athens. This is the first political event that we can trust as historical,

although its date and circumstances are by no means free from obscurity.

The population of this province was variously called Pelasgian, Achaian, and Ionian, and probably corresponds most nearly to what was afterwards called Æolian (Prichard, *Phys. Hist. of Man*, iii. p. 494). The first name carries the mind back to an extremely primitive period. When the Dorians, another tribe of Greeks of very different temperament, invaded and occupied the southern peninsula, great numbers of its Achaian inhabitants took refuge in Attica. Shortly after, the Dorians were repulsed in an inroad against Athens, an event which has transmitted to legendary renown the name of King Codrus; and thenceforward Athens was looked upon as the bulwark of the Ionian tribes against the barbarous Dorians. Overloaded with population, Attica now poured forth colonies into Asia; some of which, as Mi-

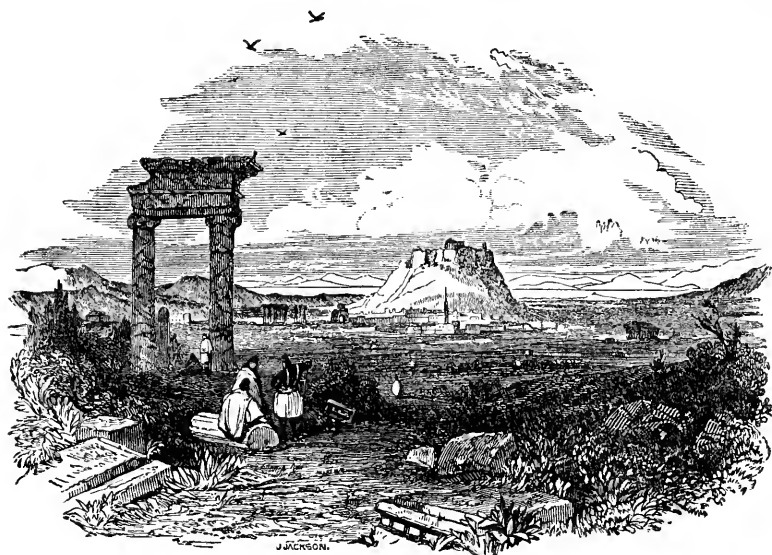

letus, soon rose to great eminence, and sent out numerous colonies themselves; so that Athens was revered as a mother of nations, by powerful children scattered along the western and northern coasts of Anatolia.

Dim tradition shows us isolated priesthoods and elective kings in the earliest times of Attica; these however gradually gave way to an aristocracy, which in a series of years established themselves as a hereditary ruling caste. But a country 'ever unravaged' (and such was their boast) could not fail to increase in wealth and numbers; and after two or three centuries, while the highest commoners pressed on the nobles, the lowest became overwhelmed with debt. The disorders caused by the strife of the former were vainly sought to be stayed by the institutions of Draco; the sufferings of the latter were ended, and the sources of violence dried up, by the enactments of Solon. Henceforth the Athenians revered the laws of Solon (*νόμοι*) as the groundwork of their whole civil polity; yet they retained by the side of them the ordinances of Draco (*θεσμοί*) in

many matters pertaining to religion. The date of Solon's reforms was probably B.C. 594.

The usurpation of Pisistratus and his sons made a partial breach in the constitution; but upon their expulsion, a more serious change was effected by Cleisthenes, head of the noble house of the Alcmaeonidæ (B.C. 508), almost in the same year in which Tarquin was expelled from Rome. An entirely new organization of the Attic tribes was framed, which destroyed whatever remained of the power of the nobles as an order, and established among the freemen a democracy, in fact, as well as in form. Out of this proceeded all the good and all the evil with which the name of Athens is associated; and though greatness which shot up so suddenly could not be permanent, there can be no difficulty in deciding that the good greatly preponderated.

Very soon after this commenced hostilities with Persia; and the self-denying, romantic, successful bravery of Athens, with the generous affability and great talents of her statesmen, soon raised her to the head of the whole Ionian confederacy. As

long as Persia was to be feared, Athens was loved; but after tasting the sweets of power, her sway degenerated into a despotism, and created at length, in the war called the Peloponnesian, a coalition of all Dorian and Æolian Greece against her (B.C. 431). In spite of a fatal pestilence and the revolt of her Ionian subjects, the naval skill of Athenian seamen and the enterprise of Athenian commanders proved more than a match for the hostile confederacy; and when Athens at last fell (B.C. 404), she fell by the effects of internal sedition more truly than by Spartan lances or Persian gold, or even by her own rash and over-grasping ambition. The demoralizing effects of this war on all Greece were infinitely the worst result of it, and they were transmitted to succeeding generations. It was substantially a *civil* war in every province; and, as all the inhabitants of Attica were every summer forced to take refuge in the few fortresses they possessed, or in Athens itself, the simple countrymen became transformed into a hungry and profligate town rabble.

From the earliest times the Ionians loved the lyre and the song, and the hymns of poets formed the staple of Athenian education. The constitution of Solon admitted and demanded in the people a great knowledge of law, with a large share in its daily administration. Thus the acuteness of the lawyer was grafted on the imagination of the poet. These are the two intellectual elements out of which Athenian wisdom was developed; but it was stimulated and enriched by extended political action and political experience. History and Philosophy, as the words are understood in modern Europe, had their birth in Athens about the time of the Peloponnesian war. Then first, also, the Oratory of the bar and of the popular assembly was systematically cultivated, and the elements of mathematical science were admitted into the education of an accomplished man. This was the period of the youth of Plato, whose philosophy was destined to leave so deep an impression on the Jewish and Christian schools of Alexandria. Its great effort was to unite the contemplative mysticism of Eastern sages with the accurate science of Greece; to combine, in short, the two qualities—intellectual and moral, argumentative and spiritual—into a single harmonious whole: and whatever opinion may be formed of the success which attended the experiment, it is not wonderful that so magnificent an aim attracted the desires and riveted the attention of thoughtful and contemplative minds for ages afterwards.

In the imitative arts of Sculpture and Painting, as well as in Architecture, it need hardly be said that Athens carried off the palm in Greece: yet, in all these, the Asiatic colonies vied with her. Miletus took the start of her in literary composition; and, under slight conceivable changes, might have become the Athens of the world. But all details on these subjects would be here out of place.

That Athens after the Peloponnesian war never recovered the political place which she previously held, can excite no surprise—that she rose so high toward it was truly wonderful. Sparta and Thebes, which successively aspired to the 'leadership' of Greece, abused their power as flagrantly as Athens had done, and, at the same time, more coarsely. The never-ending cabals, the treaties made and vio-

lated, the coalitions and breaches, the alliances and wars, recurring every few years, destroyed all mutual confidence, and all possibility of again uniting Greece in any permanent form of independence; and, in consequence, the whole country was soon swallowed up in the kingdom of Macedonia. With the loss of civil liberty, Athens lost her genius, her manly mind, and whatever remained of her virtue: she long continued to produce talents, which were too often made tools of iniquity, panders to power, and petty artificers of false philosophy.

A Christian church existed in Athens soon after the apostolic times; but as the city had no political importance, the church never assumed any eminent position.—F. W. N.

ATONEMENT. The Greek word is *καταλλαγῆ*, translated, Rom. v. 11, *atonement*, but in other places, *reconciliation* (See Rom. xi. 15; 2 Cor. v. 18, 19). In ecclesiastical writers, and in the canons of Councils, *καταλλαγῆ* is employed to signify the reconciliation of offenders to the Church after a due course of penitence. Of this there are said to have been two kinds: the one consisting merely in the remission of punishment; the other, in the restoration of the penitent to all the rights and privileges of communion. For the doctrine of Atonement, see articles SACRIFICE, REDEMPTION.—H. S.

ATONEMENT, DAY OF (יום פְּרוּר, *day of pardon*, Lev. xxiii. 27; xxv. 9). In the Talmud this day is called *תַּעֲנִית גְּדוֹלָה*, *great fasting*, or merely *יוֹם אִתָּה*, *THE DAY*; a circumstance which has suggested to some commentators the notion that by *הַמֶּרֶץ* (Heb. vii. 27) the apostle intended this *atonement day*. Though perhaps originally meant as a temporary day of expiation for the sin of the golden calf (as some would infer from Exod. xxxiii.), yet it was permanently instituted by Moses as a day of atonement for sins in general; and this day—the 10th of Tishri (our September)—is indeed the only fast ordained by Moses, though the later Jews, in commemoration of some disastrous events, especially those which occurred at and after the destruction of the two temples, instituted a few more fast days, which they observed with scarcely less rigour and strictness than the *one* ordained by Moses for the purpose of general absolution. This great fast, like all others among the Jews, commenced at sunset of the previous day, and lasted twenty-four hours, that is, from sunset to sunset, or, as the Rabbins will have it, until three stars were visible in the horizon. The ceremonies observed on this occasion are minutely described in Leviticus xvi., and were of a very laborious character, especially for the high-priest, who had to prepare himself during the previous seven days in nearly solitary confinement for the peculiar services that awaited him, and abstain during that period from all that could render him unclean, or disturb his devotions. The most remarkable ceremony of the day was the entrance of the high-priest into the Sanctuary, a thing not allowed on any other day, and to which Paul alludes, Heb. ix. 7. According to the Talmud (*Tract. Yoma*) and Maimonides (הלכות יום הכפורים, chap. iv.), the entrance of the high-priest into the Sanctuary took place four different times. The first time he was pro-

vided with the golden censer and the vessel filled with incense, when, after having entered, he placed the former between the two poles of the Tabernacle, and put the incense upon the coals. This done, he went out (according to the Talmud, *ibid.*, backwards, so as not to turn his back on the Sanctuary). At his second entrance, he took with him the blood of the bullock which he had offered in expiation for his own sins and those of the other priests, placed himself between the poles of the Tabernacle, dipped his finger in the blood, and sprinkled it seven times below and once above the mercy-seat. This done, he left the bason with the blood behind, and withdrew again. The third time, he entered with the blood of the ram which he had offered for the sins of the nation, with which he sprinkled towards the veil of the Tabernacle eight times; and having mixed it with the blood of the bullock, he sprinkled again towards the horns of the altar of incense seven times, and once above it towards the east, after which he poured out the whole on the floor of the altar of burnt offering, having again left the Sanctuary, and taken with him the basons of blood. The fourth time, he entered merely to fetch back the censer and vessel of incense; and having returned, he washed his hands and performed the other ceremonies of the day.

That the high-priest entered more than once into the Sanctuary during this solemnity is certainly clear from the various rites which he had to perform there, as described in Lev. xvi. 12, 14, 15. Nor does the assertion of the Talmud contradict Heb. ix. 7, where the Apostle tells us that the high-priest had entered only *once* on that day, since the expression, *απαξ τοῦ ἑνιαυτοῦ*, may refer to the *one day* in the year when such a service alone took place.

The other duties of the high-priest on that day consisted in frequent washings, changing his clothes, lighting the lamps, burning incense, &c.; which operations commenced soon after midnight of the 10th of the seven month (Tishri). The ceremonies of worship peculiar to this day alone (besides those which were common to it with all other days) were: 1. That the high-priest, in his pontifical dress, confessed his own sins and those of his family, for the expiation of which he offered a bullock, on which he laid them; 2. That two goats were set aside, one of which was by lot sacrificed to Jehovah, while the other (Azazel), which was determined by lot to be set at liberty, was sent to the desert burdened with the sins of the people (Lev. xvi.). According to the Talmud, both goats were to be alike in colour, stature, and age (at the time of their being set aside for the purposes of that day). For the peculiar ceremonies of the day, as regards the sacrifices, sprinkling of the blood, smoking the incense, &c., see Maimonides' *עבודת יום הכפורים* (*Worship of the Day of Atonement*), and D. Danzen's two *Dissertationes de Functione Pontificis Maximi in Adyto Anniversario*.

On this day also the high-priest gave his blessing to the whole nation; and the remainder of the day was spent in prayers and other works of penance.

Of the numerous meanings assigned to the word *עֲזָזֵל* (Azazel), we should be inclined to prefer *Loze* which render it expressive of the destination of the goat, or which derive it from the Arabic

عزل (to remove). *עֲזָזֵל* would then be equivalent to *غزازل* (solitude, desert); since we find a similar form in the *הַצִּיּוּרָה* (in the Talmud also (*Mishna*, tit. *Yomah*, iv. 2) this scape-goat goes by the name of *שְׂעִיר הַמִּזְבֵּחַ*, the *removed* or *sent-off goat*, though it is uncertain whether this is meant as a translation of the word *Azazel*, or is merely an epithet derived from one of the destinations of the goat (V. Ch. Hermanzen, *Observat. de nomine Azazel*, 1833).

Among the present orthodox Jews, for the scape-goat of old a cock seems to have been substituted, which they call *כַּפָּרָה* (pardon, atonement); and which, on the eve of the day of Atonement, they turn three times round their head, each time saying (in Hebrew) that the cock is to be sacrificed instead of them, after which it is slaughtered and eaten. Towards evening of the 9th of Tishri, and before they take the last meal for the next twenty-four hours, they repair to the synagogue, and each inflicts upon his neighbour thirty-nine blows with a piece of leather: this infliction is called *כּוֹלֵכוֹת*, in expiation of those sins which are punished by the law of Moses with flogging. Most of the Jews on that day (of atonement) wear a white gown—the same shrouds in which they are buried; while *all* of them are obliged to stand the whole day without shoes, or even slippers. For many more ceremonies observed among the present Jews on the day of Atonement, see B. Picard, *Cérémonies et Coutumes Religieuses*, &c. t. i. c. 6, p. 18.—E. M.

ATTALeia (Ἀττάλεια), a maritime city of Pamphylia, in Asia Minor, near the mouth of the river Catantbaetes. It derived its name from its founder, Attalus Philadelphus, king of Pergamos (Strabo, xiv. p. 667). It was visited by Paul and Barnabas, A. D. 45 (Acts xiv. 25). It still exists under the name of Adalia, and extensive and important ruins attest the former consequence of the city (Leake's *Asia Minor*, p. 193).

ATTITUDES. The allusions in Scripture to attitudes and postures expressive of adoration, supplication, and respect, are very numerous. From these we learn enough to perceive that the usages of the Hebrews in this respect were very nearly, if not altogether, the same as those which are still practised in the East, and which the paintings and sculptures of Egypt show to have been of old employed in that country. These sources supply ample materials for illustration, which it may be well to arrange under those heads into which such acts naturally divide themselves.

ADORATION AND HOMAGE.—The Moslems in their prayers throw themselves successively, and according to an established routine, into the various postures (nine in number) which they deem the most appropriate to the several parts of the service. For the sake of reference and comparison, we have introduced them all at the head of this article; as we have no doubt that the Hebrews employed on one occasion or another nearly all the various postures which the Moslems exhibit on one occasion. This is the chief difference. In public and common worship the Hebrews prayed *standing* (1 Kings viii. 54; Ezra ix. 5; Dan. vi. 10; 2 Chron. vi. 13); but in their separate and private acts of

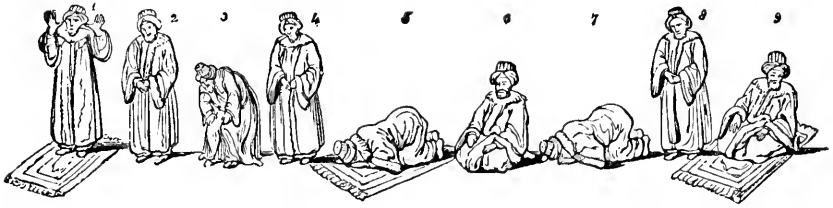

worship they assumed the position which, according to their modes of doing homage or showing respect, seemed to them the most suitable to their present feelings or objects. It would appear, however, that some form of kneeling was most usual in private devotions.

Standing in public prayer is still the practice of the Jews. This posture was adopted from the synagogue by the primitive Christians; and is still maintained by the Oriental Churches. This appears, from their monuments, to have been the custom also among the ancient Persians and Egyptians, although the latter certainly sometimes kneeled before their gods. In the Moslem worship, four of the nine positions (1, 2, 4, 8) are standing ones; and that posture which is repeated in three out of these four (2, 4, 8), may be pointed out as the proper Oriental posture of reverential standing, with folded hands. It is the posture in which people stand before kings and great men.

While in this attitude of worship, the hands were sometimes stretched forth towards heaven in supplication or invocation (1 Kings viii. 22; 2 Chron. vi. 12, 29; Isa. i. 15). This was perhaps not so much the conventional posture (1) in the Moslem series, as the more natural posture of standing adoration with outspread hands, which we observe on the Egyptian monuments. The uplifting of one hand

vi. 10; 2 Chron. vi. 13; comp. 1 Kings xix. 18; Luke xxii. 41; Acts vii. 60). This is still an Oriental custom, and three forms of it occur (5, 6, 9) in the Moslem devotions. It was also in use, although not very frequent, among the ancient Egyptians; and who likewise, as well as the Hebrews (Exod. xxxiv. 18; 2 Chron. xxix. 29; Isa. i. 15) sometimes prostrated themselves upon

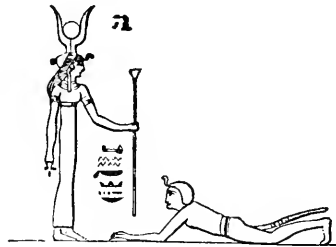

the ground. The usual mode of prostration among the Hebrews by which they expressed the most intense humiliation, was by bringing not only the body but the head to the ground



The ordinary mode of prostration at the present time, and probably anciently, is that shown in one of the postures of Moslem worship (5), in which the body is not thrown flat upon the ground, but rests upon the knees, arms, and head. In order to express devotion, sorrow, compunction or humiliation, the Israelites threw dust upon their heads (Josh. vii. 6; Job ii. 12; Lam. ii. 10; Ezek. xxiv. 7; Rev. xviii. 19), as was done also by the ancient Egyptians, and is still done by the modern Orientals. Under similar circumstances it was usual to smite the breast (Luke xviii. 13). This was also a practice among the Egyptians (Herod. ii. 85), and the monuments at



(the right) only in taking an oath was so common, that to say, 'I have lifted up my hand,' was equivalent to 'I have sworn' (Gen. xiv. 22; comp. xli. 44; Deut. xxxii. 40). This posture



was also common among other ancient nations; and we find examples of it in the sculptures of Persia (fig. 1) and Rome (fig. 2).

KNEELING is very often described as a posture of worship (1 Kings viii. 54; Ezra ix. 5; Dan.



Thebes exhibit persons engaged in this act while they kneel upon one knee.

In 1 Chron. xvii. 16 we are told that 'David the king came and *sat* before the Lord,' and in that posture gave utterance to eloquent prayer, or rather thanksgiving, which the sequel of the chapter contains. Those unacquainted with Eastern manners are surprised at this. But there is a mode of sitting in the East which is highly respectful and even reverential. It is that which occurs in the Moslem forms of worship (9). The person first kneels, and then sits back upon his heels. Attention is also paid to the position of the hands, which they cross, fold, or hide in the opposite sleeves. The variety of this formal sitting which the following figure represents is highly



respectful. The prophet Elijah must have been in this or some other similar posture when he inclined himself so much forward in prayer that his head almost touched his knees (1 Kings xviii. 42).

SUPPLICATION, when addressed externally to man, cannot possibly be exhibited in any other forms than those which are used in supplication to God. Uplifted hands, kneeling, prostration, are common to both. On the Egyptian



monuments, suppliant captives, of different nations, are represented as kneeling or standing with outspread hands. This also occurs in the sculptures of ancient Persia (Persepolis). The first of the Egyptian figures is of peculiar interest, as representing an inhabitant of Lebanon. *Prostration*, or *falling at the feet* of a person, is often mentioned in Scripture as an act of supplication or of reverence, or of both (1 Sam. xxv. 24; 2 Kings iv. 37; Esth. viii. 3; Matt. xviii. 29; xxviii. 9; Mark v. 22; Luke viii. 41; John xi. 32; Acts x. 25). In the instance last referred to, where Cornelius threw himself at the feet of Peter, it may be asked why the apostle forbade an act which was not unusual among his own people, alleging as the reason—'I myself also am a man.' The answer is, that among the Romans, prostration was *exclusively* an act of adoration, rendered only to the gods, and therefore it had in him a significance which it would not have had in an Oriental (Kuinoel, *ad Act.* x. 26). This custom is still very general among the Orientals; but, as an act of reverence merely, it is seldom shown except to kings: as expressive of alarm or supplication, it is more frequent.

Sometimes in this posture, or with the knees

bent as before indicated, the Orientals bring their forehead to the ground, and before resuming an erect position either kiss the earth, or the feet, or border of the garment of the king or prince before whom they are allowed to appear. There



is no doubt that a similar practice existed among the Jews; especially when we refer to the original words which describe the acts and attitudes of salutation, as *נפל ארצה* to *bend down to the earth*, *השתחויה ארצה* to *fall prostrate on the earth*, *כרע אפים ארצה* to *fall with the face to the earth*, and connect them with allusions to the act of kissing the feet, or the hem of the garment (Matt. ix. 20; Luke vii. 38, 45). *Kissing the hand* of another as a mark of affectionate respect, we do not remember as distinctly mentioned in Scripture. But as the Jews had the other forms of Oriental salutation, we may conclude that they had this also, although it does not happen to have been specially noticed. It is observed by servants or pupils to masters, by the wife to her husband, and by children to their father, and sometimes their mother. It is also an act of homage paid to the aged by the young, or to learned and religious men by the less instructed or less devout. Kissing one's own hand is mentioned as early as the time of Job (xxxi. 27), as an act of homage to the heavenly bodies. It was properly a salutation, and as such an act of adoration to them. The Romans in like manner kissed their hands as they passed the temples or statues of their gods [ADORATION].



It appears from 1 Sam. x. 1; 1 Kings xix. 18; Ps. ii. 12, that there was a peculiar kiss of homage, the character of which is not indicated. It was probably that kiss upon the forehead expressive of high respect which was formerly, if not now, in use among the Bedouins (*Antar*, ii. 119).

BOWING.—In the Scriptures there are different words descriptive of various postures of respectful bowing; as *קדר* to *incline or bow down the head*, *כרע* to *bend down the body very low*, *ברך* to *bend the knee*, also to *bless*. These terms indicate a conformity with the existing usages of the East, in which the modes of bowing are equally diversified, and, in all likelihood, the same. These are—

2. placing the right hand upon the breast, with or without an inclination of the head or of the body;



1. touching the lips (is this the kissing of the hand noticed above?) and the forehead with the right hand, with or without an inclination of the head or of the body, and with or without previously touching the ground; 3. bending the body very low, with folded arms; 4. bending the body and resting the hands on the knees: this is one of the postures of prayer, and is indicative of the highest respect in the presence of kings and princes. In the Egyptian paintings we see persons drop their arms towards the ground while bowing to a superior, or standing respectfully with the right hand resting on the left shoulder.

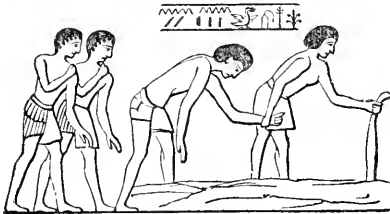

It is observable that, as before noticed, the word $\bar{\text{ב}}\bar{\text{ר}}\bar{\text{כ}}$, *barak*, means to *bless* and to *bend the knee*, which suggests the idea that it was usual for a person to receive a blessing in a kneeling posture. We know also that the person who gave the blessing laid his hands upon the head of the person blessed (Gen. xlviii. 14). This is exactly the case at the present day in the East, and a picture of the existing custom would furnish a perfect illustration of the patriarchal form of blessing. This may be perceived from the annexed engraving, which, with some of the other attitudes given in this article, is from Lane's *Translation of the Arabian Nights Entertainments*—a work which, in its notes and pictorial illustrations, affords a more complete picture of the persons, manners, and habits of the people of south-western Asia and of Egypt, than all the books of travels put together.



AVA ($\bar{\text{נ}}\bar{\text{ו}}\bar{\text{א}}$; Sept. 'Αἰά, 2 Kings xvii. 24), also IYAH ($\bar{\text{י}}\bar{\text{י}}\bar{\text{ח}}$; Sept. 'Αβᾶ, 2 Kings xviii. 34; xix. 13; Isa. xxxvii. 13), the capital of a small monarchical state conquered by the Assyrians, and

from which king Salmanser sent colonies into Samaria. Some take it for the river, or rather the town which gave name to the river Alava of Ezra viii. 21 (Bellermann, *Handbuch*, iii. 374). Iken (*Dissert. Philol. Theolog.* p. 152) would identify it with the Phœnician town Avatha, mentioned in the *Notitia Vet. Dignitatum Imper. Rom.* (but the reading here is rather doubtful: Reland, *Palæst.* p. 232, *sqq.*); or with the town of Abeje, between Beirut and Sidon, which Paul Lucas mentions as the seat of a Druse prince. But these are mere conjectures. Michaelis derives the name from

$\bar{\text{ع}}\bar{\text{و}}\bar{\text{ي}}$ or $\bar{\text{ع}}\bar{\text{و}}\bar{\text{ي}}$, *latrare*, and supposes it to be the land of the Avites between Tripoli and Beirut, because they are described as worshippers of $\bar{\text{נ}}\bar{\text{י}}\bar{\text{ב}}\bar{\text{ח}}$ *Nibhaz* (2 Kings xvii. 31), an idol which he compares with the great stone dog that formerly stood in that quarter, on which account the Lycus obtained its name of Nahr-el-Kelb, Dog-river (comp. Marten, vi. l. 380). It is most probable, however, that Ava was a Syrian or Mesopotamian town, of which no trace can now be found either in the ancient writers or in the Oriental topographers.

AVEN ($\bar{\text{א}}\bar{\text{ו}}\bar{\text{נ}}$; Sept. 'Αῆν), a plain, 'the plain of the sun,' of Damascene Syria (Amos i. 5). It is usually supposed to be the same as the plain of Baalbec, or valley of Baal, where there was a magnificent temple dedicated to the sun. Being between Lebanon and Anti-Lebanon, it is supposed by Rosenmüller and others to be the same plain or valley that is mentioned as 'the valley of Lebanon' in Josh. xi. 17. Some, however, influenced by the Septuagint, would rather seek Aven in the plain of Un, four leagues from Damascus towards the desert.

AUGUSTUS (*Venerable*), the title assumed by Octavius, who, after his adoption by Julius Cæsar, took the name of Octavianus (*i. e. Ec-Octavius*), according to the Roman fashion; and was the first peacefully acknowledged emperor of Rome. He was emperor at the birth and during half the life-time of our Lord; but his name has no connection with Scriptural events, and occurs only once (Luke ii. 1) in the New Testament. The successors of the first Augustus took the same name or title, but it is seldom applied to them by the Latin writers. In the eastern part of the empire the Greek $\bar{\text{Σ}}\bar{\text{ε}}\bar{\text{β}}\bar{\text{α}}\bar{\text{σ}}\bar{\text{τ}}\bar{\text{ῆ}}\bar{\text{ς}}$ (which is equivalent) seems to have been more common, and hence is used of Nero (Acts xxv. 21). In later times (after Diocletian) the title of Augustus was given to one of the two heirs-apparent of the empire, and Cæsar to their younger colleagues and heirs-apparent.

AVIM ($\bar{\text{א}}\bar{\text{ו}}\bar{\text{י}}\bar{\text{מ}}$; Sept. Εὐαίμι), called also AVITES and HIVITES, a people descended from Canaan (Gen. x. 17), who originally occupied the southernmost portion of that territory in Palestine along the Mediterranean coast, which the Caphtorim or Philistines afterwards possessed (Deut. ii. 23). As the territory of the Avim is mentioned in Josh. xiii. 3, in addition to the five Philistine states, it would appear that it was not included in theirs, and that the expulsion of the Avim was by a Philistine invasion prior to that by which the five principalities were founded. The territory began at Gaza, and extended southward to 'the river of Egypt' (Deut. ii. 23), forming what was the sole Philistine kingdom of Gerar in the time of Abraham, when we

do not bear of any other Philistine states. There were then Avim, or Hivites, at Shechem (Gen. xxxiv. 2), and we afterwards find them also at Gibeon (Josh. ix. 7), and beyond the Jordan, at the foot of Mount Hermon (Josh. xi. 3); but we have no means of knowing whether these were original settlements of the Avim, or were formed out of the fragments of the nation which the Philistines expelled from southern Palestine. The original country of the Avim is called Hazerim in Deut. ii. 23 [GERAR; PHILISTINES].

AURANITIS. [HAURAN.]

AWL (אֲוֵל; Sept. ἐπήτιον). The Hebrew word, which denotes an awl or other instrument for boring a small hole, occurs in Exod. xxi. 6; Deut. xv. 17. Considering that the Israelites had at that time recently withdrawn from their long sojourn in Egypt, there can be no doubt that the instruments were the same as those of that country, the forms of which, from actual specimens in the British Museum, are shown in the annexed cut. They are such as were used by the sandal-makers and other workers in leather.

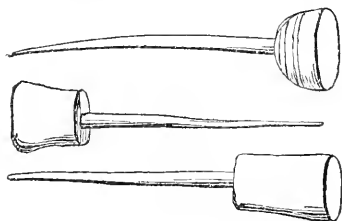

AXE. Several instruments of this description are so discriminated in Scripture as to show that the Hebrews had them of different forms and for various uses. 1. גַּרְזֵן *garzen*, which occurs in Deut. xix. 5; xx. 19; 1 Kings vi. 7; Isa. x. 15. From these

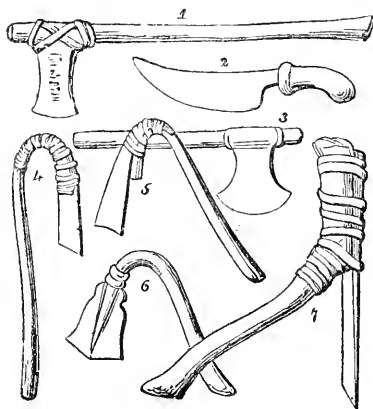

passages it appears that this kind was employed in felling trees, and in hewing large timber for building. The conjecture of Gesenius, that in 1 Kings v. 7, it denotes the axe of a stonemason is by no means conclusive. The first text supposes a case of the head slipping from the helve in felling a tree. This would suggest that it was shaped

like fig. 3, which is just the same instrument as our common hatchet, and appears to have been applied by the ancient Egyptians to the same general use as with us. The reader will observe the contrivance in all the others (wanting in this) of fastening the head to the haft by thongs. 2. מַעֲזָד *maatzad*, which occurs only in Isa. xlv. 12; and Jer. x. 3. From these passages it appears to have been a lighter implement than the former, or a kind of adze, used for fashioning or carving wood into shape; it was, probably, therefore, like figs. 4 to 7, which the Egyptians employed for this purpose. Some texts of Scripture represent them as being employed in carving images—the use to which the prophets refer. The differences of form and size, as indicated in the figures, appear to have been determined with reference to light or heavy work: fig. 3 is a finer carving-tool. 3. גַּרְדֹּם *gardom*; this is the commonest name for an axe or hatchet. It is this of which we read in Judg. ix. 48; Ps. lxxiv. 5; 1 Sam. xiii. 20, 21; Jer. xlv. 22. It appears to have been more exclusively employed than the *garzen* for felling trees, and had therefore probably a heavier head. In one of the Egyptian sculptures the inhabitants of Lebanon are represented as felling pine-trees with axes like fig. 1. As the one used by the Egyptians for the same purpose was also of this shape, there is little doubt that it was also in use among the Hebrews.

The word rendered 'axe' in 2 Kings vi. 5 is literally 'iron'; but as an axe is certainly intended, the passage is valuable as showing that the axe-heads among the Hebrews were of iron. Those which have been found in Egypt are of bronze, which was very anciently and generally used for the purpose. But this does not prove that they had none of iron; it seems rather to suggest that those of iron have been consumed by the corrosion of three thousand years, while those of bronze have been preserved. All our figures are from actual specimens now in the British Museum.

AZANIAH (אֲזַנְיָהּ; Sept. Ἀζανίαιος, Vulg. *halyetus* and *haliactos*, Auth. Vers. 'ospray'), an unclean bird; but there is a difference of opinion as to the particular species intended. The etymology of the Hebrew word would seem to point to some bird remarkably *powerful, fierce, or impudent*. Bochart supposes the *black eagle* to be meant, but reasons upon the *mere conjecture* that by the word *μελαναίετος* is intended *ἀλαιοίετος* (*Hieroz.* tom. iii. p. 188, &c.).

The *traditional meaning* strongly favours the English rendering. The following is the line through which it is traced:—The modern systems of ornithology for the most part retain the *names of birds* given to them by Linnæus in his *Systema Naturæ*. 'The system of Willughby is without doubt the basis on which the ornithological classification of Linnæus is founded' (Neville Wood's *Ornithologist's Textbook*, p. 3). Mr. Ray, giving an account of the assistance he rendered Mr. Willughby in that undertaking, says, 'Concerning the *names of birds* we did not much trouble ourselves, but have for the most part followed Gesner and Aldrovandus, being unwilling to disturb what is settled, or dispossess names that may, for their use, plead prescription' (Preface to the Eng. ed. of Willughby's *Ornithology*); and it is well known that Gesner and Aldrovandus derived their names and describ

tions of birds from their predecessors, including Aristotle and Pliny. In the same preface, Mr. Ray observes, 'Gesner and Aldrovandus wrote mere pandects of birds, comprising *whatever had before been written by others.*' This continuation



[Osprey. Falco Haliaetus.]

of the same names of many at least of the same birds, from Aristotle to the present day, is, in the instance of the haliaetus, or osprey, peculiarly clear and unbroken; and the same striking *descriptions* also of the bird so designated accompany its name from the earliest times.

The following statement places the matter in a clear light:—Aristotle, about B.C. 300, describes the *άλιαίετος* as 'a species of eagle dwelling near seas and lakes; and remarks, it sometimes happens to it, that having seized its prey, and not being able to carry it, it is drowned in the deep' (*Hist. Animal.* ix. c. 32). The word is rendered alietus in the ancient translation, aquila marina and haliaetus by Gaza (Ven. A.D. 1476), and aquila marina, nisus haliaetus, and haliaetus by Scaliger. About the time of Aristotle, the ablest of all the Septuagint translators renders the Hebrew word azaniah by *άλιαίετος*. The same word is found in the writings of Pliny (A.D. 70) with the following description, 'There remains (to be mentioned) the haliaetus, having the most penetrating vision of all (eagles); soaring (or balancing itself) on high, and upon perceiving a fish in the sea, rushing down headlong, and with its breast dashing aside the waters, seizing its prey' (*Hist. Nat.* x. 3). The same word is adopted by Jerome as answering to the Hebrew azaniah, A.D. 380, and the haliaetus is described in the very words of Aristotle and Pliny by Aldrovandus (lib. xii. Bonon. 1594, p. 194); the transference of names into the Linnæan system has already been traced (see *Systema Naturæ*, vol. i. p. 129, Holmiæ, 1767). The word, according to its etymology, signifies sea-eagle, and the traditional English word is osprey. The following accounts from modern naturalists are strikingly in accordance with the ancient descriptions:—

Species of the haliaetus, or sea-eagle, occur in

Europe, Asia, Africa, America, and Australia (Selby's *British Ornithology*).

Mr. Macgillivray describes 'its savage scream of anger when any one approaches the neighbourhood of its nest, its intimidating gestures, and even its attempts to molest individuals who have ventured among its native erags.'

Mr. Selby (*Illustrations of British Ornithology*, 1825) respecting the osprey, observes, 'It is strictly piscivorous, and is found only in the vicinity of lakes, rivers, or such pools as abound with fish. It is a powerful bird, often weighing five pounds; the limbs are very muscular in proportion to its general dimensions; its feet are admirably adapted for retaining firm hold of its slippery prey.' Mr. Montagu (*Ornithological Dictionary*, 1802, article 'Osprey') remarks, 'Its principal food is fish, which it often catches with great dexterity, by pouncing upon them with vast rapidity, and carrying them off in its talons.' In the supplement to his work, Exeter, 1813, many additional facts are related respecting the osprey, which, together with the foregoing reasons, serve to identify it with the haliaetus of the ancients (see also Grandsagne's edition of Pliny, with Notes and Excursus by Cuvier, Parisii, 1828, p. 215).—J. F. D.

AZARIAH (אֶזַרְיָה, whom Jehovah aids, answering to the German name *Gotthelf*; Sept. Ἀζαρίας), a very common name among the Hebrews, and hence borne by a considerable number of persons mentioned in Scripture.

1. AZARIAH, a high-priest (1 Chron. vi. 9), perhaps the same with Amariah, who lived under Jehoshaphat king of Judah (2 Chron. xix. 11), about B.C. 896.

2. AZARIAH, son of Johanan, a high-priest (1 Chron. vi. 10), whom some suppose the same as Zechariah, son of Jehoiada, who was killed B.C. 840 (2 Chron. xxiv. 20-22).

3. AZARIAH, the high-priest who opposed king Uzziah in offering incense to Jehovah (2 Chron. xxvi. 17).

4. AZARIAH, a high-priest in the time of Hezekiah (2 Chron. xxxi. 10).

5. AZARIAH, the father of Seraiah, who was the last high-priest before the Captivity (1 Chron. vi. 14).

6. AZARIAH, son of the high-priest Zadok; but it is uncertain if he succeeded his father (1 Kings iv. 2).

7. AZARIAH, captain of king Solomon's guards (1 Kings iv. 5).

8. AZARIAH, otherwise called Uzziah, king of Judah [UZZIAH].

9. AZARIAH, a prophet who met king Asa on his return from a great victory over the Cushite king Zerah (2 Chron. xxxiii. 1) [ASA].

10. AZARIAH, a person to whom the high-priest Jehoiada made known the secret of the existence of the young prince Joash, and who assisted in placing him on the throne (2 Chron. xv. 1).

11. AZARIAH, one of the two sons of king Jehoshaphat (2 Chron. xxi. 2).

12. AZARIAH, one of the 'proud men' who rebuked Jeremiah for advising the people that remained in Palestine, after the expatriation to Babylon, not to retire into Egypt; and who took the prophet himself and Baruch along with them to that country (Jer. xliii. 2-7).

13. AZARIAH, the Chaldean name of Abednego, one of Daniel's three friends who were cast into the fiery furnace (Dan. i. 7; iii. 9).

AZZAH (אָזָא), a mode of spelling the Hebrew name which is elsewhere rendered Gaza. The difference arises from the uncertain power of the first letter ז, which, in proper names, some use as the consonant G; while others regard only the vowel sound connected with it, which in this case is A [ALPHABET]. The name occurs in this form in Deut. ii. 23; Jer. xxv. 20; which last clearly shows that Gaza is intended.

B.

BA'AL. The word בַּעַל *ba'al*, as it signifies *lord, master*, is a generic term for *god* in many of the Syro-Arabian languages. As the idolatrous nations of that race had several gods, this word, by means of some accessory distinction, became applicable as a name to many different deities. There is no evidence, however, that the Israelites ever called Jehovah by the name of Baal; for the passage in IIos. ii. 16, which has been cited as such, only contains the word *baal* as the sterner, less affectionate representative of *husband*.

1. BAAL (בַּעַל), with the definite article, Judg. ii. 13; Sept. δ Βάαλ, but also ἡ Βάαλ, Jer. xix. 5; xxxix. 35; Rom. xi. 4) is appropriated to the chief male divinity of the Phœnicians, the principal seat of whose worship was at Tyre. The idolatrous Israelites adopted the worship of this god (almost always in conjunction with that of Ashtoreth) in the period of the Judges (Judg. ii. 13); they continued it in the reigns of Ahaz and Manasseh, kings of Judah (2 Chron. xxviii. 2; 2 Kings xxi. 3); and, among the kings of Israel, especially in the reign of Ahab, who, partly through the influence of his wife, the daughter of the Sidonian king Ethbaal, appears to have made a systematic attempt to suppress the worship of God altogether, and to substitute that of Baal in its stead (1 Kings xvi. 31); and in that of Hoshea (2 Kings xvii. 16), although Jehu and Jehoiada once severally destroyed the temples and priesthood of the idol (2 Kings x. 18, *sq.*; xi. 18).

We read of altars, images, and temples erected to Baal (1 Kings xvi. 32; 2 Kings iii. 2). The altars were generally on heights, as the summits of hills or the roofs of houses (Jer. xix. 5; xxxii. 29). His priesthood, the proper term for which seems to be כַּמְרִיִּים, were a very numerous body (1 Kings xviii. 19), and were divided into the two classes of prophets and of priests (unless the term 'servants,' which comes between those words, may denote a third order—a kind of Levites; 2 Kings x. 19). As to the rites by which he was worshipped, there is most frequent mention of incense being offered to him (2 Kings xxiii. 5), but also of bullocks being sacrificed (1 Kings xviii. 26), and even of children, as to Moloch (Jer. xix. 5). According to the description in 1 Kings xviii., the priests, during the sacrifice, danced (or, in the sarcastic expression of the original, *limped*) about the altar, and, when their prayers were not answered, cut themselves with knives until the blood flowed, like the priests of Bellona (Lucan. *Pharsal.* i. 565; Tertull.

Apologet. ix.; Lactant. *Div. Instit.* i. 21). We also read of homage paid to him by bowing the knee, and by kissing his image (1 Kings xix. 18; comp. Cicero, *In Verrem*, iv. 43), and that his worshippers used to swear by his name (Jer. xii. 16).

As to the power of nature which was adored under the form of the Tyrian Baal, many of the passages above cited show evidently that it was one of the heavenly bodies; or, if we admit that resemblance between the Babylonian and Persian religions which Münter assumes, not one of the heavenly bodies really, but the *astral spirit* residing in one of them; and the same line of induction as that which is pursued in the case of Ashtoreth, his female counterpart, leads to the conclusion that it was the *sun*. Nevertheless, the same difference of opinion between Gesenius and Münter as that on the subject of Ashtoreth meets us here in the case of Baal, and of the Babylonian Bel, which we shall, in what follows, regard as being essentially the same god. The former—who has stated his arguments in his *Thesaurus*, in his *Jesais*, and at some length in the *Allgemeine Encyclopædie*, vols. viii. & xvi.—maintains that the idolatry of Babylon was astrological, and that, from the connection between Aramæan and Phœnician religious ideas, Baal and Bel were representatives of the *planet Jupiter*, as the greater star of good fortune. He builds much on the facts, that the Arabian idolaters worshipped this planet under the name of Mushter, and sacrificed a sucking-child to him on a Thursday (*dies Jovis*), and that his temple was pyramidal (see Norberg's *Onomast. Cod. Nas.* p. 28); that Bel is also the name of this planet in the Tsabian books; and that the Romans called the Babylonian Bel by the name of Jupiter. He asserts that the words 'to Baal, to the sun,' in 2 Kings xxiii. 5, so far from proving the identity of Baal and the sun, rather directly oppose it; and, as it is impossible to deny that the sun was worshipped by the Phœnicians, he evades the force of the passage from Sanchoniathon, cited below, by arguing that, even allowing that the sun was the chief Tyrian god according to the entire religious system, it does not follow that he was necessarily the Baal *κατ' ἔφοχόν*, the most worshipped god of Tyre or Babylon: just as, in the middle ages, the excessive worship of patron saints and of the Virgin Mary was compatible with a theoretical acknowledgment of the Supreme Being.

Münter, on the other hand, in his *Religion der Babylonier*, does not deny the astrological character of the Babylonian religion, but maintains that, together with and besides that, there existed in very early times a cosmogonical idea of the *primitive power of nature*, as seen in the two functions of *generation* and of *conception* or *parturition*; that this idea is most evident in the Kabiric religion, but that it exists all over the East; and that the sun and moon were the fittest representatives of these two powers. He does not admit that the Tsabian books, or Efraem Syrus, are any authority for the religious notions of the Babylonians at a period so remote from their own time, and especially when they are opposed by better and older testimonies. Among these, he relies much on the statement of Sanchoniathon (p. 14, ed. Orelli), that the Phœnicians considered

the sun to be 'μόνος ὄρανον κύριος,' calling him 'Beelsamen, which is the Zeus of the Greeks.'

Balsamen (*i. e.* בעל שמים *lord of the heavens*) also occurs in Plautus (*Pœnul.* act. v. s. 2. 67), where Bellermann, Lindemann, and Gesenius recognise it to be the same name. Isidorus Hispalensis has the words, 'Apud Assyrios Bel vocatur, quodam sacrorum suorum ratione, et Saturnus et Sol' (*Orig.* viii. 11). We moreover find בעל המן (*i. e.* *deus solaris*, from הכמה, the sun, Job xxx. 28, with the adjective ending *ân*; see Ewald's *Hebr. Gram.* § 341) in several Carthaginian inscriptions (in Gesen. *Mon. Ling. Phœn.* p. 164), which is an evidence that the Carthaginians worshipped the sun.

As to Gesenius's assertion that 2 Kings xxiii. 5 is opposed to the identity of Baal and the sun, a consideration of the whole passage would seem to show he has judged hastily. The words are, 'which burnt incense to Baal, to the sun, and to the moon, and to the zodiacal signs, and to all the host of the heavens.' Now the omission of the *and* before the sun appears decidedly to favour the notion that the sun is an apposition to Baal, and not a distinct member of the same co-ordinate series. This view might, perhaps, recommend itself to those who appreciate the peculiar use of *and* in the Hebrew syntax. Besides, *solar images* (as he himself interprets חמנים) are mentioned in 2 Chron. xxxiv. 4, as being placed on the altars of the Baals; which is not well reconcilable with any other theory than that of the identity of Baal and the sun.

In a certain sense, every argument which goes to show that Ashtoreth was the moon is also, on account of the close conjunction between her and Baal, as valid a reason for Baal being the sun; for the two gods are such exact correlates, that the discovery of the true meaning of the one would lead, by the force of analogy, to that of the other. Nevertheless, as has been already observed in the article ASHTORETH, it must be admitted that the astrological view did subsequently prevail, and that the planets Jupiter and Venus became mysteriously connected with some modifications of the same powers which were primarily worshipped under the cosmogonical ideas of Bel and Mylitta, sun and moon. This relation between Baal and the planet Jupiter is noticed in the article GAD. For the relation between Baal and Moloch, and that between Baal and Melkarth, the Tyrian Hercules, see MOLOCH and HERCULES.

2. BAAL BERTH (בעל ברית, *covenant-lord*; Sept. Vat. Βααλβερθ; Alexand. Βάαλ διαθήκης; Judg. ix. 4) is the name of a god worshipped by the people of Shechem (Judg. viii. 33; ix. 4, 46), who, on account of the signification of the name, has been compared to the Ζεὺς Ὀρκίος of the Greeks, and the Latin *Deus Fidius*. Bochart and Creuzer think that this name means 'God of Berytus;' but, as the name of that town is probably to be recognised in ברותה of Ezek. xlvi. 16, there is hardly any ground for their opinion.

3. BAAL PEOR (בעל פעור, or sometimes only פעור, respectively represented in the Sept. by Βααλφεωρ, and Φωγώρ) appears to have been properly the idol of the Moabites (Num. xxv. 1-9; Deut. iv. 3; Jos. xxii. 17; Ps. cvi. 28;

IIos. ix. 10); but also of the Midianites (Num. xxxi. 15, 16).

It is the common opinion that this god was worshipped by obscene rites; and, from the time of Jerome downwards, it has been usual to compare him to Priapus. Selden and J. Owen (*De Diis Syris*, i. 5; *Theologoumena*, v. 4) seem to be the only persons who have disputed whether any of the passages in which this god is named really warrant such a conclusion. The utmost that those passages express is the fact that the Israelites received this idolatry from the women of Moab, and were led away to eat of their sacrifices (cf. Ps. cvi. 28); but it is very possible for that sex to have been the means of seducing them into the adoption of their worship, without the idolatry itself being of an obscene kind. It is also remarkable that so few authors are agreed even as to the general character of these rites. Most Jewish authorities (except the Targum of Jonathan on Num. xxv.) represent his worship to have consisted of rites which are filthy in the extreme, but not lascivious (see Braunius, *De Vestit. Sacerd.* i. p. 7, for one of the fullest collections of Jewish testimonies on this subject). If, however, it could be shown that this god was worshipped by libidinous rites, it would be one more confirmation of the relation between Baal and the sun; as, then, Baal Peor would be a masculine phasis of the same worship as that of which Mylitta is, both in name and rites, the female representative. The sense assigned by the Rabbins to the verb פער is now generally considered untenable. Peor (*hiatus*) is supposed to have been the original name of the mountain; and Baal Peor to be the designation of the god worshipped there. The verb נצמך, *to be bound, coupled*, which is only used in the Old Testament to denote being joined to Baal Peor, has been supposed to express either some obscene rite, or some mere symbol of initiation in the worship of this god. The Sept. renders it by ἐρελεύθησαν; and J. D. Michaelis first tried to reconcile the primitive sense of *binding* with the notion of initiation, by taking it to mean binding-on *fillets*. Gesenius, however, points to the same verb in Ethiopic, in the sense of *to serve, to worship*; and maintains that that is its force here. Nevertheless, Hitzig, in his note to IIos. ix. 10, still tries to show that the verb may mean *to wear a band*, as symbol of initiation; and argues that ינרו, there used, as contrasted with the appropriate word יצמך, implies the correspondence between the נור and the צמך (cf. 2 Sam. i. 10). Some identify this god with CHEMOSH.

4. BAALZEBUB (בעל זבוב, *Fly-lord*; Sept. τῷ Βάαλ μύτιαν θεόν, always; where more than one emendation appears necessary) occurs in 2 Kings i. 2-16, as the god of the Philistines at Ekron, whose oracle Ahaziah sent to consult. There is much diversity of opinion as to the signification of this name, according as authors consider the title to be one of honour, as used by his worshippers, or one of contempt. The former class find a parallel to him in the Ζεὺς Ἀπόμιος of Elis, and suppose that he was regarded as the god who delivered his worshippers from the annoyance of flies. We are unable, however, to discern the appositeness of this parallel. The name *Fly-lord* appears rather to mean the god

of flies, than the averter and destroyer of flies. As this name is the one used by Ahaziah himself, it is difficult to suppose that it was not the proper and reverential title of the god: and the more so, as Beelzebub, in Matt. x. 25, seems to be the contemptuous corruption of it. Any explanation, therefore, of the symbolical sense in which flies may have been regarded in ancient religions, and by which we could conceive how his worshippers could honour him as the *god of flies*, would appear to us much more compatible with his name than the only sense which can be derived from the Greek parallel. This receives some confirmation, perhaps, from the words of Josephus (*Antiq.* ix. 2), who says, 'Ahaziah sent to the god *Fly*, for that is the name of the god' (τῷ θεῷ ἄεθ).

The analogy of classical idolatry would lead us to conclude that all these Baals are only the same god under various modifications of attributes and emblems; but the scanty notices to which we owe all our knowledge of Syro-Arabian idolatry do not furnish data for any decided opinion on this subject.—J. N.

BAAL is often found as the first element of compound names of places. In this case, Gesenius thinks that it seldom, if ever, has any reference to the god of that name; but that it denotes the place which *possesses*, which is the *abode* of the thing signified by the latter half of the compound—as if it was a synonyme of בית. The best support of this opinion is the fact that *baal* and *beth* are used interchangeably of the same place; as Baalshalisha and Baaltamar are called by Eusebius Bethshalisha and Bethtamar.

J. N.

BAALAH, BAALE-JUDAH, KIRJATH-BAAL [KIRJATH JEARIM].

BAALAH (בַּעַלְהָ, Josh. xv. 29), BALAH (בְּלַח, Josh. xix. 3), BILHAH (בְּלִיָּהָ, 1 Chron. iv. 29), a town in the tribe of Simeon, usually confounded with Baalath; but, as the latter was in Dan and this in Simeon, they would appear to have been distinct.

BAALATH-BEER (בַּעַלְתַּיִן; Sept. Γεβεελάν), a town in the tribe of Dan (Josh. xix. 44), apparently the same that was afterwards rebuilt by Solomon (1 Kings ix. 18). Many have conjectured this Baalath to be the same as Baalbek; but in that case it must have lain in northernmost Dan, whereas the possession of it is ascribed to that tribe when its territory was wholly in the south of Judah, and many years before the migration (recorded in Judg. xviii.) which gave Dan a northern territory. Correspondingly, Josephus places the Baalath of Solomon (which he calls *Baleth*) in the southern part of Palestine, near to Gazara (*Antiq.* viii. 2), within the territory which would have belonged to Dan, had it acquired possession of the lands originally assigned to it. The Talmud affirms that Baalath lay so near the line of separation between Dan and Judah, that the fields only were in the former tribe, the buildings being in the latter.

BAALATH-BEER (בַּעַלְתַּיִן; Sept. Βαλέκ), probably the same as the Baal of 1 Chron. iv. 33—a city of Simeon; called also Ramath-Negeb, or Southern Ramath (Josh. xix. 8; comp. 1 Sam. xxx. 27).

BAAL-GAD (בַּעַל גַּד; Sept. Βαλαγάδ), a city 'in the valley of Lebanon under Mount Hermon' (Josh. xi. 17; xii. 7). We are also informed that among those parts of Palestine which were unsubdued by the Hebrews at the death of Joshua, was 'all Lebanon towards the sun-rising, from Baal-gad, under Mount Hermon, unto the entering into Hamath' (Josh. xiii. 5). This position of Baal-gad is not unfavourable to the conclusion which some have reached, that it is no other than the place which, from a temple consecrated to the sun, that stood there, was called by the Greeks *Heliopolis*, i. e. city of the sun; and which the natives called and still call Baalbek, a word apparently of the same meaning. The honour of being identified with Baalbek has also been claimed for the Baalath which Solomon built or fortified: but this claim has already been disposed of [BAALATH]; and no weight is to be attached to the local traditions which claim Solomon as the founder of Baalbek, seeing that it is the practice of the natives to ascribe to that great king every grand ancient work of unknown date which the country contains. It is also to be observed that those who contend for Baalath admit its possible identity with Baal-gad, and hence there are no conflicting claims to adjust. Even those who suppose the Baal-hamon of the Canticles (viii. 11) to be Baalbek, conceive that to be a later name for Baal-gad; and hence the only question that remains is, whether Baal-gad be not the more ancient name of the place afterwards known as Heliopolis and Baalbek.

Baalbek, in the Syrian language, signifies *the city of Baal*, or of the sun; and, as the Syrians never borrowed names from the Greeks, or translated Greek names, it is certain that when the Greeks came into Syria they found the place bearing this name or some other signifying 'city of the sun,' since they termed it Heliopolis, which is doubtless a translation of the native designation. We entertain no doubt that it was then called Baalbek by the natives. Now the question is, whether this word has the same meaning as Baal-gad, and if not, whether any circumstances can be pointed out as likely to occasion the change of name. If we take Baal for the name of the idol, then, as in the case of Baalbek, the last member of the word must be taken as a modifying appellation, not as in itself a proper name; and as Gad means *a troop, a multitude, or a press of people*, Baal-gad will mean *Baal's crowd*, whether applied to the inhabitants, or to the place as a resort of pilgrims. The syllable *bek* has precisely the same meaning in the Arabic.

If this should not seem satisfactory, we may conclude that *Baal* was so common an element in the composition of proper names, that it is not sufficiently distinctive to bear the stress of such an interpretation; and may rather take it to signify (as Gesenius says it always does in geographical combinations) the place where a thing is found. According to this view Baal-gad would mean *the place of Gad*. Now Gad was an idol (Isa. lxxv. 11), supposed to have been 'the god or goddess of good fortune (comp. Sept. Τύχη; Vulg. *Fortuna*), and identified by the Jewish commentators with the planet *Jupiter*.

[GAD]. But it is well known that Baal was identified with Jupiter as well as with the sun; and it is not difficult to connect Baalbek with the worship of Jupiter. John of Antioch affirms that the great temple at Baalbek was dedicated to Jupiter; and in the celebrated passage of Macrobius (*Saturnal.* i. 23), in which he reports that the worship of the sun was brought by Egyptian priests to Heliopolis in Syria, he expressly states that they introduced it under the name of Jupiter (sub nomine *Jovis*). This implies that the worship of Jupiter was already established and popular at the place, and that heliolatry previously was not; and therefore we should rather expect the town to have borne some name referring to Jupiter than to the sun; and may be sure that a name indicative of heliolatry must have been posterior to the introduction of that worship by the Egyptians; and, as we have no ground for supposing that this took place before or till long after the age of Joshua, it could not

then be called by any name corresponding to Heliopolis.

We have touched upon this matter because it presents the subject in its Biblical relations, which receive comparatively little attention in works of general reference. To such works, as well as to the travels named at the end of this article, we may refer for ample descriptions of the ruins, &c., which require but slight notice here, seeing that it is barely probable that the site is even named in the Scriptures.

Baalbek is pleasantly situated on the lowest declivity of Anti-Libanus, at the opening of a small valley into the plain El-Bekaa. Through this valley runs a small stream, divided into numberless rills for irrigation. The place is in N. lat. $34^{\circ} 1' 30''$, and E. long. $36^{\circ} 11'$, distant 109 geog. miles from Palmyra, and $38\frac{3}{4}$ from Tripoli.

Its origin appears to be lost in the most remote antiquity, and the historical notices of it are

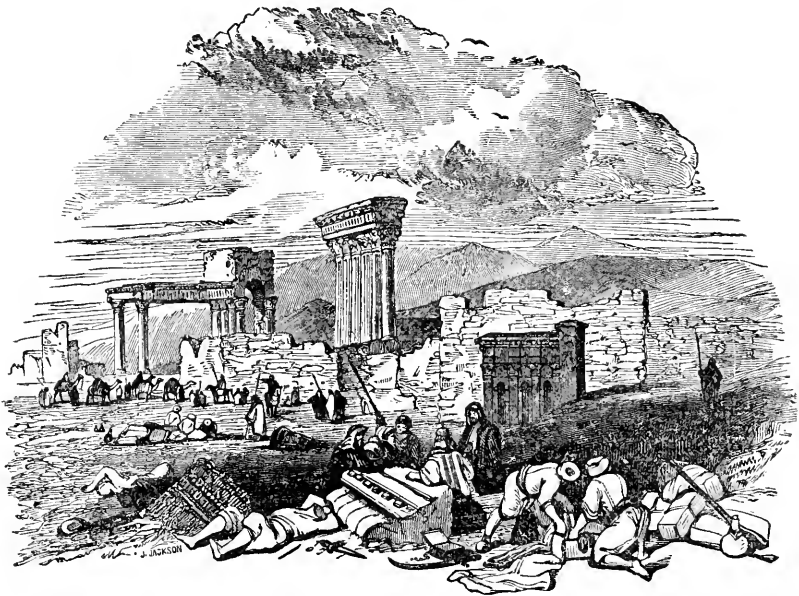

very scanty; the silence of the classical writers respecting it would alone seem to imply that it had previously existed under another name. In the absence of more positive information we can only conjecture that its situation on the high-road of commerce between Tyre, Palmyra, and the farther East, must have contributed largely to the wealth and magnificence which it manifestly attained. It is mentioned under the name of Heliopolis by Josephus (*Antiq.* xiv. 3. 4), and also by Pliny (*Hist. Nat.* v. 22). Two Roman inscriptions of the time of Antoninus Pius give sanction to the statement of John of Antioch, who alleges that this emperor built a great temple to Jupiter at Heliopolis, which was one of the wonders of the world (*Hist. Chron.* lib. xi.). From the reverses of Roman coins we learn that Heliopolis was constituted a colony by Julius Cæsar; that it was the seat of a Roman garrison in the

time of Augustus; and obtained the *Jus Italicum* from Severus. Some of the coins of later date contain curious representations of the temple.

After the age of Constantine the splendid temples of Baalbek were probably consigned to neglect and decay, unless indeed, as some appearances indicate, they were then consecrated to Christian worship. From the accounts of Oriental writers Baalbek seems to have continued a place of importance down to the time of the Moslem invasion of Syria. They describe it as one of the most splendid of Syrian cities, enriched with stately palaces, adorned with monuments of ancient times, and abounding with trees, fountains, and whatever contributes to luxurious enjoyment. On the advance of the Moslems, it was reported to the emperor Heraclius as protected by a citadel of great strength, and well able to sustain a siege. After the capture of Damascus it was regularly

invested by the Moslems, and—containing an overflowing population, amply supplied with provisions and military stores—it made a courageous defence, but at length capitulated. Its importance at that period is attested by the ransom exacted by the conquerors, consisting of 2000 ounces of gold, 4000 ounces of silver, 2000 silk vests, and 1000 swords, together with the arms of the garrison. It afterwards became the mart for the rich pillage of Syria: but its prosperity soon received a fatal blow from the khalif of Damascus, by whom it was sacked and dismantled, and the principal inhabitants put to the sword (A.D. 748). During the Crusades, being incapable of making any resistance, it seems to have quietly submitted to the strongest. In the year 1400 it was pillaged by Timour Beg, in his progress to Damascus, after he had taken Aleppo. Afterwards it fell into the hands of the Metaweli—a barbarous predatory tribe, who were nearly exterminated when Djezzar Pasha permanently subjected the whole district to Turkish supremacy.

The ruins of Heliopolis lie on an eastern branch

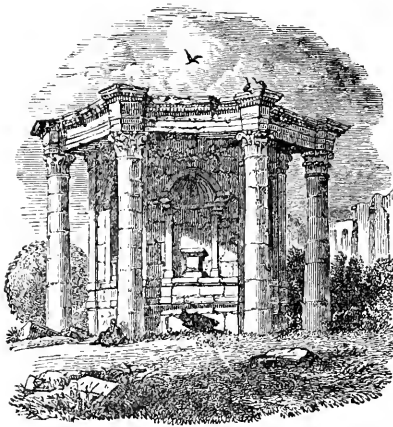

of the mountain, and are called, by way of eminence, the Castle. The most prominent objects visible from the plain are a lofty portico of six columns, part of the great temple, and the walls and columns of another smaller temple a little below, surrounded by green trees. There is also a singular and unique circular temple, if it may be so called, of which we give a figure. These, with a curious column on the highest point within the walls (which may possibly have been a clepsydra, or water-dial), form the only erect portions of the ruins. These ruins have been so often and so minutely described by scores of travellers, as well as in many works of general reference, that, since their identification as a Scriptural site is uncertain, a few additional observations only may suffice. The ruins at Baalbek in the mass are apparently of three successive eras: first, the gigantic hewn stones, in the face of the platform or basement on which the temple stands, and which appear to be remains of older buildings, perhaps of the more ancient temple which occupied the site. Among these are at least twenty standing upon a basement of rough stones, which would be called enormous anywhere but here. These celebrated

blocks, which in fact form the great wonder of the place, vary from 30 to 40 feet in length; but there are three, forming an upper course 20 feet from the ground, which together measure 190 feet, being severally of the enormous dimensions of 63 and 64 feet in length, by 12 in breadth and thickness (Addison's *Damascus and Palmyra*, ii. 55). 'They are,' says Richter (*Wallfahrten*, p. 281), 'the largest stones I have ever seen, and might of themselves have easily given rise to the popular opinion that Baalbek was built by angels at the command of Solomon. The whole wall, indeed, is composed of immense stones, and its resemblance to the remains of the Temple of Solomon, which are still shown on the foundations of the mosque Es-Sakkara on Mount Moriah, cannot fail to be observed.' This was also pointed out by Dr. Richardson. In the neighbouring quarries, from which they were cut, one stone, hewn out but not carried away, is of much larger dimensions than any of those which have been mentioned. To the second and third eras belong the Roman temples, which, being of and about the time of Antoninus Pius, present some of the finest specimens of Corinthian architecture in existence, and possess a wonderful grandeur and majesty from their lofty and imposing situation (Addison, ii. 57).

Among the ornaments of these buildings Richter finds confirmation of the following statement of Macrobius—'Isis and Horus often unequivocally appear. The winged globes surrounded with serpents show that the priests of Baalbek received their ideas of divinity from On, the Heliopolis of Egypt.' Speaking generally of these remains, Burckhardt says, 'The entire view of the ruins of Palmyra, when seen at a certain distance, is infinitely more striking than those of Baalbek, but there is not any one spot in the ruins of Tadmor so imposing as the interior view of the temple of Baalbek' (*Syria*, p. 13). He adds that the architecture of Baalbek is richer than that of Tadmor. Mr. Addison remarks that 'the ruins, though so striking and magnificent, are yet, however, quite second-rate when compared with the Athenian ruins, and display in their decoration none of the bold conceptions and the genius which characterize the Athenian architecture.'

The present Baalbek is a small village to the east of the ruins, in a sad state of wretchedness and decay. It is little more than a heap of rubbish, the houses being built of mud and sun-dried bricks. The population of 5000, which the place is said to have contained in 1751, is now reduced to barely 2000 persons; the two handsome mosques and fine serai of the Emir, mentioned by Burckhardt, are no longer distinguishable; and travellers may now inquire in vain for the grapes, the pomegranates, and the fruits which were formerly so abundant (Iken. *Dissert. de Baal-Hamon et Baal-Gad*, in *Dissert. Philologico-Theolog.* tom. i. p. 136; Wood and Dawkins, *Ruins of Baalbec*, Lond. 1757; Pococke, *Description of the East*; Maundrell, *Journey from Aleppo to Damascus*; the *Travels of Volney*, Burckhardt, Richardson, Hogg, Addison, Lord Lindsay; Richter, *Wallfahrten ein Morgenlande*; Schubert, *Reise in das Morgenland*, Erlangen, 1841; see also Rosenmüller, *Biblical Geography*, ii. pp. 252-257).

BAAL-GUR, or GUR-BAAL. We read in 2 Chron. xxvi. 7, that 'the Lord assisted Uz-

ziah against the Philistines, and (ועלה הערביים) ועלה against the Arabians that dwelt in Gur-Baal.' The Septuagint renders this by *καὶ ἐπὶ τοὺς Ἀραβας τοὺς κατοικοῦντας ἐπὶ τῆς Πέτρας*—'and the Arabians that dwelt above Petra.' It was doubtless some town of Arabia-Petra.

BAAL-HAMON (בעל המון; Sept. Βεελ-αμών), a place where Solomon is said to have had a vineyard (Cant. viii. 11). Rosenmüller conceives that if this Baal-Hamon was the name of a place that actually existed, it may be reasonably supposed identical with Baal-Gad or Heliopolis; for Hamon may have been a corruption of Amon, the Hebrew way of pronouncing the Ammon of the Egyptians (see Nah. iii. 8), whom the Greeks identified with Jupiter (*Bib. Geog.* ii. p. 253). We are not inclined to lay much stress on this conjecture. There was a place called Hamon, in the tribe of Asher (Josh. xix. 28), which Ewald thinks was the same as Baal-Hamon. The book of Judith (viii. 3) places a Balamon (Βαλαμών) or Belamon (Βελαμών) in central Palestine, which suggests another alternative.

BAAL-HAZOR (בעל הזור; Sept. Βελαζώρ), the place where Absalom kept his flocks, and held his sheep-shearing feast (2 Sam. xiii. 23). The Targum makes it 'the plain of Hazor.' It is said to have been 'beside Ephraim,' not in the tribe of that name, but near the city called Ephraim which was in the tribe of Judah, and is mentioned in 2 Chron. xiii. 19; John xi. 54. This Ephraim is placed by Eusebius eight miles from Jerusalem on the road to Jericho; and is supposed by Reland to have been between Bethel and Jericho (*Palestina*, i. 377).

BAAL-HERMON (בעל הרמון). The Septuagint makes two names of this in 1 Chron. v. 23, Βαλᾶ, Ἐρμών; and in Judg. iii. 3, where the original has 'Mount Baal-Hermon,' it has ἕρους τοῦ Ἀερμών, Mount Hermon. It seems to have been a place in or near Mount Hermon, and not far from Baal-gad, if it was not, as some suppose, the same place.

BAAL-MEON (בעל מעון; Sept. Βεελαμών; Num. xxxii. 38; 1 Chron. v. 8; otherwise BETH-MEON, Jer. xlviii. 23, and BETH-BAAL-MEON, Josh. xiii. 17), a town in the tribe of Reuben beyond the Jordan, but which was in the possession of the Moabites in the time of Ezekiel (xxv. 9). At the distance of two miles south-east of Heshbon, Burckhardt found the ruins of a place called *Mgoun*, or (as Dr. Robinson corrects it) *Mā'in*, which is doubtless the same, although Eusebius makes the distance greater.

BAAL-PERAZIM (בעל פְּרָצִים; Sept. Βαλ φαρασίμ). This name, meaning 'place of breaches,' which David imposed upon a place in or near the valley of Rephaim, where he defeated the Philistines (2 Sam. v. 20; comp. 1 Chron. xiv. 11; Isa. xxviii. 21), is important as being the only one with the prefix Baal of which we know the circumstances under which it was imposed; and we are thus enabled to determine that the word was sometimes at least used appellatively without any reference to the name of the idol Baal or to his worship.

BAAL-SIALISHA (בעל שַׁלִּישָׁה; Βαλσαρισά, Col. Alex. Βαυσαρισάθ, 2 Kings iv. 42), a place in the district of Shalisha (1 Sam. ix. 4). Eusebius and Jerome describe it as a city fifteen Roman miles north from Diospolis, near Mount Ephraim.

BAAL-TAMAR (בעל תמר; Sept. Βαλ Θαμάρ), a place near Gibeai, in the tribe of Benjamin, where the other tribes fought with the Benjamites (Judg. xx. 33). Eusebius calls it *Bethamar*, thus affording an instance of that interchange of *Beth* and *Baal* which is also exemplified in the preceding article and in Baal-Meon.

BAAL-ZEPHON (בעל צפון; Sept. Βεελασεφών), a town belonging to Egypt, on the border of the Red Sea (Exod. xiv. 2; Num. xxxiii. 7). Forster (*Epist. ad J. D. Michaellem*, p. 28) believes it to have been the same place as Heroopolis (Ἡρωπόλις) on the western gulf of the Red Sea (Plin. *Hist. Nat.* v. 12; Strabo, xvii. p. 836; Ptolem. iv. 5), where Typhon (which Forster makes in Coptic ΔΩΨΩΝ; but, *contra*, see Rosenmüller, *Alterthum.* iii. 261) was worshipped. But according to Manetho (Joseph. *Contra Apion.* i. 26), the name of Typhon's city was Avaris (Ἀβάρις). In fact, nothing is known of the situation of Baal-zephon; and whatever conjectures may be formed respecting it must be connected with a consideration of the route taken by the Israelites in leaving Egypt, for it was 'over against Baal-zephon' that they were encamped before they passed the Red Sea [Exodus].

BABEL, TOWER OF. From the account given in Genesis xi. 1-9, it appears that the primitive fathers of mankind having, from the time of the Deluge, wandered without fixed abode settled at length in the land of Shinar, where they took up a permanent residence. As yet they had remained together without experiencing those vicissitudes and changes in their outward lot which encourage the formation of different modes of speech, and were, therefore, of one language. Arrived however in the land of Shinar, and finding materials suitable for the construction of edifices, they proceeded to make and burn bricks, and using the bitumen, in which parts of the country abound, for cement, they built a city and a tower of great elevation. A divine interference, however, is related to have taken place. In consequence, the language of the builders was confounded, so that they were no longer able to understand each other. They therefore 'left off to build the city,' and were scattered 'abroad upon the face of all the earth.' The narrative adds that the place took its name of Babel (confusion) from this confusion of tongues. That the work was subsequently resumed, and in process of time completed, is known on the best historical vouchers.

Versions more or less substantially correct of this account are found among other nations. The Chaldeans themselves relate (Abydenus, quoted by Eusebius, *Prepar. Evang.* i. 14) that 'the first men, relying on their size and strength, raised a tower reaching towards heaven in the place where Babylon afterwards stood, but that the winds assisting the gods brought the building down on the heads of the builders, out of the

rums of which Babylon itself was built. Before this event, men had spoken the same tongue, but afterwards, by the act of the gods, they were made to differ in their speech.' Plato also reports a tradition that, in the golden age, men and animals made use of one common language, but too ambitiously aspiring to immortality, were, as a punishment, confounded in their speech by Jupiter. In the details of the story of the war of the Titans against the Gods may also be traced some traditional resemblance to the narrative of the Bible. 'The Sibyl,' says Josephus (*Antiq.* i. 4) 'also makes mention of this town, and of the confusion of language, when she says thus:—"When all men were of one language, some of them built a high tower as if they would thereby ascend up to heaven, but the gods sent storms of wind, and overthrew the tower; and gave every one his peculiar language; and for this reason it was that the city was called Babylon."

The same writer assigns as the reason of this overthrow and confusion, the displeasure of God at seeing them act so madly under the influence of Nimrod, 'a bold bad man,' who, in order to alienate the minds of the people from God, and to take revenge for the Deluge which had destroyed their forefathers, induced them to build a tower too high for the waters to be able to reach. Aben Ezra has given a more probable explanation. 'Those,' he says, 'who built the Tower of Babel were not so insensate as to imagine they could by any such means reach to heaven; nor did they fear another Deluge, since they had the promise of God to the contrary, but they wished for a city which should be a common residence and a general rendezvous, serving in the wide and open plains of Babylonia to prevent the traveller from losing his way; in order that whilst they took measures for their own convenience and advantage, they might also make themselves a name with future ages.'

The sacred narrative (Gen. xi. 4) assigns as the reason which prompted men to the undertaking, simply a desire to possess a building so large and high as might be a mark and rallying point in the vast plains where they had settled, in order to prevent their being scattered abroad, and thus the ties of kindred be rudely sundered, individuals be involved in peril, and their numbers be prematurely thinned at a time when population was weak and insufficient. The idea of preventing their being scattered abroad by building a lofty tower is applicable in the most remarkable manner to the wide and level plains of Babylonia, where scarcely one object exists different from another to guide the traveller in his journeying, and which, in those early days, as at present, were a sea of land, the compass being then unknown.

Such an attempt agrees with the circumstances in which the sons of Noah were placed, and is in itself of a commendable nature. But that some ambitious and unworthy motives were blended with these feelings is clearly implied in the sacred record, which, however, is evidently conceived and set forth in a dramatic manner (ver. 6, 7), and may wear around an historical substance somewhat of a poetical dress (Bauer, *Mythol.* i. 223). The apostate Julian has attempted to turn the narrative into ridicule; but even if viewed only as an attempt to account for the origin of diversity of languages, and of the dispersion of the human family, it

challenges consideration and respect. The opinion of Heeren (*Asiatic Nations*, vol. ii. p. 116) is far different and more correct: 'there is,' says he, 'perhaps nowhere else to be found a narrative so venerable for its antiquity, or so important in the history of civilization, in which we have at once preserved the traces of primeval international commerce, the first political associations, and the first erection of secure and permanent dwellings.' A comparison of this narrative with the absurd or visionary pictures which the Greeks and Romans give of the primitive condition of mankind, will gratify the student of the Bible and confirm the faith of the Christian, by showing the marked difference there is between the history contained in Genesis and the fictions of the poet, or the traditions of the mythologist.

After the lapse of so many centuries, and the occurrence in 'the land of Shinar' of so many revolutions, it is not to be expected that the identification of the Tower of Babel with any actual ruin should be easy, or lead to any very certain result. The majority of opinions, however, among the learned, make it the same as the temple of Belus described by Herodotus, which is found in the dilapidated remains of the Birs Nimrud.

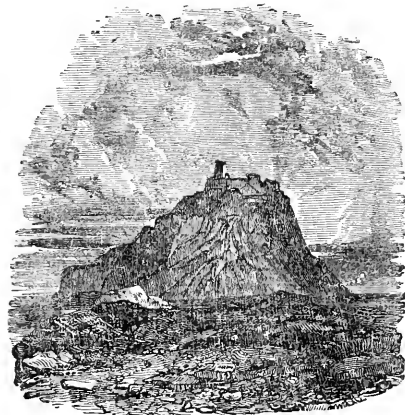

Herodotus describes the temple in his own simple but graphic manner (i. 181). 'In the other division of the city is the temple of the god Belus, with brazen gates, remaining till my own time, quadrangular, and in all of two stadia. In the middle of the sacred enclosure there stands a solid tower of a stadium both in depth and width; upon this tower another tower is raised, and another upon that, to the number of eight towers. An ascent to them has been made on the outside, in a circle extending round all the towers. When you reach about halfway you find resting places. In the last tower is a large temple, and in the temple lies a large bed well furnished, and near it stands a golden table; but there is no image within; nor does any one remain there by night, only a native female, one whom the god has chosen in preference to all others, as say the Chaldeans who are priests of that god. And these persons also say, asserting what I do not believe, that the god himself frequents the temple and reposes on the

couch. And there belongs to the temple in Babylon another shrine lower down, where there stands a large golden image of the god, and near it is placed a large golden table, and the pedestal and throne are gold, and, as the Chaldeans say, these things were made for eight hundred talents of gold. And out of the shrine is a golden altar; and there is another great altar where sheep-offerings are sacrificed, for it is not permitted to sacrifice upon the golden altar, except sucklings only; but upon the greater altar the Chaldeans offer every year a thousand talents' worth of frankincense at the time when they celebrate the festival of the god. And there was at that time in the temple a statue of twelve cubits of solid gold: but I did not see it, and relate merely what was told me by the Chaldeans. Darius Hystaspis wished to have this statue, but did not dare to take it, but Xerxes his son took it and slew the priest who forbade him to move the statue. Thus is this sacred place adorned; and there are also in it many private offerings.' These offerings, made by individuals, consisting of statues, censers, cups, and sacred vessels of massy gold, constituted a property of immense value. On the top Semiramis placed three golden statues of Jupiter, Juno, and Rhea. The first was 40 feet high, and weighed 1000 Babylonish talents. The statue of Rhea was of the same weight; the goddess was seated on a golden throne with lions at each knee, and two serpents of silver. The statue of Juno was erect like that of Jupiter, weighing 800 talents; she grasped a serpent by the head with her right hand, and held in her left a sceptre enriched with gems. A table of beaten gold was common to these three divinities, weighing 500 talents. On the table were two goblets of 30 talents, and two censers of 500 talents each, and three vases of prodigious magnitude. The total value of the precious articles and treasures contained in this proud achievement of idolatry has been computed to exceed one hundred and twenty millions sterling.

From the Holy Scriptures it appears that when Nebuchadnezzar conquered Jerusalem and levelled most of the city with the ground, 'he brought away the treasures of the temple, and the treasures of the king's house, and put them all into the temple of Bel at Babylon.' The brazen and other vessels which Solomon had caused to be made for the service of Jehovah are said to have been broken up by order of the Assyrian monarch, and formed into the famous gates of brass which so long adorned the superb entrances into the great area of the temple of Belus.

The purposes to which this splendid edifice was appropriated may have been partly gathered from the preceding statements. These purposes varied in some degree with the changes in opinions and manners which successive ages brought. The signal disappointment inflicted on its original founders show, that even in its origin there was connected with it something signally displeasing to God. It seems, indeed, always to have existed in derogation of the divine glory. Consecrated at the first, as it probably was, to the immoderate ambition of the monotheistic children of the Deluge, it passed to the Sabian religion and thus falling one degree from purity of worship, became a temple of the sun and the rest of the host of heaven, till, in the natural progress of corruption,

it sank into gross idolatry; and, as the passage from Herodotus shows, was polluted by the vices which generally accompanied the observances of heathen superstition. In one purpose it undoubtedly proved of service to mankind. The Babylonians were given to the study of astronomy. This ennobling pursuit was one of the peculiar functions of the learned men, denominated by Herodotus, Chaldeans, the priests of Belus; and the temple was crowned by an astronomical observatory, from the elevation of which the starry heavens could be most advantageously studied over plains so open and wide, and in an atmosphere so clear and bright, as those of Babylonia.

To Nimrod the first foundations of the tower are ascribed; Semiramis enlarged and beautified it, but it appears that the temple of Bel, in its most renowned state, was not completed till the time of Nebuchadnezzar, who, after the accomplishment of his many conquests, consecrated this superb edifice to the idolatrous object to whom he ascribed his victories. That the observatory on the tower was erected in remote times, there is good reason to believe. Prideaux mentions the circumstance that when Alexander made himself master of Babylon, Calisthenes, the philosopher, who attended him thither, found astronomical observations ascending upwards 1900 years.

The appearance of the tower is deeply impressive, rising suddenly as it does out of a wide desert plain, with its rent, fragmentary, and fire-blasted pile, masses of vitrified matter lying around, and the whole hill itself on which it stands caked and hardened out of the materials with which the temple had been built. Its dreary aspect seems to justify the name which the remnant of the captivity, still abiding amongst the waters of Babylon, give to the place, namely, 'Nebuchadnezzar's Prison'—an appellation which may have been assigned from the circumstance that that monarch's being confined there, under the care of the priesthood, during the period of his madness; or from the king of Israel's having been incarcerated within its precincts by Nebuchadnezzar, after his last conquest of Jerusalem (2 Kings xxv.). A very considerable space round the tower, forming a vast court or area, is covered with ruins, affording abundant vestiges of former buildings; exhibiting uneven heaps of various sizes, covered with masses of broken brick, tiles, and vitrified fragments—all bespeaking some signal overthrow in former days. The towerlike ruin on the summit is a solid mass 28 feet broad, constructed of the most beautiful brick masonry. It is rent from the top nearly halfway to the bottom. It is perforated in ranges of square openings. At its base lie several immense unshapen masses of fine brick work—some changed to a state of the hardest vitrification, affording evidence of the action of fire which seems to have been the lightning of heaven.

The base of the tower, at present, measures 2082 feet in circumference. Hardly half of its former altitude remains. Of the original pyramidal form, the erections of Semiramis and Nebuchadnezzar appear to have begun at the stage of the former overthrow. An elevation is subjoined according to the description of the structure given by historians; the dotted line marks the height of the present remains. From its summit, the view in the distance

presents to the south an arid desert plain; to the west the same trackless waste; towards the north-east marks of buried ruins are visible to a vast

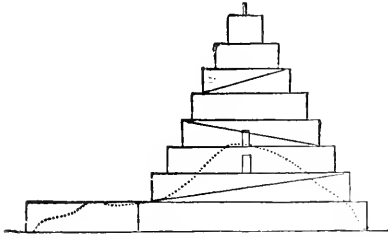

distance. The bricks which compose the town are mostly stamped with several lines of inscription, in the Cuneiform or Babylonian character. Some extend to four or even seven lines, but the dimensions of all are the same. The bricks of Babylon are of two kinds, sun-dried and fire-burnt. The former are larger and of a coarser make than the latter; their solidity is equal to that of the hardest stone. They are composed of clay mixed with chopped straw or broken reeds, in order to increase their compactness. This is the sort of brick which the children of Israel made while in Egyptian bondage. The unburnt bricks commonly form the interior or mass of a building. This is the case with the great tower, while it was faced with the more beautiful fabric made in the furnace or kiln.—J. R. B.

BABYLON, from the Greek *Βαβυλών*; the name in Hebrew is *בבל* Babel, from the confusion of tongues (Gen. xi. 1-9). Another derivation deduces the word from *בבל* *בבל*, 'the court or city of Belus.' In Daniel iv. 27 the place is appropriately termed 'Babylon the Great;' and by Josephus also (*Antiq.* viii. 6. 1), *ἡ μεγάλη Βαβυλών*. This famous city was the metropolis of the province of Babylon and of the Babylonio-Chaldæan empire. It was situated in a wide plain on the Euphrates, which divided it into two nearly equal parts. According to the book of Genesis, its foundations were laid at the same time with those of the tower of Babel. In the revolutions of centuries it underwent many changes, and received successive reparations and additions. The ancients were not agreed as to the authors or times of these, and any attempt to determine them now with strict accuracy must be fruitless. Semiramis and Nebuchadnezzar are those to whom the city was indebted for its greatest augmentations and its chief splendour. Its site has been with much probability ascertained to be near Hillah, about forty miles from Bagdad.

According to Herodotus, the walls of Babylon were sixty miles in circumference, built of large bricks cemented together with bitumen, and raised round the city in the form of an exact square; hence they measured fifteen miles along each face. They were 87 feet thick and 350 feet high (Quintus Curtius says four horse-chariots could pass each other on them without danger), protected on the outside by a vast ditch lined with the same material, and proportioned in depth and width to the elevation of the walls. The city was entered by twenty-five gates on each side, made of solid

brass, and additionally strengthened by 250 towers, so placed that between every two gates were four towers, and four additional ones at the four corners. From all the gates proceeded streets running in straight lines, each street being fifteen miles in length, fifty in number, and crossing each other at right angles. Other minor divisions occurred, and the whole city contained 676 squares, each two miles and a quarter in circumference. The river ran through the city from north to south; and on each side was a quay of the same thickness as the walls of the city, and 100 stadia in length. In these quays were gates of brass, and from each of them steps descending into the river. A bridge was thrown across the river, of great beauty and admirable contrivance, a furlong in length and 30 feet in breadth. As the Euphrates overflows during the summer months, through the melting of the snows on the mountains of Armenia, two canals were cut to turn the course of the waters into the Tigris, and vast artificial embankments were raised on each side of the river. On the western side of the city an immense lake forty miles square was excavated to the depth, according to Herodotus, of 35 feet, and into this lake the river was turned till the work was completed. At each end of the bridge was a palace, and these had a subterraneous communication.

The account given by Quintus Curtius (v. 1) of the entrance of Alexander into Babylon may serve to enliven the narrative, and at the same time make the impression on the reader's mind more distinct. 'A great part of the inhabitants of Babylon stood on the walls, eager to catch a sight of their new monarch; many went forth to meet him. Among these Bagophanes, keeper of the citadel and of the royal treasure, strewed the entire way before the king with flowers and crowns; silver altars were also placed on both sides of the road, which were loaded not merely with frankincense, but all kinds of odoriferous herbs. He brought with him for Alexander gifts of various kinds—flocks of sheep and horses; lions also and panthers were carried before him in their dens. The Magi came next, singing in their usual manner their ancient hymns. After them came the Chaldæans, with their musical instruments, who are not only the prophets of the Babylonians, but their artists. The first are wont to sing the praises of the kings; the Chaldæans teach the motions of the stars and the periodic vicissitudes of the times and seasons. Then followed last of all the Babylonian knights, whose equipment, as well as that of their horses, seemed designed more for luxury than magnificence. The king, Alexander, attended by armed men, having ordered the crowd of the townspeople to proceed in the rear of his infantry, entered the city in a chariot and repaired to the palace. The next day he carefully surveyed the household treasure of Darius, and all his money. For the rest, the beauty of the city and its age turned the eyes not only of the king, but of every one, on itself, and that with good reason.' Within a brief period after this, Alexander lay a corpse in the palace.

The greatest circumference ascribed by the ancients to the city walls is 480 stadia, the most moderate 360. The smallest computation supposes an area for the city of which we can

now scarcely form an idea. Its population however may not have been in proportion to its extent. The place was probably what in these days would be considered an enclosed district rather than a compact city. Quintus Curtius reports that the buildings were not continuous, and that within the precincts of the city was arable and pasture land sufficient to produce food for the population, as a resource against a siege.

One or two additional facts may aid in conveying a full idea of this great and magnificent city. When Cyrus took Babylon by turning the Euphrates into a neighbouring lake, the dwellers in the middle of the place were not for some time aware that their fellow-townsmen who were near the walls had been captured. This, says Herodotus (i. 191), was owing to the magnitude of the city, and to the circumstance that at the time the inhabitants were engaged in carousals, it being a festive occasion. Nor, according to Xenophon, did the citizens of the opposite quarter learn the event till three hours after sunrise—the city having been taken in the night. Alexander had to employ 10,000 men during two months, to remove the accumulated ruins precipitated by order of Xerxes nearly 200 years before. From the fallen towers of Babylon have arisen not only all the present cities in its vicinity, but others which, like itself, have long since gone down into the dust. Since the days of Alexander four capitals, at least, have been built out of its remains—Seleucia by the Greeks, Ctesiphon by the Parthians, Al Maidan by the Persians, and Kufa by the Caliphs; with towns, villages, and caravansaries without number. The necessary fragments and materials were transported along the rivers and the canals.

The antiquity of the canals of Babylonia dates from the most remote periods of the Chaldeo-Babylonian monarchy. The ancient kings of Assyria and Babylonia well understood the value of canals, and their empire arose upon alluvial plains, amid a system of irrigation and draining which spread like a net-work over the land. It may be sufficient to specify the Nahr Malikah, or Royal Canal, the origin of which has been referred both to Nimrod and Cush. Abydenus, however, attributes it to Nebuchadnezzar. From the account of Herodotus it appears to have been of sufficient breadth and depth to be navigable for merchant vessels. It is not, therefore, surprising that some writers have considered it as the ancient bed of the Euphrates.

The soil around Babylon is of a light yielding nature, easily wrought for canals and other purposes, whether of art or war. Cyrus, therefore, would find no great difficulty in digging a trench about the city sufficient to contain the waters of the river (*Cyrop.* vii.). Alexander (*Strabo*, xvi. p. 510), in enlarging one of the canals and forming basins for his fleet, laid open the graves of many buried kings and princes—which shows how readily the soil yields and gives way before the labours of man.

The new palace built by Nebuchadnezzar was prodigious in size and superb in embellishments. Its outer wall embraced six miles; within that circumference were two other embattled walls, besides a great tower. Three brazen gates led into the grand area, and every gate of consequence throughout the city was of brass. In accordance with this fact are the terms which Isaiah (xlv. 1, 2)

employs when, in the name of Jehovah, he promises Cyrus that the city should fall before him, 'I will open before him the two-leaved gates: I will break in pieces the gates of brass—a prophecy which was fulfilled to the letter when Cyrus made himself master of the place in the dead of the night. Having first by means of its canals turned the river into the great dry lake west of Babylon, and then marched through the emptied channel, he made his way to the outer walls of the fortified palace on its banks; when finding the brazen gates incautiously left open by the royal guards while engaged in carousals, he entered with all his train; 'the Lord of Hosts was his leader,' and Babylon, as an empire, was no more.

The palace was splendidly decorated with statues of men and animals, with vessels of gold and silver, and furnished with luxuries of all kinds brought thither from conquests in Egypt, Palestine, and Tyre. Its greatest boast were the hanging gardens, which acquired even from Grecian writers the appellation of one of the wonders of the world. They are attributed to the gallantry of Nebuchadnezzar, who constructed them in compliance with a wish of his queen Amytis to possess elevated groves such as she had enjoyed on the hills around her native Ecbatana. Babylon was all flat; and to accomplish so extravagant a desire an artificial mountain was reared, 400 feet on each side, while terraces one above another rose to a height that overtopped the walls of the city, that is, above 300 feet in elevation. The ascent from terrace to terrace was made by corresponding flights of steps, while the terraces themselves were reared to their various stages on ranges of regular piers, which, forming a kind of vaulting, rose in succession one over the other to the required height of each terrace, the whole being bound together by a wall of 22 feet in thickness. The level of each terrace or garden was then formed in the following manner: the top of the piers was first laid over with flat stones, 16 feet in length and 4 feet in width; on these stones were spread beds of matting, then a thick layer of bitumen; after which came two courses of bricks, which were covered with sheets of solid lead. The earth was heaped on this platform; and in order to admit the roots of large trees, prodigious hollow piers were built and filled with mould. From the Euphrates, which flowed close to the foundation, water was drawn up by machinery. The whole, says Q. Curtius (v. 5.), had, to those who saw it from a distance, the appearance of woods overhanging mountains. Such was the completion of Nebuchadnezzar's work, when he found himself at rest in his house, and flourished in his palace. The king spoke and said, 'Is not this great Babylon that I have built for the house of the kingdom by the might of my power, and the honour of my majesty' (*Dan.* iv.), a picture which is amply justified by the descriptions of heathen writers. Nowhere could the king have taken so comprehensive a view of the city he had so magnificently constructed and adorned as when walking on the highest terrace of the gardens of his palace.

The remains of this palace are found in the vast mound or hill called by the natives Kasr. It is of irregular form, 800 yards in length and 600 yards in breadth. Its appearance is constantly undergoing change from the continual digging which takes place in its inexhaustible

quaries for brick of the strongest and finest material. Hence the mass is furrowed into deep

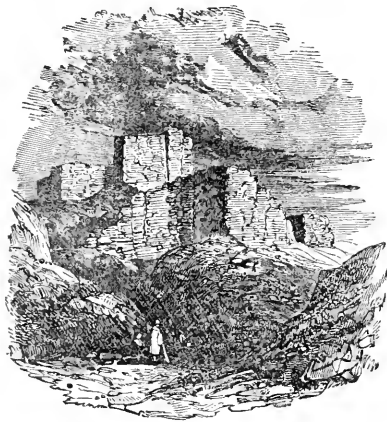

ravines, crossing and recrossing each other in every direction. Every vestige, however, discovered in it declares it to have been composed of buildings far superior to all the rest in the Eastern quarter. In this mass Rich found a lion of colossal dimensions, standing on a pedestal of a coarse kind of grey granite and of rude workmanship; in the mouth was a circular aperture, into which a man might introduce his fist. Hollows

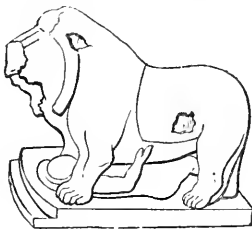

caused by excavation occur in the mound, in which persons have lost their lives. Considerable fragments of wall are still standing; and also detached masses, composed of furnace-burnt bricks of a beauty and freshness truly admirable. The bricks used in the construction of the palace appear to have been exclusively of the burnt kind. The face of every brick is invariably placed downwards. On the north side of the Kasr, amongst the mouldering fragments, and elevated on a sort of ridge, stands the famous solitary tree, called by the Arabs Atheleh; it bears every mark of antiquity in appearance, situation, and tradition. Its trunk was originally enormous; but, worn away by the lapse of ages, it is now but a ruin amid ruins: nevertheless it bears spreading and ever-green branches, which are peculiarly beautiful, being adorned with long tress-like tendrils resembling heron feathers, growing from a central stem. These slender and delicate sprays bending towards the ground give the whole the appearance of a weeping willow, while their gentle waving in the wind whenever a breeze blows, produces a low and melancholy sound. This tree is revered by the Arabs as holy, from a tradition current among them, that the

Almighty himself preserved it here from the earliest time, to form a refuge for the Caliph Ali, who fainting with fatigue from the battle of Hillah, found secure repose under its shade.

In digging in the extensive mounds which constitute the ruins of Babylon, an endless succession of curious objects is found from time to time. One or two may be specified:—a large cylinder of baked clay, covered with a cuneiform



inscription; an agate seal finely cut, representing a priest surrounded by various symbols of the Sabian worship; a small dog in bronze, with a collar of pure gold round his neck, about three inches in height. Small figures, both in bronze and clay, are frequently picked up all over the ruins of Babylon. One of a larger kind is a fragment seen lying midway between Hillah and the site of Seleucia, consisting of the lower half of the statue of a man in a sitting posture; the legs are naked, and closed together in the Egyptian style; the hands rest on the thighs. It is cut in a bluish basalt. That so few comparatively of these relics are now visible is not surprising, since, as Babylon had plundered Egypt, Assyria, and Judæa of their statues, their gold and silver, and even the architectural ornaments of their palaces, so in its turn this rich treasury of the antiquities of all nations became the prey of successive conquerors; and plunderers completed the work of spoliation. One or two



drawings are here given of relics discovered on this site. The first represents a cylinder representing a very remarkable group of personages, and an inscription in cuneiform characters of a peculiar kind. The figures are connected with the rites of the lunar deity, who was worshipped by the Persians and the Chaldeans under the

names of Mylitta and Ahytta, or Araités and Aranus. According to Maimonides, this Babylonish deity had numerous bands of young women devoted to her service; and here is seen a priestess introducing a virgin to her temple to receive the benediction of the priests. These dedicated females, Herodotus says, sat once in their lives in the shrine of Venus, their heads bound with garlands and their bodies with cords. Thus exposed, if any stranger threw gold into her lap, she was obliged to retire with him into the temple, when her charms became the victim of its impure rites. The money was then laid on the altar to be consecrated to the goddess. These outrages seem to be referred to by Moses in the law, when he says, 'Thou shalt not bring the hire of a harlot into the house of the Lord thy God.' The second cut is from a cylinder of white agate. The engraving is of good workmanship. The hieroglyphics are the sun, moon, five planets, and the archaspand, or seven balls, indicative of the seven celestial powers or intelligences, always attendant on the Chaldean and Persian great deity. The figure beneath the sun holds a wreath

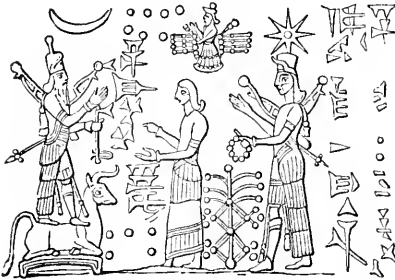

formed of globular shapes in his left hand. On his back appear to be a bow and quiver; balls surmount these weapons. Before him springs an object sprayed like a flower, and he is preceded, in advancing towards a superior kind of being, by a bareheaded figure, whose hands are held up as if in the act of addressing that being which fronts him standing upon the unicorn ball. An ethereal personage is seen over the head of the uncovered and unadorned figure. The august bearded figure, which the last addresses, bears the symbols of divinity among the Chaldeans, such as sceptres, axes, and other weapons. The floating figure in the rays clearly points out a close affinity between the religious system of the Chaldeans and the ancient Persians; showing that they used the same symbolical representations, and also prefigured the same gods and their attributes in the sun and moon; and hence it appears probable that the alleged difference between the two religions chiefly lay in the one worshipping the imaged symbols as gods, while the other restricted itself to adoring the heavenly host in themselves alone. The two engravings which follow are introduced less with reference to their subjects than for the sake of the illustrations of Babylonian costume which they afford. The figures have been selected from the engraved cylinders and gems, and probably convey as much information on this subject as can now be obtained.

Babylon, as the centre of a great kingdom, was the seat of boundless luxury, and its inhabitants were notorious for their addiction to self-indulgence and effeminacy. Q. Curtius (v. 1) asserts that, 'nothing could be more corrupt than its morals, nothing more fitted to excite and allure to immoderate pleasures. The rites of hospitality were polluted by the grossest and most shameless lusts. Money dissolved every tie, whether of kindred, respect, or esteem. The Babylonians were very greatly given to wine, and the enjoyments which accompany inebriety. Women were present at their convivialities, first with some degree of propriety, but, growing worse and worse by degrees, they ended by throwing off at once their modesty and their clothing.' On the ground of their awful wickedness the Babylonians were threatened with condign punishment, through the mouths of prophets; and the tyranny with which the rulers of the city exercised their sway was not without a decided effect in bringing on them the terrific consequences of the Divine vengeance. Nor in the whole range of literature is there anything to be found approaching to the sublimity, force, and terror with which Isaiah and others speak on this painful subject (Is. xiv. 11; xlvii. 1; Jer. li. 39; Dan. v. 1).

Under Nabonnidus, the last king, B.C. 538 or 539, Babylon was taken by Cyrus, after a siege of two years. An insurrection, under Darius Hystaspis (B.C. 500), the object of which was to gain emancipation from Persian bondage, led that prince to punish the Babylonians by throwing down the walls and gates which had been left by Cyrus, and by expelling them from their homes. Xerxes plundered and destroyed the temple of Belus, which Alexander the Great would probably, but for his death, have restored. Under Seleucus Nicator the city began to sink speedily, after that monarch built Seleucia on the Tigris, and made it his place of abode. In the time of Strabo and Diodorus Siculus the place

ray in ruins. Jerome, in the fourth century of the Christian era, learnt that the site of Babylon had been converted into a park or hunting-ground for the recreation of the Persian monarchs, and that, in order to preserve the game, the walls had been from time to time repaired. If the following extract from Rich (p. 30) is compared with these historical facts, the prophecy of Isaiah (xiii. 19) will appear to have been strikingly fulfilled to the letter: 'I had always imagined the belief of the existence of satyrs was confined to the mythology of the West; but a choadar who was with me when I examined this ruin (the Mujahlibah) mentioned that in this desert an animal is found resembling a man from the head to the waist, but having the thighs and legs of a sheep or goat: he also said that the Arabs hunt it with dogs, and eat the lower parts, abstaining from the upper, on

account of their resemblance to those of the human species.'

More thorough destruction than that which has overtaken Babylon cannot well be conceived. Rich was unable to discover any traces of its vast walls, and even its site has been a subject of dispute. 'On its ruins,' says he, 'there is not a single tree growing, except the old one,' which only serves to make the desolation more apparent. Ruins like those of Babylon, composed of rubbish impregnated with nitre, cannot be cultivated. The ruins of Babylon and its vicinity consist in general of mounds of earth formed by the decomposition of buildings, channelled and furrowed by the weather, and having the surface strewn with pieces of brick, bitumen, and pottery. In addition to the Birs Nimrod and the Kasr, already described, mention may be made of the Mujahli-

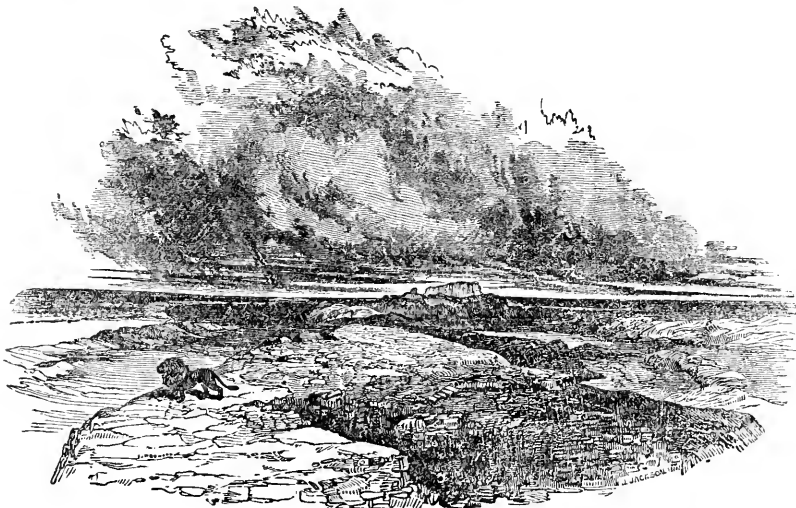

[Site of Babylon.]

bah, which lies to the north of the Kasr, five miles from Hillah, and 950 yards from the river bank. Its shape is oblong and its height irregular. The sides face the cardinal points: the northern is 200, the southern 219, the eastern 182, and the western 186 yards in length; and the elevation of the south-east or highest angle is 141 feet. The western face is the most interesting, on account of the appearance of building which it presents. Near the summit is a low wall, composed of unburnt bricks, mixed up with chopped straw or reeds, and cemented with clay mortar of great thickness, having between every layer of bricks a layer of reeds; and on the north side are also some vestiges of a similar construction. The south-west angle is crowned by something like a turret or lantern. All the sides are worn into furrows, which in some instances are of great depth. The summit is covered with heaps of rubbish, in which layers of broken burnt bricks cemented with mortar have been found, and also entire bricks with inscriptions. Scattered over the whole are fragments of pottery, brick, bitumen, pebbles, vitrified brick or scoria, and even shells, bits of glass, and mother-of-pearl. In the northern face near the

top, is a niche or recess, high enough for a man to stand upright in, at the back of which is a low aperture, leading to a small cavity, whence a passage branches off to the right, sloping upwards in a westerly direction, till it loses itself in the rubbish. Mr. Rich was informed that a human body had been found here, swathed in a tight wrapper, partially covered with bitumen, and enclosed in a coffin of mulberry-wood. Being induced to dig here, he came to a shaft, or hollow pier, 60 feet square, lined with fine brick laid in bitumen, and filled up with earth, in which were found a brass spike, some earthen vessels, and a beam of date-tree wood. This hollow pier corresponds with Strabo's description (p. 738) of the hollow brick piers which supported the hanging-gardens, and in which the large trees grew. Rich also discovered, in a continuation of the passage to the eastward, a wooden coffin containing a skeleton in good preservation. Under the head of the coffin was a round pebble; attached to the coffin, on the outside, was a brass bird, and inside an ornament of the same material, which had apparently been suspended to some part of the skeleton. A little farther on the skeleton of a child

was found, and Rich was of opinion that the whole passage was occupied in a similar manner. It may therefore be conjectured that the Mujalibah was a great brick pyramid for the dead. It may also have been used for an observatory.

Neither the ancient nor the modern authorities are in exact agreement respecting particular places and localities, and any attempt to fix them now can be nothing more than an approach to the reality. Instead, therefore, of repeating uncertainties, or adding conjectures to conjectures, we judge it better to refer the reader to the works enumerated at the foot of the ensuing article.

In the prophetic writings of the Apocalypse (xiv. 8; xvi. 19; xvii. 5; xviii. 2) Babylon stands for Rome, symbolizing Heathenism:—'Babylon is fallen, that great city, because she made all nations drink of the wine of the wrath of her fornication.' This reference appears to have been derived from the practice of the Jews, who were accustomed to designate Rome, which they hated, by the opprobrious and not inappropriate name of Babylon (Schöttgen, *Hor. Hebr.* i. p. 1125).—

J. R. B.

BABYLONIA (so called from the name of its chief city, termed also Chaldæa, from those who at a later period inhabited it), a province of Middle Asia, bordered on the north by Mesopotamia, on the east by the Tigris, on the south by the Persian Gulf, and on the west by the Arabian Desert. On the north it begins at the point where the Euphrates and Tigris approach each other, and extends to their common outlet in the Persian Gulf, pretty nearly comprising the country now designated Irak Arabi. The two words, Babylonia and Chaldæa, were however sometimes used in another signification: Babylonia, as containing in an extended sense Assyria also and Mesopotamia, nearly all the countries which Assyria in its widest meaning embraced; while Chaldæa indicated, in a narrower signification, the south-western part of Babylonia between the Euphrates and Babylon (Strabo, xvi.; Ptol.). In Hebrew, Babylonia bore the name of שִׁנְאֵר, Shinar, or 'the land of Shinar,' while 'Babylon' (Ps. cxxxvii. 1) and 'the land of the Chaldæans' (Jer. xxiv. 5; Ezek. xii. 13) seem to signify the empire of Babylon. The climate is temperate and salubrious. The country in ancient times was very prolific, especially in corn and palms. Timber-trees it did not produce. Many parts had springs of naphtha. As rain is infrequent, even in the winter months, the country owes its fruitfulness to the annual overflow of the Euphrates and the Tigris, whose waters are conveyed over the land by means of canals. Quintus Curtius (i. 5) declares that the country between the Euphrates and the Tigris was covered with so rich a soil, that the cattle were driven from their pastures lest they should be destroyed by satiety and fatness.

The alluvial plains of Babylonia, Chaldæa, and Susiana, including all the river, lake, and newer marine deposits at the head of the Persian Gulf, occupy an extent of about 32,400 square geographic miles. The rivers are the Euphrates and its tributaries, the Tigris and its tributaries, the Kerah, the Karun and its tributaries, the Jerahi, and the Idiyan; constituting, altogether, a vast hydrographical basin of 189,200 geographic square miles; containing, within itself, a central de-

posit of 32,400 miles of alluvium, almost entirely brought down by the waters of the various rivers, and which have been accumulating from periods long antecedent to all historical records. All these rivers present the peculiarity of flowing, for a great part of their course, through supra-cretaceous formations of a very friable nature, easily disintegrated by the action of the elements, and still more so by that of running waters when swollen by floods, and carrying down pebbles. Near Bushiyah, about ten miles beyond the south-east quarter of ancient Babylon, on a level plain, are found a number of sand-hills, which are constantly shifting their place and number, and yet always occupy the same general locality. They appear to owe their existence to the presence of springs, which moisten the sand and cause its accumulation, at the same time allowing the prevalent winds to alter the form and number of the hills, while their bases have a fixed point of attraction. They are objects of superstition to the Arabs, who often look upon them as the sepulchral pall of brethren who have fallen in battle. The efflorescences of nitrate of potassium and of chloride or hydro-chlorate of sodium are common on these plains; the one is most probably derived from the decomposition of vegetable matters, and, consequently, characteristic of alluvium of river or marshy origin; the other is indicative of depositions from seas or bays. The modern accumulations of soil in Babylonia from annual inundations is still very great. Several canals, such as the Isa, the Nahr Zimberani-Yah, the Muhawil, &c., convey water at certain seasons of the year from one river and part of the country to another. In general, the alluvium that is brought down by canals and rivulets, and deposited at their mouths, is a fine clay. The great extent of the plain of Babylonia is everywhere altered by artificial works; mounds rise upon the otherwise uniform level, walls and mud ramparts and dykes intersect each other, elevated masses and friable soil of pottery are succeeded by low plains inundated during great part of the year, and the antique beds of canals are visible in every direction. There is still some cultivation and some irrigation. Flocks pasture in meadows of coarse grasses; the Arabs' dusky encampments are met with here and there; but, except on the banks of the Euphrates, there are few remains of the date-groves, the vineyards, and the gardens which adorned the same land in the days of Artaxerxes; and still less of the population and labour which must have made a garden of such soil in the time of Nebuchadnezzar. The vegetation of these tracts is characterized by the usual saline plants, the river banks being fringed by shrubberies of tamarisk and acacia, and occasional groves of a poplar which has been mistaken for a willow, the weeping willow (*Salix Babylonica*) is not met with in Babylonia. The solitary tree, 'of a species altogether strange to this country' (Heeren, *Asiatic Nations*, vol. ii. p. 158), which Rich calls *lignum-vitæ*, and which has been supposed to be a last remnant or offspring of the sloping or hanging gardens that appeared to Quintus Curtius like a forest, is in reality a tamarisk. No monuments in Babylonia and Chaldæa appear to be more decisive of the antiquity and Assyrian origin of sites than the lofty artificial mound, of which the present degenerate herds of the tent

and the spear narrate so many fabulous tales, but which almost everywhere present themselves where there are also other strong grounds of presumption of an Assyrian or Chaldeo-Babylonian origin. Thus at Irakah, at Wasit, at Terodon, at the Birs Nimrud, the Mujahlibah, El Heimar, &c., these colossal piles are found domineering over the dreary waste, to the uniformity of which they offer a striking contrast, being visible at great distances; and, although thrown by the mirage into strange and contorted shapes, yet they always appear, when seen upon the verge of the horizon, as if possessing colossal dimensions, and produce an effect in point of grandeur which cannot easily be surpassed. Long before the period when man began to erect these feeble semblances of mountains, a various level of alluvium had been established in the spaces between the rivers, by which in one part the waters of the Euphrates find a higher level than the Tigris, into which they flow at the high season; while at another place the Tigris sends its waters to the Euphrates, and restores the flood by which it had been previously enriched from the 'Great River.'

The Euphrates is still a majestic stream, but wanders through a dreary solitude. Its banks are hoary with reeds, and the grey osier-willows are yet there on which the captives of Israel hung up their harps, and, while Jerusalem was not, refused to be comforted. At that time its now broken hills were palaces; its long undulating mounds, streets; its vast solitude was filled with the busy subjects of the proud mistress of the East. Now, 'wasted with misery,' her habitations are not to be found; and, for herself, 'the worm is spread over her.' Strabo makes the Euphrates a stadium (500 feet) in breadth at Babylon; according to Rennel it is about 491 English feet; D'Anville reduces it to 330; Rich, on the other hand, raises it to 430 feet; its breadth, however, varies in its passage through the ruins. Rich ascertained its depth to be $2\frac{1}{2}$ fathoms, and that the current runs gently at the medium rate of about two knots an hour. The Euphrates is far less rapid than the Tigris, and rises at an earlier period. When at its height—from the latter end of April to the latter end of June—it everflows the surrounding country, fills, without the aid of human labour, the canals dug for its reception, and facilitates agriculture in a surprising degree. The ruins of Babylon are then so inundated as to render many parts of them inaccessible. The water of the Euphrates is esteemed more salubrious than that of the Tigris. The course of the river through the site of Babylon is north and south. Bricks and other fragments of buildings are frequently found in it by fishermen who ply on its waters.

During the three great empires of the East, no tract of the whole appears to have been so reputed for fertility and riches as the district of Babylonia, which arose in the main from the proper management of the mighty river which flowed through it. Herodotus mentions that, when reduced to the rank of a province, it yielded a revenue to the kings of Persia which comprised half their income. And the terms in which the Scriptures describe its natural as well as its acquired supremacy when it was the imperial city, evidence the same facts. They call it 'Babylon, the glory of kingdoms; the beauty of the Chaldee excellency; the lady of kingdoms, given to plea-

sure; that dwelleth carelessly, and sayeth in her heart, *I am*, and there is none else beside me.' But now, in the expressive and inimitable language of the same holy book, may it be said—'She sits as a widow on the ground. There is no more a throne for thee, O daughter of the Chaldeans!' As for the abundance of the country, it has vanished as clean away as if 'the besom of desolation' had swept it from north to south; the whole land, from the outskirts of Bagdad to the farthest reach of sight, lying a melancholy waste.

In order to defend the country against hostile attacks from its neighbours, northward from Babylon, between the two rivers, a wall was built, which is known under the name of the Median Wall (*τὸ Μηδίας καλούμενον τείχος*, Xen. *Anab.* ii. 4, 12). The Babylonians were famous for the manufacture of cloth and carpets: they also excelled in making perfumes, in carving in wood, and in working in precious stones. They were a commercial as well as a manufacturing people, and carried on a very extensive trade alike by land and by sea. Babylon was indeed a commercial dépôt between the Eastern and the Western worlds (Ezek. xvii. 4; Is. xliii. 14). Thus favoured by nature and aided by art, Babylonia became the first abode of social order and the cradle of civilization. Here first arose a powerful empire—here astronomy was first cultivated—here measures and weights were first employed.

The original inhabitants were without doubt of the Shemitic family; and their language belonged to the class of tongues spoken by that race, particularly to the Aramaic branch, and was indeed a dialect similar to that which is now called Chaldee.

From the account which is found in Gen. x. 8, *Nimrod*, the son of Cush, appears to have founded the kingdom of Babylon, and to have been its first sovereign. In the 14th chap. of the same book, *Amraphel* is cursorily mentioned as king of Shinar. In the reign of *Hezekiah* (A.C. 713)—2 Kings xx. 12—'Berodach-baladan, the son of Baladan,' was 'king of Babylon,' and 'sent letters and a present unto Hezekiah, for he had heard that Hezekiah had been sick.' About a hundred years later, *Jeremiah* and *Habakkuk* speak of the invasion of the Babylonians under the name of the Chaldeans; and now *Nebuchadnezzar* appears in the historical books (2 Kings xxiv. 1, sq.; Jer. xxxvi. 9, 27) as head of the all-subduing empire of Babylon. *Evitmerodach* (2 Kings xxv. 27; Jer. lii. 31), son of the preceding, is also mentioned as 'king of Babylon;' and with *Belshazzar* (Dan. v. 1, 30), the Nabonedus of Berosus, the line of the Chaldean kings was closed: he perished in the conquest of Babylon by the Medo-Persians (Dan. v. 31), and *Darius*, the Median, took the kingdom.

The domination of the Chaldeans in Babylon has given historians some trouble to explain. The Chaldeans appear to have originally been a nomadic tribe in the mountains of Armenia, numbers of whom are thought to have settled in Babylon as subjects, where, having been civilized and grown powerful, they seized the supreme power and founded a Chaldeo-Babylonian empire.

Herodotus has noticed the Chaldeans as a tribe of priests (i. 28); *DioCorus* (i. 28), as a separate caste under *Belus*, an Egyptian priest; while the book of *Daniel* refers to them as astrologers, magicians, and soothsayers: but there can be

little doubt, as laid down by Gesenius on Isaiah xxiii. 13, that it was the name of a distinct nation, if not, as Heeren (*Manual of Anc. Hist.* 28) has maintained, the name of the Northern nomades in general. In connection with Babylonia the Chaldaeans are to be regarded as a conquering nation as well as a learned people: they introduced a correct method of reckoning time, and began their reign with Nabonassar, B.C. 747. The brilliant period of the Chaldaeo-Babylonian empire extended to B.C. 538, when the great city, in accordance with the prophecy of Daniel, was sacked and destroyed.

Babylonia, during this period, was 'the land of the Chaldaeans,' the same as that into which the children of Judah were carried away captive (Jer. xxiv. 5); which contained Babylon (Jer. l. 1; Ezek. xiii. 13); was the seat of the king of Babylon (Jer. xxv. 12), and contained the house of the god of Nebuchadnezzar (Dan. i. 1, 2). The profane historians lend their testimony to the same effect. There is another scriptural reference to this proud period in the history of the Chaldees, when learned men filled the streets and the temples of Nineveh and Babel:— 'Behold the land of the Chaldaeans; this people was not, till the Assyrian founded it for them that dwell in the wilderness: they set up the towers thereof, they raised up the palaces thereof; and he brought it to ruin' (Isa. xxiii. 13).

A full description of the actual condition of Babylonia, Babylon, and Babel, with illustrations, disquisitions, maps, plans, &c., may be found in the following works:—*Memoir on the Ruins of Babylon*, by C. J. Rich, 2nd edit. London, 1836; *Travels in Georgia, Persia, Armenia, and Ancient Babylonia*, by Sir Robert Ker Porter, London, 1822; Ainsworth's *Researches in Babylonia*, London, 1838; Fraser's *Travels in Koordistan, Mesopotamia, &c.* London, 1840; Rosenmüller's *Biblische Aelterthumskunde*; Gesenius in the *Cyclopaedie* of Ersch and Gruber; Heeren, *Ideen*, i. 4; Wahl, *Geschichte der Morg. Spr.* p. 570; Winer, *Biblisches Real-wörterbuch*.—J. R. B.

BACA (בָּכָה) and BECAIM (בְּעֵימִים) occur, the first in Ps. lxxxv. 6, 'Who passing through the valley of Baca make it a well; the rain also filleth the pools;' the second in 2 Sam. v. 23, 24, and in 1 Chron. xiv. 14, 15, 'And let it be, when thou hearest the sound of a going in the tops of the mulberry trees, that thou shalt bestir thyself.'

Neither the *mulberry* nor the *pear-tree*, considered to be the *baca* of the Scriptures, satisfies translators and commentators, because they do not possess any characters particularly suitable to the above passages. With regard to the *mulberry*, Rosenmüller justly observes, that this interpretation is countenanced neither by the ancient translators nor by the occurrence of any similar term in the cognate languages. We should expect, however, some notice in Scripture of a tree which must have been common, and always esteemed for its fruit [SYKAMINOS]. Rosenmüller prefers *pear-trees* in the preceding passages, as being the oldest rendering of the words. But the correctness of this translation is not confirmed by any of the cognate dialects; nor is the *pear-tree* more appropriate than the *mulberry*.

In consequence no doubt of these difficulties,

other plants have been resorted to; and Celsi^{us} quotes Abu'l Fadli's description of a shrub of Mecca: 'Baca nota est arbor s. frutex, in Mecca, et tractibus vicinis. Similis est 77

بشام Baschâm, nisi quod folia ejus longiora sint. Fructum, perinde ac illa, plurimum fert, sed majorem et rotundiorum. Temperamento calida est et sicca. Et cum folium ejus rescatur, lacryma quaedam inde distillat, alba, calida, et acris, virtutis tamen nullius. Probata est medicina contra dolorem dentium, si hujus arboris ramis fricentur. Quin et confortat gingivas, et prohibet ne malum renovetur' (Cels. i. 339).

The same plant is probably that referred to by Forskal (p. 198) among the obscure plants without fructification which he obtained from Djobbæ, and which he says was called بكا Baka, vel ابا Ebka: 'Arbor foliis obovatis, glabris, integris, lactescens, venenata.'

If this be the same as the former, both are still unknown any further, and we cannot therefore determine whether they are found in Palestine or not.

The tree alluded to in Scripture, whatever it is, must be common in Palestine, must grow in the neighbourhood of water, have its leaves easily moved, and have a name in some of the cognate languages similar to the Hebrew *Baca*. The only one with which we are acquainted answering to these conditions is that called *bak* by the Arabs, or rather *shajrat-abak*—that is, the *fly* or *gnat* tree. It seems to be so called from its seeds, when loosened from their capsular covering, floating about like gnats, in consequence of being covered with light silk-like hairs, as is the case with those of the willow. In Richardson's *Arabic Dictionary* the *bak*-tree is considered to be the elm, but to us it appears to be the poplar: for the *dirdar* of the Arabians seems to be another kind of *bak*-tree, probably the *arbor culicum* of the Latin translators of Avicenna. Of this tree Plempius says, 'Leguntur in codice Romano principio hæc, Dicit Dioscorides hanc arborem esse salici similem; à Syris vocari *dirdar*, à Chaldæis culicum arborem.' As this passage is not found in Dioscorides, it is curious that it should occur in an old manuscript. For in other Arabic authors the *dirdar* is said to be a kind of *ghurb*, and the *ghurb* we have ascertained to be the Lombardy poplar (v. *Illust. HIMAL. Bot.*, p. 344). The willow and the poplar are well known to have the same kind of seed, whence they are included by botanists in the group of Salicinea.

As it seems to us sufficiently clear that the *bak*-tree is a kind of poplar, and as the Arabic '*bak*' is very similar to the Hebrew '*Baca*,' so it is probable that one of the kinds of poplar may be intended in the above passages of Scripture. And it must be noted that the poplar is as appropriate as any tree can be for the elucidation of the passages in which *baca* occurs. For the poplar is well known to delight in moist situations, and Bishop Horne, in his *Comm.* on Psalm lxxxiv., has inferred that in the valley of *Baca* the Israelites, on their way to Jerusalem, were refreshed by plenty of water. It is not less appropriate in the passages in 2 Samuel and 1 Chronicles, as no tree is more remarkable than the poplar for the ease with which its leaves are rustled by the slightest

movement of the air; an effect which might be caused in a still night even by the movement of a body of men on the ground, when attacked in flank or when unprepared. That poplars are common in Palestine may be proved from Kitto's *Palestine*, p. 114: 'Of poplars we only know, with certainty, that the black poplar, the aspen, and the Lombardy poplar grow in Palestine. The aspen, whose long leaf-stalks cause the leaves to tremble with every breath of wind, unites with the willow and the oak to overshadow the watercourses of the Lower Lebanon, and, with the oleander and the acacia, to adorn the ravines of southern Palestine: we do not know that the Lombardy poplar has been noticed but by Lord Lindsay, who describes it as growing with the walnut-tree and weeping-willow under the deep torrents of the Upper Lebanon.'—J. F. R.

BACA, THE VALLEY OF (Ps. lxxxiv. 6), or Valley of Weeping. Some, with our translators, regard this as the name of a place, and by such it has been usually sought in the Bekaa (el-Bekaa), a valley or plain in which Baalbek is situated. But this spot is far from possessing the dreariness and drought on which the point of the Psalmist's allusion depends. It does not appear necessary to understand that there is any reference to an actual valley so called. The Psalmist in exile, or at least at a distance from Jerusalem, is speaking of the privileges and happiness of those who are permitted to make the usual pilgrimages to that city, in order to worship Jehovah in the Temple: 'They knew the ways that lead thither, yea, though they must pass through rough and dreary paths, even a vale of tears; yet such are their hope and joy of heart, that all this is to them as a well-watered country, a land crowned with blessings of the early rain.' Dr. Robinson (*Add. to Calmet*) concludes that something like this is the sense of the passage. Few versions regard the word as a proper name. The Sept. has εἰς τὴν κοιλάδα τοῦ κλαυθμώνος; the Vulgate, *in valle lacrymarum*.

BAD. [Byssus.]

BADGER. This is unquestionably a wrong interpretation of the word טַחַשׁ *tachash*, since the badger is not found in Southern Asia, and has not as yet been noticed out of Europe. The word occurs in the plural form in Exod. xxv. 5; xxvi. 14; xxxv. 7, 23; xxxvi. 19; xxxix. 31; Num. iv. 6, 8, 10, 11, 12, 14, 25; and Ezek. xvi. 10; and in connection with עֹרֹת *oroth*, skins, is used to denote the covering of the Tabernacle. Skins of some animal no doubt are meant, though any confirmation in favour of the badger, derived from the Chaldee version, with or without a prefix, is equally untenable, since the species is likewise unknown in Chaldæa. A judicious Biblical critic observes that it is questionable whether the skin of an unclean animal would have been suffered to come in contact with objects kept so sacred as the Tabernacle and all that pertained to it. This consideration was evidently paramount when we find rams' skins, stained red, employed in the first covering, and these, like all the other materials required for the purpose, were free gifts from the people; consequently the skins for the external covering were likewise possessed by the public, and therefore were used or intended for common purposes.

In the present state of zoological knowledge it

is not necessary to refute the notions that *tachash* was the name of a mermaid or homo marinus, or of the walrus, a Polar animal, or of the dugong or seal, for neither of these is known in the Indian, Red, or Persian seas, and there is little probability that in remote ages they frequented the south-east extremity of the Mediterranean, where the current sweeps all things northward; still less that they nested in the lakes of the Delta, where crocodiles then abounded. But

Niebuhr's hint respecting the name **تخس** *tachash*, given, with some reference to colours, to a species of delphinus or porpoise, by the Arabs near Cape Mussendum, may deserve consideration, since the same people still make small rounded bucklers and soles of sandals of the *hout's* skin, which is a cetaceous animal, perhaps identical with Niebuhr's. This material might have been obtained from the caravan-traders of Yemen, or from the Ismaelites of Edom, but does not appear to have been fitted for other purposes than pack-saddles and sandal-soles: considering *tachash*, therefore, not to indicate a colour, but the skin of an animal, which may have derived its name from its colour, probably deep grey, ash, or slaty (*hysginus*), we must look for the object in question to the zoology of the region around, or to places accessible by means of the traders and tribute importations of raw materials in Egypt, where we actually observe leopard or panther skins and others of a smaller carnivorous animal with a long fox-tail represented in the triumphal procession of Thothmes III. at Thebes (Wilkinson's *Anc. Egyptians*, vol. i. pl. 4). These may have been of a canine genus, such as the *agriodus*, or *megalotis Lalandii*, which is actually iron-grey; or of a viverrous species, whereof there are many in Africa both grey and spotted. Still these are unclean animals, and for this reason we turn to another view of the case, which may prove the most satisfactory that can now be obtained. Negroland and Central and Eastern Africa contain a number of ruminating animals of the great antelope family: they are known to the natives under various names, such as *pacasse*, *emjacasse*, *thacasse*, *facasse*, and *taclaitze*, all more or less varieties of the word *taclash*: they are of considerable size; often of slaty and purple-grey colours, and might be termed stag-goats and ox-goats. Of these one or more occur in the hunting-scenes on Egyptian monuments, and therefore we may conclude that the skins were accessible in abundance, and may have been dressed with the hair on for coverings of baggage, and for boots, such as we see worn by the human figures in the same processions. Thus we have the greater number of the conditions of the question sufficiently realized to enable us to draw the inference that *tachash* refers to a ruminant of the Aigocerine or Damaline groups, most likely of an iron-grey or slaty-coloured species.—C. H. S.

BAG, a purse or pouch (Deut. xxv. 13; Job xiv. 17; 1 Sam. xvii. 40; Luke xii. 33). The money deposited in the treasuries of Eastern princes, or intended for large payments, or to be sent to a government as taxes or tribute, is collected in long, narrow bags or purses, each containing a certain amount of money, and sealed with the official seal. As the money is counted for this purpose, and sealed with great care by

officers properly appointed, the bag, or purse, passes current, as long as the seal remains unbroken, for the amount marked thereon. In the receipt and payment of large sums, this is a great and important convenience in countries where the management of large transactions by paper is unknown, or where a currency is chiefly or wholly of silver: it saves the great trouble of counting or weighing loose money. This usage is so well established, that, at this day, in the Levant, 'a purse' is the very name for a certain amount of money (now five pounds sterling), and all large payments are stated in 'purses.' The antiquity of this custom is attested by the monuments of Egypt, in which the ambassadors of

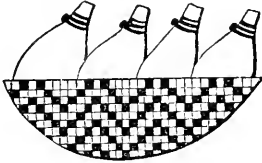

distant nations are represented as bringing their tributes in sealed bags of money to Thothmes III.; and we see the same bags deposited intact in the royal treasury. When coined money was not used, the seal must have been considered a voucher not only for the amount, but for the purity of the metal. The money collected in the Temple, in the time of Joash, seems to have been made up into bags of equal value after this fashion; which were probably delivered, sealed, to those who paid the workmen (2 Kings xii. 10; comp. also 2 Kings v. 23; Tobit ix. 5; xi. 16).

BAHURIM, a place not far from Jerusalem, beyond the Mount of Olives, on the road to the Jordan, where Shimei cursed and threw stones at David (2 Sam. xvi. 5; Joseph. *Antiq.* vii. 9. 7).

BALAAM (בְּלָעַם; Sept. and Philo, Βαλαάμ; Josephus, Βάλαμος). The name is derived by Vitringa from בָּעַל and עַם, *lord of the people*; but by Simonis from בָּלַעַם and עַם, *destruction of the people*—an allusion to his supposed supernatural powers. His father's name בעור comes likewise from a root which means *to consume or devour*. It is deserving of notice that בָּלַעַם, the first king of the Edomites, was also the son of a בעור (Gen. xxxvi. 32). In 2 Peter ii. 15, Balaam is called the Son of Bosor, which Gesenius attributes to an early corruption of the text, but Dr. Lightfoot considers it to be a Chaldaism, and infers from the Apostle's use of it, that he was then resident at Babylon. (Works, vol. vii. p. 80: *Sermon on the way of Balaam*.) In the other passage of the New Testament (Rev. ii. 14, 15), the sect of the Nicolaitans is described as following the doctrine or teaching of Balaam; and it appears not improbable that this name is employed symbolically, as Νικόλαος, Nicolaus, is equivalent in meaning to Balaam. The first mention of this remarkable person is in Numbers xxii. 5, where we are informed that Balak 'sent messengers unto Balaam the son of Beor to Pethor, which is by the river of the land of the children of his people.' Twelve Hebrew MSS. examined by Dr. Kennicott, two of De Rossi's, the Sama-

ritan text, with the Syriac and Vulgate versions, instead of בני עמון 'children of his people,' read בני עמון 'children of Ammon.' This is approved by Houbigant and Kennicott, but is inconsistent with Deut. xxiii. 4, which informs us that Pethor was in Mesopotamia; for the Ammonites, as Rosenmüller observes, never extended so far as the Euphrates, which must be the river alluded to. If the received reading be correct, it intimates that Pethor was situated in Balaam's native country, and that he was not a mere sojourner in Mesopotamia, as the Jewish patriarchs were in Canaan. In Joshua xiii. 22, Balaam is termed 'the Soothsayer' בְּסוֹף, a word which, with its cognates, is used almost without exception in an unfavourable sense. Josephus calls him μάντις ἀριστος, an eminent diviner (*Antiq.* iv. 6. § 2); and what is to be understood by this appellation, may be perhaps best learned from the following description by Philo:—'There was a man at that time celebrated for divination, who lived in Mesopotamia, and was an adept in all the forms of the divining art; but in no branch was he more admired than in augury; to many persons and on many occasions he gave great and astounding proofs of his skill. For to some he foretold storms in the height of summer; to others drought and heat in the depth of winter; to some scarcity succeeding a fruitful year, and then again abundance after scarcity; to others the overflowing and the drying up of rivers; and the remedies of pestilential diseases, and a vast multitude of other things, each of which he acquired great fame for predicting' (*Vita Moysis*, § 48). Origen speaks of Balaam as famous for his skill in magic, and the use of noxious incantations, but denies that he had any power to bless, for which he gives the following reason:—'*Ars enim magica nescit benedicere quia nec demones sciunt benefacere.*' (*In Num. Hom.* xiii.) Balak's language, 'I wot he whom thou blessest is blessed' (Numb. xxii. 6), he considers as only designed to flatter Balaam, and render him compliant with his wishes.

Of the numerous paradoxes which we find in 'this strange mixture of a man,' as Bishop Newton terms him, not the least striking is that with the practice of an art expressly forbidden to the Israelites, ('there shall not be found among you one that useth divination (קְסָמִים קְסָמִים, Deut. xviii. 10), for all that do these things are an abomination to the Lord'—ver. 12) he united the knowledge and worship of Jehovah, and was in the habit of receiving intimations of his will: 'I will bring you word again as the Lord (Jehovah) shall speak unto me' (Num. xxii. 8). The inquiry naturally arises, by what means did he become acquainted with the true religion? Dr. Hengstenberg suggests that he was led to renounce idolatry by the reports that reached him of the miracles attending the Exodus; and that having experienced the deceptive nature of the soothsaying art, he hoped by becoming a worshipper of the God of the Hebrews, to acquire fresh power over nature, and a clearer insight into futurity. Yet the sacred narrative gives us no reason to suppose that he had any previous knowledge of the Israelites. In Num. xxii. 11, he merely repeats Balak's message, 'Behold there is a people come out of Egypt, &c., without intimating that he had heard of the miracles wrought on their behalf. The allusion in Num.

xxii. 22 might be prompted by the divine afflatus which he then felt. And had he been actuated, in the first instance, by motives of personal aggrandizement, it seems hardly probable that he would have been favoured with those divine communications with which his language in Num. xxii. 8 implies a familiarity. Since, in the case of Simon Magus, the offer to 'purchase the gift of God with money' (Acts viii. 20) called forth an immediate and awful rebuke from the Apostles, would not Balaam's attempt to obtain a similar gift with a direct view to personal emolument and fame have met with a similar repulse?—Dr. H. supposes, indeed, that there was a mixture of a higher order of sentiments, a sense of the wants of his moral nature, which led him to seek Jehovah, and laid a foundation for intercourse with him. In the absence of more copious and precise information, may we not reasonably conjecture that Jacob's residence for twenty years in Mesopotamia contributed to maintain some just ideas of religion, though mingled with much superstition? To this source and the existing remains of Patriarchal religion, Balaam was probably indebted for that truth which he unhappily 'held in unrighteousness' (Rom. i. 18).

On the narrative contained in Numbers xxii. 22-35 a difference of opinion has long existed, even among those who fully admit its authenticity. The advocates for a literal interpretation urge, that in a historical work and a narrative bearing the same character, it would be unnatural to regard any of the occurrences as taking place in vision, unless expressly so stated;—that it would be difficult to determine where the vision begins, and where it ends;—that Jehovah's 'opening the mouth of the ass' (Num. xxii. 28) must have been an external act; and, finally, that Peter's language is decidedly in favour of the literal sense: ὑποζύγιον ἄφωνον, ἐν ἀνθρώπου φωνῇ φθεγγόμενον ἐκώλυσε τὴν τοῦ προφήτου παραφρονίαν.—The dumb ass, speaking with a man's voice, reproved the madness of the Prophet' (2 Peter ii. 16). Those who conceive that the speaking of the ass and the appearance of the Angel occurred in vision to Balaam (among whom are Maimonides, Leibnitz, and Hengstenberg) insist upon the fact that dreams and visions were the ordinary methods by which God made himself known to the Prophets (Num. xii. 6); they remark that Balaam, in the introduction to his third and fourth prophecies (xxiv. 3, 4, 15), speaks of himself as 'the man who had his eyes shut' (חָשַׁתְּ = חָשַׁתְּ וְחָשַׁתְּ, v. Lam. iii. 8), and who, on falling down in prophetic ecstasy, had his eyes opened;—that he expressed no surprise on hearing the ass speak; and that neither his servants nor the Moabitish princes who accompanied him appear to have been cognizant of any supernatural appearance. Dr. Jortin supposes that the Angel of the Lord suffered himself to be seen by the beast, but not by the Prophet; that the beast was terrified, and Balaam smothered, and then fell into a trance, and in that state conversed first with the beast and then with the Angel. The Angel presented these objects to his imagination as strongly as if they had been before his eyes, so that this was still a miraculous or preternatural operation. In dreaming, many singular incongruities occur without exciting our

astonishment; it is therefore not wonderful if the Prophet conversed with his beast in vision, without being startled at such a phenomenon (v. Jortin's 'Dissertation on Balaam,' pp. 190-194).

The limits of this article will not allow of an examination of Balaam's magnificent prophecies, which, as Herder remarks (*Geist der Hebräischen Poesie*, ii. 221), 'are distinguished for dignity, compression, vividness, and fulness of imagery: there is scarcely anything equal to them in the later Prophets, and' (he adds, what few readers, probably, of Deut. xxxii. xxxiii. will be disposed to admit) 'nothing in the discourses of Moses.' We must refer on this subject to Bishop Newton and Dr. Hengstenberg. The latter writer has ably discussed the doubts raised by Dr. de Wette and of other German critics, respecting the antiquity and genuineness of this portion of the Pentateuch. (Dr. Jortin's *Six Dissertations*, Lond. 1755, pp. 171-194; Bishop Butler's *Sermons on the Rolls' Chapel*, Sermon vii. Bishop Newton *On the Prophecies*, vol. i. ch. 5. *Discours Historiques*, &c., par M. Saurin, Amst. 1720, tome ii. *Disc.* 64. *Die Geschichte Bileams und seine Weissagungen erläutert*, von E. W. Hengstenberg, 1842. *Origenes Opera*, Berl. 1840, tom. x. pp. 168-258.)—J. E. R.

BALADAN. [MERODACH-BALADAN.]

BALAK (בָּלָאֵק, empty; Sept. Βαλάκ), son of Zippor, and king of the Moabites (Num. xxii. 2, 4), who was so terrified at the approach of the victorious army of the Israelites, who in their passage through the desert had encamped near the confines of his territory, that he applied to Balaam, who was then reputed to possess great influence with the higher spirits, to curse them. The result of this application is related under another head [BALAAM]. From Judg. xiv. 25, it is clear that Balak was so certain of the fulfilment of Balaam's blessing, 'blessed is he that blesseth thee, and cursed is he that curseth thee' (Num. xxiv. 9), that he never afterwards made the least military attempt to oppose the Israelites (comp. Mic. vi. 5; Rev. ii. 14).—E. M.

BALANCE. [WEIGHING.]

BALDNESS (כַּלְדָּה) may be artificial or natural. Artificial baldness, caused by cutting or shaving off the hair of the head, a custom among all the ancient and Eastern nations, in token of mourning for the death of a near relative (Jer. xvi. 6; Amos viii. 10; Micah i. 16), Moses forbade to the Israelites (Deut. xiv. 1), probably for the very reason of its being a heathen custom; for a leading object of his policy was to remove the Jews as far as possible from the ways and customs of the surrounding nations. Natural baldness, though Moses did not consider it as a symptom of leprosy, and declared the man afflicted with it to be clean and sound (Lev. xiii. 40, sq.), yet was always treated among the Israelites with contempt (*ibid.*), and a bald man was not infrequently exposed to the ridicule of the mob (2 Kings ii. 3; Isa. iii. 17; comp. Suet. *Cæs.* 45; *Domit.* 18); perhaps from the suspicion of being under some leprous taint, as the Hebrew word כַּלְדָּה originally implied an ulcer, or an ulcered person. The public prejudice thus entertained against a bald-headed man was perhaps the main reason why he was declared unfit

for the priestly office (Lev. xxi. 20; *Mishn. tit. Bechoroth*, vii. 2).—E. M.

BANQUETS. The entertainments spoken of in Scripture, on however large a scale, and of however sumptuous a character, were all provided at the expense of one individual; the *ἐπάδος* of the Greeks, to which every guest present contributed his proportion, being apparently unknown to the Jews, or at least practised only by the humbler classes, as some suppose that an instance of it occurs in the feast given to our Lord, shortly before his Passion, by his friends in Bethany (Matt. xxvi. 2; Mark xiv. 1: comp. with John xii. 2). Festive meetings of this kind were held only towards the close of the day, as it was not till business was over that the Jews freely indulged in the pleasures of the table; and although in the days of Christ these meals were, after the Roman fashion, called *suppers*, they corresponded exactly to the dinners of modern times, the hour fixed for them varying from five to six o'clock P.M., or sometimes later.

On occasions of ceremony the company were invited a considerable time previous to the celebration of the feast; and on the day and at the hour appointed, an express by one or more servants, according to the number and distance of the expected guests, was despatched to announce that the preparations were completed, and that their presence was looked for immediately (Matt. xxii. 8; Luke xiv. 17). (Grotius, *in loc.*; also Morier's *Journey*, p. 73.) This custom obtains in the East at the present day; and the second invitation, which is always verbal, is delivered by the messenger in his master's name, and frequently in the very language of Scripture: 'Behold I have prepared my dinner; my oxen and fatlings are killed, and all things are ready' (Matt. xxii. 4). It is observable, however, that this after-summons is sent to none but such as have been already invited, and have declared their acceptance; and, as in these circumstances, people are bound by every feeling of honour and propriety to postpone all other engagements to the duty of waiting upon their entertainer, it is manifest that the vehement resentment of the grandee in the parable of the great supper, where each of the guests is described as offering to the bearer of the express some frivolous apologies for absence, was, so far from being harsh and unreasonable, as infidels have characterized it, fully warranted and most natural according to the manners of the age and country. By accepting his invitation they had given a pledge of their presence, the violation of which on such trivial grounds, and especially after the liberal preparations made for their entertainment, could be viewed in no other light than as a gross and deliberate insult.

At the small entrance door a servant was stationed to receive the tablets or cards of those who were expected; and as curiosity usually collected a crowd of troublesome spectators, anxious to press forward into the scene of gaiety, the gate was opened only so far as was necessary for the admission of a single person at a time, who, on presenting his invitation ticket, was conducted through a long and narrow passage into the receiving-room; and then, after the whole company were assembled, the master of the house shut the door with his own hands—a signal to the servant to allow himself to be prevailed on neither

by noise nor by importunities, however loud and long continued, to admit the bystanders. To this custom there is a manifest reference in Luke xiii. 24, and Matt. xxv. 10 (Morier's *Journey*, p. 112).

One of the first marks of courtesy shown to the guests, after saluting the host, was the refreshment of water and fragrant oil or perfumes; and hence we find our Lord complaining of Simon's omission of these customary civilities (Luke vii. 41; see also Mark vii. 4) [*ANointing*]. But a far higher, though necessarily less frequent attention paid to their friends by the great, was the custom of furnishing each of the company with a magnificent habit of a light and showy colour, and richly embroidered, to be worn during the festivity (Eccles. ix. 8; Rev. iii. 4, 5). The loose and flowing style of this gorgeous mantle made it equally suitable for all; and it is almost incredible what a variety of such sumptuous garments the wardrobes of some great men could supply to equip a numerous party. In a large company, even of respectable persons, some might appear in a plainer and humbler garb than accorded with the taste of the voluptuous gentry of our Lord's time; and where this arose from necessity or limited means, it would have been harsh and unreasonable in the extreme to attach blame, or to command his instant and ignominious expulsion from the banquet-room. But where a well-appointed and sumptuous wardrobe was opened for the use of every guest,—to refuse the gay and splendid costume which the munificence of the host provided, and to persist in appearing in one's own habiliments, implied a contempt both for the master of the house and his entertainment, which could not fail to provoke resentment—and our Lord therefore spoke in accordance with a well-known custom of his country, when, in the parable of the marriage of the king's son, he describes the stern displeasure of the king on discovering one of the guests without a wedding garment, and his instant command to thrust him out (Matt. xxii. 11). At private banquets the master of the house of course presided, and did the honours of the occasion; but in large and mixed companies it was anciently customary to elect a governor of the feast (John ii. 8; see also Eccles. xxxii. 1), who should not merely perform the office of chairman, ἀρχιτροίκλιος, in preserving order and decorum, but take upon himself the general management of the festivities. As this office was considered a post of great responsibility and delicacy, as well as honour, the choice which among the Greeks and Romans was left to the decision of dice, was more wisely made by the Jews to fall upon him who was known to be possessed of the requisite qualities—a ready wit and convivial turn, and at the same time firmness of character and habits of temperance [*ARCHITROICLINUS*]. The guests were scrupulously arranged according to their respective ranks. This was done either by the host or governor, who, in the case of a family, placed them according to seniority (Gen. xlii. 33), and in the case of others, assigned the most honourable a place near his own person; or it was done by the party themselves, on their successive arrivals, and after surveying the company, taking up the position which it appeared fittest for each according to their respective claims to occupy. It might be expected that among the Orientals, by whom the

laws of etiquette in these matters are strictly observed, many absurd and ludicrous contests for precedence must take place, from the arrogance of some and the determined perseverance of others to wedge themselves into the seat they deem themselves entitled to. Accordingly Morier, who is well acquainted with the manners of the Persians, informs us, 'that it is easy to observe by the countenances of those present, when any one has taken a higher place than he ought.' 'On one occasion,' he adds, 'when an assembly was nearly full, the governor of Kashan, a man of humble mien, came in, and had seated himself at the lowest place, when the host, after having testified his particular attentions to him by numerous expressions of welcome, pointed with his hand to an upper seat, which he desired him to take' (*Second Journey*). As a counterpart to this, Dr. Clarke states that 'at a wedding feast he attended in the house of a rich merchant at St. Jean d'Acre, two persons who had seated themselves at the top were noticed by the master of ceremonies, and obliged to move lower down' (see also Joseph, *Antiq.* xv. 2). The knowledge of these peculiarities serves to illustrate several passages of Scripture (Prov. xxv. 6, 7; Matt. xxiii. 6; and especially Luke xiv. 7, where we find Jesus making the unseemly ambition of the Pharisees the subject of severe and merited animadversion). That class were notoriously eager to occupy the chief seats of honour when mingling in society with their fellow-citizens. Some unequivocal symptoms of such contention our Lord had probably witnessed in the house of the opulent Pharisee with whom he was dining, and if He himself were sitting at the lower part of the table, the reproof of their pride and foolish ambition, conveyed in the parable He delivered on that occasion, would be the more pointed and severely felt.

It would be difficult within a short compass to describe the form and arrangements of the table, as the entertainments spoken of in Scripture were not all conducted in a uniform style. In ancient Egypt, as in Persia, the tables were ranged along the sides of the room, and the guests were placed with their faces towards the walls. Persons of high official station were honoured with a table apart for themselves at the head of the room; and in these particulars every reader of the Bible will trace an exact correspondence to the arrangements of Joseph's entertainment to his brethren. According to Lightfoot (*Exercit. on John* xiii. 23), the tables of the Jews were either wholly uncovered, or two-thirds were spread with a cloth, while the remaining third was left bare for the dishes and vegetables. In the days of our Lord the prevailing form was the triclinium, the mode of reclining at which is described elsewhere [ACCUBATION]. This effeminate practice was not introduced until near the close of the Old Testament history, for amongst all its writers prior to the age of Amos עָשׂוּ, *to sit*, is the word invariably used to describe the posture at table (1 Sam. xvi., margin, and Ps. cxxviii. 3, implying that the ancient Israelites sat round a low table, cross-legged, like the Orientals of the present day), whereas *ἀνακλίω*, signifying a recumbent posture, is the word employed in the Gospel. And whenever the word 'sit' occurs in the New Testament, it ought to be translated 'lie,' according to the universal practice of that age.

The convenience of spoons, knives, and forks being unknown in the East, or, where known, being a modern innovation, the hand is the only instrument used in conveying food to the mouth, and the common practice, their food being chiefly prepared in a liquid form, is to dip their thin water-like bread in the dish, and folding it between their thumb and two fingers, enclose a portion of the contents. It is not uncommon to see several hands plunged into one dish at the same time. But where the party is numerous, the two persons near or opposite are commonly joined in one dish; and accordingly, at the last Passover, Judas, being close to his master, was pointed out as the traitor by being designated as the person 'dipping his hand with Jesus in the dish.' The Apostle John, whose advantageous situation enabled him to hear the minutest parts of the conversation, has recorded the fact of our Lord, in reply to the question, 'Who is it?' answering it by 'giving a sop to Judas when he had dipped' (John xiii. 27); and this leads us to mention it as not the least among the peculiarities of Oriental manners, that a host often dips his hand into a dish, and lifting a handful of what he considers a dainty, offers the *ψωλον* or sop to one of his friends. However the fastidious delicacy of a European appetite might revolt at such an act of hospitality, it is one of the greatest courtesies that an Oriental can show, and to decline it would be a violation of propriety and good manners (see Jowett's *Christian Researches*). In earlier ages, a double or a more liberal portion, or a choice piece of cookery, was the form in which a landlord showed his respect for the individual he delighted to honour (Gen. xliii. 34; 1 Sam. i. 4; ix. 23; Prov. xxxi. 15; see Voller's *Grec. Antiq.* ii. 387; Forbes, *Orient. Mem.* iii. 187).

While the guests reclined in the manner described above, their feet, of course, being stretched out behind, were the most accessible parts of their person, and accordingly the woman with the alabaster-box of ointment could pay her grateful and reverential attentions to Jesus without disturbing him in the business of the table. Nor can the presence of this woman, uninvited and unknown even as she was to the master of the house, appear at all an incredible or strange circumstance, when we consider that entertainments are often given in gardens, or in the outer courts, where strangers are freely admitted, and that Simon's table was in all likelihood as accessible to the same promiscuous visitors as are found hovering about at the banquets and entering into the houses of the most respectable Orientals of the present day (Forbes, *Orient. Mem.*). In the course of the entertainment servants are frequently employed in sprinkling the head and person of the guests with odoriferous perfumes, which, probably to counteract the effects of too copious perspiration, they use in great profusion, and the fragrance of which, though generally too strong for Europeans, is deemed an agreeable refreshment (see Ps. xlv. 8; xxiii. 5; cxxxiii. 2).

The various items of which an Oriental entertainment consists, bread, flesh, fish, fowls, melted butter, honey, and fruits, are in many places set on the table at once, in defiance of all taste. They are brought in upon trays—one, containing several dishes, being assigned to a

group of two, or at most three, persons, and the number and quality of the dishes being regulated according to the rank and consideration of the party seated before it. In ordinary cases four or five dishes constitute the portion allotted to a guest; but if he be a person of consequence, or one to whom the host is desirous of showing more than ordinary marks of attention, other viands are successively brought in, until, if every vacant corner of the tray is occupied, the bowls are piled one above another. The object of this rude but liberal hospitality is, not that the individual thus honoured is expected to surfeit himself by an excess of indulgence in order to testify his sense of the entertainer's kindness, but that he may enjoy the means of gratifying his palate with greater variety; and hence we read of Joseph's displaying his partiality for Benjamin by making his 'mess five times so much as any of theirs' (Gen. xliii. 34). The shoulder of a lamb, roasted, and plentifully besmeared with butter and milk, is regarded as a great delicacy still (Buckingham's *Travels*, ii. 136), as it was also in the days of Samuel. But according to the favourite cookery of the Orientals, their animal food is for the most part cut into small pieces, stewed, or prepared in a liquid state, such as seems to have been the 'broth' presented by Gideon to the angel (Judg. vi. 19). The made-up dishes are 'savoury meat,' being highly seasoned, and bring to remembrance the marrow and fatness which were esteemed as the most choice morsels in ancient times. As to drink, when particular attention was intended to be shown to a guest, his cup was filled with wine till it ran over (Ps. xxiii. 5), and it is said that the ancient Persians began their feasts with wine, whence it was called 'a banquet of wine' (Esther v. 6).

The hands, for occasionally both were required, besmeared with grease during the process of eating, were anciently cleaned by rubbing them with the soft part of the bread, the crumbs of which, being allowed to fall, became the portion of dogs (Matt. xv. 27; Luke xvi. 21). But the most common way now at the conclusion of a feast is for a servant to go round to each guest with water to wash, a service which is performed by the menial pouring a stream over their hands, which is received into a strainer at the bottom of the basin. This humble office Elisha performed to his master (2 Kings iii. 11).

People of rank and opulence in the East frequently give public entertainments to the poor. The rich man in the parable, whose guests disappointed him, despatched his servants on the instant to invite those that might be found sitting by the hedges and the highways—a measure which, in the circumstances, was absolutely necessary, as the heat of the climate would spoil the meats long before they could be consumed by the members of his own household. But many of the great, from benevolence or ostentation, are in the habit of proclaiming set days for giving feasts to the poor; and then, at the time appointed, may be seen crowds of the blind, the halt, and the maimed bending their steps to the scene of entertainment. This species of charity claims a venerable antiquity. Our Lord recommended his wealthy hearers to practise it rather than spend their fortunes, as they did, on luxurious living (Luke xiv. 12); and as such invi-

tations to the poor are of necessity given by public proclamation, and female messengers are employed to publish them (Hasselquist saw ten or twelve thus perambulating a town in Egypt), it is probably to the same venerable practice that Solomon alludes in Prov. ix. 3.—R. J.

BAPTISM. A conviction of the holiness of God excites in man the notion that he cannot possibly come into any amicable relation with him before he is cleansed of sin, which separates him from God. This sentiment found a very widely extended symbolic expression in the lustrations which formed an essential part of the ceremonial creeds of the ancient nations. These lustrations were prevalent not only among the heathen nations, more especially those of the southern climates, such as the Indians, Egyptians, Greeks, and Romans (comp. Wetstein, *Nov. Test. Evang. Matth.* iii. 6), but also among the Jews. With these latter they were preparations for divine services of a different nature, and even for private prayer (Judith xii). They formed a part of the offering-service, and more especially of the sin-offering (Lev. xvi.); and for that reason they usually established the prayer-houses (*προσευχαι*) in the vicinity of running waters (comp. Kainoel, *ad Act.* xvi. 13). Josephus (*Antiq.* xviii. 1. 5) gives an account of the manifold lustrations of the Essenes. In the language of the prophets, cleansing with water is used as an emblem of the purification of the heart, which in the Messianic age is to glorify the soul in her innermost recesses, and embrace the whole of the theocratic nation (Ezek. xxxvi. 25, sq.; Zech. xiii. 1). Such declarations gave rise to or nourished the expectation that the advent of the Messiah would manifest itself by a preparatory lustration, by which Elijah or some other great prophet would pave the way for him. This supposition lies evidently at the bottom of the questions which the Jews put to John the Baptist (John i. 25; comp. Matt. and Luke, iii. 7), whether he was the Messiah, or Elijah, or some other prophet? and if not, why he undertook to baptize? (comp. Schneckenberger, *Ueber das Alter der Jüdischen Proselytentaufe*, § 41, sq.). Thus we can completely clear up the historical derivation of the rite, as used by John and Christ, from the general and natural symbol of baptism, from the Jewish custom in particular, and from the expectation of a Messianic consecration. Danz, Ziegler, and others have, nevertheless, supposed it to be derived from the Jewish ceremonial of baptizing *proselytes*; and Wetstein has traced that rite up to a date earlier than Christianity. But this opinion is not at all tenable: for, as an act which strictly gives *validity* to the admission of a proselyte, and is no mere *accompaniment* to his admission, baptism certainly is not alluded to in the New Testament; while, as to the passages quoted in proof from the classical (profane) writers of that period, they are all open to the most fundamental objections. Nor is the utter silence of Josephus and Philo on the subject, notwithstanding their various opportunities of touching on it, a less weighty argument against this view. It is true that mention is made in the Talmud of that regulation as already existing in the first century A.D.; but such statements belong only to the traditions of the Gemara, and require careful investigation before they can serve as

proper authority. This Jewish rite was probably originally only a purifying ceremony; and it was raised to the character of an initiating and indispensable rite co-ordinate with that of sacrifice and circumcision, only after the destruction of the Temple, when sacrifices had ceased, and the circumcision of proselytes had, by reason of public edicts, become more and more impracticable (comp. Schneckenb. *ib.*). E. G. Bengel (*Ueber d. Alter der Jüd. Pros. Tauf.* 1814) sees, in its original establishment only an act of initiation, which, though before the destruction of the Temple merely of an accidental character, had through John and Christ received a peculiar and solid basis. The view of De Wette (*De Morie Christ. Expiat.*), that this rite was transferred from Christianity to Judaism, Winer (*Real-wörterb.* art. "Proselyten") justly rejects as utterly improbable.

BAPTISM OF JOHN.—It was the principal object of John the Baptist to combat the prevailing opinion, that the performance of external ceremonies was sufficient to secure participation in the kingdom of God and his promises; he required repentance, therefore, (*βάπτισμα μετάνοίας*), as a preparation for the approaching kingdom of the Messiah. That he may possibly have baptized *heathens* also, seems to follow from his censuring the Pharisees for confiding in their descent from Abraham, while they had no share in his spirit: yet it should not be overlooked that this remark was drawn from him by the course of the argument (Matt. iii. 8, 9; Luke iii. 7, 8). Augusti (*Denkwürdigkeiten aus der Christl. Archäol.* vii. 30) it is true, advances a few counter-reasons, but they are easily refuted (comp. Schneckenb. l. i. § 37). We must, on the whole, assume that John considered the existing Judaism as a stepping-stone by which the Gentiles were to arrive at the kingdom of God in its Messianic form.

The relation of the baptism of John to the Christian baptism gave rise to a sharp controversy in the sixteenth century. Zwingle and Calvin were in favour of the essential equality of the two; while Luther, Melancthon, and the Catholic church (*Concil. Trident. Sess. vii.*) maintained the contrary. The only difference Calvin allowed was, that John baptized in the name of the *future* Messiah, while the apostles baptized in that of the Messiah *already come*. But this difference could be of little moment; the less so, since a step towards the manifestation of the Messiah was already made in the appearance of John himself (comp. John i. 31). On the other hand, Calvin considers the most important point of equality between the two to exist in the fact, that both include repentance and pardon of sin in the name of Christ. The general point of view, however, from which John contemplated the Messiah and his kingdom was that of the Old Testament, though closely bordering on Christianity. He regards, it is true, an alteration in the mind and spirit as an indispensable condition for partaking in the kingdom of the Messiah; still he looked for its establishment by means of conflict and external force, with which the Messiah was to be endowed; and he expected in him a Judge and Avenger, who was to set up outward and visible distinctions. It is, therefore, by no means a matter of indifference whether baptism be administered in the name of that Christ who floated before the mind of John,

or of the suffering and glorified One, such as the apostles knew him; and whether it was considered a preparation for a political, or a consecration into a spiritual theocracy (comp. Dr. Neander's *Leben Jesu Christi*, p. 57, sq.). John was so far from this latter view, so far from contemplating a purely spiritual development of the kingdom of God, that he even began subsequently to entertain doubts concerning Christ (Matt. xi. 2). Tertullian distinguishes the essential characteristics of the two baptisms in their spirit and nature. To that of John he ascribes the *negative character of repentance*, and to the Christian the *positive impartation of new life* (*De Bapt.* x. 11); a distinction which arises out of the relation of *law and gospel*, and is given in the words of the Baptist himself,—that he baptizes with water and unto repentance, while the greater one who was to come after him would baptize with the Holy Ghost (Matt. iii. 11; Luke iii. 16; John i. 25). John's baptism had not the character of an immediate, but merely of a preparatory consecration for the glorified theocracy (John i. 31). The apostles, therefore, found it necessary to re-baptize the disciples of John, who had still adhered to the notions of their master on that head (Acts xix.). To this apostolic judgment Tertullian appeals, and in his opinion coincide the most eminent teachers of the ancient church, both of the East and the West (comp. Augusti, l. l. p. 31).*

THE BAPTISM OF JESUS BY JOHN (Matt. iii. 13, sq.; Mark i. 9, sq.; Luke iii. 21, sq.; comp. John i. 19, sq.; the latter passage refers to a time after the baptism, and describes, ver. 32, the incidental facts attending it).—The baptism of Jesus, as the first act of his public career, is one of the most important events recorded in evangelical history: great difficulty is also involved in reconciling the various accounts given by the evangelists of that transaction, and the several points connected with it. To question the fact itself, not even the *negative criticism* of Dr. Strauss has dared. This is, however, all that has been conceded by that criticism, viz., the mere and bare fact 'that Christ was baptized by John,' while all the circumstances of the event are placed in the region of mythology or fiction.

Critical inquiry suggests the following questions:—

1. In what relation did Jesus stand to John before the baptism?
2. What object did Jesus intend to obtain by that baptism?
3. In what sense are we to take the miraculous incidents attending that act?

With regard to the first point, we might be apt to infer, from Luke and Matthew, that there had been an acquaintance between Christ and John even prior to the baptism; and that hence John declines (Matt. iii. 14) to baptize Jesus,

* Josephus (*Antiq.* xviii. 5. 2) gives a general character of John, tinctured, it is true, with some hellenistic notions, yet not contradictory to the gospels. He calls him 'a good man, who bade the Jews to be virtuous, just and devout, and so to come to his baptism; for in this way it would be accepted of God, if used, not for the blotting out of certain sins, but for purification of the body, supposing the soul to have been previously purified by righteousness.'

arguing that he needed to be baptized by him. This, however, seems to be at variance with John i. 31, 33. Lücke (*Comment.* i. p. 416, sq. 3rd edit.) takes the words 'I knew him not' in their strict and exclusive sense. John, he says, could not have spoken in this manner if he had at all known Jesus; and had he known him, he could not, as a prophet, have failed to discover, even at an earlier period, the but too evident 'glory' of the Messiah. In fact, the narrative of the first three Gospels presupposes the same, since, as the herald of the Messiah, he could give that refusal (Matt. iii. 14) to the Messiah alone. Lücke considers John as a sure authority; as for the contradiction in Luke, he makes less of it, regarding the whole narrative of the infancy to have only a secondary historical value; while the contradiction in Matthew he thinks to remove by giving to vers. 14, 15, a different place from that which they now occupy in the text; and, after the example of the Ebionitic revision of the Gospel according to the Hebrews, in Epiphanius (*Hæres.* xxx. 13), he puts these words into the mouth of John, only after Christ had been revealed to him to be the Messiah by means of the baptism (comp. also Schleiermacher, *Ueber die Schriften des Lucas*, p. 44). That such a compromise is forced, appears still more clearly by the remark of Neander (*Leben Jesu Christi*, p. 67), that the words, 'He forbade him,' and 'Suffer it to be so now,' naturally refer to Christ's descending into the water. Strauss (*Leb. Jesu*, i. 330, sq.) and De Wette (*ad Matth.* iii. 14) agree so far with Lücke, in admitting a contradiction between the Gospel of John and the other accounts. Strauss is of opinion that the three Gospels proceeded from the popular point of view, to designate the important relation of the two divine messengers as permanent or of long standing; while John had a different object in view, to found the acquaintance of both upon revelation. We may admit the truth of the latter part of this hypothesis, always bearing in mind that the fact to which John refers is historically true; but the first part is at variance with the silence which Matthew and Mark observe as to any early acquaintance, while Luke expressly brings only the mothers, and not the sons, into intercourse. There is more ground in the other objection, viz. how a prophet of John's developed character could, after the miraculous things that had passed, according to the accounts of the Gospels, begin to doubt as to the mission of Christ (Matt. xi. 2), especially after so short a period of observation. This difficulty has not escaped the notice of any sober critic; but in what we have stated at the outset concerning the theocratic views of John may easily be found the reason of his having afterwards entertained some doubts of Jesus. At all events, considering the scanty information we possess of John, we are not justified in resorting, like Strauss, to the conclusion, that because the narratives are at variance, therefore the accounts of the baptism, having for their object to extol John and Christ, must be a fiction (comp. Lücke).

Meyer (*ad Matth.* iii. 14), Neander (l. c. p. 65, sq.), and Winer (*Bibl. Real-wörterb.*, art. 'Johannes'), endeavour to explain the accounts of the baptism in favour of an earlier acquaintance between John and Jesus. Neander, for instance, maintains that John's disclaiming all knowledge of Jesus refers merely to his Messianic character,

while his refusal to baptize him proceeded merely from the impression of sublime sanctity which Jesus had made on his mind while he stood before him and prayed (Luke iii. 21). This view does not, however, remove the following difficulties:—

1. That the simple construction of the words of John (John i. 31, sq.) speaks more in favour of Lücke's interpretation.

2. That Luke's account of the early history of Christ does not receive even by this view its full validity, since, from his narrative, we can hardly help coming to the conclusion that John was acquainted with all the circumstances attendant on the birth of Christ, in which the latter was characterized as the Messiah, and that he had even often been in previous intercourse with him, so that there was hardly any fair reason for his doubting who the Messiah was; and,

3. That the prayer of Jesus (Luke iii. 21) cannot be alleged as a reason for John's declining to baptize him, since it took place subsequently to the baptism.

With regard to the second point at issue, as to the object of Christ in undergoing baptism, we find, in the first instance, that he ranked this action among those of his Messianic calling. This object is still more defined by John the Baptist (John i. 31), which Lücke interprets in the following words: 'Only by entering into that community which was to be introductory to the Messianic, by attaching himself to the Baptist like any other man, was it possible for Christ to reveal himself to the Baptist, and through him to others.' Christ, with his never-failing reliance on God, never for a moment could doubt of his own mission, or of the right period when his character was to be made manifest by God (Paulus, *Exeget. Handbuch*, i.; Hase, *Leben Jesu*, § 54); but John needed to receive that assurance, in order to be the herald of the Messiah who was actually come. For all others whom John baptized, either before or after Christ, this act was a mere preparatory consecration to the kingdom of the Messiah; while for Jesus it was a direct and immediate consecration, by means of which he manifested the commencement of his career as the founder of the new theocracy, which began at the very moment of his baptism, the initiatory character of which constituted its general principle and tendency. Strauss, however, neglecting this point, only dwells on that which was unsuitable for the Messiah in the baptism of John, according to the Gospels. Jesus, he says, could not possibly have considered himself as the Messiah, or it would have been simulation in him to take a part in the act of baptism, which was performed for the purpose of initiation into the future Messiah. He probably came, like others, with the intention of becoming a disciple of John, whose notions he first imbibed, but which he afterwards purified, and carried through according to his own plan, when the Baptist had already quitted the stage of action (comp. against this view, Neander, l. c. p. 61).

Another objection raised by Strauss is to be found among the Ebionites of the ancient church. Jerome (*Dial. adv. Pelag.* iii. 2) quotes the following fragment from a gospel of that sect: 'Ecce mater Domini et fratres ejus dicebant ei: Joannes baptista baptizat in remissionem peccatorum; eamus et baptizemur ab eo. Dixit autem illis: quid peccavi ut vadam et baptizemur ab eo?

N:si forte noc ipsum quod dixi ignorantia est.' This is also the opinion of Strauss, namely, that the partaking of βάπτισμα μετανόιας pre-supposes a participation in sin. In refutation of this, Neander (l. l. p. 64) argues that it would be absurd for Jesus to come to be baptized, because conscious of needing pardon of sin, and nevertheless afterwards profess to pardon sins himself. De Wette also thinks that the baptism of Christ must be founded, if not in *real* sin, at least in its *possibility*. If, by this possibility, he meant a disposition to sin, similar to the 'peccability' ascribed to him by Basilides, we must deny it in the Redeemer; nor does the history of the Temptation, which the advocates of this notion try to connect with it, prove anything in its favour. And if, by that possibility, he meant to imply the free principle which lies at the basis of the free will of man, neither can that constitute the ground for baptism.

With respect to the *miraculous incidents which accompanied the baptism of Jesus*, if we take for our starting-point the narration of the three Gospels, that the Holy Spirit really and visibly descended in the form of a dove, and proclaimed Jesus, in an audible voice, to be the Son of God, there can be no difficulty in bringing it to harmonize with the statement in the Gospel of John. This literal sense of the text has, indeed, for a long time been the prevailing interpretation, though many doubts respecting it had very early forced themselves on the minds of sober inquirers, traces of which are to be found in Origen (*Contr. Cels.* i. 48), and which Strauss (p. 376) has more elaborately renewed. To the natural explanations belong that of Paulus (*Exeg. Handb.*), that the dove was a *real* one, which had by chance flown near the spot at that moment; that of Meyer, that it was the figure of a meteor which was just then visible in the sky; and that of Kuinoel (*ad Matth.* iii.), who considers the dove as a figure for lightning, and the voice for that of thunder, which the eye-witnesses, in their extatic feelings, considered as a divine voice, such as the Jews called a *Bath-kol* (Meyer). Such interpretations are not only irreconcilable with the evangelical text, but even presuppose a violation of the common order of nature (comp. Strauss, p. 376, sq.), in favour of adherence to which these interpretations are advanced: it is not to be wondered at, therefore, that they have met with due ridicule from the last-mentioned critic. The conjecture of Schulthess, who proposes to read *ὡς περιπτεράς*, is ungrammatical and improbable, and hardly deserves notice.

A more close investigation of the subject, however, induces us to take as a starting-point the account of the apostle St. John. It is John the Baptist himself who speaks. He was an eye-witness, nay, to judge from Matthew and John, the only one present with Jesus, and is consequently the only source—with or without Christ—of information. Indeed, if there were more people present, as we are almost inclined to infer from Luke, they cannot have perceived the miracles attending the baptism of Jesus, or John and Christ would no doubt have appealed to their testimony in verification of them. (Comp. Schleiermacher, p. 43.)

In thus taking the statement in St. John for the authentic basis of the whole history, a few slight hints in it may afford us the means of solving the

difficulties attending the *literal* conception of the text. John the Baptist knows nothing of an external and audible voice, and when he assures us (i. 33) that he had in the Spirit received the promise, that the Messiah would be made manifest by the Spirit descending upon him, and *remaining*—be it upon or in him—there; this very *remaining* assuredly precludes any material appearance in the shape of a bird. The internal probability of the text, therefore, speaks in favour of a spiritual vision in the mind of the Baptist; this view is still more strengthened by the fact, that Luke supposes there were many more present, who notwithstanding perceived nothing at all of the miraculous incidents. The reason that the Spirit in the vision assumed the figure of a dove, we would rather seek in the peculiar flight and movement of that bird, than, as Strauss and De Wette think, in its form and shape. Lücke and Neander find the resemblance in the swift flight of the dove; Winer, however (l. c. art. 'Taube'), in its rapid and straight movement. The image moreover was suited to the poetic character of the beholder, and it is probable, though not necessary, that the recollection of Gen. i. 2, where the Spirit of God is described as soaring over the waters, might have contributed to raise in the mind of the Baptist that image; neither is it *necessary* here to bear in mind the speculations of the Rabbins concerning the verse in Gen. (comp. Wetstein, *ad Matth.* iii.; Schöttgen, *Hor. Hebr.* i.), since all these are of a later date than the words of John, whose turn of mind and education were besides quite opposed to Rabbinism.

In a similar way is this event explained, without denying the divine operation upon the mind of the Baptist, by Origen (l. c.), Theodorus Mopsuest. (in Lücke, p. 423), 'according to a sort of spiritual contemplation. . . . to John alone:—for the appearance was a vision, not a reality.' (Lücke; Neander; comp. also De Wette, *ad Matth.* iii.). This interpretation moreover has the advantage of exhibiting the philosophic connection of the incidents, since the Baptist appears more conspicuously as the immediate end of the divine dispensation (Neander). Christ had thus the intention of being introduced by him into the Messianic sphere of operation, while the Baptist recognizes this to be his own peculiar calling: the signs by which he was to know the Messiah had been intimated to him, and now that they had come to pass, the prophecy and his mission were fulfilled. Neander, therefore, considers the manifestation as merely *subjective* (or in the mind of John), while Julius Müller and Lücke suppose a real operation at the same time of the Spirit on Christ. In process of time tradition converted this vision into a sensible external phenomenon. Matthew (comp. De Wette), though he appears (ver. 17) to consider the fact as external, nevertheless, to judge from the phrase 'unto him' (ver. 16), which most probably refers to the Baptist, agrees with John, that the Baptist was the immediate end of that revelation. But to the less refined conception of Mark and Luke, it was natural to refer that revelation solely to Jesus as the principal personage. Luke shows himself particularly partial to the sensible form (*σοματικῶς εἶδει*). The more the Ebionitic view obscures the tradition, the more does it stray from the simple exposition of the Gospel of St. John.

Justin Martyr mentions an anecdote (*Dial. cont. Tryph.* § 88) ascribed to the apostles, according to which Christ was surrounded by flames of fire when standing in the Jordan, but when he was rising from the water the Holy Spirit descended upon him, while a voice uttered, besides the words mentioned in the Gospels, those of the 7th verse of the 2nd Psalm. By this it was intended to establish the spiritual birth of Christ only from the moment of his baptism, contrary to the apostolic reports concerning his birth. The same report is given in a still more pointed manner in an Ebionitic Fragm. (Epiphanius, xxx. 13), according to which a light shines around the place, while a voice addresses itself first to Jesus and next to the Baptist, who then falls at his feet. The Spirit, also, in the figure of a dove, not only descends upon him, but enters also into him (*ἐν εἶδει περιστερᾶς κατελθούσης καὶ εἰσελθούσης εἰς αὐτόν*). The notion that Christ was distinguished from the prophets in the Old Testament by the Holy Spirit remaining with him permanently, while with the former it was merely partial and momentary, is still more distinctly expressed in a fragment of the Gospels of the Nazarenes (Jerome, *Adv. Pelag.* iii. 2): 'Descendit fons omnis Spiritus sancti et requievit super eum et dixit: Fili mi, in omnibus Prophetis expectabam te ut venires et requiescerem in te. Tu es enim requies mea, tu es filius primigenitus, qui regnas in sempiternum.' However disfigured the fact may appear in these Apocrypha, the general and decided purport of the tradition with regard to the divine manifestation, assuredly leads back to an historical origin, which can nowhere be better or more successfully sought than in the depositions of the Baptist.

Strauss, in his obstinate scepticism, refuses, notwithstanding, to accept this view. He rejects the assumption of a mere vision in John i. 31, *sq.*, and sees in 'like a dove' nothing but a visible phenomenon; neither indeed does it suit his views to assume such a vision, since it would presuppose a momentary miraculous inspiration, a thing he is averse to acknowledge. But there is no necessity for taking 'like a dove' for anything else than an embodied symbol, and more especially as the simile is wanting in ver. 33 (Lücke); nor is there, in the momentary inspiration in that instance, anything so extraordinary as to compel us to look at the incident as a mere fiction: on the contrary, we consider the state of prophetic ecstasy, which is so common to the prophets in the Old Testament, to be quite in unison with the prophetic character of John.

Strauss maintains, moreover, that the imparting of the Spirit at his baptism, and the superhuman generation of Jesus, are two facts altogether at variance with each other. De Wette also thinks it impossible to understand both in their proper and full signification, and is of opinion that the fact that Christ was in possession of the Spirit is more certain to the Christian than the manner in which he received it. Lücke's reply to this (*Comment.* p. 433, *sq.*) is of importance. He thinks that John makes a decided distinction between the divine *logos* in its existence before it was incarnated, and the Spirit. The former is a *person*, of whom it may be said 'He was made flesh,' but not so of the Spirit, which stands in contrast to flesh, and constitutes the principle of communication

and manifestation to an already existing person. Jesus, having within himself the *logos* as the *divine subject*, was therefore capable of receiving the everlasting communication of the Spirit. As man, subject to human development, he stood in need of an external excitement and animation by God, such as took place at his baptism. It was, as Lücke thinks, one of those leading epochs, at which the ever-continued process of divine communication with mankind gives rise to new external developments.

This way of reconciling the two events is conceivable. On the other hand, those critics, who, like Neander and others, do not at all assume that there was any immediate operation of the Holy Spirit on Christ at the baptism, but consider all this as a mere development of the divine principle which was in him, do not need to make compromises in trying to reconcile the two events. According to their view, the Baptist saw in the resting of the Spirit on Christ, nothing but a necessary union of his own mission with that of Jesus; yet even so, we have to confine ourselves in this particular to the relation of John alone, since the other three Gospels, in connecting the baptism of Jesus with the history of his temptation, certainly seem to insinuate thereby a more powerful operation of the Spirit on Jesus. The advocates of the latter view may fairly refer to the fact that the difference that exists in the narrative of the baptism between the Three Gospels and that of John, is chiefly owing to their respective views with regard to the Messiah. The former rest their views of him more on the Old Testament: he is therefore *won* then a king and prophet acting in the name of God by whom he is anointed with the Holy Spirit and power (Acts x. 37), and becomes manifest through miracles, and is finally raised to divine majesty. Not so the more sublime conception of John in that matter: he sees in him the incarnated *logos*, the independent source of his divine manifestations, to the execution of which he wanted, it is true, such external calls as present themselves in the relations of practical life, but by no means a new communication of the Spirit. The doctrine of St. Paul, 'Son of God after the Spirit, Son of David after the flesh,' may be considered as the link between them. 'The canonical Gospels have not gone so far in discrepancy as to come into real conflict. The three first speak plainly of the superhuman generation of Christ; and all that can be imputed to them is that they do not lay so much stress on it as John does, and are not fully aware of its import.' Only the partial view of the Ebionites renders the subject quite irreconcilable.

CHRISTIAN BAPTISM.—Jesus, having undergone baptism as the founder of the new kingdom, ordained it as a legal act by which individuals were to obtain the rights of citizens therein. Though he caused many to be baptized by his disciples (John iv. 1, 2), yet *all* were not baptized who were converted to him; neither was it even necessary after they had obtained participation in him by his personal choice and forgiving of sin. But when he could no longer personally and immediately choose and receive members of his kingdom, when at the same time all had been accomplished which the founder thought necessary for its completion, he gave

power to the spiritual community to receive, in his stead, members by *baptism* (Matt. xxviii. 19; Mark xvi. 16). Baptism essentially denotes the regenerating of him who receives it, his participation both in the divine life of Christ and the promises rested on it, as well as his reception as a member of the Christian community.

Each of these momentous points implies all the rest; and the germ of all is contained in the words of Christ (Matt. xxviii. 19; comp. Neander, *History of the Planting*, &c. ii.). The details are variously digested by the Apostles according to their peculiar modes of thinking. John dwells—in like manner as he does on the holy communion—almost exclusively on the internal nature of baptism, the immediate mystical union of the Spirit with Christ; baptism is with him, equivalent to ‘being born again’ (John iii. 5, 7). Paul gives more explicitly and completely the other points also. He understands by it not only the union of the individual with the Head, by the giving one’s self up to the Redeemer and the receiving of his life (Gal. iii. 27), but also the union with the other members (*ib.* 28; 1 Cor. 12, 13; Ephes. iv. 5; v. 26). He combines the negative and positive points of regeneration, alike with the death and resurrection of Christ, and also with the sinking *in* and rising *up* at baptism (Rom. vi. 4, *sq.*; Col. ii. 12).

As regards the relation between the external and the internal, the normal condition of baptism required that the ceremony should be combined with regeneration in him who received it, while he who administered it should have a perfect knowledge of the state of the baptized, and should aim at strengthening and promoting the new life in him. There is no doubt that when Christ himself gave the assurance that he had received some one into his community, whether with or without baptism, such a declaration of his choice was met by the individual with a disposition already prepared to begin the new life. But the Church is not in a state of perfection, and being deficient both in knowledge and will, she cannot fix the moment of regeneration in order to combine with it the act of baptism. She nevertheless places both in a necessary mutual relation, and considers baptism only then complete when regeneration takes place; the Church therefore either delays baptism until after regeneration, or administers it beforehand, confiding in the assurance that the agency of the Church (animated by the spirit of Christ and directed in behalf of an individual who enters into a sort of preliminary connection with the Church by this act of baptism) will also produce in him regeneration, provided always that the individual has the *will* for it.

In the Apostolic times the Church was in a less mixed state; a comparatively large number, perhaps an actual majority, of the whole body of the baptized might at that time have passed for *converts*, as the inward and outward conditions of baptism were then not so far removed from each other as they afterwards became. The necessity of examining the comparative merits of both conditions separately grew with the growing imperfection of the community. The Apostles did not yet feel it; they considered both only in the light of their necessary union with each other, as Paul, for instance, says (Tit. iii. 5; comp. Mark xvi.

16) of the external symbol, what belongs only to the union of both. Traces of separation, however, were already perceptible in the apostolic age. Among the symptoms of the perfect union of the convert with the Redeemer, was one peculiar to that period alone, manifesting the new life externally by the extatic state of the individual in whom the Spirit of God had operated. It was usually wrought by the hands laid on the baptized to bless, as the concluding act of baptism. Sometimes, however, that extacy manifested itself independently of the external act of baptism (Acts x. 47); while baptism, on the other hand, was sometimes performed without the requisite proper inward sentiments of the baptized, and without the ‘gift of the Spirit’ (Acts viii. 13, 19). The words of Peter (Acts x. 47) taken in connection with the whole, mean, that the Spirit of God is not bound to external ceremony, but to inward union and fellowship by belief. To ascribe the promises to baptism without that inward union, would be making it an *opus operatum* and its efficacy a magic power; but, on the other hand, since the institution of Christ comprises also the external signs, it cannot be complete without them, and he who would abolish these external signs would deprive the Church of an essential tie of fellowship. The Catholic church rather favours the former doctrine, and a few mystical sects, the Quakers, &c., the latter.

INFANT BAPTISM was established neither by Christ nor the apostles. In all places where we find the necessity of baptism notified, either in a dogmatic or historical point of view, it is evident that it was only meant for those who were capable of comprehending the word preached, and of being converted to Christ by an act of their own will. A pretty sure testimony of its non-existence in the Apostolic age may be inferred from 1 Cor. vii. 14, since Paul would certainly have referred to the baptism of children for their holiness (comp. Neander, *Hist. of the Planting*, &c., i. p. 206). But even in later times, several teachers of the church, such as Tertullian (*De Bapt.* 18) and others, reject this custom; indeed, his church in general (that of North Africa) adhered longer than others to the primitive regulations. Even when baptism of children was already theoretically derived from the apostles, its *practice* was nevertheless for a long time confined to a maturer age.

In support of the contrary opinion, the advocates in former ages (now hardly any) used to appeal to Matt. xix. 14; but their strongest argument in its favour is the regulation of baptizing all the members of a house and family (1 Cor. xvi. 15; Acts xvi. 33; xviii. 8). In none of these instances has it been proved that there were little children among them; but, even supposing that there were, there was no necessity for excluding them from baptism in plain words, since such exclusion was understood as a matter of course. Many circumstances conspired early to introduce the practice of infant-baptizing. The confusion between the outward and inward conditions of baptism, and the magical effect that was imputed to it; confusion of thought about the visible and invisible church, condemning all those who did not belong to the former; the doctrine of the natural corruption of man so closely connected with the preceding; and, finally, the desire of distinguishing Christian children from the Jewish

and Heathen, and of commending them more effectually to the care of the Christian community—all these circumstances and many more have contributed to the introduction of infant baptism at a very early period.

But, on the other hand, the baptism of children is not at all at variance with the principle of Christian baptism in general, after what we have observed on the separation of regeneration and baptism. For, since it cannot be determined when the former begins, the real test of its existence lying only in the holiness continued to the end of man's life, the fittest point for baptism is evidently the beginning of life. Nevertheless, the profession of faith is still needed to complete it; Confirmation, or some equivalent observance, is therefore a very important consummation. The *fides infantium* is an absurd assumption, of which the Scriptures know nothing. On the other hand, the baptized child is strongly recommended to the community and to the Spirit of God dwelling therein, becoming the careful object of the education and holy influence of the Church (comp. 1 Cor. vii. 14). Nature and experience teach us, therefore, to retain the baptism of children, now that it is introduced.

To be admitted to baptism in the Apostolic age there needed no further development of Christian knowledge than a professed belief that Jesus was the promised Messiah. To be baptized in his name meant, to receive baptism in the belief that the power and dignity contained in the idea of a Messiah was realized in Jesus. The profession of faith (1 Pet. iii. 21) probably was such as to convey this idea; and next also the formula of baptism in the name of Christ, or, according to Matt. xxviii. 19, of the Father, Son, and Holy Ghost, when the whole body was immersed in water. Christ did not intend by these words to institute a fixed formula of baptism, but merely meant to indicate thereby the substance of the essential relations of baptism, since in his life-time people could not yet be baptized in the name of the Holy Ghost. As the Church, however, knew of no better compendary text for the article of faith, she declared herself early for that formula, which was already in general use at the time of Justin Martyr. To preface the act of baptism by minute instruction was impossible in a time when the preaching of the Gospel was as yet limited to but a very few. A brief sketch of the history of Christ, the central point of which was his death and resurrection, and a reference to the Old Testament, where he had been pre-announced by the prophets, were deemed sufficient at that time (comp. Neander, *Hist. of the Plant.; Hist. of the Church*, ii.; Acts ii. 19). The apostles either themselves baptized, of which there are many instances in the Acts, or charged others to do it, and confined themselves to the 'laying on of hands' on which followed the communication of the Spirit. The reason of this limitation is, no doubt, the same which actuated also Christ in not himself baptizing, viz. that they might be less interrupted in the task of preaching the Gospel. Paul had subsequently also another inducement for not doing so, not to be made the leader of a party (1 Cor. i. 14-16).

BAPTISM FOR THE DEAD.—Paul (1 Cor. xv. 29) uses this phrase. It is difficult, almost impossible, to arrive at a satisfactory and certain result as to his meaning, since neither he nor any

other authorities furnish us with the necessary data. Few passages have undergone more numerous and arbitrary emendations than this text. To give, however, some order to the numerous interpretations, we may in the first instance observe, that they all chiefly turn upon the question, whether the baptism here mentioned is the *general* church-baptism, or some *particular* one independent of the former. We shall examine, first—

A. *Those interpretations which take it to be some particular application of baptism.*

From the wording of the sentence, the most simple impression certainly is, that Paul speaks of a baptism which a living man receives in the place of a dead one. This interpretation is particularly adopted by those expounders with whom grammatical construction is of paramount importance, and the first thing to be considered.

Foremost among the older critics is Ambrose (Hilar.): 'In tantum natum et stabilem vult ostendere resurrectionem mortuorum, ut exemplum det eorum, qui tam securi erant de futura resurrectione, ut etiam pro mortuis baptizarentur, si quem forte mors prevenisset, timentes, ne aut male aut non resurgeret, qui baptizatus non fuerat; vivus nomine mortui tinguebatur.' Among the moderns are Erasmus, Scaliger, Grotius, Calixtus; and of the more recent the most considerable are Augusti (*Archaol.* iv.), Meyer (who understands *ἐπέφ.* = *to the advantage, in favour*, which may indeed well be the case), Billroth, and Rückert, who supposes that the Corinthians, convinced of the necessity and benefit of baptism, but erroneously considering it not as a symbol, but as a real means of purifying the heart itself, had taken it into their heads to give the benefit thereof also to the dead, by administering baptism to them by a substitute, a living person, and thus imagined that a *baptism by proxy* was practicable. De Wette considers this the only possible meaning of the words.

With regard to this interpretation, some doubt arises as to the real existence at that time of such a custom, since the only information respecting it would be this passage, though Rückert thinks this is sufficient evidence. It is true, that they refer to the Shepherd of Hermas (*Simil.* ix. 16); but all that can be inferred from it is, that they had at that time already begun to evince an overdue and extravagant respect for outward baptism. Tertullian (*Contr. Marcion.* v. 10) seems in a more direct way to speak of the existence of the custom: 'Noli apostolum novum statim auctorem aut confirmatorem ejus (institutionis) denotare, ut tanto magis sisteret carnis resurrectionem, quanto illi qui vane pro mortuis baptizarentur, fide resurrectionis hoc facerent. Habemus illum alicubi unius baptismi definitorem. Igitur et pro mortuis tingui pro corporibus est tingui; mortuum enim corpus ostendimus' (comp. *De Resurrect. Carn.* 48). Tertullian in these words distinguishes a false application of baptism by substitution, from the general one adhered to by the apostle; he thinks that the apostle confirms baptism *pro mortuis*, not in that erroneous but in a proper sense, compatible with his other and general views of baptism. Of that erroneous practice, however, Tertullian, in this as in the other place, evidently knows no more than what is indicated by Paul in the above passage; neither does he mention that such a custom had prevailed in his time among the Marcionites or any others (comp. Neander,

Hist. of the Church, i. 2, p. 523, sq., 3rd edit.). More certain information is given by Chrysostom, who relates of the Marcionites (*Homil.* 40, ad 1 Cor.) that when a catechumen died among them, a living person used to lay himself under the bed of the deceased, and answer in his stead the customary questions, after which the deceased was baptized. He says that they referred to the approval of St. Paul in the above passage. It is true that this absurd custom is certainly met with among the rough and superstitious Marcionites of later times, yet is it highly improbable, as Neander (*ut supra*) justly observes, that such a custom should ever have emanated from Marcion himself, who had entered more deeply into the spirit of the Pauline 'Faith' than any of his contemporaries.

A similar account is given by Epiphanius (*Hæres.* xxviii. 7) of the Gnostic sect of Cerinthus, who were much opposed to the Marcionites: 'In this country,—I mean, Asia,—and even in Galatia, their school flourished eminently; and a traditional fact concerning them has reached us, that when any of them had died without baptism, they used to baptize others in their name, lest in the resurrection they should suffer punishment as unbaptized.' We are not justified in denying credence to this statement, though there is just suspicion against Epiphanius from his total want of critical judgment, and his erroneous supposition that Paul was particularly combating the opinions of Cerinthus, a supposition which he applies also to the passage before us. In the *Concil. Carthagin.* a.d. 397, can. 6, and *Codec. Eccles. Afric.* can. 18, it is forbidden to administer baptism and the holy communion to the dead: 'cavendum est etiam, ne mortuos baptizari posse fratrum infirmitas credat, quoniam eucharistiam mortuis non dari animadvertit.' Here baptism *by proxy* is not alluded to, and we must therefore assume that the Councils had no ground for its prohibition, the custom having, as it seems, not then existed in those parts. Augusti (l. i. vii. p. 42) refers to the proselyte baptism of the Jews, where, he thinks, parents underwent the rite for their children. But all the authorities quoted in its favour by Lightfoot (ad *Math.* iii. 6) prove nothing as to *substitution*; and even if they did so, it would still be highly improbable that the Gentile churches would have adopted it from them (comp. Schneckengerber, l. i. p. 79).

All therefore we can infer from the above statements is, that baptism by substitution had taken place among the Marcionites, and perhaps also among the Cerinthians and other smaller sects towards the end of the fourth century, a period when the confused views of the Church as to the relations of the external to the spiritual might easily have favoured that erroneous custom; but that it existed between that period and the time when Paul wrote the above passage is wholly unsubstantiated. Is it possible to suppose that in the various quarters of the Church of which we have any information, no notice whatever should have been taken either by a synodical decree, or by a contemporary writer within that period, of a custom, which, the earlier it existed, must have appeared only so much the more offensive. Is it not therefore evident that if it is found 300 years afterwards, it was by no means a continuation of the primitive custom, but had arisen inde-

pendently of the latter, either in imitation of it, or from a mistaken interpretation of the Apostle in our passage?

The idea, then, that such a superstitious custom existed in the Corinthian community is devoid of all historical evidence; especially as the magical notions of baptism had as yet so little prevailed as not even to have given rise to infant baptism. Add to this, that the Corinthian church was far in advance of most others at that period in education and diffused knowledge, and that, in fact, their very striving for spiritual development threatened to lead them into onesidedness, and we must confess that the clearer the sense of the words becomes the more obscure becomes the thing itself.

The difficulties will still more increase, if we were to admit, with Olbansen, Rückert, and De Wette, that the Apostle approved of the absurd practice in question, since he would thus be brought into contradiction with his own principles on the importance of faith and external works, which he develops in his Epistle to the Galatians. Such a striking error could not have been a mere slip in Paul; it might therefore certainly give cause to suspect similar superstitious views in him. Even Ambrose (l. c.) had already correctly judged, when he said, 'Exemplo hoc non factum illorum probat, sed fidem fixam in resurrectione ostendit.' In the words of Paul we discover no opinion of his own concerning the justice or injustice of the rite; it is merely brought in as an *argumentum ex concessis* in favour of the object which he pursues through the whole chapter (comp. 1 Cor. ii. 5). However much may be objected against this interpretation, it is by far more reasonable than the explanations given by other critics. The Corinthian community was certainly of a mixed character, consisting of individuals of various views, ways of thinking, and different stages of education; so that there might still have existed a small number among them capable of such absurdities. We are not sufficiently acquainted with all the particulars of the case to maintain the contrary, while the simple grammatical sense of the passage is decidedly in favour of the proposed interpretation.

2. Origen (*Dial. contr. Marcion.*), Luther, Chemnitz, and Joh. Gerhard, interpret the words as relating to baptism over the graves of the members of the community, a favourite *rendezvous* of the early Christians. Luther says that, in order to strengthen their faith in the resurrection, the Christians baptized over the tombs of the dead. In that case *ἐπὶ* with genit. must be taken in its local sense, quite an isolated instance in the New Testament (comp. Winer, *Grammat.* p. 263). The custom alluded to, moreover, dates from a much later period, when the adoration of the martyrs had begun to spread.

3. The above-quoted passage of Epiphanius mentions also a view, according to which νεκροί is not to be translated by *dead*, but *mortally ill* persons, whose baptism was expedited by sprinkling water upon them on their death-bed, instead of immersing them in the usual way; the rite is known under the name of *baptismus clinicus. lectualis*. But few of the modern theologians (among whom, however, are Calvin and Estius) advocate this view, which transgresses not less against the words of the text, than against all historical knowledge of the subject.

B. *The interpretations which suppose that the*

text speaks of general church baptism. To these belongs the oldest opinion we know of, given in Tertullian (l. c. comp. *De Resurrect. Carn.* 48): 'Quid et ipsos baptizari ait, si non quæ baptizantur corpora resurgunt?' According to this view *ὑπὲρ* is here taken in the sense of *on account of*, and *νεκρῶν* in that of *dead bodies, they themselves*, the baptized, as dead persons. The notion which lies at the bottom of this version is, that the body possesses a guarantee for resurrection in the act of baptism, in which it also shares. The sinking *under* and rising *up* is with them a symbol of burying and resurrection. Some of the Greek Fathers also favour this interpretation, and more especially Theodoret, who thus develops the notion: 'He who undergoes baptism is therein buried with his Lord, that having partaken in his death, he may become partaker in his resurrection also. But if the body is a corpse and rises not, why is it ever baptized?' Chrysostom: 'Paul said, Unless there is a resurrection, why art thou baptized for corpses, that is, for mere bodies. For to this end art thou baptized, for the resurrection of thy dead body, &c.' The idea thus developed is by itself admissible, and harmonizes well with the whole course of ideas pursued by Paul from ver. 19. The form of the sentence, however, becomes uncommonly harsh, because of the transition: 'else what shall they do who are baptized on account of the dead?' (on account of themselves, who are dead)? Indeed, it is by far more jarring than Rom. v. 6, which is quoted as a parallel passage.

2. The words of Chrysostom, just quoted, certainly convey also the same meaning as regards 'the dead,' but differ from the two former interpretations with regard to *ὑπὲρ*: 'in behalf of the dead' thus means, 'in the belief of the resurrection of the dead.' This ungrammatical version is adopted by Theophylact: 'Why are men baptized at all in behalf of resurrection, that is, in expectation of resurrection, if the dead rise not?' (Isidor. Pelas. 'If bodies rise not at all, why do we believe that in baptism they are changed to incorruptibility?' perhaps with reference to our passage).

3. Pelagius, Olearius, Fabricius, are of opinion that the phrase, 'on account of the dead,' or 'of those who are dead,' although strictly plural, here alludes to an individual, namely, to Christ, 'on account of whom' we are baptized, alluding to Rom. vi. 3. Though the plural is in itself admissible (Winer, *Gram.* p. 163), its use here would nevertheless be rather strange, there being no ground whatever for the use of so peculiar a phraseology; neither can we account for the fact, that the regular construction of *βαπτίζω* with *εἰς* should have been converted into the unprecedented construction with *ὑπὲρ*. Vater justifies the plural, by including in it *John the Baptist*; Semler understands it of Christ and those of the Apostles and teachers of the church who were already dead at that time; Flatt, by adding, on account of Christ, and those who have died in him (in the belief in him):—all quite inadmissible combinations.

4. Among the best interpretations is that of Spanheim and Joh. Christ. Wolf. They consider 'the dead' to be martyrs and other believers, who, by firmness and cheerful hope of resurrection, have given in death a worthy example, *by which*

(*ὑπὲρ*) others were also animated to receive baptism. Still this meaning would be almost too briefly and enigmatically expressed, when no particular reason for it is known, while also the allusion to the exemplary death of many Christians could chiefly apply to the martyrs alone, of whom there were as yet none at Corinth.

5. Olhausen's interpretation is of a rather doubtful character. In the first instance he interprets *ὑπὲρ*—instead of, *in favour of*; and the meaning of the passage he takes to be, that 'all who are converted to the church are baptized—for the good of the dead, as it requires a certain number (Meyer: or rather the conversion of all, Rom. xi. 12-25), a "fulness" of believers, before the resurrection can take place. Every one therefore who is baptized is so for the good of believers collectively, and of those who have already died in the Lord' (both of which, we can hardly suppose *νεκρῶν* to embrace at once!). Olhausen is himself aware that the Apostle could not have expected that such a difficult and remote idea, which he himself calls 'a mystery,' would be understood by his readers without a further explanation and development of his doctrine. He therefore proposes an interpretation as already suggested by Clericus and Döderlein (*Instit.* I.). In this explanation, it is argued, that the miseries and hardships Christians have to struggle against in this life can only be compensated by resurrection. Death causes, as it were, vacancies in the full ranks of the believers, which are again filled up by other individuals. 'What would it profit those who are baptized *in the place* of the dead (to fill up their place in the community) if there be no resurrection? The tendency of the whole connection of the text, however, would rather lead us to expect the question, 'What would the *dead* profit by it?' since the tenor of the passage decidedly refers to them. To make *ὑπὲρ*=*ἀντί*, therefore, is quite unsuitable; not to mention, that the idea—to enter into the ranks of Christians—must first be supposed to be contained in the word 'baptism,' in order to draw from it the figure of *substitution*. A reference is made, in support of the opinion which considers *ὑπὲρ*=*ἀντί*, to Dionys. Halicar. (*Antiq.* viii.), where he is treating of a new conscription, which was to be made to fill up the ranks rendered vacant by the death of the soldiers who had fallen in the war, and the expression there used is—*οὗτοι ἤξιον ὑπὲρ τῶν ἀποθανόντων στρατιωτῶν ἑτέρους καταγράφευ*. Nor are there wanting other similar passages in proof of this; but we must bear in mind, that in Dionys. the word denotes a literal substitution, while in our passage the *substitution* is figurative, far-fetched, and hard to unriddle. It is not probable that the Apostle should not have said *ἀντί*, if he had really wished to express that thought. Moreover, the very essence of the argument, the notion that resurrection is the compensation for the sufferings of life, is here not at all given, nor even hinted at except we connect the *ἐπέ* directly with ver. 19., a thing quite impossible. A somewhat similar opinion is expressed by F. J. Hermann, that *ὑπὲρ*=*præter* (ὅ, Genes. xxvii. 9), 'Cur præter eos qui jam mortui sunt, alii quoque baptismum suscipiant, et ita initiati religionem Christianorum proficiunt, si tamen nulla

erit resurrectio mortuorum nec melioris vitæ præmium expectandum est? In this sense, however, *ἀπέρ* would require the accusative.

C. *βαπτίζόμενοι*, in a *figurative sense*.

Some (referring to the words of Christ, Matt. xx. 22) take it in the sense of the *baptism of passion, suffering*: this is evidently too forced to require refutation.

The interpretations of many others who have still more transgressed against grammar and history in the process, we have with reason omitted. They are partly to be found in the collection of interpretations in Joh. Christ. Wolf's *Cursæ Philologicæ*, &c. and Heidenreich's *Comment. ad N. C.*—J. J.*

BAR (בַּר), a Hebrew word meaning *son*, but used only poetically in that language (Ps. ii. 12; Prov. xxxi. 2). In Syriac, however, Bar (ܒܪ or ܒܪܐ) answered to the more common Hebrew word for *son*, i. e. בֶּן *ben*; and hence in later times, in the New Testament, it takes the same place in the formation of proper names which *Ben* had formerly occupied in the Old Testament.

BARABBAS (probably אֲבָבָס בֶּן, *son of Abba*, a common name in the Talmud), a person who had forfeited his life for sedition and murder (Mark xv. 7; Luke xxiii. 25). As a rebel, he was subject to the punishment laid down by the Roman law for such political offences; while, as a murderer, he could not escape death even by the civil code of the Jews. But the latter were so bent on the death of Jesus, that, of the two, they preferred pardoning this double criminal (Matt. xxvii. 16-26; Mark xv. 7-15; Luke xxiii. 18-25; John xviii. 40). Origen says that in many copies Barabbas was also called *Jesus*. The Armenian Version has the same reading: 'Whom will ye that I shall deliver unto you, Jesus Barabbas, or Jesus that is called Christ?' Griesbach, in his *Comment.*, considers this as an interpolation; while Fritzsche has adopted it in his text. We can certainly conceive that a name afterwards so sacred may have been thrown out of the text by some bigoted transcriber.—E. M.

* As the topic of baptism seemed to be well exhausted in this country, the Editor thought that some freshness of effect might be produced by presenting the subject to the reader from a German point of view. The article was, therefore, offered to Dr. Neander, the church historian, and Professor of Theology in the university of Berlin. His multiplied pre-engagements, however, induced him, with the Editor's consent, to consign the subject to the Rev. J. Jacobi, of the same university; and in due time the MS. of the present article arrived, accompanied by the following note from Dr. Neander, to whose inspection it had previously been submitted by the author:—

'As my other labours would not permit me to work out the article (on Baptism) for the "Cyclopædia of Biblical Literature," I requested a dear friend, J. Jacobi, to undertake it, who, by his knowledge and critical talents, is fully qualified for the task, and whose theological principles are in unison with my own.—A. NEANDER.'

BARACHIAS (Βαραχίας), father of the Zechariah (Zacharias) mentioned in Matt. xxiii. 35 [ZACHARIAH].

BARAK (בַּרַק, *lightning*; Sept. Βέρακ), son of Abinoam of Kedesh-Naphtali, a Galilean city of refuge in the tribe of Naphtali (Judg. i. 6; comp. Josh. xix. 37; xxi. 32). He was summoned by the prophetess Deborah to take the field against the hostile army of the Canaanitish king Jabin, commanded by Sisera, with 10,000 men from the tribes of Naphtali and Zebulon, and to encamp on Mount Tabor, probably because the 900 chariots of iron (Judg. iv. 3), in which the main force of Sisera consisted, could not so easily manœuvre on uneven ground. After some hesitation, he resolved to do her bidding, on condition that she would go with him, which she readily promised. Confiding, therefore, in the God of Israel, he attacked the hostile army by surprise, put them to flight, and routed them to the last man (Judg. v. 14, 15, 16). In conjunction with Deborah, he afterwards composed a song of victory in commemoration of that event (*ibid.*).—E. M.

BARBARIAN (Βάρβαρος). This term is used in the New Testament, as in classical writers, to denote other nations of the earth in distinction from the Greeks. 'I am debtor both to the Greeks and Barbarians'—'Ἑλλησὶ τε καὶ βάρβαροις' (Rom. i. 14); 'der Griechen und der Ungriechen'—Luther; 'To the Grekes and to them which are no Grekes'—Tyndale, 1534, and Geneva, 1557; 'To the Grekes and to the Ungrekes'—Cranmer, 1539. In Coloss. iii. 11, 'Greek nor Jew—Barbarian, Scythian'—Βάρβαρος seems to refer to those nations of the Roman empire who did not speak Greek, and Σκύθης to nations not under the Roman dominion (Dr. Robinson). In 1 Cor. xiv. 11 the term is applied to a difference of language: 'If I know not the meaning of the voice, I shall be unto him that speaketh a barbarian ('as of another language,' Geneva Vers.), and he that speaketh shall be a barbarian ('as of another language,' Geneva Vers.) unto me.' Thus Ovid, 'Barbarus hic ego sum, quia non intelligor ulli,' *Trist.* v. 10. 37. In Acts xxviii. the inhabitants of Malta are called *βάρβαροι*, because they were originally a Carthaginian colony, and chiefly spoke the Punic language. In the Septuagint, *βάρβαρος* is used for the Hebrew *לען*, 'A people of strange language' (Ps. cxiv. 1); in the Chaldee paraphrase *כעמניא ברבראי*. In the Rabbinical writers *לען* is applied to foreigners in distinction from the Jews; and in the Jerusalem Talmud it is explained by *וינין*, i. e. the Greek language; Rabbi Solomon remarks, that whatever is not in the Holy tongue, is called *לען* (Buxtorf, *Lex-Talm.*). According to Herodotus, the Egyptians called all men barbarians who did not speak the same language as themselves: *μη σφίσι ὁμογλώσσους*, ii. 158. Clement of Alexandria uses it respecting the Egyptians and other nations, even when speaking of their progress in civilization, as in his *Strom.* i. c. 16, § 74: *Ὁ μόνος δὲ φιλοσοφίας, ἀλλὰ καὶ πάσης σχεδὸν τέχνης εὐρετὰ Βάρβαροι. Αἰγυπτῖοι γοῦν πρῶτοι ἀστρολογίαν εἰς ἀνθρώπους ἐξήνεγκαν, ὁμοίως δὲ καὶ Χαλδαῖοι.*—'Barbarians have been inventors not only of philosophy, but

likewise of almost every art. The Egyptians, and in like manner the Chaldeans, first introduced among men the knowledge of astrology.' In a singular passage of Justin Martyr's first Apology, the term is applied to Abraham and other distinguished Hebrews: 'We have learned and have before explained, that Christ is the first begotten of God, being the Word (or reason) *λογον ὄντα*, of which the whole human race partake. And they who live agreeably to the Word (or reason) *οἱ μετὰ λόγον βιώσαντες*, are Christians, even though esteemed atheists: such among the *Greeks* were Socrates, Heraclitus, and the like; and among the *barbarians* ('among other nations,' *Chevalier's Trans.*) *ἐν βαρβάροις*, Abraham, Ananias, Azarias, Misael, and Elias, and many others.—*Apol.* i. 46. Strabo (xiv. 2) suggests that the word *Bar-bar-os* was originally an imitative sound, designed to express a harsh dissonant language, or sometimes the indistinct articulation of the Greek by foreigners, and instances the Carians, who on the latter account he conjectures were termed by Homer *βαρβαρόφρωνι* (*Il.* ii. 867). The word appears to have acquired a reproachful sense during the wars with the Persians; their country was called ἡ βάρβαρος (γη). (*Demosth. Philipp.* iii.)—J. E. R.

BAR-JESUS (*Βαριησοῦς*). [E. YMAS.]

BAR-JONA (*Βάρ Ἰωνᾶ*, *son of Jonas*), the patronymic appellation of the Apostle Peter (*Matt.* xvi. 17).

BARKENIM. [THORNS.]

BARLEY (*בָּרֵי*). This grain is mentioned in Scripture as cultivated and used in Egypt (*Exod.* ix. 31), and in Palestine (*Lev.* xxvii. 16; *Deut.* viii. 8; 2 *Chron.* ii. 10; *Ruth* ii. 17; 2 *Sam.* xiv. 30; *Isa.* xxviii. 25; *Jer.* xli. 8; *Joel* i. 11). Barley was given to cattle, especially horses (1 *Kings* iv. 28), and was indeed the only corn grain given to them, as oats and rye were unknown to the Hebrews, and are not now grown in Palestine, although Volney affirms (ii. 117) that small quantities are raised in some parts of Syria as food for horses. Hence barley is mentioned in the *Mishnah* (*Pesach.* fol. 3) as the food of horses and asses. This is still the chief use of barley in Western Asia. Bread made of barley was, however, used by the poorer classes (*Judg.* vii. 13; 2 *Kings* iv. 42; *John* vi. 9, 13; *comp. Ezek.* iv. 9). In Palestine barley was for the most part sown at the time of the autumnal rains, October—November (*Lightfoot, Hor. Hebr. ad Matt.* xii. 1), and again in early spring, or rather as soon as the depth of winter had passed (*Mish. Berachoth.* p. 18). This later sowing has not hitherto been much noticed by writers on this part of Biblical illustration, but is confirmed by various travellers who observed the sowing of barley at this time of the year. Russell says that it continues to be sown to the end of February (*Nat. Hist. Aleppo*, i. 74; see his meaning evolved in the *Pictorial Palestine, Phys. Hist.*, p. 214; *comp.* p. 229). The barley of the first crop was ready by the time of the Passover, in the month Abib, March—April (*Ruth* i. 22; 2 *Sam.* xxi. 9; *Judith* viii. 2); and if not ripe at the expiration of a (Hebrew) year from the last celebration, the year was intercalated (*Lightfoot, ut supra*) to preserve that connection between the feast and the barley-harvest which the law required

(*Exod.* xliii. 15, 16; *Deut.* xvi. 16). Accordingly, travellers concur in showing that the barley-harvest in Palestine is in March and April—advancing into May in the northern and mountainous parts of the land; but April is the month in which the barley-harvest is chiefly gathered in, although it begins earlier in some parts and later in others (*Pict. Palestine*, pp. 214, 229, 239). At Jerusalem, Neibubr found barley ripe at the end of March, when the later (autumnal) crop had only been lately sown (*Beschreib. von Arabien*, p. 160).

The passage in *Isa.* xxxii. 20 has been supposed by many to refer to rice, as a mode of culture by submersion of the land after sowing, similar to that of rice, is indicated. The celebrated passage, 'Cast thy bread upon the waters,' &c. (*Eccles.* xi. 1), has been by some supposed to refer also to such a mode of culture. But it is precarious to build so important a conclusion, as that rice had been so early introduced into the Levant, upon such slight indications; and it now appears that barley is in some parts subjected to the same submersion after sowing as rice, as was particularly noticed by Major Skinner (i. 320), in the vicinity of Damascus. In *Exod.* ix. 31, we are told that the plague of hail, some time before the Passover, destroyed the barley, which was then in the green ear; but not the wheat or the rye, which were only in the blade. This is minutely corroborated by the fact that the barley sown after the inundation is reaped, some after ninety days, some in the fourth month (*Wilkinson's Thebes*, p. 395), and that it there ripens a month earlier than the wheat (*Soinini*, p. 395).

BARNABAS (*בָּרְנָבָא בֶּרֶךְ; Βαρνάβας*). His name was originally Ἰωσήφ, *Joses*, or Ἰωσήφ, *Joseph* (*Acts* iv. 36); but he received from the Apostles the surname of Barnabas, which signifies the *Son of Prophecy*. Luke interprets it by *υἱὸς παρακλήσεως*, i. e. *Son of Exhortation*. The Hebrew term and its cognates are used in the Old Testament with a certain latitude of meaning, and are not limited to that of foretelling future events. Thus Abraham is termed in *Gen.* xx. 7 *בְּרִיָּה*, Sept. *προφήτης*, as being a person admitted to intimate communion with the Deity, and whose intercession was deemed of superior efficacy. In *Exod.* vii. 1 Jehovah declares to Moses, 'I have made thee a god to Pharaoh, and Aaron, thy brother, shall be thy prophet,' *נְבִיאֲךָ*, which Onkelos translates by *נְבִיאֲךָ מִתְּוֹרַתִּי*, *thy interpreter* (Buxtorf, *Lex. Talmud.*) In like manner *προφητεία*, in the New Testament, means not merely prediction, but 'includes the idea of declarations, exhortations, or warnings uttered by the prophets while under divine influence' (*Dr. E. Robinson*). 'He that *prophesieth* (*ὁ προφητεύων*) speaketh unto men, unto edification, and *exhortation* (*παράκλησιν*), and comfort' (1 *Cor.* xiv. 3). Of Silas and Judas it is said, 'being *prophets*, they *exhorted* (*παρεκάλεισαν*) the brethren' (*Act* xv. 32). It can hardly be doubted that this name was given to Joses to denote his eminence as a Christian teacher. In *Acts* xiii. 1 his name is placed first in the list of prophets and teachers belonging to the church at Antioch. Chrysostom, however, understands the surname in the same way as the Auth. Vers., *Son of Consolation*, and supposes that it was

given to Barnabas on account of his mild and gentle disposition: 'This Barnabas was a mild and gentle person. His name means *Son of Consolation*: hence he became a friend of Paul; and that he was very kind and easy of access is proved by the instance before us, and by the case of John (Mark)' (*In Act. Apost. Hom. xxi.*). He is described by Luke as 'a good man, full of the Holy Ghost and of faith' (Acts xi. 24). He was a native of Cyprus, but the son of Jewish parents of the tribe of Levi. From Acts iv. 36, 37 it appears that he was possessed of land, but whether in Judæa or Cyprus is not stated. He generously disposed of the whole for the benefit of the Christian community, and 'laid the money at the Apostles' feet.' As this transaction occurred soon after the day of Pentecost, he must have been an early convert to the Christian faith. According to Clement of Alexandria (*Strom. ii. c. 20, vol. ii. p. 192, ed. Klotz*), Eusebius (*Hist. Eccles. i. 12*), and Epiphanius (*Hær. xx. 4*), he was one of the seventy disciples (Luke x. 1). It has been maintained that Barnabas is identical with Joseph Barsabas, whose name occurs in Acts i. 23. Most modern critics, however, embrace the contrary opinion, which they conceive is supported by the circumstantial manner in which Barnabas is first mentioned. However similar in sound, the meanings of the names are very different; and if no further notice is aken of Barsabas (a circumstance which Ullman urges in favour of his identity with Barnabas), the same may be affirmed of Matthias. Chrysostom observes, on Acts iv. 36, 'This person is not, in my opinion, the same that is mentioned with Matthias; for he was called Joses and Barsabas, and afterwards surnamed Justus; but this man was surnamed by the apostles Barnabas, *Son of Consolation*; and the name seems to have been given him from the virtue, inasmuch as he was competent and fit for such a purpose' (*In Act. Apost. Homil. xi. 1*).

When Paul made his first appearance in Jerusalem after his conversion, Barnabas introduced him to the Apostles, and attested his sincerity (Acts ix. 27). This fact lends some support to an ancient tradition that they had studied together in the school of Gamaliel—that Barnabas had often attempted to bring his companion over to the Christian faith, but hitherto in vain—that meeting with him at this time in Jerusalem, not aware of what had occurred at Damascus, he once more renewed his efforts, when Paul threw himself weeping at his feet, informed him of 'the heavenly vision,' and of the happy transformation of the persecutor and blasphemer into the obedient and zealous disciple (Acts xxvi. 16).

Though the conversion of Cornelius and his household, with its attendant circumstances, had given the Jewish Christians clearer views of the comprehensive character of the new dispensation, yet the accession of a large number of Gentiles to the church at Antioch was an event so extraordinary, that the Apostles and brethren at Jerusalem resolved on deputing one of their number to investigate it. Their choice was fixed on Barnabas. After witnessing the flourishing condition of the church, and adding fresh converts by his personal exertions, he visited Tarsus to obtain the assistance of Saul, who returned with him to Antioch, where they laboured for a whole year (Acts xi. 23-26).

In anticipation of the famine predicted by Agabus, the Antiochian Christians made a contribution for their poorer brethren at Jerusalem, and sent it by the hands of Barnabas and Saul (Acts xi. 28-30), who speedily returned, bringing with them John Mark, a nephew of the former. By divine direction (Acts xii. 2) they were separated to the office of missionaries, and as such visited Cyprus and some of the principal cities in Asia Minor (Acts xiii. 14). Soon after their return to Antioch, the peace of the church was disturbed by certain zealots from Judæa, who insisted on the observance of the rite of circumcision by the Gentile converts. To settle the controversy, Paul and Barnabas were deputed to consult the Apostles and elders at Jerusalem (Acts xv. 1, 2); they returned to communicate the result of their conference (ver. 22), accompanied by Judas Barsabas and Silas, or Silvanus. On preparing for a second missionary tour, a dispute arose between them on account of John Mark, which ended in their taking different routes; Paul and Silas went through Syria and Cilicia, while Barnabas and his nephew revisited his native island (Acts xv. 36-41). In reference to this event, Chrysostom remarks—'Τί οὖν; ἔχθροὶ ἀνεχώρησαν; μή γένοιτο. Ὅρας γὰρ μετὰ τοῦτο Βαρνάβαν πολλῶν ἐγκωμίων ἀπολαύοντα παρὰ Παύλου ἐν ταῖς ἐπιστολαῖς. Παροξυσμός, φησὶν, ἐγένετο, οὐκ ἔχθρα οὐδὲ φιλονεικία.' 'What then? Did they part as enemies? Far from it. For you see that after this Paul bestows in his Epistles many commendations on Barnabas. There was "a sharp fit of anger" (Doddridge) he (Luke) says, not enmity, nor love of strife.' At this point Barnabas disappears from Luke's narrative, which to its close is occupied solely with the labours and sufferings of Paul. From the Epistles of the latter a few hints (the only authentic sources of information) may be gleaned relative to his early friend and associate. From 1 Cor. ix. 5, 6, it would appear that Barnabas was unmarried, and supported himself, like Paul, by some manual occupation. In Gal. ii. 1 we have an account of the reception given to Paul and Barnabas by the Apostles at Jerusalem, probably on the occasion mentioned in Acts xv. In the same chapter (ver. 13) we are informed that Barnabas so far yielded to the Judaizing zealots at Antioch, as to separate himself for a time from communion with the Gentile converts. The date of this occurrence has been placed by some critics soon after the Apostolic convention at Jerusalem (about A.D. 52); by others, on the return of Paul from his second missionary journey (A.D. 55). Dr. Paley thinks 'that there is nothing to hinder us from supposing that the dispute at Antioch was prior to the consultation at Jerusalem, or that Peter, in consequence of this rebuke, might have afterwards maintained firmer sentiments (*Horæ Paulinæ*, ch. v.). The same view has been taken by Hug and Schneckenburger; but (as Dr. Neander remarks) though Paul may not follow a strict chronological order, it is difficult to believe that he would not place the narrative of an event so closely connected with the conference at Jerusalem, at the beginning, instead of letting it follow as supplementary (*History of the Planting of the Christian Church*, vol. i. p. 248, Eng. Transl.). It has been inferred from 2 Cor. viii. 18, 19, that Barnabas was not only reconciled to Paul after their separation (Acts xv. 39)

but also became again his coadjutor; that he was 'the brother whose praise was in the Gospel through all the churches.' Chrysostom says that some suppose the brother was Luke, and others Barnabas. Theodoret asserts that it was Barnabas, and appeals to Acts xiii. 3, which rather serves to disprove his assertion, for it ascribes the appointment of Paul and Barnabas to an express divine injunction, and not to an elective act of the church; and, besides, the brother alluded to was chosen, not by a single church, but by several churches, to travel with Paul (*χειροτονηθείς ὑπὸ τῶν ἐκκλησιῶν συνέκδημος ἡμῶν*, 2 Cor. viii. 19). In Colos. iv. 10, and Philemon, ver. 24, Paul mentions Mark as his fellow-labourer; and at a still later period, 2 Tim. iv. 11, he refers with strong approbation to his services, and requests Timothy to bring him to Rome; but of Barnabas (his relationship to Mark excepted) nothing is said. The most probable inference is, that he was already dead, and that Mark had subsequently associated himself with Paul. For the latter years of Barnabas we have no better guides than the *Acta et Passio Barnabæ in Cypro*, a forgery in the name of John Mark, and, from the acquaintance it discovers with the localities of Cyprus, probably written by a resident in that island; and the legends of Alexander, a Cyprian monk, and of Theodore, commonly called Lector (that is, an *ἀναγνώστης*, or reader), of Constantinople: the two latter belong to the sixth century. According to Alexander, Barnabas, after taking leave of Paul, landed in Cyprus, passed through the whole island, converted numbers to the Christian faith, and at last arrived at Salamis, where he preached in the synagogue with great success. Thither he was followed by some Jews from Syria (the author of the *Acta* names Barjesus as their leader), who stirred up the people against him. Barnabas, in anticipation of his approaching end, celebrated the Eucharist with his brethren, and bade them farewell. He gave his nephew directions respecting his interment, and charged him to go after his decease to the Apostle Paul. He then entered the synagogue, and began as usual to preach Christ. But the Jews at once laid hands on him, shut him up till night, then dragged him forth, and, after stoning him, endeavoured to burn his mangled body. The corpse, however, resisted the action of the flames; Mark secretly conveyed it to a cave about five stadia from the city; he then joined Paul at Ephesus, and afterwards accompanied him to Rome. A violent persecution, consequent on the death of Barnabas, scattered the Christians at Salamis, so that a knowledge of the place of his interment was lost. This account agrees with that of the pseudo Mark, excepting that, according to the latter, the corpse was reduced to ashes. Under the emperor Zeno (A.D. 474-491), Alexander goes on to say, Peter Fullo, a noted Monophysite, became patriarch of Constantinople. He aimed at bringing the Cyprian church under his patriarchate, in which attempt he was supported by the emperor. When the Bishop of Salamis, a very worthy man, but an indolent debater (*ὀλιγοστός δὲ πρὸς διάλεξιν*), was called upon to defend his rights publicly at Constantinople, he was thrown into the greatest perplexity. But Barnabas took compassion on his fellow-countryman, appeared to him by night no less than three times, assured him of success, and told

him where he might find his body, with a copy of Matthew's gospel lying upon it. The bishop awoke, assembled the clergy and laity, and found the body as described. The sequel may be easily conjectured. Fullo was expelled from Antioch; the independence of the Cyprian church acknowledged; the manuscript of Matthew's gospel was deposited in the palace at Constantinople, and at Easter lessons were publicly read from it; and by the emperor's command a church was erected on the spot where the corpse had been interred. The suspicious visions of Barnabas are termed by Dr. Cave, 'a mere addition to the story, designed only to serve a present turn, to gain credit to the cause, and advance it with the emperor.'

Neither Alexander nor Theodore is very explicit respecting the copy of Matthew's gospel which was found with the corpse of Barnabas. The former represents Barnabas as saying to Anthemius, *ἐκεῖ μοῦ τὸ πᾶν σῶμα ἀποκείται, καὶ εὐαγγέλιον ἰδίῳ χειρὶν ὃ ἐξέλαβον ἀπὸ Ματθαίου*—'There my whole body is deposited, and an autograph gospel which I received from Matthew.' Theodore says, *ἔχον ἐπὶ στήθους τὸ κατὰ Ματθαῖον εὐαγγέλιον, ἰδιόγραφον τοῦ Βαρνάβα*—'Having on his breast the Gospel according to Matthew, an autograph of Barnabas.' The pseudo Mark omits the latter circumstance. If we believe that, as Alexander reports, it was read at Constantinople, it must have been written not in Hebrew, but in Greek. The year when Barnabas died cannot be determined with certainty; if his nephew joined Paul after that event, it must have taken place not later than A.D. 63 or 64. 'Chrysostom,' it has been asserted, 'speaks of Barnabas as alive in A.D. 63.' The exact statement is this: in his *Eleventh Homily on the Epistle to the Colossians* he remarks, on ch. iv. 10, 'touching whom ye receive commandments, if he come unto you receive him'—*ἴσως παρὰ Βαρνάβα ἐντολὰς ἔλαβον*—'perhaps they received commands from Barnabas.'

There is a vague tradition that Barnabas was the first bishop of the church at Milan, but it is so ill supported as scarcely to deserve notice. It is enough to say that the celebrated Ambrose (b. A.D. 340, d. 397) makes no allusion to Barnabas when speaking of the bishops who preceded himself (v. Hefele, *Das Sendschreiben des Apostels Barnabas*, pp. 42-47).

From the incident narrated in Acts xiv. 8-12 Chrysostom infers that the personal appearance of Barnabas was dignified and commanding. When the inhabitants of Lystra, on the cure of the impotent man, imagined that the gods were come down to them in the likeness of men, they called Barnabas Zeus (their tutelary deity), and Paul, Hermes, because he was chief speaker: *ἐμοὶ δοκεῖ καὶ ἀπὸ τῆς ὕψους ἀξιοπρεπέως εἶναι ὃ Βαρνάβας* (*In Act. Apost. Hom. xxx*).

BARNABAS, GOSPEL OF. A spurious gospel, attributed to Barnabas, exists in Arabic, and has been translated into Italian, Spanish, and English. It was probably forged by some heretical Christians, and has since been interpolated by the Mohammedans, in order to support the pretensions of their prophet. Dr. White has given copious extracts from it in his *Bampton Lectures*, 1784: *Sermon* viii. p. 358, and *Notes*, p. 41-69 (See also Sale's *Koran*, *Prelim. Dissert.* sect. 4). It is placed among the Apocryphal books in the

Stichometry prefixed by Cotelierius to his edition of the Apostolical Constitutions (Lardner's *Credibility*, part ii. ch. 147). It was condemned by Pope Gelasius I. (Tillemont, *Mémoires*, &c. i. p. 1055).

BARNABAS, EPISTLE OF. The title of this ancient composition is found in the Stichometries (or catalogues of the sacred books) of the ninth century; but from that period to the seventeenth century the work itself remained entirely unknown. Jacob Sirmond, a Jesuit, in copying the transcript of a Greek manuscript of Polycarp's *Epistle to the Philippians*, which belonged to Turrianus (a member of the same order), discovered another piece appended to it, which proved to be the Epistle (so called) of Barnabas. It was also found in two manuscripts of Polycarp, at Rome, which Cressolius collated. Sirmond sent a copy to the Benedictine, Hugo Menard, who had not long before found an ancient Latin translation of the Epistle of Barnabas in the Abbey of Corbey. About the same time Andreas Schottus (also a Jesuit) obtained a manuscript containing the Epistles of Polycarp and Barnabas; this was transcribed by Claudius Salmasius, and given, with a copy of the Corbey version, to Isaac Vossius. Vossius shortly after paid a visit to Archbishop Usher, who was then preparing for publication an ancient Latin version of the shorter Ignatian Epistles. It was agreed between them to annex to this work the Epistle of Barnabas. But it had hardly been sent to press when the great fire at Oxford occurred (1644), in which the manuscript was destroyed, with all the archbishop's notes, and only a few pages saved which were in the corrector's hands. These were afterwards inserted by Bishop Fell, in the Preface to his edition of Barnabas, Oxford, 1685. The first edition of Barnabas appeared at Paris, in 1645; it had been prepared by Menard, but, in consequence of his death, was edited by Luke d'Acherry. In the following year a new and much improved edition was published by Vossius, for which he collated three manuscripts; it was appended to his *editio princeps* of the Ignatian Epistles. In 1672 Cotelierius published his magnificent edition of the Apostolic Fathers. Besides the Greek text, and Corbey's version of Barnabas, it contained a new translation and valuable notes by the editor. The reprint, in 1724, contained additional notes by Davis and Le Clerc. In 1685 two additions appeared; Bishop Fell's, already noticed, and one by Stephen le Moyné, at Leyden, in the first volume of his *Varia Sacra*, with copious notes. It is also contained in Russel's edition of the Apostolic Fathers, Lond. 1746, and in the first volume of Galland's *Bibliotheca veterum Patrum*, Ven. 1765. The most recent and convenient edition is that by Dr. C. J. Hefele, in his *Patrum Apostolicorum Opera*, Tübingen, 1839 and 1842. Two German translations have appeared, by Arnold (1696), Glüsing (Hamb. 1723), Gryncœus (1772), and Möst (1774); it was translated into English, by Archbishop Wake (*The genuine Epistles of the Apostolic Fathers*, &c., Lond. 1693 and 1710); and a French translation by Le Gras is inserted in Despey's Bible, Paris, 1717. On comparing the Corbey version with the Greek text, it appears that the latter wants four chapters and a half at the beginning, and the former four chapters at the end; thus each supplies the deficiencies of the

other. It is remarkable that all the Greek manuscripts hitherto found are similarly defective; which plainly shows that they are all derived from the same source, and form only one family of manuscripts.

The Epistle of Barnabas consists of twenty-one chapters. The first part (i. 17) treats of the abrogation of the Mosaic dispensation, and of the types and prophecies relating to Christ; the last four chapters are composed entirely of practical directions and exhortations. The names and residence of the persons to whom it is addressed are not mentioned, on which account, probably, it was called by Origen a *Catholic Epistle* (Origen, *Contr. Cels.* lib. i. p. 49). But if by this title he meant an epistle addressed to the general body of Christians, the propriety of its application is doubtful, for we meet with several expressions which imply a personal knowledge of the parties. It has been disputed whether the persons addressed were Jewish or Gentile Christians. Dr. Hefele strenuously contends that they were of the former class. His chief argument appears to be, that it would be unnecessary to insist so earnestly on the abolition of the Mosaic economy in writing to Gentile converts. But the Epistle of Paul to the Galatians is a proof to what danger Gentile Christians were exposed in the first ages from the attempts of Judaizing teachers; so that, in the absence of more exact information, the supposition that the persons addressed were of this class, is at least not inconsistent with the train of thought in the Epistle. But more than this: throughout the Epistle we find a distinction maintained between the writer and his friends on the one hand, and the Jews on the other. Thus in chap. iii., 'God speaketh to *them* (the Jews), concerning these things, "Ye shall not fast as ye do this day," &c.; but to *us* he saith, "Is not this the fast that I have chosen?" &c.; and at the end of the same chapter, 'He hath shown these things to all of *us* that we should not run as *proselytes* to the Jewish law'—'*ante ostendit omnibus nobis ut non incurramus tanquam proselyti ad illorum legem.*' This would be singular language to address to persons who were Jews by birth, but perfectly suited to Gentile converts. In chap. xiii. he says, 'Let us inquire whether the covenant be with *us* or with *them*' (the Jews), and concludes with quoting the promise to Abraham (with a slight verbal difference), 'Behold I have made thee a father of the nations which *without circumcision* believe in the Lord,' a passage which is totally irrelevant to Jewish Christians. For other similar passages, see Jones *On the Canon*, part iii. chap. 39.

Whether this Epistle was written by Barnabas, the companion of St. Paul, has been a subject of controversy almost ever since its publication in the seventeenth century. Its first editors, Usher and Menard, took the negative, and Vossius the affirmative side of the question. Of modern critics, Hug, Ullman, Neander, Winer, and Hefele agree with the former, and Rosenmüller, Gieseler, Bleek, Heuke, and Rordam with the latter. The external evidence for its genuineness, it may be allowed, is considerable; but besides some conflicting testimonies, criteria furnished by the Epistle itself lead to the opposite conclusion. We shall present a view of both as succinctly as possible.

I. The first writer who alludes to this Epistle is Clement of Alexandria. 1. He quotes a sen-

tence from the tenth chapter, and adds, 'These things saith Barnabas' (*Strom.* ii. 15. § 67, vol. ii. p. 165, ed. Klotz. Lips. 1831). 2. A sentence from chap. xxi., of which he says, 'Barnabas truly speaks mystically' (*Strom.* ii. 18. § 84, vol. ii. p. 174). 3. Again, quoting chap. x., 'Barnabas says' (*Strom.* v. 8. § 52, vol. iii. p. 38). 4. After quoting two passages from chap. i. and ii., he calls the author the *apostle Barnabas* (*Strom.* ii. 6. § 31, vol. ii. p. 142). 5. He cites a passage from chap. iv. with the words 'the apostle Barnabas says' (*Strom.* ii. 7. § 35, vol. ii. 114). 6. He prefaces a passage from chap. xvi. with 'I need not say more, when I adduce as a witness the apostolic Barnabas, who was one of the Seventy, and a fellow-labourer with Paul' (*Strom.* ii. 20. § 116, vol. ii. p. 192). 7. He makes two quotations from chap. vi., which he introduces with these words: 'But Barnabas also, who proclaimed the word with the apostle, in his ministry among the Gentiles' (*Strom.* v. 10. § 64, vol. iii. p. 46). The name of Barnabas occurs in another passage (*Strom.* vi. 8. § 64, vol. iii. 136), but probably by a lapse of memory, instead of Clements Romanus, from whose first Epistle to the Corinthians a sentence is there quoted. There is also an evident allusion to the Epistle of Barnabas in *Pædag.* ii. 10. § 83, vol. i. p. 245, and in some other passages, though the author's name is not mentioned.

II. Origen quotes this Epistle twice. 1. The sentence in chap. v. respecting the apostles, which he says 'is written in the Catholic Epistle of Barnabas' (*Contr. Cels.* i. 49). 2. A passage from chap. xviii.: 'To the same purpose Barnabas speaks in his Epistle, when he says, that "there are two ways, one of light, the other of darkness," &c. (*De Princ.* iii. 2).

On these testimonies it has been remarked, that both these Alexandrian fathers have quoted works unquestionably spurious without expressing a doubt of their genuineness: thus Clement refers to the Revelation of Peter, and Origen to the Shepherd of Hermas, which he believed to be inspired ('quæ scriptura valde mihi utilis videtur, et, ut puto, divinitus inspirata,' *In Ep. ad Rom. Comment.* lib. x.); and though Clement speaks of the *apostolic* Barnabas, he evidently does not treat this Epistle with the same deference as the canonical writings, but freely points out its mistakes. Tertullian calls all the seventy disciples apostles, and in this inferior and secondary sense, as Dr. Lardner observes, Clement terms Barnabas an apostle.

III. Eusebius, in the noted passage of his *Ecclesiastical History* (iii. 25), quoted at length (in the original) by De Wette, in his *Lehrbuch der historisch-kritischen Einleitung in die Bibel*, &c., Berlin, 1840, Theil. i. § 32, and translated by Lardner, *Credibility*, part ii. chap. 72, says, 'The Epistle reputed to be written by Barnabas is to be ranked among the books which are *spurious*'—*ἐν τοῖς νόθοις κατατάχθαι—ἡ φερομένη Βαρνάβα ἐπιστολή;* and elsewhere, 'He (Clement of Alexandria) makes use of testimonies out of those scriptures that are contradicted (*ἀπὸ τῶν ἀντιλεγόμενων γραφῶν*), that called the Wisdom of Solomon, and of Jesus the Son of Sirach, and the Epistle to the Hebrews, and that of Barnabas and of Clement, and of Jude' (*Hist. Eccles.* vi. 13). He also observes of Clement, 'In his book called

Hypotyposes, he gives short explications of all the canonical Scriptures (*πάσης τῆς ἐνδιάθηκου γραφῆς*),* not neglecting even the *controverted* books (*τὰς ἀντιλεγόμενας*), I mean that of Jude and the other Catholic Epistles, the Epistle of Barnabas, and that called the Revelation of Peter.'

IV. Jerome, in his work on *Illustrious men*, or *Catalogue of Ecclesiastical Writers*, thus speaks of Barnabas: 'Barnabas of Cyprus, called also Joseph, a Levite, was ordained, with Paul, an apostle of the Gentiles: he wrote an Epistle for the edification of the church, which is read among the *Apocryphal* scriptures' (*Catal. Vir. illust.* cap. vi.); and in his *Commentary on Ezekiel* xlii. 19, 'Many parts of the Scriptures, and especially the Epistle of Barnabas, which is reckoned among the *apocryphal* Scriptures,' &c. In another place he quotes, as the words of Ignatius, the passage relative to the apostles, which is cited by Origen from the Epistle of Barnabas (Lardner's *Credibility*, pt. ii. ch. 114).

It is evident, as Valesius (with whom Lardner and Hefele agree) has remarked, that Eusebius uses the term *νόθα*, not in the strict sense of *spurious*, but as synonymous with *ἀντιλεγόμενα*, i. e. *disputed, controverted*, and applies it to writings which were received by some, but rejected by others. The term *apocryphal* also, used by Jerome, was applied both by Jews and Christians to works which (though the authors were known) were not considered canonical. The use of these terms, therefore, in reference to the Epistle before us, cannot be deemed as absolutely decisive against its genuineness. The following considerations, however, omitting some of less weight which have been urged by different writers, will, it is believed, go far to prove that Barnabas was not the author of this Epistle.

1. Though the exact date of the death of Barnabas cannot be ascertained, yet from the particulars already stated respecting his nephew, it is highly probable that that event took place before the martyrdom of Paul, A. D. 64. But a passage in the Epistle (ch. xvi.) speaks of the temple at Jerusalem as already destroyed: it was consequently written after the year 70.

2. Several passages have been adduced to show that the writer (as well as the persons addressed) belonged to the Gentile section of the Church; but waiving this point, the whole tone of the Epistle is different from what the knowledge we possess of the character of Barnabas would lead us to expect, if it proceeded from his pen. From the hints given in the Acts he appears to have been a man of strong attachments, keenly alive to the ties of kindred and father-land; we find that on both his missionary tours his native island and the Jewish synagogues claimed his first attention. But throughout the Epistle there is a total absence of sympathetic regard for the Jewish nation: all is cold and distant, if not contemptuous. 'It remains yet that I speak to you (the 16th chapter begins) concerning the temple; how those *miserable men*, being deceived, have put their trust in the house.' How unlike

* 'Libri canonici vocantur ἐνδιάθηκοι quia efficiunt utrumque Testamentum (διαθήκην Græci appellant) vetus scilicet et novum' (*Suiceri Theol. s. v. ἐνδιάθηκος*).

the friend and fellow-labourer of him who had 'great heaviness and continual sorrow in his heart for his brethren, his kindred according to the flesh' (Rom. ix. 2).

3. Barnabas was not only a Jew by birth, but a Levite; from this circumstance, combined with what is recorded in the Acts, of the active part he took in the settlement of the points at issue between the Jewish and the Gentile converts, we might reasonably expect to find, in a composition bearing his name, an accurate acquaintance with the Mosaic ritual—a clear conception of the nature of the Old Economy, and its relation to the New Dispensation, and a freedom from that addition to allegorical interpretation which marked the Christians of the Alexandrian school in the second and succeeding centuries. But the following specimens will suffice to show that exactly the contrary may be affirmed of the writer of this Epistle; that he makes unauthorized additions to various parts of the Jewish Cultus; that his views of the Old Economy are confused and erroneous; and that he adopts a mode of interpretation countenanced by none of the inspired writers, and at utter variance with every principle of sound criticism, being to the last degree puerile and absurd. The inference is unavoidable, that Barnabas, 'the Son of Prophecy,' 'the Man full of the Holy Spirit and of faith,' was not the author of this Epistle.

(1.) He mentions in two passages the fact recorded in Exod. xxxii. 19, of Moses breaking the two tables of stone, and infers that Jehovah's covenant was thereby annulled. The falsity of this statement need not be pointed out to the Biblical student. He says, 'They (the Jews) have for ever lost that which Moses received. For thus saith the Scripture: And Moses received the covenant from the Lord, even two tables of stone, &c. But, having turned themselves to idols, they lost it; as the Lord said unto Moses, Go down quickly, &c. And Moses cast the two tables out of his hands, and their covenant was broken, that the love of Jesus might be sealed in your hearts unto the hope of his faith' (ch. iv.). The second passage, in ch. xiv., is very similar, and need not be quoted.

(2.) On the rite of Circumcision (Acts xv. 1, 2) we find in this Epistle equal incorrectness. The writer denies that circumcision was a sign of the covenant. 'You will say the Jews were circumcised for a sign, and so are all the Syrians and Arabians, and all the idolatrous priests.' Herodotus (ii. 37), indeed, asserts that the Syrians in Palestine received the practice of circumcision from the Egyptians; but Josephus, both in his *Antiquities* and *Treatise against Apion*, remarks that he must have alluded to the Jews, because they were the only nation in Palestine who were circumcised (*Antiq.* viii. 10, § 3; *Contr. Apion.* i. 22). 'How,' says Hug, 'could Barnabas, who travelled with Paul through the southern provinces of Asia Minor, make such an assertion respecting the heathen priests!'

(3.) Referring to the goat (chap. vii.), either that mentioned in Num. xix. or Lev. xvi., he says, 'All the priests, and they only, shall eat the unwashed entrails with vinegar.' Of this direction, in itself highly improbable, not a trace can be found in the Bible, or even in the Talmud.

(4.) In the same chapter, he says of the scape-

goat, that all the congregation were commanded to spit upon it, and put scarlet wool about its head; and that the person appointed to convey the goat into the wilderness took away the scarlet wool and put it on a thorn-bush, whose young sprouts, when we find them in the field, we are wont to eat; so the fruit of that thorn only is sweet. On all these particulars the Scriptures are silent.

(5.) In chap. viii. our author's fancy (as Mr Jones remarks) seems to grow more fruitful and luxuriant. In referring to the red heifer (Num. xix.), he says that men in whom sins are come to perfection (*ἐν οἷς ἁμαρτίαι τέλειαι*) were to bring the heifer and kill it; that three youths were to take up the ashes and put them in vessels; then to tie a piece of scarlet wool and hyssop upon a stick, and so sprinkle every one of the people. 'This heifer is Jesus Christ; the wicked men that were to offer it are those sinners who brought him to death; the young men signify those to whom the Lord gave authority to preach his Gospel, being at the beginning twelve, because there were twelve tribes of Israel.' But why (he asks) were there *three* young men appointed to sprinkle? To denote Abraham, Isaac, and Jacob. And why was wool put upon a stick? Because the kingdom of Jesus was founded upon the cross, &c.

(6.) He interprets the distinction of clean and unclean animals in a spiritual sense. 'Is it not (*Ἐρα οὐκ*—v. Dr. Hefele's valuable note, p. 85) the command of God that they should not eat these things?—(Yes.) But Moses spoke in spirit (*ἐν πνεύματι*). He named the swine, in order to say, Thou shalt not join those men who are like swine, who, while they live in pleasure, forget their Lord,' &c. He adds—Neither shalt thou eat of the hyæna: that is, thou shalt not be an adulterer.' If these were the views entertained by Barnabas, how must he have been astonished at the want of spiritual discernment in the Apostle Peter, when he heard from his own lips the account of the symbolic vision at Joppa, and his reply to the command—'Arise, Peter, slay and eat. But I said, Not so, Lord, for nothing common or unclean hath at any time entered into my mouth' (Acts xi. 8).

(7.) In ch. ix. he attempts to show that Abraham, in circumcising his servants, had an especial reference to Christ and his crucifixion:—'Learn, my children, that Abraham, who first circumcised in spirit, having a regard to the Son (*in Jesum*, Lat. Vers.), circumcised, applying the mystic sense of the three letters (*λαβὼν τριῶν γραμμάτων δόγματα—den geheimen Sinn dreier Buchstaben anwendend*, Hefele). For the Scripture says that Abraham circumcised 318 men of his house. What then was the deeper insight (*γνώσις*) imparted to him? Mark first the 18, and next the 300. The numeral letters of 18 are I (Iota) and H (Eta), I = 10, H = 8; here you have Jesus Ἰησοῦν; and because the cross in the T (Tau) must express the grace (of our redemption), he names 300; therefore he signified Jesus by two letters, and the cross by one.'

It will be observed that the writer hastily assumes (from Gen. xiv. 14) that Abraham circumcised only 318 persons, that being the number of 'the servants born in his own house,' whom he armed against the four kings; but he circumcised his household nearly twenty years later, inclu-

ing not only those born in his house (with the addition of Ishmael), but 'all that were bought with money' (Gen. xvii. 23). The writer evidently was unacquainted with the Hebrew Scriptures, by his committing the blunder of supposing that Abraham was familiar with the Greek alphabet some centuries before it existed.

Our limits will not allow us to enter into the question of the integrity of the Epistle in its present form; but this and several other topics are discussed very fully and with great ability in Dr. Hefele's *Treatise*, to which, and the other works mentioned below, the reader is referred.

A new and full Method of settling the Canonical Authority of the New Testament, by the Rev. Jeremiah Jones, Oxford, 1827, vol. ii. part iii. ch. 37-43; *Das Sendschreiben des Apostels Barnabas aufs Neue untersucht, übersetzt, und erklärt*, von Dr. Carl Joseph Hefele, Tübingen, 1840; *Patrum Apostolicorum Opera*, edidit C. J. Hefele, Tübingen, 1839; Lardner's *Credibility of the Gospel History*, part ii. ch. i.; Neander, *Allgemeine Geschichte der Christlichen Religion und Kirche*, i. 653, 1100, or, *History of the Christian Religion and Church*, translated by the Rev. J. H. Rose, 1841, vol. ii. pp. 329-331; *Lives of the most eminent Fathers of the Church*, by William Cave, D.D., Oxford, 1840, vol. i. pp. 90-105.—J. E. R.

BARRENESS is, in the East, the hardest lot that can befall a woman, and was considered among the Israelites as the heaviest punishment with which the Lord could visit a female (Gen. xvi. 2; xxx. 1-23; 1 Sam. i. 6, 29; Isa. xlvii. 9; xlix. 21; Luke i. 25; Niebuhr, p. 76; Volney, ii. 359). In the Talmud (*Yeramoth*, vi. 6) a man was *bound*, after ten years childless conjugal life, to marry another woman (with or without repudiation of the first), and even a third one, if the second proved also barren. Nor is it improbable that Moses himself contributed to strengthen the opinion of disgrace by the promises of the Lord of exemption from barrenness as a blessing (Exod. xxiii. 26; Deut. vii. 14). Instances of childless wives are found in Gen. xi. 30; xxv. 21; xxix. 31; Judg. xiii. 2, 3; Luke i. 7, 36. Some cases of unlawful marriages, and more especially with a brother's wife, were visited with the punishment of barrenness (Lev. xx. 20, 21); Michaelis, however (*Mosaïches Recht*, v. 290), takes the word עֵיִרִים here in a figurative sense, implying that the children born in such an illicit marriage should not be ascribed to the real father, but to the former brother, thus depriving the second husband of the share of patrimonial inheritance which would otherwise have fallen to his lot if the first brother had died childless.

This general notion of the disgrace of barrenness in a woman may early have given rise, in the patriarchal age, to the custom among barren wives of introducing to their husbands their maid-servants, and of regarding the children born in that concubinage as their own, by which they thought to cover their own disgrace of barrenness (Gen. xvi. 2; xxx. 3). [CHILDREN].—E. M.

BARSABAS. [JOSEPH BARSABAS; JUDAS BARSABAS.]

BARTHOLOMEW (Βαρθολομαῖος בַּר תּוֹלְמַי, i. e. the son of Tolmai: תּוֹלְמַי) is a name that occurs in the Old Testament (Josh. xv. 14); Sept.

Θολομαί, Θολομαί; Auth. Vers., *Tolmai*; (2 Sam. xiii. 37) Sept. Θολμαί, Θολομαί. In Josephus, we find Θολομαῖος (*Antiq.* xx. 1. § 1). The Θολομαῖος in *Antiq.* xiv. S. 1 is called Πτολεμαῖος in *Bell. Jud.* i. 9. § 3, not improbably by an error of the transcriber, as another person of the latter name is mentioned in the same sentence. Bartholomew was one of the twelve Apostles, and is generally supposed to have been the same individual who in John's gospel is called Nathanael. The reason of this opinion is, that in the three first gospels Philip and Bartholomew are constantly named together, while Nathanael is nowhere mentioned; on the contrary, in the fourth gospel the names of Philip and Nathanael are similarly combined, but nothing is said of Bartholomew. Nathanael therefore must be considered as his real name, while Bartholomew merely expresses his filial relation. He was a native of Cana in Galilee (John xxi. 2). He was introduced by Philip to Jesus, who, on seeing him approach, at once pronounced that eulogy on his character which has made his name almost synonymous with sincerity: 'Behold an Israelite indeed, in whom there is no guile!' (John i. 47).* He was one of the disciples to whom our Lord appeared after his resurrection, at the Sea of Tiberias (John xxi. 2); he was also a witness of the Ascension, and returned with the other apostles to Jerusalem (Acts i. 4, 12, 13). Of his subsequent history we have little more than vague traditions. According to Eusebius (*Hist. Eccles.* v. 10), when Pantænus went on a mission to the Indians (towards the close of the second century), he found among them the Gospel of Matthew, written in Hebrew, which had been left there by the apostle Bartholomew. Jerome (*De Vir. Illust.* c. 36) gives a similar account, and adds that Pantænus brought the copy of Matthew's Gospel back to Alexandria with him. But the title of Indians is applied by ancient writers to so many different nations, that it is difficult to determine the scene of Bartholomew's labours. Mosheim (with whom Neander agrees) is of opinion that it was a part of Arabia Felix, inhabited by Jews, to whom alone a Hebrew gospel could be of any service. Socrates (*Hist. Eccles.* i. 19) says that it was the India bordering on Ethiopia; and Sophronius reports that Bartholomew preached the Gospel of Christ Ἰησοῦ τοῖς κατοικοῦμένοις εὐδαίμοσιν. This apostle is said to have suffered crucifixion at Albanopolis in Armenia, or, according to Nicephorus, at Urbanopolis in Cilicia. A spurious gospel which bears his name is in the catalogue of apocryphal books condemned by Pope Gelasius (Fabricius, *Cod. Apoc.* i. 137; Mosheim, *Commentaries on the Affairs of the Christians*, &c., translated by Vidal, vol. ii. p. 6, 7; Tillemont, *Mémoires*, &c., i. 960, 1160; Neander, *Allgemeine Geschichte*, i. 113; Cave, *Lives of the Apostles*, Oxford, 1840, pp. 387-392).—J. E. R.

* We have thus the highest evidence of the falsehood in one instance (and the apostle John is another), of the assertion of the pseudo-Barnabas 'that Jesus selected for his apostles men laden with the greatest sins (ὕπερ πάντων ἀμαρτιῶν ἀνομωτέρους) in order to show that he came not to call the righteous, but sinners to repentance' (*Ep. Barnab.* ch. v.: v. Hafele's *Das Sendschreiben*, &c., p. 160).

BARTIMÆUS (*Βαρτιμαῖος*), the blind beggar of Jericho whom Christ restored to sight (Mark x. 46).

BARUCH (ברוך, *blessed*; Sept. *Βαρουχ*), the faithful friend and amanuensis of the prophet Jeremiah, was of a noble family of the tribe of Judah, and generally considered to be the brother of the prophet Seraiah, both being represented as sons of Nediah; and to Baruch the prophet Jeremiah dictated all his oracles. During the siege of Jerusalem, Baruch was selected as the depository of the deed of purchase which Jeremiah had made of the territory of Hanameel, to which deed he had been a witness. In the fourth year of the reign of Jehoiachin, king of Judah (B.C. 605), Baruch was directed to write all the prophecies delivered by Jeremiah up to that period, and to read them to the people, which he did from a window in the Temple upon two solemn occasions. He afterwards read them before the counsellors of the king at a private interview, when Baruch being asked to give an account of the manner in which the prophecy had been composed, gave an exact description of the mode in which he had taken it down from the prophet's dictation. Upon this they ordered him to leave the roll, advising that he and Jeremiah should conceal themselves. They then informed the king of what had taken place, upon which he had the roll read to him; but, after hearing a part of it, he cut it with a penknife, and, notwithstanding the remonstrances of his counsellors, threw it into the fire of his winter parlour, where he was sitting. He then ordered Jeremiah and Baruch to be seized, but they could not be found. The Jews to this day commemorate the burning of this roll by an annual fast.

Another roll was now written by Baruch from the prophet's dictation, containing all that was in the former, with some additions, the most remarkable of which is the prophecy respecting the ruin of Jehoiachin and his house, as the punishment of his impious act. This roll is the prophecy of Jeremiah which we now possess. Baruch, being himself terrified at the threats contained in the prophetic roll, received the comforting assurance that he would himself be delivered from the calamities which should befall Judah and Jerusalem. In the fourth year of Zedekiah (B.C. 593), Baruch is supposed by some to have accompanied Seraiah to Babylon, when the latter attended Zedekiah with the prophecies contained in Jeremiah, chaps. l. and li., which he was commanded by Jeremiah to read on the banks of the Euphrates, and then to cast the prophetic roll into the river, with a stone attached to it, to signify the everlasting ruin of Babylon (Jer. li. 61). At least, Baruch, in the book which bears his name [*BARUCH, BOOK OF*], is said to have read these prophecies at Babylon, in the hearing of king Jehoiachin and the captive Jews, in the fifth year of the taking of Jerusalem by the Chaldeans (see next article), which must have been the same taking of it in which Jehoiachin was made prisoner. For after the other taking of Jerusalem, in the eleventh year of the reign of king Zedekiah, when the Jews, after their return from Babylon, obstinately persisted in their determination to migrate to Egypt, against the remonstrances of the prophet, both Baruch and Jeremiah accompanied

them to that country, where they remained until the death of Jeremiah, and from whence there is no account in Scripture of Baruch's return. The Rabbins, however, allege that he died in Babylon, in the twelfth year of the exile (see Calmet's *Preface*). Josephus asserts that he was well skilled in the Hebrew language; and that, after the taking of Jerusalem, Nebuzaradan treated Baruch with consideration, from respect to Jeremiah, whose misfortunes he had shared, and whom he had accompanied to prison and exile (*Antiq.* x. 11).—W. W.

BARUCH, BOOK OF (*ΑΠΟΚΡΥΦΤΑ*), follows next after the book of Jeremiah in the Septuagint Version. It is the only one of the deutero-canonical books named in the catalogue of the celebrated fifty-ninth canon of the Council of Laodicea. If Baruch, the scribe of Jeremiah, be the author of this book, he must have removed from Egypt to Babylon immediately after the death of Jeremiah, inasmuch as the author of the book lived in Babylon in the fifth year after that event, unless we suppose, with Eichhorn, Arnold, and others, that the reference (Baruch i. 1) is to the fifth year of the captivity of Jehoiachin. Jahn (*Introductio in Epitomen redacta*, § 217, &c.) considers this latter opinion at variance with Baruch i. 1, where the destruction of Jerusalem is spoken of as having already taken place. De Wette (*Lehrbuch der Einleitung in das A. und N. T.*) ingeniously conjectures that *ἔτει* (year) is a mistake or correction of some transcriber for *μηνί* (month); and there is no question that the present reading, which mentions the year, and the *day* of the month, without naming the month itself, is quite unaccountable.

If Baruch, the friend of Jeremiah, was the author of the present work, it must be a translation from the Hebrew or Chaldee; and it is by no means impossible that this is the case, as the work abounds in Hebraisms. These Hebraisms, however, in the opinion of Jahn (*Introduction*), might have originated with a Jew writing Greek, although he leans to the opinion that, from the use of the word *manna*, and the frequent Hebraisms, this work not only does not belong to the Greek age of the Jews, but was actually written in Hebrew. This is also the opinion of Calmet (*Preface to Baruch*), Huet (*Demonstratio Evangelica*), and others; while Grotius, Eichhorn, and most of the German writers favour the idea of a Greek original. They conceive that the writer was some unknown person in the reign of Ptolemy Lagos, who, wishing to confirm in the true religion the Jews then residing in Egypt, attributed his own ideas to Baruch the scribe. There appears, however, no reason, on this latter hypothesis, why the author should speak of the return from Babylon. Grotius conceives that the book abounds not only in Jewish, but even in Christian interpolations (see Eichhorn's *Einleitung in die Apokryphe Schriften*).

Although Cyril of Jerusalem speaks of the book of Baruch as canonical, it is not expressly named in any of the ancient catalogues of the canon of Scripture, except, as already observed, that of the Council of Laodicea; and the remarkable circumstance of this being the only deutero-canonical book named in the canon of that Council has given rise to various conjectures. Dean Prideaux, indeed, conceives that the words of the

canon, 'Jeremiah, with Baruch, the Lamentations, and the Epistle,' were intended to express no more than Jeremiah's Prophecies and Lamentations; that by the *Epistle* is meant only the epistle in the 29th chapter of Jeremiah; and that Baruch's name is added only because of the part he bore in collecting them together, and adding the last chapter (*Connexion*, vol. i. p. 50). But on examining the Alexandrian manuscript in the British Museum, it will be seen that the arrangement of these books exactly tallies with the words of the canon. Immediately after Jeremiah follows Baruch, with its title and subscription; then the Lamentations, with title and subscription; and, last of all, the Epistle, with the title, 'The Epistle of Jeremiah,' and the following subscription, 'Jeremiah, Lamentations, and the Epistle.'

Whiston (*Authentic Records*, vol. i. p. 1, &c.) strongly contends for the canonicity of this book, founding his opinion on Origen's mode of citing it, with the formula 'It is written,' as well as his testimony, recorded by Eusebius (*Hist. Eccles.* vi. 25), that *The Epistle* (Baruch vi.) was owned by the Jews; in addition to the fact, that it is stated in the Apostolical Constitutions that the book of Baruch, together with the Lamentations, was publicly read in the synagogues on the tenth day of the month Gorpiceus.

Among the fathers the book of Baruch is cited generally as part of the book of Jeremiah,—by Irenæus, Cyprian, Clement of Alexandria, Eusebius, Ambrose, Augustin, Chrysostom, Basil, Epiphanius, and others. Augustin, having cited under the name of Jeremiah the passage in our Bibles, Baruch iii. 35-37, observes, 'Some ascribe this saying not to Jeremiah, but to Baruch, his amanuensis, but it is now known under the name of Jeremiah (*City of God*, ch. xxxiii.).' The book of Baruch is also cited as part of Jeremiah in the Roman office for the Saturday in Whitsun week. This mode of citing it most probably accounts for the fact of its name being omitted in the ancient catalogues, including those of Hippo and Carthage. It was at length cited as a separate book by the Council of Florence, and afterwards, not without a struggle (see Father Paul's history), by the Council of Trent.

It is at the same time observed by Calmet, that its 'canonicity had been denied not only by the Protestants, but by several Catholics,' among whom he instances Driedo, Lyranus, and Dionysius of Carthage. He considers that Jerome treats the book with harshness when (*Preface to Jeremiah*) that father observes, 'I have not thought it worth while to translate the book of Baruch, which is generally joined in the Septuagint version to Jeremiah, and which is not found among the Hebrews, nor the pseudepigraphal epistle of Jeremiah.' This is the epistle forming the sixth chapter of Baruch, the genuineness of which is questioned by several who acknowledge that of the former part of the book. Most modern writers of the Roman church, among whom are Du Pin (*Canon of Scripture*), Calmet (*Commentary*), and Allber (*Hermeneutica Generalis*), reckon this a genuine epistle of Jeremiah's. Jahn, however, after St. Jerome, maintains its spurious and pseudepigraphal character. This he conceives sufficiently attested by the difference of style, and its freedom from Hebraisms. He considers it to be an imitation of the Epistle of Jeremiah (ch. xxix.). This

Epistle, however, is confessedly more ancient than the second book of Maccabees, for it is there referred to (Macc. ii. 2, comp. with Baruch vi. 4) as an ancient document. The position of this letter varies in manuscripts; it sometimes precedes and sometimes follows Lamentations.

The book of Baruch was marked with obeli in Origen's *Hexapla*; the translation in the Latin Vulgate is older than the time of Jerome.

The subject of the book is (1) an exhortation to wisdom and a due observance of the law. (2) It then introduces Jerusalem as a widow, comforting her children with the hope of a return. (3) An answer follows in confirmation of this hope. A prologue is prefixed, stating that Baruch had read his book to Jeremiah and the people in Babylon by the river Sud (Euphrates), by which the people were brought to repentance, and sent the book with a letter and presents to Jerusalem.—

W. W.

BARZILLAI (בַּרְזַיִל), a wealthy old Gileadite of Rogelim, who distinguished himself by his loyalty when David fled beyond the Jordan from his son Absalom. He sent in a liberal supply of provisions, beds, and other conveniences for the use of the king's followers (2 Sam. xvii. 27; xix. 32). On the king's triumphant return, Barzillai attended him as far as the Jordan, but declined, by reason of his advanced age, to proceed to Jerusalem and receive the favours to which he had entitled himself.

BASAM, or BAAL-SHEMEN (בעלשמן, *balsam-tree*). The word *balm* occurs frequently in the authorized version, as in Gen. xxxvii. 25; xliii. 11; Jerem. viii. 22; xlv. 11; li. 8; and Ezek. xxviii. 17. In all these passages the Hebrew text has *tzeri*, translated *balm*, which is generally understood to be the true balsam, and is considered a produce of Gilead, a mountainous district, where the vegetation is that of the Mediterranean region and of Europe, with few traces of that of Africa or of Asia. But as it is not certain that *tzeri* indicates the balsam-tree, we shall confine our attention here to the latter, and reserve what we have to say respecting the former to the article TZERI.

The name balsam is no doubt derived from the Arabic بلسان *balesan*, which is probably also the origin of the βάλαμον of the Greeks. Forskal informs us that the balsam-tree of Mecca is there called Abosham, *i. e.* perodora. The word بشام *basham*, given by him, is the name of a fragrant shrub growing near Mecca, with the branches and tufts of which they clean the teeth, and is supposed to refer to the same plant. These names are very similar to words which occur in the Hebrew text of several passages of Scripture, as in the Song of Solomon, v. 1, 'I have gathered my myrrh with my spice' (*basam*); ver. 13, 'His cheeks are as a bed of spices' (*basam*); and in vi. 2, 'gone down into his garden to the beds of spices' (*basam*). The same word is used in Exod. xxxv. 28, and in 1 Kings x. 10, 'There came no more such great abundance of spices (*basam*) as those which the Queen of Sheba gave to King Solomon.' In all these passages *basom* or *bosom* בֶּשֶׂם and בָּשָׂם, though translated 'spices,' would seem to indicate the 'balsam-tree.

if we may infer identity of plant or substance from similarity in the Hebrew and Arabic names. But the word may indicate only a fragrant aromatic substance in general. The passages in the Song of Solomon may with propriety be understood as referring to a plant cultivated in Judæa, but not to spices in the general sense of that term. Queen Sheba might have brought balsam or balsam-trees, as well as spices, for both are the produce of southern latitudes, though far removed from each other.

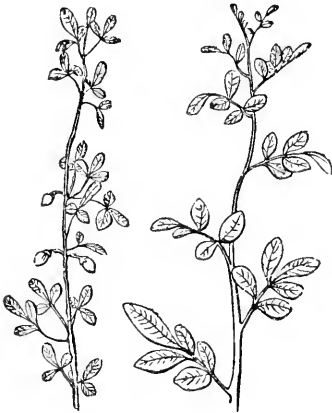

The balsam-tree was one of the most celebrated and highly esteemed among the ancients. Pliny (*Hist. Nat.* xii. 25) says, 'Sed omnibus odoribus præferunt balsamum, uni terrarum Judææ concessum. Ostendere arbusculam hanc urbi imperatores Vespasiani.' Pompey the Great also boasted of having had it borne in triumph. Justin the historian (xxxvi. 3) says, 'Opes genti Judaica, ex vectigalibus opobalsami crevere, quod in his tantum regionibus gignitur. Est namque vallis, &c. nomine Hierichus dicitur. In ea valle sylvæ est, et ubertate, et amœnitate arborum insignis; siquidem palmeto et opobalsamo distinguitur.' So Strabo and Diodorus Siculus. Dioscorides states that it is found in one valley of Judæa, and also in Egypt. At a much earlier period Theophrastus was aware of the fact that the balsamum tree was found in a valley of Syria, and that it was cultivated only in two gardens, one of twenty acres, the other much smaller, as is also stated by Pliny. Josephus informs us that the balsam is produced only in the plains of Jericho. Abdollatif ('Memorabilia of Egypt,' as quoted by Rosenmüller) says that he has read in Galenus that the best balsam is produced in Palestine; but now (in Abdollatif's age) he says, that no more balsam is found in that country; also that he knew of it only as 'carefully reared at Ain-Shames in Egypt, in an enclosed piece of ground.' Prosper Alpinus informs us that Messoner, a eunuch, governor of Cairo in 1519, caused to be brought from Arabia forty plants, which he placed in the garden of Matareah. Belon, in the early part of the sixteenth century, saw the shrubs in the balsam gardens of Matareah, a village near Cairo, and his description of them agrees very well with that

given by Abdollatif. Hence it would appear from ancient authors that the plant yielding balsam was never very common in Palestine—in fact, that it was confined to one locality, where it was found only as a plant in cultivation, though it may have been, and probably was, introduced at a very early period. That it has long disappeared from thence is evident from the authors we have just quoted, as well as from the testimony of all travellers in Palestine. That it was a southern plant we may believe from its being cultivated in the warm southern valley of Jericho, and that it was introduced into that locality we have the testimony of Josephus (*Antiq.* viii. 6), who says that it was brought thither by Queen Sheba. Strabo, moreover, states that myrrh, frankincense, and the balsam-tree were produced in the country of the Sabæans.

The balsam-tree, or balm of Gilead tree, as it is also very generally called, is not a native of that region, nor indeed does it appear ever to have been cultivated there. It is probable, therefore, that some other tree producing a balsamic secretion is intended in the above passages, where the word *balm* has been considered as the equivalent of *tzeri*. The true balsam, we have seen, was cultivated near Jericho, and at a later age in Egypt. From that country it has been traced to Arabia. Thus Gerlach, as quoted by Bergius, relates that the tree which produces the balsam of Mecca grows near Bederhunun, a village between Mecca and Medina, in a sandy rocky soil, confined to a small tract, about a mile in length. Strabo, we have found, was aware that the balsam-tree grows on the coast near Saba, in the happy land of the Sabæans. Bruce identifies this spot with that part of the African coast near the straits of Babelmandel, which now bears the name of Azab; and he further states, that among the myrrh-trees behind Azab all along the coast to the straits of Babelmandel is the native country of the balsam-tree. It grows to above fourteen feet high, spontaneously and without culture, like the myrrh, the coffee, and frankincense tree, all equally the wood of the country, and occasionally cut down and used for fuel. It was no doubt early transplanted into Arabia, that is, into the southern part of Arabia Felix, immediately fronting Azab: the high country of Arabia was too cold for it, being all mountainous, and water freezing there. The first plantation that succeeded seems to have been at Petra, the ancient metropolis of Arabia, now called Beder, or Beder Hunein. Bruce has, moreover, given two figures of the balsam-tree,—one of the whole tree, the other of a single branch, with the dissection of the fruit. These, he says, may be depended on, as being carefully drawn, after an exact examination, from two very fine trees brought from Beder-Hunein. Salt also found it on the west coast of the Red Sea, and Mr. Brown, having examined his specimen, is sufficient evidence of its authenticity.

The balsam-tree, having been seen by Bruce and Salt, and figured by the former as well as by Nees von Esenbeck, and introduced into India, has been described by the first and by Wight and Arnott, and is now pretty well known. It forms a middle-sized tree, with spreading branches and a smooth ash-coloured bark, but which is no doubt rough in the older parts, as represented by Bruce. The ultimate branches are short, and thorn-like, with

small very short abortive branchlets, bearing at their extremities the leaves and flowers. The fruit is pointed, fleshy, with a viscid pulp; nut 4-angled; 1—2-celled, containing one perfect seed.

This species is now considered to be identical with the *Amyris opobalsamum* of Forskal, found by him in Arabia, in the neighbourhood of the caravanserai of Oude, not far from Has, where it is called **أبو شام** aboosham, *i. e.* perodora; and the wounded bark of which yields opobalsamum, or balsam of Mecca. It is as highly esteemed by all Orientals in the present day as it was by the civilized nations of antiquity. Another species, discovered by Forskal, and called by him *Amyris Küfal*, from its Arabic name **قفل**, is now also referred to the genus *Balsamodendron*. It is a tree with reddish-coloured wood, and with branches rather spinous. The younger leaflets are described as being villous and acute, the old ones smooth, often obtuse; the berry compressed, with an elevated ridge on each side, the apex forming a black prominent point. The wood he describes as forming an article of considerable commerce, especially to Egypt, where water-vessels are impregnated with its smoke. It is probably the twigs of this species which are taken to India, and there sold under the name of aod-i balessan; that is, the wood of the balsam-tree, and therefore analogous to the xylobalsamum of the ancients. *Carpobalsamum* was probably only the fruit of one of these species. *Opobalsamum*, or juice of the balsam, is generally described as the finest kind, of a greenish colour, and found in the kernel of the fruit. *Carpobalsamum* is said to have been made by the expression of the fruit when in maturity, and xylobalsamum, by the expression or decoction of the small new twigs, which are of a reddish colour. But the ancients probably employed both the fruit and the wood for macerating in oil, which would extract the odour. The greatest quantity of balsam, and the best in quality, must in all times have been produced by an incision into the bark when the juice is in its strongest circulation, in July, August, and the beginning of September. It is then received into a small earthen bottle, and every day's produce is poured into a larger, which is kept closely corked. The whole quantity collected is but small. When Sultan Selim conquered Egypt and Arabia in 1516, three pounds were ordered to be sent yearly as a tribute to Constantinople.

If, then, we compare ancient statements with modern investigations, we find that the latter confirm the former, as to the balsam-tree being a native of southern latitudes,—that is, of Arabia and the opposite coast of Africa; to both of which regions Bruce supposes the name of Saba to have been applied. Again, if we consider the estimation in which the tree is even now held by Oriental nations, we shall have no difficulty in believing that the ancients may have equally valued it; and if so, the probability is, that it would be noticed in some part of the Old Testament, as we find it is, in the above passages of the *Canticles*, *Exodus*, and *Kings*; while the Hebrew and Arabic names are too similar to allow us to doubt their being applied to the same plant,

namely, the far-famed balsam-tree of Arabia and Africa.—J. F. R.

BASCA, or BASCAMA, a town near Bethshan, where Jonathan Maccabæus was killed (1 Macc. xiii. 23; Josh. xiii. 1).

BASHAN, **בַּשָּׁן** and **הַבַּשָּׁן**; Samaritan Vers **בַּתְּנַן**; Targ. **בַּתְּנַן**, Ps. lxxviii. 13, also **בַּתְּנַן**; the latter Buxtorf suggests may have originated in the mistake of a transcriber, yet both are found in Targ. Jon.; Deut. xxxiii. 22; v. *Lex. Talm.* col. 370; Sept. **Βασάν** and **Βασανίτις**; Josephus and Eusebius, **Βατανάλα**. *El Bottein* is the modern name. The word probably denotes the peculiar fertility of the soil: in the ancient versions, instead of using it as a proper name, a word meaning *fruitful* or *fat* is adopted. Thus in Ps. xxiii. 13, for *Bashan*, we find in Sept. **πίδες**; Aquila, **λιπαροί**; Symmachus, **σιτιστοί**; and Vulg. *Pinguet* (Ps. lxxviii. 16), for *hill of Bashan*; Sept. **ὄρος πίων**; Jerome (v. Bochart, *Hierozoicon*, pars i. col. 531), **mons pinguis**. The sacred writers include in Bashan that part of the country eastward of the Jordan which was given to half the tribe of Manasseh, situated to the north of Gilead. Bochart incorrectly places it between the rivers Jabok and Arnon; and speaks of it as the allotment of the tribes of Reuben and Gad (Num. xxxii. 33). The first notice of this country is in Gen. xiv. 5. Cherdorlaomer and his confederates 'smote the Rephaim in Ashtaroth Karnaïm.' Now Og, king of Bashan, dwelt in Ashtaroth, and 'was of the remnant of the Rephaim' ('giants' Auth. Vers.), Joshua xii. 4. When the Israelites invaded the Promised Land, Argob, a province of Bashan, contained 'sixty fenced cities, with walls and gates and brazen bars, besides unwall'd towns a great many' (Deut. iii. 4, 5; 1 Kings iv. 13). These were all taken by the Israelites, and Og and his people utterly destroyed. Golan, one of the cities of refuge, was situated in this country (Deut. iv. 43; Josh. xx. 8; xxi. 27). **Γαυλανῶν ἐν τῇ Βαταναιᾷ** (Joseph. *Antiq.* iv. 7. § 4). Solomon appointed twelve officers to furnish the monthly supplies for the royal household, and allotted the region of Argob to the son of Geber (1 Kings iv. 13). Towards the close of Jehu's reign, Hazael invaded the land of Israel, and smote the whole eastern territory, 'even Gilead and Bashan' (2 Kings x. 33; Joseph. *Antiq.* ix. 8. § 1); but after his death the cities he had taken were recovered by Jehoash (Joash) (2 Kings xiii. 25), who defeated the Syrians in three battles, as Elisha had predicted (2 Kings xiii. 19; Joseph. *Antiq.* ix. 8. § 7). After the captivity the name *Batanæa* was applied to only a part of the ancient Bashan; the rest being called *Trachonitis*, *Auranitis*, and *Gaulanitis* (v. Lightfoot's *Chorographical Notes* upon the places mentioned in St. Luke: Works, vol. x. p. 282). All these provinces were granted by Augustus to Herod the Great, and on his death *Batanæa* formed a part of Philip's tetrarchy (Joseph. *De Bell. Jud.* ii. 6. § 3; *Antiq.* xviii. 4. § 6). At his decease, A.D. 34, it was annexed, by Tiberius, to the province of Syria; but in A.D. 37 it was given by Caligula to Herod Agrippa, the son of Aristobulus, with the title of king (Acts xii. 1; Joseph. *Antiq.* xviii. 6. § 10). From the time of Agrippa's death, in A.D. 44, to A.D. 53, the government again reverted to the Romans, but it

was then restored by Claudius to Agrippa II. (Acts xxv. 13; Joseph. *Antiq.* xx. 7. §1).

The richness of the pasture-land of Bashan, and the consequent superiority of its breed of cattle, are frequently alluded to in the Scriptures. We read in Deut. xxxii. 14, of 'rams of the breed (Heb. *sons*) of Bashan.' (Ezek. xxxix. 18) 'Rams, lambs, bulls, goats, all of them fattings of Bashan.' The oaks of Bashan are mentioned in connection with the cedars of Lebanon (Isa. ii. 13; Zech. xi. 2). In Ezekiel's description of the wealth and magnificence of Tyre it is said, 'Of the oaks of Bashan have they made their cars' (xxvii. 6). The ancient commentators on Amos iv. 1, 'the kine of Bashan,' Jerome, Theodoret, and Cyril, speak in the strongest terms of the exuberant fertility of Bashan (Bochart, *Hierozoicon*, pars i. col. 306), and modern travellers corroborate their assertions (v. Burckhardt's *Travels in Syria and the Holy Land*, pp. 286-288; Buckingham's *Travels in Palestine*, through the countries of Bashan and Gilead, London, 1822, vol. ii. pp. 112-117).—J. E. R.

BASKET. There are several words in the Hebrew Scriptures by which different kinds of baskets appear to be indicated:—

1. **דוד** *dud*, which occurs in 2 Kings x. 7, where the heads of Ahab's sons are sent from Samaria to Jezreel in baskets; Jer. xxiv. 2, as containing figs; and Ps. lxxxi. 6 (rendered *pots*), also as containing figs; where, therefore, deliverance from the baskets means deliverance from the bondage of carrying burdens in baskets. In fact, very heavy burdens were thus carried in Egypt, as corn in very large baskets from the field to the threshing-floor, and from the threshing-floor to the granaries. They were carried between two men by a pole resting on their *shoulders*; which agrees with the previous clause of the cited text, 'I removed his shoulder from the burden.' This labour and form of the basket are often shown in the Egyptian sculptures.

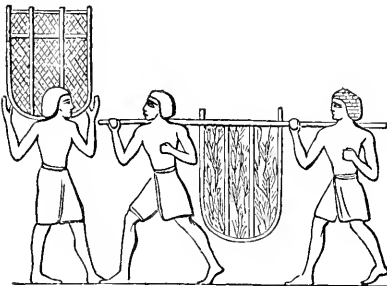

2. **טבה** *teba*, which occurs in connection with agricultural objects, 'the basket and the store' (Deut. xxvi. 2-4; xxviii. 5-17), and would therefore appear to have been somewhat similar to the above; and, in fact, the Egyptian sculptures show different baskets applied to this use.

3. **כלוב** *kelub*. From the etymology, this appears to have been an interwoven basket, made of leaves or rushes. In Lev. v. 27, however, it is used for a bird-cage, which must have been of open-work, and probably not unlike our own wicker bird-cages. The name is also applied to fruit-baskets (Amos viii. 1, 2), Egyptian examples of

which are presented in figs. 2 and 4 (which contain pomegranates) of the annexed cut.

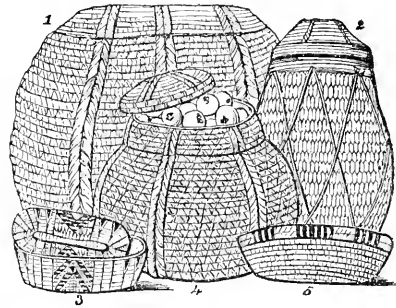

[Ancient Egyptian.]

4. **סלסילות** *salsilloth*, occurs only in Jer. vi. 9, where it obviously denotes baskets in which grapes were deposited as they were gathered. The form of the baskets used for this purpose is often shown on the Egyptian monuments, and is similar to that represented in fig. 4, cut 3.

5. In all the other places where the word basket occurs, we are doubtless to understand a basket made of rushes, similar both in form and material to those used by carpenters for carrying their tools. This is still the common kind of basket throughout Western Asia; and its use in ancient Egypt is shown by an actual specimen which was found in a tomb at Thebes, and which is now in the British Museum. It was, in fact, a carpenter's basket, and contained his tools (fig. 1).

The specimens of Egyptian baskets in the British Museum, represented in our cut, convey a favourable idea of the basket-work of ancient times. Some of these are worked ornamentally with colours (figs. 3, 5, cut 2); also the modern examples, figs. 2, 7, cut 3). And besides these the monuments exhibit a large variety of hand-baskets, of different shapes, and so extensively employed as to show the numerous applications of basket-work in the remote times to which these representations extend. They are mostly manufactured, the stronger and larger sorts of the fibres, and the finer of the leaves of the palm-tree, and not infrequently of rushes, but more seldom of reeds.

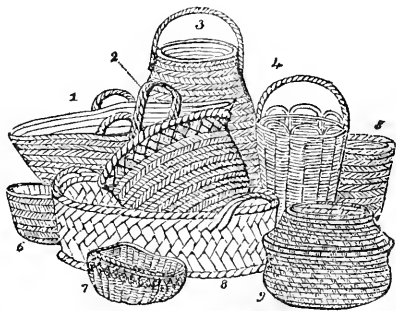

[Modern Oriental.]

In the preceding cut of examples of modern Oriental baskets, many are of the same form, and

mostly of the same materials as those found in the Egyptian tombs or pictured on their walls. We doubt not that the three engravings taken together furnish examples of all the different kinds of baskets in use among the Israelites.

BASTARD. By this word the Anth. Vers. renders the Hebrew בְּמִיּוֹר, which occurs only in Deut. xxiii. 2, and Zech. ix. 6. But Michaelis (*Mos. Recht*, ii. § 139) reads the word with a different punctuation, so as to make it a compound of two words בְּמִיּוֹר, meaning *stain, defect* of a *stranger*, implying the stain that would be cast upon the nation by granting to such a stranger the citizen-right. Some understand by it the offspring of prostitutes, but they forget that prostitutes were expressly forbidden to be tolerated by the law of Moses (Lev. xix. 29; Deut. xxiii. 17). The most probable conjecture is that which applies the term to the offspring of heathen prostitutes in the neighbourhood of Palestine; since no provision was made by Moses against their toleration (Potter, *Archæol.* i. 354), and who were a sort of priestesses to the Syrian goddess *Astarte* (comp. Num. xxv. 1, *sq.*; Gesenius, *Comment. on Isaiah*, ii. 339; Hos. iv. 14; 1 Kings xiv. 24, xv. 12; xxii. 47; 2 Kings xxiii. 7; Herodot. i. 199).

That there existed such bastard offspring among the Jews, is proved by the history of Jephthah (Judg. xi. 1-7), who on this account was expelled, and deprived of his patrimony.—E. M.

BAT (בַּת הַצִּפּוֹרִים, *'atalleph*) occurs in Lev. xi. 19; Deut. xiv. 18; Isa. ii. 20; and Baruch vi. 22. In Hebrew the word implies flying in the dark; which, taken in connection with the sentence 'moreover the othelaph and every creeping thing that flieth is unclean unto you; they shall not be eaten,' is so clear, that there cannot be a mistake respecting the order of animals meant; though to modern zoology neither the species, the genus, nor even the family is thereby manifested: the injunction merely prohibits eating bats, and may likewise include some tribes of insects. At first sight, animals so diminutive, lean, and repugnant to the senses, must appear scarcely to have required the legislator's attention, but the fact evidently shows that there were at the time men or tribes who ate animals classed with bats, a practice still in vogue in the great Australasian islands, where the frugivorous Pteropi of the harpy or goblin family, by our seamen denominated flying-dogs, and erroneously vampyres, are caught and eaten; but where the insectivorous true bats, such as the genera common in Europe, are rejected. Some of the species of harpies are of the bulk of a rat, with from three to four feet of expanse between the tips of the wings; they have a fierce dog-like head, and are nearly all marked with a space of rufous hair from the forehead over the neck and along part of the back.

They reside in the most dense foliage of large trees, whence they fly out at night and do considerable damage to the plantations of fruit-trees. Among them the *Pteropus edulis*, kalong or edible goblin bat, is conspicuous, and not unfrequently found in our museums of natural history. The first tribe of them, distinguished by being without tails, is not at present known in Egypt or Northern Arabia, but of the second, having tails, a large species was discovered by M. Geoffroy

in the pyramids, and a very large one is figured on the oldest monuments. Species of this or of both are likewise common in Madagascar; and thence it may be inferred that they still exist in Southern Arabia. It was to one or more species of this section of Cheiroptera that we think the Mosaic prohibition was chiefly directed; and it is likewise to them that may be referred the foundation of the ancient legends concerning harpies, which, however much they may be distorted, have a basis of truth. Indeed, when we consider their voice, the faculty they have of feeding with their thumbs, their formidable teeth, their habit of flying in the day during dark weather, and their willingness, though they are frugivorous, to devour not only insects, but also the blood and flesh of small animals, we may admit that originally they were more daring in the presence of man; that their true characters are but moderately amplified by poetical fancy; and that the Mosaic injunction was strikingly appropriate.

In the texts of Scripture, where allusion is made to caverns and dark places, true Vespertilionide, or insect-eating bats, similar to the European, are clearly designated.—C. H. S.

BATANÆA. [BATHAN.]

BATH KOL (בַּת קוֹל, *daughter of the voice*).

Under this name the *Talmud*, the later Targums, and the Rabbinical writers, make frequent mention of a kind of oracular voice, constituting the fourth grade of revelation, which, although it was an instrument of divine communication throughout the early history of the Israelites, was the most prominent, because the sole, prophetic manifestation which existed during (and even after) the period of the second Temple. The *Midrashim* and the *Gemara*, cited in Reland's *Antiq. Sacr.* pt. ii. ch. ix., severally affirm that the Bath Kol is the voice which spoke to Abraham, Moses, David, Nebuchadnezzar, and others; and the Targums of Jonathan and of Jerusalem make the Bath Kol appear in Gen. xxxviii. 26; Num. xxi. 6; and in other places. The treatise *Sanhedrin*, cited in Vitringa's *Obscr. Sacr.* ii. 338, uses the words:—'From the death of Haggai, Zechariah, and Malachi, the Holy Spirit (רוח הקדוש) which, according to the Jewish distinction, is only the second degree of the prophetic gift) was withdrawn from Israel; but they nevertheless enjoyed the use of the Bath Kol.'

The Jewish authorities are not agreed as to what the Bath Kol was, nor as to the precise reason of its designation. It is disputed whether the persons hearing the Bath Kol heard the very voice from heaven, or only a daughter of it—an *echo* of it; whether, as thunder is often mentioned as a sign of the Divine presence, and as the word *voice* appears to be used for thunder in Exod. ix. 23; Jer. x. 13; Ps. xxix. 3, the Bath Kol may not signify an articulate voice proceeding out of the thunder; or whether, according to the explanation of Maimonides, 'the Bath Kol is when a man has such a strong imagination that he believes he hears a voice from without himself.' As to the meaning of the name itself, passages are cited in Buxtorf's *Lex. Talm.* s. v. בַּת, and in Reland's *Antiq. Sacr.* l. c., which show that the daughter of the voice sometimes means the echo of a sound, and sometimes merely a pri-

mary sound itself. It is certain that the *Peshito* has sometimes rendered the simple Greek *φωνή* by 'daughter of the voice,' as in Acts xii. 22; 1 Tim. vi. 20; Heb. iii. 15. It is necessary, however, to remark that, according to a fundamental law of all Syro-Arabian grammar, these two words must either stand to each other in the relation of *apposition*, or of the *state construct*. But as apposition can only take place between equivalent and convertible terms, which 'daughter' and 'voice' are not, accordingly, the alternative rendering of *daughter voice* proposed by Prideaux (which Horne also has adopted, *Introduct.* iv. p. 149) violates that rule; because, in such an English combination, the word 'daughter' has the force of an *adjective*; and the Hebrew language, possessing but few adjectives, would have expressed the sense of *daughter voice* (if that had been the sense intended to be conveyed by Bath Kol) by making Bath the *last* word, depending as a genitive on the former. For instance, what we render the Holy Spirit is literally 'the spirit of holiness' in Hebrew. Thus '*daughter voice*' is not an apposition in English, nor is it the translation of a state construct according to the Hebrew order; but of a state construct in which Prideaux has taken the liberty of transposing the dependent word, *i. e.* of making 'daughter of the voice' become, in effect, 'voice of a daughter.' Jennings also, in his *Jewish Antiq.* p. 229, when he renders Bath Kol by '*filia vocis, seu filia vocis*,' only commits, in the first case, the same error more palpably; and is guilty of quite as great a violation of the first principle of Hebrew grammar, as he would be, in the case of Latin, were he to translate *filia vocis* by 'voice of the daughter.'

The occasions on which it is alleged that the Bath Kol was heard after the death of Malachi are of very various degrees of solemnity or significance. Supposing the instances mentioned in Josephus (*Antiq.* xiii. 10), of the voice which announced to Hyrcanus that his sons had conquered Antiochus, and (*De Bell. Jud.* vi. 5) of the awful voice which was heard in the Temple, just before the capture of Jerusalem, to exclaim, *Μεταβαίνομεν ἐν τειχέσιν*—not to belong to the Bath Kol (as it is to be observed that the pseudo-Josephus ben Gorion has, in these cases, merely used the Hebrew word for *voice*), most of the other recorded instances fall far short of these in dignity; and some appear irreconcilable to even very credulous notions of the limits of Divine interposition. Only a few of them, however, can be classed with quite as trivial a species of divination as the Sortes Virgilianæ, which is done in the unfair statement of Prideaux (*Connex.* ii. p. 354). The fact is, that most Christian writers who have treated of the Bath Kol have not been able to divest themselves of an undue desire to discredit its pretensions, in consequence of their fearing any comparison which might be instituted between it and the voices from heaven mentioned in the New Test. Indeed, Lightfoot (in his *Hor. Hebr.* ad Matth. iii. 17) considers all cases of Bath Kol to be either Jewish fables or devices of the devil. Instances of voices from heaven, on occasions outwardly very analogous to some among the Jews, are recorded in the history of the early Christian church; as the voice which was instrumental in making Alexander bishop of Jerusalem, and that

which exhorted Polycarp to be of good courage (Eusebii *Hist. Eccles.* vi. 11; iv. 15).

Two very learned dissertations on the Bath Kol may be found in Vittinga's *Obser. Sacr.* ii. pp. 341-363; and (by Danz) in Meuschen's *Nov. Test. ex Talmude illustratum*, pp. 351-378.—J. N.

BATH-SHEBA, also BATH-SHUA, daughter of Eliam, grand-daughter of Ahitophel, and wife of Uriah. She was seduced and became pregnant by King David during the absence of her husband, who was then engaged at the siege of Rabbah (2 Sam. xi. 4, 5; Ps. li. 2). The child thus born in adultery became ill and died (2 Sam. xii. 15-18). After the lapse of the period of mourning for her husband, who was slain by the contrivance of David (xi. 15), she was legally married to the king (xi. 27), and bore him Solomon (xii. 24; 1 Kings i. 11; ii. 13). In 1 Chron. iii. 5 she is called Bath-shua instead of Bathsheba; and her father, Ammiel, instead of Eliam (comp. Matt. i. 6). The other children of Bath-sheba are named in 2 Sam. v. 14; 1 Chron. iii. 5. She is afterwards noticed only in consequence of her good-natured intercession for Adonijah; which incidentally displays the respect with which she was treated by king Solomon, her son (1 Kings ii. 19). [DAVID, ADONIJAH.]

The Rabbins describe Bath-sheba as a woman of vast information and a highly cultivated mind, to whose education Solomon owed much of his wisdom and reputation, and even a great part of the practical philosophy embodied in his Proverbs.—E. M.

BATTLE, SYSTEM OF. Though the Hebrews in their mode of conducting warlike operations varied somewhat in the course of ages, and are elsewhere shown to have been swayed by the practice of greater and more military nations, still, from the period when the institution of royalty gave rise to an organized system, it was a maxim to spare the soldiers all unnecessary fatigue before an engagement, and to supply them liberally with food. Their arms were enjoined to be in the best order, and when drawn up for battle they formed a line of solid squares of a hundred men, each square being ten deep, and with sufficient interval between to allow of facility in movements, and the slingers to pass through. The archers may have occupied the two flanks, or formed in the rear, according to the intentions of the commander on the occasion; but the slingers were always stationed in the rear until they were ordered forward to impede an hostile approach, or to commence the engagement, somewhat in the manner of modern skirmishers. Meantime, while the trumpets waited to sound the last signal, the king, or his representative, appeared in his sacred dress (the *הדר* 'hadre' *kodesh*, rendered in our version 'the beauties of holiness'), except when he wished to remain unknown, as at Megiddo (2 Chron. xxxv. 22); and proceeded to make the final dispositions, in the middle of his chosen braves, attended by priests who, by their exhortations, animated the ranks within hearing. It was now, we may suppose, when the enemy was at hand, that the slingers would be ordered to pass between the intervals of the line of solid squares, open their order, and with shouts, let fly their stone or leaden missiles, until by the gradual approach of the opposing fronts they would be hemmed in, and be recalled

to the rear, or to cover a flank. Then would come the signal to charge, and the great shout of battle; the heavy infantry, receiving the order to attack, would, under cover of their shields and levelled spears, press direct upon the front of the enemy; the rear ranks might then, if so armed, cast their second darts, and the archers from the rear shoot high, so as to pitch the arrows over their own main line of spearmen into the dense masses beyond them. If the enemy broke through the intervals, we may imagine that a line of charioteers in reserve, breaking from their position, might in part charge among the disordered ranks of the foe, drive them back, and facilitate the restoration of the oppressed masses, or wheeling round a flank, fall upon the enemy, or be encountered by a similar manœuvre, and perhaps repulsed. The king, meanwhile, surrounded by his princes, posted close to the rear of his line of battle, and in the middle of the showered missiles, would watch the enemy and remedy every disorder. In this position it was that several of the sovereigns of Judah were slain (2 Chron. xviii. 33, and xxxv. 23), and that such an enormous waste of human life took place; for the shock of two hostile lines of masses, at least ten in depth, advancing under the confidence of breastplate and shield, when once engaged hand to hand, had difficulties of no ordinary nature to retreat; because the hindermost ranks not feeling personally the first slaughter, would not, and the foremost could not, fall back; neither could the commanders disengage the line without a certainty of being defeated. The fate of the day was therefore no longer within the control of the chief, and nothing but obstinate valour was left to decide the victory. Hence, from the stubborn character of the Jews, battles fought among themselves were particularly sanguinary; such, for example, as that in which Jeroboam, king of Israel, was defeated by Abijah of Judah (2 Chron. xiii. 3, 17), wherein, if there be no error of copyists, there was a greater slaughter than in ten such battles as that of Leipzig, although on that occasion three hundred and fifty thousand combatants were engaged for three successive days, provided with all the implements of modern destruction in full activity. Under such circumstances defeat led to irretrievable confusion; and where either party possessed superiority in cavalry and chariots of war, it would be materially increased: but where the infantry alone had principally to pursue a broken enemy, that force, laden with shields, and preserving order, could overtake very few who chose to abandon their defensive armour, unless they were hemmed in by the locality. Sometimes a part of the army was posted in ambush, but this manœuvre was most commonly practised against the garrisons of cities (Josh. viii. 12; Judg. xx, 38). In the case of Abraham (Gen. xiv. 16), when he led a small body of his own people suddenly collected, and fell upon the guard of the captives, released them, and recovered the booty, it was a surprise, not an ambush; nor is it necessary that he should have fallen in with the main army of the enemy. At a later period, there is no doubt that the Hebrew armies, in imitation of the Romans, formed into more than one line of masses; but there is ample evidence that they always possessed more stubborn valour than discipline.—

C. H. S.

BATTELEMENT. [HOUSE.]

BAY-TREE. [EZRACI.]

BDELLIUM. [BEDOLACH.]

BEAN. [PHUL.]

BEAR (𐤁𐤀𐤂) *dob*, in Arabic *dub*, in Persic *deeb* and *dob*, is noticed in 1 Sam. xvii. 34, 36, 37; 2 Sam. xvii. 8; 2 Kings ii. 24; Prov. xvii. 12; xxviii. 15; Isa. xi. 7; Lam. iii. 10; Hos. xiii. 8; Amos v. 19, &c. Although the moderns have



[Ursus Syriacus.]

denied the existence of bears in Syria and Africa, there cannot be a doubt of the fact, and of a species of the genus *Ursus* being meant in the Hebrew texts above noted. David defended his flock from the attacks of a bear (1 Sam. xvii. 34, 35, 36), and bears destroyed the children who mocked the prophet (2 Kings ii. 24). The genus *Ursus* is the largest of all the plantigrade carnassiers, and with the faculty of subsisting on fruit or honey unites a greater or less propensity, according to the species, to slaughter and animal food. To a sullen and ferocious disposition it joins immense strength, little vulnerability, considerable sagacity, and the power of climbing trees. The brown bear, *Ursus arctos*, is the most sanguinary of the species of the Old Continent, and *Ursus Syriacus*, or the bear of Palestine, is one very nearly allied to it, differing only in its stature being proportionably lower and longer, the head and tail more prolonged, and the colour a dull buff or light bay, often clouded, like the Pyrenean variety, with darker brown. On the back there is a ridge of long semi-erect hairs running from the neck to the tail. It is yet found in the elevated woody parts of Lebanon. In the time of the first crusades these beasts were still numerous and of considerable ferocity; for during the siege of Antioch, Godfrey of Bouillon, according to Math. Paris, slew one in defence of a poor woodcutter, and was himself dangerously wounded in the encounter.—C. H. S.

BEARD. The ancient nations in general agreed with the modern inhabitants of the East in attaching a great value to the possession of a beard. The total absence of it, or a sparse and stunted sprinkling of hair upon the chin, is thought by the Orientals to be as great a deformity to the features as the want of a nose would appear to us; while, on the contrary, a long and bushy beard, flowing down in luxuriant profusion to the breast, is considered not only a most graceful ornament to the person, but as contributing in no small degree to respectability and dignity of character. So much, indeed, is the possession of this

venerable badge associated with notions of honour and importance, that it is almost constantly introduced, in the way either of allusion or appeal, into the language of familiar and daily life. When a man's veracity is doubted, 'Look at this beard,' he will say, 'the very sight of it may satisfy you as to the truth and probity of its owner.' When censuring a bad or dishonest action, 'Shame on your beard' is the ordinary style of rebuke. When friends express their mutual good wishes, 'May God preserve your beard' is the strongest and most ardent form of benediction. When requesting a favour from any one, the most earnest terms of supplication are to beg 'by his beard, or the life of his beard,' that he will grant it; and no higher idea of the value of a thing can be given than by saying, 'It is worth more than one's beard.' In short, this hairy appendage of the chin is most highly prized as the attribute of manly dignity; and hence the energy of Ezekiel's language when, describing the severity of the Divine judgments upon the Jews, he intimates that, although that people had been as dear to God and as fondly cherished by him as the beard was by them, the razor, *i. e.* the agents of his angry providence, in righteous retribution for their long-continued sins, would destroy their existence as a nation (Ezek. v. 1-5). With this knowledge of the extraordinary respect and value which have in all ages been attached to the beard in the East, we are prepared to expect that a corresponding care would be taken to preserve and improve its appearance; and, accordingly, to dress and anoint it with oil and perfume was, with the better classes at least, an indispensable part of their daily toilet (Ps. cxxxiii. 2). In many cases it was dyed with variegated colours, by a tedious and troublesome operation, described by Morier (*Journ.* p. 247), which, in consequence of the action of the air, requires to be repeated once every fortnight, and which, as that writer informs us, has been from time immemorial a universal practice in Persia. From the history of Mephiboseth, it seems probable, that the grandees in ancient Palestine 'trimmed their beards' with the same fastidious care and by the same elaborate process; while the allowing these to remain in a foul and dishevelled state, or to cut them off, was one among the many features of sordid negligence in their personal appearance by which they gave outward indications of deep and overwhelming sorrow (2 Sam. xix. 24; Ezra ix. 13; Isa. xv. 2; Jer. xli. 5; comp. Herodot. ii. 36; Suet. *Caligula*, ch. v.).

Nor were they less jealous in guarding the honour of this attribute of manhood, than in setting it off to advantage. The slightest exhibition of contempt, by sneering, spitting at, pulling, or even pressing against it in a rude and careless manner, was resented as an insult, such as would now, among men of the world, be deemed expiable only by a duel (Burckhardt, *Trav. in Arabia*, p. 61). No one was permitted to touch it except in the way of respectful and affectionate salutation, which was done by gently taking hold of its extremity with the right hand, and kissing it; but even in that case it was only wives in approaching their husbands, children their parents, or the nearest and most attached friends, to whom this unusual liberty was granted (D'Arvieux, *Coutumes des Arabes*, ch. 7). The act itself being an expression of kind and cordial

familiarity, its performance by Joab shows in a flagrant light the base and unprincipled conduct of that ruthless veteran, when he took Amasa by the beard with his right hand to kiss him (rather *it*), and then, having assumed this attitude under the mask of the most friendly feelings, smote his unsuspecting victim under the fifth rib (2 Sam. xx. 9).

To be deprived of a beard was, and still is, in some places of the East, the badge of servility—a mark of infamy, that degraded a person from the ranks of men to those of slaves and women (Niebuhr, *Arabia*, ch. vii.; Volney, ii. p. 118); while to shave it off voluntarily, even for a time, as the former writer mentions he knew was done by some in mere wantonness or a drunken fit, frequently subjects the offender to so great odium as to exclude him from society. Nay, so great is the disgrace entailed by the appearance of a smooth and naked chin, that D'Arvieux describes the case of an individual who, having sustained a dangerous wound in his jaw, preferred hazarding his life rather than allow the surgeon to remove his beard. Among people influenced by such ideas, the forcible erasure of a beard must be felt to be the severest punishment that the malice of an enemy can inflict; and we can easily conceive how deep and intolerable was the affront which the young and ill-advised king of the Ammonites put upon the ambassadors of David, when, among other acts of insolence, he shaved off one-half of their beards, and sent them home in that grotesque condition, exposed to the derision of their countrymen (2 Sam. x.). Persons of their high rank, who, in all probability, were fastidious about the orderly state and graceful appearance of their beards, would be even more sensitive as to this ignominious treatment than those of an humbler condition; and, as the shaving off one-half of the beard was among some ancient nations the punishment of cowardice, these circumstances united will help to account for the spirit of determined revenge which the king and the whole nation of Israel breathed, on receiving intelligence of the national outrage. (See also Herodotus, ii. 121; Lane's *Modern Egyptians*, i. p. 322, *note*.)—R. J.

From the above facts it is clear that the Israelites maintained their beard and the ideas connected with it, during their abode among the Egyptians, who were a shaven people. This is not unimportant as one of the indications which evince that, whatever they learned of good or evil in that country, they preserved the appearance and habits of a separate people. As the Egyptians shaved their beards off entirely, the injunction in Lev. xix. 27 against shaving 'the corners of the beard' must have been levelled against the practices of some other bearded nation. The prohibition is usually understood to apply against rounding the corners of the beard where it joins the hair; and the reason is supposed to have been to counteract a superstition of certain Arabian tribes, who, by shaving off or rounding away the beard where it joined the hair of the head, devoted themselves to a certain deity who held among them the place which Bacchus did among the Greeks (Herodot. iii. 8; comp. Jer. ix. 26; xxv. 23; xlix. 32). The consequence seems to have been altogether to prevent the Jews from shaving off the edges of their beards. The effect

of this prohibition in establishing a distinction of the Jews from other nations cannot be understood, unless we contemplate the extravagant diversity in which the beard was and is treated by the nations of the East. The first cut is very in-



teresting, being a collection of bearded heads of foreigners obtained from the Egyptian monuments, and, without doubt, including the beards, head-dresses, and physiognomies of most of the nations bordering on Egypt and Palestine. In nearly all of them we see that the upper edges of the beard were shaven off, and apparently the hair of the upper lip. The second cut, fig. 1, represents the head and beard of the Babylonian figure given at full length (on a smaller scale) in the second cut at p. 272; fig. 2 is the regal Persian

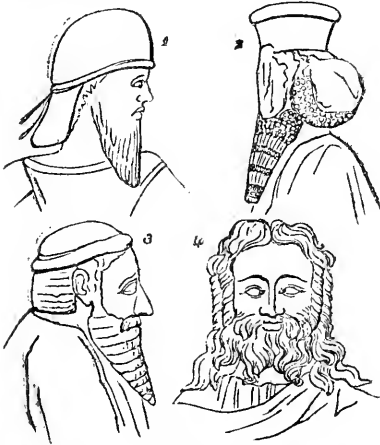
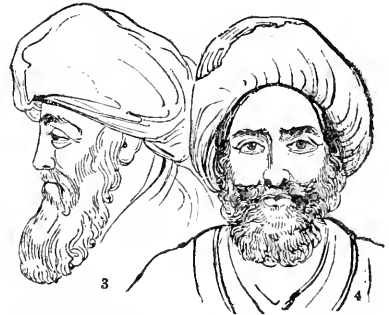

their beards, had the singular custom of tying a false beard upon the chin. This was probably by way of compromise between their love of cleanliness and their desire to preserve some trace of the distinguishing sign of manhood. It was made of plaited hair, and had a peculiar form according to the rank of the persons by whom they were worn. Private individuals had a small beard, scarcely two inches long; that of a king was of considerable length, and square at the bottom; and the figures of gods were distinguished by its turning up at the end (Wilkinson, *Anc. Egyptians*, iii. 362).

beard, curiously curled and tressed; fig. 3 is a somewhat similar beard from the recently-discovered sculptures of Xanthus in Asia Minor; and fig. 4 is Græco-Syrian, from the sculptures at Palmyra. With these it may be useful to compare the principal varieties of the beard among the modern orientals, whose tastes in this matter are in general much less fantastic than those of their predecessors. In the following cut the first figure is that of a modern Egyptian (Copt), and the second that of a Persian, exhibiting a remarkable contrast between the amplitude of the one beard and the scantiness of the other. The other two figures we offer with pleasure, as presenting, in all probability, correct resemblances of such beards as were worn by the ancient Israelites. Fig. 3 is that of an Arab sheikh, and fig. 4 that of a Syrian Jew.

The ancient Egyptians, although they shaved

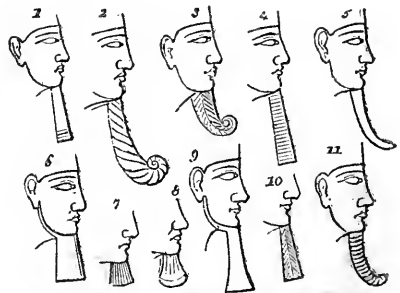

2, 3, 5, 11. Gods. 1, 4, 6, 9, 10. Kings. 7, 8. Private persons.

BEASTS. In the Bible, this word, when used in contradistinction to man (Ps. xxxvi. 6), de-

notes a brute creature generally; when in contradistinction to *creeping things* (Lev. xi. 2-7; xxvii. 26), it has reference to four-footed animals; and when to *wild mammalia*, as in Gen. i. 25, it means domesticated cattle.

Tziyim, צִיִּים (Isa. xlii. 21), denotes wild beasts of the upland wilderness. *Ochim*, אוֹחִים, rendered 'doleful creatures' and 'marsh animals,' may, we think with more propriety, be considered as 'poisonous and offensive reptiles.'

Se'irim, שְׂעִרִים, shaggy ones, is a general term for apes—not *satyrs*, a pagan poetical creation unfit for Scriptural language: it includes *Saadim* as a species, and תַּנִּינִים, *Tanninim*, monsters of the deep and of the wilderness—boas, serpents, crocodiles, dolphins, and sharks.

The zoology of Scripture may, in a general sense, be said to embrace the whole range of animated nature; but after the first brief notice of the creation of animals recorded in Genesis, it is limited more particularly to the animals found in Egypt, Arabia, Palestine, Syria, and the countries eastward, in some cases, to beyond the Euphrates. It comprehends mammalia, birds, reptiles, fishes, and invertebrate animals; but in a work like the Bible, written for a far different purpose, we might naturally expect that only a small part of these would be found described, and that general indications would more frequently occur than specific characteristics. As the intention of Scripture, in its allusions to animate or inanimate objects, was not scientific description, but the illustration of arguments and precepts by images drawn from objects familiar to those to whom it was addressed, it is not to be expected that zoology or botany should be treated systematically, or in terms such as modern science has adopted: yet, where we can now fully ascertain the true meaning of the text, the imagery drawn from natural history is always forcible, correct, and effective, even where it treats the subject under the conditions of the contemporary popular belief; for, had the inspired writers entered into explanations on matters of science not then commonly understood, the poetical force of the imagery, and consequently its intended effect, must necessarily have been greatly diminished; and, where system is appropriate, we find a classified general distribution of the creation, simple indeed, but sufficiently applicable to all the purposes for which it was introduced. It resembles other parts of the philosophy of the earliest nations, in which the physical distribution of matter, excepting so far as man is concerned, proceeds by triads. Botany is treated under the heads of grass, shrubs, and trees: in animated nature, beginning with the lowest organized in the watery element, we have first שְׂרָיִם *Sherets*, 'the moving creature that hath life,' animalcula, crustacea, insecta, &c.; second, תַּנִּינִים *Tanninim*, fishes and amphibia, including the huge tenants of the waters, whether they also frequent the land or not, crocodiles, python serpents, and perhaps even those which are now considered as of a more ancient zoology than the present system, the great Saurians of geology; and third, it appears, birds, עוֹף *Oph*, 'flying creatures' (Gen. i. 20); and still advancing (cetaceans, pinnatipeds, whales and seals being excluded), we have quadrupeds, forming three other divisions or orders: 1st, cattle, בְּהֵמָה *Behemah*, embracing the ruminant her-

bivora, generally gregarious and capable of domesticity; 2nd, wild beasts, חַיָּה *Chayah*, carnivora, including all beasts of prey; and 3rd, reptiles, רֶמֶשׂ *Remes*, minor quadrupeds, such as creep by means of many feet, or glide along the surface of the soil, serpents, annelides, &c.; finally we have man, אָדָם *Adam*, standing alone in intellectual supremacy. The classification of Moses, as it may be drawn from Deuteronomy, appears to be confined to *Vertebrata* alone, or animals having a spine and ribs, although the fourth class might include others. Taking man as one, it forms five classes—1st, Man; 2nd, Beasts; 3d, Birds; 4th, Reptiles; 5th, Fishes. It is the same as that in Leviticus xi., where beasts are further distinguished into those with solid hoofs, the Solipeds of systematists, and those with cloven feet (Bisulci), or Ruminantia. But the passage specially refers to animals that might be lawfully eaten because they were clean, and to others prohibited because they were declared unclean, although some of them, according to the common belief of the time, might ruminate; for, it may be repeated, that the Scriptures were not intended to embrace anatomical disquisitions aiming at the advancement of human science, but to convey moral and religious truth, without disturbing the received opinions of the time on questions having little or no relation to their main object. In like manner, fishes and birds are divided into clean and unclean; and, taken altogether, the classification now described forms an excellent series of distinctions, which, even at the present day, and in countries far distant from the scene where it was ordained, still remains applicable, with few exceptions; and from its intrinsic propriety will remain in force, notwithstanding our present knowledge of the manners and opinions of the East and of Egypt has rendered many of the earlier comments upon it in a great measure useless.

The Scriptures, as already mentioned, contain no minute details on natural history, and notice only a small proportion of the animals inhabiting the regions alluded to. Notwithstanding the subsequent progress of science, the observation of Dr. Adam Clarke is still in a great measure true, that, 'of a few animals and vegetables we are comparatively certain, but of the great majority we know almost nothing. Guessing and conjecture are endless, and they have on these subjects been already sufficiently employed. What learning—deep, solid, extensive learning and judgment could do, has already been done by the incomparable Bochart in his *Hierozoicon*. The learned reader may consult this work, and, while he gains much general information, will have to regret that he can apply so little of it to the main and grand question.' With these facts before him, it is singular that the learned doctor did not suspect the incompetence of mere philologists to solve questions in natural history, of which the true principles were so little known in the time of Bochart, and which still remain but little investigated by Biblical scholars; for, even now, some appear to believe in the faculty of rumination 'in a variety of the hare,' although such a capability would remove the animal from the genus and even from the order of Rodents, and place it in that of the Ruminantia. Nor is physical science sometimes better understood; for we

find a recent writer objecting to needless miraculous interposition in the case of the prophet Jonah, by supposing that he was swallowed by a whale, because, according to him, whales do not exist in the Mediterranean, and have not swallow sufficiently wide to admit a human body: he therefore contends that the monster must have been a shark: as if anything short of a miracle could preserve human life for more than ten minutes in the swallow of a whale or shark, no matter which. Yet with such trifling do books on a subject above all others important, sometimes abound, being written by men who are believed competent to the task, merely on the ground of their extensive Biblical learning. But the acts and laws by which it has pleased the Almighty to vindicate his own incomprehensible power ought not to be trifled with in this way; a more logical spirit is demanded for such inquiries, and he who undertakes to explain His word must endeavour to comprehend at least the general laws which it has pleased Omnipotence to impress upon matter; laws from which He never departs, but on rare and great occasions, for the accomplishment of His unfathomable purposes. It is in this spirit that the questions connected with zoological science are intended to be viewed in this work. Care will be taken not to lose sight of the Hebrew and cognate languages, nor to overlook the possible influence of Pelhevi and other dialects of the Sanscrit family, which even in Palestine appear to have formed an element in the tongues of the population anterior to the great immigration of the people of Israel. Notwithstanding the advance of zoological science in the field in question, where Niebuhr, Forskal, Hasselquist, Bruce, Russell, Hempich, Ehrenberg, Rüppell, Wilkinson, and others illustrious in this field of inquiry, have toiled, we are still obliged to confess that but a small portion of the local zoology is known, and that only a certain number of animals can be identified with complete certainty. Others can never attain more than the consent of acquiescence, because in the Hebrew text of the sacred writings the names of animals are mostly descriptive of characters applicable to several species, and some are more even than generically vague. Resorting to the roots of the language often increases the difficulty; and besides our still scanty knowledge of the present fauna of Western Asia and Egypt, it is only by inference that we can conjecture what changes have taken place in the species during the course of ages. Anciently the lion, ostrich, and wolf were undeniably abundant in these countries; while the hyæna, jackal, domestic horse, buffalo, &c. were either unknown or are not indicated with sufficiently distinguishable characters; and where we must rely upon an epithet or quality for fixing a name, our increased information supplies us with two or more distinct species equally entitled to the denomination. Thus, for instance, we might refer to the four or five species of smaller Canidæ, Tnoes, Jackals, and true foxes at present found in Syria and Egypt, and the absence of the real wolf, such as he is so beautifully and distinctly characterized in the parables of our Saviour; while the hyæna, only known in classical literature by the absurdities assigned to it, has now not only superseded the real wolf in Palestine and

Syria, but has spread northward into Natolia, and may be heard sometimes in Constantinople howling on the eastern side of the Bosphorus. Another difficulty arises from the many different Hebrew names given to one species. When this occurs with reference to the lion, so obviously important in the eyes of a resident population, we need not wonder; but the case is different as regards the ostrich, so liable to be confounded with the bustard or with the various names that are translated by owl, or where it is mixed with the epithets applied to the crane and stork.* Whether a clear indication of an otis can be derived from any of the texts in Scripture we have not yet been able to ascertain satisfactorily, and we own that where scholars have had no doubts of their own interpretations, but have shown the laxity of others who have given a different version of the same text, sometimes widely departing from the other, it is with no small hesitation we should venture to propose our own. These questions, however, will fall to be discussed under separate heads, as do those also which refer to animals now extinct, or which are differently located from what they were in the earlier ages of the world.—C. H. S.

BEDAN (בִּדָן). In 1 Sam. xii. 11, we read that the Lord sent as deliverers of Israel—Jerubbaal, *Bedan*, Jephthah, Samuel. Three of these we know to have been judges of Israel, but we nowhere find *Bedan* among the number. The Targum understands it of Samson, and so Jerome and the generality of interpreters; but this interpretation goes on the supposition that בִּדָן should be rendered *in Dan*, i. e. one in Dan, or of the tribe of Dan, as Samson was. In this sense, as Kimchi observes, it would have the same force as Ben-Dan, a son of Dan, a Danite. Such an intermixture of proper names and appellatives, however, is very doubtful, and it is to be noted that *Bedan* is mentioned before Jephthah, whereas Samson was after him. The Septuagint, Syriac, and Arabic have *Barak*, which many think the preferable reading (comp. Heb. xi. 32). A man of the name of *Bedan* occurs, however, among the posterity of Manasseh (1 Chron. vii. 17), and Junius, followed by some others, thinks that the judge *Jair* is meant, and that he is here called *Bedan* to distinguish him from the more ancient *Jair*, the son of Manasseh. The order in which the judges are here named is not at variance with this view (Num. xxxii. 41; Judg. x. 3, 4); but surely if *Jair* had been really intended, he might have been called by that name without any danger of his being, in this text (where he is called a deliverer of Israel, and placed among the judges), confounded with the more ancient *Jair*.

BEDOLACH (בְּדוֹלַח). This word occurs but twice in the Scriptures: in Gen. ii. 12, as a product of the land of Havilah; and Num. xi. 7, where the manna is likened to it. It has been much disputed among critics, both ancient and modern. In the Sept. it is considered as a precious stone, and translated (Gen. ii. 12) by

* *Otis Hobara*, *Otis Arabica*, and several other species are birds of the desert in Egypt and Arabia, and occur on the plain of Esdraelon. They are figured on monuments, and distinguished from the young ostrich by their quill-feathers and three-toed feet.

ἄρωμαξ, and (Num. xi. 7) by κροσταλλος; while Aquila, Symmachus, Theodotion, and the Vulgate render it *bdellium*, a transparent aromatic gum from a tree growing in Arabia. Of this opinion also is Josephus (*Antiq.* iii. 1. 6), where he describes the manna—*ἄμοιον τῆ τῶν ἀρωμάτων βδέλλα*, i. e. similar to the aromatic bdellium (Num. xi. 7). In the Syriac version it is

ܒܕܘܠܚܘ *brulcho*, evidently for ܒܕܘܠܚܘ

bdulcho, the two letters *r* and *d* being so similar—with the exception of the dot, which stands in the *r* over, and in the *d* under—as to be easily confounded with one another in transcribing. We find the same translation in the Samaritan and Chaldee, while the precious stones given by the Sept. and others bear with them a different name, פנקולה or פקולה.

The Jewish Rabbins, however, followed by a host of their Arabian translators, and to whom Bochart (*Hieroz.* iii. p. 593, sq.), and Gesenius (*The-saur.* i. 181), accede, translate *bedolach* by *pearl*, and consider *Havilah* (חױלח) as the part of Arabia near Catipha and Balreïn on the Persian Gulf, where the pearls are found.

Those who regard *bedolach* as some kind of precious stone, rest their argument on the fact that it is placed (Gen. ii. 12) by the side of *שׁהם* *shoham*, which is a precious stone, and occurs several times in the Scriptures, and that they are both mentioned as belonging to the productions of the land *Havilah*. But the least knowledge of Hebrew construction must satisfy us that, if this meaning were intended, the reading ought to be *שׁם אבן הברלח והשׁהם*, and not, as it actually stands, *שׁם הברלח ואבן השׁהם*, expressly excluding *bedolach* from the mineral kingdom.

Those who translate *bedolach* by 'pearl' refer to the later Jewish and Arabian expounders of the Bible, whose authority, if not strengthened by valid arguments, is but of little weight. It is, moreover, more than probable that the *pearl* was as yet unknown in the time of Moses, or he would certainly not have excluded it from the costly contributions to the tabernacle, the priestly dresses, or even the Urim and Thummim, while its fellow *shoham*, though of less value, was variously used among the sacred ornaments (Exod. xxv. 7; xxxv. 9, 27; xxviii. 20; xxxix. 13). Nor do we find any mention of pearl in the times of David and Solomon. It is true that Luther translates פנינים (Prov. iii. 15; viii. 11; x. 25; xxxi. 10) by *pearls*, but this is not borne out by Lament. iv. 7, where it is indicated as having a *red* colour. The only passage in the Old Testament where the pearl really occurs under its true Arabic name is in Esth. i. 6, 77 (dar), Arab. ܕܪ; and in the New Testament it is very frequently mentioned under the Greek name *μαργαρίτης*.

It is, therefore, most probable that the Hebrew *bedolach* is the aromatic gum *bdellium*, which issues from a tree growing in Arabia, Media, and the Indies. Dioscorides (i. 80) informs us that it was called *μάδακον* or *βολλάγον*, and Pliny (xii. 19) that it bore the names of *brochon*, *mala-cham*, and *maldacon*. The frequent interchange

of the μ ψ and the β ρ brings the form very near to that of the Hebrew word; nor is the similarity of name in the Hebrew and Greek, in the case of natural productions, less conclusive of the nature of the article, since the Greeks probably retained the ancient Oriental names of productions coming from the East. Pliny's description of the tree from which the bdellium is taken makes Kämpfer's assertion (*Amœn. Exot.* p. 668) highly probable, that it is the sort of palm-tree (*borassus flabelliformis*, Linn. ci. 6. 3, Trigynia) so frequently met with on the Persian coast and in Arabia Felix. The term bdellium, however, is applied to two gummy-resinous substances. One of them is the *Indian bdellium*, or *false myrrh* (perhaps the bdellium of the Scriptures), which is obtained from *Amyris* (balsamodendron?) *Commiphora*. Dr. Roxburgh (*Flor. Ind.* ii. 245) says that the trunk of the tree is covered with a light-coloured pellicle, as in the common birch, which peels off from time to time, exposing to view a smooth green coat, which in succession supplies other similar ex-foliations. This tree diffuses a grateful fragrance, like that of the finest myrrh, to a considerable distance around. Dr. Royle (*Illust.* p. 176) was informed that this species yielded bdellium; and in confirmation of this statement, we may add that many of the specimens of this bdellium in the British Museum have a yellow pellicle adhering to them, precisely like that of the common birch, and that some of the pieces are perforated by spiny branches—another character serving to recognise the origin of the bdellium. Indian bdellium has considerable resemblance to myrrh. Many of the pieces have hairs adhering to them.

The other kind of bdellium is called *African bdellium*, and is obtained from *Heudolotia Africana* (Richard and Guillemin, *Fl. de Sénégalambie*). It is a natural production of Senegal, and is called by the natives, who make tooth-picks of its spines, *niottout*. It consists of rounded or oval tears, from one to two inches in diameter, of a dull and waxy fracture, which, in the course of time, become opaque, and are covered externally by a white or yellowish dust. It has a feeble but peculiar odour, and a bitter taste. Pellitier (*Ann. de Chim.* lxxx. p. 39) found it to consist of resin 59.0; soluble gum, 9.2; *bassorin*, 30.6; *volatile oil and loss*, 1.2. Resin of bdellium (African bdellium?) consists, according to Johnstone, of carb. 40, hydr. 31, oxyg. 5.—E. M.

BEDS. The manner of sleeping in warm Eastern climates is necessarily very different from that which is followed in our colder regions. The present usages appear to be the same as those of the ancient Jews, and sufficiently explain the passages of Scripture which bear on the subject. Beds of feathers are altogether unknown, and the Orientals generally lie exceedingly hard. Poor people who have no certain home, or when on a journey, or employed at a distance from their dwellings, sleep on mats, or wrapped in their outer garment, which from its importance in this respect was forbidden to be retained in pledge over night (D'Arvieux, iii. 257; Gen. ix. 21, 23; Exod. xxii. 27; Deut. xxiii. 13). Under peculiar circumstances a stone covered with some folded cloth or piece of dress is often used for

a pillow (Gen. xxviii. 11). The more wealthy classes sleep on mattresses stuffed with wool or cotton, which are often no other than a quilt thickly padded, and are used either singly or one or more placed upon each other. A similar quilt

finer materials forms the coverlet in winter, and in summer a thin *blak* suffices; but sometimes the convenient outer garment is used for the latter purpose, and was so among the Jews, as we learn from 1 Sam. xix. 3, where Michal covers with a *בגד*, cloak or mantle (corresponding to the modern *abba* or *hyk*), the image which was to represent her husband sleeping. The difference of use here is, that the poor *wrap themselves up* in it, and it forms their whole bed; whereas the rich employ it as a *covering* only. A pillow is placed upon the mattress, and over both, in good houses, is laid a sheet. The bolsters are more valuable than the mattresses, both in respect of their coverings and material: they are usually stuffed with cotton or other soft substance (Ezek. 19; xviii. 21); but instead of these, skins of goats or sheep appear to have been formerly used by the poorer classes and in the harder ages. These skins were probably sewed up in the natural shape, like water-skins, and stuffed with chaff or wool (1 Sam. xix. 13). It is not unlikely that the Israelites were acquainted with those wooden crescent-shaped bolsters of wood, which were common in ancient Egypt (see one in the cut of a couch below); the comfort in the use of which is not very apparent, till one tries the experiment and realizes the complete repose which is obtained by resting the nape of the neck and base of the skull upon some similar contrivance.

It has been doubted whether the couches of the Jews for repose and for the use of the sick, called *מטה* *mittah* (Gen. xlvii. 31; 1 Sam. ix. 13; 2 Sam. iv. 7; 2 Kings i. 4), *מיטבב* *mishcab* (Exod. xxi. 18; 2 Sam. xiii. 5; Cant. iii. 1), or *עריש* *eres* (Job vii. 13; Cant. i. 16, properly 'bedstead,' comp. Deut. iii. 11), were actually bedsteads of different sorts, or simply the standing and fixed divans such as those on which the Western Asiatics commonly make their beds at night. It has been usually thought that the choice must lie between these alternatives, because it has not been understood that in the East there is, in fact, a variety of arrangement in this matter; but we feel satisfied that the different Hebrew words answer to and describe similarly different arrangements, although we may be unable now to assign to the several *words* their distinctive applications to still subsisting *things*.

The *divan*, or *daïs*, is a slightly elevated platform at the upper end and often along the sides of the room. On this are laid the mattresses on which the Western Asiatics sit cross-legged in the day-time, with large cushions against the wall to support the back. At night the light bedding is usually laid out upon this *divan*, and thus beds for many persons are easily formed. The bedding is removed in the morning, and deposited in recesses in the room, made for the purpose. This is a sort of general sleeping-room for the males of the family and for guests, none but the master having access to the inner parts of the house, where alone there are proper and distinct bed-chambers. In these the bedding is either laid on the carpeted floor, or placed on a low frame or bedstead. This difference between the public

and private sleeping-room, which the arrangement of an Eastern household renders necessary, seems to explain the difficulties which have perplexed readers of travels, who, finding mention only of the more public dormitory, the *divan*, have been led to conclude that there was no other or different one.

The most common bedstead in Egypt and Arabia is of this shape, framed rudely of palm-

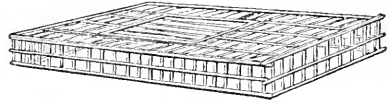

sticks. It was used in ancient Egypt, and is figured in the mural paintings. In Palestine, Syria, and Persia, where the palm-tree is not common, and where timber is more plentiful, a bed-frame of similar shape is made of boards. This kind of bedstead is also used upon the house-tops during the season in which people sleep there. It is more than likely that Og's bedstead was of this description (Deut. iii. 11). In the times in which he lived the palm-tree was more common in Palestine than at present, and the bedsteads in ordinary use were probably formed of palm-sticks. They would therefore be incapable of sustaining any undue weight without being disjointed and bent awry; and this would dictate the necessity of making that destined to sustain the vast bulk of Og, rather of rods of iron than of the mid-ribs of the palm-fronds. These bedsteads are also of a length seldom more than a few inches beyond the average human stature (commonly 6 feet 3 inches); and hence the propriety with which the length of Og's bedstead is stated, to convey an idea of his stature—a fact which has perplexed those who supposed there was no other bedstead than the *divan*, seeing that the length of the *divan* has no determinate reference to the stature of the persons reposing on it.

It is not necessary to suppose that the bedsteads were all of this sort. There are traces of a kind of portable couch (1 Sam. xix. 15), which appears to have served as a sofa for sitting on in the day-time (1 Sam. xxviii. 3; Ezek. xxiii. 41; Amos vi. 4); and there is now the less reason to doubt that the ancient Hebrews enjoyed this convenience, as we find such couches in use among the neighbouring nations, and figured on their monuments. The subjoined example is from

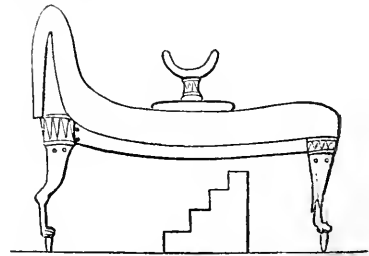

ancient Egypt. The elegance of shape in this and other specimens, shows the perfection to which the manufacture of these articles had been brought among that people. Persons are represented sitting

on such sofas in the day-time; and that they were used by single persons for sleeping on at night, is shown by the wooden pillow placed thereon, as well as by the steps for ascent that occur beside some of the specimens (as the present) which stand higher than the others. Such couches were capable of receiving those ornaments of ivory which are mentioned in Amos vi. 4; which of itself shows that the Hebrews had something of the kind, forming an ornamental article of furniture.

The next cut shows another variety of couch-bed, from the sculptures discovered by Mr. Fellows in Asia Minor.



A bed with a tester is mentioned in Judith xvi. 23, which, in connection with other indications, and the frequent mention of rich tapestries hung upon and about a bed for luxuriousness and ornament, proves that such beds (represented in the annexed cut) as are still used by royal and distinguished personages were not unknown under the Hebrew monarchy (comp. Esth. i. 6; Prov. vii. 16, seq.; Ezek. xxiii. 41).



It is evident that the ancient Jews, like the modern inhabitants of their land, seldom or never changed their dress on going to bed. Most people only divest themselves of their outer garment, and loosen the ligatures of the waist, excepting during the hottest part of the summer, when they sleep almost entirely unclad.

BEE (occurs in Deut. i. 44; Judg. xiv. 8; Ps. cxviii. 2; Isa. vii. 18). This insect belongs to the family *apidae*, order *hymenoptera*, species *apis mellifica*, commonly called the honey-bee, because this species has often yielded honey to

man. The bee is one of the most generally diffused creatures on the globe, being found in every region. Its instincts, its industry, and the valuable product of its labours, have obtained for it universal attention from the remotest times. No nation upon earth has had so many historians as this insect. The naturalist, agriculturist, and politician have been led by a regard to science or interest to study its habits. Cicero and Pliny refer to one philosopher (Aristomachus) who devoted sixty years to it; and another (Philiscus) is said to have retired to the desert to pursue his inquiries, and to have obtained, in consequence, the name of Agrius.

A prodigious number of books have been written, periodical publications have appeared, and even learned societies have been founded with a view to promote the knowledge of the bee, and increase its usefulness to man. Poets and moralists of every age have derived from it some of their most beautiful and striking illustrations.

The following is a mere outline of the facts ascertained by Swammerdam, Maraldi, Reaumur, Schirach, Bonnet, and Huber. *Its anatomy and physiology*, comprehending the antennæ, or tactors, by which it exercises at least all the human senses, if not more;—

‘Her glanceful eye

Set with ten thousand lenses,’

and studded with hairs to ward off the pollen, or dust of flowers, and the three additional eyes on the top of the head, giving a defensive vision upwards from the cups of flowers; the double stomach, the upper performing the office of the crop in birds, and regurgitating the honey, and the lower secreting the wax into various sacklets; the baskets on the thighs for carrying the pollen; the hooked feet; the union of chemical and mechanical perfection in the sting; its organs of progressive motion; its immense muscular strength:—the different sorts of bees inhabiting a hive, and composing the most perfect form of insect society, from the stately venerated queen-regnant, the mother of the whole population and their leader in migrations, down to the drone, each distinguished by its peculiar form and occupations:—the rapidity of their multiplication; the various transitions from the egg to the perfect insect; the amazing deviations from the usual laws of the animal economy; the means by which the loss of a queen is repaired, amounting to the literal creation of another; their architecture (taught by the great geometrician, who ‘made all things by number, weight, and measure’) upon the principles of the most refined geometrical problem; their streets, magazines, royal apartments, houses for the citizens; their care of the young, consultations and precautions in sending forth a new colony; their military prowess, fortifications, and discipline; their attachment to the hive and the common interest, yet patience under private wrongs; the subdivision of labour, by which thousands of individuals co-operate without confusion in the construction of magnificent public works; the uses they serve, as the promoting of the fructification of flowers; the amazing number and precision of their instincts, and the capability of modifying these by circumstances, so far as to raise a doubt whether they be not endowed with a portion at least of intelligence resembling that of man.

In proceeding to notice the principal passages of Scripture in which the bee is mentioned, we first pause at Deut. i. 44, where Moses alludes to the irresistible vengeance with which bees pursue their enemies: 'The Amorites came out against you and chased you as bees do, and destroyed you in Seir unto Hormah.' The powerlessness of man under the united attacks of these insects is well attested. Pliny relates that bees were so troublesome in some parts of Crete, that the inhabitants were compelled to forsake their homes; and Ælian records that some places in Scythia were formerly inaccessible on account of the swarms of bees with which they were infested. Mr. Park (*Travels*, vol. ii. p. 37) relates that at Doofroo, some of the people being in search of honey, unfortunately disturbed a swarm of bees, which came out in great numbers, attacked both men and beasts, obliged them to fly in all directions, so that he feared an end had been put to his journey, and that one ass died the same night, and another the next morning. Even in this country the stings of two exasperated hives have been known to kill a horse in a few minutes.

The reference to the bee contained in Judg. xiv. 8, has attracted the notice of most readers. It is related in the 5th and 6th verses that Samson, aided by supernatural strength, rent a young lion, that warred against him, as he would have rent a kid, and that 'after a time,' as he returned to take his wife, he turned aside to see the carcass of the lion, 'and, behold, there was a swarm of bees and honey in the carcass of the lion.' It has been hastily concluded that this narrative favours the mistaken notion of the ancients, possibly derived from misunderstanding this very account, that bees might be engendered in the dead bodies of animals (Virgil, *Georg.* iv.); and ancient authors are quoted to testify to the aversion of bees to flesh, unpleasant smells, and filthy places. But it may readily be perceived that it is not said that the bees were bred in the body of the lion. Again, the frequently recurring phrase, 'after a time,' literally 'after days,' introduced into the text, proves that at least sufficient time had elapsed for all the flesh of the animal to have been removed by birds and beasts of prey, ants, &c. The Syriac version translates 'the bony carcass.' The learned Bochart remarks that the Hebrew phrase sometimes signifies a whole year, and in this passage it would seem likely to have this meaning, because such was the length of time which usually elapsed between espousal and marriage (see ver. 7). He refers to Gen. iv. 3; xxiv. 55; Lev. xxv. 29, 30; Judg. xi. 4; comp. with ver. 40; 1 Sam. i. 3; comp. with vers. 7, 20; and 1 Sam. ii. 19; and 1 Sam. xxvii. 7. The circumstance that 'honey' was found in the carcass as well as bees, shows that sufficient time had elapsed since their possession of it, for all the flesh to be removed. Nor is such an abode for bees, probably in the skull or thorax, more unsuitable than a hollow in a rock, or in a tree, or in the ground, in which we know they often reside, or those clay nests which they build for themselves in Brazil. Nor is the fact without parallel. Herodotus (v. 114) relates that a swarm of bees took up their abode in the skull of one Silius, an ancient invader of Cyprus, which they filled with honeycombs, after the inhabitants had

suspended it over the gate of their city. A similar story is told by Aldrovandus (*De Insectis*, lib. i. p. 110) of some bees that inhabited and built their combs in a human skeleton in a tomb in a church at Verona.

The phrase in Ps. cxviii. 12, 'They compassed me about like bees,' will be readily understood by those who know the manner in which bees attack the object of their fury.

The only remaining passage has been strangely misunderstood (Isa. vii. 18): 'The Lord shall hiss for the fly that is in the uttermost parts of the river of Egypt, and for the bee that is in the land of Assyria.' Here the fly and the bee are no doubt personifications of those inveterate enemies of Israel, the Egyptians and Assyrians, whom the Lord threatened to excite against his disobedient people. But the hissing for them has been interpreted, even by modern writers of eminence, as involving 'an allusion to the practice of calling out the bees from their hives, by a hissing or whistling sound, to their labour in the fields, and summoning them to return when the heavens begin to lower, or the shadows of evening to fall' (Dr. Harris's *Natural History of the Bible*, London, 1825). No one has offered any proof of the existence of such a custom, and the idea will itself seem sufficiently strange to all who are acquainted with the habits of bees.

The true reference is, no doubt, to the custom of the people of the East, and even of many parts of Europe, of calling the attention of any one in the street, &c. by a significant hiss or rather hist, as Bishop Lowth translates the word both here and in Isa. v. 26, but which is generally done in this country by a short significant *hem!* or other exclamation. Hissing, or rather histing, is in use among us for setting a dog on any object. Hence the sense of the threatening is, I will direct the hostile attention of the Egyptians and Assyrians against you. It may be remarked that in the Septuagint version there is an allusion to the bee, immediately after that of the ant (Prov. vi. 8), which may be thus rendered—'Or go to the bee, and learn how industrious she is, and what a magnificent work she produces; whose labours kings and common people use for their health. And she is desired and praised by all. And though weak in strength, yet prizing wisdom, she prevails.' This passage is not now found in any Hebrew copy, and Jerome informs us that it was wanting in his time. Neither is it contained in any other version except the Arabic. It is nevertheless quoted by many ancient writers, as Clem. Alex. *Strom.* lib. i.; Origen, in *Num. Hom.* 27, and in *Isai. Hom.* 2; Basil, *Hexameron*, Hom. 8; Ambrose, v. 21; Jerome, in *Ezek.* iii.; Theodoret, *De Providentia*, Orat. 5; Antiochus, *Abbas Sabbæ*, Hom. 36; and John Damascenus, ii. 89. It would seem probable that it was in the copy used by the Greek translators. The ant and the bee are mentioned together by many writers, because of their similar habits of industry and economy.—J. F. D.

BEEF. [FOOD.]

BEELZEBUL (Βεελζεβούλ) is the name assigned (Matt. xii. 24) to the prince of the demons. There is no doubt that the reading *Beelzebub* is the one which has the support of almost every critical authority; and the *Beelzebub* of the *Peshito* (if indeed it is not a corrup-

tion, as Michaelis thinks), and of the Vulgate, and of some modern versions, has probably been accommodated to the name of the Philistine god *Baalzebub*. Some of those who consider the latter to have been a reverential title for that god, believe that Beelzebub is a wilful corruption of it, in order to make it contemptible. It is a fact that the Jews are very fond of turning words into ridicule, by such changes of letters as will convert them into words of contemptible signification. Of this usage Lightfoot gives many instances (*Hor. Hebr. ad Matth. l. c.*). Beelzebub, then (*Be'el* being the Aramaic pronunciation for *Ba'ai*), is considered to mean *dominus stercoris*. In the Hebrew language of the Old Test., however, all the derivations of the root **זב** occur solely in the sense of *dwelling*; and it is only the later language of the *Talmud* which has the sense of *stercorare*. The very form *zebub* is not, indeed, found in that later idiom. Nevertheless, if the word is only a contemptuous perversion of *zebub*, *fly*, some licence of formation would be easily excused. It is evident from numerous passages in the *Talmud*, cited by Lightfoot, that many derivatives of **זב** are used, as terms of the utmost disgust, to denote *idolatry*. It also appears that *zabbel*, *stercorare*, is at the same time a perversion of *zabach*, to *sacrifice*, and, as such, is used, with the same construction as the latter, to mean sacrificing to idols. From these combinations, it is easy to conceive how the name Beelzebub might have been formed, and how, as meaning *dominus stercoris*, it might be considered an appropriate name of the *archdemon of idolatry*.

Some scholars, however, still adhere to the ancient Hebrew sense of *dwelling*. Among these, J. D. Michaelis (*Suppl. ad Lex.*, p. 205), proposes an astrological interpretation of the name: *zebub*, according to him, means *house*, in that sense in which the heavens are divided into twelve mansions, in every one of which some planet presides, called the *lord of the house*. As the planets also were objects of idolatrous worship, he conceives *lord of the house* to have become a fitting name for the author of idolatry. This view, however untenable otherwise, produces a striking antithesis when seen in connection with the rest of the passage: 'If they have called the master of the house Beelzebub,' &c. (*Matt. x. 25*).

If the reading *Beelzebub* were retained, it might, according to the proposal of Storr and Döderlein, receive some support from the Syriac *Be'eldebobo*, *lord of hatred, of enmity* (which is often used for *enemy*)—*διάβολος*. Michaelis (in his *Lex. Syr.*) questions whether *debobo* by itself means *enmity*; although he admits that the compound *Beeldebobo* means *enemy*. His doubt may, however, be removed; for, although *debobo* does not occur in that sense by itself, in Aramaic, yet it does in the Samaritan Version (*e. g.* Gen. iii. 15), and *dabub* means *slanderer*, in Arabic.

It is remarkable that, amidst all the demonology of the *Talmud* and Rabbinical writers, this name should be exclusively confined to the New Testament.—J. N.

BEER (בֵּירָא, a well; Sept. Βαίρη), a local proper name, denoting, whether by itself or in composition, the presence of a well of water. There were two places so called.—1. A place

in the land of Moab, which was one of the encampments of the Israelites (*Num. xxi. 16*).—2. A town in the tribe of Judah. It is mentioned only once in Scripture (*Judg. ix. 21*), as the place to which Jotham fled. Eusebius (*Onomast. s. v. Βερά, Bera*) places Beer eight R. miles north of Eleutheropolis; but this is probably an error, as he also states that it becomes visible at the seventh R. mile on the road from Nicopolis to Jerusalem, which cannot be true of a town situated as he indicates; but is true of a place still bearing the corresponding name of el-Bireh, which, since Maundrell's time, has been identified with Beer (*Journey*, March 25). Eusebius probably wrote 'Eleutheropolis' instead of 'Jerusalem;' for the place in question is nearly at the expressed distance, northward, from the latter city. Bireh is mentioned, under the name of *Bira*, by Brocard (*c. vii. p. 178*), in whose time it was held by the Templars. By the Crusaders and the later ecclesiastics it was erroneously confounded with the ancient Michmash. Bireh is situated on the ridge, running from east to west, which bounds the northern prospect, as beheld from Jerusalem and its vicinity, and may be seen from a great distance north and south. It is now a large village, with a population of 700 Moslems. The houses are low, and many of them half underground. Many large stones and various substructions evince the antiquity of the site; and there are remains of a fine old church of the time of the Crusades (*Robinson, ii. 131*; *Reland, Palestina*, p. 617; *Richter, Wallfahrten*, p. 54).

BEEROTH (בֵּירוֹת), the plural of Beer, and by many taken for the same place. Dr. Robinson thinks that if they were different (but he believes them the same), the Bireh mentioned in the preceding article represents Beeroth rather than Beer. Beeroth is mentioned as a city of the Gibeonites (*Josh. ix. 17*), and was reckoned in the tribe of Benjamin (*2 Sam. iv. 2*; *Ezra ii. 25*). Eusebius distinguishes it from Beer (*Onomast. s. v. Βηροθ, Beerth*), and assigns it a position coincident with that now occupied by Bireh, *i. e.* seven R. miles (in fact rather more) north of Jerusalem.

BEERSHEBA (בְּרֵשֶׁת הַיַּבֵּעַ, *well of the oath*; Sept. Βηροσαβέ), a place in the southernmost part of Canaan, celebrated for the sojourn of the patriarchs. It took its name from the *well* which was dug there by Abraham, and the oath which confirmed his treaty with Abimelech (*Gen. xxi. 31*). It seems to have been a favourite station of that patriarch, and here he planted one of those 'groves' which formed the temples of those remote times (*Gen. xxi. 33*). A town of some consequence afterwards arose on the spot, and retained the same name. It was first assigned to the tribe of Judah (*Josh. xv. 28*), and afterwards transferred to Simeon (*Josh. xix. 2*), but was still popularly ascribed to Judah (*2 Sam. xxiv. 7*). As it was the southernmost city of the land, its name is of frequent occurrence, being proverbially used in describing the extent of the country, in the phrase 'from Dan (in the north) to Beersheba' (in the south), and reversely, 'from Beersheba unto Dan' (*Judg. xx. 1*; *2 Sam. xvii. 11*; *1 Chron. xxi. 2*; *2 Chron. xxx. 5*). When the land was divided into two kingdoms, the extent of that of Judah was in like manner described by the phrase 'from Beersheba to Mount Ephraim'

(2 Chrn. xix. 4). It was at Beersheba that Samuel established his sons as judges for the southernmost districts (1 Sam. viii. 2): it was from thence that Elijah wandered out into the southern desert (1 Kings xix. 3): here was one of the chief seats of idolatrous worship in the time of Uzziah (Amos v. 5; viii. 14); and to this place, among others, the Jews returned after the Captivity (Neh. xi. 27, 30). This is the last time its name occurs in the Old Testament. In the New Testament it is not once mentioned; nor is it referred to, as then existing, by any writer earlier than Eusebius and Jerome, in the fourth century, who describe it as a large village (Euseb. *κώμη μεγίστη*; Jerome, *vicus grandis*), and the seat of a Roman garrison. In the centuries before and after the Moslem conquest it is mentioned among the episcopal cities of Palestine (Reland, *Palest.* i. 35); but none of its bishops are anywhere named. The site seems to have been forgotten till the fourteenth century, when Sir John Maundeville, Rudolf de Suchem, and William de Baldensel recognised the name at a place which they passed on their route from Sinai to Hebron. It was then uninhabited, but some of the churches were still standing. From that time till the recent visit of Dr. Robinson, the place remained unvisited and unknown, except for the slight notice obtained by Seetzen from the Arabs (*Zach's Monatl. Corresp.* xvii. 143). Dr. Robinson gives a clear idea of the southernmost district of Palestine, in which is Beersheba, and with which the book of Genesis has connected so many interesting associations. Coming from the south, he emerged from the desert by a long and gradual ascent, over swelling hills scantily covered with grass. The summit of this ascent afforded a view over a broad barren tract, bounded on the horizon by the mountains of Judah south of Hebron: 'We now felt that the desert was at an end. Descending gradually, we came out upon an open undulating country; the shrubs ceased, or nearly so; green grass was seen along the lesser watercourses, and almost green sward; while the gentle hills, covered in ordinary seasons with grass and rich pasture, were now burnt over with drought. In three-quarters of an hour we reached Wady es-Leba, a wide watercourse or bed of a torrent, running here W.S.W., upon whose northern side, close upon the bank, are two deep wells, still called Bir-es-Leba, the ancient Beersheba. We had entered the borders of Palestine!' These wells are 55 rods apart. They are circular, and stoned up very neatly with masonry, apparently very ancient. The largest of them is 12½ feet in diameter, and 44½ feet deep to the surface of the water, 16 of which, at the bottom, are excavated in the solid rock. The other well is 5 feet in diameter by 12 feet deep. 'The water in both is pure and sweet, and in great abundance; the finest, indeed, we had found since leaving Sinai. Both wells are surrounded with drinking-troughs of stone for camels and flocks, such as were doubtless used of old by the flocks which were fed on the adjacent hills' (Robinson, i. 301). No ruins were at first visible; but, on examination, foundations of former dwellings were traced, dispersed loosely over the low hills, to the north of the wells, and in the hollows between. They seem to have been built chiefly of round stones, although some of the stones are squared

and some hewn; suggesting the idea of a small straggling city. The site of the wells is nearly midway between the southern end of the Dead Sea and the Mediterranean at Raphaa, or twenty-seven miles south-east from Gaza, and about the same distance south-by-west from Hebron. Its present Arabic name, Bir-es-Seba, means 'well of the seven,' which some take to be the significance also of Beersheba, in allusion to the seven ewe-lambs which Abraham gave to Abimelech, in token of the oath between them. There is no ground for rendering it by 'seven wells,' as some have done.

BEE-TLE. [CHARGOL.]

BEEVES (בקר *Bakar*, in Arabic, *al-bakar*), cattle, herds, applicable to all Ruminantia, the camels alone excepted; but more particularly to the Bovidæ and the genera of the larger antelopes.

Ox or beeve, אֵלֶף, *aluph*, the most important of all clean beasts (Ps. viii. 7; cxliv. 14; Jer. xi. 19). Bull, שׁוֹר, *shor*; Chaldee, *taur*; Arabic, *al-taur*; Latin, *taurus*; Celtic, *tor*. Young bull, פַּר, *phar*; Belgic, *veir* (Job xxi. 10; 1 Sam. vi. 7, 10; Ps. lxxix. 31). Heifer, פַּרְהָה, *pharah*. Calf, עֵגֶל, *egel*; Arabic, *idgl*; but theó, תָּאוֹ, although the hunched ox occurs on Egyptian monuments, we take to refer to an oryx, as well as *Beker-el-wash*, unless it be the Antelope defassa of Wilkinson, a species not yet scientifically described.—C. H. S.

BEGGARS. [ALMS.]

BEHEADING. [PUNISHMENTS.]

BEHEMOTH (בְּהֵמוֹת, Job xl. 15; in Coptic, according to Jablonski, *Pehemont*) is regarded as the plural of behemah, בְּהֵמָה, but commentators are by no means agreed as to its true meaning. A number of learned men, with

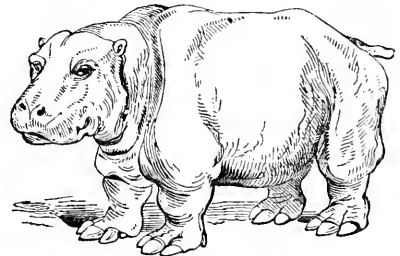

[Hippopotamus.]

Bochart and Calmet at their head, understand the word in the singular number as a specific name, denoting the hippopotamus, seeking, by somewhat forced interpretations of the beautiful poetical allusions in Job xl. 15-24, to prove the exactness of the description when compared with the species. In some respects, however, it is more applicable to the elephant, while in others it is equally so to both animals. Hence the term behemoth, taken intensively (for in some places it is admitted to designate cattle in general), may be assumed to be a poetical personification of the great Pachydermata, or even Herhivora, wherein the idea of hippopotamus is predominant. This view accounts for the ascription to it of characters not truly applicable to one species; for instance, the tail is likened to a cedar (provided בְּנֵי really denotes the tail, which the context makes

very doubtful. See Zeddel, *Beitr. z. Bibl. Zoologie*), which is only admissible in the case of the elephant; again, 'the mountains bring him forth food;' 'he trusteth that he can draw up Jordan,' a river which elephants alone could reach; 'his nose pierceth through snares,' certainly more indicative of that animal's proboscis with its extraordinary delicacy of scent and touch, ever cautiously applied, than of the obtuse perceptions of the river-horse. Finally, the elephant is far more dangerous as an enemy than the hippopotamus, which numerous pictorial sculptures on the monuments of Egypt represent as fearlessly speared by a single hunter standing on his float of log and reeds. Yet although the elephant is scarcely less fond of water, the description referring to manners, such as lying under the shade of willows, among reeds, in fens, &c., is more directly characteristic of the hippopotamus. The book of Job appears, from many internal indications, to have been written in Asia, and is full of knowledge, although that knowledge is not expressed according to the precise technicalities of modern science; it offers pictures in magnificent outline, without condescending to minute and laboured details. Considered in this light, the expression in Ps. l. 10, 'For every beast of the forest is mine, and the cattle (behemoth) upon a thousand hills,' acquires a grandeur and force far surpassing those furnished by the mere idea of cattle of various kinds. If, then, we take this plural noun in the sense here briefly indicated, we may, in like manner, consider the leviathan, its counterpart, a similarly generalized term, with the idea of crocodile most prominent; and as this name indicates a twisting animal, and, as appears from various texts, evidently includes the great pythons, cetacea, and sharks of the surrounding seas and deserts, it conveys a more sublime conception than if limited to the crocodile, an animal familiar to every Egyptian, and well known even in Palestine.—C. H. S.

BEKAH, half a shekel. [WEIGHTS.]

BEL (𐤁𐤋, contracted from 𐤁𐤋𐤁, the Aramaic form of 𐤁𐤋𐤁; Sept. Βήλ and Βήλος), is the name under which the national god of the Babylonians is cursorily mentioned in Isa. xlvi. 1; Jer. l. 2; li. 44. The only passages in the Bible which contain any further notice of this deity are Bar. vi. 40, and the apocryphal addition to the book of Daniel, in the Sept., xiv. 1, sq., where we read of meat and drink being daily offered to him, according to a usage occurring in classical idolatry, and termed *Lectisternia* (Jer. li. 44?). We, therefore, turn to the testimonies of profane writers. A particular account of the pyramidal temple of Bel, at Babylon, is given by Herodotus, i. 181-183. It is there also stated that the sacrifices of this god consisted of adult cattle (πρόβατα), of their young, when sucking (which last class were the only victims offered up on the golden altar), and of incense. The custom of providing him with *Lectisternia* may be inferred from the table placed before the statue, but it is not expressly mentioned. Diodorus (ii. 9) gives a similar account of this temple; but adds that there were large golden statues of Zeus, Hera, and Rhea on its summit, with a table, common to them all, before them. Gesenius, in order to support his own theory,

endeavours to show that this statue of Zeus must have been that of *Saturn*, and that of Rhea represented the sun. Hitzig, however, in his note to Isa. xvii. 8, more justly observes that Hera is the female counterpart to Zeus-Bel, that she is called so solely because it was the name of the chief Greek goddess, and that she and Bel are the moon and sun. He refers for confirmation to Berosus (p. 59, ed. Richter), who states that the wife of Bel was called *Omorca*, which means moon; and to Ammian. Marcell. xxiii. 3, for a statement that the moon was, in later times, zealously worshipped in Mesopotamia. The classical writers generally call this Babylonian deity by their names, *Zeus* and *Jupiter* (Herod. and Diod. l. c.; Plin. *Hist. Nat.* vi. 30); by which they assuredly did not mean the planet of that name, but merely the chief god of their religious system. Cicero, however (*De Nat. Deor.* iii. 16), recognises *Hercules* in the Belus of India, which is a loose term for Babylonia. This favours the identity of Bel and Melkarth.

The question whether the sun or the planet Jupiter was the power of nature adored under the name of Bel, is discussed under the article BAAL.

The following engraving, taken from a Babylonian cylinder, represents, according to Münter, the sun-god and one of his priests. The triangle on the top of one of the pillars, the star with eight rays, and the half moon, are all significant symbols.—J. N.

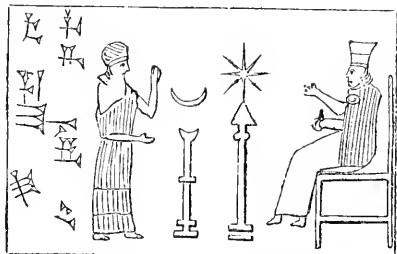

BEL and DRAGON. [DANIEL, APOCRYPHAL ADDITIONS TO.]

BELA. [ZOAR.]

BELL. The first bells known in history are those small golden bells which were attached to the lower part of the blue robe (the robe of the ephod) which formed part of the dress of the high-priest in his sacerdotal ministrations (Exod. xxviii. 33, 34; comp. Ecclus. xlv. 11). They were there placed alternately with the pomegranate-shaped knobs, one of these being between every two of the bells. The number of these bells is not mentioned in Scripture; but tradition states that there were sixty-six (Clem. Alex. *Stromata*, p. 563). We need not seek any other reason for this rather singular use of bells than that which is assigned: 'His sound shall be heard when he goeth into the holy place before the Lord, and when he cometh out, that he die not' (Exod. xxviii. 35); by which we may understand that the sound of the bells manifested that he was properly arrayed in the robes of ceremony which he was required to wear when he entered the presence-chamber of the Great King; and that as no minister can enter the presence of an earthly potentate abruptly and un-

announced, so he (whom no human being *could* introduce) was to have his entrance harbingered by the sound of the bells he wore. This sound, heard outside, also notified to the people the time in which he was engaged in his sacred ministrations, and during which they remained in prayer (Luke i. 9, 10).

'BELLS OF THE HORSES' are mentioned in Zecl. xiv. 20, which were probably such as were attached to the bridles or foreheads, or to belts around the necks of horses trained for war, that they might thereby be accustomed to noise and tumult, and not by their alarm expose the riders to danger in actual warfare. Hence a person who had not been tried or trained up to anything was by the Greeks called *ἀκαθάμιστος*, 'one not used to the noise of a bell,' by a metaphor taken from horses. The mules employed in the funeral pomp of Alexander had at each jaw a golden bell. We incline to think, however, that the use of horse-bells with which the Jews were most familiar, and which the prophet had in view, was that which at present exists in the East, and in other countries where carriage by pack-horses and mules is common. The laden animals, being without riders, have bells hung from their necks, that they may be kept together, in traversing by night the open plains and deserts, by paths and roads unconfined by fences or boundaries; that they may be cheered by the sound of the bells; and that if any horse strays, its place may be known by the sound of its bell, while the general sound from the caravan enables the traveller who has strayed or lingered, to find and regain his party, even in the night.

That the same motto, HOLINESS TO THE LORD, which was upon the mitre of the high-priest, should, in the happy days foretold by the prophet, be inscribed even upon the bells of the horses, manifestly signifies that all things, from the highest to the lowest, should in those days be sanctified to God.

It is remarkable that there is no appearance of bells of any kind in the Egyptian monuments.

BELLOWS. This word only occurs in Jer. vi. 29, and is there employed with reference to the casting of metal. As fires in the East are always of wood or charcoal, a sufficient heat for ordinary purposes is soon raised by the help of fans, and the use of bellows is confined to the workers in metal. Such was the case anciently; and in the mural paintings of Egypt we observe no bellows but such as are used for the forge or furnace. They occur as early as the time of Moses, being represented in a tomb at Thebes which bears the name of Thothmes III. They consisted of a leathern



bag, secured and fitted into a frame, from which a long pipe extended for carrying the wind to the fire. They were worked by the feet, the operator

standing upon them with one under each foot and pressing them alternately, while he pulled up each exhausted skin with a string he held in his hand. In one instance it is observed from the painting, that when the man left the bellows they were raised as if filled with air, and this would imply a knowledge of the valve (Wilkinson's *Anc. Egyptians*, iii. 338).

BELLY. Among the Hebrews and most ancient nations, the belly was regarded as the seat of the carnal affections, as being, according to their notions, that which first partakes of sensual pleasures (Tit. i. 2; Phil. iii. 9; Rom. xvi. 18). It is used likewise symbolically for the heart, the innermost recesses of the soul (Prov. xviii. 8; xx. 27; xxii. 18). The expression *embittering* of the belly signifies all the train of evils which may come upon a man (Jer. iv. 19; ix. 15; comp. Num. xvii. 27).

BELOMANCY. [DIVINATION.]

BELSHAZZAR (בלשצר; Sept. Βαλσάσαρ) is the name given in the book of Daniel to the last king of the Chaldees, under whom Babylon was taken by the Medes and Persians. Herodotus calls this king, and also his father, *Labynetus*, which is undoubtedly a corruption of *Nabonnedus*, the name by which he was known to Berosus, in Joseph. *Contr. Apion*. i. 20. Yet in Joseph. (*Antiq.* x. 11. 2) it is stated that Baltasar was called *Naboandel* by the Babylonians. *Nabonadius* in the Canon of Ptolemy, *Nabonedus* in Euseb. *Chron. Armen.* i. p. 60 (from Alexander Polyhistor.), and *Nabonnidochus* in Euseb. *Prep. Evan.* ix. 41 (from Megasthenes), are remarked by Winer as other varieties of his name. Winer (*Simon. Lex.*) conjectures that in the name Belshazzar the element *shazzar* means 'the principle of fire' سزازر.

Nothing is really known of this king except from the book of Daniel, the authenticity and credibility of which will be treated under the article DANIEL. That which is told of Nabonnedus by Berosus does not agree with the Scriptural account, viz., that losing a pitched battle against Cyrus in the open plain, Nabonnedus was shut up in the city Borsippa on the Euphrates, below Babylon, and soon forced to surrender his person. Cyrus received him kindly, sent him into Caramania, and settled him on an estate, where he ended his life peaceably. No hypothesis will reconcile this account with the other, since it is certain that Nabonnedus is the *last* king in the one narrative, as Belshazzar in the other. Some of the older critics in vain endeavoured to remove the difficulties, by making Belshazzar the same as Laborosarchod, who preceded Nabonnedus. Xenophon (*Cyrop.* vii. 5, 30) agrees with the book of Daniel as to the fate of Belshazzar.—

F. W. N.

BELTESHAZZAR. [DANIEL.]

BELUS, TEMPLE OF. [BABEL.]

BEN (בן, *son*) is often found as the first element of proper names; in which case the word which follows it is always to be considered dependent on it, in the relation of *own* genitive. The word which follows *Ben* may either be of itself a proper name, or be an appellative or abstract, the principle of the connection being essentially the same in both cases. As for the first

class, as the Syro-Arabian nations are all particularly addicted to genealogy, and as they possess no surnames, nor family names in our sense, they have no means of attaching a definite designation to a person, except by adding some accessory specification to his distinctive, or, as we would term it, *Christian*, name. This explains why so many persons, both in the Old and New Testaments, are distinguished by the addition of the names of their father. The same usage is especially frequent among the Arabs; but they have improved its definiteness by adding the name of the person's child, in case he has one. In doing this they always observe this arrangement—the name of the child, the person's own name, and the name of his father. Thus the designation of the patriarch Isaac would, in Arabic, run thus—Father of Jacob, Isaac, son of Abraham (Abū Ja'qūb, Ishāq, ben Ibrahim). As for the latter class, there is an easy transition from this strict use of *son* to its employment in a figurative sense, to denote a peculiar dependence of derivation. The principle of such a connection not only explains such proper names as Ben Chesed (son of mercy), but applies to many striking metaphors in other classes of words, as sons of the bow, a son of seventeen years (the usual mode of denoting age), a hill, the son of oil (Isa. v. 2), and many others, in which our translation effaces the Oriental type of the expression. All proper names which begin with Ben belong to one or the other of these classes. Ben Aminadab, Ben Gaber, and Ben Chesed (1 Kings iv. 10, 11) illustrate all the possibilities of combination noticed above. In these names, Ben would, perhaps, be better not translated, as it is in our version; although the Vulgate has preserved it, as the Sept. also appears to have once done in ver. 8, to judge by the reading there.

These remarks apply also in part to BAR, the Aramaic synonyme of Ben, as in the name Bar-Abbas.—J. N.

BENAIAH (בְּנֵיָהוּ or בְּנֵיָהוּ; Sept. *Bavalas*), son of Jehoiada, and commander of David's guard (the Cherethites and Pelethites, 2 Sam. viii. 18). His exploits were celebrated in Israel. He overcame two Moabish champions ('lions of God'), slew an Egyptian giant with his own spear, and went down into an exhausted cistern and destroyed a lion which had fallen into it when covered with snow (2 Sam. xxiii. 21). Benaiah (doubtless with the guard he commanded) adhered to Solomon when Joab and others attempted to set up Adonijah; and when that attempt failed, he, as belonged to his office, was sent to put Joab to death, after which he was appointed commander in chief in his place (1 Kings i. 36; ii. 29). Some persons named Benaiah returned from the exile with Ezra (x. 25, 30, 35, 43).

BENHADAD (בְּנֵי־הַדָּד, *son of Hadad*; Sept. *υἱος Ἀδδερ*), the name of three kings of Damascus-Syria. As to the latter part of this name, Hadad, there is little doubt that it is the name of the Syrian god ADAD. The expression *son of Hadad*, which denotes dependence and obedience, not only accords with the analogies of other heathen names, but is also supported by the existence of such terms as 'sons of God' among the Hebrews (cf. Ps. lxxxii. 6).

1. **BENHADAD**, the king of Syria who was subsidised by Asa king of Judah to invade Israel, and thereby compel Baasha (who had invaded Judah) to return to defend his own kingdom (1 Kings xv. 18). [ASA.] This Ben-hadad has, with some reason, been supposed Hadad the Edomite who rebelled against Solomon (1 Kings xi. 25).

2. **BENHADAD**, king of Syria, son of the preceding. His earlier history is much involved in that of Ahab, with whom he was constantly at war [AHAB]. He owed the signal defeat in which that war terminated to the vain notion which assimilated JEHOVAH to the local deities worshipped by the nations of Syria, deeming Him 'a God of the hills,' but impotent to defend his votaries in 'the plains' (1 Kings xx. 1-30). Instead of pursuing his victory, Ahab concluded a peace with the defeated Benhadad, which was observed for about twelve years, when the Syrian king declared war against Jehoram the son of Ahab, and invaded Israel; but all his plans and operations were frustrated, being made known to Jehoram by the prophet Elisha (2 Kings vi. 8, *ad fin.*). After some years, however, he renewed the war, and besieged Jehoram in his capital, Samaria, until the inhabitants were reduced to the last extremities and most revolting resources by famine. The siege was then unexpectedly raised, according to a prediction of Elisha, through a panic infused into the besiegers, who concluding that a noise which they seemed to hear portended the advance upon them of a foreign host procured by Jehoram, thought only of saving themselves by flight. The next year Benhadad, learning that Elisha, through whom so many of his designs had been brought to nought, had arrived at Damascus, sent an officer of distinction named Hazael with presents, to consult him as to his recovery from an illness under which he then suffered. The prophet answered, that his disease was not mortal, but that he would nevertheless die. This was accomplished a few days after by this very Hazael, who smothered the sick monarch in his bed, and mounted the throne in his stead, B.C. 884 (2 Kings viii. 7-15). [ELISHA; HAZAEL; JEHOHAM.]

3. **BENHADAD**, king of Syria, son of the Hazael just mentioned. He was thrice defeated by Jehoash, king of Israel, who recovered from him all the territories beyond the Jordan which Hazael had rent from the dominion of Israel (2 Kings xiii. 3, 24, 25).

BENJAMIN (בְּנֵי־יָמִין; Sept. *Beniamin*), youngest son of Jacob, by Rachel (Gen. xxxv. 18). His mother died immediately after he was born, and with her last breath named him בֶּן עֹנִי (Ben-Oni, 'Son of my pain'), which the father changed into Benjamin, a word of nearly the same sound, but portending comfort and consolation, 'Son of my right hand,' probably alluding to the support and protection he promised himself from this, his last child, in his old age. This supposition is strengthened when we reflect on the reluctance with which he consented to part with him in very trying circumstances, yielding only to the pressure of famine and the most urgent necessity (Gen. xlii.).

In Gen. lvi. 21, *sq.*, the immediate descendants of Benjamin are given to the number of *ten*,

whereas in Num. xxvi. 38-40, only seven are enumerated, and some even under different names. This difference may probably be owing to the circumstance that some of the direct descendants of Benjamin had died either at an early period or at least childless.

The tribe of Benjamin, though the least numerous of Israel, became nevertheless a considerable race in process of time. In the desert it counted 35,400 warriors, all above twenty years of age (Num. i. 36; ii. 22); and, at the entrance of Israel into Canaan, even as many as 45,600. The portion allotted to this tribe was in proportion to its small number, and was encompassed by the districts of Ephraim, Dan, and Judah, in central Palestine. In Josh. xviii. 11-20, the northern and southern boundaries are minutely described; from ver. 12 to 16 is sketched the northern boundary-line, and from 16 to 20, the southern. Within the boundaries described in these eight verses lay a district rather small, but highly-cultivated and naturally fertile (Joseph. *Antiq.* v. l. 22; Reland, p. 637), containing thirty-six towns (with the villages appertaining to them), which are named in Josh. xviii. 21-28; and the principal of which were Jericho, Bethagla, Bethel, Gibeon, Ramah, and Jebus or Jerusalem. This latter place subsequently became the capital of the whole Jewish empire; but was, after the division of the land, still in possession of the Jebusites. The Benjamites had indeed been charged to dispossess them, and occupy that important town; but (Judg. i. 21) the Benjamites are reproached with having neglected to drive them from thence, that is, from the *upper*, well-fortified part of the place *Zion*, since the *lower* and less fortified part had already been taken by Judah (Judg. i. 8), who in this matter had almost a common interest with *Benjamin*. *Zion* was finally taken from the Jebusites by David (2 Sam. v. 6, *sq.*).

In the time of the Judges, the tribe of Benjamin became involved in a civil war with the other eleven tribes, for having refused to give up to justice the miscreants of Gibeon who had publicly violated and caused the death of a concubine of a man of Ephraim, who had passed with her through Gibeon. This war terminated in the almost utter extinction of the tribe; leaving no hope for its regeneration from the circumstance, that, not only had nearly all the women of that tribe been previously slain by their foes, but the eleven other tribes had engaged themselves by a solemn oath not to marry their daughters to any man belonging to Benjamin. When the thirst of revenge, however, had abated, they found means to evade the letter of the oath, and to revive the tribe again by an alliance with them (Judg. xix. 20, 21). This revival was so rapid, that, in the time of David, it already numbered 59,434 able warriors (1 Chron. vii. 6-12); in that of Asa, 280,000 (2 Chron. xiv. 8); and in that of Jehoshaphat, 200,000 (2 Chron. xvii. 17).

This tribe had also the honour of giving the first king to the Jews, Saul being a Benjamite (1 Sam. ix. 1, 2). After the death of Saul, the Benjamites, as might have been expected, declared themselves for his son Ishbosheth (2 Sam. ii. 8, *sq.*); until, after the assassination of that prince, David became king of all Israel. David

having at last expelled the Jebusites from *Zion*, and made it his own residence, the close alliance that seems previously to have existed between the tribes of Benjamin and Judah (Judg. i. 8) was cemented by the circumstance that, while Jerusalem actually belonged to the district of Benjamin, that of Judah was immediately contiguous to it. Thus it happened, that, at the division of the kingdom after the death of Solomon, Benjamin espoused the cause of Judah, and formed, together with it, a kingdom by themselves. Indeed, the two tribes stood always in such a close connection, as often to be included under the single term Judah (1 Kings xi. 13; xii. 20). After the exile, also, these two tribes constituted the flower of the new Jewish colony in Palestine (comp. *Ezr.* xi. 1; x. 9).—E. M.

BEREA (Βέροια), Acts xvii. 10, a city of Macedonia, which Pliny (*Hist. Nat.* iv. 10) places in the northern part of that province; and Ptolemy (*Geog.* iii. 13) in that part of it called *Æmathia*. It was on the river *Stræus*, not far from Pella, towards the south-west, and near Mount *Bermius*. It was afterwards called *Irenopolis*, and is now known by the name of *Boor*. Paul and Silas withdrew to this place from *Thessalonica*; and the Jewish residents are described as more ingenuous, and of a better disposition (not 'more noble,' as in the Authorized Version) 'than those of *Thessalonica*' (οἱ τοῦ δὲ ἦσαν εὐγενέστεροι τῶν ἐν Θεσσαλονικῆ), in that they diligently searched the Scriptures to ascertain the truth of the doctrines taught by the Apostles.

BERENICE (Βερνίκη), eldest daughter of Herod Agrippa I., and sister of the younger Agrippa (Acts xxv. 13, 23; xxvi. 30). She was married to her uncle Herod, king of *Chalcis*; and after his death, in order to avoid the merited suspicion of incest with her brother Agrippa, she became the wife of *Polemon*, king of *Cilicia*. This connection being soon dissolved, she returned to her brother, and afterwards became the mistress of *Vespasian* and *Titus* (Joseph. *Antiq.* xix. 5. 1; xx. 7; 2, 3; Tacit. *Hist.* ii. 81; Suet. *Tit.* 7).

BERODACH-BALADAN. [MERODACH-BALADAN.]

BEROSH (בְּרוֹשׁ) occurs in several passages of Scripture, as in 2 Sam. vi. 5; 1 Kings v. 8; vi. 15 and 34; ix. 11; 2 Kings ix. 23; 2 Chron. ii. 8; iii. 5; Ps. civ. 17; Isa. xiv. 8; xxxvii. 24; xli. 19; lv. 13; lx. 13; Ezek. xxvii. 5; xxxi. 8; Hos. xiv. 8; Nah. ii. 3; Zech. xi. 2; and BEROTH (בְּרוֹת), which is said to be only the Aramaean pronunciation of the same word, in Cant. i. 17, 'the bearers of our house are cedar, and the rafters of fir' (Bereth). So in most of the other passages *Eres* and *Berosh*, translated *Cedar* and *Fir* in the Auth. Vers., are mentioned together, as 1 Kings v. 8, 'And Hiram sent to Solomon saying, I will do all thy desire concerning timber of cedar, and concerning timber of fir;' Isa. xiv. 8, 'Yes, the fir-trees rejoice at thee, and the cedars of Lebanon.' But Rosenmüller says, 'In most of the passages where the Hebrew word occurs, it is by the oldest Greek and the Syriac translators rendered *Cypress*.' Celsius and the contrary, is of opinion that *Berosh* indicates the cedar of Lebanon, and that *Eres*, which is usually considered to have the same meaning, is

the common pine (*pinus sylvestris*), apparently because he conceives Berosh to be changed from *sherbin*, the Arabic name of *pine*. Others have thought that Berosh is the box, ash, juniper, &c.

The word *berosh* or *beroth* is slightly varied in the Syriac and Chaldee versions, being written *berutha* in the former, and *berath* in the latter. All these are closely allied to *bruta*, a name of the Savine plant, which is the $\beta\rho\delta\theta\nu$, $\beta\rho\delta\theta\nu$, and $\beta\rho\delta\theta\nu$ of the Greeks, and which the Arabs have converted into *burasee* and *buratee*. By them it is applied to a species of juniper, which they call *abhul* and *arus* or *orus*. It appears to us that many of these terms must be considered generic, rather than specific in the modern sense, when so much care is bestowed on the accurate discrimination of one species from another. Thus *arus*, applied by the Arabs to a juniper, indicates a pine-tree in Scripture, whether we follow the common acceptance and consider it the cedar, or adopt the opinion of Celsius, that the *pinus sylvestris* is indicated. So *buratee* may have been applied by the Arabs, &c. not only to the Savine and other species of juniper, but also to plants, such as the cypress, which resemble these. In many of those cases, therefore, where we are unable to discover any absolute identity or similarity of name, we must be guided by the nature of the trees, the uses to which they were applied, and the situations in which they are said to have been found. Thus, as we find Eres and Berosh so constantly associated in Scripture, the former may indicate the cedar with the wild pine-tree, while the latter may comprehend the juniper and cypress tribe.

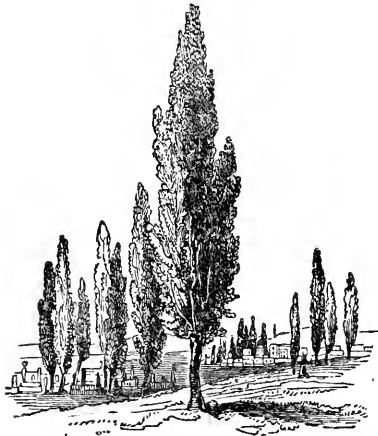

163. [Cypress—*Cupressus sempervirens*.]

The different species of juniper have by some botanists been ranked under *Cedrus*, the true species being distinguished by the title of *Cedrus baccifera*, and the pines by that of *Cedrus conferta*. Of *Juniperus*, the $\alpha\rho\kappa\epsilon\theta\omicron\varsigma$ of the Greeks and *abhul* of the Arabs, there are several species in Syria. Of these *J. communis*, the common juniper, is a very widely diffused species, being found in Europe and Asia, in the plains of northern and in the mountains of southern latitudes; usually forming a low shrub, but in some situations being 15 feet, and even 30 feet high. *J. Oxycedrus*, the sharp or prickly, or

brown-berried juniper, closely allied to the common juniper, is an evergreen shrub, from 10 to 12, but sometimes even 20 feet high. It was found by M. Boué on Mount Lebanon. *J. drupacea* or large-fruited juniper is a species which was introduced into Europe from the East under the Arabic name *Habel*. This name, however, is applied rather to all the species than to any one in particular. It is a native of Mount Cassius, and is thought to be the same as the greater juniper found by Belon on Mount Taurus, which he describes as rising to the height of a cypress. *J. Phœnicæ*, or Phœnician juniper, is the great juniper of Dioscorides, and is a native of the south of Europe, Russia, and Syria. It has imbricated leaves, bears some resemblance to the cypress, and attains a height of from 20 to 30 feet. *J. Lycia*, or Lycian juniper, is a dwarf species, and *J. Sabina*, or the common Savine, is usually a low spreading shrub, but sometimes rises to the height of 10 or 12 feet. It is a native of the south of Europe and Syria. Of these species *J. Oxycedrus* and *J. Phœnicæ* are the only species which could have been the Berosh of Scripture. Some are of opinion that the wood of *J. Oxycedrus*, rather than that of the so-called cedar of Lebanon, is the cedar-wood so famed in ancient times for its durability, and which was therefore employed in making statues. It is to the wood of certain species of juniper that the name of cedar-wood is now specially applied.

Cupressus, the $\kappa\nu\rho\delta\rho\iota\sigma\sigma\omicron\varsigma$ of the Greeks and the *suroo* of the Arabs, called also by them *shujrât-ahyat*, or tree of life, is the *Cupressus sempervirens*, or the evergreen cypress of botanists. This tree is well known as being tapering in form, in consequence of its branches growing upright and close to the stem, and also that in its general appearance it resembles the Lombardy poplar, so that the one is often mistaken for the other when seen in Oriental drawings. In southern latitudes it usually grows to a height of 50 or 60 feet. Its branchlets are closely covered with very small imbricated leaves, which remain on the tree for 5 or 6 years. Du Hamel states that he has observed on the bark of young cypresses small particles of a substance resembling gum tragacanth, and that he has seen bees taking great pains to detach these particles, probably to supply some of the matter required for forming their combs. This cypress is a native of the Grecian Archipelago, particularly of Candia (the ancient Crete) and Cyprus, and also of Asia Minor, Syria, and Persia. It may be seen on the coast of Palestine, as well as in the interior, as the Mahomedans plant it in their cemeteries. That it is found on the mountains of Syria is evident from the following passage, which with others is quoted and translated by Celsius, *Hierobot.* i. p. 133: Cyrillus Alexandr. in *Esaiam*, p. 848—' Mons est phœnicæ Libanus, cedris, cupressis ac pinis densus, et ipsis thuris fruticibus.' So Jerome, *Comment. in Hos.* xiv. 6—' Crebræ hic crescunt cedri. Rectæ quoque et electæ abietes, odorifera cypressi, seu cyparissi, pingues olivæ, pini, buxi, &c. The cypress being so common, we should expect it to be frequently mentioned in Scripture; but this does not appear to be the case, if we judge by the *Aeth. Vers.*, as it occurs there only once, in *Isa.* xliv. 14, 'He heweth him down cedars and taketh the cypress and the oak,' for the

purpose of making idols. The word here translated 'cypress' is *tirza*, which there does not appear to be any other authority for identifying with the cypress. But the cypress is expressly mentioned in the Apocrypha (Ecclus. xxiv. 13), where it is described as growing upon the Mountains of Hermon; and it has been observed by Mr. Kitto, that if this be understood of the great Hermon, it is illustrated by Pococke, who tells us that it is the only tree which grows towards the summit of Lebanon. In Ecclus. l. 10, the high-priest is compared to a 'cypress towering to the clouds,' on account of his tall and noble figure. 'The wood of the cypress is hard, fragrant, and of a remarkably fine close grain, very durable, and of a beautiful reddish hue, which Pliny says it never loses.' As to the opinion respecting the durability of the cypress-wood entertained by the ancients, it may be sufficient to adduce the authority of Pliny, who says 'that the statue of Jupiter, in the Capitol, which was formed of cypress, had existed above 600 years without showing the slightest symptom of decay, and that the doors of the Temple of Diana at Ephesus, which were also of cypress, and were 400 years old, had the appearance of being quite new.' This wood was used for a variety of purposes, as for wine-presses, poles, rafters, and joists. Horace says, that whatever was thought worthy of being handed down to remote posterity was preserved in cypress or cedar wood: and Virgil refers to it in these lines (*Georg.* ii. 412),

————— 'dant utile lignum

Navigiis pinos, domibus cedrumque cypressosque.'

In all the passages of Scripture, therefore, the cypress will be found to answer completely to the descriptions and uses of the Berosh; for it is well adapted for building, is not subject to destruction, and was therefore very likely to be employed in the erection of the Temple, and also for its gates and flooring; for the decks of ships, and even for musical instruments and lances. J. E. Faber, as quoted by Rosenmüller, conjectures that the Hebrew name Berosh included three different trees which resemble each other, viz. the evergreen cypress, the thyme, and the savine. The last, or Juniperus Sabina, is so like the cypress, that the ancients often called it by that name, and the moderns have noticed the resemblance, especially as to the leaves. 'Hence, even among the Greeks, both trees bore the old Eastern names of Berosh, Beroth, Brutha, or Brathy' (Rosenmüller, *Bot. of Bible*, Trans. p. 260).—J. F. R.

BERYL. [SHOHAM.]

BESHA (בֶּשֶׂת) occurs in the singular form in Job xxxi. 40, 'Let thistles grow instead of wheat, and cockle (besha) instead of barley;' and in the plural form in Isaiah v. 2, 'He (Jehovah) planted it with the choicest vine, and also made a wine-press therein; and he looked that it should bring forth grapes, and it brought forth wild grapes' (בִּשְׂמֵת בֶּשֶׂת *beushim*). So also in verse 4 of the same chapter. It is probable that the same plant is referred to in these two passages; but difficulties have here, as elsewhere, been experienced in ascertaining the precise plant intended. All, however, are agreed that some useless, if not noxious, herb must be understood in both cases. Some have supposed that it was a plant with offensive odour, as the word implies a bad smell; others, that it was a thorny plant, a bramble,

darnel, &c. In addition to these conjectures we may infer, that, if not a general term for weeds, the word denoted a plant which sprung up in cultivated ground. Celsius seeks in Arabic for the name of some noxious plant similar to *besha*, and he finds it in the *besb* or *bish*, which has long been known as one of the most powerful of poisons. This name seems to have been adopted by the Arabs from the Hindoos, among whom the *bish* is likewise celebrated as a poison, and is pointed out as a product of the Himalayan mountains. Celsius refers it to the Hebrew verb בִּשָׁה, but it is no doubt derived from the Sanscrit *visha*, signifying poison; and the plant is the *Aconitum ferox* of Dr. Wallich (*Pl. Asiat. Rar.* i. 2. 41) and Royle (*Illustr. Himalayan Bot.* p. 46). The Latin translators of Avicenna consider the *bish* to be the *Napellus*, or an Aconite, proving that in some cases a considerable approximation to correctness was attained in ascertaining the kind of plants yielding drugs which were formerly in use in medicine. *Bish* having thus been ascertained to be an Aconite, and to be the same word as *besha*, the latter has in consequence been thought to indicate *Aconitum album*, the only species which appears to be found in Syria. It is not anywhere very common, but is most likely to occur on the sides of hills, the situations usually selected as the sites for vineyards.

But as we have seen that *bish* is probably derived from the Sanscrit *visha*, the correspondence of the Arabic *bish* with the Hebrew *besha* is accidental, and does not prove them to be even allied. The Aconite, moreover, is not very likely to have sprung up instead of barley in a vineyard of Palestine, and still less so in a more southern latitude, to which the passage in Job must refer, the scene of that book being thought to have been Idumæa, a part of Arabia Petræa, on the south-east of the tribe of Judah. Hence other plants have been sought for; some being in favour of the *ἄμπελος ἄγρια* of the Greeks and *labrusca* of the Romans, which is considered to be the wild variety of *Vitis vinifera*. Of this Dioscorides 'genera duo fecit: alterius enim uva non maturaescit, sed florum tantum profert οἰνάνθην nominatum; altera fructum perfcit, ex parvis acinis nigris subastringentibus.' In the neighbourhood of Tripoli, Raufold found wild vines, called *labrusca*, on which nothing appeared, but only the flower (*ananthe*).

Others, not satisfied with this determination, have endeavoured to find some plant which, resembling the vine in some respects, should yet be strongly contrasted with it in its properties. Thus, the Hebrew name of the grape being *hanob*, there can be no doubt that it is the same word as the Arabic *'anab*, which also signifies the grape. But in Arabia it is rather used generically than specifically, as, besides the common grape, there are also *anab-al-salih*, or ox's grape, and *anab-al-dub*, or wolf-grape. The former name we have found applied in India to the var. *indicum* of *Solanum nigrum*, which is a common weed in Europe, and even in India, especially in the neighbourhood of cultivated ground. This, which somewhat resembles the grape in the form of its berried fruit, is very different in its properties, being narcotic and poisonous. Hasselquist came nearly to the same conclusion, for in reference to the passage of Isaiah, he says, 'I am inclined to believe

that the prophet here means the hoary nightshade (*Solanum incanum*), because it is common in Egypt and Palestine, and the Arabian name agrees well with it. The Arabs call it *anib-el-dib*, i. e. wolf-grape. The prophet could not have found a plant more opposite to the vine than this, for it grows much in the vineyards, and is very pernicious to them, wherefore they root it out: it likewise resembles a vine by its shrubby stalk' (Hasselquist, *Travels*, p. 289). This plant appears better entitled than the Aconite to be contrasted with the grape-vine, and it is not unworthy of notice that either it or the *Solanum nigrum* will suit the passage of Job equally well.—J. F. R.

BESOR (בִּסְרוֹר; Sept. Βοσόρ), a brook mentioned in 1 Sam. xxx. 9. Sanutus derives its course from the interior Carmel, near Hebron, and states that it enters the sea near Gaza (*Liber Secretorum*, p. 252). It is without doubt the same that Richardson crossed on approaching Gaza from the south, and which he calls Oa di Gaza (Wady Gaza). The bed was thirty yards wide, and its stream was, early in April, already exhausted, although some stagnant water remained.

BETH (בֵּית *house*) is often found as the first element of proper names of places in the

Bible. It is only necessary to observe that, in all such compounds, as Bethel, &c., the latter part of the word must be considered, according to our Occidental languages, to depend on the former in the relation of the *genitive*; so that Bethel can only mean 'house of God.' The notion of *house* is, of course, capable of a wide application, and is used to mean temple, habitation, place, according to the sense of the word with which it is combined.—J. N.

BETHABARA (Βηθαβάρ) or BETHHARAM. This name means *place of the ford*, i. e. of or over the Jordan; and is mentioned in John i. 28, as the place where John baptized. The best manuscripts and recent editions, however, have Βηθανία (Bethany): the reading Βηθαβάρ appears to have arisen from the conjecture of Origen, who in his day found no such place on the Jordan as Bethany, but knew a town called Bethabara, where John was said to have baptized, and therefore took the unwarrantable liberty of changing the reading (Orig. *Opp.* ii. p. 139, ed. Huet; Kuinoel, *Comment. in Joh.* i. 28).

BETHANY (Βηθανία, from the Heb. בֵּית דָּת, *place of dates*). 1. The place near the Jordan where John baptized, the exact situation of which is unknown. Some copies here read Bethabara, as stated in the preceding article. 2. BETHANY, a



164. [Bethany.]

town or village about fifteen furlongs east-south-east from Jerusalem, beyond the Mount of Olives (John xi. 18), so called, probably, from the number of palm-trees that grew around. It was the residence of Lazarus and his sisters Mary and Martha, and Jesus often went out from Jerusalem to lodge there (Matt. xxi. 17; xxvi. 6; Mark xi. 1, 11, 12; xiv. 3; Luke xix. 29; xxiv. 50; John xi. 1, 18; xii. 1). The place still subsists in a shallow wady on the eastern slope of the Mount of Olives. Dr. Robinson reached Bethany in three-quarters of an hour from

the Damascus gate of Jerusalem; which gives a distance corresponding to the fifteen furlongs (stadia) of the evangelist. It is a poor village of about twenty families. The only marks of antiquity are some hewn stones from more ancient buildings, found in the walls of some of the houses. The monks, indeed, show the house of Mary and Martha, and of Simon the leper, and also the sepulchre of Lazarus, all of which are constantly mentioned in the narratives of pilgrims and travellers. The sepulchre is a deep vault, like a cellar, excavated in the limestone rock

in the middle of the village, to which there is a descent by twenty-six steps. Dr. Robinson (ii. 101) alleges that there is not the slightest probability of its ever having been the tomb of Lazarus. The form is not that of the ancient sepulchres, nor does its situation accord with the narrative of the New Testament, which implies that the tomb was not in the town (John xvi. 31, 38). The present Arab name of the village is el-Azirezeh, from el-Azir, the Arabic form of Lazarus.

BETH-ARBEL (בֵּית אֲרְבֵּאל), a place mentioned only in Hos. x. 14; and as it seems to be there implied that it was an impregnable fortress, the probability is strengthened of its being the same as the Arbela of Josephus. This was a village in Galilee, near which were certain fortified caverns. They are first mentioned in connection with the march of Bacchides into Judæa, at which time they were occupied by many fugitives, and the Syrian general encamped there long enough to subdue them (*Antiq.* xii. 1. 1; 1 Macc. ix. 2). At a later period these caverns formed the retreats of banded robbers, who greatly distressed the inhabitants throughout that quarter. Josephus gives a graphic account of the means taken by Herod to extirpate them. The caverns were situated in the midst of precipitous cliffs, overhanging a deep valley, with only a steep and narrow path leading to the entrance: the attack was therefore exceeding difficult. Parties of soldiers being at length let down in large boxes, suspended by chains from above, attacked those who defended the entrance, with fire and sword, or dragged them out with long hooks and dashed them down the precipice. In this way the place was at length subdued (*Joseph. Antiq.* xiv. 15. 4, 5; *De Bell. Jud.* i. 16. 2-4). These same caverns were afterwards fortified by Josephus himself against the Romans during his command in Galilee. In one place he speaks of them as the caverns of Arbela, and in another as the caverns near the lake of Gennesareth (*Joseph. Vita*, § 37; *De Bell. Jud.* ii. 20. 6). According to the Talmud, Arbela lay between Sepphoris and Tiberias (*Lightfoot, 'Chorog. Cent.* c. 85). These indications leave little doubt that Arbela of Galilee, with its fortified caverns, may be identified with the present Kulat ibn Maan and the adjacent ruins now known as Irbid (probably a corruption of Irbil, the proper Arabic form of Arbela). This latter is the site which Pococke (ii. 58) supposed to be that of Bethsaida, and where he found columns and the ruins of a large church, with a sculptured doorcase of white marble. The best description of the neighbouring caves is that of Burckhardt (p. 331), who calculates that they might afford refuge to about 600 men.

BETH-AVEN, a nickname for the town of Bethel, applied to it after it became the seat of the worship of the golden calves [**BETHEL**]. There was, however, a town of this name not far from Bethel eastward (*Josh.* vii. 2; 1 Sam. xiii. 5), the existence of which, perhaps, occasioned the transfer of the name to Bethel. The Talmudists confound it with Bethel. There was also a desert of the same name (*Josh.* xviii. 12).

BETHEL (בֵּית אֵל; Sept. Βαθὴλ), originally Luz (לֹז; Sept. Λουζά), an ancient town which Eusebius places 12 R. miles north of Jerusalem, on

the right hand of the road to Shechem. Jacob rested here one night on his way to Padan-Aram, and commemorated the vision with which he was favoured by erecting and pouring oil upon the stone which had served him for a pillow, and giving to the place the name of Bethel (*place or house of God*), which eventually superseded the more ancient designation of Luz (*Gen.* xxviii. 11-19). Under that name it is mentioned prophetically with reference to the earlier *time* of Abraham (*Gen.* xii. 18; xiii. 3). After his prosperous return, Bethel became a favourite station with Jacob: here he built an altar, buried Deborah, received the name of Israel (for the second time), and promises of blessing; and here also he accomplished the vow which he had made on his going forth (*Gen.* xxxv. 1-15; comp. xxxii. 28, and xxviii. 20-22). It seems not to have been a town in those early times; but at the conquest of the land, Bethel is mentioned as a royal city of the Canaanites (*Josh.* xii. 16). It became a boundary town of Benjamin toward Ephraim (*Josh.* xviii. 22), and was actually conquered by the latter tribe from the Canaanites (*Judg.* i. 22-26). At this place, already consecrated in the time of the patriarchs, the ark of the covenant was, apparently for a long while, deposited [ARK], and probably the tabernacle also (*Judg.* xx. 26; comp. 1 Sam. x. 3). It was also one of the places at which Samuel held in rotation his court of justice (1 Sam. vii. 16). After the separation of the kingdoms Bethel was included in that of Israel, which seems to show, that although originally in the formal distribution assigned to Benjamin, it had been actually possessed by Ephraim in right of conquest from the Canaanites—which might have been held by that somewhat unscrupulous tribe to determine the right of possession to a place of importance close on their own frontier. Jeroboam made it the southern seat (Dan being the northern) of the worship of the golden calves; and it seems to have been the chief seat of that worship (1 Kings xii. 28-33; xiii. 1). The choice of Bethel was probably determined by the consideration that the spot was already sacred in the estimation of the Israelites, not only from patriarchal consecration, but from the more recent presence of the ark; which might seem to point it out as a proper seat for an establishment designed to rival that of Jerusalem. This appropriation, however, completely desecrated Bethel in the estimation of the orthodox Jews; and the prophets name it with abhorrence and contempt—even applying to it, by a sort of *jeu de mot*, the name of Bethaven (*house of idols*) instead of Bethel (*house of God*) (*Amos* v. 5; *Hos.* iv. 15; v. 8; x. 5, 8). The town was taken from Jeroboam by Abijah, king of Judah (2 Chron. xiii. 19); but it again reverted to Israel (2 Kings x. 28). After the Israelites were carried away captive by the Assyrians, all traces of this illegal worship were extirpated by Josiah, king of Judah, who thus fulfilled a prophecy made to Jeroboam 350 years before (2 Kings xiii. 1, 2; xxiii. 15-18). The place was still in existence after the Captivity, and was in the possession of the Benjamites (*Ezra* ii. 28; *Neh.* vii. 32). In the time of the Maccabees Bethel was fortified by Bacchides for the king of Syria (*Joseph. Antiq.* xiii. 1. 13). It is not named in the New Testament; but it still existed and was taken by Vespasian. (*Joseph. De*

Bell. Jud. iv. 9. 9). It is described by Eusebius and Jerome as a small village (*Onomast.* s. vv. *Aggai* and *Luzā*); and this is the last notice of it as an inhabited place. Bethel and its name were believed to have perished until within these few years; yet it has been ascertained by the Protestant missionaries at Jerusalem that the name and a knowledge of the site still existed among the people of the land. The name was indeed preserved in the form of Beitin—the Arabic termination *in* for the Hebrew *el* being not an unusual change. Its identity with Bethel had been recognised by the Oriental Christian priests, who endeavoured to bring into use the Arabic form *Beitil*, as being nearer to the original; but it had not found currency beyond the circle of their influence.

The situation of Beitin corresponds very exactly with the intimations afforded by Eusebius and others; the distance from Jerusalem, $3\frac{3}{4}$ hours, being equal to the 12 Roman miles assigned in the *Onomasticon*. The ruins lie upon the point of a low hill, between the heads of two shallow wadys which unite below, and run off into a deep and rugged valley. The spot is shut in by higher land on every side. The ruins are more considerable than those of a 'large village,' as the place was in the time of Jerome; and it is therefore likely that, although unnoticed in history, it afterwards revived, and was enlarged. The ruined churches upon the site and beyond the valley evince that it was a place of importance even down to the middle ages. Besides these, there yet remain numerous foundations and half-standing walls of houses and other buildings; on the highest part are the ruins of a square tower, and in the western valley are the remains of one of the largest reservoirs in the country, being 314 feet in length by 217 in breadth. The bottom is now a green grass plat, having in it two living springs of good water.

BETHER (בֵּתֵר). The Mountains of Bether are only mentioned in Cant. ii. 17; viii. 14; and no place called Bether occurs elsewhere. The word means, properly, *dissection*. The mountains of Bether may therefore be *mountains of disjunction, of separation, etc.*, that is, mountains cut up, divided by ravines, etc. In the Authorized Version the same words that are rendered 'mountains of Bether' in Cant. ii. 17, are rendered 'mountains of spices' in viii. 14. It is an objectionable mode of disposing of two different interpretations, to adopt sometimes the one and sometimes the other. The second interpretation is reached by considering that the mountains derived their name from the growth of trees, from *incisions* (with reference to the etymology) in which odoriferous gums distilled. This is after the Sept.—*ὄρη τῶν ἀρωμάτων*; which version also sets the example of a difference in rendering by giving *ὄρη κοιλωμάτων*, *hollow mountains*, in the previous passage. As the word is found nowhere else as a proper name, it is doubtful if it should be so taken in the Canticles.

BETHESDA (Βηθεσδα; from Heb. בֵּית שֶׁבַע *house or place of mercy*), a pool (κοιλυβήθρα) at the Sheep-gate of Jerusalem, built round with porches for the accommodation of the sick who sought benefit from the healing virtues of the water, and upon one of whom Christ performed

the healing miracle recorded by St. John (v. 2-9). That which is now, and has long been pointed out as the Pool of Bethesda, is a dry basin or reservoir outside the northern wall of the enclosure around the Temple Mount, of which wall its southern side may be said to form a part. The east end of it is close to the present gate of St. Stephen. The pool measures 360 feet in length, 130 feet in breadth, and 75 in depth to the bottom, besides the rubbish which has accumulated in it for ages. Although it has been dry for above two centuries, it was once evidently used as a reservoir, for the sides internally have been cased over with small stones, and these again covered with plaster; but the workmanship of these additions is coarse, and bears no special marks of antiquity. The west end is built up like the rest, except at the south-west corner, where two lofty arched vaults extended westward, side by side, under the houses that now cover this part.



165. [Pool of Bethesda.]

Dr. Robinson was able to trace the continuation of the work in this direction under one of these vaults for 100 feet, and it seemed to extend much farther. This gives the whole a length of 160 feet, equal to one-half of the whole extent of the sacred enclosure under which it lies; and how much more is unknown. It would seem as if the deep reservoir formerly extended farther westward in this part; and that these vaults were built up, in and over it, in order to support the structures above. Dr. Robinson considers it probable that this excavation was anciently carried quite through the ridge of Bezetha, along the northern side of Antonia to its N.W. corner, thus forming the deep trench which separated the fortress from the adjacent hill (*Bib. Researches*, i. 433, 434). The mere appearance of the place, and its position immediately under the wall of the sacred enclosure, strongly support this conjecture, so that we are still left to seek the Pool of Bethesda, if indeed any trace of it now remains. Dr. Robinson himself, without having any definite conviction on the subject, asks whether the Pool of Bethesda may not in fact be the 'Fountain of the Virgin'? The question was suggested to his mind by the exceedingly abrupt and irregular plan of that fountain. He remarks—'We are told that an angel went down at a certain season into the pool and troubled the water; and then whosoever first stepped in was made whole (*John* v. 2-7). There seems to have been no special me-

dicinal virtue in the water itself, and only he who first stepped in after the troubling was healed. Does not this troubling of the water look like the irregular plan of this fountain? And as the Sheep-gate seems to have been situated not far from the Temple (Neh. iii. 1, 32), and the wall of the ancient Temple probably ran along this valley; may not that gate have been somewhere in this part, and the Fountain of the Virgin correspond to Bethesda? the same as the 'King's Pool' of Nehemiah, and the 'Solomon's Pool' of Josephus? (*Bibl. Researches*, i. 508). For an account of the Fountain to which these inquiries relate, we must refer to the article on the Fountain, with which that of the Virgin is closely connected [SILOAM, POOL OF].

BETH-HORON (בֵּית הָרוֹן; Sept. *Βαιθωρών*): two places of this name are distinguished in Scripture as the Upper and Nether Beth-horon (Josh. xvi. 3, 5; xviii. 13; 1 Chron. vii. 24). The Nether Beth-horon lay in the N.W. corner of Benjamin; and between the two places was a pass called both the ascent and descent of Beth-horon, leading from the region of Gibeon (el-Jib) down to the western plain (Josh. xviii. 13, 14; x. 10, 11; 1 Macc. iii. 16, 24). Down this pass the five kings of the Amorites were driven by Joshua (Josh. x. 11). The upper and lower towns were both fortified by Solomon (1 Kings ix. 17; 2 Chron. viii. 5). At one of them Nicanor was attacked by Judas Maccabæus; and it was afterwards fortified by Bacchides (1 Macc. vii. 39, seq.; ix. 50; Joseph. *Antiq.* xii. 10. 5; xiii. 1. 3). Cestius Gallus, the Roman consul of Syria, in his march from Cæsarea to Jerusalem, after having burned Lydda, ascended the mountain by Beth-horon and encamped near Gibeon (Joseph. *De Bell. Jud.* ii. 19. 1). Dr. Robinson collects from these intimations that in ancient times, as at the present day, the great road of communication and of heavy transport between Jerusalem and the sea-coast was by the pass of Beth-horon (*Bibl. Researches*, iii. 61).

In the time of Eusebius and Jerome the two Beth-horons were small villages; and, according to them, the Upper Beth-horon was 12 Roman miles from Jerusalem; according to Josephus, it was 100 stadia from thence, and 50 stadia from Gibeon. From the time of Jerome the place appears to have been unnoticed till 1801, when Dr. E. D. Clarke recognised it in the present Beit-Ur (*Travels*, vol. i. pt. ii. p. 628); after which it appears to have remained unvisited till 1838, when the Rev. J. Paxton, and, a few days after, Dr. Robinson, arrived at the place. The Lower Beit-Ur is upon the top of a low ridge, which is separated by a wady, or narrow valley, from the foot of the mountain upon which the Upper Beit-Ur stands. Both are now inhabited villages. The lower is very small, but foundations of large stones indicate an ancient site—doubtless that of the Nether Beth-horon. The Upper Beit-Ur is likewise small, but also exhibits traces of ancient walls and foundations. In the steep ascent to it the rock is in some parts cut away, and the path formed into steps, indicating an ancient road. On the first offset or step of the ascent are foundations of huge stones, the remains perhaps of a castle that once guarded the pass.

It is remarkable that the places are still dis-

tinguished as Beit-Ur el-Foka (the Upper), and Beit-Ur el-Tahta (the Lower), and there can be no question that they represent the Upper and Lower Beth-horon. 'In the name,' remarks Dr. Robinson (iii. p. 59), 'we find the rather unusual change from one harsh Hebrew guttural to one still deeper and more tenacious in Arabic; in all other respects the name, position, and other circumstances agree.'

BETH-LEHEM (בֵּית לֶחֶם, *house or place*

of bread, i. q. *Bread-town*; now **بيت لحم**, *house of flesh*; Sept. *Βηθλεέμ*), a city of Judah (Judg. xvii. 7), six miles southward from Jerusalem, on the road to Hebron. It was generally called Bethlehem-Judah, to distinguish it from another Bethlehem in Zebulun (Josh. xix. 15; Judg. xii. 10). It is also called Ephrathah (the fruitful), and its inhabitants Ephrathites (Gen. xlviii. 7; Mic. v. 2). Bethlehem is chiefly celebrated as the birth-place of David and of Christ, and as the scene of the Book of Ruth. It was fortified by Rehoboam (2 Chron. xi. 6); but it does not appear to have been a place of much importance; for Micah, extolling the moral pre-eminence of Bethlehem, says, 'Thou, Bethlehem Ephrathah, though thou be little among the thousands of Judah,' &c. (Mic. v. 2). Matthew quotes this as—'and thou, Bethlehem of Judah, art not the least of the cities of Judah,' &c. (Matt. ii. 6), which has the appearance of a discrepancy. But it is answered that a city may be little, without being the least; or that the evangelist may have quoted from memory, and hence the slight difference in expression, while the sense remains the same.

There never has been any dispute or doubt about the site of Bethlehem, which has always been an inhabited place, and, from its sacred associations, has been visited by an unbroken series of pilgrims and travellers. It is now a large village, beautifully situated on the brow of a high hill, which commands an extensive view of the surrounding mountainous country, and rises in parterres of vineyards, almond-groves and fig plantations, watered by gentle rivulets that murmur through the terraces; and is diversified by towers and wine-presses. It is a straggling village, with one broad and principal street. The houses have not domed roofs like those of Jerusalem and Rumla, they are built for the most part of clay and bricks; and every house is provided with an apiary, the beehives of which are constructed of a series of earthen pots, ranged on the house-tops. The inhabitants are said to be 3000, and were all native Christians at the time of the most recent visits; for Ibrahim Pasha, finding that the Moslem and Christian inhabitants were always at strife, caused the former to withdraw, and left the village in quiet possession of the latter, whose numbers had always greatly predominated (Wilde's *Narrative*, ii. p. 411). The chief trade and manufacture of the inhabitants consist of beads, crosses, and other relics, which are sold at a great profit. Some of the articles, wrought in mother-of-pearl, are carved with more skill than one would expect to find in that remote quarter; and the workmanship in some instances would not discredit the artists of Britain. The people are said to be remarkable for their ferocity

and ruleless, which is indeed the common character of the inhabitants of most of the places accounted holy in the East.

At the farthest extremity of the town is the Latin convent, connected with which is the Church of the Nativity, said to have been built by the empress Helena. It has suffered much from time, but still bears manifest traces of its Grecian origin; and is alleged to be the most chaste architectural building now remaining in Palestine. It is a spacious and handsome hall, consisting of a central nave amid aisles separated from each other by rows of tall Corinthian pillars of grey marble. As there is no ceiling, the lofty roof is exposed to view, and although composed of the cedars of Lebanon, is still in good preservation, and affords a fine specimen of the architecture of that age. Two spiral staircases lead to the cave called the 'Grotto of the Nativity,' which is about 20 feet below the level of the church. This cave is lined with Italian marbles, and lighted by numerous lamps. Here the pilgrim is conducted with due solemnity to a star inlaid in the marble, marking the exact spot where the Saviour was born, and corresponding to that in the firmament occupied by the meteor which intimated that great event; he is then led to one of the sides, where, in a kind of recess, a little below the level of the rest of the floor, is a block of white marble, hollowed out in the form of a manger, and said to mark the place of the one in which the infant Jesus was laid. His attention is afterwards directed to the 'Sepulchre of the Innocents;' to the grotto in which St. Jerome passed the greater portion of his life; and to the chapels dedicated to Joseph and other saints. There has been much controversy respecting the claims of this grotto to be regarded as the place in which our Lord was born. Tradition is in its favour, but facts and probabilities are against it. It is useless to deny that there is much force in a tradition regarding a locality (more than it would have in the case of an historical fact), which can be traced up to a period not remote from that of the event commemorated; and this event was so important as to make the scene of it a point of such unremitting attention, that the knowledge of the spot was not likely to be lost. This view would be greatly strengthened if it could be satisfactorily proved that Adrian, to cast odium upon the mysteries of the Christian religion, not only erected statues of Jupiter and Venus over the holy sepulchre and on Calvary, but placed one of Adonis over the spot of the Nativity at Bethlehem. This part of the evidence is examined under another head [CALVARY]. Against tradition, whatever may be its value in the present case, we have to place the utter improbability that a *subterranean* cavern like this, with a steep descent, should ever have been used as a stable for cattle, and, what is more, for the stable of a khan or caravanserai, which doubtless the 'inn' of Luke ii. 7 was. Although therefore it is true that cattle are, and always have been, stabled in caverns in the East; yet certainly not in such caverns as this, which appears to have been originally a tomb. Old empty tombs often, it is argued, afford shelter to man and cattle; but such was not the case among the Jews, who held themselves ceremonially defiled by contact with sepulchres. Besides, the circumstance of Christ's having been

born in a cave would not have been less remarkable than his being laid in a manger, and was more likely to have been noticed by the evangelist, if it had occurred; and it is also to be observed that the present grotto is at some distance from the town, whereas Christ appears to have been born *in* the town, and whatever may be the case in the open country, it has never been usual in towns to employ caverns as stables for cattle. To this we may add the suspicion which arises from the fact, that the local traditions seem to connect with caverns almost every interesting event recorded in Scripture, as if the ancient Jews had been a nation of troglodytes [CAVES]. Under all these circumstances, perhaps the most solid interest connected with the so-called 'Cave of the Nativity,' is to be found in the long abode in the convent of so eminent a father as the learned Jerome; and in the fact that there most of his great and useful works were composed.

On the north-east side of the town is a deep valley, alleged to be that in which the angels appeared to the shepherds announcing the birth of the Saviour (Luke ii. 8). In the same valley is a fountain, said to be that for the water of which David longed, and which three of his mighty men procured for him at the hazard of their lives (2 Sam. xxiii. 15-18). Dr. Clarke stopped and drank of the delicious water of this fountain, and from its correspondence with the intimations of the sacred historian and of Josephus, as well as from the permanency of natural fountains, he concludes that there can be no doubt of its identity.

There are accounts of Bethlehem in nearly all books of travels in Palestine. The best of modern date are those of Clarke, Wittman, Richardson, Buckingham, Hardy, Elliot, Wilde, Robinson, Paxton, Olin, Prokesch, Richter, Schubert (see also Raumer's *Palästina*, pp. 307-313).

BETH-NIMRA (בֵּית נִמְרָה); Sept. Βαυθα-ναβρά; or simply NIMRA, נִמְרָה; Sept. Ναυρά, a town in the tribe of Gad (Num. xxxii. 3, 36; Josh. xiii. 27), which Eusebius (who calls it Bethnabris, Βηθναβρίς) places five Roman miles north of Livia. This leaves no doubt of its being the same ruined city called Nimrin, south of Szalt, which Burckhardt mentions (*Syria*, p. 355) as situated near the point where the Wady Shoeb joins the Jordan. Dr. Robinson understood that there was here a fountain corresponding to 'the waters of Nimra' (Isa. xv. 6; Jer. xlvi. 31).

BETHPHAGE (Βηθφαγή; Syr. ܒܝܬ ܦܗܓܝ; Heb. בֵּית פְּהַג, *house of figs*; comp. Cant. ii. 13), a small village, which our Lord, coming from Jericho, appears to have entered before reaching Bethany (Matt. xxi. 1; Luke xix. 29); it probably, therefore, lay near the latter place, a little below it to the east. The site usually assigned to it *beyond* Bethany in the same direction, and between it and the Mount of Olives, cannot be correct, nor does any trace of Bethphage now exist (Robinson, ii. 103). The name occurs often in the Talmud; and the Jewish glossarists induced Lightfoot (*Chorog. Cent. ch. xli.*) and Otte (*Lex. Rabb. p. 101, sq.*) to regard it as a district extending from the foot of the Mount of Olives to the precincts of Jerusalem, and including the village of the same name.

BETH-REHOB. [REHOB.]

BETHSAIDA (Βηθσαιδά; Syr. ܒܝܬ ܫܝܢܐ)

Fishing-Town, a town (πόλις, John i. 45; κώμη, Mark viii. 23) in Galilee (John xii. 21), on the western side of the sea of Tiberias, towards the middle, and not far from Capernaum (Mark vi. 45; viii. 22). It was the native place of Peter, Andrew, and Philip, and the frequent residence of Jesus. This gives some notion of the neighbourhood in which it lay; but the precise site is utterly unknown, and the very name has long eluded the search of travellers. The last historical notice of it is by Jerome, but he affords no more information than may be derived from the intimations in the New Testament. It is true that Pococke (ii. p. 99) finds Bethsaida at Irbid; Seetzen at Khan Mīnyeh (Zach's *Monath. Corresp.* xviii. 348); Nau at Mejdél (*Voyage*, p. 578; Quaresmius, tom. ii. 866), apparently between Khan Mīnyeh and Mejdél; and others at Tabighah—all different points on the western shore of the lake. But Dr. Robinson expresses his deliberate persuasion that these identifications can have no better foundation than the impression of the moment. He inquired perseveringly among the natives along the western border of the lake; but no Moslem knew of any such name, or any name that could be moulded into a resemblance to it. The Christians of Nazareth and Tiberias are indeed acquainted with the name, as well as that of Capernaum, from the New Testament; and they have learned to apply them to different places according to the opinions of their monastic teachers, or as may best suit their own convenience in answering the inquiries of travellers. It is thus that Dr. Robinson (*Bibl. Researches*, iii. 295) accounts for the fact that travellers have sometimes heard the names along the lake. Whenever this has not been the consequence of direct leading questions, which an Arab would always answer affirmatively, the names have doubtless been heard from the monks of Nazareth, or from the Arabs in a greater or less degree dependent upon them.

2. BETHSAIDA. Christ fed the 5000 'near to a city called Bethsaida' (Luke ix. 10); but it is evident from the parallel passages (Matt. xiv. 13; Mark vi. 32-45), that this event took place not in Galilee, but on the eastern side of the lake. This was held to be one of the greatest difficulties in sacred geography (Cellar. *Notit. Orb.* ii. 536), till the ingenious Reland afforded materials for a satisfactory solution of it, by distinguishing two Bethsaidas; one on the western, and the other on the north-eastern border of the lake (*Palestina*, p. 653). The former was undoubtedly 'the city of Andrew and Peter'; and, although Reland did not himself think that the other Bethsaida is mentioned in the New Testament, it has been shown by later writers that it is in perfect agreement with the sacred text to conclude that it was the Bethsaida near which Christ fed the five thousand, and also, probably, where the blind man was restored to sight. This, and not the western Bethsaida (as our English writers persist in stating), was the Bethsaida of Gaulonitis, afterwards called Julius, which Pliny (*Hist. Nat.* xv.) places on the eastern side of the lake and of the Jordan, and which Josephus describes as situated in lower Gaulonitis, just above the en-

trance of the Jordan into the lake (*De Bell. Jud.* ii. 9. 1; iii. 10. 7). It was originally only a village, called Bethsaida, but was rebuilt and enlarged by Philip the Tetrarch not long after the birth of Christ, and received the name of Julius in honour of Julia the daughter of Augustus (Luke iii. 1; Joseph. *Antiq.* xviii. 2. 1). Philip seems to have made it his occasional residence; and here he died, and was buried in a costly tomb (*Antiq.* xviii. 4. 6). At the northern end of the lake of Gennesareth, the mountains which form the eastern wall of the valley through which the Jordan enters the lake throw out a spur or promontory, which extends for some distance southward along the river. This is known by the people on the spot by no other name than el Tell (the hill). On it are some ruins, which were visited by the Rev. Eli Smith, and proved to be the most extensive of any in the plain. The place is regarded as a sort of capital by the Arabs of the valley (the Ghawarineh), although they have lost its ancient name, and now occupy only a few houses in it as magazines. The ruins cover a large portion of the Tell, but consist entirely of unheaven volcanic stones, without any distinct trace of ancient architecture (Robinson, *Bibl. Researches*, iii. 308; Winer, *Bibl. Realwört.* s. v. 'Bethsaida').

BETH-SHAN (בֵּית שַׁן, *house of rest*, or *Rest-Town*; Sept. Βαιθσαν), a city belonging to the half-tribe of Manasseh, west of the Jordan, and situated in a valley of that river, where it is bounded westward by a low chain of the Gilboa mountains. It is on the road from Jerusalem to Damascus, and is about two miles from the Jordan, eighteen from the southern end of Lake Gennesareth, and twenty-three from Nazareth. It also bore the name of Scythopolis, perhaps because Scythians had settled there in the time of Josiah (b.c. 631), in their passage through Palestine towards Egypt (Herod. i. 205; comp. Pliny, *Hist. Nat.* v. 16, 20; Georg. Syncellus, p. 214). This hypothesis is supported by 2 Macc. xii. 30, where mention is made of 'Jews who lived among the Scythians (in Bethshan)'; and by the Septuagint version of Judg. i. 27; Βαιθσαν, ἢ ἐστὶ Σκυθῶν πόλις. In Judith iii. 2, the place is also called Σκυθῶν πόλις, and so likewise by Josephus and others. The supposition that these were descendants of the Scythians in Palestine, renders more intelligible Coloss. iii. 11, where the Scythian is named with the Jew and Greek; and it also explains why the ancient Rabbins did not consider Scythopolis as a Jewish town, but as one of an unwholy people (Havercamp. *Observat. ad Joseph. Antiq.* v. 1. 22). On coins the place is called Scythopolis and Nysa, with figures of Bacchus and the panther (Eckhel, pp. 438-440; comp. Reland, p. 993, sq.). As Succoth lay somewhere in the vicinity, east of the Jordan, some would derive Scythopolis from Succothopolis (Reland, p. 992, sq.; Gesenius in Burckhardt, p. 1053, German edit.). It is also not improbably supposed to be the same as Beth-Sitta (Judg. vii. 22).

Josephus does not account Scythopolis as belonging to Samaria, in which it geographically lay; but to Decapolis, which was chiefly on the other side of the river, and of which he calls it the largest town (*De Bell. Jud.* iii. 9. 7).

Although Bethshan was assigned to Manasseh

(Josh. xvii. 11), it was not conquered by that tribe (Judg. i. 17). The body of Saul was fastened to the wall of Bethshan by the Philistines (1 Sam. xxxi. 10); Alexander Januæus had an interview here with Cleopatra (Joseph. *Antiq.* xiii. 13. 3); Pompey marched through it on his way from Damascus to Jerusalem (xiv. 3. 4); and in the Jewish war 13,000 Jews were slain by the Scythopolitans (*De Bell. Jud.* ii. 18. 3). In the middle ages the place had become desolate, although it still went by the name of *Metropolis Palestina tertia* (Will. Tyr. pp. 749, 1034; Vitriacus, p. 1119). We find bishops of Scythopolis at the councils of Chalcedon, Jerusalem (A.D. 536), and others. During the Crusades it was an archbishopric, which was afterwards transferred to Nazareth (Raumer's *Palästina*, pp. 147-149).

The ancient native name, as well as the town itself, still exists in the Beisan of the present day. It stands on a rising ground somewhat above the valley of the Jordan, or in the valley of Jezreel where it opens into the Jordan valley. It is a poor place, containing not more than sixty or seventy houses. The inhabitants are Moslems, and are described by Richardson and others as a set of inhospitable and lawless fanatics. The ruins of the ancient city are of considerable extent. It was built along the banks of the rivulet which waters the town and in the valleys formed by its several branches, and must have been nearly three miles in circumference. The chief remains are large heaps of black hewn stones, with many foundations of houses and fragments of a few columns (Burekhardt, p. 243). The principal object is the theatre, which is quite distinct, but now completely filled up with weeds; it measures across the front about 180 feet, and has the singularity of possessing three oval recesses half-way up the building, which are mentioned by Vitruvius as being constructed to contain the brass sounding-tubes. Few theatres had such an apparatus even in the time of this author, and they are scarcely ever met with now. The other remains are the tombs, which lie to the north-east of the Acropolis without the walls. The sarcophagi still exist in some of them; triangular niches for lamps have also been observed in them; and some of the doors continue hanging on the ancient hinges of stone in remarkable preservation. Two streams run through the ruins of the city, almost insulating the Acropolis. There is a fine Roman bridge over the one to the south-west of the Acropolis, and beyond it may be seen the paved way which led to the ancient Ptolemais, now Acri. The Acropolis is a high circular hill, on the top of which are traces of the walls which encompassed it (Irby and Mangles, *Travels*, pp. 301-303).

BETH-SHEMESH (בֵּית שֵׁמֶשׁ, *house of the sun*, i. q. *Sun-town*; Sept. Βαθσαμύς), a sacerdotal city (Josh. xxi. 16; 1 Sam. vi. 15; 1 Chron. vi. 59) in the tribe of Judah, on the (south-east) border of Dan (Josh. xv. 10), and the land of the Philistines (1 Sam. vi. 12), probably in a low-land plain (2 Kings xiv. 1); and placed by Eusebius ten Roman miles from Eleutheropolis, in the direction of the road to Nicopolis. It belonged at an early date to the Philistines, and they had again obtained possession of it in the time of Ahaz (1 Kings iv. 9; 2 Chron.

xxviii. 18). It was to this place that the ark was taken by the milch kine from the land of the Philistines, and it was here that, according to the present text, 'fifty thousand and threescore and ten men' were miraculously slain for irreverently exploring the sacred shrine (1 Sam. vi. 19). This number has occasioned much discussion. It appears likely that the text has been corrupted in transcription by an erroneous solution of an arithmetical sign. The Syriac and Arabic have 5070 instead of 50070 (כ"ז instead of כ"ע), and this statement agrees with 1 Col. Kennicott (comp. Gesenius *Gesch. der Hebr. Sprache*, p. 174). Even with this reduction, the number, for a provincial town like Beth-Shemesh, would still be great. The fact itself has been accounted for on natural principles by some German writers, in a spirit at variance with that of Hebrew antiquity, and in which the miraculous part of the event has been explained away by ungrammatical interpretations.

At the distance, and in the vicinity indicated by Eusebius and Jerome, a place called Ain Shems was found by Dr. Robinson, and, with great probability, identified with Beth-Shemesh. The name is applied to the ruins of an Arab village constructed of ancient materials. To the west of the village, upon and around the plateau of a low swell or mound, are the vestiges of a former extensive city, consisting of many foundations and the remains of ancient walls of hewn stone. With respect to the exchange of Beth for Ain, Dr. Robinson remarks (iii. 19):—'The words Beit (Beth) and Ain are so very common in the Arabic names of Palestine, that it can excite no wonder there should be an exchange, even without an obvious reason. In the same manner the ancient Beth-Shemesh (Heliopolis, of Egypt) is known in Arabian writers as Ain Shems.' The Ir-Shemesh of Joshua (xix. 4) is supposed to be the same as this Beth-Shemesh. 2. There was another Beth-Shemesh in Naphtali (Judg. i. 33). 3. Another in Issachar (Josh. xix. 22). 4. And the Egyptian Beth-Shemesh is named in Jer. xliii. 13; although usually called On.

BETHUEL (בֵּיתוּאֵל; Sept. Βαθουήλ), son of Abraham's brother Nahor, and father of Laban and of Rebecca, whom Isaac married (Gen. xxii. 22, 23). His name only occurs incidentally (Gen. xxiv. 50) in the account of the transactions which led to that marriage, in which Laban takes the leading part. This has given occasion to a number of uncertain conjectures. Josephus concludes that he was then dead; and that the Bethuel here mentioned was a younger brother, named after the father (*Antiq.* i. 16. 1).

BETHULIA (Βεθουλοία; Heb. בֵּיתוּלָה), a place mentioned only in the Apocryphal book of Judith (iv. 5; vii. 1, 3), and which appears to have lain near the plain of Esdraelon on the south, not far from Dothaim, and to have guarded one of the passes towards Jerusalem. Modern ecclesiastical tradition identifies Bethulia with Safed, near the lake of Gennesareth. Travellers prior to the seventeenth century usually give the name of Bethulia to the Frank Mountain in Judæa and to the ruins at its foot. Raumer has lately offered a conjecture in favour of Samur (*Paläst.* p. 149). But Dr. Robinson has intimated the inapplicability

of all these identifications (*Bibl. Researches*, ii. 172; iii. 152, 325), and we must be content to regard the site of Bethulia as still undetermined.

BETH-ZUR (בֵּית צֹר); Sept. Βηθσοῦρ), a town in the tribe of Judah (Josh. xv. 58), twenty Roman miles from Jerusalem, on the road to Hebron (*Onomast.* s. v. 'Beth-zur'), and consequently two miles from the latter city. It was fortified by Rehoboam (2 Chron. xi. 7). The inhabitants assisted in building the walls of Jerusalem (Neh. iii. 16). Lysias was defeated in the neighbourhood by Judas Maccabæus, who fortified the place as a stronghold against Idumæa (1 Macc. iv. 29, 61; 2 Macc. xi. 5; comp. 1 Macc. vi. 7, 26). It was besieged and taken by Antiochus Eupator (1 Macc. vi. 31, 50), and fortified by Bacchides (ix. 52), whose garrison defended themselves against Jonathan Maccabæus (x. 11); but it was taken and fortified by his brother Simon (xi. 65, 66; xiv. 7, 33). Josephus calls Beth-zur the strongest fortress in Judæa (*Antiq.* xiii. 5. 6). Its site has not been ascertained. The traditional Beth-zur, near Bethlehem, where the fountain (of St. Philip) at which the Ethiopian eunuch was baptized is pointed out (Cotovic, p. 247; Pococke, ii. 67; Maundrell, p. 116), cannot be the real place: for, as we have seen, Eusebius places it much more to the south, and is in this supported by its history, which shows that it lay on what was the southern border of the Jordan, in the time of the Maccabees, when the Idumæans had taken possession of the southernmost part of the country and made Hebron their chief town. In those times, indeed, Beth-zur, or Bethsaida, appears to have been the corresponding fortress on the Jewish side of the fountain to that of Hebron on the side of Idumæa, standing at a short distance, and probably over against it, as many similar fortresses are found to do at the present day.

BETRÓTHING. [MARRIAGE.]

BETULIA, anointed stones. [STONES.]

BETZAL (בֵּצַל, in the plural בֵּצָלִים *betzalim*) occurs in Numbers xi. 5, where the Israelites 'murmur for the leeks, and the onions (*betzalim*), and the garlick' of Egypt. Though the identification of many Biblical plants is considered uncertain, there can be no doubt that Betzal means the common onion, the *Allium Cepa* of botanists. This is proved by its Arabic name, and its early employment as an article of diet in Egypt. In the present day the onion, distinguished from other species of *Allium* by its fistular leaves and swelling stalks, is well known to be cultivated in all parts of Europe and in most parts of Asia. Its native country is not known; but it is probable that some part of the Persian region may have first produced it in a wild state, as many species of *Allium* are found in the mountainous chain which extends from the Caspian to Cashmere, and likewise in the Himalayan Mountains. It is common in Persia, where it is called *piaz*, and has been long introduced into India, where it receives the same name. By the Arabs it is called **بصل** *basl* or *bassal*, under which name it is described in their works on *Materia Medica*, in which the description of *κρόμμυον* given by Dioscorides (ii. 181) is adopted. The Arabic is too similar to the He-

brew name to allow us to doubt that both were originally the same word.

That the onion has long been cultivated in the south of Europe and in the north of Asia, is evident from the different kinds enumerated by Theophrastus, which, he states, derived their names chiefly from the places where they were reared. Among these, probably, some other species may have been included; but no doubt several were varieties only of the onion. Pliny (*Hist. Nat.* xix. 6) also enumerates these, as well as others cultivated in Italy, and notices the superstition of the Egyptians in regard to them: 'Where, by the way, I cannot overpass the foolish superstition of the Ægyptians, who use to swear by garlick and onions, calling them to witness in taking their oaths, as if they were no less than some gods' (Holland's transl.). Juvenal (*Sat.* xv. 9) in like manner ridicules the Egyptians for their superstitious veneration of onions, &c.:

'Porrum et cæpe nefas violare et frangere morsu.
O sanctas gentes, quibus hæc nascuntur in hortibus
Numina!'

This, however, must be an exaggerated statement, as it is unlikely that the Israelites should have been allowed to regale themselves upon what was considered too sacred for, or forbidden, to their task-masters. It is probable, as suggested by Dr. Harris, that the priests only refrained from what was freely partaken of by the rest of the people. This may be observed in the present day among the Brahmins of India. It has also been supposed that some particular kind of onion may have been held sacred, from its utility as a medicine, as the sea onion, or squill (*Scilla maritima*), which grows in abundance on the sea-coast in the neighbourhood of Pelusium, whose inhabitants are said by Lucian to have especially worshipped the onion. But it is evident that the Israelites in the desert did not long for this acrid bulb, as they did for the melons and cucumbers.

It may, moreover, be remarked, that the onions of warm dry countries grow to a considerable size, and, instead of being acrid and pungent in taste, are comparatively bland, and mild and nutritious articles of diet. This is particularly conspicuous in the Portugal onions, which are largely imported into this country. Other celebrated varieties are those of Spain and Tripoli; but Egypt itself is famed for the production of fine onions, as stated by Hasselquist: 'Whoever has tasted onions in Egypt, must allow that none can be had better in any part of the universe. Here they are sweet; in other countries they are nauseous and strong. Here they are soft; whereas in the northern and other parts they are hard, and their coats are so compact, that they are difficult of digestion. Hence they cannot in any place be eaten with less prejudice and more satisfaction than in Egypt.'...

J. F. R.

BEZEK (בֵּצֶק; Sept. Βεζέκ), a city over which Adoni-bezek was king (*Judg.* i. 4, *sq.*), and where Saul mustered his army to march to the relief of Jabesh-Gilead (1 Sam. xi. 8). Eusebius and Jerome mention two towns of this name close together, seventeen miles from Neapolis in Shechem, on the road to Bethshan.

BEZER (בֵּעֶזֶר; Sept. Βοσρόρ), a city beyond the Jordan, in the tribe of Reuben, and one of the

six cities of refuge (Deut. iv. 43; Josh. xx. 8). The site is unknown.

BEZETHA. [JERUSALEM.]

BIBLE, βιβλία, *libelli* (the small books), a name supposed to have been first applied in the fifth century to denote the collective volume of the sacred writings. The word occurs in the Prologue to Ecclesiasticus, 'the Law, the Prophets, and the rest of the books' (βιβλία), and 2 Tim. iv. 13, 'and the books' (βιβλία). Before the adoption of this name the more usual terms in the Christian Church by which the sacred books were denominated were, the Scripture or writing (γραφή), the Scriptures (γραφαί), the sacred writings (γραφαί ἁγίας), and the sacred letters (ἐπὶ γράμματα). These names are thus frequently applied to the sacred books of the Old Testament by Josephus and Philo, as well as by the writers of the New Testament (2 Pet. i. 20; Matt. xxii. 29; Rom. i. 2; 2 Tim. iii. 15). Jerome substitutes for these expressions the term *Bibliotheca Divina* (see Hieronymi *Opera*, ed. Martianay, vol. i. Proleg.), a phrase which this learned father probably borrowed from 2 Maccabees, ii. 13, where Nehemiah is said, in 'founding a library' (βιβλιοθήκη), to have 'gathered together the acts of the kings, and the prophets, and of David, and the epistles of the kings concerning the holy gifts.' But although it was usual to denominate the separate books in Greek by the term *Biblia*, which is frequently so applied by Josephus, we first find it simply applied to the entire collection by St. Chrysostom in his *Second Homily*, 'The Jews have the books (βιβλία), but we have the treasure of the books; they have the letters (γράμματα), but we have both spirit and letter.' And again *Hom. ix. in Epist. ad Coloss.*, 'Provide yourselves with books (βιβλία), the medicine of the soul, but if you desire no other, at least procure the new (καινή), the Apostolos, the Acts, the Gospels.' He also adds to the word βιβλία the epithet *divine* in his *Tenth Homily on Genesis*: 'Taking before and after meals the divine books' (τὰ θεία βιβλία), or, as we should now express it, the Holy Bible. This name, in the course of time, superseded all others both in the Eastern and Western Church, and is now everywhere the popular appellation. The sacred books were denominated by the Jews the *writing* (chetib or mikra), a name of the same character as that applied by the Mahometans (korawn) to denote their sacred volume.

The Bible is divided into the Old and New Testaments, ἡ παλαιά, καὶ ἡ καινὴ διαθήκη. The name Old Testament is applied to the books of Moses by St. Paul (2 Cor. iii. 14), inasmuch as the former covenant comprised the whole scheme of the Mosaic revelation, and the history of this is contained in them. This phrase, 'book of the covenant,' taken probably from Exod. xxiv. 7; 1 Macc. i. 57 (βιβλίον διαθήκης), was transferred in the course of time by a metonymy to signify the writings themselves. The word διαθήκη, which we now translate *testament*, signifies either a testament or a covenant, but the translators of the old Latin version have by a Grecism always rendered it, even when it was used as a translation of the Hebrew *Berith* (covenant), by the word *Testamentum*. The names given to the Old Testament were, the Scriptures (Matt. xxi. 42), Scripture (2 Pet. i. 20), the Holy Scriptures (Rom. i. 2), the sacred letters (2 Tim. iii. 15),

the holy books (*Sanhed.* xci. 2), the law (John xii. 34), the law, the prophets, and the psalms (Luke xxiv. 44), the law and the prophets (Matt. v. 17), the law, the prophets, and the other books (Prol. Eccclus.), the books of the old covenant (Neh. viii. 8), the book of the covenant (1 Macc. i. 57; 2 Kings xxiii. 2).

The other books (not in the canon) were called apocryphal, ecclesiastical, and deutero-canonical. The term New Testament has been in common use since the third century, and is employed by Eusebius in the same sense in which it is now commonly applied (*Hist. Eccles.* iii. 23). Tertullian employs the same phrase, and also that of 'the Divine Instrument' in the same signification. For detailed information on subjects connected with BIBLE, see SCRIPTURE, HOLY.—W. W.

BIER. [BURIAL.]

BIGHTHAN (בִּיגְתָן), an eunuch in the court of king Ahasuerus, whose conspiracy against that monarch was frustrated through the disclosures of Mordecai (Esth. ii. 21).

BILDAD (בִּלְדָּד; Sept. Βαλδᾶδ), the Shuhite, one of the friends of Job, and the second of his opponents in the disputation (Job ii. 11; viii. 1; xvii. 1; xxv. 1). The Shuah, of which the Septuagint makes Bildad the prince, or patriarch (Βαλδᾶδ ὁ Σαυχέων τύραννος), was probably the district assigned to Shuah, the sixth son of Abraham by Keturah, and called by his name. This was doubtless in Arabia Petraea, if Shuah settled in the same quarter as his brothers, of which there can be little doubt; and to this region we are to refer the town and district to which he gave his name, and in which Bildad was doubtless a person of consequence, if not the chief [SHUAH]. Wemys (*Job and his Times*, p. 111) remarks:—'Bildad attacks the poor sufferer with more keenness than Eliphaz, but with less acerbity than Zophar. He renews the charge which Eliphaz had advanced, but with less eloquence and less delicacy. His second address is full of imagery, and wrought up to a high pitch of terror. He is filled with resentment against Job, merely because the latter defends himself from their criminations; and he uses provoking and taunting expressions. His denunciations are furious and awful; yet he is rather elevated than sublime, and more passionate than energetic.'

BILHAH (בִּלְהָה; Sept. Βαλλά), the handmaid whom the childless Rachel bestowed upon her husband Jacob, that through her she might have children. Bilhah became the mother of Dan and Naphtali (Gen. xxx. 1-8).

BIRD-CAGES are named in Jer. v. 27; Rev. xviii. 2; and are perhaps implied in Job xli. 5, where 'playing with a bird' is mentioned. This just suffices to show that the ancient Israelites kept birds in cages; but we have no further information on the subject, nor any allusions to the sing-

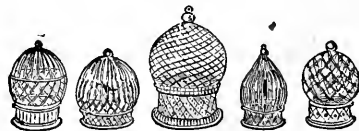

166.

ing of birds so kept. The cages were probably of the same forms which we still observe in the

East, and which are shown in the annexed engraving. It is remarkable that there is no appearance of bird-cages in any of the domestic scenes which are portrayed on the mural tablets of the Egyptians.

BIRD-CATCHING. [FOWLING.]

BIRDS may be defined oviparous vertebrate animals, organized for flight. The common name צִפּוֹר *tsippor* is used of small birds generally, and of the sparrow in particular; חַיִּיפָה *'oph*, translated 'fowl' (Gen. i. 21), properly means flier; אֵיט *ait*, a bird of prey; ΑΕΤΟΣ, *an eagle*; in Gen. xv. 11, Job xxviii. 7, and Isa. xviii. 6, rendered 'fowls;' in Jer. xii. 9, 'bird;' and in Isa. xlvi. 11, and Ezek. xxxix. 4, 'ravenous birds.' בַּרְבָּרִים *barburim* denotes fatted gallinacea; it occurs only in 1 Kings iv. 23, and is there translated 'fowls,' though it may be questioned whether domestic fowls are mentioned in any part of the Hebrew bible [Cock]. Gesenius applies the word to geese.

In the Mosaic law birds were distinguished as clean and unclean: the first being allowed for the table, because they fed on grain, seeds, and vegetables; and the second forbidden, because they subsisted on flesh and carrion. The birds most anciently used in sacrifice were, it seems, turtle-doves and pigeons. In Kitto's *Physical History of Palestine* there is a more complete notice than exists elsewhere of the actual ornithology of the Holy Land.—C. H. S.

BIRDS'-NESTS. The law in Deut. xxii. 6, 7, directs that if one falls in with a bird's-nest with eggs or young, he shall allow the dam to escape, and not take her as well as the nest. The reason Maimonides (*More Nevochim*) gives for this, 'The eggs on which the dam is sitting, or the young ones which have need of her, are not, in general, permitted to be eaten; and when the dam is allowed to escape, she is not distressed by seeing her young ones carried off. It thus frequently happens that all are untouched, because that which might be taken may not be lawfully eaten.' He adds, 'If the law then be thus careful to prevent birds and beasts (for he had been alluding to the instances of this humanity of the law) from suffering pain and grief, how much more mankind!'

BIRTH. In Eastern countries child-birth is usually attended with much less pain and difficulty than in our northern regions; although Oriental females are not to be regarded as exempt from the common doom of woman, 'in sorrow shalt thou bring forth children' (Gen. iii. 16). It is however uncertain whether the difference arise from the effect of climate or from the circumstances attending advanced civilization; perhaps both causes operate, to a certain degree, in producing the effect. Climate must have *some* effect; but it is observed that the difficulty of child-birth, under any climate, increases with the advance of civilization, and that in any climate the class on which the advanced condition of society most operates finds the pangs of child-birth the most severe. Such consideration may probably account for the fact that the Hebrew women, after they had long been under the influence of the Egyptian climate, passed through the child-birth pangs with much more facility than the women of Egypt, whose habits of life were more refined and self-indulgent (Exod. i. 19). There were, however,

already recognised Hebrew midwives while the Israelites were in Egypt; and their office appears to have originated in the habit of calling in some matron of experience in such matters to assist in cases of difficulty. A remarkable circumstance in the transaction which has afforded these illustrations (Exod. i. 16) has been explained under ABNAIM.

The child was no sooner born than it was washed in a bath and rubbed with salt (Ezek. xvi. 4); it was then tightly swathed or bandaged to prevent those distortions to which the tender frame of an infant is so much exposed during the first days of life (Job xxxviii. 9; Ezek. xvi. 4; Luke ii. 7, 11). This custom of bandaging or swathing the new-born infant is general in Eastern countries. It was also a matter of much attention with the Greeks and Romans (see the citations in Wetstein, at Luke ii. 7), and even in our own country was not abandoned till the last century, when the repeated remonstrances of the physicians seem to have led to its discontinuance.

It was the custom at a very ancient period for the father, while music celebrated the event, to clasp the new-born child to his bosom, and by this ceremony he was understood to declare it to be his own (Gen. i. 23; Job. iii. 3; Ps. xxii. 11). This practice was imitated by those wives who adopted the children of their handmaids (Gen. xvi. 2; xxx. 3-5). The messenger who brought to the father the first news that a son was born unto him was received with pleasure and rewarded with presents (Job iii. 3; Jer. xx. 15), as is still the custom in Persia and other Eastern countries. The birth of a daughter was less noticed, the disappointment at its not being a son, subduing for the time the satisfaction which the birth of any child naturally occasions.

Among the Israelites, the mother, after the birth of a son, continued unclean seven days; and she remained at home during the thirty-three days succeeding the seven of uncleanness, forming altogether forty days of seclusion. After the birth of a daughter the number of the days of uncleanness and seclusion at home was doubled. At the expiration of this period she went into the tabernacle or temple, and presented a yearling lamb, or, if she was poor, two turtle doves and two young pigeons, as a sacrifice of purification (Lev. xii. 1-8; Luke ii. 22) [CHILDREN].

BIRTH-DAYS. The observance of birth-days may be traced to a very ancient date; and the birth-day of the first-born son seems in particular to have been celebrated with a degree of festivity proportioned to the joy which the event of his actual birth occasioned (Job i. 4, 13, 18). The birth-days of the Egyptian kings were celebrated with great pomp as early as the time of Joseph (Gen. xl. 20). These days were in Egypt looked upon as holy; no business was done upon them, and all parties indulged in festivities suitable to the occasion. Every Egyptian attached much importance to the day, and even to the hour of his birth; and it is probable that, as in Persia (Herodot. i. 133; Xenoph. *Cyrop.* i. 3. 9), each individual kept his birth-day with great rejoicings, welcoming his friends with all the amusements of society, and a more than usual profusion of delicacies of the table (Wilkinson, v. p. 280). In the Bible there is no instance of birth-day celebrations among the Jews themselves. The example

of Herod the tetrarch (Matt. xiv. 6), the celebration of whose birth-day cost John the Baptist his life, can scarcely be regarded as such, the family to which he belonged being notorious for its adoption of heathen customs. In fact, the later Jews at least regarded birth-day celebrations as parts of idolatrous worship (Lightfoot, *Hor. Hebr. ad Matt.* xiv. 6); and this probably on account of the idolatrous rites with which they were observed in honour of those who were regarded as the patron gods of the day on which the party was born.

BIRTH-RIGHT (בְּכֹרֶת; Sept. πρωτόδικια).

This term denotes the rights or privileges belonging to the first-born among the Hebrews. The particular advantages which these conferred were the following:—

1. A right to the priesthood. The first-born became the priest in virtue of his priority of descent, provided no blemish or defect attached to him. Reuben was the first-born of the twelve patriarchs, and therefore the honour of the priesthood belonged to his tribe. God, however, transferred it from the tribe of Reuben to that of Levi (Num. iii. 12, 13; viii. 18). Hence the first-born of the other tribes were redeemed from serving God as priests, by a sum not exceeding five shekels. Being presented before the Lord in the temple, they were redeemed immediately after the thirtieth day from their birth (Num. xviii. 15, 16; Luke ii. 22). It is to be observed, that only the first-born who were fit for the priesthood (*i. e.* such as had no defect, spot, or blemish) were thus presented to the priest.

2. The first-born received a double portion of his father's property. There is some difficulty in determining precisely what is meant by a double portion. Some suppose that half the inheritance was received by the elder brother, and that the other half was equally divided among the remaining brethren. This is not probable. The Rabbins believe that the elder brother received twice as much as any of the rest; and there is no reason to doubt the correctness of this opinion. When the first-born died before his father's property was divided, and left children, the right of the father descended to the children, and not to the brother next of age.

3. He succeeded to the official authority possessed by his father. If the latter was a king, the former was regarded as his legitimate successor, unless some unusual event or arrangement interfered.

After the law was given through Moses, the right of primogeniture could not be transferred from the first-born to a younger child at the father's option. In the patriarchal age, however, it was in the power of the parent thus to convey it from the eldest to another child (Deut. xxi. 15-17; Gen. xxv. 31, 32).

It is not difficult to perceive the reason why the first-born enjoyed greater privileges than the rest of the children. The peculiar honour attaching to them is easily accounted for. They are to be viewed as having reference to the Redeemer, the first-born of the Virgin. Hence in the epistle to the Romans, viii. 29, it is written concerning the Son, 'that he might be the first-born among many brethren;' and in Coloss. i. 18, 'who is the beginning, the first-born from the dead; that in all things he might have the pre-eminence' (see also Heb. i. 4,

5, 6). As the first born had a double portion, so the Lord Jesus, as Mediator, has an inheritance superior to his brethren; he is exalted to the right hand of the Majesty on high, where he reigns until all his enemies shall be subdued. The universe is his rightful dominion in his mediatorial character. Again, he alone is a true priest: he fulfilled all the functions of the sacerdotal office; and the Levites, to whom, under the law, the priesthood was transferred from all the first-born of Israel, derived the efficacy of their ministrations from their connection with the great high priest (Jahn's *Biblical Archaeology*, § 165).—

S. D

BISHOP. The active controversy in which the subject of episcopacy has been involved, although it has not reconciled conflicting opinions, has brought out the historical facts in their fullest clearness. The able and candid on opposite sides can scarcely be said to differ as to the facts themselves; but they differ in their estimate of them.

The Apostles originally appointed men to superintend the spiritual, and occasionally even the secular wants of the churches (Acts xiv. 23; xi. 30; see also 2 Tim. ii. 2), who were ordinarily called πρεσβύτεροι, *elders*, from their age, sometimes ἐπίσκοποι, *overseers* (bishops), from their office. They are also said προϊστάσθαι, *to preside* (1 Thess. v. 12; 1 Tim. v. 17), never ἄρχειν, *to rule*, which has far too despotic a sound. In the Epistle to the Hebrews (xiii. 7, 17, 24), they are named ἡγούμενοι, *leading men* (comp. Acts xv. 22); and, figuratively, ποιμένες, *shepherds* (Ephes. iv. 11). But that they did not always teach is clear from 1 Tim. v. 17; and the name Elders proves that originally age, experience, and character were their most necessary qualifications. They were to be married men with families (1 Tim. iii. 4), and with converted children (Tit. i. 6). In the beginning there had been no time to train teachers, and teaching was regarded far more in the light of a gift than an office; yet St. Paul places 'ability to teach' among episcopal qualifications (1 Tim. iii. 2; Titus i. 9; the latter of which passages should be translated, 'that he may be able both to exhort men by sound teaching, and also to refute opposers'). That teachers had obtained in St. Paul's day a fixed official position, is manifest from Gal. vi. 6, and 1 Cor. ix. 14, where he claims for them a right to worldly maintenance: in fact, that the *shepherds* ordered to 'feed the flock,' and be its 'overseers' (1 Pet. v. 2), were to feed them with knowledge and instruction, will never be disputed, except to support a hypothesis. The *leaders* also, in Heb. xiii. 7, are described as 'speaking unto you the word of God.' Ecclesiastical history joins in proving that the two offices of teaching and superintending were, with few exceptions, combined in the same persons, as, indeed, the nature of things dictated.

That during St. Paul's lifetime no difference between elders and bishops yet existed in the consciousness of the church, is manifest from the entire absence of distinctive names (Acts xx. 17-28; 1 Pet. v. 1, 2). The mention of bishops and deacons in Phil. i. 1, and 1 Tim. iii., without any notice of elders, proves that at that time no difference of order subsisted between bishops and elders. A formal ceremony, it is generally believed, was employed in appointing elders, al-

though it does not appear that as yet any fixed name was appropriated to the idea of ordination. (The word *ordained* is inexcusably interpolated in the English version of Act i. 22. In Tit. i. 5 the Greek word is *καταστήσῃς, set, or set up*; and in Acts xiv. 23 it is *χειροτονήσαυτες, having elected*, properly, by a show of hands; though, abusively, the term came to mean simply, *having chosen or nominated* (Acts x. 41); yet in 2 Cor. viii. 19, it seems to have its genuine democratic sense). In 1 Cor. xvi. 15 we find the house of Stephanas to have volunteered the task of 'ministering to the saints'; and that this was a ministry of 'the word,' is evident from the Apostle's urging the church 'to submit themselves to such.' It would appear then that a formal investiture into the office was not as yet regarded *essential*. Be this as it may, no one doubts that an ordination by laying on of hands soon became general or universal. Hands were first laid on not to bestow an office, but to solicit a spiritual gift (1 Tim. iv. 14; 2 Tim. i. 6; Acts xiii. 3; xiv. 26; xv. 40). To the same effect Acts viii. 17; xix. 6;— passages which explain Heb. vi. 2. On the other hand, the absolute silence of the Scriptures, even if it were not confirmed, as it is, by positive testimony, would prove that no idea of consecration, as distinct from ordination, at that time existed at all; and, consequently, although individual elders may have really discharged functions which would afterwards have been called episcopal, it was not by virtue of a second ordination, nor, therefore, of episcopal rank.

The Apostles themselves, it is held by some, were the real *bishops* of that day, and it is quite evident that they performed many episcopal functions. It may well be true, that the only reason why no bishops (in the modern sense) were then wanting was, because the Apostles were living; but it cannot be inferred that in any strict sense prelates are *co-ordinate in rank with the Apostles*, and can claim to exercise their powers. The later 'bishop' did not come forward as a successor to the Apostles, but was developed out of the presbyter; much less can it be proved, or alleged with plausibility, that the Apostles took any measures for securing substitutes for themselves (in the high character of Apostles) after their decease. It has been with many a favourite notion that Timothy and Titus exhibit the episcopal type even during the life of Paul; but this is an obvious misconception. They were attached to the person of the Apostle, and not to any one church. In the last Epistle written by him (2 Tim. iv. 9) he calls Timothy suddenly to Rome, in words which prove that the latter was not, at least as yet, bishop, either of Ephesus or of any other church. That Timothy was an *evangelist* is distinctly stated (2 Tim. iv. 5), and that he had received spiritual gifts (i. 6, &c.); there is then no difficulty in accounting for the authority vested in him (1 Tim. v. 1; xix. 22), without imagining him to have been a bishop; which is in fact disproved even by the same Epistle (i. 3). That Titus, moreover, had no local attachment to Crete, is plain from Titus iii. 13, to say nothing of the earlier Epistle, 2 Cor. *passim*. Nor is it true that the episcopal power developed itself out of wandering evangelists any more than out of the Apostles.

On the other hand it would seem that the

bishop began to elevate himself above the presbyter while the Apostle John was yet alive, and in churches to which he is believed to have peculiarly devoted himself. The meaning of the title *angel*, in the opening chapters of the Apocalypse, has been mystically explained by some; but its true meaning is clear from the nomenclature of the Jewish synagogues. In them, we are told, the minister who ordinarily led the prayers of the congregation, besides acting as their chief functionary in matters of business, was entitled *אֱלִיָּהוּ הַצְּבוֹר* [SYNAGOGUE], a name which may be translated literally *nuncius ecclesie*, and is here expressed by the Greek *ἄγγελος*. The substantive *מְלִאכָה* also (which by analogy would be rendered *ἄγγελια*, as *מְלִאכָה* is *ἄγγελος*) has the ordinary sense of *opus, ministerium*, making it almost certain that the 'angels of the churches' are nothing but a harsh Hebraism for 'ministers of the churches.' We therefore here see a single officer, in these rather large Christian communities, elevated into a peculiar prominence, which has been justly regarded as episcopal. Nor does it signify that the authorship of the Apocalypse is disputed, since its extreme antiquity is beyond a doubt; we find, therefore, the germ of episcopacy here planted, as it were, under the eyes of an Apostle. (Neander, *Pflanzung und Leitung*, ii. 468.)

Nevertheless, it was still but a germ. It is vain to ask, whether these angels received a second ordination and had been promoted from the rank of presbyters. That this was the case is possible, but there is no proof of it; and while some will regard the question as deeply interesting, others will think it unimportant. A second question is, whether the angels were overseers of the congregation only, or of the presbyters too; and whether the church was formed of many local unions (such as we call parishes), or of one. Perhaps both questions unduly imply that a set of fixed rules was already in existence. No one who reads Paul's own account of the rebuke he uttered against Peter (Gal. ii.), need doubt that in those days a zealous elder would assume authority over other elders, officially his equals, when he thought they were dishonouring the Gospel; and, *a fortiori*, he would act thus towards an official inferior, even if this had not previously been defined or understood as his duty. So again, the Christians of Ephesus or Miletus were probably too numerous ordinarily to meet in a single assembly, especially before they had large buildings erected for the purpose; and convenience must have led at a very early period to subordinate assemblies (such as would now be called 'chapels-of-ease' to the mother church); yet we have no ground for supposing that any sharp division of the Church into organic portions had yet commenced.

Episcopalians, Presbyterians, and Congregationalists agree in one point, viz. that (because of its utility and general convenience) it is lawful for Christians to take a step for which they have no clear precedent in the Scripture, that of breaking up a church, when it becomes of unwieldy magnitude, into fixed divisions, whether parishes, or congregations. The question then arises, whether the organic union is to be still retained at all. To this (1) Congregationalists reply in the negative, saying that the congrega-

tions in different parts of a great city no more need to be in organic union, than those of two different cities; (2) Presbyterians would keep up the union by means of a synod of the elders; (3) Episcopalians desire to unite the separate churches by retaining them under the supervision of a single head—the bishop. It seems impossible to refer to the practice of the Apostles as deciding in favour of any one of these methods; for the case had not yet arisen which could have led to the discussion. The city churches had not yet become so large as to make subdivision positively necessary; and, as a fact, it did not take place. To organize distant churches into a fixed and formal connection by synods of their bishops, was, of course, quite a later process; but such unions are by no means rejected, even by Congregationalists, as long as they are used for deliberation and advice, not as assemblies for ruling and commanding. The spirit of Episcopacy depends far less on the episcopal form itself, than on the size and wealth of dioceses, and on the union of bishops into synods, whose decisions are to be authoritative on the whole church: to say nothing of territorial establishment and the support of the civil government. If, under any ecclesiastical form, either oppression or disorder should arise, it cannot be defended; but no form is a security against such evils. Our experience may, in these later times, possibly show us which of these systems is on the whole preferable; but the discussion must belong to ecclesiastical history, and would be quite out of place here.—

F. W. N.

BITHRON (2 Sam. ii. 29). This name has the same meaning as Bether. It probably denotes a region of hills and valleys, and not any definite place.

BITHYNIA (Βιθυνία), a province of Asia Minor, on the Euxine Sea and the Propontis; bounded on the west by Mysia, on the south and east by Phrygia and Galatia, and on the east by Paphlagonia. The Bithynians were a rude and uncivilized people, Thracians who had colonized this part of Asia, and occupied no towns, but lived in villages (καμμοροαίς, Strabo, p. 566). That Christian congregations were formed at an early period in Bithynia, is evident from the Apostle Peter having addressed the first of his Epistles to them (1 Pet. i. 1). The Apostle Paul was at one time inclined to go into Bithynia with his assistants Silas and Timothy, 'but the Spirit suffered him not' (Acts xvi. 7).

BITTER, BITTERNESS. Bitterness (Exod. i. 14; Ruth i. 20; Jer. ix. 15) is symbolical of affliction, misery, and servitude. It was for this reason that, in the celebration of the Passover, the servitude of the Israelites in Egypt was typically represented by bitter herbs.

On the day of bitterness in Amos viii. 10, comp. Tibullus, ii. 4. 11—

'Nunc et amara dies, et noctis amarior umbra est.' In Habakk. i. 6 the Chaldeans are called 'that bitter and swift nation;' which Schultens illustrates by remarking that the root *Merer* in Arabic (answering to the Hebrew word for bitter) is usually applied to strength and courage.

The gail of bitterness (Acts viii. 23) describes a state of extreme wickedness, highly offensive to God, and hurtful to others.

A root of bitterness (Heb. xiii. 15) expresses

a wicked or scandalous person, or any dangerous sin leading to apostasy (Wemyss's *Clavis Symbolica*, &c.).

BITTER HERBS (בִּרְיָרִים; literally *bitters*; Sept. *πικριδες*; Vulg. *lactucee agrastes*). There has been much difference of opinion respecting the kind of herbs denoted by this word. On this subject the reader may consult Carpov, *Apparat.* p. 404, sq.

It however seems very doubtful whether any particular herbs were intended by so general a term as *bitters*; it is far more probable that it denotes whatever bitter herbs, obtainable in the place where the Passover was eaten, might be fitly used with meat. This seems to be established by the fact that the first directions respecting the Passover were given in Egypt, where also the first Passover was celebrated; and as the esculent vegetables of Egypt are very different from those of Palestine, it is obvious that the bitter herbs used in the first celebration could scarcely have been the same as those which were afterwards employed for the same purpose in Canaan. According to the Mishna (*Pesachim*, ii. 6), and the commentators thereon, there were five sorts of bitter herbs, any one or all of which might be used on this occasion. There were—1. חֲזַרֶת חֹרֶת *chazereth*, supposed to be wild lettuce, which the Septuagint and Vulgate make stand for the whole. 2. עוֹלֵשִׁין *'ulshin*, endives; or, according to some, wild endives. 3. תַּמְכָּה *thamca*, which some make the garden endive, others horehound, others tansy, others the green tops of the horse-raddish, while, according to De Pomis, in *Zemach David*, it is no other than a species of thistle (*carduus marianum*). 4. חֲרַחְבִּינָה *charchabina*, supposed to be a kind of nettle. 5. מָרוֹר *maror*, which takes its name from its bitterness, and is alleged by the Mishnic commentators to be a species of the most bitter coriander. All these might, according to the Mishna, be taken either fresh or dried; but not pickled, boiled, or cooked in any way.

BITTERN. [KIPPOD.]

BITUMEN. [ASPHALTUM.]

BLACK. Although the Orientals do not wear black in mourning, they, as did the ancient Jews, regard the colour as a symbol of affliction, disaster, and privation. In fact, the custom of wearing black in mourning is a sort of visible expression of what is in the East a figure of speech. In Scripture blackness is used as symbolical of afflictions occasioned by drought and famine (Job xxx. 30; Jer. xiv. 2; Lam. iv. 8; v. 10). Whether this be founded on any notion that the hue of the complexion was deepened by privation, has not been ascertained; but it has been remarked by Chardin and others, that in the periodical mourning of the Persians for Hossein many of those who take part in the ceremonies appear with their bodies blackened, in order to express the extremity of thirst and heat which Hossein suffered, and which, as is alleged, was so great that he turned black, and the tongue swelled till it protruded from his mouth.

In Mal. iii. 14 we read, 'What profit is it that we keep his ordinances, and that we have walked in blackness (Authorized Version 'mournfully') before the Lord of Hosts;' meaning that they had fasted in sackcloth and ashes. 'Black occurs as a symbol of fear in Joel ii. 6.—'Ah

faces shall gather blackness,' or *darken* with apprehension and distress. This use of the word may be paralleled from Virgil, *Æn.* ix. 719, 'Atrunque timorem;' and *Georg.* iv. 468, 'Caligantem nigra formidine lucum.'

The same expression which Joel uses is employed by Nahum (ii. 10) to denote the extremity of pain and sorrow.

In connection with this subject it may be remarked that black is studiously avoided in dress by all Orientals, except in certain garments of hair or wool, which are naturally of that colour. Black is also sometimes imposed as a mark of humiliating distinction by dominant nations upon subject or tributary tribes, the most familiar instance of which is the obligation laid upon the Jews in Turkey of wearing black turbans.

BLAINS. The word בַּלְאִים, which, in the only places where it occurs, is in our version rendered *blains*, strictly means *eruptions*. The roots בַּלַּע and בָּלַע, which are the cognate forms of the root from which the word is derived, have the primary sense of ebullience and efflorescence; and the specific kind of eruption here intended cannot, on account of the vague term by which it is described, be determined with any accuracy. The Septuagint renders it by φλυκτίδες, which is also a general term for pustules and vesicles [**DISEASES**].—J. N.

BLASPHEMY (בְּלִשְׁׁנָה לַעֲרֹב הָעָם; Sept. βλασφημία). The Greek word βλασφημία is *generic*, denoting verbal abuse proceeding from an evil disposition. It is equivalent to *defamation* or *slander*, involving an attempt to lessen the character of others, with the intention of doing them injury. All kinds of abusive language, whether called *imprecation*, *calumny*, or *reviling*, come under the term.

The English word *blasphemy* is more restricted in its signification. It refers to God only. In like manner when βλασφημία is directed against the Supreme Being, or when Jehovah is the object of it, it is specific. In these circumstances it corresponds to the English *blasphemy*. The Greek βλασφημία is employed in reference to the defamation of men or angels equally with the Deity; but it is proper to use the term *blasphemy* only when God is spoken against. Thus the Greek and English words are not coextensive in import.

Our English translators have not adhered to the right use of the term. They employ it with the same latitude as the Greek; but it is generally easy to perceive, from the connection and subject of a passage, whether *blasphemy*, properly so called, be meant, or only defamation. It would certainly have been better to have employed *detraction* or *calumny* rather than *blasphemy* where man is the object; reserving the latter for that peculiarly awful slander which is directed against the ever-blessed God.

Blasphemy signifies a false, irreverent, injurious use of God's names, attributes, words, and works. Whenever men *intentionally* and *directly* attack the perfections of Jehovah, and thus lessen the reverence which others entertain for him, they are *blasphemers*. If the abusive language proceed from ignorance, or if it be dishonouring to the majesty of Heaven only in the consequences

deduced from it by others, *blasphemy* has no existence. It is *wilful* calumny directed against the name or providence of God that alone constitutes the crime denoted by the term.

Examples of the general acceptance of βλασφημία in the New Testament are common, where the objects of it are men, angels, or the devil, as in Acts xiii. 45; xviii. 6; Jude 9. The restricted sense is found in such passages as Luke v. 21; John x. 36.

By the Mosaic law *blasphemy* was punished with death (Lev. xxiv. 10-16); and the laws of some countries still visit it with the same punishment. Fines, imprisonment, and various corporal inflictions are annexed to the crime by the laws of Great Britain. It is matter, however, of sincere satisfaction, that there are very few instances in which these enactments require to be enforced.

Much has been said and written respecting *the blasphemy* against the Holy Ghost, usually but improperly denominated *the unpardonable sin* against the Holy Ghost. Some refer it to continued opposition to the Gospel, *i. e.* obstinate impenitence or final unbelief. In this view it is unpardonable, not because the blood of Christ is unable to cleanse from such a sin, nor because there is anything in its own nature which separates it from all other sins and places it beyond forgiveness, but because, as long as man continues to disbelieve, he voluntarily shuts himself out from the forgiving mercy of God. By not receiving the Gospel, he refuses pardon. In the same manner, *every* sin might be styled unpardonable, as long as an individual continues to indulge in it.

But we object to this opinion, because it generalizes the nature of the sin in question. On the contrary, the Scripture account narrows it to a particular sin of a special kind, discountenancing the idea that it is of frequent occurrence and marked by no circumstances of unwonted aggravation. Besides, all the notices which we have refer it not so much to a state of mind, as to the outward manifestation of a singularly malignant disposition *by the utterance of the lips*.

The occasion on which Christ introduced his mention of it (Matt. xii. 31, &c.; Mark iii. 28, &c.), the subsequent context, and, above all, the words of Mark iii. 30 ('because they said, He hath an unclean spirit') indicate, with tolerable plainness, that the sin in question consisted in attributing the miracles wrought by Christ, or his apostles in His name, to the agency of Satan. It was by the power of the Holy Ghost, given to the Redeemer without measure, that he cast out devils; and whoever maligned the Saviour, by affirming that an unclean spirit actuated and enabled him to expel other spirits, maligned the Holy Ghost.

There is no connection between the description given in the Epistle to the Hebrews, vi. 4-6, and this unpardonable blasphemy. The passages in the Gospels which speak of the latter are not parallel with that in the Epistle to the Hebrews: there is a marked difference between the states of mind and their manifestations as described in both. The sins ought not to be identified: they are altogether dissimilar.

It is difficult to discover the 'sin unto death,' noticed by the apostle John (1 John v. 16), although it has been generally thought to coincide

with the blasphemy against the Holy Spirit; but the language of John does not afford data for pronouncing them one and the same. The first three gospels alone describe the *blasphemy* which shall not be forgiven: from it the 'sin unto death' stands apart (See Lücke's *Commentar über die Briefe des Evangelisten Johannes*, Zweyte Auflage, pp. 305-317; Campbell's *Preliminary Dissertations to the Gospels*, Dissertat. ix. part ii.; Olshausen's *Commentar*, Dritte Auflage, pp. 306-7).—S. D.

BLASTUS (Βλάστος), a man who was *cubicularius* to king Herod Agrippa, or who had the charge of his bed-chamber (Acts xii. 20). Such persons had usually great influence with their masters, and hence the importance attached to Blastus's favouring the peace with Tyre and Sidon.

BLEMISHES. There were various kinds of blemishes, *i. e.* imperfections or deformities, which excluded men from the priesthood, and animals from being offered in sacrifice. These blemishes are described in Lev. xxi. 17-23; xxii. 19-25; Deut. xv. 21. We learn from the Mishna (*Zebachim*, xii. 1; *Becoroth*, vii. 1), that temporary blemishes excluded a man from the priesthood only as long as those blemishes continued. The rule concerning animals was extended to imperfections of the inward parts: thus if an animal, free from outward blemish, was found, after being slain, internally defective, it was not offered in sacrifice. The natural feeling that only that which was in a perfect condition was fit for sacred purposes, or was a becoming offering to the gods, produced similar rules concerning blemishes among the heathen nations (Conf. Pompon. Læt. *De Sacerdot.* cap. 6; Herodot. ii. 38; *Iliad*, i. 66; Servius *ad Virg. Æn.* ii. 4).

BLESSING. The terms 'blessing' and 'to bless' occur very often in the Scriptures, and in applications too obvious to require explanation or comment. The patriarchal blessings of sons form the exception, these being, in fact, prophecies rather than blessings, or blessings only in so far as they for the most part involved the invocation and the promise of good things to come upon the parties concerned. It has been thought by many, in all nations, that the departing soul has unusual keenness of perception with respect to the past and the future, and in a particular manner receives strong inspirations of things to come. How far this may be generally true no one can with certainty affirm or deny. But that a faculty of this sort existed in the leading members of the chosen family of Abraham is beyond all question. The most remarkable instances are those of Isaac 'blessing' Jacob and Esau (Gen. xxvii.); of Jacob 'blessing' his twelve sons (Gen. xlix.); and of Moses 'blessing' the twelve tribes (Deut. xxxiii.). On the first of these transactions Professor George Bush remarks—'It cannot be doubted that from such a father as Isaac a common blessing was to be expected on all his children; but in this family there was a peculiar blessing pertaining to the first-born—a solemn, extraordinary, prophetic benediction, entailing the covenant blessing of Abraham, with all the promises temporal and spiritual belonging to it, and by which his posterity were to be distinguished as God's peculiar people' (*Notes on Genesis*). This was the blessing which Isaac intended to bestow upon his

first-born Esau, but which was secured for Jacob.

With regard to the blessing bestowed by Jacob upon his twelve sons, the same author prefaces his valuable commentary thereon with these remarks—'1. That the blessings or *announcements* have respect mainly to the *posterity* and not to the *persons* of the twelve sons of Jacob; 2. That consequently, the materials of a just interpretation are to be sought in the subsequent history of these tribes. It is only from the documents furnished in the sacred record that the leading characteristic traits and the most important events related of each tribe can be determined; 3. That the fulfilment of these blessings is to be traced not in any one event or in any single period of time, but in a continuous and progressive series of accomplishments, reaching down to the latest era of the Jewish polity; 4. That the peculiar phraseology in which the blessings are couched has in most cases a verbal allusion to the names bestowed upon the twelve phylarchs, or princes of tribes—a circumstance not, indeed, obvious to the English reader, but palpable to one who consults the original.' Most of these latter observations apply equally to the blessing pronounced by Moses, which is in fact a magnificent prophetic poem, characterized by the finest attributes of the class of Hebrew poetry to which it belongs.

BLESSING, VALLEY OF (בְּרַכָּה עֵינֶק, Sept. Κοιλάς Εὐλογίας), a translation of the name Valley of Berachah (benediction), which was borne by the valley in which Jehoshaphat celebrated the miraculous overthrow of the Moabites and Ammonites. It was from this circumstance it derived its name; and from the indications in the text, it must have been in the tribe of Judah, near the Dead Sea and Engedi, and in the neighbourhood of Tekoa (2 Chron. xx. 23-26).

BLINDING. [PUNISHMENTS.]

BLINDNESS. The frequent occurrence of blindness in the East has always excited the astonishment of travellers. Volney says that, out of a hundred persons in Cairo, he has met twenty quite blind, ten wanting one eye, and twenty others having their eyes red, purulent, or blemished (*Travels in Egypt*, i. 221). This is principally owing to the Egyptian ophthalmia, which is endemic in that country and on the coast of Syria. This disease commences with such a violent inflammation of the conjunctiva, that, in a few hours, the whole of that membrane, which lines the anterior surface of the eye and the internal surface of the eyelids, is covered with red fleshy elevations, resembling granulations, and secreting a purulent discharge. The inflammation spreads rapidly over the eyeball; the delicate internal tissues are destroyed and converted into pus; the outer coats ulcerate through; and the whole contents of the eye are evacuated. In its acute and most virulent form, the disease runs its course in 3-7 days; otherwise it may continue for as many weeks or months. It is to be ascribed to those peculiar conditions of the atmosphere which are termed miasmatic, of which, however, nothing is known, except that they exert a specific influence on the body, different from the ordinary effects of cold and damp. The variety of causes assigned by travellers for this disease, such as the suspension of fine dust and saline particles in the

atmosphere, the custom so prevalent amongst the inhabitants of all Eastern countries of sleeping on the roofs of the houses, southerly winds, bad diet, shaving the head, &c., can only be regarded as secondary or occasional causes; and amongst these bad diet, great fatigue, and exposure to the night dews are the most important. The Egyptian ophthalmia is contagious; but it is not often communicated from one individual to another. It is not confined to the East, but appears here and there throughout Europe; and during the last war, probably on account of the practice of bivouacking in the open air, and the great hardships to which the troops were often exposed, it was a dreadful scourge to most of the European armies, more particularly to the Prussians during the campaigns of 1813 and 1814, although that army had never left Europe (Jungken's *Augenkrank.* p. 336). The French and English suffered greatly from it while they were in Egypt, and subsequently.

Small-pox is another great cause of blindness in the East (Volney, *l. c.*).

In the New Testament, blind mendicants are frequently mentioned (Matt. ix. 27; xii. 22; xx. 30; xxi. 14; John v. 3). The blindness of Bar Jesus (Acts xiii. 6) was miraculously produced, and of its nature we know nothing. Winer (*s. v. Blindheit*) infers that it was occasioned by specks on the cornea, which were curable, because the same term, ἀχλὺς, is made use of by Hippocrates (Προϋρητικόν, ii. 215, ed. Kühn), who says that ἀχλὺς will disappear, provided no wound has been inflicted. Before such an inference can be drawn, we must be sure that the writers of the New Testament were not only acquainted with the writings of Hippocrates, but were also accustomed to a strict medical terminology. The haziness implied by the expression ἀχλὺς may refer to the sensation of the blind person, or to the appearance of the eye, and, in both cases, the cause of the haziness may have been referrible to any of the other transparent media, as well as to the cornea. Tobit's blindness (Tobit ii. 10) was attributed to sparrows' dung having fallen into his eyes. If the story be considered true (which we are by no means required to believe), his cure must be regarded as altogether miraculous. Though the gall of a fish was an old remedy for diseases of the eyes (Plin. *Hist. Nat.* xxxii. 24), and has been frequently used in modern times (Richter, *Anfangsgr. d. Wunderarzneik.* iii. p. 130), it cannot be supposed to have had any medicinal effect in Tobit's case; and for not only was the cure instantaneous, but the specks which impeded vision were seen to escape from the corners of his eyes; which plainly shows that the whole process, if not the disease itself, was of a kind which does not fall under the province of science [MEDICINE]. Examples of blindness from old age occur in Gen. xxvii. 1; 1 Kings xiv. 4; 1 Sam. iv. 15. The Syrian army that came to apprehend Elisha was suddenly smitten with blindness in a miraculous manner (2 Kings vi. 18); and so also was St. Paul (Acts ix. 9). The Mosaic law has not neglected to acculate humane feelings towards the blind (Lev. xix. 14; Deut. xxvii. 18). Blindness is sometimes threatened in the Old Testament as a punishment for disobedience (Deut. xxviii. 28; Lev. xxvi. 16; Zeph. i. 17).—W. A. N.

BLOOD. There are two respects in which the

ordinances of the Old and New Testaments concerning blood deserve notice here—the prohibition of its use as an article of food, and the appointment and significance of its use in the ritual of sacrifice; both of which appear to rest on a common ground.

In Gen. ix. 4, where the use of animal food is allowed, it is first absolutely forbidden to eat 'flesh with its soul, its blood;' which expression, were it otherwise obscure, is explained by the mode in which the same terms are employed in Deut. xii. 23. In the Mosaic law the prohibition is repeated with frequency and emphasis; although it is generally introduced in connection with sacrifices, as in Lev. iii. 7; vii. 26 (in both which places blood is coupled in the prohibition with the *fat* of the victims); xvii. 10-14; xix. 2; Deut. xii. 16-23; xv. 23. In cases where the prohibition is introduced in connection with the lawful and unlawful articles of diet, the reason which is generally assigned in the text is, that 'the blood is the soul,' and it is ordered that it be poured on the ground like water. But where it is introduced in reference to the portions of the victim which were to be offered to the Lord, then the text, in addition to the former reason, insists that 'the blood expiates by the soul' (Lev. xvii. 11, 12).^{*} This strict injunction not only applied to the Israelites, but even to the strangers residing among them. The penalty assigned to its transgression was the being 'cut off from the people;' by which the punishment of death appears to be intended (cf. Heb. x. 28), although it is difficult to ascertain whether it was inflicted by the sword or by stoning. It is observed by Michaelis (*Mos. Recht.* iv. 45) that the blood of *fishes* does not appear to be interdicted. The words in Lev. vii. 26 only expressly mention that of birds and cattle. This accords, however, with the reasons assigned for the prohibition of blood, so far as fishes could not be offered to the Lord; although they formed a significant offering in heathen religions. To this is to be added, that the Apostles and elders, assembled in council at Jerusalem, when desirous of settling the extent to which the ceremonial observances were binding upon the converts to Christianity, renewed the injunction to abstain from blood, and coupled it with things offered to idols (Acts xv. 29). It is perhaps worthy of notice here, that Mohammed, while professing to abrogate some of the dietary restrictions of the Jewish law (which he asserts were imposed on account of the sins of the Jews, Sura iv. 158), still enforces, among others, abstinence from blood and from things offered to idols (*Qurán*, Sur. v. 4, vi. 146, ed. Flügel).

In direct opposition to this emphatic prohibition of blood in the Mosaic law, the customs of uncivilized heathens sanctioned the cutting of slices from the living animal, and the eating of the flesh while quivering with life and dripping with blood. Even Saul's army committed this barbarity, as we

^{*} We can only for brevity refer the reader to Bähr's *Symbolik*, ii. 207, for the philological reasons for this rendering. He there shows that שׂוֹבֵב, which is generally rendered as the mere *object* of the verb, must, instead, be the instrument; so that the sense is, in that the soul is in the blood, therefore the blood atones; or, the blood atones by means of the soul, *its* soul.

read in 1 Sam. xiv. 32; and the prophet also lays it to the charge of the Jews in Ezek. xxxiii. 25.* This practice, according to Bruce's testimony, exists at present among the Abyssinians. Moreover, pagan religions, and that of the Phœnicians among the rest, appointed the eating and drinking of blood, mixed with wine, as a rite of idolatrous worship, and especially in the ceremonial of swearing. To this the passage in Ps. xvi. 4 appears to allude (cf. J. D. Michaelis, *Critisch. Colleg.* p. 108, where several testimonies on this subject are collected).

The appointment and significance of the use of blood in the ritual of sacrifice belongs indeed to this head; but their further notice will be more appropriately pursued in the art. SACRIFICE.—

J. N.

BLOOD AND WATER (John xix. 34) are said to have issued from our Lord's side when the soldier pierced him on the cross. The only natural explanation that can be offered of the fact is to suppose that some effusion had taken place in the cavity of the chest, and that the spear penetrated below the level of the fluid. Supposing this to have happened, and the wound to have been inflicted shortly after death, then, in addition to the water, blood would also have trickled down, or, at any rate, have made its appearance at the mouth of the wound, even though none of the large vessels had been wounded. It is not necessary to suppose that the pericardium was pierced; for, if effusion had taken place there, it might also have taken place in the cavities of the pleura; and, during health, neither the pericardium nor the pleura contains fluid, but are merely lubricated with moisture on their internal or opposing surfaces, so as to allow of free motion to the heart and lungs.

It may be objected to this view of the question, that, according to the longest computation, our Lord died in six hours, and that this is too short a time to occasion effusion. Indeed, reasoning from experience alone, it is very difficult to understand the *physical* cause of our Lord's death. The crucifixion is quite inadequate to account for it; for, even if the impression produced by this torture on a weak nervous system was sufficient to annihilate consciousness and sensibility, the death of the body, or what physiologists have termed *organic* death, could not have taken place in so short a time, as long as the brain, lungs, and circulation, the so-called *atria mortis*, had sustained no material injury. In other words, the functions of respiration, circulation, secretion, and nutrition must have continued for a far longer time. In fact, we learn from Eusebius (*Hist. Eccles.* viii. 8) that many of the Egyptian martyrs perished from hunger on the cross, al-

though they were crucified with their heads downwards. According to Richter, some survive on the cross for three, four, and even for *nine* days (Winer's *Bibl. Realwört.* s. v. *Jesus*). Our Lord's death could not have been occasioned by tetanus, or else it would have been mentioned; and even this disease, though the sufferer be racked with the most frightful convulsions without intermission, most rarely puts an end to life in less than twelve hours. Nor can we attribute it to the wound inflicted by the soldier; for, although, when it is said he 'expired, and the soldiers saw that he was dead,' our Lord might have merely fainted, yet it is impossible to suppose that the soldier would not have perceived his error the moment he inflicted the wound, provided it was mortal; for then would have commenced the death-struggle, which, in cases of death by asphyxia and hæmorrhage, is very severe, and would have struck the most careless spectator.

Schuster (in Eichhorn's *Bibl. Biblioth.* ix. 1038) is of opinion that, as blood is known to separate into a red coagulum and a watery fluid, the expression 'blood and water' is to be understood as an *endiadma*, meaning nothing more than blood. To this it must be objected that blood is only observed to separate in that way when it is allowed to coagulate in a vessel, and that therefore the opportunities for observing it must have been a great deal too rare to allow of such figurative language being employed and understood. That it certainly was not so understood is clear; for some of the fathers (Orig. *Contr. Cels.* ii. 82) interpreted the expression literally, and looked upon the fact as a miracle, and a proof of our Lord's divine nature. According to Strauss (*Leben Jesu*, ii. 571), the evangelist recollected that dead blood separates in the manner just mentioned, and, as he wished to bring forward the strongest proof of our Lord's death, he asserted that blood and water issued from the wound, meaning thereby that our Lord's blood had already undergone that change which is only observed when it is removed from the body and deprived of its vitality. This hypothesis is wholly untenable; for, if we suppose the evangelist so well acquainted with the separation of blood, he would have known that the coagulum, which, according to the hypothesis, is designated by the term *blood*, could not, on account of its solidity, have issued from the wound. Moreover, St. John must have known, what every one knows, that the fact of no blood at all being seen would have been a far better proof of our Lord's death. Indeed, the appearance of blood and water could not have been regarded as a proof of death, but rather as something wonderful and inexplicable; for the words of Origen, τῶν ἀλλῶν νεκρῶν σωματῶν τὸ αἷμα πηγνυται, καὶ ὕδωρ καθαρὸν οὐκ ἀποβρεῖ (*l. c.*), express a fact which every one in those days must have known from personal experience. St. John then must have entirely failed in his object, and merely from his ignorance of the most vulgar opinions.

It has been asserted by some (as by Winer) that, when deep incisions are made in the body after death, the blood will be found separated into cruor and serum. This is incorrect. Even in the heart and large vessels the serum cannot be distinguished, because it readily transudes, and is imbibed by the surrounding tissues. In many

* The use of the preposition *על* in this passage has been entirely misunderstood by Spencer, who (*De Leg. Hebr.* ii. 11) adduces much testimony from profane sources for the existence of the rite of feasting *over* the blood of the victim. Nevertheless, that this preposition also has the sense of *with*, in addition to, *insuper*, is established by Gen. xxxii. 12; Exod. xii. 9 (Ewald's *Hebr. Gram.* § 524); as well as by the recurrence of the whole phrase in 1 Sam. xiv. 32. Deyling has refuted Spencer in a special dissertation (*Observ. Sacr.* ii. 25).

cases coagulation takes place very imperfectly after death.

It must not be supposed that the fact of blood coming from the wound at all militates against the idea that our Lord was dead at the moment he was pierced. This argument is, indeed, made use of by Strauss (*l. c.*); but it can be refuted by the most ordinary experience. It is well known that, even many days after death, blood will trickle from deep incisions, especially where any of the large veins have been wounded. The popular opinion that blood will not flow from a corpse, must be taken in a relative, and not absolute sense. It certainly will not flow as it does from a living body; and, when the wound is small and superficial, sometimes not a drop will be seen.

The three other evangelists do not mention the circumstance.—W. A. N.

BLOOD, ISSUE OF (Matt. ix. 20). The disease here alluded to is hæmorrhagia; but we are not obliged to suppose that it continued unceasingly for twelve years. It is a universal custom, in speaking of the duration of a chronic disease, to include the intervals of comparative health that may occur during its course; so that when a disease is merely stated to have lasted a certain time, we have still to learn whether it was of a strictly continuous type, or whether it intermitted. In the present case, as this point is left undecided, we are quite at liberty to suppose that the disease did intermit; and can therefore understand why it did not prove fatal even in twelve years.

Bartholinus (*De Morb. Bibl.* p. 61) quotes a case in which hæmorrhage is said to have occurred for upwards of two years without cessation; but the details necessary to render such an extraordinary case credible are not given.—

W. A. N.

BLOOD-REVENGE, or revenge for bloodshed, was regarded among the Jews, as among all the ancient and Asiatic nations, not only as a right, but even as a duty, which devolved upon the nearest relative of the murdered person, who on this account was called **גֹּאֵל הַדָּם** (*go'el hädäm*), the *reclaimer of blood*, or one who demands restitution of blood, similar to the Latin *sanguinem repetere*.

The Mosaic law (Num. xxxv. 31) expressly forbids the acceptance of a ransom for the forfeited life of the murderer, although it might be saved by his seeking an asylum at the altar of the Tabernacle, in case the homicide was accidentally committed (Exod. xxi. 13; 1 Kings i. 50; ii. 28). When, however, in process of time, after Judaism had been fully developed, no other sanctuary was tolerated but that of the Temple at Jerusalem, the chances of escape of such an homicide from the hands of the avenger, ere he reached the gates of the Temple, became less in proportion to the distance of the spot where the murder was committed from Jerusalem, six *cities of refuge* (**עֲרֵי מִקְלוֹט** *oreh miklot*) were in consequence appointed for the momentary safety of the murderer, in various parts of the kingdom, the roads to which were kept in good order to facilitate his escape (Deut. xix. 3). Thither the avenger durst not follow him, and there he lived in safety until a proper examination had taken

place before the authorities of the place (Jos. xx. 6, 9), in order to ascertain whether the murder was a wilful act or not. In the former case he was instantly delivered up to the *Go'el*, against whom not even the altar could protect him (Exod. xxi. 14; 1 Kings ii. 29); in the latter case, though he was not actually delivered into the hands of the *Go'el*, he was notwithstanding not allowed to quit the precincts of the town, but was obliged to remain there all his lifetime, or until the death of the high-priest (Num. xxxv. 6; Deut. xix. 3; Josh. xx. 1-6), if he would not run the risk of falling into the hands of the avenger, and be slain by him with impunity (Num. xxxv. 26; Deut. xix. 6). That such a voluntary exile was considered more in the light of a punishment for manslaughter than a provision for the safe retreat of the homicide against the revengeful designs of the **גֹּאֵל**, is evident from Num. xxxv. 32, where it is expressly forbidden to release him from his confinement on any condition whatever. That the decease of the high-priest should have been the means of restoring him to liberty was probably owing to the general custom among the ancients, of granting free pardon to certain prisoners at the demise of their legitimate prince or sovereign, whom the high-priest represented, in a spiritual sense, among the Jews. These wise regulations of the Mosaic law, as far as the spirit of the age allowed it, prevented all family hatred, persecution, and war from ever taking place, as was inevitably the case among the other nations, where any bloodshed whatever, whether wilful or accidental, laid the homicide open to the *duteous* revenge of the relatives and family of the slain person, who again in their turn were then similarly watched and hunted by the opposite party, until a family-war of extermination had *legally* settled itself from generation to generation, without the least prospect of ever being brought to a peaceful termination. Nor do we indeed find in the Scriptures the least trace of any abuse or mischief ever having arisen from these regulations (comp. 2 Sam. ii. 19, *sq.*, iii. 26, *sq.*).

That such institutions are altogether at variance with the spirit of Christianity may be judged from the fact that revenge, so far from being counted a right or duty, was condemned by Christ and his apostles as a vice and passion to be shunned (Acts vii. 60; Matt. v. 41; Luke vi. 28; Rom. xii. 14, *sq.*; comp. Rom. xiii., where the power of executing revenge is vested in the authorities alone).

Of all the other nations, the Greeks and Romans alone seem to have possessed such *cities of refuge* (Serv. *ad Æn.* viii. 342; Liv. i. 8; Tac. *Ann.* iii. 60), of which Daphne, near Antioch, seems to have been one of the most prominent (2 Macc. iv. 34; comp. Potter's *Greek Archæol.* i. 480), and to have served as a refuge even for wilful murderers. The laws and customs of the ancient Greeks in cases of murder may be gathered from the principle laid down by Plato on that head (*De Legib.* ix. in t. ix. p. 28, *sq.*): 'Since, according to tradition, the murdered person is greatly incited against the murderer during the first few months after the perpetration of the deed, the murderer ought therefore to inflict a punishment upon himself, by exiling himself from his country for a whole year,

and if the murdered be a foreigner, by keeping away from his country. If the homicide subjects himself to such a punishment, it is but fair that the nearest relative should be appeased and grant pardon; but in case he does not submit to that punishment, or dares even to enter the temple while the guilt of blood is still upon his hands, the avenger shall arraign him before the bar of justice, where he is to be punished with the infliction of a double fine. But in case the avenger neglects to proceed against him, the guilt passes over to him (the avenger), and any one may take him before the judge, who passes on him the sentence of banishment for five years.'

The high estimation in which *blood-revenge* stood among the ancient Arabs may be judged of from the fact that it formed the subject of their most beautiful and elevated poetry (comp. the *Scholiast. Taurizi* to the 16th poem in Schulten's *Excerpt. Hamas*). Mahomet did not abolish, but modify, that rigorous custom, by allowing the acceptance of a ransom in money for the forfeited life of the murderer (*Koran*, ii. 173-175), and at the worst, forbidding the infliction of any cruel or painful death (*Ibid.* xvii. 35).

In Europe the custom of blood-revenge is still prevalent in Corsica and Sardinia, where, however, it is more the consequence of a vindictive character than of an established law or custom. A Corsican never passes over an insult without retaliation, either on the offender or his family, and this cruel and un-Christian custom (*vendetta traversa*, mutual vengeance) is the source of many assassinations. The celebrated General Paoli did his best to eradicate this abominable practice, but his dominion was of too short duration for the effective cure of the evil, which has gained ground ever since the first French revolution, even among the female sex. It is calculated that about four hundred persons yearly lose their lives in Sardinia by this atrocious habit (Simonot, *Lettres sur la Corse*, p. 314).—E. M.

BLOODY SWEAT. According to Luke xxii. 44, our Lord's sweat was 'as great drops of blood falling to the ground.' Michaelis takes the passage to mean nothing more than that the drops were as large as falling drops of blood (*Anmerk. für Ungelehrte*, ad loc.). This, which also appears to be a common explanation, is liable to some objection. For, if an ordinary observer compares a fluid which he is accustomed to see colourless, to blood, which is so well known and so well characterized by its colour, and does not specify any particular point of resemblance, he would more naturally be understood to allude to the colour, since it is the most prominent and characteristic quality.

There are several cases recorded by the older medical writers, under the title of bloody sweat. With the exception of one or two instances, not above suspicion of fraud, they have, however, all been cases of general hæmorrhagic disease, in which blood has flowed from different parts of the body, such as the nose, eyes, ears, lungs, stomach, and bowels, and, lastly, from various parts of the skin. When blood oozes from the skin, it must reach the external surface through orifices in the epidermis, which have been produced by rupture, or, we must suppose that it has been extravasated into the sweat-ducts. But, even in this latter case, we must no more consider hæmorrhage of

the skin to be a modification of the function of sweating, than bleeding from the nose to be a modification of the secretion of mucus. The blood is simply mixed with the sweat, precisely in the same way as, when spit up from the lungs, it is mixed with mucus and saliva in passing through the air-tubes and mouth. It is, therefore, incorrect to suppose that hæmorrhage from the skin indicates a state of body at all analogous to that which occasions sweating. If this distinction had been clearly understood, and clearly stated by medical writers, it would have been seen at once how far their experience went to illustrate the case before us.

The greater number of cases described by authors were observed in women and children, and sometimes in infants. Mental anxiety we have only found mentioned as a cause or as a concomitant symptom, in one case, which will be noticed below. The case of a young lady who was afflicted with cutaneous hæmorrhage is detailed by Mesaportiti in a letter to Valisneri. She is noticed to have been cheerful, although she must have suffered greatly from debility and febrile symptoms (*Phil. Trans.* No. 303, p. 2114). The case of an infant, only three months old, affected with the same disease, is related by Du Gard (*Phil. Trans.* No. 109, p. 193). A similar case is described in the *Nov. Act. Acad. Nat. Cur.* tom. iv. p. 193. See also *Eph. Acad. Nat. Cur.* obs. 41; and, for other references, Copeland's *Dict. of Med.* ii. p. 72. Where hæmorrhagic diathesis exists, muscular exertion is a powerful exciting cause of all kinds of hæmorrhage, and must likewise give rise to the cutaneous form of the disease. A most remarkable case of the kind, occurring in a horse, is mentioned by Dr. Copeland. His friend Dr. W. Hutchinson had a fine Arabian horse, whose sweat was sanguineous after moderate exertion, and almost pure blood upon violent exertion (*Dict. of Med.*, l. c.).

Bloomfield (*Greek Test.* note on Luke xxii. 44) says that Aristotle adduces a case of bloody sweat from extreme agitation, in his *Hist. Anim.* iii. 19. This statement, however, is incorrect. Aristotle is merely speaking of the blood in a general way; and says, 'si sanguis immodice humescit, morbus infestat: sic enim in speciem saniei diluitur et adeo serescit, ut jam nonnulli sudore cruento exundant.' There is no allusion made to any case, nor a word said about extreme agitation. There is, however, a case of this kind recorded by Durius, a German physician (*Miscell. cur. Ephemerid.* p. 354, obs. 179). A student was put into prison, 'propter insolentias nocturnas et alia tentata,' when he was seized with such fear and agitation that drops of blood burst forth, here and there, from his hands, chest, and arms. Durius was ordered by the magistrate, who was informed of the circumstance, to visit the prisoner; and he witnessed all that had been related to him. The prisoner was of course immediately released, and was restored to his former state of health as soon as the cause of his anxiety had been removed. If this was really a fact, the student must have been affected with hæmorrhagic disease, or have had a very strong tendency to it; but the story does not deserve the slightest credence. The author does not appear to have imagined, for a moment, that it was a case of impo-

sition, or that it might be afterwards suspected to be such. His account is, therefore, confined to the bare statement of the fact, and affords no evidence of the correctness of his observation. It is highly improbable that a student of such habits should feel great alarm at being put in prison; while nothing is more conceivable than that he should attempt to impose on the credulity of his attendants, in order to obtain his release, and that he should even succeed in deceiving a physician. Medical experience abounds in cases of successful imposition of a far more extraordinary nature (Bartholinus, *Hist. Anat. rar.*, cent. i. hist. 52).

While, then, on the one hand, experience teaches that cutaneous hæmorrhage, when it does occur, is the result of disease, or, at any rate, of a very peculiar idiosyncrasy, and is in no way indicative of the state of the mind, we have, on the other, daily experience and the accumulated testimony of ages to prove that intense mental emotion and pain produce on the body effects even severer in degree, but of a very different nature. It is familiar to all that terror will blanch the hair, occasion momentary paralysis, fainting, convulsions, melancholy, imbecility, and even sudden death. Excessive grief and joy will produce some of the worst of these. Sweat is caused by fear, and by bodily pain; but not by sorrow, which excites no secretion except tears.

It is very evident, then, that medical experience does not bear at all upon the words of St. Luke. The circumstances connected with our Lord's sufferings in the garden must be considered by themselves, without any reference to actual observation; otherwise, we shall be in danger of rendering a statement, which may be easily received on its own grounds, obscure and contradictory.

It may be remarked that the passage in question only occurs in St. Luke, and is omitted in five MSS. of that Gospel.—W. A. N.

BLUE. [PURPLE.]

BOANERGES (*Boavepéγes*, explained by *viol Bpovῆς, sons of thunder*, Mark iii. 17), a surname given by Christ to James and John, probably on account of their fervid, impetuous spirit (comp. Luke ix. 54, and see Olshausen thereon). The word *boanerges* has greatly perplexed philologists and commentators. It seems agreed that the Greek term does not correctly represent the original Syro-Chaldee word, although it is disputed what that word was. Many, with Jerome, think that the true word is *Bevepeélu*, from the Hebrew *בני רעם bene-ra'am*, as in Hebrew *רעם* constantly denotes thunder. But this varies too much from the *vestigia literarum*. Others derive it from the Hebrew *בני רעש bene-ra'ash*, which deviates still further, and only signifies—sons of tumult or commotion. Recent interpreters therefore incline to the derivation of Caninius, De Dieu, and Fritzsche, who take it from *בני רגז bene-reges*, for *reges* in Syriac and Arabic signifies 'thunder.' Thus the word *boan-erges* would seem to be a slight corruption from *boane-reges*, the *boane* being very possibly the Galilæan pronunciation instead of *bene* (comp. Bloomfield's *New Test.* on Mark iii. 17; and Robinson's *Gr. Lex. s. v. Boavepéγes*).

BOAR (חזיר *hazir* or *chazir*, in Arabic *chizron*). Occurs in Lev. xi. 7; Deut. xiv. 8; Ps. lxxx. 13; Prov. xi. 22; Isa. lxxv. 4; lxvi. 3, 17.

The Hebrew, Egyptian, Arabian, Phœnician, and other neighbouring nations abstained from hog's flesh, and consequently, excepting in Egypt, and (at a later period) beyond the Sea of Galilee, no domesticated swine were reared. In

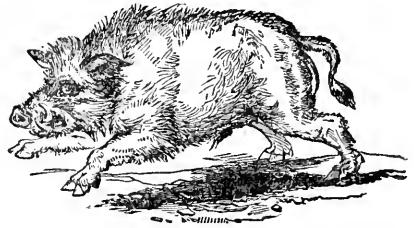

167. [Wild Boar.]

Egypt, where swineherds were treated as the lowest of men, even to a denial of admission into the temples, and where to have been touched by a swine defiled the person nearly as much as it did a Hebrew, it is difficult to conjecture for what purpose these animals were kept so abundantly, as it appears by the monumental pictures they were; for the mere service of treading down seed in the deposited mud of the Nile when the inundation subsided, the only purpose alleged, cannot be admitted as a sufficient explanation of the fact. Although in Palestine, Syria, and Phœnicia hogs were rarely domesticated, wild boars are often mentioned in the Scriptures, and they were frequent in the time of the Crusades; for Richard Cœur-de-Lion encountered one of vast size, ran him through with his lance, and while the animal was still endeavouring to gore his horse, he leaped over its back and slew it with his sword. At present wild boars frequent the marshes of the Delta, and are not uncommon on Mount Carmel and in the valley of Ajalah. They are abundant about the sources of the Jordan, and lower down where the river enters the Dead Sea. The Koords and other wandering tribes of Mesopotamia and on the banks of both the great rivers hunt and eat the wild boar, and it may be suspected that the half human satyrs they pretend sometimes to kill in the chase, derive their cloven-footed hind-quarters from wild boars, and offer a convenient mode of concealing from the women and public that the nutritive flesh they bring home is a luxury forbidden by their law. The wild boar of the East, though commonly smaller than the old breeds of domestic swine, grows occasionally to a very large size. It is passive while unmolested, but vindictive and fierce when roused. The ears of the species are small, and rather rounded, the snout broad, the tusks very prominent, the tail distichous, and the colour dark ashy, the ridge of the back bearing a profusion of long bristles. It is doubtful whether this species is the same as that of Europe, for the farrow are not striped: most likely it is identical with the wild hog of India.—C. H. S.

1. BOAZ (בועז, *alacritas*; Sept. Βοός), a wealthy Bethlehemite, and near kinsman of the first husband of Ruth, whom he eventually espoused under the obligations of the Levirate law, which he willingly incurred. The conduct of Boaz—his fine spirit, just feeling, piety, and amenity of manners

—appears to great advantage in the book of Ruth, and forms an interesting portraiture of the condition and deportment of what was in his time the upper class of Israelites. By his marriage with Ruth he became the father of Obed, from whom came Jesse, the father of David. He was thus one of the direct ancestors of Christ, and as such his name occurs in Matt. i. 5. There are some chronological difficulties respecting the time of Boaz and his genealogical connections; but as these are involved in the considerations which determine the time of the book of Ruth, they will be more advantageously examined in connection with that larger subject [RUTH; GENEALOGY].

2. BOAZ, the name given to one of the two brazen pillars which Solomon erected in the court of the Temple [JACHIN AND BOAZ].

BOCHIM (בְּכִיִּים, *weepings*), the name given to a place (probably near Shiloh, where the tabernacle then was) where an 'angel of the Lord' reproved the assembled Israelites for their disobedience in making leagues with the inhabitants of the land, and for their remissness in taking possession of their heritage. This caused the bitter weeping among the people for which the place took its name (Judg. ii. 1). 'Angel' is here usually taken in the ordinary sense of 'messenger,' and he is supposed to have been a prophet, which is strengthened by his being said to have come from Gilgal: for it was not usual to say that an angel came from another place, and Gilgal was a noted station and resort of holy men [GILGAL]. Most of the Jewish commentators regard this personage as Phinehas, who was at that time the high-priest. There are many, however, who deny that any man or created angel is here meant, and affirm that no other than the Great Angel of the Covenant is to be understood—the same who appeared to Moses in the bush, and to Joshua as the Captain of Jehovah's host. This notion is grounded on the fact that 'the angel,' without using the usual formula of delegation, 'thus saith the Lord,' says at once 'I made you to go up out of Egypt;' &c.

BOHAN (בֹּחַן, *a thumb*; Sept. Βαύων), a Reubenite, in whose honour a stone was erected which afterwards served as a boundary-mark on the frontier between Judah and Benjamin (Jos. xv. 6; xviii. 17). It does not appear from the text whether this stone was a sepulchral monument, or set up to commemorate some great exploit performed by this Bohan in the conquest of Canaan. Bunting (*Itinerar. tot. S. Script.* p. 144), mentioning Bahurim, says that near to it, in the valley, is a stone called *Bohan*, of extraordinary size, and shining like marble. This wants confirmation, and no authority is given.

BOND, BONDAGE. [SLAVERY.]

BOOK. [WRITING.]

BOOK OF LIFE. In Phil. iv. 3 Paul speaks of Clement and other of his fellow-labourers, 'whose names are written in the book of life.' On this Heinrichs (*Annotat. in Ep. Philipp.*) observes that as the future life is represented under the image of a πολιτεια (citizenship, community, political society) just before (iii. 20), it is in agreement with this to suppose (as usual) a catalogue of 'the citizens' names, both natural and adopted. Luke x. 20; Rev. xx. 15; xxi. 27), and from which the unworthy are erased (Rev.

iii. 5). Thus the names of the good are often represented as *registered in heaven* (Matt. iii. 5). But this by no means implies a certainty of salvation (nor, as Doddridge remarks, does it appear that Paul in this passage had any particular revelation), but only that at that time the persons were *on the list*, from which (as in Rev. iii. 5) the names of unworthy members might be erased. This explanation is sufficient and satisfactory for the other important passage in Rev. iii. 5, where the glorified Christ promises to 'him that overcometh,' that he will not blot his name out of the book of life. Here, however, the illustration has been sought rather in *military* than in *civil* life, and the passage has been supposed to contain an allusion to the custom according to which the names of those who were cashiered for misconduct were erased from the muster-roll.

When God threatened to destroy the Israelites altogether, and make of Moses a great nation—the legislator implored forgiveness for them, and added—'if not, blot me, I pray thee, out of the book which thou hast written' (Exod. xxxii. 34). By this he meant nothing so foolish or absurd as to offer to forfeit eternal life in the world to come—but only that he, and not they, should be cut off from the world, and brought to an untimely end. This has been regarded as an allusion to the records kept in the courts of justice, where the deeds of criminals are registered, and hence would signify no more than the purpose of God with reference to future events; so that to be cut off by an untimely death is to be blotted out of this book.

A *sealed book* (Isa. xxix. 11; Rev. v. 1-3) is a book whose contents are secret, and have for a very long time been so, and are not to be published till the seal is removed.

A *book or roll written within and without*, i. e. on the back side (Rev. v. 1), may be a book containing a long series of events; it not being the custom of the ancients to write on the back side of the roll, unless when the inside would not contain the whole of the writing (comp. Horace, *Ep.* i. 20, 3).

To *eat a book* signifies to consider it carefully, and digest it well in the mind (Jer. xv. 16; Rev. x. 9). A similar metaphor is used by Christ in John vi., where he repeatedly proposes himself as 'the Bread of Life' to be eaten by his people.

BOOTH (בֹּתֵךְ *succah*; pl. *succhoth*), a hut made of branches of trees, and thus distinguished from a tent properly so called. Such were the booths in which Jacob sojourned for a while on his return to the borders of Canaan, whence the place obtained the name of Succoth (Gen. xxxiii. 17); and such were the temporary green sheds in which the Israelites were directed to celebrate the Feast of Tabernacles (Lev. xxiii. 42, 43). As this observance was to commemorate the abode of the Israelites in the wilderness, it has been rather unwisely concluded by some that they there lived in such booths. But it is evident from the narrative, that, during their wanderings, they dwelt in tents; and, indeed, where, in that treeless region, could they have found branches with which to construct their booths? Such structures are only available in well-wooded regions; and it is obvious that the direction to celebrate the feast in booths, rather than in tents, was given because, when the Israelites became settled people in Pales-

time, and ceased to have a general use of tents, it was easier for them to erect a temporary shed of green branches than to provide a tent for the occasion.

BOOTY. [SPOIL.]

BORITH (בֹּרִית) occurs in two passages of Scripture—first, in Jerem. ii. 22, 'For though thou wash thee with nitre, and take thee much sope (borith), yet thine iniquity is marked before me, saith the Lord God;' and again, in Malachi iii. 2, 'But who may abide the day of his coming? and who shall stand when he appeareth? for he is like a refiner's fire, and like fullers' sope (borith).' From neither of these passages does it distinctly appear whether the substance referred to by the name of borith was obtained from the mineral or from the vegetable kingdom. But it is evident that it was possessed of cleansing properties; and this is confirmed by the origin and signification of the word, which is thus illustrated by Celsus: 'à verbo בָּרַר Barar, *purificavit*, quæ vox etiam apud Chaldæos, Syros, Arabes in usu fuit, descendit nomen בֹּר Bor, *puritas*' (*Hierobot.* i. p. 419). So Maimonides, on the Talmud, tract *Shemittah*, 'Species ablutioibus aptæ, uti sunt Borith et Ahal.'

The word *borith* is very similar to the *boruk* of the Arabs, written *bawrahk* in the Latin translations of Serapion and Avicenna; and translated nitrum—that is, natron, or carbonate of soda. *Boruk* appears, however, to have been used in a generic rather than in a specific sense, as in the Persian works on *Materia Medica*, derived chiefly from the Arabic, which we have collated, we find that no less than six different kinds of *boruk* (Persian *boorah*) are enumerated; of which some are natural, as the Armenian, the African, &c.; others artificial, as that obtained from burning the wood of the poplar; also that employed in the preparation of glass. Of these it is evident that the two last are, chemically, nearly the same, being both carbonates of alkalis; the incineration of most plants, as well as of the poplar, yield the carbonate of potash (commonly called potash, or pearlash); while carbonate of soda, or barilla, is the alkali used in the preparation of glass. Previous to the composition of bodies having been definitely ascertained by correct chemical analysis, dissimilar substances were often grouped together under one general term; while others, although similar in composition, were separated on account of some unimportant character, as difference of colour or of origin, &c. It is unnecessary for our present purpose to ascertain the other substances included by the Arabs under the general term of *boruk*, and which may have been also included under the nitrum of the Greeks. It is evident that both the carbonate of soda and of potash were comprehended under one name by the former. It would be difficult, therefore, to distinguish the one from the other, unless some circumstances were added in addition to the mere name. Thus in the above passage of Jeremiah we have *neter* (nitre) and *borith* (sope) indicated as being both employed for washing, or possessed of some cleansing properties; and yet, from occurring in the same passage, they must have differed in some respects. The term *natron* we know was, in later times, confined to the salt obtained chiefly from the natron-lakes of Egypt,

and *neter* may also have been so in earlier times. Since therefore the natural carbonate of soda is mentioned in one part of the verse, it is very probable that the artificial carbonates may be alluded to in the other, as both were in early times employed by Asiatic nations for the purposes of washing. The carbonate of potash, obtained from the burning of most plants growing at a distance from the sea or a saline soil, might not have been distinguished from the carbonate of soda, produced from the ashes of plants growing on the shores of the sea or of salt-water lakes.

Hence it is probable that the ashes of plants, called *boruk* and *boreh* by Asiatic nations, may be alluded to under the name of *borith*, as there is no proof that soap is intended, though it may have been known to the same people at very early periods. Still less is it probable that *borax* is meant, as has been supposed by some authors, apparently from the mere similarity of name.

Supposing that the ashes of plants are intended by the word *borith*, the next point of inquiry is, whether it is to be restricted to those of any particular plants. The ashes of the poplar are mentioned by Arabian authors, and of the vine by Dioscorides; those of the plantain and of the *Butea frondosa* by Sanscrit authors: thus indicating that the plants which were most common, or which were used for fuel, or other purposes, in the different countries, had also their ashes, that is, impure carbonate of potash, employed for washing, &c. Usually the ashes only of plants growing on the sea-shore have been thought to be intended. All these, as before mentioned, would yield barilla, or carbonate of soda. Many of them have been burnt, for the soda they yield, on the coasts of India, of the Red Sea, and of the Mediterranean. They belong chiefly to the natural family of the Chenopodeæ and to that of the Mesembryanthemums. In Arabic authors, the plant yielding soda is said to be called *ishman*, and its Persian name is stated to be *ghasool*, both words signifying 'the washer' or 'washing-herb.' *Rauwolf* points out two plants in Syria and Palestine which yield alkaline salts. *Hasselquist* considered one of them to be a Mesembryanthemum. *Forskål* has enumerated several plants as being burned for the barilla or soda which they afford: as *Mesembryanthemum geniculatum* and *nodiflorum*, both of which are called *ghasool*. *Salsola kali*, and his *Suaeda monoica*, called *asul*, are other plants, especially those last named, which yield sal-alkali. So on the coasts of the Indian Peninsula, *Salicornia Indica* and *Salsola nudiflora* yield barilla in great abundance and purity, as do *Salsola sativa*, *Kali*, *Soda*, and *Tragus*; and also *Salicornia annua*, on the coasts of Spain and of the South of France.—J. F. R.

BORROWING. On the general subject, as a matter of law or precept, see LOAN.

In Exod. xii. 35 we are told that the Israelites, when on the point of their departure from Egypt, 'borrowed of the Egyptians jewels of silver, and jewels of gold, and raiment;' and it is added, that 'the Lord gave the people favour in the sight of the Egyptians, so that they lent unto them such things as they required. And they spoiled the Egyptians.' This was in pursuance of a Divine command which had been given to them through Moses (Exod. iii. 22; xi. 2). This has suggested a difficulty, seeing that the Israelites had certainly no intention to

return to Egypt, or to restore the valuables which they thus obtained from their Egyptian 'neighbours.' The removal of this difficulty has been sought in various modes. The first is to question the accuracy of the present translation. It is admitted that the general acceptance of the word rendered *borrow* (שָׁבַע) is to *request* or *demand*; although there are places (Exod. xxii. 14; 1 Sam. i. 28; 2 Kings vi. 5) where *borrowing* is certainly denoted by it. The real question, therefore, is, which of these significations agrees best with the context and the circumstances of the transaction. Those who would at all hazards disconnect the Divine name from a transaction resting on this basis, allege that the Israelites did not *borrow* the valuables, but *demand*ed them of their Egyptian neighbours, as an indemnity for their services, and for the hard and bitter bondage which they had endured. But this does not appear to us to mend the matter much; for the Israelites had been public servants, rendering certain onerous services to the state, but not in personal bondage to individual Egyptians, whom, nevertheless, they, according to this account, mulcted of much valuable property in compensation for wrongs committed by the state. These individual Egyptians also were selected not with reference to their being implicated more than others in the wrongous treatment of the Israelites: they were those who happened to be their 'neighbours,' and as such open more than others to the exaction. This mode of extorting private and partial compensation for public wrong will not stand the test of our rules of public morality, any more than that of borrowing without the intention to restore. As so little is to be gained by the proposed change, we incline to adhere to the old interpretation, that the Israelites actually did *borrow* the valuables of the Egyptians, with the understanding, on the part of the latter, that they were to be restored. This agrees with the fact that the professed object of the Hebrews was not to quit Egypt for ever, but merely to withdraw for a few days into the desert, that they might here celebrate a high festival to their God. At such festivals it was usual among all nations to appear in their gayest attire, and decked with many ornaments; and this suggests the grounds on which the Israelites might rest the application to their Egyptian neighbours for the loan of their jewels and rich raiment. Their avowed intention to return in a few days must have made the request appear very reasonable to the Egyptians; and in fact the Orientals are, and always have been, remarkably ready and liberal in lending their ornaments to one another on occasions of religious solemnity or public ceremony. It would seem also as if the avowed intention to return precluded the Hebrews from any other ground than that of borrowing; for if they had *required* or *demand*ed these things as compensations or gifts, it would have amounted to an admission that they were quitting the country altogether. It is therefore best to take these things together—the *borrowing* as a necessary result of the professed intention to return; and, although the borrowing without the intention to restore, looks more unjustifiable than the avowed intention to return, when the real intention was to withdraw altogether—both facts must be tried by the same

general doctrine of public morals, and must be explained with reference to the same general principles. Turn which way we will in this matter, there is but a choice of difficulties; and this leads us to suspect that we are not acquainted with all the facts bearing on the case, in the absence of which we spend our strength for nought in labouring to explain it. One of the difficulties is somewhat softened by the conjecture of Professor Bush, who, in his Note on Exod. xi. 2, observes, 'We are by no means satisfied that Moses was required to *command* the people to practise the device here mentioned. We regard it rather, as far as *they* were concerned, as the mere *prediction* of a fact that should occur.'

BOSOM. It is usual with the western Asiatics to carry various sorts of things in the bosom of their dress, which forms a somewhat spacious depository, being wide above the girdle, which confines it so tightly around the waist as to prevent anything from slipping through. Aware of this, Harmer and our other Biblical illustrators rather hastily concluded that they had found an explanation of the text (Luke vi. 38), 'Good measure, pressed down, and shaken together, and running over, shall men give into your bosom.' All these expressions obviously apply, in the literal sense, to *corn*; and it is certain that corn and things measured in the manner described never are carried in the bosom. They could not be placed there, or carried there, or taken out without serious inconvenience, and then only in a small quantity. The things carried in the bosom are simply such as Europeans would, if in the East, carry in their pockets. Yet this habit of carrying valuable property may indicate the origin of the image, as an image, *into the bosom*, without requiring us to suppose that everything described as being given *into the bosom* really was deposited there.

To have one in our bosom implies kindness, secrecy, intimacy (Gen. xvi. 5; 2 Sam. xii. 8). Christ is *in the bosom of the Father*; that is, possesses the closest intimacy with, and most perfect knowledge of, the Father (John i. 18). Our Saviour is said to *carry his lambs in his bosom*, which touchingly represents his tender care and watchfulness over them.

BOSSES, the thickest and strongest parts, the prominent points of a buckler [ARMS, ARMOUR].

BOTNIM (בֹּטְנִים) occurs only in Gen. xliii. 11, where Jacob, wishing to conciliate the ruler of Egypt, desires his sons on their return to 'take of the best fruits in the land in their vessels and carry down the man a present,' and along with other articles mentions '*nuts* and almonds.' Here the word rendered *nuts* is *botnim*. Among the various translations of this term Celsius enumerates walnuts, hazel-nuts, pine-nuts, peaches, dates, the fruit of the terebinth-tree, and even almonds; but there is little doubt that *pistachio-nuts* is the true rendering. From the context it is evident that the articles intended for presents were the produce of Syria, or easily procurable there. Hence they were probably less common in Egypt, and therefore suitable for such a purpose.

The Hebrew word *botnim*, reduced from its plural form, is very similar to the Arabic **بطم** *batam*, which we find in Arabian authors, as Rhases, Serapion, and Avicenna. It is sometimes

written baton, boton, botin, and albotin. The name is applied specially to the terebinth-tree, or *Pistacia terebinthus* of botanists, the *τέρεβινθος* or *τερέβινθος* of the Greeks. This is the turpentine-yielding pistacia, a native of Syria and of the Greek Archipelago, which has already been described in the article *ΑΛΑΧ*. The tree, as there mentioned, is remarkable for yielding one of the finest kinds of turpentine, that usually called of Chio or of Cyprus, which, employed as a medicine in ancient times, still holds its place in the British pharmacopœias. From being produced only in a few places and from being highly valued, it is usually adulterated with the common kinds of turpentine. In many places, however, where the tree grows well, it does not yield turpentine, which may account for its not being noticed as a product of Palestine; otherwise we might have inferred that the turpentine of this species of pistacia formed one of the articles sent as a present into Egypt. This seems to have been the view of the translators of the Sept., who render botnim by *τερέβινθος*. The name batam is applied by the Arabs both to the turpentine and to the tree. It appears, however, to be sometimes used generically, as in some Arabic works it is applied to a tree of which the kernels of the seeds are described as being of a green colour. This is the distinguishing characteristic of another species of pistacia, the *P. vera* of botanists, of which the fruit is well known to the Arabs by the name of *fistuk*, which seems to be derived from the Persian *fisteh*. This, no doubt, gave origin to the Greek *πιστάκια*, said by Dioscorides to be produced in Syria and to be like pine-nuts. Besides these edible kernels, the pistacia-tree is described in the Arabic works on *Materia Medica* as yielding another product somewhat similar to the turpentine of the battam, but which is called 'aluk-al-anbat, a resin of the *anbat*, as if this were another name for the pistacia-tree. This brings it much nearer the botnim of Scripture. The *Botna* of the Talmud is considered by annotators to be the pistacia (Celsius, *Hierobot.* i. p. 26). Bochart for this and other reasons considered botnim to be the kernels of the pistacia-tree.

The pistachio-nut-tree is well known, extending as it does from Syria to Afghanistan. From the latter country the seeds are carried as an article of commerce to India, where they are eaten in their uncooked state, added to sweetmeats, or as a dessert fried with pepper and salt, being much relished by Europeans for the delicacy of their flavour. The pistacia-tree is most common in the northern, that is, the cooler parts of Syria, but it is also found wild in Palestine in some very remarkable positions, as Mount Tabor, and the summit of Mount Attarus (Nebo?), (*Physical Palestine*, p. 323). This tree is said to have been introduced from Syria into Italy by Lucius Vitellius in the reign of Tiberius. It delights in a dry soil, and rises to the height of 20, and sometimes 30 feet. As it belongs to the same genus as the terebinth-tree, so like it the male and female flowers grow on separate trees. It is therefore necessary for the fecundation of the seed that a male tree be planted among the female ones. It is probably owing to the flowers of the latter not being fecundated, that the trees occasionally bear oblong fruit-like but hollow bodies, which are sometimes described as galls, sometimes as

nuts, of little value. The ripe seeds are enclosed in a woody but brittle whitish-coloured shell, and within it is the seed-covering, which is thin, membranous, and of a reddish colour. The kernel is throughout of a green colour, abounds in oil, and has a sweetish agreeable taste. Pistachio-nuts are much eaten by the natives of the countries where they are grown, and, as we have seen, they form articles of commerce from Afghanistan to India—a hot country like Egypt. They are also exported from Syria to Europe in considerable quantities. They might therefore have well formed a part of the present intended for Joseph, notwithstanding the high position which he occupied in Egypt.—J. F. R.

BOTTLE. Natural objects, it is obvious, would be the earliest things employed for holding and preserving liquids; and of natural objects those would be preferred which either presented themselves nearly or quite ready for use, or such as could speedily be wrought into the requisite shape. The skins of animals afford in themselves more conveniences for the purpose than any other natural product. When an animal had been slain, either for food or sacrifice, it was easy and natural to use the hide for enveloping the fat or other substances, and with very little trouble the parts of the skin might be sewed together so as to make it hold liquids. The first bottles, therefore, were probably made of the skins of animals. Accordingly, in the fourth book of the *Iliad* (l. 247) the attendants are represented as bearing wine for use in a bottle made of goat's skin, *ἄσκαφ ἐν αἰγέλωρ*. In Herodotus also (ii. 121) a passage occurs by which it appears that it was customary among the ancient Egyptians to use bottles made of skins; and from the language employed by him it may be inferred that a bottle was formed by sewing up the skin and leaving the projection of the leg and foot to serve as a cock; hence it was termed *ποδεών*. This aperture was closed with a plug or a string. In some instances every part was sewed up except the neck; the neck of the animal thus became the neck of the bottle. This alleged use of skin-bottles by the Egyptians is confirmed by the monuments, on which such various forms as the following occur. Fig. 1 is curious as showing

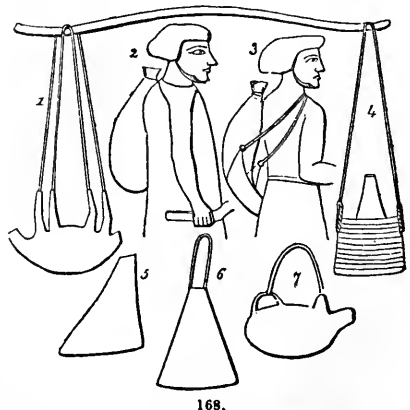

168.

the mode in which they were carried by a yoke; and as it balances a large bottle in a case, this skin

may be presumed to have contained wine. Fig. 7 is such a skin of water as in the agricultural scenes is suspended from the bough of a tree, and from which the labourers occasionally drink. Figs. 2 and 3 represent two men with skins at their backs, belonging to a party of nomades entering Egypt. This party has been with some plausibility supposed to represent the sons of Jacob—a point elsewhere considered [JOSEPH].

The Greeks and Romans also were accustomed to use bottles made of skins, chiefly for wine. Some interesting examples of those in use among the Romans are represented at Herculaneum and Pompeii, and are copied in the annexed engraving.



169.

Skin-bottles doubtless existed among the Hebrews even in patriarchal times; but the first clear notice of them does not occur till Joshua ix. 4, where it is said that the Gibeonites, wishing to impose upon Joshua as if they had come from a long distance, took 'old sacks upon their asses, and wine-bottles old and rent and bound up.' So in the 13th verse of the same chapter: 'these bottles of wine which we filled were new; and behold, they be rent; and these our garments and our shoes are become old by reason of the very long journey.' Age, then, had the effect of wearing and tearing the bottles in question, which must consequently have been of skin. To the same effect is the passage in Job xxxii. 19, 'My belly is as wine which hath no vent; it is ready to burst, like new bottles.' Our Saviour's language (Matt. ix. 17; Luke v. 37, 38; Mark ii. 22) is thus clearly explained: 'Men do not put new wine into old bottles, else the bottles break and the wine runneth out, and the bottles perish; 'New wine must be put in new bottles, and both are preserved.' To the conception of an English reader who knows of no bottles but such as are made of clay or glass, the idea of bottles breaking through age presents an insuperable difficulty; but skins may become 'old, rent and bound up;' they also prove, in time, hard and inelastic, and would in such a condition be very unfit to hold new wine, probably in a state of active fermentation. Even new skins might be unable to resist the internal pressure caused by fermentation. If, therefore, by 'new' is meant 'untried,' the passage just cited from Job presents no inconsistency.

As the drinking of wine is illegal among the Moslems who are now in possession of Western Asia, little is seen of the ancient use of skin-

bottles for wine, unless among the Christians of Georgia, Armenia, and Lebanon, where they are still thus employed. In Georgia the wine is stowed in large ox-skins, and is moved or kept at hand for use in smaller skins of goats or kids.

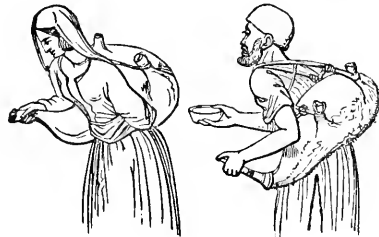

170.

But skins are still most extensively used throughout Western Asia for water. Their most usual forms are shown in the above cut (170), which also displays the manner in which they are carried. The water-carriers bear water in such skins and in this manner.

It is an error to represent bottles as being made exclusively of dressed or undressed skins among the ancient Hebrews (Jones, *Biblical Cyclopaedia*, in voc.). Among the Egyptians ornamental vases were of hard stone, alabaster, glass, ivory, bone, porcelain, bronze, silver or gold; and also, for the use of the people generally, of glazed pottery or common earthenware. As early as Thothmes III., assumed to be the Pharaoh of the Exodus, B.C. 1490, vases are known to have existed of a shape so elegant and of workmanship so superior, as to show that the art was not, even then, in its infancy.



171. — 1, 2. Gold. 3. Cut glass. 4. Earthenware. 5, 7. Porcelain. 6. Hard stone. 8. Gold, with plates and bands. 9. Stone. 10. Alabaster, with lid.

Many of the bronze vases found at Thebes and in other parts of Egypt are of a quality which cannot fail to excite admiration, and which proves the skill possessed by the Egyptians in the art of working and compounding metals. Their shapes are most various—some neat, some plain, some grotesque; some in form not unlike our cream-

jugs, others as devoid of taste as the wine-bottles of our cellars or the flower-pots of our conservatories. They had also bottles, small vases, and pots, used for holding ointment or for other purposes connected with the toilet, which were made of alabaster, glass, porcelain, and hard stone. The reader is here presented with a view of some of these vases and bottles, from actual specimens in the British Museum.

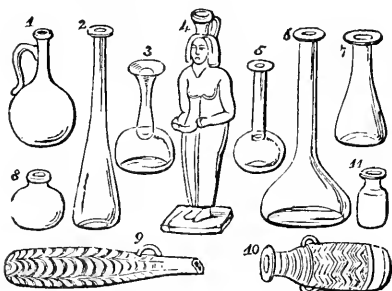

172.—1, 3, Earthenware. 2, 5, 6, 7, Green glass. 4, Blue glass. 8, 11, Alabaster. 9, 10, Porcelain.

The subjoined representation of a case containing bottles, supported on a stand, is among the Egyptian antiquities in the Berlin Museum, and is supposed to have belonged to a medical man or to the toilet of a Theban lady (Wilkinson, ii. 217). It forms a suitable conclusion to this set of illustrations.

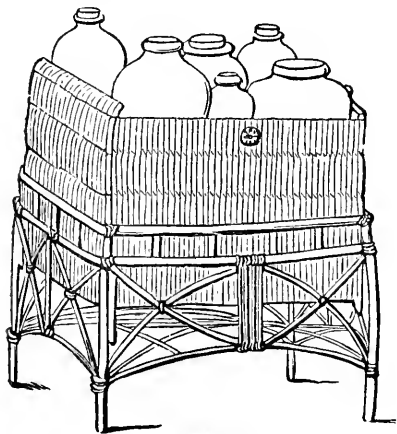

173.

The perishable nature of skin-bottles led, at an early period, to the employment of instruments of a more durable kind; and it is to be presumed that the children of Israel would, during their sojourn in Egypt, learn, among other arts practised by their masters, that of working in pottery-ware. Thus, as early as the days of the Judges (iv. 19; v. 25), bottles or vases composed of some earthy material, and apparently of a superior make, were in use; for, what in the fourth chapter is termed 'a bottle,' is in the fifth designated 'a lordly dish.' Isaiah (xxx. 14) expressly mentions 'the bottle of the potters,' as the reading in the margin gives it, being a literal translation

from the Hebrew, while the terms which the prophet employs show that he could not have intended any thing made of skin—'he shall break it as the breaking of the potter's vessel that is broken in pieces, so that there shall not be found in the bursting of it a sherd to take fire from the hearth, or to take water out of the pit.' In the nineteenth chap. ver. 1, Jeremiah is commanded, 'Go and get a potter's earthen bottle;' and (ver. 10) 'break the bottle;' 'Even so, saith the Lord of Hosts (ver. 11), will I break this people and this city as one breaketh a potter's vessel, that cannot be made whole again' (see also Jer. xiii. 12-14). Metaphorically the word bottle is used, especially in poetry, for the clouds considered as pouring out and pouring down water (Job xxxviii. 37), 'Who can stay the bottles of heaven?' The cut already given in p. 278 affords an illustration of a passage in the Psalms (lvi. 8), 'Put thou my tears in a bottle'—that is, 'treasure them up,—' have a regard to them as something precious.' It was, as appears from the cut at p. 278, customary to tie up in bags or small bottles, and secure with a seal, articles of value, such as precious stones, necklaces, and other ornaments.— J. R. B.

BOUNDARIES. [LANDMARKS.]

BOW. [ARMS.] The bow is frequently mentioned symbolically in Scripture. In Ps. vii. 12 it implies victory, signifying judgments laid up in store against offenders. It is sometimes used to denote lying and falsehood (Ps. lxiv. 4; cxx. 4; Jer. ix. 3), probably from the many circumstances which tend to render a bow inoperative, especially in unskilful hands. Hence also 'a deceitful bow' (Ps. lxxviii. 57; Hos. vii. 16); with which compare Virgil's 'Perfidus ensis frangitur.'

The bow also signifies any kind of arms. The bow and spear are the most frequently mentioned, because the ancients used these most (Ps. xlv. 6, xlv. 9; Zech. x. 4; Josh. xxiv. 12).

In Habakk. iii. 9 'thy bow was made bare,' means that it was drawn out of its case. The Orientals used to carry their bows in a case hung on their girdles.

In 2 Sam. i. 18 the Authorized Version has 'Also he (David) had them teach the children of Judah the use of the bow.' 'Here,' says Professor Robinson (*Addit. to Calmet*), 'the words "the use of" are not in the Hebrew, and convey a sense entirely false to the English reader. It should be "teach them the bow," i. e. the song of the bow, from the mention of this weapon in verse 22. This mode of selecting an inscription to a poem or work is common in the East; so in the Korán the second Sura is entitled *the cow*, from the incidental mention in it of the red heifer: comp. Num. xix. 2. In a similar manner, the names of the books of the Pentateuch in the Hebrew Bibles are merely the first word in each book.'

BOWELS are often put by the Hebrew writers for the internal parts generally, the inner man, and so also for *heart*, as we use that term. Hence the bowels are made the seat of tenderness, mercy, and compassion; and thus the Scriptural expressions of the bowels being moved, bowels of mercy straitened in the bowels, &c. By a similar association of ideas, the bowels are also sometimes made the seat of wisdom and understanding (Job xxxviii. 36; Ps. li. 10; Isa. xvi. 11).

BOWING [ATTITUDES.]

BOX-TREE. [TEASHER.]

BOZRAH (בֹּזְרַיִם; Sept. Βοσόρ), an ancient city, known also to the Greeks and Romans by the name of ΒΟΣΡΙΑ. In most of the passages of the Old Testament where it is mentioned, it appears as a chief city of the Edomites (Isa. xxxiv. 6; lxiii. 1; Amos i. 12; Jer. xlix. 13, 22). In Jer. xlviii. 24 Bozrah is named among the cities of Moab: but it does not hence follow, as Raumer and others contend, that we should regard them as different cities; for, in consequence of the continual wars, incursions, and conquests which were common among the small kingdoms of that region, the possession of particular cities often passed into different hands. Thus Selah, *i. e.* Petra, the capital of the Edomites, taken from them by Amaziah, king of Judah (2 Kings xiv. 7), is also mentioned by Isaiah (lvi. 1) among the Moabitish cities. Since Bozrah lay not in the original territory of the Edomites, *i. e.* south-east of Judah, but north of the territory of the Ammonites, in Auranitis, or Hauran, we must suppose that the Edomites had become masters of it by conquest, and that it was afterwards taken from them by the Moabites, who for a time retained it in their possession. This is upon the whole more satisfactory than the conclusion of Raumer (*Palästina*), who makes Bostra to be the Bozrah of Moab, and seeks the Bozrah of Edom in the present Besseyra, *i. e.* little Bozrah, so called, he conjectures, to distinguish it from the Bozrah of Moab. His principal argument, that Edom is described as dwelling in 'the clefts of the rocks' (Jer. xlix. 16), is of little weight, seeing that it is very possible for the dwellers in rocks and mountains to have possessions in the neighbouring plains.

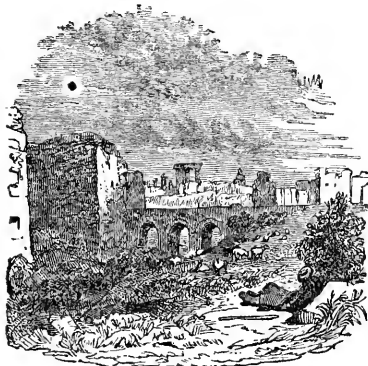

174. [Bozrah.]

Bozrah lay southward from Edrei, one of the capitals of Bashan, and, according to Eusebius, 24 Roman miles distant from it. The Romans reckoned Bozrah as belonging to Arabia Deserta (Amm. Marcell. xiv. 27). Alexander Severus made it the seat of a Roman colony. In the acts of the Nicene, Ephesian, and Chalcedonian councils mention is made of bishops of Bozrah; and at a later period it became an important seat of the Nestorians (Asseman, *Biblioth. Orient.* tom. iii. pt. 2, pp. 595, 730). Abulfeda makes it the capital of the Hauran, in which, according to Burck-

hardt, it is still one of the most important towns. Although the place has been since visited by Laborde (from whom our engraving is taken), Lord Lindsay, and other later travellers, the account which Burckhardt gives of Bozrah is still the best that we possess. 'Bozrah is situated in the open plain, and is at present the last inhabited place in the south-east extremity of the Hauran. It was formerly the capital of *Arabia Provincia*, and is now, including the ruins, the largest town in the Hauran. It is of an oval shape, its greatest length being from east to west; its circumference is three quarters of an hour. It was anciently enclosed by a thick wall, which gave it the reputation of a place of great strength. Many parts of this wall, especially on the west side, still remain; it is constructed with stones of a moderate size, strongly cemented together. The principal buildings of Bozrah were on the east side, and in a direction thence towards the middle of the town. The south and south-east quarters are covered with the ruins of private dwellings, the walls of many of which are still standing, but most of the roofs have fallen in. The style of building seems to be similar to that observed in all the other ancient towns of the Hauran. On the west side are springs of fresh water, of which I counted five beyond the precincts of the town and six within the walls; their waters unite with a rivulet, whose source is on the north-west side, within the town, and which loses itself in the southern plain at several hours' distance. On the eastern quarter of the town is a large bucket, or reservoir, almost perfect, 190 paces in length, 153 in breadth, and enclosed by a wall seven feet in thickness, built of large square stones; its depth may be about 20 feet. A staircase leads down to the water, as the basin is never completely filled. This reservoir is a work of the Saracens, made for watering the pilgrims' caravans to Mecca, which as late as the seventeenth century passed by Bozrah. . . . Just beyond the walls is a large castle of Saracenic origin, probably of the time of the Crusades; it is one of the best-built castles in Syria, and is surrounded by a deep ditch. Its walls are very thick, and in the interior are alleys dark vaults, subterraneous passages, &c. of the most solid construction. This castle is a most important post to protect the harvests of the Hauran against the hungry Bedouins. . . . Of the vineyards for which Bozrah was celebrated, and which are commemorated in the Greek medals of the *Colonia Bostræ*, not a vestige remains. There is scarcely a tree in the neighbourhood of the town, and the twelve or fifteen families who now inhabit it cultivate nothing but wheat, barley, horse-beans, and a little dhourra (Indian corn). A number of fine rose-trees grow wild among the ruins of the town, and are just beginning (April 28th) to open their buds' (Burckhardt's *Syria*, pp. 224-236).

The same writer gives a very ample description of the various ruins, the extent and importance of which are alone sufficient to evince the ancient consequence of the place. They are of various kinds, Greek, Roman, and Saracenic, with traces of the native works in the private dwellings.

These monuments of ancient grandeur serve but to heighten the impression which is created by the present desolation and decay.—'Bozrah,' says Lord Lindsay, 'is now for the most part a heap of ruins, a most dreary spectacle: here and there

the direction of a street or alley is discernible, but that is all. The modern inhabitants—a mere handful—are almost lost in the maze of ruins. Olive-trees grew here within a few years, they told us—all extinct now, like the vines for which the Bostra of the Romans was famous. And such, in the nineteenth century, and under Moslem rule, is the condition of a city which even in the seventh century, at the time of its capture by the Saracens, was called by Caled “the market-place of Syria, Irak, and the Hedjaz.” “I have sworn by myself, saith the Lord of Hosts, that Bozrah shall become a desolation and reproach, a waste and a curse; and all the cities thereof shall be perpetual wastes!” (Jer. xlix. 13.) And it is so.

BRACELET. This name, in strict propriety, is as applicable to circlets worn on the upper part of the arm as to those worn on the wrist; but as it has been found convenient to distinguish the former as **ARMLETS**, the term bracelet must be restricted to the latter. These are, and always have been, much in use among Eastern females. Many of them are of the same shapes and patterns as the armlets, and are often of such considerable weight and bulk as to appear more like manacles than ornaments. Many are often worn one above another on the same arm, so as to occupy the greater part of the space between the wrist and the elbow. The materials vary according to the condition of the wearer, but it seems to be the rule that bracelets of the meanest materials are better than none. Among the higher classes they are of mother-of-pearl, of fine flexible gold, and of silver, the last being the most common. The poorer women use plated steel, horn, brass, copper, beads, and other materials of a cheap description. Some notion of the size and value of the bracelets used both now and in ancient times may be formed from the fact that those which were presented by Eliezer to Rebecca weighed ten shekels (Gen. xxiv. 22). The bracelets are sometimes flat, but more frequently round or semicircular, except at the point where they open to admit the hand, where they are flattened. They are frequently hollow, giving the show of bulk (which is much desired) without the inconvenience. Bracelets of gold twisted rope-wise are those now most used in Western Asia; but we cannot determine to what extent this fashion may have existed in ancient times.

BRAMBLE. [THORN.]

BRANCH. As trees, in Scripture, denote great men and princes, so branches, boughs, sprouts, or plants denote their offspring. In conformity with this way of speaking, Christ, in respect of his human nature, is styled a rod from the stem of Jesse, and a branch out of his roots (Isa. xi. 1), that is, a prince arising from the family of David. This symbol was also in use among the ancient poets (Sophocles, *Electra*, iv. 18; Homer, *Iliad*, ii. 47, 170, 211, 252, 349; Pindar, *Olymp.* ii. 6, &c.). ‘And so even in our English tongue (remarks Wemyss), the word *imp*, which is originally Saxon, and denotes a plant, is used to the same purpose, especially by Fox, the martyrologist, who calls King Edward the Sixth an imp of great hope; and by Thomas Cromwell, Earl of Essex, in his dying speech, who has the same expression concerning the same prince.’

A branch is the symbol of kings descended from royal ancestors, as branches from the root (Ezek. xvii. 3, 10; Dan. xi. 7). As only a vigorous tree can send forth vigorous branches, a branch is used as a general symbol of prosperity (Job viii. 16).

From these explanations it is easy to see how a branch becomes the symbol of the Messiah (Isa. xi. 1; iv. 2; Jer. xxiii. 15; Zech. iii. 8; vi. 12; and elsewhere).

Branch is also used as the symbol of idolatrous worship (Ezek. viii. 17), probably in allusion to the general custom of carrying branches as a sign of honour.

An *abominable branch* (Isa. xiv. 19) means a tree on which a malefactor has been hanged. In Ezek. xvii. 3 Jehoiachim is called the *highest branch* of the cedar, as being a king.

BRASS. This word occurs in the Authorized Version. But brass is a factitious metal, not known to the early Hebrews, and wherever it occurs, *copper* is to be understood [COPPER]. That copper is meant is shown by the text, ‘Out of whose hills thou mayest dig brass’ (Deut. viii. 9), it being of course impossible to dig a factitious metal, whether brass or bronze, out of mines. That compound of copper and zinc which forms our brass does not appear to have been known to the ancients; but we have every evidence that they knew and used *bronze* arms, implements of that metal having been found in great abundance among ancient tombs and ruins. This, instead of pure copper, is probably sometimes, in the later Scriptures, meant by the word כֶּסֶף [COPPER].

Brass (to retain the word) is in Scripture the symbol of insensibility, baseness, and presumption or obstinacy in sin (Isa. xlvi. 4; Jer. vi. 28; Ezek. xxii. 18). Brass is also a symbol of strength (Ps. cvii. 16; Isa. xlvi. 4; Mic. iv. 13). So in Jer. i. 18 and xv. 20, brazen walls signify a strong and lasting adversary or opponent.

The description of the Macedonian empire as a *kingdom of brass* (Dan. ii. 39) will be better understood when we recollect that the arms of ancient times were mostly of bronze; hence the figure forcibly indicates the warlike character of that kingdom. The *mountains of brass*, in Zech. vi. 1, are understood by Vitringa to denote those firm and immutable decrees by which God governs the world, and it is difficult to affix any other meaning to the phrase (comp. Ps. xxxvi. 6).

BREAD. The word ‘bread’ was of far more extensive meaning among the Hebrews than with us. There are passages in which it appears to be applied to all kinds of victuals (Luke xi. 3); but it more generally denotes all kinds of baked and pastry articles of food. It is also used, however, in the more limited sense of bread made from wheat or barley, for rye is little cultivated in the East. Barley being used chiefly by the poor, and for feeding horses [BARLEY], *bread*, in the more limited sense, chiefly denotes the various kinds of cake-like bread prepared from *wheaten* flour.

Corn is ground daily in the East [MILL]. After the wheaten flour is taken from the hand-mill, it is made into a dough or paste in a small wooden trough. It is next leavened; after which it is made into thin cakes or flaps, round or oval, and then baked.

The *kneading-troughs*, in which the dough is prepared, have no resemblance to ours in size or shape. As one person does not bake bread for many families, as in our towns, and as one family does not bake bread sufficient for many days, as in our villages, but every family bakes for the day only the quantity of bread which it requires, only a comparatively small quantity of dough is prepared. This is done in small wooden bowls; and that those of the ancient Hebrews were of the same description as those now in use appears from their being able to carry them, together with the dough, wrapped up in their cloaks, upon their shoulders without difficulty. The Bedouin Arabs, indeed, use for this purpose a leather, which can be drawn up into a bag by a running cord along the border, and in which they prepare and often carry their dough. This might equally, and in some respects better answer the described conditions; but, being especially adapted to the use of a nomade and tent-dwelling people, it is more likely that the Israelites, who were not such at the time of the Exode, then used the wooden bowls for their 'kneading-troughs' (Exod. viii. 3; xii. 34; Deut. xxviii. 5, 7). It is clear, from the history of the departure from Egypt, that the flour had first been made into a dough by water only, in which state it had been kept some little time before it was leavened; for when the Israelites were unexpectedly (as to the moment) compelled in all haste to withdraw, it was found that, although the dough had been prepared in the kneading-trough, it was still unleavened (Exod. xii. 34; comp. Hos. vii. 4); and it was in commemoration of this circumstance that they and their descendants in all ages were enjoined to eat only unleavened bread at the feast of the Passover.

The dough thus prepared is not always baked at home. In towns there are public ovens and bakers by trade; and although the general rule in large and respectable families is to bake the bread at home, much bread is bought of the bakers by unsettled individuals and poor persons; and many small households send their dough to be baked at the public oven, the baker receiving for his trouble a portion of the baked bread, which he adds to his day's stock of bread for sale. Such public ovens and bakers by trade must have existed anciently in Palestine, and in the East generally, as is evident from Hos. vii. 4 and Jer. xxxvii. 21. The latter text mentions the bakers' street (or rather bakers' place or market), and this would suggest that, as is the case at present, the bakers, as well as other trades, had a particular part of the bazaar or market entirely appropriated to their business, instead of being dispersed in different parts of the towns where they lived.

For their larger operations the bakers have ovens of brick, not altogether unlike our own; and in large houses there are similar ovens. The ovens used in domestic baking are, however, usually of a portable description, and are large vessels of stone, earthenware, or copper, inside of which, when properly heated, small loaves and cakes are baked, and on the outer surface of which thin flaps of bread, or else a large wafer-like biscuit, may be prepared.

Another mode of baking bread is much used, especially in the villages. A pit is sunk in the middle of the floor of the principal room, about

four or five feet deep by three in diameter, well lined with compost or cement. When sufficiently heated by a fire kindled at the bottom, the bread is made by the thin pancake-like flaps of dough being, by a peculiar knack of hand in the women, stuck against the oven, to which they adhere for a few moments, till they are sufficiently dressed. As this oven requires considerable fuel, it is seldom used except in those parts where that article is somewhat abundant, and where the winter cold is severe enough to render the warmth of the oven desirable, not only for baking bread, but for warming the apartment.

Another sort of oven, or rather mode of baking, is much in use among the pastoral tribes. A shallow hole, about six inches deep by three or four feet in diameter, is made in the ground: this is filled up with dry brushwood, upon which, when kindled, pebbles are thrown to concentrate and retain the heat. Meanwhile the dough is prepared; and when the oven is sufficiently heated, the ashes and pebbles are removed, and the spot well cleaned out. The dough is then deposited in the hollow, and is left there over night. The cakes thus baked are about two fingers thick, and are very palatable. There can be little doubt that this kind of oven and mode of baking bread were common among the Jews. Hence, Hezel very ingeniously, if not truly, conjectures (*Real-Lexicon*, art. 'Brod') comes the סלי הורי of Gen. xi.

16, which he renders, or rather paraphrases, 'baskets full of bread baked in holes,' not 'white baskets,' as in the Authorized Version, nor 'baskets full of holes,' as in our margin; nor 'white bread,' as in most of the continental versions, seeing that all bread is white in the East. As the process is slower and the bread more savoury than any other, this kind of bread might certainly be entitled to the distinction implied in its being prepared for the table of the Egyptian king. That the name of the oven should pass to the bread baked in it, is not unusual in the East, just as the modern *tadsheen* (*pan*) gives its name (say *pan*-cake) to the cake baked by it. Hezel's conjecture that the oven in question is called a hole, הור, in Hebrew, and that the bread baked by it is called therefrom *hole-bread*, is corroborated by, if not founded upon, a passage cited by Buxtorf in his *Lex. Talmud*: 'Faciunt הור foramen, vel cavitatem in terra, et calefaciunt eam igni coquantque in ea panem, qui vocatur הוררה, à הורר cavitare illa in qua coctus est.'

There is a baking utensil called in Arabic *tajen* (طاجين) which is the same word (τηγάνου) by which the Septuagint renders the Hebrew מַחֲבַת *machabath*, in Lev. ii. 5. This leaves little doubt that the ancient Hebrews had this *tajen*. It is a sort of pan of earthenware or iron (usually the latter), flat, or slightly convex, which is put over a slow fire, and on which the thin flaps of dough are laid and baked with considerable expedition, although only one cake can be baked in this way at a time. This is not a household mode of preparing bread, but is one of the simple and primitive processes employed by the wandering and semi-wandering tribes, shepherds, husbandmen and others, who have occasion to prepare a small quantity of daily bread in an easy off-hand manner. Bread is also baked in a manner which, al-

though apparently very different, is but a modification of the principle of the *tajen*, and is used chiefly in the houses of the peasantry. There is a cavity in the fire-heap, in which, when required for baking, a fire is kindled and burnt down to hot embers. A plate of iron, or sometimes copper, is placed over the hole, and on this the bread is baked.

Another mode of baking is in use chiefly among the pastoral tribes, and by travellers in the open country, but is not unknown in the villages. A smooth clear spot is chosen in the loose ground, a sandy soil—so common in the Eastern deserts and harder lands—being preferred. On this a fire is kindled, and, when the ground is sufficiently heated, the embers and ashes are raked aside, and the dough is laid on the heated spot, and then covered over with the glowing embers and ashes which had just been removed. The bread is several times turned, and in less than half an hour is sufficiently baked. Bread thus baked is called in Scripture עֲגָה *'uggah* (Gen. xviii. 6; 1 Kings xvii. 13; Ezek. iv. 12), and the indication, 1 Kings xix. 6, is very clear, עֲגַת רֶצֶפִים *'uggath retzafim* (*coal-cakes*), i. e. cakes baked under the coals. The Septuagint expresses this word *'uggath* very fairly by ἐγκρυφίας, panis subimericius (Gen. xviii. 6; Exod. xii. 39). According to Busbequius (*Itin.* p. 36), the name of *Huqath*, which he interprets *ash-cakes*, or *ash-bread*, was in his time still applied in Bulgaria to cakes prepared in this fashion; and as soon as a stranger arrived in the villages, the women baked such bread in all haste, in order to sell it to him. This conveys an interesting illustration of Gen. xvi. 6, where Sarah, on the arrival of three strangers, was required to bake 'quickly' such ash-bread—though not for sale, but for the hospitable entertainment of the unknown travellers. The bread thus prepared is good and palatable, although the outer rind, or crust, is apt to smell and taste of the smoke and ashes. The necessity of turning these cakes gives a satisfactory explanation of Hos. vii. 8, where Ephraim is compared to a cake not turned, i. e. only baked on one side, while the other is raw and adhesive.

The second chapter of Leviticus gives a sort of list of the different kinds of bread and cakes in use among the ancient Israelites. This is done incidentally, for the purpose of distinguishing the kinds which were and which were not suitable for offerings. Of such as were fit for offerings we find—

I. *Bread baked in ovens* (Lev. ii. 4); but this is limited to two sorts, which appear to be, 1st, the bread baked inside the vessels of stone, metal or earthenware, as already mentioned. In this case the oven is half filled with small smooth pebbles, upon which, when heated and the fuel withdrawn, the dough is laid. Bread prepared in this mode is necessarily full of indentations or holes, from the pebbles on which it is baked; 2nd, the bread prepared by dropping with the hollow of the hand a thin layer of the almost liquid dough upon the outside of the same oven, and which, being baked dry the moment it touches the heated surface, forms a thin wafer-like bread or biscuit. The first of these Moses appears to distinguish by the characteristic epithet of חֲלוֹת, *perforated*, or *full of holes*; and the other by the name of רֶקִיקִים, *thin cakes*, being, if correctly identified, by much the thin-

ness of any bread used in the East. A cake of the former was offered as the first of the dough (Lev. viii. 26), and is mentioned in 2 Sam. vi. 19, with the addition of 'bread,'—*perforated bread* (חֲלֵת לַחֵם). Both sorts, when used for offerings, were to be unleavened (perhaps to secure their being prepared for the special purpose); and the first sort, namely, that which appears to have been baked inside the oven, was to be *mixed up* with oil, while the other (that baked outside the oven), which from its thinness could not possibly be thus treated, was to be only smeared with oil. The fresh olive oil, which was to be used for this purpose, imparts to the bread something of the flavour of butter, which last is usually of very indifferent quality in Eastern countries.

II. *Bread baked in a pan*—1st, that which, as before described, is baked in, or rather on, the *tajen*. This also as an offering was to be unleavened and mixed with oil. 2nd, This, according to Lev. ii. 6, could be broken into pieces, and oil poured over it, forming a distinct kind of bread and offering. And in fact the thin biscuits baked on the *tajen*, as well as the other kinds of bread, thus broken up and re-made into a kind of dough, form a kind of food or pastry in which the Orientals take much delight, and which makes a standing dish among the pastoral tribes. The ash-cake answering to the Hebrew *'uggah* is the most frequently employed for this purpose. When it is baked, it is broken up into crumbs, and re-kneaded with water, to which is added, in the course of the operation, butter, oil, vinegar, or honey. Having thus again reduced it to a tough dough, the mass is broken into pieces, which are baked in smaller cakes and eaten as a dainty. The preparation for the Mosaic offering was more simple; but it serves to indicate the existence of such preparations among the ancient Israelites.

III. *Bread baked upon the hearth*—that is to say, baked upon the hearth-stone, or plate covering the fire-pit which has already been mentioned. This also was to be mixed with oil (Lev. ii. 7).

As these various kinds of baked breads were allowed as offerings, there is no question that they were the best modes of preparing bread known to the Hebrews in the time of Moses; and as all the ingredients were such as Palestine abundantly produced, they were such offerings as even the poorest might without much difficulty procure.

Besides these there are two other modes of preparing bread indicated in the Scriptures, which cannot with equal certainty be identified by reference to modern usages.

One of these is the נִקּוּדִים *nikuddim* of 1 Kings xiv. 3, translated 'cracknels' in the Authorized Version, an almost obsolete word denoting a kind of crisp cake. The original would seem by its etymology (from נִקָּד, speckled, spotted), to denote something spotted or sprinkled over, &c. Buxtorf (*Lex. Chald. et Talm.*) writes under this word: 'Orbiculi parvi panis instar dimidii orni. *Teramoth*, c. 5; and in another place (*Epit. rad. Hebr.* p. 544), 'Et bucellata, 1 Reg. xiv. 3, quæ biscoccta vulgo vocant, sic dicta, quod in frusta exigua rotunda, quasi puncta conficerentur, aut quod singulari forma interpunctarentur.' It is indeed not improbable that they may have been a sort of biscuit or small and hard baked cakes,

calculated to keep (for a journey or some other purpose), by reason of their excessive hardness (or perhaps being twice baked, as the word *biscuit* implies). Not only are such hard cakes or biscuits still used in the East, but they are, like all biscuits, *punctured* to render them more hard, and sometimes also they are sprinkled with seeds; either of which circumstances sufficiently meets the conditions suggested by the etymology of the Hebrew word. The existence of such biscuits is further implied in Josh. ix. 5, 12, where the Gibeonites describe their bread as having become as *hard as biscuit* (not 'mouldy,' as in the Authorized Version), by reason of the length of their journey.

The other was a kind of fancy bread, the making of which appears to have been a rare accomplishment, since Tamar was required to prepare it for Amnon in his pretended illness (2 Sam. xiii. 6). As the name only indicates that it was some favourite kind of cake, of which there may have been different sorts, no conjecture with reference to it can be offered. See Hezel, *Real-Lexicon*, art. 'Brod'; Burckhardt, *Notes on the Bedouins*; and the various travellers in Palestine, &c., particularly Shaw, Niebuhr, Mouconys, Russell, Lane (*Modern Egyptians*), Perkins, Olin, &c. compared with the present writer's personal observations.

BREAD OF THE PRESENCE. [SHew BREAD.]

BREASTPLATE, a piece of defensive armour. [ARMS, ARMOUR.]

BREASTPLATE OF THE HIGH-PRIEST, a splendid ornament covering the breast of the high-priest. It was composed of richly embroidered cloth, in which were set, in four rows, twelve precious stones, on each of which was engraven the name of one of the twelve tribes of Israel (Exod. xxviii. 15-29; xxxix. 8-21). [PRIESTS, DRESS OF.]

BRECHES. [PRIESTS, DRESS OF.]

BRICKS. Bricks compacted with straw and dried in the sun, are those which are chiefly mentioned in the Scriptures. Of such bricks the tower of Babel was doubtless composed [ABEL, BABYLON], and the making of such formed the chief labour of the Israelites when bondsmen in Egypt (Exod. i. 13, 14). This last fact constitutes the principal subject of Scriptural interest connected with bricks; and leads us to regard with peculiar interest the mural paintings of that country, which have lately been brought to light, in which scenes of brick-making are depicted.

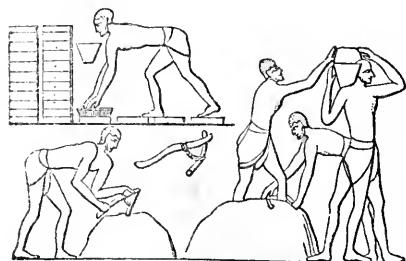

173. [Egyptian Brickmaking.]

'The use of crude brick, baked in the sun, was universal in Upper and Lower Egypt, both for public and private buildings; and the brick-

field gave abundant occupation to numerous labourers throughout the country. These simple materials were found to be particularly suited to the climate, and the ease, rapidity, and cheapness with which they were made, afforded additional recommendations. Inclosures of gardens or granaries, sacred circuits encompassing the courts of temples, walls of fortifications and towns, dwelling-houses and tombs, in short, all but the temples themselves were of crude brick; and so great was the demand, that the Egyptian government, observing the profit which would accrue from a monopoly of them, undertook to supply the public at a moderate price, thus preventing all unauthorized persons from engaging in the manufacture. And in order the more effectually to obtain this end, the seal of the king, or of some privileged person, was stamped upon the bricks at the time they were made. This fact, though not positively mentioned by any ancient author, is inferred from finding bricks so marked both in public and private buildings; some having the ovals of a king, and some the name and titles of a priest, or other influential person: and it is probable that those which bear no characters belonged to individuals who had obtained a licence or permission from the government, to fabricate them for their own consumption. The employment of numerous captives who worked as slaves, enabled the government to sell the bricks at a lower price than those who had recourse solely to free labour; so that, without the necessity of a prohibition, they speedily became an exclusive manufacture; and we find that, independent of native labourers, a great many foreigners were constantly engaged in the brick-fields at Thebes and other parts of Egypt. The Jews, of course, were not excluded from this drudgery; and, like the captives detained in the Thebaid, they were condemned to the same labour in Lower Egypt. They erected granaries, treasure-cities, and other public buildings for the Egyptian monarch: the materials used in their construction were the work of their hands; and the constant employment of brick-makers may be accounted for by the extensive supply required and kept by the government for sale' (Wilkinson's *Ancient Egyptians*, ii. pp. 97, 98).

Captive foreigners being thus found engaged in brick-making, Biblical illustrators, with their usual alacrity, jumped to the conclusion that these captive foreigners were Jews, and that the scenes represented were those of their actual operations in Egypt. Sir J. G. Wilkinson satisfactorily disposes of this inference by the following remark: 'To meet with Hebrews in the sculptures cannot reasonably be expected, since the remains in that part of Egypt where they lived have not been preserved; but it is curious to discover other foreign captives occupied in the same manner, and overlooked by similar 'task-masters,' and performing the very same labours as the Israelites described in the Bible; and no one can look at the paintings of Thebes, representing brick-makers, without a feeling of the highest interest. . . . It is scarcely fair to argue that, because the Jews made bricks, and the persons here introduced are so engaged, they must necessarily be Jews; since the Egyptians and their captives are constantly required to perform the same task; and the great quantity made at all times may be justly inferred from

the number of buildings which still remain, constructed of these materials: but it is worthy of remark that *more bricks bearing the name of Thothmes III. (who is supposed to have been the king at the time of the Exode) have been discovered than at any other period*, owing to the many prisoners of Asiatic nations employed by him, independent of his Hebrew captives.

The process of manufacture indicated by the representations in cut 175, does not materially differ from that which is still followed in the same country. The clay was brought in baskets from the Nile, thrown into a heap, thoroughly saturated with water, and worked up to a proper temper by the feet of the labourers. And here it is observable that the watering and tempering of the clay is performed entirely by the light-coloured labourers, who are the captives, the Egyptians being always painted red. This labour in such a climate must have been very fatiguing and unwholesome, and it consequently appears to have been shunned by the native Egyptians. There is an allusion to the severity of this labour in Nahum iii. 14, 15. The clay, when tempered, was cut by an instrument somewhat resembling the agricultural hoe, and moulded in an oblong trough; the bricks were then dried in the sun, and some from their colour appear to have been baked or burned, but no trace of this operation has yet been discovered in the monuments (Dr. W. C. Taylor's *Bible Illustrated*, p. 82). The writer just cited makes the following pertinent remarks on the order of the king that the Israelites should collect the straw with which to compact (not burn) their bricks: 'It is evident that Pharaoh did not require a physical impossibility, because the Egyptian reapers only cut away the tops of the corn [AGRICULTURE]. We must remember that the tyrannical Pharaoh issued his orders prohibiting the supply of straw about two months before the time of harvest. If, therefore, the straw had not been usually left standing in the fields, he would have shown himself an idiot as well as a tyrant; but the narrative shows us that the Israelites found the stems of the last year's harvest standing in the fields; for by the word 'stubble' (Exod. v. 12) the historian clearly means the stalks that remained from the last year's harvest. Still the demand that they should complete their tale of bricks was one that could scarcely be fulfilled; and the conduct of Pharaoh on this occasion is a perfect specimen of Oriental despotism.'

BRIDE, BRIDEGROOM. [MARRIAGE.]

BRIDGE. It is somewhat remarkable that the word bridge does not occur in all Scripture, although there were without doubt bridges over the rivers of Palestine, especially in the country beyond the Jordan, in which the principal perennial streams are found. There is mention of a military bridge (2 Macc. xii. 13) which Judas Maccabæus intended to make, in order to facilitate his operations against the town of Caspis, had he not been prevented. There are traces of ancient bridges across the Jordan, above and below the lake of Gennesareth, and also over the Arnon and other rivers which enter the Jordan from the East; and some of the winter torrents which traverse the westernmost plain (the plain of the coast) are crossed by bridges. But the oldest of these appear to be of Roman origin, and some of more recent date. It would be useless, in a subject so little

Biblical, to trace the contrivances which were probably resorted to in the ruder and more remote ages. Such contrivances, before the stone bridge is attained, are progressively the same in most countries, or varied only by local circumstances. The bridges which existed in the later ages of Scriptural history are probably not very different from those which we still find in and near Palestine; and under this view the following representations of existing bridges are introduced.

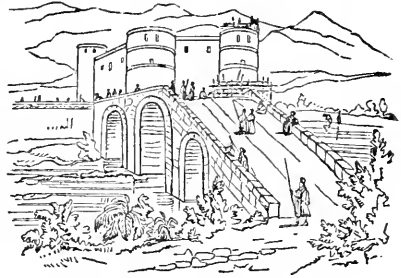

176. [Jacob's Bridge.]

The principal existing bridge in Palestine is that shown in cut 176. It crosses the upper Jordan about two miles below the lake Houle. The river here flows rapidly through a narrow bed; and here from the most remote ages has lain the high road to Damascus from all parts of Palestine; which renders it likely that a bridge existed at this place in very ancient times, although, of course, not the one which is now standing. The bridge is called Jacob's Bridge (*Jissr Yakoub*), from a tradition that it marks the spot where the patriarch Jacob crossed the river on his return from Padan-Aram. But it is also sometimes called *Jissr Beni Yakoub*, the Bridge of Jacob's Sons, which may suggest that

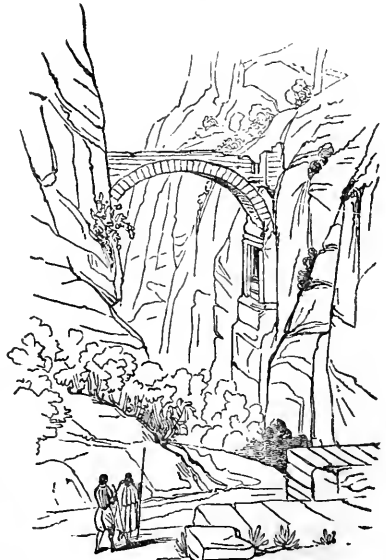

177. [Bridge at El Sak.]

the name is rather derived from some Arab tribe called the Beni Yakoub. The bridge is a very solid structure, well built, with a high curve in the middle like all the Syrian bridges; and is composed of three arches, in the usual style of these fabrics. Close by it, on the east, is a khan much frequented by travellers, built upon the remains of a fortress which was erected by the Crusaders to command the passage of the Jordan. A few soldiers are now stationed here to collect a toll upon all the laden beasts which cross the bridge.

No. 177 is a bridge or arch thrown over a ravine at El Sak, the antiquity of which is evinced by the sculptured cliffs with which it is connected.

Somewhat similar to this is the bridge next represented (No. 178), which is in many respects a

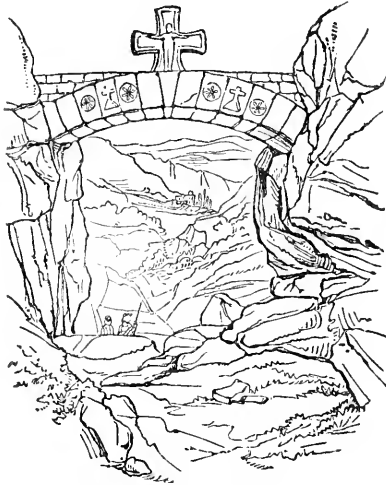

178. [Bridge of St. Anthony.]

curious and remarkable structure. It leads to a convent (of St. Anthony) among the mountains; which explains the Christian symbols that have been placed upon it.

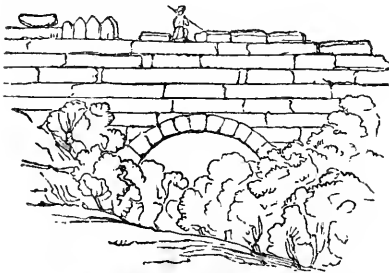

179. [Bridge at Tchavdere.]

No. 179 is an ancient bridge, at Tchavdere, in Asia Minor. It is introduced as a fair specimen of many ancient bridges of one arch, by which winter torrents and small streams are crossed in Syria and Asia Minor.

Bridges, such as the following (No. 180), also entirely unfenced, frequently occur.

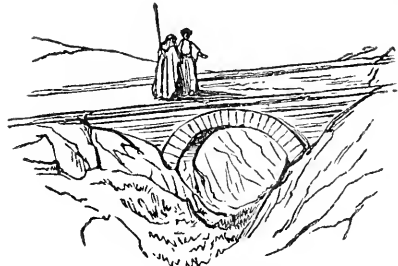

180. [Unfenced Bridge.]

No. 181 is a Persian bridge; but it is here introduced as a very fair specimen of the general character of the bridges which are met with in all parts of Western Asia.

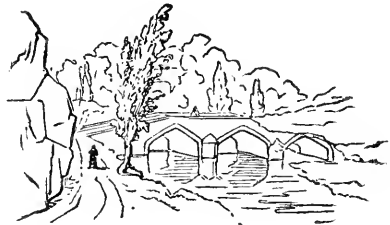

181. [Persian Bridge.]

BRIERS. [THORNS.]

BROOK (נַחַל *nachal*; Sept. χεῖμαρρος): the original word thus translated might better be rendered by *torrent*. It is applied, 1. to small streams arising from a subterraneous spring, and flowing through a deep valley, such as the Arnon, Jabbok, Kidron, Sorek, &c.; and also the brook of the willows, mentioned in Isa. xv. 7; 2. to winter-torrents, arising from rains, and which are soon dried up in the warm season (Job vi. 15, 19). Such is the noted river (brook) of Egypt, so often mentioned as at the southernmost border of Palestine (Num. xxxiv. 5; Josh. xv. 4, 47), and, in fact, such are most of the brooks and streams of Palestine, which are numerous in winter and early spring, but of which very few survive the beginning of the summer.

BROTHER (אָדֵלְפֹס; New Test. Ἀδελφός). This term is so variously and extensively applied in Scripture, that it becomes important carefully to distinguish the different acceptations in which it is used.

1. It denotes a brother in the natural sense, whether the offspring of the same father only (Matt. i. 2; Luke iii. 1, 19), or of the same father and mother (Luke vi. 14, &c.).—2. A near relative or kinsman by blood, cousin (Gen. xiii. 8; xiv. 16; Matt. xii. 46; John vii. 3; Acts i. 14; Gal. i. 19).—3. One who is connected with another by any tie of intimacy or fellowship: hence—4. One born in the same country, descended from the same stock, a fellow countryman (Matt. v. 47; Acts iii. 22; Heb. vii. 5; Exod. ii. 11; iv. 18).—5. One of equal rank and dignity (Job xxx. 29; Prov. xviii. 9; Matt. xxiii. 8).—6. Disciples, followers, &c. (Matt. xxv. 40; Heb. ii. 11, 12).—7. One of the

same faith (Amos i. 9; Acts ix. 30; xi. 29; 1 Cor. v. xi.); from which and other texts it appears that the first converts to the faith of Jesus were known to each other by the title of Brethren, till the name of Christians was given to them at Antioch (Acts xi. 26).—8. An associate, colleague in office or dignity, &c. (Ezra iii. 2; 1 Cor. i. 1; 2 Cor. i. 1; &c.)—9. One of the same nature, a fellow-man (Gen. xiii. 8; xxvi. 31; Matt. v. 22, 23, 24; vii. 5; Heb. ii. 17; viii. 11).—10. One beloved, *i. e.* as a brother, in a direct address (Acts ii. 29; vi. 3; 1 Thess. v. 1).

In Matt. xiii. 55 James, Josés, Simon, and Judas are mentioned as the brothers of Jesus, and in the ensuing verse sisters are also ascribed to him. The Protestant spirit of opposition to the Popish notion about the perpetual virginity of Mary, has led many commentators to contend that this must be taken in the literal sense, and that these persons are to be regarded as children whom she bore to her husband Joseph after the birth of Christ. On the whole we incline to this opinion, seeing that such a supposition is more in agreement with the spirit and letter of the context than any other; and as the force of the allusion to the brothers and sisters of Jesus would be much weakened if more distant relatives are to be understood. Nevertheless there are some grounds for the other opinion, that these were not natural brothers and sisters, but near relations, probably cousins, of Christ. In Matt. xxvii. 56 a James and Josés are described as sons of Mary (certainly not the Virgin); and again a James and Judas are described as sons of Alphæus (Luke vi. 15, 16, which Alphæus is probably the same as Cleophas, husband of Mary, sister of the Virgin (John xix. 25). If therefore it were clear that this James, Josés and Judas are the same that are elsewhere described as the Lord's brothers, this point would be beyond dispute; but as it is, much doubt must always hang over it.

BUBASTIS. [PIBESETH.]

BULL (בַּשׁ *shor*), with other kindred terms, has been already noticed in the article BEEVES. We may add תֹּר *tor*, which occurs only in Ezra vi. 9, 17; vii. 17; Dan. iv. 25, 32, 33 [iv. 22, 29, 30]; in all which passages it seems to refer to bullocks, labouring or yoke oxen, and cattle wild or tame, taken collectively; אַבִּירִים *abirim*, implying strength, and rendered 'bulls,' is found in Ps. xxii. 12; l. 13; lxxviii. 30; Isa. xxxiv. 7, and Jer. xlvi. 21; and אַגְלוֹת *agloth*, אַגְלִים *aglim*, are used when the animals are under three years of age. It is contended that the castration of no animal was practised among the Hebrews. If that was the case other methods than those generally alluded to must have been adopted to break oxen to labour; for the mere application of a metal ring through the cartilage of the nostrils, although it might have greatly restrained the ferocity of the beasts, would not assuredly have rendered them sufficiently docile to the yoke and goad of a people whose chief dependence for food was in the produce of the plough.

The rearing of horned cattle was encouraged by the people of Israel. These animals were protected in some cases by express provisions of the law; they were held clean, being the usual sacrifice of consideration, and the chief article of flesh diet of

the population. Judging from Egyptian remains, there were two great breeds of straight-backed cattle, the long-horned and the short-horned; and in Upper Egypt at least, there was one without horns. Another hunched species existed, which served to draw chariots, yoked in the same manner as the Brahmince bulls of India are at present. It is still abundant in Nubia, and, under the name of *bos sacer*, or *Indicus*, notwithstanding it breeds with the common species, is yet considered distinct. The calf is born with teeth; and although in central Africa, India, and China it is mixed with the other species, and when low in flesh is almost deprived of its hunch, the natural characters nevertheless continue; and from the evidence of ancient Egyptian pictures and written documents it must have been propagated for above 3000 years.

In Egypt the straight-backed or common cattle appear, from the same evidence, to have formed a very handsome breed with lunate horns. They were generally spotted black or red upon a white ground, and there were, besides, others white, red, or black. They all served for common use, but those without red were selected when new sacred bulls, apis or mnevis, were to be supplied; for they alone had the colours which could show the marks made by chance or by art, and required to fit the animal for the purpose intended. There was, besides, a sacred cow; and a black bull was worshipped at Hermonthis. This was the *bash*, the largest of bulls, by the Greeks changed to *onaphis*, *basis*, *bazis*, and had the additional character of the hair running the wrong way, or forward; hence, evidently it was not a true ox or bull, but a species of gnu, the *catoblepas gorgon*, or *cat. taurina*, still denominated *baas* (which is a Namaqua Hottentot name, and not Dutch, although the same word in Dutch signifies 'master') by the Namaquas, and a con-

gener or the same as the **فشل** *fesh-tall* of Shaw, whose name indicates a similar maned and bristled external. This presents another instance of the extension of Semitic words and names to South Africa; for though it may be that the same word was applied to a species of an approximating genus, perhaps the *Aigocerus niger*, which is black, and, like others of the group, has the direction of the hair on the mane and anterior parts turned forward, either or both of the above species may have extended so far northward as to have been within the occasional reach of the Egyptian priesthood; and the first, at least, which has congeners in Northern Africa, possesses external characters sufficiently remarkable to have answered their purposes.

In Palestine the breed of cattle was most likely in ancient times, as it still is, inferior in size to the Egyptian; and provender must have been abundant indeed, if the number of beasts sacrificed at the great Jewish festivals, mentioned in Josephus, be correct, and could be sustained for a succession of years.

Unless the name be taken synonymously with that of other species, there is not in the Bible any indication of the buffalo. The Asiatic species was not known in Greece till the time of Aristotle, who first speaks of it by the name of the Arachosian ox. No species of *Bos Bubalus* is known even at this day in Arabia; but in Egypt the Asiatic species has been introduced in consequence of the *Mohammedan*

medan conquests in the East. The indigenous buffaloes of Africa, amounting at least to two very distinct species, appear to have belonged to the south and west of that continent, and only at a later period to have approached Egypt as far as the present Bornou; for none are figured on any known monument in either Upper or Lower Egypt. With regard, however, to wild oxen of the true Taurine genus, some may, at a very remote period, have been found in Bashan, evidently the origin of the name,—a region where mountain, wood, and water, all connecting the Syrian Libanus with Taurus, were favourable to their existence; but the wild bulls of the district, mentioned in Psalm xxii. 12, and in various other passages, appear, nevertheless, to refer to domestic species, probably left to propagate without much human superintendence, except annually

marking the increase, and selecting a portion for consumption, in the same manner as is still practised in some parts of Europe. For although the words, 'fat bulls of Bashan close me in on every side,' are an indication of wild manners, the word 'fat' somewhat weakens the impression; and we know that the half-wild white breed of Scotland likewise retains the character of encompassing objects that excite their distrust. It was therefore natural that in Palestine wild gregarious instincts should have still remained in operation, where real dangers beset herds, which in the time of David were still exposed to lions in the hills around them. See ANTELOPE, and CALF, where *Bahumed* seems to be a modification of *Bahema*. Baal is said to have been worshipped in the form of a beevee, and Moloch to have had a calf's or steer's head [BEEVES; CALF].—C. H. S.



182. [Ancient Jewish Funeral: Costume, Modern Syrian.]

BURIAL and SEPULCHRES. Abraham, in his treaty for the cave of Macpelah, spoke the language of nature when he expressed his anxiety to obtain a secure place in which 'to bury his dead out of his sight'; and accordingly, amongst every people whose natural feelings have been influenced by pure morality and religion, the consignment of the mortal remains of those near and dear to them to the custody of their mother earth, has been approved of as the most proper and pleasing mode of disposing of the dead. Two instances, indeed, we meet with in sacred history of the barbarous practice of burning them to ashes: the one in the case of Saul and his sons, whose bodies were probably so much mangled as to preclude their receiving the royal honours of embalment (1 Sam. xxxi. 12); the other, mentioned by Amos (vi. 10), appears to refer to a season of prevailing pestilence, and the burning of those who died of plague was probably one of the sanitary measures adopted to prevent the spread of contagion. But throughout the whole of their national history the people of God observed the practice of burial. Amongst them, as amongst many other ancient nations, the rites of sepulture were considered as of indispensable importance. It was deemed not only an act of humanity, but a sacred duty of religion to pay the last honours to the departed; while, to be deprived of these, as was frequently the fate of enemies at the hands of ruthless conquerors (2 Sam. xxi. 9-14; 2 Kings xi. 11-16; Ps. lxxix. 2; Eccles. vi. 3), was considered the greatest calamity and disgrace which a person could suffer.

On the death of any member of a family, preparations were forthwith made for the burial, which, among the Jews, were in many respects similar to those which are common in the East at the present day, and were more or less expensive according to circumstances. After the solemn ceremony of the last kiss and closing the eyes,

the corpse, which was perfumed by the nearest relative, having been laid out and the head covered with a napkin, was subjected to entire ablution in warm water (Acts ix. 37), a precaution probably adopted to guard against premature interment. But, besides this first and indispensable attention, other cares of a more elaborate and costly description were amongst certain classes bestowed on the remains of deceased friends, the origin of which is to be traced to a fond and natural, though foolish anxiety to retard or defy the process of decomposition, and all of which may be included under the general head of embalming. Nowhere was this operation performed with such religious care and in so scientific a manner as in ancient Egypt, which could boast of a class of professional men trained to the business; and such adepts had these 'physicians' become in the art of preserving dead bodies, that there are *mummies* still found, which must have existed



183. [Interior of a Mummy Pit.]

for many thousand years, and are probably the remains of subjects of the early Pharaohs. The

bodies of Jacob and Joseph underwent this eminently Egyptian preparation for burial, which on both occasions was doubtless executed in a style of the greatest magnificence (Gen. 1. 2, 26). Whether this expensive method of embalming was imitated by the earlier Hebrews, we have no distinct accounts; but we learn from their practice in later ages that they had some observance of the kind, only they substituted a simpler and more expeditious, though it must have been a less efficient process, which consisted in merely swathing the corpse round with numerous folds of linen, and sometimes a variety of stuffs, and anointing it with a mixture of aromatic substances, of which aloes and myrrh were the chief ingredients. A sparing use of spices on such occasions was reckoned a misplaced and discreditable economy; and few higher tokens of respect could be paid to the remains of a departed friend than a profuse application of costly perfumes. Thus we are told by the writers of the Talmud (*Massecheth Semacoth*, viii.), that not less than eighty pounds weight of spices were used at the funeral of Rabbi Gamaliel, an elder; and by Josephus (*Antiq.* xvii. 8. § 3), that in the splendid funeral procession of Herod, 500 of his servants attended as spice-bearers. Thus, too, after the crucifixion, Nicodemus and Joseph of Arimathea, two men of wealth, testified their regard for the sacred body of the Saviour by 'bringing a mixture of myrrh and aloes about an hundred pound weight' (John xix. 39, 40); while, unknown to them, the two Marys, together with their associates, were prepared to render the same office of friendship on the dawn of the first day of the week. Whatever cavils the Jewish doctors have made at their extravagance and unnecessary waste in lavishing such a quantity of costly perfumes on a person in the circumstances of Jesus, the liberality of those pious disciples in the performance of the rites of their country was unquestionably dictated by the profound veneration which they cherished for the memory of their Lord. Nor can we be certain but they intended to use the great abundance of perfumes they provided, not in the common way of anointing the corpse, but, as was done in the case of princes and very eminent personages, of preparing 'a bed of spices,' in which, after burning them, they might deposit the body (2 Chron. xvi. 14; Jer. xxxiv. 5). For unpatriotic and wicked princes, however, the people made no such burnings, and hence the honour was denied to Jehoram (2 Chron. xxi. 19).

The corpse, after receiving the preliminary attentions, was enveloped in the grave-clothes, which were sometimes nothing more than the ordinary dress, or folds of linen cloth wrapped



184. [Grave-clothes.]

round the body, and a napkin about the head; though in other cases a shroud was used, which had long before been prepared by the individual for the purpose, and was plain or ornamental according to taste or other circumstances. The body thus dressed was deposited in an upper

chamber in solemn state, open to the view of all visitors (Acts ix. 37).

From the moment the vital spark was extinguished, the members of the family, especially the females, in the violent style of Oriental grief, burst out into shrill, loud, and doleful lamentations, and were soon joined by their friends and neighbours, who, on hearing of the event, crowded to the house in such numbers that Mark describes it by the term *θόρυβος*, a tumult (v. 38). By the better classes, among whom such liberties were not allowed, this duty of sympathizing with the bereaved family was, and still is, performed by a class of females who engaged themselves as professional mourners, and who, seated amid the mourning circle, studied, by vehement sobs and gesticulations, and by singing dirges in which they eulogized the personal qualities or virtuous and benevolent actions of the deceased (Acts ix. 39), to stir the source of tears, and give fresh impulse to the grief of the afflicted relatives. Numbers of these singing men and women lamented the death of Josiah (2 Chron. xxxv. 25). The effect of their melancholy ditties was sometimes heightened by the attendance of minstrels (*αὐληταί*, properly *pipers*); and thus in solemn silence, broken only at intervals by vocal and instrumental strains suited to the mournful occasion, the time was passed till the corpse was carried forth to the grave.

The period between the death and the burial was much shorter than custom sanctions in our country; for a long delay in the removal of a corpse would have been attended with much inconvenience, from the heat of the climate generally, and, among the Jews in particular, from the circumstance that every one that came near the chamber was unclean for a week. Interment, therefore, where there was no embalming, was never postponed beyond twenty-four hours after death, and generally it took place much earlier. It is still the practice in the East to have burials soon over; and there are two instances in sacred history where consignment to the grave followed immediately after decease (Acts v. 6, 10).

Persons of distinction were deposited in coffins. Among the Egyptians, who were the inventors of them, these chests were formed most commonly of several layers of pasteboard glued together, sometimes of stone, more rarely of sycamore wood, which was reserved for the great, and furnished, it is probable, the materials of the coffin which received the honoured remains of the vizier of Egypt. There is good reason to believe also that the kings and other exalted personages in ancient Palestine were buried in coffins of wood or stone, on which, as additional marks of honour, were placed their insignia when they were carried to their tombs—if a prince, his crown and sceptre—if a warrior, his armour,—and if a rabbi, his books.

But the most common mode of carrying a corpse to the grave was on a bier or *bed* (2 Sam. iii. 31), which in some cases must have been furnished in a costly and elegant style, if, as many learned men conclude from the history of Asa (2 Chron. xvi. 14) and of Herod (Josephus, *Antiq.* xvii. 8. § 3), these royal personages were conveyed to their tombs on their own beds. The bier, however, in use among the common and meaner sort of people was nothing but a plain

wooden board, on which, supported by two poles, the body lay concealed only by a slight coverlet

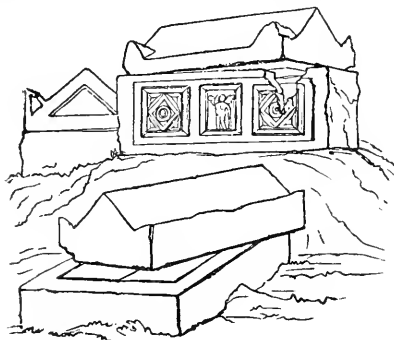

185. [Ancient Sarcophagi in Palestine.]

from the view of the attendants. On such a humble vehicle was the widow's son of Nain carried (Luke vii. 14), and 'this mode of performing funeral obsequies,' says an intelligent traveller, 'obtains equally in the present day among the Jews, Mohammedans, and Christians of the East.' The nearest relatives kept close by the bier, and performed the office of bearers, in which, however, they were assisted by the company in succession. For if the deceased was a public character, or, though in humble life, had been much esteemed, the friends and neighbours showed their respect by volunteering attendance in great numbers; and hence, in the story of the affecting incident at Nain, it is related that 'much people of the city were with the widow.' In cases where the expense could be afforded, hired mourners accompanied the procession, and, by every now and then lifting the covering and exposing the corpse, gave the signal to the company to renew their shouts of lamentation. A remarkable instance occurs in the splendid funeral cavalcade of Jacob. Those mercenaries broke out at intervals into the most passionate expressions of grief, but especially on approaching the boundaries of Canaan and the site of the sepulchre: the immense company halted for seven days, and, under the guidance of the mourning attendants, indulged in the most violent paroxysms of sorrow.

Sepulchres were, as they still are in the East, —by a prudential arrangement sadly neglected in our country—situated without the precincts of cities. Among the Jews, in the case of Levitical cities, the distance required to be 2000 cubits, and in all it was considerable. Nobody was allowed to be buried within the walls, Jerusalem forming the only exception, and even there the privilege was reserved for the royal family of David and a few persons of exalted character (1 Kings ii. 10; 2 Kings xiv. 20). In the vicinity of this capital were public cemeteries for the general accommodation of the inhabitants, besides a field appropriated to the burial of strangers,—the supposed site of which, together with the discoveries made in it, has been described by a late traveller, Wilde, in a most interesting and satisfactory manner, but the evidence he adduces for his conclusions does not admit of abridgment here.

The style of the public cemeteries around the cities of ancient Palestine in all probability resembled that of the present burying-places of the East, of which Dr. Shaw gives the following description:—'They occupy a large space, a great extent of ground being allotted for the purpose. Each family has a portion of it walled in like a garden, where the bones of its ancestors have remained undisturbed for many generations. For in these inclosures the graves are all distinct and separate; each of them having a stone placed upright, both at the head and feet, inscribed with the name or title of the deceased; whilst the intermediate space is either planted with flowers, bordered round with stone, or paved with tiles.'

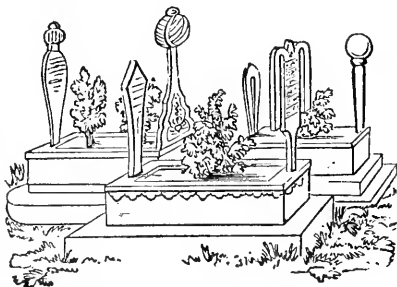

186. [Modern Syrian Tombs.]

Examples of these tombs are given in Nos. 186 and 187. By these it is seen that, as among people in good circumstances, the monumental stones are placed upon quadrangular tombs, in the centre of which evergreen or flowering shrubs are often planted, and tended with much care.

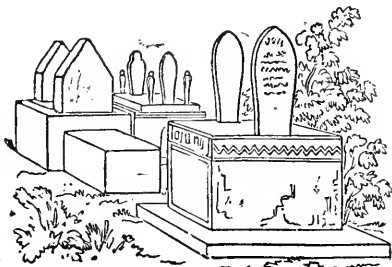

187. [Modern Syrian Tombs.]



188. [Rachel's Sepulchre.]

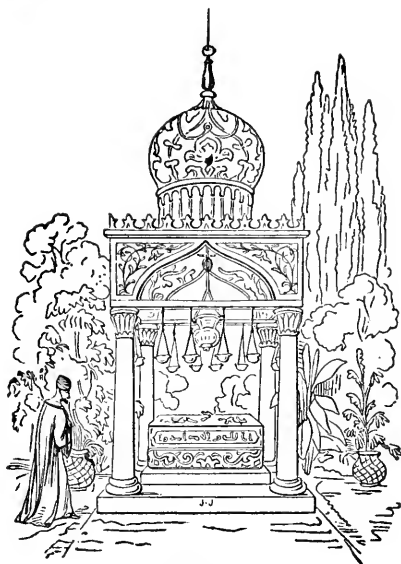

189. [Garden Tomb.]

There were other sepulchres which were private property, erected at the expense and for the use of several families in a neighbourhood, or provided by individuals as a separate burying-place for themselves. These were situated either in some conspicuous place, as Rachel's on the highway to Bethlehem (Gen. xxxv. 19)—the comparatively modern representation of which is given above in No. 188—or in some lonely and sequestered spot, under a wide-spreading tree (Gen. xxxv. 8) in a field or a garden. Of such garden tombs a modern Oriental specimen is given in No. 189, and over which, especially when the tomb is that of some holy person, lamps are sometimes hung and occasionally lighted. In common cases, sepulchres were formed by digging a small depth into the ground. Over these, which were considered an humble kind of tomb, the wealthy and great often erected small stone buildings, in the form of a house or cupola, to serve as their family sepulchre. These are usually open at the sides, as in the two specimens annexed, Nos. 190 and 191, which are of forms such as a traveller in the East has daily occasion to notice. Sometimes, however, these interesting monuments are built up on all sides, as in the tomb of Rachel figured above (No. 188); so that the walls are required to be taken down, and a breach made to a certain extent, on each successive interment. 'This custom,' says Carne, 'which is of great antiquity, and particularly prevails in the lonely parts of Lebanon, may serve to explain some passages of Scripture. The prophet Samuel was buried in his own house at Ramah, and Joab was buried in his house in the wilderness. These, it is evident, were not their dwelling-houses, but mansions for the dead, or family vaults which they had built within their own policies.' Not unfrequently, however, those who had large establishments, and whose fortunes enabled them to command the assistance of human art and labour,

purchased, like Abraham, some of the natural caverns with which Palestine abounded, and converted them by some suitable alterations into family sepulchres; while others with vast pains and expense made excavations in the solid rock (Matt. xxvii. 60). These, the entrance to which was either horizontal or by a flight of steps, had their roofs, which were arched with the native stone, so high as to admit persons standing upright, and were very spacious, sometimes being divided into several distinct apartments; in which case the remoter or innermost chambers were dug a little deeper than those that were nearer the entrance, the approach into their darker solitudes being made by another descending stair. Many sepulchres of this description are still found in Palestine; but the descent into them is so choked up with the rubbish of ages, that they are nearly inaccessible, and have been explored only by a few indefatigable

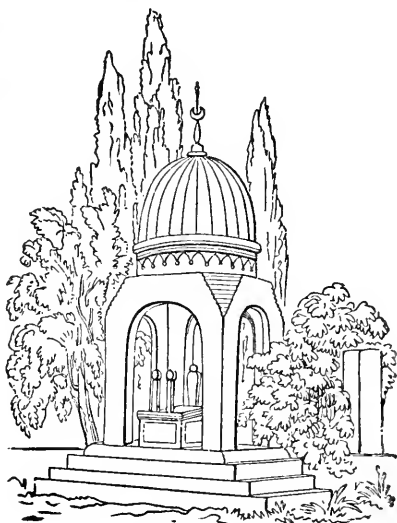

190. [Domed Sepulchre.]

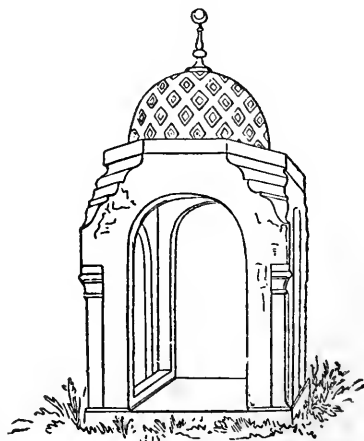

191. [Domed Sepulchre.]

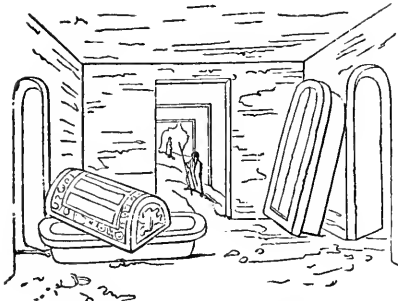

192. [Interior of Tomb of the Kings.]

nunters after antiquities. Along the sides of those vast caverns niches were cut, or sometimes shelves ranged one above another, on which were deposited the bodies of the dead, while in others the ground-floor of the tomb was raised so as to make different compartments, the lowest place in the family vaults being reserved for the servants. These interior arrangements may be the better understood by the help of the annexed engravings showing the interiors of tombs now actually existing in Palestine. No. 192 is the interior of the celebrated Tomb of the Kings (so called), near Jerusalem. In it are some further specimens of the stone sarcophagi already noticed. No. 193

three large niches in which the bodies were deposited.

The entrance chamber of an extensive crypt, examined by Dr. Wilde (*Narrative*, ii. 344), situated on what he supposes to have been the site of Aceldama near Jerusalem, is shown in No. 195. The different doors, at the upper end and on each side, lead to small oblong chambers or crypts, about seven feet long, containing on each side a stone trough or sarcophagus, in every one of which bones still remain. The knowledge of this internal arrangement in those immense subterranean receptacles serves to illustrate that magnificent passage, where the prophet in a strain of the most sublime poetry represents all the kings of the earth as lying in sepulchral glory,

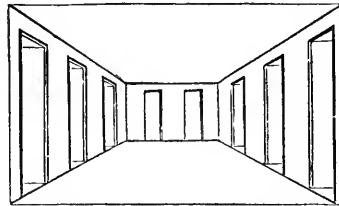

95. [Interior of Sepulchre near Jerusalem.]

and as raising themselves from their cells or thrones in astonishment at the arrival of the haughty tyrant of Assyria (Isa. xiv. 18). The more elevated position of these sepulchres was in the rock—perched, as it were, among the high and seemingly inaccessible cliffs—of course the more notice and admiration they attracted, and the greater was thought to be the honour of having achieved so difficult an undertaking; and hence we discover the source of Shebna's vanity, which drew upon him in so pointed a manner the displeasure and rebuke of God (Isa. xxii. 16).

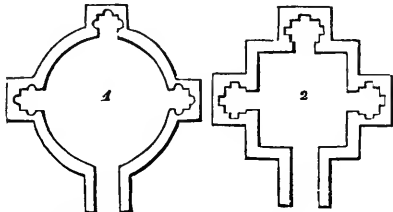

193. [Ground Plans of Sepulchres.]

contains two ground-plans showing the general character of the interior arrangements of the more extensive crypts. Some of those found near Tyre, and at Alexandria, are of the round form shown in fig. 1, but these seem exceptions; for the tombs at Jerusalem, in Asia Minor, and generally in Egypt and the East, offer the arrangement shown in fig. 2.

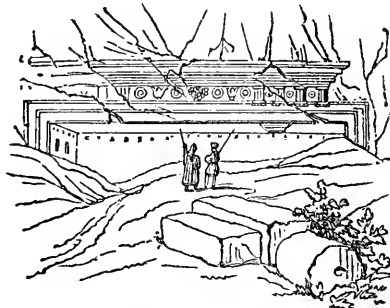

196. [Exterior of Tomb of the Kings.]

The mouth of the sepulchre was secured by a huge stone (Matt. xxvii. 60; John xi. 38). But the entrance-porch, to which the removal of this rude door gave admittance, was so large that several persons could stand in it and view the interior; and hence we read that the women who visited the sepulchre of our Lord, 'entering in, saw a young man sitting, clothed in a long white garment' (Mark xvi. 5); and in like manner, in reference to the flight of steps, that Peter 'stooping down, and looking in, saw the linen clothes lying' (John xx. 5). Some of the more splendid

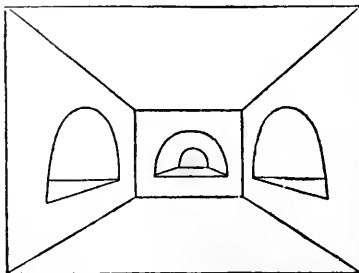

194. [Interior of Sepulchre at Tyre.]

The above cut (No. 194) is a chamber of one of the sepulchres situated near Tyre, with

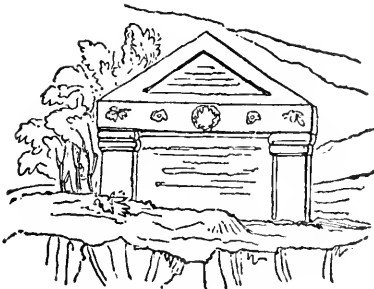

197. [Exterior of Sepulchre: Jerusalem.]

of these tombs, however, instead of the block of stone, have the porches surmounted with tasteful mason-work, and supported by well-finished colonnades; and as they stand open and exposed, do now, as they did formerly, afford retreats to numbers of vagrants and lawless characters. The rocky valleys around Jerusalem exhibit numberless specimens of these sepulchral excavations. Representations of two of these are here given. No. 196 shows the exterior of the so-called sepulchre of the Kings, the interior of which is represented in No. 192. The other (No. 197) is the exterior view of the sepulchre, the interior arrangements of which are shown in No. 195. An interesting account of this tomb is given by Dr. Wilde (*ut sup.*), by whom it was first examined and described, after it had been recently discovered by the Arabs.

Monuments of this elegant description were erected to many of the prophets and other holy men who figured as prominent characters in the early history of Israel, and it seems to have been considered, in the degenerate age of our Lord, an act of great piety to repair and ornament with fresh devices the sepulchres of those ancient worthies (Matt. xxiii. 29). The art and taste of the times would, of course, expend their chief resources in what was deemed the patriotic service of adding fresh beauty and attraction to edifices which contained such venerable and precious dust. But humbler tombs received also some measure of attention, all in the neighbourhood of Jerusalem being at certain seasons white-washed (Matt. xxiii. 27). The origin of this prevailing custom is to be traced not so much to a desire of rendering all such objects of interest in the environs of Jerusalem pleasing to the eye, as of making them easily discernible, and so preventing the risk of contracting ceremonial defilement through accident or ignorance, more especially at the annual festivals, when multitudes unacquainted with the localities resorted to the capital. To paint them with white was obviously the best preservative against the apprehended danger; and the season chosen for this garniture of the sepulchres was on the return of spring, a little before the Passover, when, the winter rains being over, a long unbroken tract of dry weather usually ensued. The words of Christ referred to were spoken but a few days before the Passover, when the fresh coating of white paint would be conspicuous on all the adjoining hills and valleys; and when we consider the striking contrast that must have been presented between the graceful architecture and carefully dressed appearance of

these tombs without, and the disgusting relics of mortality that were mouldering within, we cannot fail to perceive the emphatic energy of the language in which our Lord rebuked the *hypocrisy* of the Pharisees.

It remains only to notice that, during the first few weeks after a burial, members of a family, especially the females, paid frequent visits to the tomb. This affecting custom still continues in the East, as groups of women may be seen daily at the graves of their deceased relatives, strewing them with flowers, or pouring over them the tears of fond regret. And hence, in the interesting narrative of the raising of Lazarus, when Mary rose abruptly to meet Jesus, whose approach had been privately announced to her, it was natural for her assembled friends, who were ignorant of her motives, to suppose 'she was going to the grave to weep there' (John xi. 31).—R. J.



198. [Women at Tombs.]

BURNT-OFFERINGS (עֹלָה *olah*, from עָלָה *alah*, to ascend), sacrifices which owed their Hebrew name to the circumstance that the whole of the offering was to be consumed by fire upon the altar, and to rise, as it were, in smoke towards heaven: hence also the term כֹּלֵל (Deut. xxxiii. 10; 1 Sam. vii. 9; Ps. li. 21; comp. Judg. xx. 40); Chald. כֹּלֵלָא; Gr. *δολκαύτωμα*, *entire burnt-offering*, alluding to the fact that, with the exception of the skin, nothing of the sacrifice came to the share of the officiating priest or priests in the way of emolument, it being *wholly and entirely* consumed by fire.

Such burnt-offerings are among the most ancient, if not the earliest, on Scriptural record. We find them already in use in the patriarchal times; hence the opinion of some, that *Abel's* offering (Gen. iv. 4) was a burnt-offering as regarded the firstlings of his flock, while the pieces of fat which he offered was a thank-offering, just in the manner that Moses afterwards ordained, or rather confirmed from ancient custom (Lev. i. sq.). It was a burnt-offering that Noah offered to the Lord after the Deluge (Gen. viii. 20).

Originally and generally all offerings from the animal kingdom seem to have passed under the name of *olah*, since a portion at least of every sacrifice, of whatever kind—nay, that very portion which constituted the offering to God—was

consumed by fire upon the altar. In process of time, however, when the sacrifices became divided into numerous classes, a more limited sense was given to the term עֹלָה, it being solely applied to those sacrifices in which the priests did not share, and which were intended to propitiate the anger of Jehovah, for some particular transgression. Only oxen, male sheep or goats, or turtle-doves and young pigeons, all without blemish, were fit for burnt-offerings. The offerer, in person, was obliged to carry this sacrifice first of all into the fore-court, as far as the gate of the tabernacle or temple, where the animal was examined by the officiating priest to ascertain that it was without blemish. The offerer then laid his hand upon the victim, confessing his sins, and dedicated it as his sacrifice to propitiate the Almighty. The animal was then killed (which might be done by the offerer himself) towards the north of the altar (Lev. i. 11), in allusion, as the Talmud alleges, to the coming of inclement weather (typical of the Divine wrath) from the northern quarter of the heavens. After this began the ceremony of taking up the blood and sprinkling it around the altar, that is, upon the lower part of the altar, not immediately upon it, lest it should extinguish the fire thereon (Lev. iii. 2; Deut. xii. 27; 2 Chron. xxix. 22).

In the Talmud (Tract *Zebachim*, sect. i. ch. 1.) various laws are prescribed concerning this sprinkling of the blood of the burnt-offering: among others, that it should be performed about the middle of the altar, below the red line, and only twice, so as to form the figure of the Greek gamma; also, that the priest must first take his stand east of the altar, sprinkling in that position first to the east and then to the west; which done, he was to shift his position to the west, sprinkling again to the east and west, and lastly only round about the altar as prescribed in Lev. i. 5. The next act was the skinning or flaying of the animal, and the cutting of it into pieces, actions which the offerer himself was allowed to perform (Lev. i. 6). The skin alone belonged to the officiating priest (Lev. vii. 8). The dissection of the animal began with the head, legs, &c., and it was divided into twelve pieces. The priest then took the right shoulder, breast, and entrails, and placing them in the hands of the offerer, he put his own hands beneath those of the former, and thus waved the sacrifice up and down several times in acknowledgment of the all-powerful presence of God (Tract *Cholin*, i. 3). The officiating priest then retraced his steps to the altar, placed the wood upon it in the form of a cross, and lighted the fire. The entrails and legs being cleansed with water, the separated pieces* were placed together upon the altar in the form of a slain animal. Poor people were allowed to bring a turtle-dove or a young pigeon as a burnt-offering, these birds being very common and cheap in Palestine (Maimonides, *Moreh Nevochim*, iii. 46). With regard to these latter, nothing is said about the sex, whether they were to be males or females. The mode of killing

them was by nipping off the head with the nails of the hand.

Standing public burnt-offerings were those used daily morning and evening (Num. xxviii. 3; Exod. xxix. 38), and on the three great festivals (Lev. xxiii. 37; Num. xxviii. 11-27; xxix. 2-22; Lev. xvi. 3; comp. 2 Chron. xxxv. 12-16).

Private and occasional burnt-offerings were those brought by women rising from childbed (Lev. xii. 6); those brought by persons cured of leprosy (*ib.* xiv. 19-22); those brought by persons cleansed from issue (*ib.* xv. 11, *sq.*); and those brought by the Nazarites when rendered unclean by having come in contact with a dead body (Num. vi. 9), or after the days of their separation were fulfilled (*ib.* vi. 14).

Nor were the burnt-offerings confined to these cases alone; we find them in use almost on all important occasions, events, and solemnities, whether private or public, and often in very large numbers (comp. Judg. xx. 26; 1 Sam. vii. 9; 2 Chron. xxxi. 2; 1 Kings iii. 4; 1 Chron. xxix. 21; 2 Chron. xxix. 21; Ezra vi. 17; viii. 35). Heathens also were allowed to offer burnt-offerings in the temple, and Augustus gave orders to sacrifice for him every day in the temple at Jerusalem a burnt-offering, consisting of two lambs and one ox (Philo, *Opp.* ii. p. 592; Joseph. *De Bell. Jud.* ii. 17. 2).—E. M.

BUSHEL is used in the Auth. Vers. to express the Greek μῶδιος, Latin *modius*, a measure of about a peck.

BUTTER. [MILK.]

BUTZ. [Byssus.]

BUZ, son of Nahor and Milcah, and brother of Huz (Gen. xxii. 21). Elibu, one of Job's friends, who is distinguished as an Aramæan or Syrian (Job xxxii. 2), was doubtless descended from this Buz. Judgments are denounced upon the tribe of Buz by Jeremiah (xxv. 23); and from the context this tribe appears to have been located in Arabia Deserta; which may render it uncertain whether the descendants of Nahor's son are intended, although a migration south of the Euphrates is by no means unlikely, and had perhaps already occurred in the time of Elibu.

BYSSUS. The Greek word βύσσος occurs in Luke xvi. 19, where the rich man is described as being clothed in purple and *fine linen*; and also in Rev. xviii. 12, 16, and xix. 8, 14, among the merchandise, the loss of which would be mourned for by the merchants trading with the mystical Babylon. But it is by many authors still considered uncertain whether this byssus was of *flax* or *cotton*. Reference has been made to this article both from *bad* and *butz*, and might be also from *shesh*. For, as Rosenmüller says, 'The Hebrew word *shesh*, which occurs thirty times in the two first books of the Pentateuch (p. SHERER, and Celsius, ii. p. 259), is in these places, as well as in Prov. xxxi. 22, by the Greek Alexandrian translators, interpreted *byssus*, which denotes Egyptian cotton, and also the cotton cloth made from it. In the later writings of the Old Testament, as for example, in the Chronicles, the book of Esther, and Ezekiel, *buz* is commonly used instead of *shesh*, as an expression for cotton cloth.' This however seems to be inferred rather than proved, and it is just as likely that improved civilization may have introduced a substance such as cotton, which was unknown at the times when *shesh* was spoken of

* In Lev. i. 8 mention is made only of the *head* and the *fat*, but these comprised, no doubt, also the other pieces, the sacrifice being an עֹלָה, in which nothing was left to the priests.

and employed; in the same manner as we know that in Europe woollen, hempen, linen, and cotton clothes have, at one period of society, been more extensively worn than at another.

כַּבּ *bad* occurs in numerous passages of Scripture, as Exod. xxvii. 42, and xxix. 29; Lev. vi. 3; xvi. 4, 23, 32; 1 Sam. ii. 18; xxxii. 18; 2 Sam. vi. 14; 1 Chron. xv. 27; Ezek. ix. 2, 3, 11; x. 2, 6, 7; Dan. x. 5; xii. 7. In all these places the word *linen* is used in the Authorized Version, and Rosenmüller (*Botany of the Bible*, p. 175) says, 'The official garments of Hebrew, as well as of Egyptian priests, were made of linen, in Hebrew *bad*.' Celsius, however (ii. p. 509), states his opinion thus: 'Non fuit igitur כַּבּ vulgare linum, ut arbitrati sunt viri quidam doctissimi; sed linum Ægypti optimum et subtilissimum;' and he quotes (p. 510) Aben Ezra for its being the same thing as *butz*: '*Butz* idem est quod *bad*, nempe species lini in Ægypto.'

בּוּץ *butz* or *buz* occurs in 1 Chron. iv. 21; xv. 27; 2 Chron. ii. 14; iii. 14; v. 12; Esther i. 6; viii. 15; Ezek. xxvii. 16; and in these passages in the Authorized Version it is rendered *fine linen* and *white linen*. According to Celsius, '*Butz* idem est quod Græci *βύσσον* et Latini *byssum* adpellant;' while Rosenmüller, as above stated, considers *buz* and *byssum* to indicate cotton and the cloth made from it; as does Forster in his book *De Byssu Antiquorum*.

The mere similarity of name would not prove the correctness of either opinion, for they are not more like than are *قطن* *kootn*, and *کتان*

kutan, adduced by Rosenmüller (*Bibl. Bot.* p. 176), as the Arabic names of cotton, while in fact they indicate, the first cotton, and the second, flax. So at p. 179, the same author states that 'in the Sanscrit, *karpasum* denotes a linen cloth.' Now nothing is more certain than that the Sanscrit word indicates cotton, and cotton only, which was no doubt known to the Hebrews during a part at least of the time when the Scriptures were written. Mr. Harmer has justly observed that 'there were various sorts of linen cloth in the days of antiquity; for little copious as the Hebrew language is, there are no fewer than four different words, at least, which have been rendered "linen," or "fine linen," by our translators.' These words are, *bad*, *butz*, *pishet*, and *shesh*. To which may be added *carpas* or *karpas*, and as Dr. Harris suggests, *sadin* and *seethum*. But as it will be more satisfactory, in the midst of so many uncertainties, to proceed from the known to the unknown, and from a knowledge of things to the names by which they were in early times indicated, so it will be desirable in this work to treat of the different substances employed for clothing, under the heads of COTTON, FLAX, and HEMP, as well as under SILK and WOOL.—J. F. R.

C.

CAB, a measure mentioned in 2 Kings vi. 25. The Rabbins make it the sixth part of a *seah* or *satum*, and the eighteenth part of an ephah. In that case a cab contained 3½ pints of our wine measure, or 2½ pints of our corn measure.

CABBALAH. [KABBALAH]

CABUL (כַּבּוּל; Sept. Ὀπιον). A district given to Hiram, king of Tyre, by Solomon, in acknowledgment of the important services which he had rendered towards the building of the Temple (1 Kings ix. 13). Hiram was by no means pleased with the gift, and the district received the name of Cabul (*unpleasing*) from this circumstance. The situation of Cabul has been disputed; but we are content to accept the information of Josephus (*Antiq.* viii. 5. 3), who seems to place it in the north-west part of Galilee, adjacent to Tyre. In Galilee it is also placed by the Septuagint. There was a town named Cabul in the tribe of Zebulun (Josh. xix. 27), and as it was in Galilee, it is possible that it was one of the twenty towns consigned to Hiram, who, to mark his dissatisfaction, applied the significant name of this one town to the whole district. The cause of Hiram's dislike to what Solomon doubtless considered a liberal gift, is very uncertain. It has been conjectured (*Pictorial Bible*, note on 1 Kings ix. 13) that 'probably, as the Phœnicians were a maritime and commercial people, Hiram wished rather for a part of the coast, which was now in the hands of Solomon, and was not therefore prepared to approve of a district which might have been of considerable value in the eyes of an agricultural people like the Hebrews. Perhaps the towns were in part payment of what Solomon owed Hiram for his various services and contributions.'

CÆSAR, a name assumed by, or conferred upon, all the Roman emperors after Julius Cæsar. In this way it became a sort of title like Pharaoh, and, as such, is usually applied to the emperors in the New Testament, without their distinctive proper names (Augustus). The Cæsars mentioned in the New Testament are Augustus (Luke ii. 1); Tiberius (Luke iii. 1; xx. 22); Claudius (Acts xi. 28); Nero (Acts xxv. 8); Caligula, who succeeded Tiberius, is not mentioned.

CÆSAREA. There were two important towns in Palestine thus named in compliment to Roman emperors.

1. CÆSAREA PALESTINA, or Cæsarea of Palestine, so called to distinguish it from the other Cæsarea, or simply Cæsarea, without addition, from its eminence as the Roman metropolis of Palestine, and the residence of the procurator. It was built by Herod the Great, with much of beauty and convenience, twenty-two years before the birth of Christ, on a spot where had formerly stood a tower called Straton's Tower.

The whole coast of Palestine may be said to be extremely inhospitable, exposed as it is to the fury of the western storms, with no natural port affording adequate shelter to the vessels resorting to it. To remedy this defect, Herod, who, though an arbitrary tyrant, did much for the improvement of Judæa, set about erecting, at immense cost and labour, one of the most stupendous works of antiquity. He threw out a semicircular mole, which protected the port of Cæsarea on the south and west, leaving only a sufficient opening for vessels to enter from the north; so that, within the enclosed space, a fleet might ride at all weathers in perfect security. The mole was constructed of immense blocks of stone brought from a great distance, and sunk to the depth of 20 fathoms in the sea. The best idea of the work may perhaps be realized,

by comparing it as to design and execution with the Breakwater at Plymouth. Besides this, Herod added many splendid buildings to the city : among which was a temple, dedicated to Cæsar, a theatre, and an amphitheatre ; and when the whole was finished, which was within twelve years from the commencement of the undertaking, he fixed his residence there, and thus elevated the city to the rank of the civil and military capital of Judæa, which rank it continued to enjoy as long as the country remained a province of the Roman empire (Joseph. *Antiq.* xv. 9. &c. See Dr. Mansford, *Script. Gazetteer*). Vespasian raised Cæsaræa to the rank of a Roman colony, granting it first, exemption from the capitation tax, and afterwards, from the ground taxes (the real *jus Italicum*, see COLONY). The place was, however, inhabited chiefly by Gentiles, though some thousands of Jews lived in it (Joseph. *De Bell. Jud.* iii. 9. 1 ; iii. 14 ; *Antiq.* xx. 8. 7 ; *Vita*, 11).

Cæsaræa is the scene of several interesting circumstances described in the New Testament, such as the conversion of Cornelius, the first-fruits of the Gentiles (Acts x) ; the residence of Philip the Evangelist (Acts xxi. 8) ; the journey thither of St. Paul ; his pleading there before Felix ; his imprisonment for two years ; and his final pleading before Festus and King Agrippa (Acts xxiv.). It was here also, in the amphitheatre built by his father, that Herod Agrippa was smitten of God, and died (Acts xii. 21-23).

It seems there was a standing dispute between the Jewish and Gentile inhabitants of Cæsaræa, to which of them the city really belonged. The former claimed it as having been built by a Jew, meaning King Herod ; the latter admitted this, but contended that he built it for them and not for Jews, seeing that he had filled it with statues and temples of their gods, which the latter abominated (Joseph. *De Bell. Jud.* ii. 13. 7). This quarrel sometimes came to blows, and eventually,

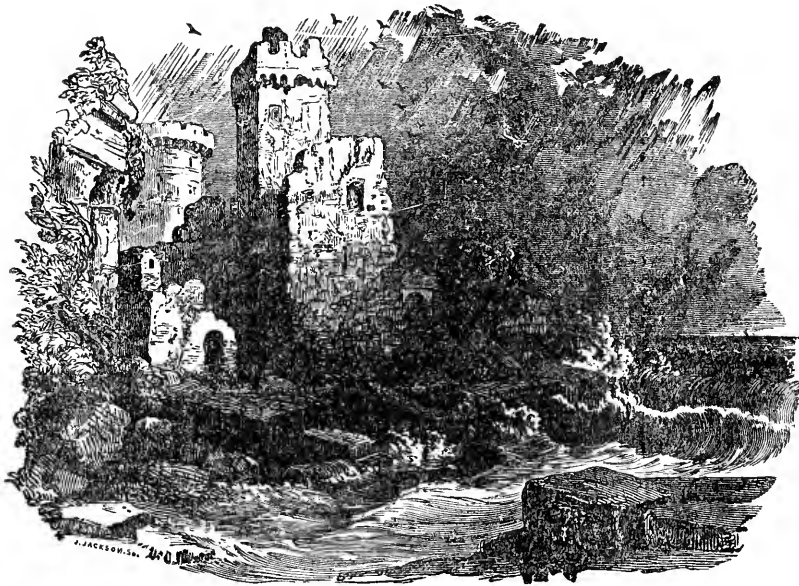

199. [Cæsaræa.]

the matter was referred to the emperor Nero, whose decision in favour of the Gentiles, and the behaviour of the latter thereupon, gave deep offence to the Jews generally, and afforded occasion for the first outbreaks, which led to the war with the Romans (Joseph. *De Bell. Jud.* ii. 14). One of the first acts of that war was the massacre of all the Jewish inhabitants by the Gentiles, to the number of 20 000 (Joseph. *u. s.* ii. 18. 1.).

In later times, Cæsaræa is chiefly noted as the birth-place and episcopate of Eusebius, the celebrated Church historian, in the beginning of the 4th century.

Cæsaræa is almost thirty-five miles north of Joppa or Jaffa, and fifty-five miles from Jerusalem. It still retains the ancient name in the form of Kaiseraiih ; but has long been desolate. The most conspicuous ruin is that of an old castle, at

the extremity of the ancient mole (see the engraving). A great extent of ground is covered by the remains of the city. A low wall of grey-stone encompasses these ruins, and without this is a moat now dry. Between the accumulation of rubbish and the growth of long grass, it is difficult to define the form and nature of the various ruins thus enclosed. Nevertheless, the remains of two aqueducts, running north and south, are still visible. The one next the sea is carried on high arches ; the lower one, to the eastward, carries its waters along a low wall, in an arched channel, five or six feet wide. The water is abundant and of excellent quality ; and the small vessels of the country often put in here to take in their supplies. Cæsaræa is, apparently, never frequented for any other purpose ; even the high-road leaves it wide ; and it has been visited

by very few of the numerous travellers in Palestine. The present tenants of the ruins are snakes, scorpions, lizards, wild boars, and jackals (George Robinson, *Travels*, ii. pp. 189, 191; see also D'Arvieux, Clarke, Buckingham, Joliffe, and Monro).

2. CÆSAREA PHILIPPI. Towards the springs of the Jordan, and near the foot of Isbel Shrik, or the Prince's Mount, a lofty branch of Lebanon, forming in that direction the boundary between Palestine and Syria Proper, stands a city originally called Baniās, which has erroneously been considered by many to be the Laish captured by the Danites, and by them called Dan (Judg. xviii. 7-29). But it appears, from the testimony of both Eusebius and Jerome, that they were then separate and distinct cities, situated at the distance of four miles from each other. This city, which was in later times much enlarged and beautified by Philip the tetrarch, who called it Cæsarea in honour of Tiberius the emperor, adding the cognomen of Philippi to distinguish it from Cæsarea of Palestine, lay about 120 miles north from Jerusalem, and a day and a half's journey from Damascus (Matt. xvi. 13; Mark viii. 27). Herod Agrippa also bestowed upon it a considerable share of attention, still further extending and embellishing it. In compliment to the emperor Nero, its name was afterwards changed to Neronias; and Titus, after the overthrow of Jerusalem, exhibited some public games here, in which the Jewish prisoners were compelled to fight like gladiators, and numbers perished in the inhuman contests. Under the Christians it was erected into a bishopric of Phœnicia. 'During the Crusades,' says Dr. Robinson, 'it was the scene of various changes and conflicts. It first came into the possession of the Christians in 1129, along with the fortress on the adjacent mountain, being delivered over to them by its Israelite governor, after their unsuccessful attempt upon Damascus in behalf of that sect. It has now resumed its original name of Baniās, which is the Arabic pronunciation of the Paneas of the Greeks and Romans. The city and castle were given as a fief to the Knight Rayner Brus. In 1132, during the absence of Rayner, Baniās was taken, after a short assault, by the Sultan Ismail of Damascus. It was recaptured by the Franks, aided by the Damascenes themselves. In 1139, the temporal control was restored to Rayner Brus; and the city made a Latin bishopric, under the jurisdiction of the archbishop of Tyre (*Researches in Palestine*, vol. iii. p. 360). Baniās has now dwindled into a paltry and insignificant village, whose mean and destitute condition contrasts strikingly with the rich and luxuriant character of the surrounding country. It is said that many remains of ancient architecture are found in the neighbourhood, bearing testimony to the former grandeur of the place, although it is difficult to trace the site of the splendid temple erected here in honour of Augustus. The ruins of the castle of Baniās, which appears to have been a work of the Saracens, crown the summit of the adjoining mountain, and display a wall 10 feet in thickness, by which the fortress was defended. The ruins of another fortified castle are visible on the south of the village, and a substantial bridge which conducts to it, inscribed with an Arabic legend, its date being of the age of the Crusades.—R. J.

CAIN. The derivation of this word is disputed. Most writers trace it to קָנָה, *an acquisition* or *possession*, but some derive it from a verb signifying *to lament*, and others from a verb of similar sound, signifying *to envy*. Both Eusebius and Chrysostom seem to support the last interpretation; but the best Hebrew authorities are on the side of that first named.

Abounding as the Scriptures do with proofs of human guilt, and filled yet more as are the secular annals of the world with instances of crime, none impress the mind with a stronger feeling of horror than that of Cain. It is easy to understand how the passion of envy or jealousy wrought in the heart of the offender; but some degree of mystery attends the immediate origin of his crime. Abel, it appears, brought two offerings, the one an oblation, the other a sacrifice. Cain brought but the former—a mere acknowledgment, it is supposed, of the sovereignty of God; neglecting to offer the sacrifice which would have been a confession of fallen nature, and, typically, an atonement for sin. It was not, therefore, the mere difference of feeling with which the two offerings were brought which constituted the virtue of the one, or the guilt of the other brother. God's righteous indignation against sin had been plainly revealed, and there can be no doubt that the means of safety, of reconciliation and atonement, were as plainly made known to Adam and his offspring. The refusal, therefore, of the sacrifice was a virtual denial of God's right to condemn the sinner, and at the same time a proud rejection of the proffered means of grace.

The punishment which attended the crime was such as could only be inflicted by an Almighty avenger. It admitted of no escape, scarcely of any conceivable alleviation. Cursed from the earth himself, the earth was doomed to a double barrenness wherever the offender should set his foot. Not like his father, sentenced merely to gather his food from the unwilling ground, bearing herbs, though thorns sprung up along with them, for him it was not to yield its strength; it was to be as without life beneath him. Physical want and hardship, therefore, were among the first of the miseries heaped upon his head. Next came those of mind and conscience: 'The voice of thy brother's blood crieth unto me from the ground,' was the announcement of his discovered guilt. He could now hear that same voice himself; nor did any retreat remain to him from the terrors of his own soul or those of Divine vengeance: 'From thy face shall I be hid,' was his agonizing cry, even when trembling at the voice of his judge; no hope, as he knew and thus confessed, continuing to exist for him who was utterly cut off from communion with God. By the statement that 'Cain went out from the presence of the Lord,' probability is given to the conjecture which represents him as abiding, till thus exiled, in some favoured spot where the Almighty still, by visible signs, manifested himself to his fallen creatures. The expression of dread lest, as he wandered over the face of the earth, he might be recognised and slain, has an awful sound when falling from the mouth of a murderer. But he was to be protected against the wrath of his fellow-men; and of this God gave him assurance, not, says Shuckford, by setting a mark upon him, which is a false translation, but by appointing a sign or token which he

himself might understand as a proof that he should not perish by the hand of another, as Abel had perished by his.

What was the Divine purpose in affording him this protection it is difficult to determine. That it was not with the intention of prolonging his misery may be conjectured from the fact, that it was granted in answer to his own piteous cry for mercy. Some writers have spoken of the possibility of his becoming a true penitent, and of his having at length, after many long years of suffering, obtained the Divine forgiveness. It must be confessed that this affords the easiest solution of some difficulties in the circumstance alluded to; nor ought we, in any way, peremptorily to conclude that such repentance was impossible, when both our blessed Lord and St. Stephen, and a whole host of martyrs, did not refuse to pray for their murderers, assuredly intimating thereby that no irrevocable sentence had, as yet, been passed upon them.

It may be worthy of observation, that especial mention is made of the fact, that Cain having travelled into the land of Nod there built a city; and further, that his descendants were chiefly celebrated for their skill in the arts of social life. In both accounts may probably be discovered the powerful struggles with which Cain strove to overcome the difficulties which attended his position as one to whom the tillage of the ground was virtually prohibited.—H. S.

CAINAN (כַּיִן, *possessor*; Sept. *Καϊνάν*).

1. Son of Enos, and father of Mahaleel (Gen. v. 9; 1 Chron. i. 2). 2. Son of Arphaxad, the son of Shem, and father of Salah. His name is wanting in the present copies of the Hebrew Scriptures; but is found in the Septuagint version of Gen. x. 24; xi. 12, and in Luke iii. 36. As the addition of his generation of 130 years in the series of names is of great chronological importance, and is one of the circumstances which render the Septuagint computation of time longer than the Hebrew, this matter has engaged much attention, and has led to great discussion among chronologers. Some have suggested that the Jews purposely excluded the second Cainan from their copies, with the design of rendering the Septuagint and Luke suspected; others, that Moses omitted Cainan, being desirous of reckoning ten generations only from Adam to Noah, and from Noah to Abraham. Some suppose that Arphaxad was father of Cainan and Salah, of Salah naturally, and of Cainan legally; while others allege that Cainan and Salah were the same person, under two names. It is believed by many, however, that the name of this second Cainan was not originally in the text of Luke, but is an addition of inadvertent transcribers, who, remarking it in some copies of the Septuagint, added it (Kuinoël, *ad Luc. iii. 36*). Upon the whole, the balance of critical opinion is in favour of the rejection of this second Cainan. Even Hales, though, as an advocate of the longer chronology, predisposed to its retention, decides that we are fully warranted to conclude that the second Cainan was not, originally, in the Hebrew text, and the Septuagint versions derived from it. And since water cannot rise to a level higher than that of the spring from which it issues, so neither can the

authority of the New Testament for its retention, rise higher than that of the Old Testament, from which it is professedly copied, for its exclusion (*Chronology*, i. p. 291). Some of the grounds for this conclusion are—1. That the Hebrew and Samaritan, with all the ancient versions and targums, concur in the omission; 2. That the Septuagint is not consistent with itself; for in the repetition of genealogies in 1 Chron. i. 24, it omits Cainan and agrees with the Hebrew text; 3. That the second Cainan is silently rejected by Josephus, by Philo, by John of Antioch, and by Eusebius; and that, while Origen retained the name itself, he, in his copy of the Septuagint, marked it with an obelisk as an unauthorized reading.

CAIAPHAS (Καϊάφας), called by Josephus (*Antiq. xviii. § 2*) Joseph Caiaphas, was high-priest of the Jews in the reign of Tiberius Caesar (Luke iii. 2). We learn from Josephus that he succeeded Simon the son of Camith (about A.D. 27 or 28), and held the office nine years, when he was deposed. His wife was the daughter of Annas, or Ananus, who had formerly been high-priest, and who still possessed great influence and control in sacerdotal matters, several of his family successively holding the high-priesthood. The names of Annas and Caiaphas are coupled by Luke—Annas and Caiaphas being the high-priests; and this has given occasion to no small amount of discussion. Some maintain that Annas and Caiaphas then discharged the functions of the high-priesthood by turns; but this is not reconcilable with the statement of Josephus. Others think that Caiaphas is called high-priest, because he then actually exercised the functions of the office, and that Annas is so called because he had formerly filled the situation. But it does not thus appear, why of those who had before Caiaphas held the high-priesthood, Annas in particular should be named, and not Ismael, Eliazer, or Simon, who had all served the office more recently than Annas. Hence, Kuinoël and others consider it as the more probable opinion, that Caiaphas was the high-priest, but that Annas was his vicar or deputy, called in the Hebrew, *יָד סָגָן* *sagan*. Nor can that office be thought unworthy of a man who had filled the pontifical office, since the dignity of *sagan* was also great. Thus, for instance, on urgent occasions he might even enter the Holy of Holies (Lightfoot, *Hor. Heb. ad Luc. iii. 2*). Nor ought it to seem strange or unusual that the vicar of a high-priest should be called by that name. For if, as it appears, those who had once held the office were ever after, by courtesy, called high-priests, with greater justice might Annas, who was both a pontifical person and high-priest's vicar, be so called. In fact, the very appellation of high-priest is given to a *sagan* by Josephus (*Antiq. xvii. 6, 4*). See the commentators on Luke iii. 2; particularly Hammond, Lightfoot, Kuinoël, and Bloomfield. Caiaphas is the high-priest who rent his clothes, and declared Jesus to be worthy of death. When Judas had betrayed him, our Lord was first taken to Annas, who sent him to Caiaphas (John xviii. 13), who perhaps abode in another part of the same palace. What became of Caiaphas after his deposition in A.D. 38, is not known.

CAKES (BREAD).

CALAH (כַּלָּח; Sept. Καλαχ), or rather **CALACH**, a city of Assyria, built by Ashur or Nimrod (the phrase in Gen. x. 11, 12, being ambiguous). It was at some distance from Nineveh, the City of Resen lying between them. Most writers concur in placing it on the Great Zab (the ancient Lycus) not far from its junction with the Tigris, and Resen is placed higher up on the same river, so as to be between it and Nineveh. There appears to be a trace of this name in Calachene, which Strabo describes as a province of Assyria, lying between the source of the Lycus and the Tigris. Many suppose that this Calah is the same as the Chalach (*Auth. Vers.* Halah) in 1 Kings xviii. 6; xvii. 11, whither Salmanassar transplanted a colony of Israelites; but there are good reasons assigned under another head (*Halah*) for disputing this conjecture.

CALEB (כִּלְבֵּי, *dog*; Sept. Χάλεβ), son of Jephunneh, of the tribe of Judah. He was sent with Joshua and others to explore the land of Canaan, and in consequence of his joining with Joshua in opposing the discouraging accounts brought back by the other spies, they were both specially exempted from the decree of death which was pronounced on the generation to which they belonged (Num. xiii. 6; xiv. 6, 24, 38). When the land of Canaan had been invaded and partly conquered, Caleb was privileged to choose Kirjath-arba, or Hebron, and its neighbourhood, for his possession (Josh. xiv. 6-15). He accordingly went and wrested it from the native inhabitants, and thence proceeded to Debir, which was taken for him by his nephew Othniel, who, as his reward, received in marriage the hand of Caleb's daughter [**ACHISAPH**], with a valuable dower (Josh. xv. 13-19). Caleb is usually supposed to have outlived Joshua.

CALF (בָּקָר) is mentioned in several places, but, not requiring a zoological explanation, it

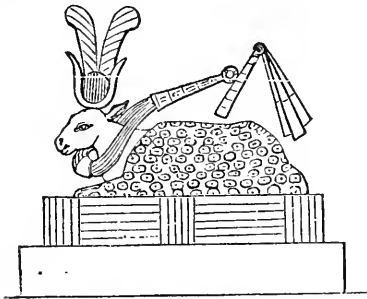

200. [Egyptian Calf-Idol.]

may be sufficient to make a few remarks on the worship of calves and other superstitious practices connected with them. The most ancient and remarkable notice in the Scriptures on this head, is that of the golden calf which was cast by Aaron from the earrings of the people, while the Israelites were encamped at the foot of Sinai and Moses was absent on the Mount. The next notice refers to an event which occurred ages after, when Jeroboam, king of Israel, set up two idols in the form of a calf, the one in Dan and the other in Bethel. This almost incomprehensible

degradation of human reason was, more particularly in the first instance, no doubt the result of the debasing influences which operated on the minds of the Israelites during their sojourn in Egypt, where, amid the daily practice of the most degrading and revolting religious ceremonies, they were accustomed to see the image of a sacred calf, surrounded by other symbols, carried in solemn pomp at the head of marching armies; such as may be still seen depicted in the processions of Rameses the Great or Sesostris. The preceding figure is a representation of a calf-idol which the present writer copied from the original collection made by the artists of the French Institute of Cairo. It is recumbent, with human eyes, the skin flesh-coloured, and the whole afterwards covered with a white and sky-blue diapered drapery: the horns are not on the head, but above it, and contain within them the symbolical globe surmounted by two feathers. Upon the neck is a blue and yellow yoke, and the flagellum, of various colours, is suspended over the back: the whole is fixed upon a broad stand for carrying, as here shown. The rendering of the *Auth. Vers.*, which alludes to the image being finished with a graving tool, is obviously correct, for all the lines and toolings of the covering cloth, of the eyes, and of the feathers, must have required that manual operation (Exod. xxxii. 4). It is doubtful whether this idolatrous form is either Apis or Mnevis; it may perhaps represent the sun's first entrance into Taurus, or more probably be a symbol known to the Egyptians by an undeciphered designation, and certainly understood by the Edomites of later ages, who called it *bahumed* and *kharuf*, or the calf, the mysterious *anima mundi*: according to Von Hammer (*Pref. to Ancient Alphabets*), the Nabathæan secret of secrets, or the beginning and return of everything. With the emblems on the back, it may have symbolized the plural Elohim, long before the cabbalistical additions of this mysterious type had changed the figure. At the time of the departure of the Israelites from Egypt this may have been the Moloch of their neighbours, for that idol was figured with the head of a calf or steer. A similar divinity belonged to the earliest Indian, Greek, and even Scandinavian mythologies; and therefore it may be conceived that the symbol, enduring even to this day, was at that period generally understood by the multitude, and consequently that it was afterwards revived by Jeroboam without popular opposition. Egyptian paintings illustrate the contempt which the prophet Hosea (x. 5) casts upon the practice of those whom he designates as '*coming to sacrifice and kiss the calves*,' and commentators have been at pains to explain in what manner Moses reduced the golden calf to such a state as to make it potable in water; but surely as the science of making gold-leaf for gilding was already practised in Egypt, there could be no difficulty, even if chemical processes had not then been discovered, in effecting the object. With regard to Jer. xxxiv. 18, 19, it may be sufficient to mention that many nations of antiquity had a practice of binding themselves to certain resolutions by the ceremony of cutting a calf or other victim into two halves or sides, laying them on the ground, and passing between the severed parts. This was considered as constituting a peculiarly binding obligation (comp. Gen. xv. 10, 17).—C. II. S.

CALNEH (כַּלְנֵי; Sept. *Χαλάνη*), or rather **CHALNEH**, the fourth of Nimrod's cities (Gen. x. 10), and probably not different from the Calno of Isa. x. 9, or the Canneh of Ezek. xxvii. 23. According to the Chaldee translation, with which Eusebius and Jerome agree, this is the same place that was subsequently called Ctesiphon. It lay on the Tigris, opposite Seleucia, and was for a time the capital of the Parthians. This ancient opinion respecting Chalneh is rendered probable by the circumstance that the district named Ctesiphon was called by the Greeks Chalonenitis (Pliny, *Hist. Nat.* vi. 26, 27; Polyb. v. 44). Ammianus Marcellinus (xxiii. 6. 23) states that it was the Persian king Pacorus (who reigned from A.D. 71 to 107) who changed the name of the city to Ctesiphon; but that name must have been more ancient, as it is mentioned by Polybius. In the time of the prophet Amos, Cal-

neh appears to have constituted an independent principality (Amos vi. 1, 2); but not long after it became, with the rest of Western Asia, a prey to the Assyrians (Isa. x. 9). About 150 years later, Calneh was still a considerable town, as may be inferred from its being mentioned by Ezekiel (xxvii. 23) among the places which traded with Tyre. The site of Ctesiphon, or Calneh, was afterwards occupied by El-Madain, *i. e.* the (two) cities, of which the only remains are the ruins of a remarkable palace called Tauk-kesra, some mounds of rubbish, and a considerable extent of massive wall towards the river. The ruined palace, with its broken arch, although it stands on low ground, is a most conspicuous object, and is seen at a considerable distance, in ascending the river, in varied and striking points of view, in consequence of the serpentine course of the stream in this part.

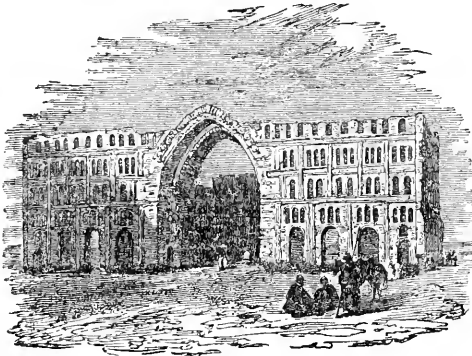

201. [Tauk-kesra.]

CALVARY, the place where Christ was crucified. In three of the Gospels the Hebrew name of the place, **GOLGOTHA** (*place of a skull*), is given; and in Luke (xxiii. 33), where we find Calvary in the Authorized Version, the original is not Calvary, but Cranion (*κρανιον*), a diminutive of *κρανον* (*a skull*). Calvaria is the Latin translation of this word, adopted by the Vulgate, from which it found its way into our version. But as the names *Cranion* and *Calvaria* are respectively Greek and Latin translations of the original Gulgatha, which occurs in three out of the four Gospels, the plan of this work requires that the various particulars connected with the site of the Crucifixion should be referred to **GOLGOTHA**.

CAMBYSES. [AHASUERUS.]

CAMEL (גַּמַּל *gamal* in Hebrew and Syriac, *gamala* in Chaldaic, *jemel* in ancient Arabic, *djammel* in modern, and *καμηλος* in Greek). These are the principal names in Eastern history of the genus *Camelus*, as constituted by modern naturalists. In this arrangement it comprises two species positively distinct, but still possessing the common characters of being ruminants without horns, without muzzle, with nostrils forming oblique slits, the upper lip divided, and separately movable and extensible, the soles of the feet horny, with two toes covered by unguiticulated claws, the limbs long, the abdomen drawn up, and the neck, long and slender, is bent down and up, the

reverse of that of a horse, which is arched. Camels have thirty-six teeth in all, whereof three cuspidate on each side above, six incisors, and two cuspidate on each side below, which, though differently named, still have all more or less the character of tusks. They have callosities on the breast-bone and on the flexures of the joints. Of the four stomachs, which they have in common with other animals chewing the cud, the ventriculus, or paunch, is provided with membranous cells to contain an extra provision of water, enabling the species to subsist for four or more days without drinking. But when in the desert, the camel has the faculty of smelling it afar off, and then, breaking through all control, he rushes onwards to drink, stirring the element previously with a fore-foot, until quite muddy. Camels are temperate animals, being fed on a march only once in twenty-four hours, with about a pound weight of dates, beans, or barley, and are enabled in the wilderness, by means of their long flexible necks and strong cuspidate teeth, to snap as they pass at thistles and thorny plants, mimosas and caper-trees. They are emphatically called the ships of the desert; having to cross regions where no vegetation whatever is met with, and where they could not be enabled to continue their march but for the aid of the double or single hunch on the back, which, being composed of muscular fibre, and cellular substance highly adapted for the accumulation of fat, swells in proportion as the animal is healthy and well fed, or sinks by absorption as it

supplies the want of sustenance under fatigue and scarcity; thus giving an extra stock of food without eating, till by exhaustion the skin of the prominences, instead of standing up, falls over, and hangs like empty bags on the side of the dorsal ridge. Now, when to these endowments are added a lofty stature and great agility; eyes that discover minute objects at a distance; a sense of smelling of prodigious acuteness—ever kept in a state of sensibility by the animal's power of closing the nostrils to exclude the acrid particles of the sandy deserts; a spirit, moreover, of patience, not the result of fear, but of forbearance, carried to the length of self-sacrifice in the practice of obedience, so often exemplified by the camel's bones in great numbers strewing the surface of the desert; when we perceive it furnished with a dense wool, to avert the solar heat and nightly cold, while on the animal, and to clothe and lodge his master when manufactured, and know that the female carries milk to feed him,—we have one of the most incontrovertible examples of Almighty power and beneficence in the adaptation of means to a direct purpose, that can well be submitted to the apprehension of man; for, without the existence of the camel, immense portions of the surface of the earth would be uninhabitable, and even impassable. Surely the Arabs are right, 'Job's beast is a monument of God's mercy!' The two species are—1. The Bactrian camel (*camelus Bactrianus* of authors) is large and robust; naturally with two hunches, and originally a native of the highest table-lands of Central Asia, where even now, wild individuals

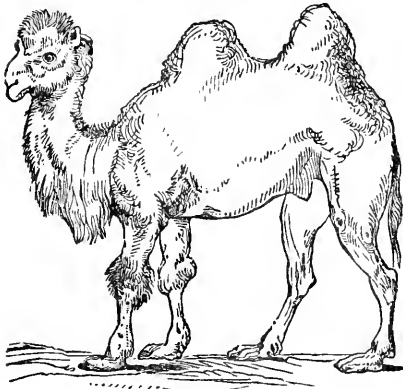

202. [Bactrian Camel.]

may be found. The species extends through China, Tartary, and Russia, and is principally imported across the mountains into Asia Minor, Syria, and Persia. One appears figured in the processions of the ancient Persian satrapies among the bas-reliefs of *Chehel Minar*, where the Arabian species is not seen. It is also this species which, according to the researches of Burckhardt, constitutes the brown Taous variety of single-hunched Turkish or Tootkee camels commonly seen at Constantinople, there being a very ancient practice among breeders, not, it appears, attended with danger, of extirpating with a knife the foremost hunch of the animal soon after birth, thereby procuring more space for the packsaddle and load. It seems that this mode of rendering the Bactrian cross-breed

similar to the Arabian camel or dromedary (for Burckhardt misapplies the last name), is one of the principal causes of the confusion and contradictions which occur in the descriptions of the two species, and that the various other intermixtures of races in Asia Minor and Syria, having for their object either to create greater powers of endurance of cold or of heat, of body to carry weight, or to move with speed, have still more perplexed the question. From these causes a variety of names have arisen, which, when added to the Arabian distinctions for each sex, and for the young during every year of its growth, and even for the camels nursing horse-foals, the appellatives become exceedingly numerous. We notice only—

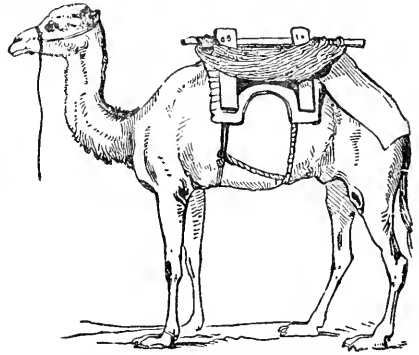

203. [Arabian Camel: baggage.]

2. The Arabian camel or dromedary (*camelus dromedarius* or *Arabicus* of naturalists, בָּכָר, *bacar*; and female and young בָּכָרָה, *Isa. lx. 6*; *Jer. ii. 23*) is properly the species having naturally but one hunch, and considered as of Western-Asiatic or of African origin, although no kind of camel is figured on any monument of Egypt, not even where there are representations of live stock such as that found in a most ancient tomb beneath the pyramid of Gizeh; which shows herdsmen bringing their cattle and domesticated animals to be numbered before a steward and his scribe; and in which we see oxen, goats, sheep, asses, geese, and ducks, but neither horses nor camels. That they were not indigenous in the early history of Egypt is countenanced by the mythical tale of the priests describing 'the flight of Typhon, seven days' journey upon an ass.' We find, however, camels mentioned in *Genesis xii.*; but being placed last among the cattle given by Pharaoh to Abraham, the fact seems to show that they were not considered as the most important part of his donation. This can be true only upon the supposition that only a few of these animals were delivered to him, and therefore that they were still rare in the valley of the Nile; though soon after there is abundant evidence of the nations of Syria and Palestine having whole herds of them fully domesticated. These seem to imply that the genus *Camelus* was originally an inhabitant of the elevated deserts of Central Asia, its dense fur showing that a cold but dry atmosphere was to be encountered, and that it came already domesticated, towards the south and west, with the oldest colonies of mountaineers who are to be distinguished from earlier tribes who subdued the ass, and perhaps from others still more an

erent, who, taking to the rivers, descended by water, and afterwards coasted and crossed narrow seas.

Of the Arabian species two very distinct races are noticed; those of stronger frame but slower pace used to carry burdens, varying from 500 to 700 weight, and travelling little more than twenty-four miles per day; and those of lighter form bred for the saddle with single riders, whereof the fleetest serve to convey intelligence, &c., and travel at the rate of 200 miles in twenty-four hours. They are designated by several appellations, such as Deloul, the best coming

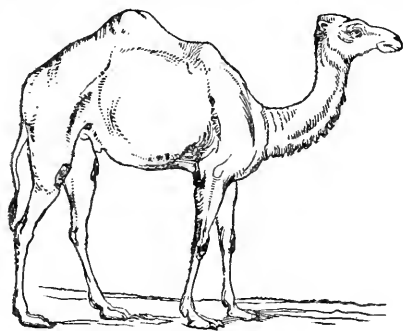

204. [Arabian Camel: saddle.]

from Oman, or from the Bishareens in Upper Egypt; also Hadjeens, Ashaary, Maherry, Rechcs, Badeses at Herat, Rawahel, and Racabel in India, all names more or less implying swiftness, the same as *δρομάς*, *swift*. Caravans of loaded camels have always scouts and flankers mounted on these light animals, and in earlier ages, Cyrus and others employed them in the line of battle, each carrying two archers. The Romans of the third and fourth centuries of our era, as appears from the *Notitia*, maintained in Egypt and Palestine several *ale* or squadrons, mounted on dromedaries; probably the wars of Belisarius with the northern Africans had shown their importance in protecting the provinces bordering on the desert; such was the *ale dromedariorum Antonia* at *Amata* in the tribe of Judah, and three others in the Thebais. Buonaparte formed a similar corps, and in China and India the native princes and the East India Company have them also.

All camels, from their very birth, are taught to bend their limbs and lie down to receive a load or a rider. They are often placed circularly in a recumbent posture, and together with their loads form a sufficient rampart of defence against robbers on horseback. The milk of she-camels is still considered a very nutritive cooling drink, and when turned it becomes intoxicating. Their dung supplies fuel in the desert, and in sandy regions where wood is scarce; and occasionally it is a kind of resource for horses when other food is wanting in the wilderness. Their flesh, particularly the hunch, is in request among the Arabs, but was forbidden to the Hebrews, more perhaps from motives of economy, and to keep the people from again becoming wanderers, than from any real uncleanness.

Camels were early a source of riches to the patriarchs, and from that period became an increasing object of rural importance to the several tribes

of Israel, who inhabited the grazing and border districts, but still they never equalled the numbers possessed by the Arabs of the desert. In what manner the Hebrews derived the valuable remunerations obtainable from them does not directly appear, but it may be surmised that by means of their camels they were in possession of the whole trade that passed by land from Asia Minor and Syria to the Red Sea and Egypt; and from the Red Sea and Arabia towards the north, and to the Phœnician sea-ports. On swift dromedaries the trotting motion is so hard that to endure it the rider requires a severe apprenticeship; but riding upon slow camels is not disagreeable, on account of the measured step of their walk; ladies and women in general are conveyed upon them in a kind of wickerwork sedan, known as the *takht-ravan* of India and Persia. Those which carried the king's servants or guests, according to Philostratus, were always distinguished by a gilded boss on the forehead.

It is likely the word *אחשתרנים* *achashteranim* (Esth. viii. 10), rendered 'young dromedaries' (though Bochart regards it as meaning mules), implies the swift postage or conveyance of orders, the whole verse showing that all the means of dispatch were set in motion at the disposal of government. With regard to the passage in Matt. xix. 24, 'It is easier for a camel to go through the eye of a needle,' &c., and that in Matt. xxiii. 24, 'Ye strain at a gnat, and swallow a camel,' it may be sufficient to observe, that both are proverbial expressions, similarly applied in the kindred languages of Asia.—C. H. S.

CAMPHIRE. [COPHER.]

CANA (*Kavā*), a town in Galilee, not far from Capernaum, where Christ performed his first miracle by turning water into wine (John iv. 46). This Cana is not named in the Old Testament, but is mentioned by Josephus as a village of Galilee (*Vita*, § 16, 64; *De Bell. Jud.* i. 17. 5). The site has long been identified with the present Kefr Kenna, a small place about four miles north-east from Nazareth, on one of the roads to Tiberias. It is a neat village, pleasantly situated on the descent of a hill looking to the south-west, and surrounded by plantations of olive and other fruit trees. There is a large spring in the neighbourhood, enclosed by a wall, which, if this be the Cana of the New Testament, is doubtless that from which water was drawn at the time of our Lord's visit. It is also observable that water-pots of compact limestone are still used in this neighbourhood, and some old ones are, as might be expected, shown as those which once contained the miraculous wine. Here are also the remains of a Greek church, and of a house said to be that of Nathaniel, who was a native of Cana (John ii. 1-11). The view which we give is that of the traditional Cana.

There is a ruined place called *Kāna el-Jelil*, about eight miles N. $\frac{1}{2}$ E. from Nazareth, which Dr. Robinson is inclined to regard as the more probable site of Cana. His reasons, which are certainly of considerable weight, may be seen in *Biblical Researches*, iii. 204-208. Descriptions of Kefr Kenna may be found in Pococke, Burckhardt, Clarke, G. Robinson (*Travels*), Richardson, Monro, Schubert, &c.

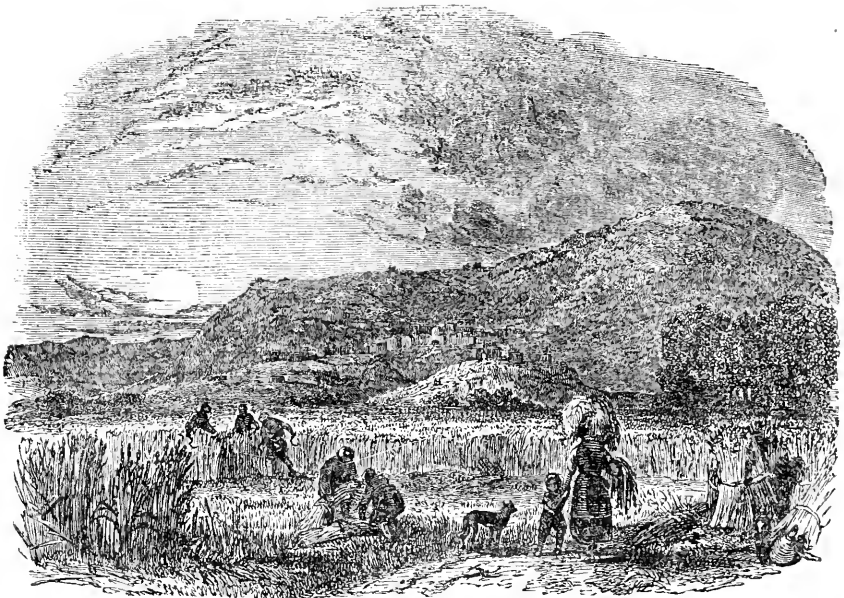

905. [Cana: Kefr Kenna.]

CANAAN (כְּנָעַן; *Xanaán*), son of Ham and grandson of Noah. The transgression of his father Ham (Gen. ix. 22-27), to which some suppose Canaan to have been in some way a party, gave occasion to Noah to pronounce that doom on the descendants of Canaan which was, perhaps, at that moment made known to him by one of those extemporaneous inspirations with which the patriarchal fathers appear in other instances to have been favoured [BLESSING]. That there is no just ground for the conclusion that the descendants of Canaan were cursed as an immediate consequence of the transgression of Ham, is shown by Professor Bush, who, in his *Notes on Genesis*, has fairly met the difficulties of the subject.

CANAAN, LAND OF, the ancient name of that portion of Palestine which lay to the west of the Jordan (Gen. xiii. 12; Num. xxxiii. 51; Deut. xi. 30; Judg. xxi. 12), the part beyond the Jordan eastward being distinguished by the general name of Gilead (comp. Judg. xxi. 12). The denomination Canaan included Philistia and Phœnicia (comp. Isa. xxiii. 11, and Gesenius thereon; Ezek. xvi. 29; Zeph. ii. 5). The name occurs on Phœnician coins (Eckhel, *Doctr. Num.* iv. 409), and was not even unknown to the Carthaginians (Ges. *Gesch. d. Heb. Sprach.* p. 16). For an account of the geography, &c. of the country, see PALESTINE.

CANAANITES (כְּנָעִי; Sept. *Kavalois*), the descendants of Canaan, the son of Ham and grandson of Noah, inhabitants of the land of Canaan and the adjoining districts. A general account of the different nations included in the term is given in the present article, and a more detailed account of each will be found under their respective names.

The Israelites were delivered from Egypt by Moses, in order that they might take possession of

the land which God had promised to their fathers. This country was then inhabited by the descendants of Canaan, who were divided into six or seven distinct nations, viz. the Hittites, Girgashites, Amorites, Canaanites, Perizzites, Hivites, and Jebusites (Exod. iii. 17, where the Girgashites are not mentioned; Deut. vii. 1, &c.). All these tribes are included in the most general acceptation of the term Canaanites; but the word, in its more restricted sense, as applied to one tribe, designated those 'who dwell by the sea, and by the coasts of Jordan' (Num. xiii. 29). Besides these 'seven nations,' there were several tribes of the Canaanites who lived beyond the borders of the Promised Land, northward. These were the Arkites, Sinites, Arvadites, Zemarites, and Hamathites (Gen. x. 17, 18), with whom, of course, the Israelites had no concern. There were also other tribes of Canaanitish origin (or possibly other names given to some of those already mentioned), who were dispossessed by the Israelites. The chief of these were the Amalekites, the Anakites, and the Rephaim (or 'giants,' as they are frequently called in our translation).* These nations, and especially the six or seven so frequently mentioned by name, the Israelites were commanded to dispossess and utterly to destroy (Exod. xxiii. 23; Num. xxxiii. 53; Deut. xx. 16, 17). The de-

* Other tribes are mentioned in the promise to Abraham (Gen. xv. 19), viz. the Kenites, Kenizzites, and Kadmonites. Of these the Kenites, or at least a branch of them, seem to have adhered to the Israelites, through their connection by marriage with Moses (Judg. iv. 11), and they were treated with kindness when the Amalekites were destroyed by Saul (1 Sam. xv. 6). The others are not elsewhere mentioned—the term *Kenizite*, applied to Caleb (Josh. xiv. 14), being a patronymic. (See Josh. xv. 17.)

lands
 Canaan-
 land
 emi-
 (De
 re in
 s on
 pters,
 i roū
 from
 aue.
 s of
 usl.;
 and

ame
 fre-
 ired
 is so
 go-
 sing
 has
 ceses
 ave
 that
 li to
 and
 de-
 in-
 s, as
 sess
 ius,
 ani-
 that
 ica-
 ther
 ust
 ject
 79,
 ther
 had
 as-
 the
 it
 of
 een
 an-
 ook
 the
 ew
 In
 of
 her
 sed
 der
 bes
 of
 ice
 pt
 nd
 al
 he
 at
 d,
 in
 of
 ne

destroyed by the tribe of Simeon (1 Chron. iv. 43). Even after the return of the Jews from the Babylonish captivity, there were survivors of five of the Canaanitish nations, with whom alliances had been

command to do so. That the Israelites were instruments in God's hand is a lesson not only continually impressed on their minds by the teaching of Moses, but enforced by their defeat whenever

struction, however, was not to be accomplished at once. The promise on the part of God was that he would 'put out those nations by little and little,' and the command to the Israelites corresponded with it; the reason given being, 'lest the beasts of the field increase upon thee' (Exod. xxiii. 29; Deut. vii. 22).

The destructive war commenced with an attack on the Israelites, by Arad, king of the Canaanites, which issued in the destruction of several cities in the extreme south of Palestine, to which the name of Hormah was given (Num. xxi. 1-3). The Israelites, however, did not follow up this victory, which was simply the consequence of an unprovoked assault on them; but turning back, and compassing the land of Edom, they attempted to pass through the country on the other side of the Jordan, inhabited by a tribe of the Amorites. Their passage being refused, and an attack made on them by Sihon, king of the Amorites, they not only forced their way through his land, but destroyed its inhabitants, and proceeding onwards towards the adjoining kingdom of Bashan, they in like manner destroyed the inhabitants of that district, and slew Og, their king, who was the last of the Rephaim, or giants (Deut. iii. 11). The tract of which they thus became possessed was subsequently allotted to the tribes of Reuben and Gad, and the half tribe of Manasseh.

After the death of Moses the Israelites crossed the Jordan, and, under the conduct of Joshua, took possession of the greater part of the Promised Land, and destroyed its inhabitants. Several cities, however, still held out, particularly Jebus, afterwards Jerusalem, which was not taken till the time of David (2 Sam. v. 6), and Sidon, which seems never to have yielded to the tribe of Asher, to whom it was allotted (Judg. i. 31). Scattered portions also of the Canaanitish nations escaped, and were frequently strong enough to harass, though not to dispossess, the Israelites. The inhabitants of Gibeon, a tribe of the Hivites, made peace by stratagem, and thus escaped the destruction of their fellow-countrymen. Individuals from amongst the Canaanites seem, in later times, to have united themselves, in some way, to the Israelites, and not only to have lived in peace, but to have been capable of holding places of honour and power; thus Uriah, one of David's captains, was a Hittite (1 Chron. xi. 41). In the time of Solomon, when the kingdom had attained its highest glory and greatest power, all the remnants of these nations were made tributary, and bond-service was exacted from them (1 Kings ix. 20). The Girgashites seem to have been either wholly destroyed or absorbed in other tribes. We find no mention of them subsequent to the book of Joshua, and the opinion that the Gergesenes, or Gadarenes, in the time of our Lord, were their descendants, has very little evidence to support it (Rosenmüller, *Scholia in Gen.* x. 16; Reland, *Palæstina*, i. 27, p. 138). The Anakites were completely destroyed by Joshua, except in three cities, Gaza, Gath, and Ashdod (Josh. xi. 21-23); and the powerful nation of the Amalekites, many times defeated and continually harassing the Israelites, were at last totally destroyed by the tribe of Simeon (1 Chron. iv. 43). Even after the return of the Jews from the Babylonish captivity, there were survivors of five of the Canaanitish nations, with whom alliances had been

made by the Jews, contrary to the commands which had been given them. Some of the Canaanites, according to ancient tradition, left the land of Canaan on the approach of Joshua, and emigrated to the coast of Africa. Procopius (*De Bello Vandalico*, ii. 10) relates that there were in Numidia, at Tigisis (*Tingis*), two columns on which were inscribed, in Phœnician characters, *ἡμεῖς ἐσμέν οἱ φυγόντες ἀπὸ προσώπου Ἰησοῦ τοῦ ληστοῦ υἱοῦ Ναυῆ*—'We are those who fled from the face of Joshua, the robber, the son of Naue.' (Bochart, *Peleg*, i. 24; Michaelis, *Laws of Moses*, art. 31, vol. i. p. 176, Smith's Transl.; Winer's *Realwörterbuch*, arts. 'Canaaniter' and 'Josua'.)

The manner in which the Israelites became possessed of the Promised Land has been so frequently brought as an objection to the inspired character of the Old Testament, and indeed is so far removed from the ordinary providential government of God, that it will be proper, in closing this account, to notice the difficulty which has been felt, and to advert to some of the hypotheses by which it is sought to be removed. Many have asserted, in order to alleviate the difficulty, that an allotment of the world was made by Noah to his three sons, and that by this allotment the Land of Promise fell to the share of Shem—that the descendants of Ham were therefore usurpers and interlopers, and that on this ground the Israelites, as the descendants of Shem, had the right to dispossess them. This explanation is as old as Epiphanius, who thus answered the objection of the Manichæans. Others justify the war on the ground that the Canaanites were the first aggressors—a justification which applies only to the territory on the other side of the Jordan. Michaelis, to whom we must refer for a lengthened investigation of the subject (*Laws of Moses*, b. ii. ch. iii. vol. 1, p. 111-179, Smith's Transl.), dissatisfied with these and other attempted apologies, asserts that the Israelites had a right to the land of Canaan, as the common pasture land of their herdsman, in consequence of the undisturbed possession and appropriation of it from the time of Abraham till the departure of Jacob into Egypt—that this claim had never been relinquished, and was well known to the Canaanites, and that therefore the Israelites only took possession of that which belonged to them. The same hypothesis is maintained by Jahn (*Hebrew Commonwealth*, ch. ii. § x. Stowe's Transl.). In the Fragments appended to Taylor's edition of Calmet's *Dictionary* (vol. iv. pp. 93, 96), another ground of justification is sought in the supposed identity of race of the Egyptian dynasty under which the Israelites were oppressed, with the tribes that overran Canaan—so that the destruction of the latter was merely an act of retributive justice for the injuries which their compatriots in Egypt had inflicted on the Israelites. To all these and similar attempts to justify, on the ground of *legal right*, the forcible occupation of the land by the Israelites, and the extermination (at least to a great extent) of the existing occupants, it is to be objected, that no such reason as any of these is hinted at in the sacred record. The right to carry on a war of extermination is there rested simply on the divine command to do so. That the Israelites were instruments in God's hand is a lesson not only continually impressed on their minds by the teaching of Moses, but enforced by their defeat whenever

they relied on their own strength. That there may have been grounds of justification, on the plea of human or legal right, ought not indeed to be denied, but it is, we imagine, quite clear, from the numerous attempts to find what these grounds were, that they are not stated in the Old Testament; and to seek for them as though they were necessary to the justification of the Israelites, seems to be an abandonment of the high ground on which alone their justification can be safely rested—the express command of God.

It may be said that this is only shifting the difficulty, and that just in proportion as we exculpate the Israelites from the charges of robbery and murder, in their making war without legal ground, we lower the character of the Being whose commands they obeyed, and throw doubt on those commands being really given by God. This has indeed been a favourite objection of infidels to the divine authority of the Old Testament. Such objectors would do well to consider whether God has not an absolute right to dispose of men as he sees fit, and whether an exterminating war, from which there was at least the opportunity of escape by flight, is at all more opposed to our notions of justice, than a destroying flood, or earthquake, or pestilence. Again, whether the fact of making a chosen nation of His worshippers the instruments of punishing those whose wickedness was notoriously great, did not much more impressively vindicate his character as the only God, who 'will not give his glory to another, nor his praise to graven images,' than if the punishment had been brought about by natural causes. Such considerations as these must, we apprehend, silence those who complain of injustice done to the Canaanites. But then it is objected further, that such an arrangement is fraught with evil to those who are made the instruments of punishment, and, as an example, is peculiarly liable to be abused by all who have the power to persecute. As to the first of these objections, it must be remembered, that the conduct of the war was never put into the hands of the Israelites—that they were continually reminded that it was for the wickedness of those nations that they were driven out, and, above all, that they themselves would be exposed to similar punishment if they were seduced into idolatry—an evil to which they were especially prone. As to the example, it can apply to no case where there is not an equally clear expression of God's will. A person without such a commission has no more right to plead the example of the Israelites in justification of his exterminating or even harassing those whom he imagines to be God's enemies, than to plead the example of Moses in justification of his promulgating a new law purporting to come from God. In a word, the justification of the Israelites, as it appears to us, is to be sought in this alone, that they were clearly commissioned by God to accomplish this work of judgment, thus, at once, giving public testimony to, and receiving an awful impression of, His power and authority, so as in some measure to check the outrageous idolatry into which almost the whole world had sunk.—

F. W. G.

CANDACE, or, more correctly, KANDAKĒ (both the c's being hard), was the name of that queen of the Ethiopians (Κανδάκη ἡ βασίλισσα Αἰθίοπων), whose high treasurer was converted to

Christianity under the preaching of Philip the Evangelist (Acts viii. 27). The country over which she ruled was not, as some writers allege, what is known to us as Abyssinia; it was that region in Upper Nubia which was called by the Greeks *Meroë* and is supposed to correspond to the present province of Atbara, lying between 13° and 18° north latitude. From the circumstance of its being nearly enclosed by the Atbara (Astaboras or Tacazze) on the right, and the Bahr el Abiad, or White river, and the Nile on the left, it was sometimes designated the 'Island' of Meroë; but the ancient kingdom appears to have extended at one period to the north of the island as far as Mount Berkal. The city of Meroë stood near the present Assour, about twenty miles north of Shendy; and the extensive and magnificent ruins found not only there, but along the upper valley of the Nile, attest the art and civilization of the ancient Ethiopians. These ruins, seen only at a distance by Bruce and Burckhardt, have since been minutely examined and accurately described by Cailliaud (*Voyage à Meroë*), Rüppel (*Reisen in Nubien, &c.*), and other travellers. Meroë, from being long the centre of commercial intercourse between Africa and the south of Asia, became one of the richest countries upon earth; the 'merchandise' and wealth of Ethiopia (Isa. xlv. 14) was the theme of the poets both of Palestine and Greece; and since much of that affluence would find its way into the royal coffers, the circumstance gives emphasis to the phrase—*πάσης τῆς γᾶς, 'all the treasure' of Queen Candace*. It is further interesting to know, from the testimonies of various profane authors, that for some time both before and after the Christian era, Ethiopia Proper was under the rule of female sovereigns, who all bore the appellation of 'Candace,' which was not so much a proper name as a distinctive title, common to every successive queen, like 'Pharaoh' and 'Ptolemy' to the kings of Egypt, and 'Cæsar' to the emperors of Rome. Thus Pliny (*Hist. Nat.* vi. 29) says that the centuries whom Nero sent to explore the country reported—'regnare in Meroë feminam Candacem, quod nomen multis jam annis ad reginas transiit.' Strabo also (p. 820, ed. Casaub.) speaks of a warrior-queen of Ethiopia called Candace, in the reign of Augustus, the same whom Dion Cassius (liv. 5) describes as queen of the Αἰθίοπες ἐπὲρ Αἰγύπτου οἰκοῦντες. An insult having been offered to the Romans on the Ethiopian frontier of Egypt, Caius Petronius, the governor of the latter province, marched against the Ethiopians, and having defeated them in the field, took Pselca, and then crossing the sands which had long before proved fatal to Cambyse, advanced to Premnis, a strong position. He next attacked Napata, the capital of Queen Candace, took and destroyed it; but then retired to Premnis, where he left a garrison, whom the warlike queen assailed, but they were relieved by Petronius. This Napata, by Dion called Teuape, is supposed to have stood near Mount Berkal, and to have been a kind of second Meroë; and there is still in that neighbourhood (where there are likewise many splendid ruins) a village which bears the very similar name of *Merauô*. Eusebius, who flourished in the fourth century, says, that in his day the queens of Ethiopia continued to be called Candace.

A curious confirmation of the fact of female

sovereignty having prevailed in Ethiopia has been remarked on the existing monuments of the country. Thus, on the largest sepulchral pyramid near Assour, the ancient Meroë (see Cailliaud, plate xlvii.), a female warrior, with the royal ensigns on her head, drags forward a number of captives as offerings to the gods; on another compartment she is in a warlike habit, about to destroy the same group. Heeren, after describing the monuments at Naga, or Naka, south-east of Shendy, says, 'It is evident that these representations possess many peculiarities, and that they are not pure Egyptian. The most remarkable difference appears in the persons offering. The queens appear with the kings; and not merely as presenting offerings, but as heroines and conquerors. Nothing of this kind has yet been discovered on the Egyptian reliefs, either in Egypt or Nubia. It may therefore with certainty be concluded, that they are subjects peculiar to Ethiopia. Among the Ethiopians, says Strabo (p. 1177), the women also are armed. Herodotus (ii. 100) mentions a Nitocris among the ancient queens of Ethiopia. Upon the relief [on the monument at Kalabshé] representing the conquest of Ethiopia by Sesostris, there is a queen, with her sons, who appears before him as a captive' (Heeren, *On the Nations of Africa*, vol. ii. p. 399). It is singular enough, that when Bruce was at Shendy, the government of the district was in the hands of a female called *Sittina*, i. e. the lady or mistress. He says 'There is a tradition there, that a woman, whose name was Hendaqué, once governed all that country, whence we might imagine that this was part of the kingdom of Candace; for writing this name in Greek letters it will come to be no other than Hendaqué, the native or mistress of Chendi or Chandi' (*Travels to discover the Source of the Nile*, vol. iv. p. 529; comp. vol. i. p. 505). It is true that, the name Kandaké being foreign to the Jews, it is in vain to seek with Calmet for its etymology in Hebrew, but the conjectural derivation proposed by Bruce is wholly inadmissible; nor is the attempt of Hiller to trace its meaning in the Ethiopic language much more satisfactory (Simonis, *Onomasticon Nov. Test.* p. 88). De Dieu asserts, on the authority of ecclesiastical tradition, that the proper name of the queen mentioned in the Acts was *Lacasa*, and that of her chamberlain *Judich*. It is not unlikely that some form of Judaism was at this period professed to a certain extent in Ethiopia, as well as in the neighbouring country of Abyssinia. Irenæus (iii. 12) and Eusebius (*Hist. Eccl.* ii. 1) ascribe to Candace's minister her own conversion to Christianity, and the promulgation of the Gospel throughout her kingdom; and with this agrees the Abyssinian tradition, that he was likewise the apostle of Tigré, that part of Abyssinia which lay nearest to Meroë; it is added that he afterwards preached the Gospel in Arabia Felix, and also in the island of Ceylon, where he suffered martyrdom (See Tillemont, *Mem. Hist. Eccl.* tom. ii.; Basnage, *Exercitatio anti-Baron.* p. 113; Ludolf, *Comment. ad Hist. Æthiop.* p. 89). [ETHIOPIA; ABYSSINIA.]—

N. M.

CANDLESTICK (הַמְּנִלָּה; Sept. ἡ λυχνία). The candelabrum which Moses was commanded to make for the tabernacle, after the model shown

him in the Mount, is chiefly known to us by the passages in Exod. xxv. 31-40; xxxvii. 17-24; on which some additional light is thrown by the Jewish writers, and by the representation of the spoils of the Temple on the arch of Titus.

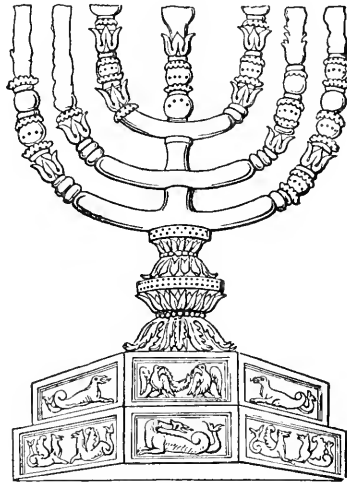

206.

The material of which it was made was fine gold, of which an entire talent was expended on the candelabrum itself and its appendages. The mode in which the metal was to be worked is described by a term which appears to mean wrought with the hammer, as opposed to cast by fusion. The structure of the candelabrum, as far as it is defined in the passages referred to, consisted of a base; of a shaft rising out of it; of six arms, which came out by threes from two opposite sides of the shaft; of seven lamps, which were supported on the summits of the central shaft and the six arms; and of three different kinds of ornaments belonging to the shaft and arms. These ornaments are called by names which mean cups, globes, and blossoms. The cups receive, in verse 33, the epithet almond-shaped (it being uncertain whether the resemblance was to the fruit or to the flowers). Three such cups are allotted to every arm; but four to the shaft: two-and-twenty in all. Of the four on the shaft, three are ordered to be placed severally under the spots where the three pairs of arms set out from the shaft. The place of the fourth is not assigned; but we may conceive it to have been either between the base and the cup below the lowest tier of arms, or, as Bähr prefers, to have been near the summit of the shaft. As for the name of the second ornament, the word only occurs in two places in the Old Testament, in which it appears to mean the capital of a column; but the Jewish writers generally (cited in Ugolini, *Thesaur.* xi. 917) concur in considering it to mean apples in this place. Josephus, as he enumerates four kinds of ornaments, and therefore two of his terms must be considered identical, may be supposed to have understood globes, or pomegranates (σφαίρα, ῥόσχοι. *Antiq.* iii. 6). But as the term here used is not the common name for pomegranates, and as the Sept. and Vul-

gate render it *σφαρωτίδες* and *sphærolæ*, it is safest to assume that it denotes bodies of a spherical shape, and to leave the precise kind undefined. Bähr, however, is in favour of *apples* (*Symbolik*, i. 414). The name of the third ornament means *blossom, bud*; but it is so general a term that it may apply to any flower. The Sept., Josephus, and Maimonides, understand it of the lily; and Bähr prefers the flower of the almond. It now remains to consider the manner in which these three ornaments were attached to the candelabrum. The obscurity of verse 33, which orders that there shall be 'three almond-shaped cups on one arm, globe and blossom, and three almond-shaped cups on the other arm, globe and blossom; so on all the arms which come out of the shaft,' has led some to suppose that there was only one globe and blossom to every three cups. However, the fact that, according to verse 34, the shaft (which, as being the principal part of the whole, is here called the *candelabrum* itself), which had only four cups, is ordered to have globes and blossoms (in the plural), is a sufficient proof to the contrary.

It is to be observed, that the original text does not define the height and breadth of any part of the candelabrum; nor whether the shaft and arms were of equal height; nor whether the arms were curved round the shaft, or left it at a right angle, and then ran parallel with it. The Jewish authorities maintain that the height of the candelabrum was eighteen palms, or three ells; and that the distance between the outer lamps on each side was two ells. Bähr, however, on the ground of harmonical proportion with the altar of incense and table of shew-bread, the dimensions of which are assigned, conjectures that the candelabrum was only an ell and a half high and broad. The Jewish tradition uniformly supports the opinion that the arms and shaft were of equal height; as do also Josephus and Philo (*l. c.*; *Quis Rer. Div. Hær.* § 44); as well as the representation on the arch of Titus. Scacchius has, however, maintained that they formed a pyramid, of which the shaft was the apex.

This candelabrum was placed in the Holy Place, on the south side (*i. e.* to the left of a person entering the tabernacle), opposite the table of shew-bread (Exod. xxvi. 35). Its lamps, which were supplied with pure olive oil only, were lighted every evening, and extinguished (as it seems) every morning (Exod. xxvii. 21; xxx. 7, 8; Lev. xxiv. 3; 1 Sam. iii. 3; 2 Chron. xiii. 11). Although the tabernacle had no windows, there is no good ground for believing that the lamps burnt by day in it, whatever may have been the usage of the second temple. It has also been much disputed whether the candelabrum stood lengthwise or diagonally as regards the tabernacle; but no conclusive argument can be adduced for either view. As the lamp on the central shaft was by the Jewish writers called *נר מערבי*, *the western, or evening lamp*, some maintain that the former name could not be applicable unless the candelabrum stood across the tabernacle, as then only would the central lamp point to the west. Others again adhere to the latter signification, and build on a tradition that the central lamp alone burnt from evening to evening, the other six being extinguished by day (Reland, *Antiq.* i. 5. 8).

In the first temple, instead of this single candelabrum, there were ten candelabra of pure gold (whose structure is not described, although *flower*-are mentioned: 1 Kings vii. 49; 2 Chron. iv. 7), one half of which stood on the north and the other on the south side of the Holy Place. These were carried away to Babylon (Jer. lii. 19). In the temple of Zerubbabel there appears to have been only one candelabrum again (1 Mac. i. 21; iv. 49, 50). It is probable that it also had only seven lamps. At least, that was the case in the candelabrum of the Herodian temple, according to the description of Josephus (*De Bell. Jud.* vii. 5). This candelabrum is the one which, after the destruction of Jerusalem, was carried with other spoils to Rome; then, A.D. 455, became a part of the plunder which Genseric transported to Africa; was again, about A.D. 533, recaptured from the Vandals by Belisarius, and carried to Constantinople, and was thence sent off to Jerusalem, and from that time has disappeared altogether. It is to this candelabrum that the representation on the arch of Titus at Rome was intended to apply; and, although the existence of the figures of eagles and marine monsters on the pediment of that lamp tends, with other minor objections, to render the accuracy of that copy very questionable (as it is incredible the Jews should have admitted any such graven images into their temple), yet there is reason to believe that, in other points, it may be relied upon as a reasonably correct representation of the Herodian candelabrum. Reland has devoted a valuable little work to this subject, *De Spoliis Templi Hierosolym. in Arcu Titiano*, ed. sec. Schulze, 1775.—J. N.

CANE (OR CALAMUS), SWEET, an aromatic seed, mentioned among the drugs with which sacred perfumes were compounded (Ezek. xxvii. 19) [KANEH].

CANKER-WORM. [YELEK.]

CANNEH (Ezek. xxvii. 23), probably the same as CALNEH (Gen. x. 10), which see.

CANON. 1. The Greek word *Κανών* denotes, primarily, a straight rod; and from this flow numerous derivative uses of it, in all of which the idea of *straightness*, as opposed to *obliquity*, is apparent. Among the rest, it is employed to denote a *rule or standard*, by a reference to which the rectitude of opinions or actions may be determined. In this latter acceptance it is used in the New Testament (comp. Gal. vi. 16; Phil. iii. 16). In the same sense it is frequently used by the Greek fathers (Suicer. *Thes. Eccles.* in voce); and as the great standard to which they sought to appeal in all matters of faith and duty was the revealed will of God contained in the scriptures of the Old and New Testaments, they came insensibly to apply this term to the collective body of those writings, and to speak of them as **THE CANON** OR **RULE**. In the same acceptance we shall use the term in this article.

2. The Canon then may be defined to be 'The Authoritative Standard of Religion and Morals, composed of those writings which have been given for this purpose by God to men.' A definition frequently given of the Canon is, that it is 'The Catalogue of the Sacred Books;' while Semler (*Von Freier Untersuchungen des Canons*), Doederlein (*Institutio Theol. Christ.* tom. i. p. 83), and others, define it as 'The List of the Books publicly read in the meetings of the early Chris-

tians.' The former of these definitions, however, leaves out of sight the true meaning of the term Canon; and the latter is doubly erroneous, as it not only omits the main characteristic of the Canon, *its divine authority*, but substitutes for this a characteristic which is historically false, as the Canon was not at any time synonymous with the list of books read in public in the early churches.

3. According to this definition, in order to establish the Canon of Scripture, it is necessary to show that all the books of which it is composed are of divine authority; that they are entire and incorrupt; that, having them, it is complete without any addition from any other source; and that it comprises the whole of those books for which divine authority can be proved. It is obvious that, if any of these four particulars be not true, Scripture cannot be *the sole and supreme* standard of religious truth and duty. If any of the books of which it is composed be not of divine authority, then part of it we are not bound to submit to; and consequently, *as a whole*, it is not the standard of truth and morals. If its separate parts be not in the state in which they left the hands of their authors, but have been mutilated, interpolated, or altered, then it can form no safe standard; for in appealing to it, one cannot be sure that the appeal is not made to what is spurious, and what, consequently, may be erroneous. If it require or admit of supplementary revelations from God, whether preserved by tradition or communicated from time to time to the Church, it obviously would be a mere contradiction in terms to call it *complete*, as a standard of the divine will. And if any other books were extant, having an equal claim, with the books of which it is composed, to be regarded as of divine authority, it would be absurd to call it *the sole* standard of truth; for in this case the one class of books would be quite as deserving of our reverence as the other.

4. Respecting the *evidence* by which the Canon is thus to be established, there exists considerable difference of opinion amongst Christians. Some contend, with the Catholics, that the authoritative decision of the Church is alone competent to determine the Canon; others appeal to the concurrent testimony of the Jewish and early Christian writers; and others rest their strongest reliance on the internal evidence furnished by the books of Scripture themselves. We cannot say that we are satisfied with any of these sources of evidence exclusively. As Michaelis remarks, the first is one to which no consistent Protestant can appeal, for the matter to be determined is of such a kind, that, unless we grant the Church to be infallible, it is quite possible that she may at any given period of her existence determine erroneously; and one sees not why the question may not be as successfully investigated by a private individual as by the Church. The concurrent testimony of the ancient witnesses is invaluable so far as it goes; but it may be doubted if it be sufficient of itself to *settle* this question, for the question is not *entirely* one of facts, and testimony is good proof only for *facts*. As for the internal evidence, one needs only to look at the havoc which Semler and his school have made of the Canon, to be satisfied that where dogmatical considerations are allowed to determine exclusively such questions, each

man will extend or extruncate the Canon so as to adjust it to the Procrustean couch of his own preconceived notions. As the question is one partly of fact and partly of opinion, the appropriate grounds of decision will be best secured by a combination of authentic testimony with the evidence supplied by the books themselves. We want to know that these books were really written by the persons whose names they bear; we want to be satisfied that these persons were commonly reputed and held by their contemporaries to be assisted by the divine spirit in what they wrote; and we want to be sure that care was taken by those to whom their writings were first addressed, that these should be preserved entire and uncorrupt. For all this we must appeal to the testimony of competent witnesses, as the only suitable evidence for such matters. But after we have ascertained these points affirmatively, we still require to be satisfied that the books themselves contain nothing obviously incompatible with the ascription to their authors of the divine assistance, but, on the contrary, are in all respects favourable to this supposition. We want to see that they are in harmony with each other; that the statements they contain are credible; that the doctrines they teach are not foolish, immoral, or self-contradictory; that their authors really assumed to be under the divine direction in what they wrote, and afforded competent proofs of this to those around them; and that all the circumstances of the case, such as the style of the writers, the allusions made by them to places and events, &c., are in keeping with the conclusion to which the external evidence has already led. In this way we advance to a complete moral proof of the divine authority and canonical claims of the sacred writings.

5. The books specified as canonical in the 6th Article of the Church of England, and the 1st of the Confession of the Church of Scotland, are received as such by the majority of Protestants. To these the Church of Rome adds, as part of the Old Testament, ten other books, or parts of books, which Protestants reject as Apocryphal [ΑΠΟΚΡΥΦΑ]. For the evidence in support of the genuineness and divine authority of those books universally regarded by Christians as canonical, taken individually, we shall refer here to the articles in this work under the titles of these books respectively. The remainder of the present article shall be devoted to a sketch of the formation and history of the Canon, first of the Old Testament, and then of the New.

6. *Formation of the Old Testament Canon.*—By this is meant the collection into one whole of all those books whose divine authority was recognised by the Jews, and which now form the Old Testament, as that is received by the Protestant churches. The question is—At what time and by whom was this done?

In answer to this, a very steadfast tradition of the Jews ascribes the completion of the Old Testament Canon to Ezra, and certain other persons who, after the re-building of the Temple, formed with him, and under his auspices, what has been called the Great Synagogue (בֵּית הַדְרָוֶלָה). Without pretending to be able to give full demonstration of the accuracy of this traditional opinion, it seems to us one which may by evidence, both direct and

circumstantial, be rendered so extremely probable, that to call it in question would be to exhibit a degree of scepticism such as, in all other questions of a similar kind, would be thought highly unreasonable and absurd. In the *first* place, there is the testimony of the tradition itself. It occurs in one of the oldest books of the Talmud, the Pirke Aboth; and is repeated, with greater minuteness, in the Babylonian Gemarah (*Tr. Baba Bathra*, fol. 13, 2. See the passages in Buxtorf's *Tiberias*, lib. i. c. 10). The substance of it is that, after Moses and the elders, the sacred books were watched over by the prophets; and that the Canon was completed by Ezra, Nehemiah, and the men of the Great Synagogue. Against this tradition it has been objected that it proves too much, for it says that the men of the Great Synagogue *wrote* the later books, such as the twelve minor prophets, &c. But that, by *writing*, is here meant not the original composing of these books, but the *ascription* (the *to-writing*) of them to the sacred Canon may be inferred, partly from the circumstance that, in the same tradition, the men of Hezekiah are said to have *written* the Proverbs, which can only mean that they *copied* them (see Prov. xxv. 1), for the purpose of inserting them in the Canon; and partly from the fact that the word here used (כתב) is used by the Targumist, on Prov. xxv. 1, as equivalent to the Heb. עָתָה. An attempt has also been made to discredit this tradition, by adducing the circumstance that Simon the Just, who lived long after Ezra, is said, in the Pirke Aboth, to have been one of the members of the Great Synagogue; but to this much weight cannot be allowed, partly because Simon is, in the passage referred to, said to have been one of the *remnants* of the Great Synagogue, which indicates his having outlived it; and principally because the same body of tradition which states this opinion, makes him the *successor* of Ezra: so that either the whole is a mistake, or the Simon referred to must have been a different person from the Simon who is commonly known by the title of 'Just' (Cf. Othonis, *Lex. Rabbin. Philol.* p. 604, Gen. 1675; Hävernick's *Einleitung in das A. T.* Th. i. Abt. 1, s. 43). Or we may adopt the opinion of Hartmann (*Die Enge Verbindung des Alt. Test. mit d. Neuen*, s. 127), that the college of men learned in the law, which gathered round Ezra and Nehemiah, and which properly was the synagogue, continued to receive accessions for many years after their death, by means of which it existed till the time of the Maccabees, without our being required to suppose that what is affirmed concerning its doings in the time of Ezra is meant to refer to it during the entire period of its existence. Suspicions have also been cast upon this tradition from the multitude of extravagant wonders narrated by the Jews respecting the Great Synagogue. But such are found in almost every traditional record attaching to persons or bodies which possess a nationally heroic character; and it is surely unreasonable, because a chronicler tells one or two things which are incredible, that we should disbelieve all besides that he records, however possible or even probable it may be. 'Je ne nie pas,' says Fabricy (*Des Titres Primitifs de la Révélation*, i. 87, Rome, 1772), 'que les Docteurs Juifs n'ayent avancé bien des chimères au sujet de cette Grande-Syna-

gogue; mais laissons le fabuleux, et prenons ce qu'il y a de vrai dans un point d'antiquité Hébraïque, appuyé sur des témoignages que la bonne critique ne permet pas de révoquer en doute.—2ndly. The part of this tradition which ascribes the formation of the Canon, before the Exile, to Moses and the prophets, is sufficiently supported by the testimony of Scripture itself. When Moses had finished the writing of the Law, 'he delivered it to the priests, the sons of Levi, and unto the elders of Israel' (Deut. xxxi. 9); and the book was then taken and put in the side of the ark, in the most holy place (v. 26). Towards the close of the book of Joshua it is said that 'he wrote these words in the book of the law of God'; which Le Clerc, with considerable probability, explains as meaning that he agglutinated the membrane on which his words were written to the volume of Moses which had been deposited in the side of the ark (*Comment.* in loc.). At a later period we find that Samuel, when he had told the people the manner (עֲשֵׂה) the *ius publicum* of the kingdom, wrote it in *the* book (הַסֵּפֶר), and laid it up before the Lord (1 Sam. x. 25). Hilkiah, at a still later date, is said to 'have found the book of the Law in the House of the Lord' (2 Kings xxii. 8). Isaiah, in calling attention to his own prophecies, says, 'Seek ye out of the book of the Lord and read; no one of these shall fail' (xxxiv. 16); a passage on which Gesenius says (*Comment.* i. 921), 'The poet seems to have before his mind the placing of his oracle in a collection of oracles and sacred writings, whereby future generations might judge of the truth of his predictions.' And Daniel informs us, that he 'understood, by the books, the number of the years of the captivity' (ix. 2); an expression which seems to describe the sacred Canon so far as it then was complete (Gesenius, *Lex. Heb.* in v. סֵפֶר). From these notices we may gather—that such books as were sanctioned by the authority of Moses and the prophets (whose business it was, as the watchmen of Zion, to guard the people against either the reception of any writing that was spurious or the loss of any that was genuine) were acknowledged by the Jews, before the Exile, as of divine authority; that in all probability an authentic copy was in every case laid up in the sanctuary, and placed under the care of the priests* (Joseph. *Antiq.* v. 1. 17), from which copies were taken and circulated among the people (2 Chron. xvii. 9); and that collections of these were made by pious persons for their own use, such as Daniel probably had in Babylon, and such as Jeremiah seems to have had, from the frequent quotations in his prophecies from the older books.—3rdly. It is natural to suppose that, on the return of the people from their exile, they would desiderate an authoritative collection of their sacred books. We know that, on that occasion, they were filled with an anxious desire to know the will of God, for neglect of which, on the part of their fathers, they had so severely suffered; and that, to meet this desire, Ezra and certain of the Priests and Le-

* The entrusting of the sacred books to the care of the priesthood was common to the Jews with the ancient nations generally. See Hävernick's *Einleit.* i. 1. § 17, and the authors cited there.

wites read and expounded the word of the Lord to the people (Neh. viii. 1-8; ix. 1-3). As their fathers also had been misled by false prophets, it is natural to suppose that they would earnestly crave some assurance as to the writers whose words they might with safety follow. The Temple also was now bereft of its sacred treasures (Joseph. *De Bell. Jud.* vi. 6; *Tract. Rabbin. Joma.* ed. Sheringham, p. 102, sqq.). During the exile, and the troublous times preceding it, several prophets had committed their oracles to writing, and these required to be added to the Canon; and the majority of the people having lost acquaintance with the Hebrew, a translation of their sacred books had become necessary. All this conspired to render it imperative that some competent authority should, at the time of the second temple, form and fix the code of sacred truth.—4thly. The time of Ezra and Nehemiah was the latest at which this could be done. As the duty to be performed was not merely that of determining the genuineness of certain books, but of pointing out those which had been divinely ordained as a rule of faith and morals to the Church, it was one which none but a prophet could discharge. Now in the days of Nehemiah and Ezra there were several prophets living, among whom we know the names of Haggai, Zechariah, and Malachi; but with that age expired the line of prophets which God had appointed 'to comfort Jacob, and deliver them by assured hope' (Ecclus. xlix. 10). On this point the evidence of Josephus, the Apocryphal books, and Jewish tradition, is harmonious (comp. Joseph. *Cont. Apion.* i. 8; 1 Macc. iv. 46; ix. 27; xiv. 41; Hieronym. *ad Jes.* xlix. 21; Vitringa, *Obs. Sac. lib.* vi. cap. 6, 7; Hävernick, *Einleit.* i. 1. 27; Hengstenberg, *Beiträge zur Einleit. ins A. T.* i. s. 245). As the men of the Great Synagogue were thus the last of the prophets, if the Canon was not fixed by them, the time was passed when it could be fixed at all.—5thly. That it was fixed at that time appears from the fact, that all subsequent references to the sacred writings presuppose the existence of the complete Canon; as well as from the fact, that of no one among the Apocryphal books is it so much as hinted, either by the author or by any other Jewish writer, that it was worthy of a place among the sacred books, though of some of them the pretensions are in other respects sufficiently high (e. g. Ecclus. xxxiii. 16-18; l. 28). Josephus, indeed, distinctly affirms (*Cont. Ap.* loc. cit.) that, during the long period that had elapsed between the time of the close of the Canon and his day, no one had dared either to add to, or to take from, or to alter anything in, the sacred books. This plainly shows that in the time of Artaxerxes, to which Josephus refers, and which was the age of Ezra and Nehemiah, the collection of the sacred books was completed by an authority which thenceforward ceased to exist.

7. *Division of the Canon into three parts, the Law, the Prophets, and the Writings* (תורה וכתובים וכתובים). This division is very ancient; it appears in the prologue to Ecclesiasticus, in the New Testament, in Philo, in Josephus, and in the Talmud (Surenhusii *Bib. Græc.* p. 49). Respecting the principle on which the division has been made, there is a considerable difference of opinion. Whilst all are agreed that the first

part, the Law, was so named from its containing the national laws and regulations; the other two are regarded by some as named from the character of the writings they contain; by others, from the office and station of their authors; and by others, from a sort of accidental combination, for which no reason can now be assigned. Of these, the second is the only one that will bear the test of examination. Two very material points in its favour are, 1st, that in the days of the Theocracy there was a class of persons who bore the name of Prophets (נביאים) professionally, i. e. they were persons not who were occasionally favoured with divine revelations, but who, renouncing all other occupations, gave themselves up to the duties of the prophetic office; and, 2ndly, that of all the books in the second division the reputed authors belong to this class; while of those in the third division, none of the authors, with two exceptions, belong to this class. The exceptions are Daniel and Lamentations. Of these the first is only apparent, for, though Daniel uttered prophecies, he was not by profession a prophet. The latter presents a greater difficulty; the best way of getting over which perhaps is, with Hävernick, to admit it to be an exception, and suppose it made intentionally, for the purpose of classing this book of elegies with the Psalms and other lyric poetry of the Jews (*Einleit.* § 11, s. 65). Adopting this theory, the title of the second division is accounted for. As for that of the third, the most probable account of it is, that, at first, it was fuller—viz. 'the other writings,' as distinguished from the Law and the Prophets (comp. the expression τὰ ἄλλα βιβλία, used by the Son of Sirach, *Ecclus.* Prol.); and that in process of time it was abbreviated into 'the writings.' This part is commonly cited under the title *Hagiographa*.

8. *Subsequent History of the Old Testament Canon.*—The Canon, as established in the time of Ezra, has remained unaltered to the present day. Some, indeed, have supposed that, because the Greek version of the Old Testament contains some books not in the Hebrew, there must have been a double canon, a Palestinian and an Egyptian (Semler, *Apparat. ad liberaliorem V. T. interpret.* § 9, 10; Corodi, *Beleuchtung der Gesch. des Jüdisch. u. Christlich. Kanons*, s. 155-184; Augusti, *Einleit. ins. A. T.* s. 79); but this notion has been completely disproved by Eichhorn (*Einleit.* bd. i. s. 23), Hävernick (*Einl.* i. § 16), and others. All extant evidence is against it. The Son of Sirach, and Philo, both Alexandrian Jews, make no allusion to it; and Josephus, who evidently used the Greek version, expressly declares against it in a passage above referred to (§ 6). The earlier notices of the Canon simply designate it by the threefold division already considered. The Son of Sirach mentions 'the Law, the Prophets, and the other books of the fathers;' and again, 'the Law, the Prophecies, and the rest of the books;' expressions which clearly indicate that in his day the Canon was fixed.* In

* Hitzig and some others speak of the title thus applied to the third division as 'vague,' and as indicating no settled canon. But this is absurd. 'The rest of the books' pre-supposes a fixed number of books, by subtracting from which the remainder is found.

the New Testament our Lord frequently refers to the Old Testament, under the title of 'The Scriptures,' or of 'The Law' (Matt. xxi. 42; xxii. 29; John x. 30, &c. &c.); and in one place he speaks of 'the Law of Moses, the Prophets, and the Psalms' (Luke xxiv. 44); by the third of these titles intending, doubtless, to designate the *Ἱαγιογραφα*, either after the Jewish custom of denoting a collection of books by the title of that with which it commenced; or, as Hävernäck suggests, using the term *ψαλμοί* as a general designation of these books, because of the larger comparative amount of lyric poetry contained in them (*Einkl.* § 14); Paul applies to the Old Testament the appellations 'The Holy Writings' (*γραφαὶ ἁγία*, Rom. i. 2); 'the Sacred Letters' (*ἱερὰ γράμματα*, 2 Tim. iii. 15), and 'the Old Covenant' (*ἡ παλαιὰ διαθήκη*, 2 Cor. iii. 14); both our Lord and his Apostles ascribe divine authority to the ancient Canon (Matt. xv. 3; John x. 34-36; 2 Tim. iii. 16; 2 Peter i. 19-21, &c.); and in the course of the New Testament, quotations are made from all the books of the Old except Ruth, Ezra, Nehemiah, Esther, Canticles, Lamentations, and Ezekiel; the omission of which may be accounted for on the simple principle that the writers had no occasion to quote from them. Philo attests the existence in his time of the *ἱερὰ γράμματα*, describes them as comprising laws, oracles uttered by the prophets, hymns, and the other books by which knowledge and godliness may be increased and perfected (*De Vita Contemplat.* in *Opp.*, tom. ii. p. 275, ed. Mangey); and quotations from or references to the most of the books are scattered through his writings. The evidence of Josephus is very important, for, besides general references to the sacred books, he gives a formal account of the Canon, as it was acknowledged in his day, ascribing five books, containing laws and an account of the origin of man, to Moses, thirteen to the Prophets, and four, containing songs of praise to God and ethical precepts for men, to different writers, and affirming that the faith of the Jews in these books is such that they would for them suffer all tortures and death itself (*Cont. Apion.* i. 7, 8; Eichhorn, *Einkl.* i. § 50; Jahn, *Introductio*, p. 50). Melito, bishop of Sardis in the second century of the Christian era, gives, as the result of careful inquiry, the same books in the Old Testament Canon as we have now, with the exception of Nehemiah, Esther, and Lamentations; the two first of which, however, he probably included in Ezra, and the last in Jeremiah (Euseb. *Hist. Eccles.* iv. 26; Eichhorn, *Einkl.* i. § 52). The catalogues of Origen (Euseb. *Hist. Eccles.* vi. 2, 5), of Jerome (*Prolog. Galeat.* in *Opp.* iii.), and of others of the fathers, give substantially the same list (Eichhorn, *l. c.*; Augusti, *Einkl.* § 54; Cosins, *Scholastical Hist. of the Canon*, ch. iii. vi.; Henderson, *On Inspiration*, 449). In the Talmudic Tract entitled *Baba Bathra*, a catalogue of the books of the sacred Canon is given, which exactly corresponds with that now received by Christians (Buxtorf, *Tiberias*, c. 11). Hence it appears that all the evidence we have shows that the Canon, once fixed, has remained unaltered.

9. *Formation of the New Testament Canon.*—Whilst there is abundance of evidence in favour of the divine authority of the New Testament books, taken separately, fully greater per-

haps than can be adduced in support of many of those of the Old Testament, the history of the formation of the New Testament Canon is involved in much greater obscurity than that of the Old. An ecclesiastical tradition ascribes to the apostle John the work of collecting and sanctioning the writings which were worthy of a place in the Canon; but this tradition is too late, too unsupported by collateral evidence, and too much opposed by certain facts, such as the existence of doubt in some of the early churches as to the canonicity of certain books, the different arrangement of the books apparent in catalogues of the Canon still extant, &c., for any weight to be allowed to it. A much more probable opinion, and one in which nearly all the modern writers who are favourable to the claims of the Canon are agreed, is, that each of the original churches, especially those of larger size and greater ability, collected for itself a complete set of those writings which could be proved, by competent testimony, to be the production of inspired men, and to have been communicated by them to any of the churches as part of the written word of God; so that in this way a great many complete collections of the New Testament scriptures came to be extant, the accordance of which with each other, as to the books admitted, furnishes irrefragable evidence of the correctness of the Canon as we now have it. This opinion, which in itself is highly probable, is rendered still more so when we consider the scrupulous care which the early churches took to discriminate spurious compositions from such as were authentic—the existence, among some, of doubts regarding certain of the New Testament books, indicating that each church claimed the right of satisfying itself in this matter—their high veneration for the genuine apostolic writings—their anxious regard for each other's prosperity leading to the free communication from one to another of whatever could promote this, and, of course, among other things, of those writings which had been entrusted to any one of them, and by which, more than by any other means, the spiritual welfare of the whole would be promoted—the practice of the fathers of arguing the canonicity of any book, from its reception by the churches, as a sufficient proof of this—and the reason assigned by Eusebius (*Hist. Eccles.* iii. 25) for dividing the books of the New Testament into *ὁμολογούμενοι* and *ἀντιλεγόμενοι*, viz. that the former class was composed of those which the universal tradition of the churches authenticated, while the latter contained such as had been received by the majority, but not by all (Storch, *Comment. Hist. Crit. de Libb. N. Testamenti Canon.*, &c. p. 112, ff.; Olshausen's *Echtheit der IV. Evang.* s. 439). In this way we may readily believe that, without the intervention of any authoritative decision, either from an individual or a council, but by the natural process of each body of Christians seeking to procure for themselves and to convey to their brethren authentic copies of writings in which all were deeply interested, the Canon of the New Testament was formed.

10. *History of the New Testament Canon.*—The first certain notice which we have of the existence of any of the New Testament writings, in a collected form, occurs in 2 Pet. iii. 16, where the writer speaks of the epistles of Paul in such a way as to lead us to infer that at that time the

whole or the greater part of these were collected together, were known amongst the churches generally (for Peter is not addressing any particular church), and were regarded as on a par with 'the other Scriptures,' by which latter expression Peter plainly means the sacred writings both of the Old Testament and the New Testament, as far as then extant.—That John must have had before him copies of the other evangelists is probable from the *supplementary* character of his own gospel.—In the anonymous Epistle to Diognetus, which is, on good grounds, supposed to be one of the earliest of the uninspired Christian writings, the writer speaks of the Law, the Prophets, the Gospels, and the Apostles (§ xi. ed. Hefele).—Ignatius speaks of 'betaking himself' to the Gospel as the flesh of Jesus, and to the apostles as the Presbytery of the church,' and adds, 'the prophets also we love;' thus showing, that it is to the Scriptures he was referring (*Ep. ad Philadelphenos*, § v. ed. Hefele).—Theophilus of Antioch speaks frequently of the New Testament writings under the appellation of *αἱ ἅγια γράφαι*, or *ὁ θεῖος λόγος*, and in one place mentions the Law, the Prophets, and the Gospels, as alike divinely inspired (*Ad Autol.* iii. 11).—Clement of Alexandria frequently refers to the books of the New Testament, and distinguishes them into 'the Gospels and Apostolic Discourses' (*Quis Dives Salvus?* prope fin.; *Stromat.* sæpissime).—Tertullian distinctly intimates the existence of the New Testament Canon in a complete form in his day, by calling it 'Evangelicum Instrumentum' (*Adv. Marc.* iv. 2), by describing the whole Bible as 'totum instrumentum utriusque Testamenti' (*Adv. Prax.* c. 20), and by distinguishing between the 'Scriptura Vetus' and the 'Novum Testamentum' (*ibid.* c. 13).—Irenæus repeatedly calls the writings of the New Testament 'the Holy Scriptures,' 'the Oracles of God' (*Adv. Hær.* ii. 27; i. 8, &c.), and in one place he puts the Evangelical and Apostolical writings on a par with the Law and the Prophets (*ibid.* i. 3, § 6). From these allusions we may justly infer that before the middle of the third century the New Testament Scriptures were generally known by the Christians in a collected form, and revered as the word of God. That the books they received were the same as those now possessed by us, is evident from the quotations from them furnished by the early Fathers, and which have been so carefully collected by the learned and laborious Lardner, in his *Credibility of the Gospel History*. The same thing appears from the researches of Origen and Eusebius, both of whom carefully inquired, and have accurately recorded what books were received as Canonical by the tradition of the churches or the church writers (*ἐκκλησιαστικῆ παράδοσις*), and both of whom enumerate the same books as are in our present Canon, though of some, such as the Epistles of James and Jude,* the 2nd Ep. of Peter, the 2nd and 3rd of John, and the Apocalypse, they mention that though received by the majority, they were doubted by some (Euseb. *H. E.* iii. 25;

vi. 24). Besides these sources of information we have no fewer than ten ancient catalogues of the New Testament books still extant. Of these, six accord exactly with our present Canon, while of the rest three omit only the Apocalypse, and one omits, with this, the Epistle to the Hebrews (Lardner's *Works*, vol. iv. and v., 8vo.; Horne's *Introduction*, vol. i. p. 70, 8th edition). An accumulation of evidence so copious and direct as this renders the integrity of the New Testament Canon a fact, than which none of a purely historical kind is better ascertained.

11. With the external evidence thus furnished in favour of the sacred Canon, the internal fully accords. In the Old Testament all is in keeping with the assumption that its books were written by Jews, sustaining the character, surrounded by the circumstances, and living at the time ascribed to their authors; or if any apparent discrepancies have been found in any of them, they are of such a kind as further inquiry has served to explain and reconcile. The literary peculiarities of the New Testament, its language, its idioms, its style, its allusions, all are accordant with the hypothesis that its authors were exactly what they profess to have been—Jews converted to Christianity, and living at the commencement of the Christian era. Of both Testaments the theological and ethical systems are substantially in harmony; whilst all that they contain tends to one grand result—the manifestation of the power and perfection of Deity, and the restoration of man to the image, service, and love of his Creator. The conclusion from the whole facts of the case can be none other than that the Bible is entitled to that implicit and undivided reverence which it demands, as the only divinely appointed Canon of religious truth and duty.

12. Besides the immortal work of Lardner and the different introductions to the critico-historical study of Scripture, the following works may with advantage be consulted on the subject of the Canon:—Cosin's *Scholastical History of the Canon*, 4to. London, 1657, 1672; Du Pin's *History of the Canon and Writers of the Books of the Old and New Test.* 2 vols. folio, London, 1699-1700; *Ens. Bibliotheca Sacra, sive Diatribe de Librorum Nov. Test. Canone*, 12mo. Amstel. 1710; Storch, *Comment. Hist. Crit. de Libb. Nov. Test. Canone*, 8vo. Francof. ad Viadrum, 1753; Schmid, *Hist. Antiq. et Vindicatio Canonis V. et N. Test.* 8vo. Lips. 1775; Millii *Proleg. in Nov. Test. Pars Prima*, Oxon. 1707; Jones's *New and Full Method of settling the Canonical Authority of the New Test.* 3 vols. 8vo.; Paley's *Horæ Paulinæ*; Alexander's *Canon of the Old and New Test. ascertained*, 12mo. Princeton, U. S. 1826, London, 1828.—W. L. A.

CANTICLES, or SOLOMON'S SONG (שִׁיר הַשִּׁירִים; Sept. *ᾠσμα των ᾠμάτων*; Vulg. *Canticum Canticoorum*; all signifying the Song of Songs), is generally believed to have been so denominated in the inscription, to denote the superior beauty and excellence of this poem. It is one of the five *megilloth*, or volumes, placed immediately after the Pentateuch in the present manuscripts of the Jewish Scriptures, in the following order, viz. Canticles, Ruth, Lamentations, Ecclesiastes, and Esther; although this

* Origen omits these altogether in his list as given by Eusebius, but elsewhere in his writings he so fully admits their Canonicity, that this omission can be regarded only as an oversight either on his part or on that of Eusebius.

order is sometimes violated [SCRIPTURE, HOLY]. It also constitutes the fourth of the *Cetubim*, or writings (hagiographa), which in the Jewish enumeration comprehend the Psalms, Proverbs, Job, Canticles, Ruth, Lamentations, Ecclesiastes, Esther, Daniel, and Ezra; which last includes the book of Nehemiah. These books are supposed to have been so called in contradistinction to the Law, which was delivered orally, and to the prophetic books, which were dictated in a peculiar manner. The *Cetubim* the Jews regard as the inspired writings of men who had no prophetic mission [HAGIOGRAPHIA].

Canonicity of Canticles.—In favour of the canonical authority of this book (which has been questioned in ancient and modern times) we may observe, that it is found in all the copies of the Hebrew Bible which have descended to our times, as well as in the version of the Seventy, which was finished some time in the second century before the Christian era. It is also found in all the ancient catalogues which have come down to us from the early Christian church. The most ancient which we possess, that of Melito, bishop of Sardis (A.D. 170), preserved by Eusebius (*Hist. Eccles.* iv. ch. 26.), professes to give an account of the books of the Old Testament, according to the order in which they were written, from accurate information obtained in the East. The names of these books, he acquaints us, are as follows:—‘of Moses, five books, Genesis, Exodus, Leviticus, Numbers, Deuteronomy; Jesus Naue, Judges, Ruth; four books of Kings; two of Paralipomena; Psalms of David; Proverbs of Solomon; Ecclesiastes; *Song of Songs*; Job; of Prophets, Isaiah, Jeremiah; of the twelve Prophets, one book; Daniel, Ezekiel, Esdras.’ The book of Canticles is invariably contained in all subsequent catalogues. It has consequently all the external marks of canonicity possessed by any other book of the Old Testament not expressly cited in the New. Those who have questioned its right to a place in the sacred volume have proceeded more in dogmatical than on historico-critical grounds. It has been, indeed, attempted to be shown that the Song of Solomon was not included by Josephus in his account of the books of canonical Scripture, on the following grounds:—Josephus divides these books into the ‘five books of Moses; thirteen books containing the history of their own times, written by the Prophets who succeeded him, to the time of Artaxerxes, son of Xerxes, king of Persia; and the remaining four consisting of hymns to God, and admonitions for the conduct of men’s lives.’ It is generally supposed that these four books are—Psalms, Proverbs, Ecclesiastes, and Canticles; and that the thirteen other books, included under the term Prophets, are—Joshua, Judges and Ruth, Samuel, Kings, Chronicles, Ezra and Nehemiah, Esther, Isaiah, Jeremiah and Lamentations, Ezekiel, Daniel, the twelve minor Prophets, and the book of Job. But it has been maintained, that this last book more appropriately belongs to the four which contain hymns and admonitions for human conduct, than to the Prophets who wrote the history of their own times after Moses, and consequently that there is no place left for Canticles. Those who adopt this view are compelled to separate the book of Ezra from that of Nehemiah, in order to make up the number of thirteen

prophets; but whatever appearance of truth there may be in this reasoning, which is that advanced by Mr. William Whiston, in his supplement to his *Essay towards restoring the Text of the Old Testament*, it is overbalanced by the fact already stated, that this book formed part of the Jewish canonical Scriptures and of the Septuagint version. It is true that other books are found in the copies of this latter version, which were either originally written in Greek, as the Book of Wisdom and others, or are translated from the Hebrew or Chaldee, as Ecclesiasticus, and the first book of Maccabees; but it is confessed that these never formed part of the first or Jewish canon. The Book of Canticles was also translated into Greek, from the original, by Symmachus the Jew, and by Aquila, in the second century.

The Canticles was one of the books translated by Jerome from the Greek, or rather, corrected from the older Latin version, and published by that Father; but this work is now lost. We still possess in the present Latin Vulgate Jerome’s translation of this book from the original Hebrew.

Subject of Canticles.—The subject of this book is confessedly LOVE. But it has been a matter of much controversy, especially in modern times, what kind of love is here celebrated. It is equally a matter of dispute among divines whether the interpretation of the poem is limited to its obvious and primary meaning, or whether it does not also include a latent mystical and allegorical sense. We shall speak of these subjects in order. And, first, as to the literal and primary meaning, the earliest information which we have is contained in the preface of Origen to his commentary on this book. This eminent scholar holds it to be an epithalamium, or marriage-song, in the form of a drama. This idea has been, in modern times, improved by Lowth, Bossuet, Michaelis, and other commentators. ‘The Song of Songs,’ says Bishop Lowth, ‘for so it is entitled, either on account of the excellence of the subject or of the composition, is an epithalamium, or nuptial dialogue, or rather, if we may be allowed to give it a title more agreeable to the genius of the Hebrews, a Song of Loves. Such is the title of Psalm xlv. It is expressive of the utmost fervour as well as delicacy of passion: it is instinct with all the spirit and sweetness of affection. The principal characters are Solomon himself and his bride, who are represented speaking both in dialogue, and in soliloquy, when accidentally separated. Virgins, also, the companions of the bride, are introduced, who seem to be constantly on the stage, and bear a part of the dialogue. Mention is also made of young men, friends of the bridegroom, but they are mute persons. This is exactly conformable to the manners of the Hebrews, who had always a number of companions to the bridegroom, thirty of whom were present in honour of Samson at his nuptial feast (Judg. xiv. 13). In the New Testament, according to the Hebrew idiom, they are called children, or sons of the bridechamber, and friends of the bridegroom. There, too, we find mention of ten virgins who went forth to meet the bridegroom and conduct him home; which circumstances indicate that this poem is founded on the nuptial rites of the Hebrews, and is ex-

pressive of the forms or ceremonial of their marriage. In this opinion, indeed, the harmony of commentators is not less remarkable than their disagreement concerning the general economy and conduct of the work, and the order and arrangement of the several parts. The present object of inquiry, however, is only whether any plot or fable be contained or represented in this poem; and upon this point the most probable opinion is that of the celebrated Bossuet, a critic whose profound learning will ever be acknowledged, and a scholar whose exquisite taste will ever be admired.'

Bossuet's idea of this poem was, that it is a regular drama, or pastoral eclogue, consisting of seven acts, each act filling a day, concluding with the Sabbath, inasmuch as the bridegroom on this day does not, as usual, go forth to his rural employments, but proceeds from the marriage chamber into public with his bride. The following are Bossuet's divisions of the plots:—

First day . . .	Chap. i.—ii. 6.
Second day . . .	ii. 7—17.
Third day . . .	iii.—v. 1.
Fourth day . . .	v. 2—vi. 9.
Fifth day . . .	vi. 10—vii. 11.
Sixth day . . .	vii. 12—viii. 3.
Sabbath . . .	viii. 4—14.

Lowth so far differs from Bossuet as to deny the existence of a regular drama, inasmuch as there is no termination to the plot. Michaelis, in his note to his German translation of Lowth's *Preclections*, endeavours to overturn the views of Bossuet and Lowth, and to show that this poem can have no relation to the celebration of a marriage, inasmuch as the bridegroom is compelled in his nuptial week to quit his spouse and friends for his whole days, in order to attend to his cattle in the pastures; and while he altogether repudiates the idea, which some have had the rashness to maintain, that the subject of the poem, in its literal signification, is a clandestine amour, inasmuch as the transaction is described as legal and public, and the consent of parents plainly intimated, he equally rejects the views of those who conceive that these songs relate to the state of parties betrothed before marriage. His opinion is, that this poem has no reference to a future marriage, but that the chaste loves of conjugal and domestic life are described. This state, he conceives, in the East, admits of more of the perplexities, jealousies, plots, and artifices of love than it does with us; the scene is more varied, and there is consequently greater scope for invention.

But the idea that the conjugal state, or the loves of married persons, are here referred to, has been strongly opposed by some of the ablest modern writers, including Eichhorn (*Einleitung*), Rosenmüller (*Scholia in Cant.* Pref. p. 261), Jahn (*Einleitung und Introduct. in Compendium redacta*), who maintain that the chaste mutual loves of two young persons antecedent to marriage are here celebrated. The last-named writer having observed that neither in monogamy nor in polygamy is the passion of love so ardent as is here represented, proceeds to maintain that no other object remains but 'the chaste and reciprocal affection of the sexes previously to marriage. Some of the language,' he adds, 'may be thought indecorous in persons in such circumstances; but this is not the case, unless it be taken in the worst sense. It admits of

a meaning perfectly chaste, which in the mouths of chaste lovers, such as the parties are uniformly represented, is the only one that can be true.' He conceives that there is no necessity to suppose any actual historical foundation for the poem.

Here it may be necessary to state, that the learned are divided on the point whether the Canticles consist of one continued and connected poem, or of a number of detached songs or amorets. The first person who maintained the latter opinion was Father Simon, who was on this account unjustly accused of denying the canonicity of the book. This opinion has been subsequently defended by Eichhorn (*Einleitung*), Jahn, Pareau (*Institutio Interpretis V. T.* p. iii. § iv. c. xi. § 3; *Biblical Cabinet*, vol. ii. p. 129), and many others. A very general opinion is, that it is an idyl, or rather, a number of idyls, all forming a collective whole. Such is the opinion held, among others, by Sir William Jones and Dr. J. Mason Good, in his beautiful translation of the Song of Songs. Dr. Adam Clarke, however, will not allow that the book of Canticles comes under the denomination of a pastoral, an idyl, an ode, or an epithalamium. He conceives it to be a composition *sui generis*, partaking more of the nature of a mask than anything else—an entertainment for the guests who attended a marriage ceremony. He admits no mystical sense. Jahn, in the work above alluded to, having stated his opinion that the work comprehends several amatory poems, thus distributes them:—

1. An innocent country maiden makes an undisguised profession of her attachment, and her lover, a shepherd, replies to it with equal protestations of affection (i. 2—ii. 7). Some prefer concluding this dialogue at i. 11, and making i. 12—ii. 7, a soliloquy, in which the maiden is supposed to repeat some compliments of her lover. But this is without sufficient reason.—2. A maiden sings of her lover, who is seeking her everywhere, and she also confesses her warm affection (ii. 8—iii. 5). Some suppose that ii. 8—14 is a dream, and that in verse 15 the maiden awakes, who dreams again in iii. 1-5. But if these places are similar to dreams, it ought to be remembered that waking dreams are not uncommon with lovers. This the poet, true to nature, has here represented.—3. A maiden in a litter, surrounded by Solomon's soldiers, is brought to the harem of the king. The lover prefers, far before all the royal beauties, his own beloved, in whose society he declares that he is happier than the king himself (iii. 6- v. 1). Some choose to make iv. 8—v. 1, a distinct poem; but they can hardly offer any sufficient reason for separating this portion from the other. Nevertheless the distribution of the work into its several parts must be left very much to the reader's own taste and feeling.—4. A maiden beloved sings of her lover. He had come to her door at night, and had fled away before she opened it. She seeks him; is beaten by the watch, and stripped of her veil. She describes the beauty of her lover, who at length answers, celebrating her loveliness, with a contemptuous glance at the multitude of the king's wives (v. 2- vi. 9).—5. Shulamith recounts, in few words, the allurements of the courtiers, whom she has met with unexpectedly in the garden, and her rejection of them, and celebrates her affection for

her lover (vi. 10—viii. 3).—6. Protestation and praises of constant affection (viii. 4-7).—7. A discourse between two brothers, about guarding and giving away their sister in marriage; who replies with scorn, that she would be her own guardian (viii. 8-12).—8. A fragment. A lover wishes to hear his beloved. She replies by persuading him to fly. Perhaps her parents or relations were near, who, in the East, never permit such meetings (viii. 13, 14).

Ewald considers the poem to consist of a drama in four parts. The heroine of the poem, according to this writer, is a country maiden, a native of Engedi, who, while rambling in the plains, fell in with the chariots of Solomon, and was carried by him into his palace. (Ewald's *Das Hohe Lied Salomo's*, Gotting. 1826).

We may here mention, that the divisions in general of this poem have been modified according to the views of its different commentators. Those, for instance, who regard it as *prophetical*, have adopted various divisions; such as the *legal* and *evangelical*—the former commencing with the captivity, and ending with the death of Christ, from the commencement to chap. iv. 6; and the latter from chap. iv. 7 to the end. Nicholas Lyranus considers the six first chapters to represent the Old Testament, and the two last the New. Ederus (*Econom. Bibl.* p. 180) supposes that it describes the history of the church to the time of Christ, in ten dramas. Gregory de Valentia divides it into two parts—the first containing the history of the Israelitish church to Solomon; and the second, the professing Christian church, to the time of Constantine. Cornelius a Lapide finds in it the Christian church in its infancy to the feast of the Pentecost, its youth to the time of Constantine, its manhood under Constantine, its old age in the time of the Arian and Nestorian heresies, and its renovation under Basil, Chrysostom, and Augustin. Those who consider it as a *dogmatical* book form other divisions. Thus, Cocceius, holding it to be a representation of the progress of religion in the soul, or the spiritual wedlock of Christ and the church, divides it into four parts, consisting of espousals, mutual love, reconciliation, and consummation in heaven; while Calovius forms of it three divisions, consisting of the desire of Christ and his advent, grief for the loss of the bridegroom, and the song of the bridegroom and bride.

Object of the Canticles.—It has been in all ages a matter of dispute, whether we are to seek for any hidden or occult meaning under the envelope of the literal and obvious sense. While several eminent men have maintained that the object of these poems is confined to the celebration of the mutual love of the sexes, or that its main design, in so far as its sacred character is considered, is the inculcation of marriage, and especially of monogamy, the majority of Christian interpreters, at least since the days of Origen, have believed that a divine allegory is contained under the garb of an epithalamium, founded on the historical fact of the marriage of Solomon with the daughter of Pharaoh: others have held it to be a simple allegory, having no historical truth for its basis. We are informed by Jerome, that Origen wrote ten books of commentaries on this poem, containing twenty thousand *stichi*. Of

these there are extant, in Latin, two homilies, translated from the original Greek by Jerome; and four books of Commentaries, in the version of Rufinus (Origen, *Opera*, Paris, 1740, vol. iii.). While the celebrated author admits the historical sense, he represents, according to his custom, a hidden sense, in which either the church or the soul of the believer (for he does not determine which) converses with the divine Redeemer. 'This little book,' he says, 'seems to be an epithalamium—that is, a nuptial song—written by Solomon, and sung in the person of a bride to her bridegroom, who is the word of God burning with celestial love. For she loved him passionately, whether we consider her as the soul made after his image, or the church.' Jerome, in his *Epistle to Pope Damasus*, observes, that 'Origen, having in his other writings exceeded all others, in his work on Canticles has exceeded himself.' Jerome and the Fathers in general have followed Origen's interpretation. The only exception to this view, among the early writers, whose name has come down to us, is the famous Syrian commentator, Theodore, Bishop of Mopsuestia, the friend and schoolfellow of St. Chrysostom. This eminent writer altogether denied the allegorical interpretation, and is said to have considered the Canticles to have been composed with the view of gaining the affections of an Ethiopian princess. Theodoret, in his *Commentary on Canticles*, while he states that Eusebius, Cyprian of Carthage, and others nearer to the apostolic age recognised the Canticles as a spiritual book, acquaints us that there were persons who slandered the book, and denied its spiritual meaning, putting together fables unworthy of a doting old woman; others, he observes, were of opinion that the wise Solomon writes concerning himself and the daughter of Pharaoh, while some authors of the same class feigned that the Shunamite (for the word is sometimes thus read) was no other than Abishag, who was a native of Shunem. St. Bernard assigns to the book three senses—a historical, a moral, and a spiritual. He describes it as an agreeable and figurative epithalamium, in which Solomon sings the mysteries of an eternal marriage; and among the moderns, Bossuet observes, that 'Solomon adduces, as an example, his chaste affection towards Pharaoh's daughter; and while on the foundation of a true history he aptly describes the most passionate love, he sings, under the envelope of an elegant fable, celestial loves and the union of Christ and the Church.'

Among those who have maintained the opinion that the Song of Songs is an allegory founded on facts, were Isidore Clarius and Francis Vatablus. Lightfoot also considers the poem to refer to a daughter of Pharaoh, an Ethiopian and a Gentile. Others, as we have observed, among whom are the learned Lutherans Carpzov (*Introductio ad Libros Canonicos V. T.*), and Gerhard (*Postill. Salomonis, in Cant. proem. cap. x.*), maintain that the book is a simple allegory, having no historical base whatever, but describing the love which subsists between Christ and the Church under figures borrowed from the ardour of human passion. These writers maintain that there exists no double sense whatever, but that its primary is its only sense, and that this primary sense is entirely of a spiritual character.

As, however, the Scriptures give no intimation

that this book contains a mystical or allegorical sense, recourse has been had to the analogy of some of the Messianic Psalms, whose application to Spiritual objects is recognised in the New Testament. Especially a great resemblance has been observed between the character of the Canticles and the 45th Psalm; and it will suffice for our present purpose to cite the opinion of Rosenmüller, one of the ablest commentators on the Messianic Psalms, in reference to this subject. Professing to follow the opinion of the ancient Hebrews, communicated by the Chaldee paraphrast, and the writer of the Epistle to the Hebrews—namely, that the 45th Psalm celebrated the excellencies and praises of the great Messiah; he observes, ‘Throughout the latter part of the psalm this allegory, in which the Hebrew poets particularly delighted, is maintained. They were accustomed to represent God as entertaining, towards his chosen people, feelings which they compared to conjugal affections; and which they deduced, under this figure, into all their various and even minute expressions. In the illustrating and beautifying of this allegory, the whole of the *Song of Songs* is occupied: that the subject of that poem, and that of the psalm before us, is the same, there is no doubt among sound interpreters.’ The reader may also refer, in illustration of this subject, to the many passages of the Old and New Testament in which this figure is retained by the sacred writers: such as Isaiah liv. 5; lxii. 5; Jerem. iii. 1, &c.; Ezek. xvi. and xxiii.; Matt. ix. 15; John iii. 29; 2 Cor. xi. 2; Ephes. v. 2, 3, &c.; Rev. xix. 7; xxi. 2; xxii. 17. (See, especially, Bishop Lowth’s 21st Lecture, *De Sacra Heb. Poesi*.) The writers, however, who have admitted the allegorical sense, are divided as to the object and design of the allegory. The ancient Chaldee paraphrast, a writer not more ancient than the sixth century, has been considered by some as preserving the tradition of the Jews on this subject. In this commentary (the Targum) the Canticles are explained as a figurative description of the gracious conduct of Jehovah towards his people, in delivering them from the Egyptian bondage, conferring great benefits on them during their progress through the wilderness, and conveying them in safety to the promised land. Aben Ezra, the celebrated Jewish commentator of the 12th century, considered that the Canticles represented the history of the Jews from Abraham to the Messiah. Others have conceived the bride to be Wisdom, with whom Solomon was acquainted from his childhood, and with whose beauty he was captivated (Leo Hebræus, Dialog. iii. *De Amore*). This latter is the view followed by Rosenmüller in his *Scholia*. He conceives the sudden transitions of the bride from the court to the grove inexplicable, on the principle that the Canticles describe only human love; but while adopting the allegorical interpretation, he professes to follow the Chaldee paraphrast and Solomon Jarchi, and terms the Canticles a dramatico-allegorical poem. Luther, in his *Commentary on Canticles*, maintained the allegorical interpretation, conceiving Jehovah to be the bridegroom, the bride the Jewish nation, and the poem itself a figurative description of Solomon’s civil government, which, as we have already seen, appears, from Theodoret, to have been an opinion of some of the

ancients. In his *Commentary* on 1 Peter, however, he explains the bride to be the New Testament church. For the view in his *Commentary on Canticles* he is put down as a follower of those ancient heretics by Sixtus of Sienna, and other writers of the church of Rome. But from this charge he is ably defended by Gerhard (*ut supra*).

The modern writers of the Roman church have, in general, followed Origen and Jerome in their allegorical interpretations. The learned Hug, however (*Das Hohelied in einen noch unver-suchten Deutung*, Freyberg, 1813), has given an entirely new interpretation. He finds, under the image of the bride, the ten tribes, and by the brothers of the Shulamite he understands the citizens of Judah, inasmuch as they did not think the Jews worthy of being united with them. He regards the book as an attempt made in the time of Hezekiah to re-unite the remnant of the ten tribes to the tribe of Judah. Carpzov states that the Papists find Christ the spouse, and Mary the bride: but this only applies to very few writers in the Roman communion. Others among them explain the allegory as descriptive of the union between Christ and perfect souls, including the blessed Virgin; among English commentators also the idea is very prevalent that the Canticles have a peculiar reference to the union of the soul of the believer with Christ. The Rev. T. Scott observes, in his *Commentary*, that ‘no other poem of the kind could be so explained as to describe the state of the heart at different times, and to excite admiring, adoring, grateful love to God our Saviour as this does.’ We shall briefly dismiss the other views held respecting the Canticles by those who admitted the allegorical sense. Grotius has been justly censured for his views on this subject. Conceiving it to be a dialogue between Solomon and the daughter of the king of Egypt, he supposes that the mysteries of marriage are hidden under modest expressions. His comments cannot be too highly reprobated for their grossness and obscenity. At the same time he adds that ‘Solomon, in order to perpetuate the work, composed it with such art that, without much distortion, it might be found to contain an allegory expressive of the love of God to the Israelites, as held by the Chaldee paraphrast and Maimonides. But as this was a type of the love of Christ to his Church, Christians laudably employed their genius in applying the words of the *Song* to this.’ Carpzov, who admits no literal interpretation, considers that Bossuet only re-hashed this idea of Grotius, whom he acknowledges to have been a great man, if he had let sacred subjects alone.

Among the remaining allegorical senses given to this poem, is that of its being a dialogue between God and the human soul, and even between the divine and human nature of Christ; while the alchemists conceive the whole book to treat of nothing but the philosopher’s stone, of which Solomon was in search (see Carpzov’s *Introduction*). We must not omit the opinion of the learned Keiser, who conceives it to be a historico-allegorical song, celebrating the restoration of the Mosaic worship by Zerubbabel, Ezra, and Nehemiah (*Das Hohelied*, Erlangen, 1825).

We are now to give some account of those who deny any but a literal interpretation of this book. We find in the Mishna (*Pirke Avoth* and *Mas-*

sechet Jadaim) some allusion to an idea that until the time of Ezra doubts were entertained as to the authenticity of this book; and to a decision of the Rabbins, that so far from its being an impure book, it was the most holy of all the hagiographa; and that if any controversy existed, it was only in respect to Ecclesiastes. We are also informed by Origen and Jerome that the Jews forbade this book to be read by any one until he arrived at thirty years of age—a restriction which these Fathers approved of in consequence of the amatory character of the poem. Among the Christian writers we have already observed that the only author of antiquity who has defended its literal interpretation was Theodore of Mopsuestia, who was condemned at the second Council of Constantinople for having ‘disparaged the Canticles, by asserting that Solomon wrote these things to his bride, expounding things unutterable to Christian ears.’ Leontius of Byzantium, a writer of the seventh century, in his book against Nestorius (see *Canisius*, vol. i. p. 577), observes, among other things, of Theodore, that he ‘interpreted libidiously, according to his own mind, and with meretricious tongue, the most holy Song of Songs, which, with incredible audacity, he cuts off from the sacred books. Jahn also (*Introduction*) says, that the worst interpretation of all was that of Theodore, who considered the Canticles an obscene book. Dr. Nathaniel Lardner had long since observed that this accusation was probably false, as being made by his enemies. The reader can only form his judgment from the few fragments which have come down to us from this eminent interpreter. The following is, perhaps, the most remarkable:—‘It becomes all readers to reflect that this book of the wise man cannot be looked on as an encouragement to immorality, and therefore to be held in disrepute. Neither should the book, on the other hand, be commended as having a prophetic character, for the edification of the Church; for had it been a prophetic book, there would have been some mention in it of the name of God; but all ought to know that the book is a table entertainment, such as Plato, at a later period, wrote concerning love, on which account the public reading of the Canticles was never allowed either to the Jews or to us, as being a domestic and nuptial Song of Solomon, singing to his guests the reproaches cast upon his bride.’ But whatever might have been Theodore’s particular views, he appears to have had no followers for many ages; the allegorical interpretation has been the current one in the Christian Church. Erasmus is said to have been the first after Theodore to deny this interpretation (*American Ency.*, art. ‘Sol.’s Song’). Le Clerc, at a later period, took the same view, maintaining that it was simply an idyl or pastoral eclogue; and, in more modern times, some of the most distinguished interpreters have followed this interpretation.

The opinions of those who have acknowledged no other than the literal interpretation of the Canticles has had a considerable influence in the question of the canonicity of the book. Nor is it at all surprising that those who were in the habit of attaching a spiritual meaning to it should find it difficult to believe that a book, treating of human love, should have a place in the inspired volume. Jahn endeavours to explain this by the hypothesis that the author or authors of these

songs do not celebrate all kinds of chaste love—the sexes before marriage, but only that which leads to monogamy (which is commended in Ecclesiastes ix. 9) and polygamy condemned, iii. 6-11, and vi. 8, 9; or that the prophets—possibly Haggai, Zechariah, and Malachi—who placed the Canticles in the canon, seem to have understood it in the mystical sense; so that the canonical sense is mystical, although this sense was not intended by the authors [INSPIRATION]. Most, however, of the literal commentators are of opinion that marriage, being a divine institution, the chaste love of the sexes is a fit subject for sacred song. Thus Pareau (*Institutio Interpretis V. T.*; see Translation in *Bib. Cabinet*, vol. ii. p. 291), who conceives that these songs are employed in ‘describing the chastest love subsisting between a certain young man and a girl betrothed to him, in which the poet gives the reins to a most luxuriant imagination,’ thinks that, at the same time, nothing is seen adapted to excite or nourish impure feelings, but that the author seems to have studiously endeavoured to adorn the virtuous loves of the future spouses with all those allurements which a fervid and Oriental genius could imagine, that he might more efficaciously recal the young men of his time from the enticements of impure love (See also Seiler’s *Hermeneutics*, § 175). Seiler conceives that the aim of these songs consists in a commendation of conjugal fidelity, and of pure love for one wife, who is the legitimate spouse, even in a state of polygamy.

An argument has been made use of against the literal sense derived from the style of the poem; some critics having maintained that actual deformities are ascribed to the bride, which is inconsistent with an amatory poem; but from this charge it has been powerfully vindicated by writers of exquisite taste, of whom it will be sufficient to name Bossuet, Lowth, Eichhorn, and Dr. J. Mason Good. ‘Even regarding it,’ says Calmet, ‘as a mere human composition, it has all the beauties of which a piece of this nature is capable. The bride and bridegroom express their sentiments in figurative and enigmatic periods, and by comparisons and similitudes derived from rural scenery. If the comparisons are sometimes too strong, we must allow something to the genius of the Orientals and the vivacity of love. The style is tender, lively, animated, and delicate’ (Preface to *Canticles*).

These views, however, respecting the beauties of the poem, leave the question of its mystical and spiritual character untouched. We know that many poets, ancient and modern, have written amatory songs, which have allegorical, distinct from the primary, meaning. To adduce a familiar instance, it is known that several of Mr. Moore’s *Melodies* are of this character. It is, therefore, at least possible that the Canticles may have a hidden meaning; but as the Scriptures nowhere refer to this, it can only be inferred from analogy. It is, at the same time, remarkable, that although the ancient Jews have attached a *Messianic* character to several of the psalms, they have never, as far as we know, sought this meaning in the Canticles.

It was chiefly the *subject* of the poem that influenced Dr. J. Pye Smith in rejecting the Canticles from the Canon, although he also maintained,

with Whiston, that Josephus did not include it in his catalogue (*Scripture Testimony*, i. 55, 3rd edit. 1837; also *Congregational Magazine* for 1837, 1838.)

But by many who defend the allegorical interpretation, it is acknowledged that, even in its literal sense, it has a just claim to be considered a canonical book. Dr. J. Mason Good, for instance, who, although he acknowledges that we have no sufficient data to build a decisive opinion, still believes it an allegory (observing that 'this allegoric mode of describing the sacred union subsisting between mankind at large, or an individual and pious soul, and the great Creator, is common to almost all Eastern poetry,' in proof of which he refers to the chaste and virtuous Sadi or the more impassioned Hafiz), and maintains that 'to those who disbelieve the existence of such an allegory, they still afford a happy example of the pleasures of holy and virtuous love; they inculcate, beyond the power of didactic poetry, the tenderness which the husband should manifest for his wife, and the deference, modesty, and fidelity with which his affection should be returned; and, considered even in this sense alone, they are fully entitled to the honour of constituting a part of the sacred Scriptures' (*Song of Songs, or Sacred Idyls*, by J. Mason Good, M.D.).

The translators of the Canticles have come in for their share of obloquy. 'Sebastian Castello,' says Beza, 'wanted to expunge the Canticles from the Canon as an impure and obscene poem, and heaped the vilest reproaches on those ministers who resisted him. For this he was summoned before the senate, and expelled from Geneva. Conceiving the whole to relate to the amours of the polygamist monarch, he rendered it into Latin so as to express the effeminate and softly breathing sighs of lovers, imitating rather Catullus and Petronius than a divine prophet.' Beza styles Castello an ambitious and self-opiniated man. Sixtus Senensis is equally severe on Castello's translation (*Bib. Sac.* book vi. hæc. xiii. p. 664). He has been even accused of calling the Canticles 'a flagitious book.' These are, however, it must be borne in mind, the accusations of Castello's enemies; and it must be recollected that Castello was particularly obnoxious to Beza on other accounts, especially for disapproving of the burning of Servetus, which Beza had defended, together with the propriety of burning heretics in general (Beza's *Life of Calvin*). Beza himself subsequently incurred similar obloquy for his own translation; and it is known, that when in his old age he married his second wife, he facetiously called his youthful bride by the name of his *Shunamite*.

Author and Age of Canticles.—These have been also much disputed. The inscription ascribes it to Solomon; and this is confirmed by the universal voice of antiquity, although some of the Jews have attributed it to Hezekiah.

From some Aramaic words, the spelling of David, in the solitary instance in which it occurs, with a *y* (yod), and the abbreviation of the pronoun *W*N, the work has been supposed, by Eichhorn, Jahn, and others, to be written after the captivity. Rosenmüller dwells on the word 'Paradise,' which is found only here (ch. iv. 13), and in Ecclesiastes (ii. 5), and (Nehemiah (iv. 6)), as a proof of this later date. The two latter

books he regards as evidently written after the exile. But this mode of spelling David, which also occurs in Amos (vi. 5), only proves that the present text is corrupted. Aramaic words are found in other books of Scripture, whose antiquity is undisputed. Ewald fixes it to the year B.C. 920, which brings it near the age of Solomon; and Pareau, although coinciding with Rosenmüller in the opinion that Ecclesiastes was written after the captivity, has not 'the least doubt that the song is rightly attributed to Solomon; and the eminent critic De Wette (*Lehrbuch*) is of opinion that the whole range of the figures and allusions, and the character of the manners depicted, prove that this work belongs to the age of Solomon. He accounts for the later features by supposing several minor poems to have been collected at some late period.—W. W.

CAPERNAUM (*Καπερναούμ*), a city on the north-western side of the Lake of Gennesareth, and on the border of the tribes of Zebulun and Naphtali. The infidelity and impotence of the inhabitants of this place, after the evidence given to them by our Saviour himself of the truth of his mission, brought upon them this heavy denunciation:—'And thou, Capernaum, which art exalted unto heaven, shalt be brought down to hell: for if the mighty works which have been done in thee had been done in Sodom, it would have remained unto this day,' &c. (Matt. xi. 23.) This seems to have been more than any other place the residence of Christ after he commenced his great mission; and hence the force of the denunciation, which has been so completely accomplished, that even the site of Capernaum is quite uncertain. Dr. Robinson (*Bibl. Researches*, iii. 288-294) exposes the errors of all previous travellers in their various attempts to identify the site of Capernaum; and, from a hint in Quaresnius, he is rather inclined to look for it in a place marked only by a mound of ruins, called by the Arabs, Khan Mineh. This is situated in the fertile plain on the western border of the Lake of Gennesareth, to which the name of 'the land of Gennesareth' is given by Josephus (*De Bell. Jud.* iii. 10, 8). This plain is a sort of triangular hollow, formed by the retreat of the mountains about the middle of the western shore. The base of this angle is along the shore, and is about one hour's journey in length, whereas it takes an hour and a half to trace the inner sides of the plain. In this plain Josephus places a fountain called Capharnaum: he says nothing of the town; but, as it can be collected from the Scriptural intimations that the town of Capernaum was in this same plain, it may be safely concluded that the fountain was not far from the town, and took its name therefrom. In this plain there are now two fountains, one called 'Ain el Madaurwarah, the 'Round Fountain'—a large and beautiful fountain, rising immediately at the foot of the western line of hills. This Pococke took to be the Fountain of Capernaum, and Dr. Robinson was at the time disposed to adopt this conclusion. There is another fountain called 'Ain et-Tin, near the northern extremity of the plain, and not far from the lake. It is overhung by a fig-tree, from which it derives its name. Near this are several other springs, the water of which is said to be brackish; but Burckhardt, who rested for some time under the great fig-tree, describes the water of the main

source as sweet. This is the fountain which Dr. Robinson inclines to regard as that which Josephus mentions under the name of Capharnaum; and the reasons which he assigns certainly make it appear preferable to the other fountain at the inner part of the plain. Whichever be the Capharnaum, we should look for some traces of an ancient town in the vicinity, and, finding them, should be justified in supposing that they formed the remains of Capernaum. There are no ancient remains of any kind near the Round Fountain, which is one of the reasons against its claim to indicate the site of ancient Capernaum. But near the 'Ain et-Tin is a low mound of ruins, occupying a considerable circumference, which certainly offer the best probability which has yet been offered of being the remains of the doomed city; and if these be all its remains, it has, according to that doom, been brought low indeed. Near the fountain is also a khan, which gives the name of Khan Minyeh to the spot. This khan is now in ruins, but was once a large and well-built structure. Close on the north of this khan, and of the fountain, rocky hills of considerable elevation come down quite to the lake, and form the northern termination of the plain. It is important to add, that Quaresmius expressly states, that in his day, the place called by the Arabs Minyeh, was regarded as marking the site of Capernaum (*Elucil.* t. s. ii. p. 864).

CAPHTHOR (כַּפְתֹּר; Deut. ii. 23; Jer. xlvii. 4; Amos ix. 7) was the real and proper country of the Philistines. There has been a great diversity of opinion with regard to the exact situation of that country. The general opinion that Caphthor was Cappadocia, is, upon the whole, founded more on the ancient versions of the Bible, such as the Septuagint and the Targums, than on any sound argument. Against this opinion have been urged:—1. The authority of Josephus, who seems to seek Caphthor somewhere between Egypt and Ethiopia; 2. That the Caphthorim came originally from Egypt, from which Cappadocia is so far removed, that it seems highly improbable that an Egyptian colony should first have emigrated thither, and then again removed to Palestine still more remote; 3. That Caphthor and Cappadocia are very dissimilar names even in sound; 4. That Caphthor is (Jer. xlvii. 4) designated as an island (יָם), though יָם sometimes also signifies a coast.

Others again, such as Calmet (*Dissert. sur l'Origine des Philistins*, p. 321), and still more J. G. Lackemacher (*Obs. Phil.* p. 2, 11, *sqq.*), have tried to prove that the Philistines derived their origin from the island of Crete, because—1. Caphthor is, with Jeremiah, an island, and—2. The proper name of the Philistines is כְּרִתִּים (*Ezek.* xxv. 16; *Zeph.* ii. 5; *1 Sam.* x. 14). The Sept., however, evidently makes a distinction between כַּפְתֹּרִים and כְּרִתִּים; nor is it probable that Crete should have been so populous, in the time of Abraham, as to send colonies to remote Palestine.

By far more probable is Calmet's previous opinion (found in the first edition of his *Comment. on Genesis*, but which he afterwards recalled), that Caphthor is the island of Cyprus. From the geographical situation of that island, it may have been known to the Egyptians at a very early pe-

riod, and they may have sent colonies thither, who afterwards removed, from some reason or other, to the southern coast of Palestine bordering on Egypt. Swinton (*Inscr. Cit.* Oxon. 1750, pp. 78, 85) actually found on that island an ancient Phœnician coin, with the inscription כַּבְדֹר (Kubdor), not very unlike כַּפְתֹר; but in the *Allgemeine Liter. Zeitung* (Leipsic, 1825, i. 440) it has been proved that Swinton was mistaken in the reading of that inscription. Forster (*Epist. ad Michael.* p. 17, *sq.*) thinks that the Caphthorim had lived on the Egyptian coast (as יָם in Jer. xlvii. 4 is also used of sea-coasts), somewhere about Darnietta. From hence, he supposes a colony of that people, and their brethren and easterly neighbours, the *Castuchim*, had gone forth, in the period between the first wars of the world (described in Gen. xiv.) and the birth of Isaac, and settled on the southern coast of Palestine, under the name of *Philistines*, after having expelled the Avim, who lived about Gaza [ΑΒΙΜ]. Only in subsequent times, Forster thinks, these new Philistines had again sent a colony who conquered the province of Lapethus, in the island of Cyprus. This colony he identifies with the Ethiopians, who lived, according to Herodotus (vii. 88), upon that island. There is much solid ground in favour of this opinion.—E. M.

CAPPADOCIA (Καππαδοκία), an ancient province of Asia Minor, bounded on the north by Pontus, on the east by the Euphrates and Armenia Minor, on the south by Mount Taurus (beyond which are Cilicia and Syria), and on the east by Phrygia and Galatia. The country is mountainous and abounds in water, and was celebrated for the production of wheat, for its fine pastures, and for its excellent breed of horses, asses, and sheep. The inhabitants were notorious for their dulness and vice. They were called 'Syrians' in the age of Herodotus (i. 72; v. 49), and even in Strabo's days they bore the name of 'Leuco-Syrians,' i. e. 'White Syrians' (xii. p. 544), in contradistinction to those dwelling beyond the Taurus, whose complexion was darkened by the sun. Cappadocia was subjugated by the Persians under Cyrus; but after the time of Alexander the Great it had kings of its own, who bore the common name of Ariarathes. It continued to be governed by tributary kings under the Romans till A.D. 17, when Tiberius made it a Roman province. Christianity was very early propagated in Cappadocia, for St. Peter names it in addressing the Christian churches in Asia Minor (1 Pet. i. 1). Cappadocians were present at Jerusalem on the day of Pentecost (*Acts* ii. 9).

CAPTIVITIES. The word *Captivity*, as applied to the people of Israel, has been appropriated, contrary to the analogy of our language, to mean Expatiation. The violent removal of the entire population of a city, or sometimes even of a district, is not an uncommon event in ancient history. As a measure of policy, no objection to it on the ground of humanity was felt by any one; since, in fact, it was a very mild proceeding, in comparison with that of selling a tribe or nation into slavery. Every such destruction of national existence, even in modern times, is apt to be embittered by the simultaneous disruption of religious bonds; but in the ancient world, the positive sanctity attributed to special places, and the local attachment of Deity, made expatriation doubly severe. The Hebrew people, for instance, in many

most vital points, could no longer obey their sacred law at all, when personally removed from Jerusalem; and in many others they were forced to modify it by reason of their change of circumstances.

Two principal motives impelled conquering powers thus to transport families in the mass: first, the desire of rapidly filling with a valuable population new cities, built for pride or for policy; next, the determination to break up hostile organizations, or dangerous reminiscences of past greatness. Both might sometimes be combined in the same act. To attain the former object, the skilled artisans would in particular be carried off; while the latter was better effected by transporting all the families of the highest birth, and all the well-trained soldiery. The Greeks used the special epithet *ἀνάσπαστοι* for a population thus removed (Herod. vi. 93, *et passim*).

The expatriation of the Jewish people belongs to two great eras, commonly called the first and second Captivity; yet differing exceedingly in character. It is to the former that the above remarks chiefly apply. In it, the prime of the nation were carried eastward by the monarchs of Assyria and Babylon, and were treated with no unnecessary harshness, even under the dynasty that captured them. So far were they from the condition of *bondsmen* (which the word 'captive' suggests), that the book of Susanna represents their elders in Babylon as retaining the power of life and death over their own people (i. 28), when Daniel was as yet a very young man. The authority of that book cannot indeed be pressed as to the chronology; yet the notices given by Ezekiel (xiv. 1; xx. 1) concur in the general fact, that they still held an internal jurisdiction over their own members. At a later time, under the Seleucidæ, we have distinct proof that in the principal cities the Jews were governed by an officer (*ἐθνάρχης*) of their own nation; as also in Egypt under the Ptolemies. The book of Tobit exhibits Israelites in Media possessed of slaves themselves (viii. 18); the book of Daniel tells us of a Jew, in eminent political station; and that of Esther celebrates their power and consequence in the Persian empire. Under the Seleucidæ [Ἀντιόχου] they were occasionally important as garrison-soldiers; and it may be suspected that, on the whole, their lot was milder than that of the other conquered nations among which they dwelt.

That which we name the first Captivity, was by no means brought about by a single removal of the population. In fact, from beginning to end, the period of deportation occupied full 150 years; as the period of return reaches probably through 100. The first blow fell upon the more distant tribes of Israel, about 741 B. C.; when Tiglath-pileser, king of Assyria (2 Kings xv. 29), carried off the pastoral population which lived beyond the Jordan, with Zebulun and Naphtali. (To this event allusion is made in Isaiah ix. 1; a passage very ill translated in our received version.) In the time of this conquering monarch, Assyria was rapidly rising into power, and to aggrandize Nineveh was probably a great object of policy. It is therefore credible, as he had received no particular provocation from the Israelites, that he carried off these masses of population to stock his huge city with. His successor Shalmanezar made the Israelitish king Hoshea tributary. When the tribute was

withheld, he attacked and reduced Samaria (B. C. 721), and, by way of punishment and of prevention, transported into Assyria and Media its king and all the most valuable population remaining to the ten tribes (2 Kings xvii. 6). That he did not carry off all the peasants is probable from the nature of the case; Hengstenberg however maintains the contrary (*Authentic des Pentateuches*, ch. i. 'On the Samaritan'). The families thus removed were, in great measure, settled in very distant cities; many of them probably not far from the Caspian Sea; and their place was supplied by colonies from Babylon and Susis (2 Kings xvii. 24). Such was the end of Israel as a kingdom.—An interval of more than a century followed before Judah was to suffer a similar fate. Two separate deportations are narrated in the book of Kings, three in that of Jeremiah, while a fourth and earlier one appears in the book of Daniel. Jeremiah dates by the years of Nebuchadnezzar's reign (who came to the throne B. C. 606 or 605), and estimates that in his seventh year 3023 were carried off, in his eighteenth 832, and in his twenty-third only 745; making in all, as the writer is careful to note, 4600 (Jer. lii. 28, &c.). The third removal he ascribes to Nebuzaradan, the Babylonian general. That some error here exists, at least in the *numbers*, appears undeniable; for 4600 persons was a very petty fraction of the Jewish people; and, in fact, 42,360 are stated to have returned immediately upon the decree of Cyrus (Ezra ii. 64). In 2 Kings xiv. 8-16, we find 18,000 carried off at once, in the third month of king Jehoiahin, and in the eighth year of Nebuchadnezzar; which evidently is the same as the first removal named by Jeremiah, and may be placed in B. C. 598. After this, the vassal king Zedekiah having rebelled, his city is beleaguered, and finally in his eleventh year is reduced (B. C. 588) by Nebuchadnezzar in person; and in the course of the same year, 'the nineteenth of Nebuchadnezzar' (2 Kings xxv. 8), Nebuzaradan carries away all the population except the peasants. Perhaps we need not wonder that no mention is made in the 'Kings' of the third deportation; for the account of the destruction was in a manner complete, upon the second invasion. There is a greater difficulty in the statement with which the book of Daniel opens, which is generally interpreted to mean that in the *third year* of Jehoiakim, Nebuchadnezzar besieged and captured Jerusalem, partially plundered the temple, and carried off the first portion of the people into captivity, among whom was Daniel. The text however does not explicitly say so much, although such is the obvious meaning; but if this is the only interpretation, we find it in direct collision with the books of Kings and Chronicles (which assign to Jehoiakim an *eleven years'* reign), as also with Jeremiah xxv. 1. The statement in Daniel partially rests on 2 Chron. xxxvi. 6; which is itself not in perfect accordance with 2 Kings xiv. In the earlier history, the war broke out during the reign of Jehoiakim, who died before its close; and when his son and successor Jehoiahin had reigned three months, the city and its king were captured. But in the Chronicles, the same event is made to happen twice over, at an interval of three months and ten days (2 Chron. xxxvi. 6 and 9), and even so, we do not obtain accordance with the received interpretation

of Daniel i. 1-3. It seems on the whole the easiest supposition, that 'the third year of Jehoiakim' is there a mistake for 'the third month of Jehoiachin.' Hengstenberg, however, and Havemick defend the common reading, and think they reconcile it with the other accounts. On the whole, it is pretty clear that the people of Judah, as of Israel, were carried out of their land by two principal removals. The former, B.C. 598, was directed to swell the armies and strengthen the towns of the conqueror; for of the 18,000 then carried away, 1000 were 'craftsmen and smiths, all strong and apt for war,' and the rest are called 'mighty men of valour.' (Yet there is a difficulty about verses 14 and 16 in 2 Kings xxiv.) It was not until the rebellion of Zedekiah that Nebuchadnezzar proceeded to the extremity of breaking up the national existence, B.C. 588. As the temple was then burnt, with all the palaces and the city walls, and no government was left but that of the Babylonian satrap, this latter date is evidently the true era of the captivity. Previously Zedekiah was tributary; but so were Josiah and Ahaz long before; and the national existence was still saved.

Details concerning the *Return* from the captivity are preserved in the books denominated after Ezra and Nehemiah; and in the prophecies of two contemporaries, Haggai and Zechariah. The first great event is the decree of Cyrus, B.C. 536, in consequence of which 42,360 Jews of Babylon returned under Sheshbazzar, with 7337 slaves, besides cattle. This ended in their building the altar, and laying the foundation of the second temple, 53 years after the destruction of the first. The progress of the work was, however, almost immediately stopped: for Zerubbabel, Jeshua and the rest abruptly refused all help from the half-heathen inhabitants of Samaria, and soon felt the effects of the enmity thus induced. That the mind of Cyrus was changed by their intrigues, we are not informed; but he was probably absent in distant parts, through continual war. (There is a difficulty in Ezra iv. as to the names Ahasuerus and Artaxerxes; yet the general facts are clear.)—When Darius (Hystaspis), an able and generous monarch, ascended the throne, the Jews soon obtained his favour. At this crisis, Zerubbabel was in chief authority (Sheshbazzar perhaps being dead), and under him the temple was begun in the second and ended in the sixth year of Darius, B.C. 520-516. Although this must be reckoned an era in the history, it is not said to have been accompanied with any new immigration of Jews. We pass on to 'the seventh year of king Artaxerxes' (Longimanus), Ezra vii. 7, that is, B.C. 458, when Ezra comes up from Babylon to Jerusalem, with the king's commendatory letters, accompanied by a large body of his nation. The enumeration in Ezra viii. makes them under 1800 males, with their families; perhaps amounting to 5000 persons, young and old: of whom 113 are recounted as having heathen wives (Ezra x. 18-43). In the twentieth year of the same king, or B.C. 445, Nehemiah, his cupbearer, gains his permission to restore 'his fathers' sepulchres,' and the walls of his native city; and is sent to Jerusalem with large powers. This is the crisis which decided the national restoration of the Jewish people: for before their city was fortified, they had no defence against the now confirmed enmity of their Samaritan neighbours; and, in fact, before the walls could

be built, several princes around were able to offer great opposition [SANBALLAT]. The Jewish population was overwhelmed with debt, and had generally mortgaged their little estates to the rich; but Nehemiah's influence succeeded in bringing about a general forfeiture of debts, or at least of the interest: after which we may regard the new order of things to have been finally established in Judæa [NEHEMIAH]. From this time forth it is probable that numerous families returned in small parties, as to a secure home, until all the waste land in the neighbourhood was re-occupied.

There has been great difference of opinion, as to how the 70 years of captivity spoken of by Jeremiah (xxv. 12; xxix. 10) are to be estimated. A plausible opinion would make them last from the destruction of the first temple, B.C. 588, to the finishing of the second, B.C. 516: but the words of the text so specify 'the punishing of the king of Babylon' as the end of the 70 years—which gives us the date B.C. 538—that many, with Jahn, cling to the belief that a first captivity took place in the third year of Jehoiakim, B.C. 605. Winer, on the contrary, suspects that a desire to make out the 70 years in this way, has generated the story in Daniel, so irreconcilable with the books of Kings and of Jeremiah. But, in fact, if we read Jeremiah himself, it may appear that in ch. xxv. he intends to compute the 70 years from the time at which he speaks (ver. 1, 'in the fourth year of Jehoiakim,' i. e. B.C. 604); and that in xxix. 10 the number 'seventy years' is still kept up, in remembrance of the former prophecy, although the language there used is very lax.

The great mass of the Israelitish race nevertheless remained in dispersion. Previous to the captivity, many Israelites had settled in Egypt (Zech. x. 11; Isa. xix. 18), and many Jews afterwards fled thither from Nebuzaradan (Jer. xli. 17). Others appear to have established themselves in Sheba (see Jost's *Geschichte* &c), where Jewish influence became very powerful (SHEBA).

It is maintained by Von Bohlen (*Genesis*, p. cxvi.) that the ten tribes intermarried so freely with the surrounding population as to have become completely absorbed; and it appears to be a universal opinion that no one now knows where their descendants are. But it is a harsh assumption that such intermarriages were commoner with the ten tribes than with the two; and certainly, in the apostolic days, the *twelve* tribes are referred to as a well-known people, sharply defined from the heathen (James i. 1; Acts xxiv. 7). Not a trace appears that any repulsive principle existed at that time between the Ten and the Two. 'Ephraim no longer envied Judah, nor Judah vexed Ephraim;' but they had become 'one nation;' though only partially 'on the mountains of Israel' (Isa. xi. 13; Ezek. xxxvii. 22). It would seem, therefore, that one result of the captivity was to blend all the tribes together, and produce a national union which had never been effected in their own land. If ever there was a difference between them as to the books counted sacred, that difference entirely vanished; at least no evidence appears of the contrary fact. When, moreover, the laws of landed inheritance no longer enforced the maintenance of separate tribes and put a difficulty in the way of the intermarriage, an almost inevitable result in course of time was the entire obliteration of this distinction,

and as a fact, no modern Jews know to what tribe they belong, although vanity always makes them choose to say that they are of the two or three, and not of the ten tribes. That all Jews now living have in them the blood of all the twelve tribes, ought (it seems) to be believed, until some better reason than mere assertion is advanced against it.

When Cyrus gave permission to the Israelites to return to their own country, and restored their sacred vessels, it is not wonderful that few persons of the ten tribes were eager to take advantage of it. In two centuries they had become thoroughly naturalized in their eastern settlements; nor had Jerusalem ever been the centre of proud aspirations to them. It is perhaps remarkable, that in *Ezra* ii. 2, 36 (see also x. 18, 25), the word *Israel* is used to signify what we might call the Laity as opposed to the priests and Levites; which might seem as though the writer were anxious to avoid asserting that all the families belonged to the two tribes. (If this is not the meaning, it at least shows that all discriminating force in the words *Israel* and *Judah* was already lost. So, too, in the book of *Esther*, the twelve tribes through all parts of the Persian empire are called Jews.) Nevertheless, it was to be expected that only those would return to Jerusalem whose expatriation was very recent; and principally those whose parents had dwelt in the Holy City or its immediate neighbourhood. The re-migrants doubtless consisted chiefly of the pious and the poor; and as the latter proved docile to their teachers, a totally new spirit reigned in the restored nation. Whatever want of zeal the anxious *Ezra* might discern in his comrades, it is no slight matter that he could induce them to divorce their heathen wives—a measure of harshness which *St. Paul* would scarcely have sanctioned (*1 Cor.* vii. 12): and the century which followed was, on the whole, one of great religious activity and important permanent results on the moral character of the nation. Even the prophetic spirit by no means disappeared for a century and a half; although at length both the true and the false prophet were supplanted among them by the learned and diligent scribe, the anxious commentator, and the over-literal or over-figurative critic. In place of a people prone to go astray after sensible objects of adoration, and readily admitting heathen customs; attached to monarchical power, but inattentive to a hierarchy; careless of a written law, and movable by alternate impulses of apostasy and repentance; we henceforth find in them a deep and permanent reverence for *Moses* and the prophets, an aversion to foreigners and foreign customs, a profound hatred of idolatry, a great devotion to priestly and Levitical rank, and to all who had an exterior of piety; in short, a slavish obedience both to the law and to its authorized expositors. Now first, as far as can be ascertained (observe the particularity of detail in *Neh.* viii. 4, &c.), were the synagogues and houses of prayer instituted, and the law periodically read aloud. Now began the close observance of the Passover, the Sabbath, and the Sabbatical year. Such was the change wrought in the guardians of the Sacred Books, that, whereas the pious king *Josiah* had sat eighteen years on the throne without knowing of the existence of 'the Book of the Law' (2

Kings xxii. 3, 8); in the later period, on the contrary, the text was watched over with a scrupulous and fantastic punctiliousness. From this era, the civil power was absorbed in that of the priesthood, and the Jewish people affords the singular spectacle of a nation in which the priestly rule came later in time than that of hereditary kings. Something analogous may perhaps be seen in the priestly authority at *Comana* in *Cappadocia* under the Roman sway (*Cicero*, *Ep. ad Div.* xv. 4, &c.).

In their habits of life also, the Jewish nation was permanently affected by the first captivity. The love of agriculture, which the institutions of *Moses* had so vigorously inspired, had necessarily declined in a foreign land; and they returned with a taste for commerce, banking, and retail trade, which was probably kept up by constant intercourse with their brethren who remained in dispersion. The same intercourse in turn propagated towards the rest the moral spirit which reigned at Jerusalem. The Egyptian Jews, it would seem, had gained little good from the contact of idolatry (*Jer.* xliv. 8); but those who had fallen in with the Persian religion, probably about the time of its great reform by *Zoroaster*, had been preserved from such temptations, and returned purer than they went. Thenceforward it was the honourable function of Jerusalem to act as a religious metropolis to the whole dispersed nation; and it cannot be doubted that the ten tribes, as well as the two, learned to be proud of the Holy City, as the great and free centre of their name and their faith. The same religious influences thus diffused themselves through all the twelve tribes of Israel.

Thus in *Egypt* and *Arabia*, in *Babylonia*, *Assyria*, *Media*, masses of the nation were planted, who, living by traffic and by banking, were necessitated to spread in all directions as their numbers increased. By this natural progress they moved westward, as well as eastward, and, in the time of *St. Paul*, were abundant in *Asia Minor*, *Greece*, and the chief cities of *Italy*.

The extermination suffered by the Jewish inhabitants of Palestine, under the Romans, far better deserves the name of captivity: for after the massacre of countless thousands, the captives were reduced to a real bondage. According to *Josephus* (*De Bell. Jud.* vi. 9. 3), 1,100,000 men fell in the siege of Jerusalem by *Titus*, and 97,000 were captured in the whole war. Of the latter number, the greatest part was distributed among the provinces, to be butchered in the amphitheatres or cast there to wild beasts; others were doomed to work as public slaves in *Egypt*: only those under the age of seventeen were sold into private bondage. An equally dreadful destruction fell upon the remains of the nation, which had once more assembled in *Judæa*, under the reign of *Hadrian* (A.D. 133), which *Dion Cassius* concisely relates: and by these two savage wars, the Jewish population must have been effectually extirpated from the Holy Land itself, a result which did not follow from the Babylonian captivity. Afterwards, a dreary period of fifteen hundred years' oppression crushed in Europe all who bore the name of Israel, and Christian nations have visited on their head a crime perpetrated by a few thousand inhabitants of Jerusalem, who were not the real forefathers of the European

Jews. Nor in the East has their lot been much more cheering. With few and partial exceptions, they have ever since been a despised, an oppressed, and naturally a degraded people; though from them have spread light and truth to the distant nations of the earth.—F. W. N.

CARAVAN (كروان) is the name given to a body of merchants or pilgrims as they travel in the East. A multitude of people, of all ages and conditions, assembling to undertake a journey, and prosecuting it *en masse* for days and weeks together, is a thing unknown in Europe, where, from the many facilities for travelling, and a well organized system of police, travellers can go alone and unprotected along the highways to any distance with the most perfect security. But troops of people on march are a common spectacle along the roads of Eastern countries; and, indeed, the nature of the countries in many places, as well as the disorderly state of society, points out the only practicable way of travelling to be in large caravans. The dangers arising from the vast deserts that intersect these regions, as well as from wild beasts and bands of marauding Arabs, are too numerous and imminent for single traders or solitary travellers to encounter; and hence merchants and pilgrims are accustomed to unite for mutual protection in traversing these wild and inhospitable parts, as well as for offering a more effectual resistance to the attacks of robbers. Through this kind of intercourse, which principally obtains in Turkey, Persia, and Arabia, most of the inland commerce of the East is carried on; and certainly of all the various modes in which the commodities of one country are conveyed to another, it is the cheapest and the most expeditious, as the possession of the camel affords facilities for journeying over barren and sandy regions, which would be inaccessible to wheel-carriages, and the difficulties and privations of which no beast of burden but this invaluable creature could endure. The company composing a caravan is often very numerous, consisting, it may be, of several hundred persons, and as many thousand camels; and it may be supposed that the assembling of so many individuals, together with the orderly distribution of their respective bales of merchandise and travelling equipage, is an affair requiring both time and the most careful attention. Accordingly, the packing and unpacking of the camels, as well as the general service of the caravans, employ a great many hands, some of whom, by dint of economy and active habits, often raise themselves from the condition of servants to the more respectable status of merchants, who travel on their own account or in the capacity of carriers. Any person can, under certain regulations, form a caravan at any time. But generally there are stated periods, which are well known as the regular starting-times for the mercantile journeys; and the merchants belonging to the company, or those travellers who are desirous of accompanying it for the benefit of a safe conduct, repair to the place of rendezvous where the caravan is to be formed, exhibiting, as their goods and camels successively arrive, a motley group—a busy and tumultuous scene of preparation, which can be more easily conceived than described. As in the hot season the travelling is performed under night, the previous part of the

day on which the caravan leaves is consumed in the preparatory labours of packing—an indispensable arrangement, which has been observed with unbroken uniformity since the days of Ezekiel (xii. 3); and then, about eight o'clock, the usual starting-time, the whole party put themselves in motion, and continue their journey without interruption till midnight (Luke xi. 5, 6) or later. At other seasons they travel all day, only halting for rest and refreshment during the heat of noon. The distances are measured by a day's journey; and from seven to eight hours seem to have been a usual day's journey for caravans (Hornemann, p. 150); so that, estimating the slow and unwieldy gait of a camel at $2\frac{1}{2}$ miles an hour, the average rate of travel will be from 17 to 20 miles per day.

The earliest caravan of merchants we read of is the itinerant company to whom Joseph was sold by his brethren (Gen. xxxvii.). 'Here,' says Dr. Vincent, 'upon opening the oldest history in the world, we find the Ishmaelites from Gilead, conducting a caravan loaded with the spices of India, the balsam and myrrh of Hadramaut, and in the regular course of their traffic proceeding to Egypt for a market. The date of this transaction is more than seventeen centuries before the Christian era, and notwithstanding its antiquity, it has all the genuine features of a caravan crossing the desert at the present hour' (*Commerce and Navig. of the Ancients*, vol. ii. p. 262). This caravan was a mixed one, consisting of three classes, Ishmaelites (ver. 25), Midianites (ver. 28), and Medanites, as the Hebrew calls the last (ver. 36), who, belonging to the mountainous region of Gilead, would seem, like the nomade tribes of Africa in the present day, to have engaged themselves as commercial travellers, and were then, in passing over the plain of Dothan, on the high caravan-road for the market of Egypt. This circumstance, though minute, and incidentally introduced, is a beautiful confirmation of the truth of Scripture history; for it is well known that the ancient Egyptians were not addicted to commerce, and that all their traffic was thrown into the hands of foreigners, who by overland carriage regularly imported the productions of other countries—slaves, from Ethiopia; incense, from Arabia; and spices, from India—into Egypt, which was then, as it has been in all ages, the emporium of the Southern and Western nations.

Besides these communities of travelling merchants in the East, there are caravans of pilgrims, *i. e.* of those who go for religious purposes to Mecca, comprising vastly greater multitudes of people. Four of these start regularly every year: one from Cairo, consisting of Mahommedans from Barbary; a second from Damascus, conveying the Turks; a third from Babylon, for the accommodation of the Persians; and a fourth from Zibith, at the mouth of the Red Sea, which is the rendezvous for those coming from Arabia and India. The organization of the immense hordes which, on such occasions, assemble to undertake a distant expedition, strangers to each other, and unaccustomed to the strict discipline which is indispensable for their comfort and security during the march, though, as might be expected, a work of no small difficulty, is accomplished in the East by a few simple arrangements which are the result of long experience. One obvious bond of union

to the main body, when travelling by night and through extensive deserts, is the music of the Arab servants, who by alternate songs in their national manner beguile the tedium of the way; while the incessant jingling of innumerable bells fastened to the necks of the camels—a characteristic feature of Oriental caravans—enlivens the patient beasts, frightens animals of prey, and keeps the party together. To meet all the exigencies of the journey, however, which would be a task impracticable without the establishment of some kind of order, and a prudent division of labour, the caravan is placed under the charge of a *caravan bashè*, the chief who presides over all, and under whom there are five leading officers appointed to different departments:—one who regulates the march; a second, whose duties only commence at halting time; a third who superintends the servants and cattle; a fourth who takes charge of the baggage; a fifth who acts as paymaster, &c.; and besides these, there are the officers of the military escort that always accompanies it. One functionary of the highest importance remains to be noticed—the *hybeer*, or guide, a word derived by Bruce from the Arabic verb *hubbar*, to inform or direct, and whose services are indispensable in crossing the great deserts, such as that along the coast of the Red Sea or on the western extremities of Africa. He is commonly a person of influence, belonging to some powerful tribe, whose valuable assistance on an emergency may by his means be obtained; and, besides the indispensable qualities of truth and fidelity, his personal qualifications must embrace an extensive and accurate acquaintance with the whole features of the land. For as he has the lives and property of all in his power, it is absolutely necessary that he understand the prognostics of the weather, the time and places where the terrible simoom or hot wind blows, and the tracts occupied by shifting sands; and that he know the exact locality and qualities of the wells, the oases that afford the refreshments of shade for the men and grass for the cattle, the situation of hostile or treacherous tribes, and the means of escaping those threatened dangers.

This description of the general economy of caravans we follow up by the account given by Pitts of the Hadj caravan which he accompanied to Mecca, and embracing so many minute details, that it may be both interesting and instructive to the reader to be furnished with it in the traveller's own words. 'The first day,' says he, 'we set out from Mecca, it was without any order at all—all hurly-burly; but the next day every one laboured to get forward, and in order to do it there was many times much quarrelling and fighting. But after every one had taken his place in the caravan, they orderly and peaceably kept the same place till they came to Grand Cairo. They travel four camels abreast, which are all tied one after another like as in teams. The whole body is divided into several *cottors*, or companies, each of which has its name, and consists, it may be, of several thousand camels; and they move, one *cottor* after another, like distinct troops. At the head of each *cottor* is some great gentleman or officer, who is carried in a thing like a litter, borne by two camels, one before and the other behind. At the head of every *cottor* there goes likewise a sumpter camel, which carries his treasure,

&c. This camel has two bells, hanging one on each side, the sound of which may be heard a great way off. Others of the camels have bells round about their necks, like those which our carriers put about their fore-horse's neck; which, together with the servants who belong to the camels, and travel on foot, singing all night, make a pleasant noise, and the journey passes away delightfully. Thus they travel in good order every day till they come to Grand Cairo; and were it not for this order, you may guess what confusion would be among such a vast multitude. They have lights by night (which is the chief time of travelling, because of the exceeding heat of the sun), which are carried on the top of high poles, to direct the hadjis, or pilgrims, on their march. These are somewhat like iron stoves, into which they put short dry wood, which some of the camels were loaded with: it is carried in great sacks, which have a hole near the bottom, where the servants take it out as they see the fire needs a recruit. Every *cottor* has one of these poles belonging to it, some of which have ten, some twelve, of these lights on their tops, or more or less: they are likewise different in figures as well as in numbers—some perhaps oval-way, like a gate; another triangular, or like N or M, &c.; so that every one knows by them his respective *cottor*. They are carried in the front, and set up in the place where the caravan is to pitch, before that come up, at some distance from one another. They are also carried by day, not lighted; but yet, by the figure and number of them, the hadjis are directed to what *cottor* they belong, as soldiers are by their colours where to rendezvous; and without such directions it would be impossible to avoid confusion in such a vast number of people.'

This description of the Hadj caravans that travel yearly to Mecca, bears so close a resemblance to the far-famed journey of the Israelites through almost the same extensive deserts, that, as the arrangement of those vast travelling bodies seems to have undergone no material alteration for nearly four thousand years, it affords the best possible commentary illustrative of the Mosaic narrative of the Exodus. Like them, the immense body of Israelitish emigrants, while the chief burden devolved on Moses, was divided into companies, each company being under the charge of a subordinate officer, called a prince (Num. vii.). Like them, the Hebrews made their first stage in a hurried manner and in tumultuous disorder (Exod. xii. 11); and, like them, each tribe had its respective standard, the precise form and device of which, amid the conflicting accounts of the Rabbins, it is not easy to determine [STANDARDS]; but which, of whatever description it was, was pitched at the different stages, or thrust perpendicularly into the ground, and thus formed a central point, around which the straggling party spread themselves during their hours of rest and leisure (Num. ii. 2). Like them, the signal for starting was given by the blast of a trumpet, or rather trumpets (Num. x. 2, 5); and the time of march and halting was regulated by the same rules that have been observed by all travellers from time immemorial during the hot season. Like theirs, too, the elevation of the standard, as it was borne forward in the van of each company, formed a prominent object to prevent dispersion, or

enable wanderers to recover their place within the line or division to which they belonged. Nor was there any difference here, except that, while the Israelites in like manner prosecuted their journey occasionally by night as well as by day, they did not require the aid of fires in their standards, as the friendly presence of the fiery pillar superseded the necessity of any artificial lights. One other point of analogy remains to be traced in the circumstance of Hobah being enlisted in the service of the Hebrew caravan as its guide through the great Arabian desert. At first sight, the extreme solicitude of Moses to secure his brother-in-law in that capacity may appear strange, and not easily reconcilable with the fact that they enjoyed the special benefit of a heavenly guide, who had guaranteed, in a supernatural manner, to direct their progress through the wilderness. But the difficulty will vanish when it is borne in mind, that although the pillar of cloud by day and of fire by night sufficed to regulate the main stages of the Hebrews, foraging parties would at short intervals require to be sent out, and scouts to reconnoitre the country for fuel, or to negotiate with the native tribes for provender and water. And who so well qualified to assist in these important services as Hobah, from his intimate acquaintance with the localities, his influence as a Sheikh, and his family connection with the leader of Israel?

The nature and economy of the modern Hadj caravans might be applied also to illustrate the return of the Hebrew exiles under Ezra from the land of their captivity.

The bands of Jewish pilgrims that annually repaired from every corner of Judæa to attend the three great festivals in Jerusalem, wanted this government and distribution into distinct companies, and seem to have resembled less the character of the great Mecca caravans than the irregular processions of the Hindoos to and from the scene of some of their religious pageants. On such occasions multitudes of men, women, and children, amounting to ten or twenty thousand (Roberts' *Oriental Illustrations*, and Ward's *View of the Hindoos*), may be seen bending their way to the place of ceremonial, with their beds, cooking implements, and other luggage on their heads, prosecuting their journey in this manner from day to day, by long or shorter stages, as custom or physical strength may dictate. As in a crowd of this motley description not the slightest regard is paid to regularity or order, and every one of course takes the place or mingles with the group that pleases him, the separation of the nearest friends for a whole day must, in such circumstances, be a common and unavoidable occurrence; and yet anxiety is never felt, unless the missing one fail to appear at the appointed rendezvous of the family. In like manner among the ancient Jews, the inhabitants of the same village or district would naturally form themselves into travelling parties, for mutual security as well as for enjoying the society of acquaintance. The poorer sort would have to travel on foot, while females and those of the better class might ride on asses and camels. But as their country was divided into tribes, and those who lived in the same hamlet or canton would be more or less connected by family ties, the young, the volatile,

and active among the Jewish pilgrims had far more inducements to disperse themselves amongst the crowd than those of the modern processions, numbers of whom are necessarily strangers to each other. In these circumstances it is easy to understand how the young Jesus might mingle successively with groups of his kindred and acquaintance, who, captivated with his precocious wisdom and piety, might be fond to detain him in their circle, while his mother, together with Joseph, felt no anxiety at his absence, knowing the grave and sober character of their companions in travel; and the incident is the more natural that his parents are said to have gone 'one day's journey' from Jerusalem before they missed him; since, according to the present, and probably the ancient, practice of the East, the first stage is always a short one, seldom exceeding two or three hours. Micmasli—the modern El Vyra, where Mary's discovery is reputed to have been made—is, according to Mr. Munro (*Summer Ramble*, vol. i. p. 265), scarcely three miles from Jerusalem, where the caravan of Galilæan pilgrims halted.—R. J.

CARAVANSERAIS. In the days of the elder patriarchs, there seem to have been no places specially devoted to the reception of travellers, at least in the pastoral districts frequented by those venerable nomades; for we find Abraham, like the Oriental shepherds of the present day, under a strong sense of the difficulties and privations with which journeying in those regions was attended, deeming it a sacred duty to keep on the outlook, and offer the wayfaring man the rites of hospitality in his own tent. Nor could the towns of Paies-

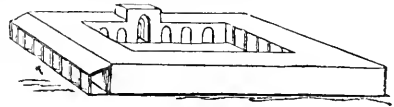

207.

tine, as it would seem, at that remote period, boast of any greater advance with respect to establishments of this sort; for the angelic strangers who visited Lot in Sodom were entertained in his private house; and on the tumultuous outrage occasioned by their arrival disinclining them to subject his family to inconvenience and danger by prolonging their stay, they announced their intention to lodge in the streets all night. This elicited no surprise, nor any other emotion than a strenuous opposition on the part of their kind-hearted host to their exchanging the comforts of his home for a cheerless exposure to the cold and dews of midnight; and hence we conclude that the custom, which is still frequently witnessed in the cities of the East, was then not uncommon, for travellers who were late in arriving, and who had no introductions to a private family, to bivouac in the streets, or wrapping themselves up in the ample folds of their hykes, to pass the night as they best could in the open air. In the Arab towns and villages, however, when a traveller arrives in the daytime, the sheikh, or some principal person of the place, goes out to welcome him, and treats him with great civility in his own house; or else he conducts him to the *menzil*, which, though a place of rather a nondescript character, is understood to be the house occupied by those who entertain strangers, when there are no other lodgings, and to which the women in the sheikh's

house, having surveyed the number of the guests, send provisions of every kind according to the season, and provide every accommodation the place can afford (*La Roque, De la Palestine*, p. 124).

The first mention of an inn, or house set apart for the accommodation of travellers, occurs in the account of the return of Jacob's sons from Egypt (*Gen. xlii. 27*); and as it was situated within the confines of that country, and at the first stage from the metropolis, it is probable that the erection of such places of entertainment originated with the Egyptians, who were far superior to all their contemporaries in the habits and the arts of civilized life, and who, though not themselves a commercial people, yet invited to their markets such a constant influx of foreign traders, that they must have early felt the necessity and provided the comforts of those public establishments. The 'inns' where travellers lodge in the East do not, however, bear the least resemblance to the respectable houses of the same class in this country, much less do they approximate to the character and appurtenances of European hotels. The Egyptian inn, where the sons of Israel halted to bait their asses, was probably, from the remote period to which it belonged, of a rude and humble description, in point both of appearance and accommodation—merely a shed, under the roof of which the cattle and their drivers might obtain shelter from the heats of noon and the dews of midnight; and such is the low state of art, or the tyrannical force of custom in the East, that establishments of this kind in the present day can, with few exceptions, boast of improvements, that render them superior to the mean and naked poverty of those which received the pilgrims of the patriarchal age.

خان *khan*, or **کروانسرائی** *karavanserai*, is the name which this kind of building bears; and though the terms are often applied indiscriminately, there is an acknowledged distinction, which seems to be, that *khan* is applied to those which are situated in or near towns, whereas *caravanserais* (a lodge for caravans, as the compound word imports) is the more appropriate designation of such as are erected in desert and sequestered places. A *khan* is always to be found in the neighbourhood of a town; and while houses corresponding to the description of the other are generally disposed at regular stages along public and frequented roads, they are more or less numerous in proportion to the relative distances of towns, and the populous or desert state of the country. Some are provided at the public expense, or owe their existence to devoted Mussulmans, who bestow a portion of their wealth, as a meritorious act of charity, in promoting the comfort and refreshment of pilgrims; while others are erected by the contributions of private merchants for their own accommodation. The latter, of course, are the most spacious, the most elegant and best appointed; but though varying in character and size, this class of establishments preserves so generally the same uniform plan of construction, that a description of one may serve to convey an idea of all. Let the reader imagine, then, a large edifice, which, though in the distance it seems an immense pile, resembling a castellated fort, on a nearer approach loses much of this for-

midable appearance, when it is found that no part of the building rises above the enclosing wall. It presents the form of a square, the sides of which, about 100 yards in length each, are surrounded by an external wall of fine brickwork, based on stone, rising generally to the height of twenty feet. In the middle of the front wall there is a wide and lofty archway, having on one or both sides a lodge for the porter and other attendants; while the upper part of it, being faced with carving or ornamental mason-work, and containing several rooms, surmounted by elegant domes, is considered the most honourable place of the building, and is therefore appropriated to the use of the better sort. This archway leads into a spacious rectangle, the area forming a courtyard for cattle, in the midst of which is a well or fountain. Along the sides of the rectangle are piazzas extending the whole length, and opening at every few steps into arched and open recesses, which are the entrances into the travellers' apartments. An inner door behind each of these conducts to a small oblong chamber, deriving all its light from the door, or from a small open window in the back wall entirely destitute of furniture, and affording no kind of accommodation in the way of presses or shelves, except some rude niches excavated in the thick walls. This cell is intended for the dormitory of the traveller, who generally prefers, however, the recess in front for sitting in under shade during the daytime, as well as for sleeping in during the night, when the season allows; being the more adapted for this purpose that the floor is neatly paved, or consists of a smooth bed of earth, on a platform rising two or three feet above the level of the area. There being no other door but the entrance arch, each occupant remains isolated in his own quarters, and is cut off from all communication with the other inmates of the *caravanserai*. But in the middle of each of the three sides there is a large hall, which serves as a travellers' room, where all may indiscriminately assemble: while at the end of each side there is a staircase leading to the flat roof of the house, where the cool breeze and a view of the surrounding country may be enjoyed. These chambers generally stand on the ground-floor, which is a few feet above the level of the court-yard; but in the few buildings of this sort which have two stories, the travellers are accommodated above, while the under flat is reserved for the use of their servants, or appropriated as warehouses for goods. And in such establishments there is found one other additional advantage in having a supply of servants and cooks, as well as a shop in the porter's house, where all commodities may be procured. *Caravanserais* of this superior class, however, are rarely to be met with. The most part are but wretched lodging-places—filled, it may be, with dirt and vermin—consisting only of bare walls, in which not an article of furniture is to be seen, nor a cooking utensil to be found, nor provisions of any sort to be obtained for love or money. The traveller must carry along with him, as well as provide with his own hands, whatever is necessary for his use and comfort. If he performs his journey on camels or on horseback, he must, on arriving at the stage, act as his own ostler, tie up his beast, and distribute its provender and litter. To supply the want of a divan and bed, he must take his mat and carpet, which, folded up, may have

served him for a saddle, and squat upon the floor, or repose himself at night; or if he is a pedestrian, and must travel as lightly as possible, he makes the cloak which he wears by day discharge the office of a counterpane by night. In the victualling department he finds as great a dearth as in that of furniture. He must subsist on the supply of food and articles of luxury he may have had the foresight to provide, and husband them as well as he can, as no addition to his stores can be made till he reaches the next town. In general he must content himself with a plain diet of dry bread, fruits, or such prepared viands as admit of preservation; or if he wishes a fresh cooked meal, he must himself furnish the fuel, kindle the fire, superintend the boil or the roast, as well as wash and arrange his eating-pan. 'The baggage of a man, therefore, who wishes to be completely provided,' says Voluey, 'consists of a carpet, a mattress, a blanket, two saucerpans, with lids, contained within each other; two dishes, two plates, &c., coffee-pot, all of copper well timed. A small wooden box for salt and pepper, a round leather table, which he suspends from the saddle of his horse, small leather bottles or bags for oil, melted butter, water, a pipe, a tinder-box, a cup of cocoa-nut, some rice, dried raisins, dates, Cyprus cheese, and, above all, coffee berries, with a roaster and wooden mortar to pound them.' Every one, although his travelling equipage may not be so complete as this, must find several of these items and implements indispensable to existence during a journey in the East; for in many of the khans or caravanserais to which he may come, he can look for nothing from the keeper except to show him the way to his chamber, and give him the key if it is furnished with a door. One assistance only he may depend upon, and it is no inconsiderable one,—that of receiving some attendance and aid if overtaken by sickness; for one of the requisite qualifications for the office is, that the functionary possess a knowledge of simples, and the most approved practice in case of fracture or common ailments. And hence the good Samaritan in the parable (Luke x. 30), although he was obliged, in the urgency of the case, himself to apply from his own viaticum a few simple remedies for the relief of the distressed man, left him with full confidence to be treated and nursed by the keeper of the khan, whose assiduities in dressing the wounds and bruises of his patient might be quickened, perhaps, by the liberal remuneration he was promised, as well as by the example of the humane traveller.

Among the Egyptians, and indeed among the ancients generally, the keepers of houses of public entertainment were always women (Herod. ii. 35); and hence we can easily account for the ready admission which the spies obtained into the house of Rahab, 'on the wall of Jericho,' situated, as such houses were, for the reception of strangers, for the most part at the gate or entrance into the town (Josh. ii. 1). This woman is called a harlot in our translation. But the Hebrew, *זונה* *zonah*, signifies also the landlady of an inn or tavern—most of whom, doubtless, in ancient times, were women of easy virtue—the more so as the idolatrous religion to which they were educated encouraged prostitution: and hence there being only a single word in the original descriptive of both professions, and the first having been adopted

by the Septuagint, which was the common version of the Jews in the days of Paul and James (Heb. xi. 31; James ii. 25), those two Apostles might have used the same expression that they found there. The original Hebrew, however, admits of being translated by another word, to which no degrading or infamous associations are attached.

The preceding observations on the ancient and existing accommodation for journeying in the East, will serve to illustrate many passages in the sacred volume, where allusions are made to incidents of travel. The state of Judæa, however, in the time of Christ and the Apostles, was, probably, in respect to means of communication, much superior to that of any Oriental country in the present day; and we may be disposed to conclude that for the encouragement of intercourse between distant parts, that country was then studded with houses of public entertainment on a scale of liberal provision at present unknown in the same quarter of the world. But the warm commendations of hospitality so frequently met with in the works of contemporary classical writers, as well as the pressing exhortations of the inspired Apostle to the practice of that virtue, too plainly prove that travellers were then chiefly dependent on the kindness of private individuals. The strong probability is, that the 'inns' mentioned in the New Testament find their true and correct representations in the Eastern khans and caravanserais of the present day; and that, although the Jews of that period could not have been acquainted with the largest and most magnificent of this class of buildings, which do not date earlier than the commencement of the Mecca caravans, and which the devotion of opulent Mussulmans then began to erect for the accommodation of the pilgrims, they had experience of nothing better than the bare walls and cell-like apartments of such edifices as we have described above. Bishop Pearce, Dr. Campbell, and others, indeed, have laboured to show that *κατάλυμα*, the word used by Luke to denote the place whence Mary was excluded by the previous influx of strangers, is not synonymous with *πανδοχείον*, the house to which the good Samaritan brought the wounded stranger, although in both instances our translators, for want of corresponding terms in the English language, have indiscriminately rendered it by 'inn.' *Κατάλυμα* signifies the guest-chamber (Mark xiv. 14; Luke xxii. 11); and it is extremely probable that, as upper-rooms were always the largest in a house, and most suitable for the reception of a numerous company, every respectable householder in Jerusalem appropriated one gratuitously to his friends, who flocked to Jerusalem at the annual feasts, and who from that circumstance might call it their 'inn.' *Πανδοχείον*, again, was a house set apart for the accommodation of all strangers who could pay for their lodging and entertainment; and as the name, 'receiver of everything,' seems to imply, was of a mean description, having no partition wall, men and cattle being both included under the same roof, the former occupying one side, and the latter the other. Beth-lehem being the chief city of the family of David, a *κατάλυμα* might have been placed, by the kindness of some friend, at the service of Joseph and Mary, who were wont to resort to it as often as business or

friendship called them to town. But as the same privilege might have been offered to others, who, owing to the general census, flocked in such unnumbered numbers, that the first comers completely occupied every vacant space, they were obliged to withdraw to the *πανδοχείον*, where, in the only retired corner, viz., at the head of the cattle, the mother of Jesus brought forth her child. This explanation of these eminent critics, however, does not invalidate, nor in the least degree affect the views we have advanced respecting the general resemblance of the ancient inns of Judæa to the modern khans or caravanserais; for in these, as well as in the *καταλύματα*, persons are generally admitted without payment. And occasions are constantly occurring to set multitudes on travel, many of whom are driven, like Joseph and Mary, for want of room, from the inn to the adjoining stables.

Many caravanserais, however, have not the accommodation of stables, the cattle being allowed to range in the open area; and hence has arisen an opinion warmly espoused by many learned writers, and supported by a venerable tradition, that our Lord was born in an adjoining shed, or probably in a subterranean cave, like the grotto that is sometimes connected with the fountain of the place (Justin Martyr, *Dial. with Trypho*, p. 303; Origen, *Cont. Cels.*). [ΒΗΤΥΛΗΝΕΜ.] Moreover, much learning has been expended on the word *φάτνη*, which our translators have rendered 'manger;' although it is capable of the clearest demonstration, that the ancients, equally with the modern inhabitants of the East, are strangers to the conveniences which go under that name in European stables. The anecdote, quoted by Campbell from Herodotus, respecting Mardonius, the Persian general, having brought with him a brazen manger for his horses, only establishes our remark, proving as it does that those ancient mangers were more like troughs than the crib out of which our horses are fed; and, indeed, in the only other place in the New Testament where *φάτνη* occurs, it is rendered 'stall;' that is, not the thing out of which the cattle ate, but the place from which they ate (see Parkhurst, in loco). No explanation, however, that we have met with, appears so satisfactory, and conveys such an intelligible picture to the eye, as that given by the editor of the *Pictorial Bible* (Luke ii. 7); with whose words we shall conclude this article. 'The most complete establishments have very excellent stables in covered avenues, which extend behind the ranges of apartments—that is, between the back walls of these ranges of building and the external wall of the khan; and the entrance to it is by a covered passage at one of the corners of the quadrangle. The stable is on a level with the court, and consequently below the level of the buildings, by the height of the platform on which they stand. Nevertheless, this platform is allowed to project behind into the stable, so as to form a bench, to which the horses' heads are turned, and on which they can, if they like, rest the nose-bag of hair-cloth, from which they eat, to enable them to reach the bottom when its contents get low. It also often happens that not only this bench exists in the stable, but also recesses corresponding to those in front of the apartments, and formed by the side walls which divide

the rooms, being allowed to project behind into the stable, just as the projection of the same walls into the great area forms the recesses in front. These recesses in the stable or the bench, if there are no recesses, furnish accommodation to the servants and others who have charge of the beasts; and when persons find on their arrival that the apartments usually appropriated to travellers are already occupied, they are glad to find accommodation in the stable, particularly when the nights are cold or the season inclement. It is evident, then, from this description, that the part of the stable called 'the manger,' could not reasonably have been better than one of those recesses, or at least a portion of the bench which we have mentioned, as affording accommodation to travellers under certain circumstance.'—R. J.

CARBUNCLE. [ΕΚΔΑΗ.]

CARCHEMISH (כַּרְכֵּמִישׁ) is mentioned in Isa. x. 9 among other places in Syria which had been subdued by an Assyrian king, probably Tiglath-pileser. That Carchemish was a stronghold on the Euphrates appears from the title of a prophecy of Jeremiah against Egypt (xlvii. 2):—'Against the army of Pharaoh-necho, king of Egypt, which lay on the river Euphrates, at Carchemish, and which Nebuchadnezzar the king of Babylon overthrew, in the fourth year of Jehoiakim, the son of Josiah, king of Judah.' According to 2 Chron. xxxv. 20, Necho had five years before advanced with his ally Josiah, the father of Jehoiakim, against the Babylonians, on the Euphrates, to take Carchemish. These two circumstances—the position of Carchemish on the Euphrates, and its being a frontier town, render it probable that the Hebrew name points to a city which the Greeks called Kukeston, the Latins Cercisium, and the Arabs, Kerkesiyeh (قرقسية):

for this too lay on the western bank of the Euphrates, where it is joined by the Chaboras. It was a large city, and surrounded by strong walls, which, in the time of the Romans, were occasionally renewed, as this was the remotest out-post of their empire, towards the Euphrates, in the direction of Persia (Ammian. Marcell. xxiii. 11). It is unknown whether any traces of it still exist; for, as it lies off the usual route of caravans, it has not been noticed by modern travellers (Rosenmuller, *Bib. Geog.*)

CARIA (*Καρία*), a country lying at the southwestern extremity of Asia Minor, to which, among others, the Romans wrote in favour of the Jews (1 Macc. xv. 22, 33). Its principal towns were Halicarnassus, Cnidus, and Myndus, which are all mentioned in the rescript of the Roman senate, to which we refer. Halicarnassus was the birth-place of Herodotus; Cnidus is mentioned in Acts xxvii. 7, as having been passed by St. Paul on his voyage to Rome.

CARMEL (כַּרְמֶל; Sept. *Κάρμηλος*), a range of hills extending north-west from the plain of Esdraelon, and ending in a promontory, or cape, which forms the Bay of Acre. The extent of this range of hills is about six miles, not in a direct line; but the two extremities (on the western side towards the sea) jut out, and stand over against each other, forming a bow in the middle. The height is about 1500 feet; and at the foot of the mountain, on the south, runs the brook Kishon,

and a little further north, the river Belus. Mount Carmel consists rather of several connected hills than of one ridge; the north and eastern parts being somewhat higher than the southern and western. The foot of the northern portion approaches the water very closely, so that, when seen from the hills north-east of Acre, the mountain appears as if 'dipping his feet in the western sea;' but further south it retires more inland, so as to leave between the mountain and the sea an extensive and very fertile plain.

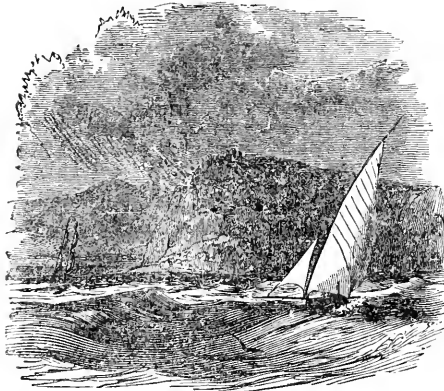

208.

Mount Carmel forms the only great promontory upon the coast of Palestine. According to the reports of most travellers, the mountain well deserves its Hebrew name (Carmel—*country of vineyards and gardens*). Mariti describes it as 'a delightful region,' and says the good quality of its soil is apparent from the fact that many odoriferous plants and flowers, as hyacinths, jonquils, tazettos, anemones, &c., grow wild upon the mountain (*Travels*, p. 274, sq.). Ottovon Richter (*Walfahrten*, p. 61) gives the following account: Mount Carmel is entirely covered with verdure. On its summit are pines and oaks, and further down olives and laurel trees, everywhere plentifully watered. It gives rise to a multitude of crystal brooks, the largest of which issues from the so-called Fountain of Elijah; and they all hurry along, between banks thickly overgrown with bushes, to the Kishon. Every species of tillage succeeds here admirably, under this mild and cheerful sky. The prospect from the summit of the mountain over the gulf of Acre and its fertile shores, and over the blue heights of Lebanon and the White Cape, is enchanting.' Mr. Carne also ascended the mountain, and traversed its whole summit, which occupied several hours. He says—'No mountain in or around Palestine retains its ancient beauty so much as Carmel. Two or three villages and some scattered cottages are found on it; its groves are few, but luxuriant; it is no place for crags and precipices, or rocks of the wild goats; but its surface is covered with a rich and constant verdure' (*Letters*, ii. 119). Such descriptions admirably illustrate the vivid representations of the inspired Hebrew prophets and poets in respect of Carmel. Thus, Isaiah (xxxv. 2) alludes to 'the excellency (splendid ornaments) of Carmel.' So, on account of the graceful form

and verdant beauty of the summit, the head of the bride in Cant. vii. 5 is compared to Carmel. It was also celebrated for its pastures, and is therefore ranked with Bashan in Isa. xxxiii. 9; Jer. i. 19; Amos i. 2.

It is nevertheless right to state that a much less glowing account of Carmel is given by many travellers; but we are satisfied that the difference arises from the time of the year at which the place was visited. Those who were on Carmel in the spring, or early summer, found the mountain covered with verdure; whereas those whose visit was later in the year—towards the end of summer or in autumn,—found everything parched, dry, and brown. This is the real secret of the discordant accounts which travellers of equal credit often give of the same places.

The mountain is of compact limestone, and, as often happens where that is the case [CAVES], there are in it very many caverns—it is said, more than a thousand. In one tract, called the Monk's Cavern, there are as many as four hundred adjacent to each other, furnished with windows and with places for sleeping hewn in the rock. A peculiarity of many of these caverns is mentioned by Shulz (*Leitung*, &c., v. pp. 187, 382), that the entrances into them are so narrow that only a single person can creep in at a time; and that the caverns are so crooked that a person is immediately out of sight unless closely followed. This may serve to give a clearer idea of what is intended in Amos ix. 3, where the Lord says of those who endeavour to escape his punishments, 'Though they hide themselves in the top of Carmel, I will search and take them out thence.' That the grottoes and caves of Mount Carmel were already, in very ancient times, the abode of prophets and other religious persons is well known. The prophets Elijah and Elisha often resorted thither (1 Kings xviii. 19, sq. 42; 2 Kings ii. 25; iv. 25; and comp. perhaps 1 Kings xviii. 4, 13). At the present day is shown a cavern called the cave of Elijah, a little below the Monks' Cavern already mentioned, and which is now a Moslem sanctuary. Upon the summit is an ancient establishment of Carmelite monks, which order, indeed, derived its name from this mountain. The old convent was destroyed by Abdallah Pasha, who converted the materials to his own use; but it has of late years been rebuilt on a somewhat imposing scale by the aid of contributions from Europe (Dr. Robinson's *Addit. to Calmet*, in art. 'Carmel;' comp. Winer's *Biblisches Realwörterbuch*; Raumer's *Palästina*; and the following travellers: D'Arvieux, Maundrell, Pococke, Mariti, Clarke, Buckingham, Irby and Mangles, Menro, Skinner, Hardy, G. Robinson, Richter, Schubert, &c.

2. CARMEL. Another Carmel, among the mountains of Judah, is named in Josh. xv. 55. It was here that Saul set up the trophy of his victory over Amalek (1 Sam. xv. 12), and where Nabal was shearing his sheep when the affair took place between him and David in which Abigail bore so conspicuous a part (1 Sam. xxv. 2, sq.). This Carmel is described by Eusebius and Jerome as, in their day, a village, with a Roman garrison, ten miles from Hebron, verging towards the east. From the time of the Crusades till the present century its name seems to have been forgotten. But it was recognised by Setzen,

and more recently by Count Bertou and Dr. Robinson, under the name of Kurnoul. The place is now utterly desolate, but the ruins indicate a town of considerable extent and importance. These ruins lie around the head and along the two sides of a valley of some width and depth, the head of which forms a semicircular amphitheatre shut in by rocks. They consist chiefly of the foundations and broken walls of dwellings and other edifices, scattered in every direction, and thrown together in mournful confusion and desolation. The most remarkable ruin is that of a castle, quadrangular, standing on a swell of ground in the midst of the town. A minute description of this and the other remains is given by Dr. Robinson (*Bib. Researches*, ii. pp. 195-201). The distance of this place from Hebron is nearer eight Roman miles than ten, as assigned by Eusebius and Jerome.

CARNAIM. [ASHTAROTH.]

1 CARPENTER. [HANDICRAFT.]

CARPUS (Κάρπος), a disciple of Paul who dwelt at Troas (2 Tim. iv. 13).

CART (כֶּרֶס; Sept. *Ἀμαξα*). The Hebrew word rendered by our translators in some places by 'waggon,' and in others by 'cart,' denotes any vehicle moving on wheels and usually drawn by oxen; and their particular character must be determined by the context indicating the purpose for which they were employed. First, we have the carts which the king of Egypt sent to assist in transporting Jacob's family from Canaan (Gen. xlv. 19, 27). From their being so sent it is manifest that they were not used in the latter country; and that they were known there as being peculiar to Egypt is shown by the confirmation which they afforded to Jacob of the truth of the strange story told by his sons. These carts or waggons were, of course, not war-chariots, nor such curricles as were in use among the Egyptian nobility, but were not suited for travelling. The

any rate, they afford the only attainable analogy, and are for that reason here represented (No. 209).

Elsewhere (Num. vii. 3, 6; 1 Sam. vi. 7) we read of carts used for the removal of the sacred arks and utensils. These also were drawn by two oxen.

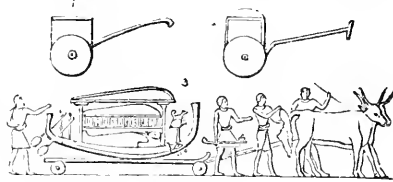

210.

In Rossellini we have found a very curious representation of the vehicle used for such purposes by the Egyptians (No. 210, fig. 3). It is little more than a platform on wheels; and the apprehension which induced Uzzah to put forth his hand to stay the ark when shaken by the oxen (2 Sam. vi. 6), may suggest that the cart employed on that occasion was not unlike this, as it would be easy for a jerk to displace whatever might be upon it.

As it appears that the Israelites used carts, they doubtless employed them sometimes in the removal of agricultural produce, although we are not aware of any distinct mention of this practice in Scripture. This is now the only use for which carts are employed in Western Asia. They are such as are represented in No. 211.

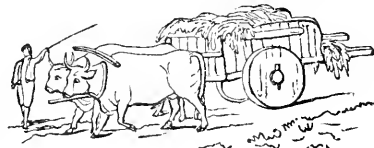

211.

CASLUHIM (סִיחִימ; Sept. *Χασμωνίμ*),

properly Casluchim, a people whose progenitor was a son of Mizraim (Gen. x. 14; 1 Chron. i. 12). He, or they, for the word applies rather to a people than to an individual, are supposed by Bochart and others to have carried a colony from Egypt, which settled in the district between Pelusium and Gaza, or, in other words, between the Egyptians and the Philistines. There are some grounds for this conjecture; but it is impossible to obtain any certainty on so obscure a subject.

CASSIA. [KETZIAH.]

CASTLE. [FORTIFICATIONS.]

CASTOR AND POLLUX (Διδούκωροι), the Dioscuri: in heathen mythology, the twin sons of Jupiter by Leda. They had the special province of assisting persons in danger of shipwreck (Theocrit. *Id.* xxii. 1; Xenoph. *Symp.* viii. 29; comp. Horat. *Carm.* i. 3. 2; iv. 8. 31); and hence their figures were often adopted for 'the sign' (τὸ παράσημον, *insigne*), from which a ship derived its name, as was the case with that 'ship of Alexandria' in which St. Paul sailed on his journey for Rome (Acts xxviii. 11).

CAT (ἀλώπου). It might be assumed that the cat was an useful, if not a necessary, domestic animal to the Hebrew people in Palestine, where corn was grown for exportation, as well as for

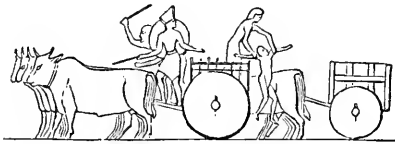

209.

only other wheel-vehicles actually or probably used by the Egyptians themselves are those represented in figs. 1, 2, of No. 210. But they are not found on the monuments in such connection as to show whether they were employed for travelling or for agriculture. The solid wheels would suggest the latter use, if, indeed, the same feature does not rather show that, although figured on Egyptian monuments, they are the cars of a foreign people. This is the more probable, inasmuch as the ready means of transport and travel by the Nile seems to have rendered in a great measure unnecessary any other wheel-carriages than those for war or pleasure. The sculptures, however, exhibit some carts as used by a nomade people (enemies of the Egyptians) in their migrations. If any of these had, by the rout of this people, been left in the hands of the Egyptians, the king would no doubt consider them suitable to assist the migration of another people of similar habits. At

consumption of the resident population, twenty or thirty-fold more than at present, and where, moreover, the conditions of the climate required the precaution of a plentiful store being kept in reserve to meet the chances of scarcity. The animal could not be unknown to the people, for their ancestors had witnessed the Egyptians treating it as a divinity, under the denomination of Pasht, the Lunar Goddess, or Diana, holding every domesticated individual sacred, embalming it after death, and often sending it for interment to Bubastis. Yet we find the cat nowhere mentioned in the canonical books as a domestic animal. And in Baruch it is noticed only as a tenant of Pagan temples, where no doubt the fragments of sacrificed animals and vegetables attracted vermin, and rendered the presence of cats necessary. This singular circumstance, perhaps, resulted from the animal being deemed unclean, and being thereby excluded domestic familiarity, though the Hebrews may still have encouraged it, in common with other vermin-hunters, about the outhouses and farms, and corn-stores, at the risk of some loss among the broods of pigeons which, in Palestine, were a substitute for poultry. If the domestic species of cats were not tolerated, there could not exist many wild in a country almost destitute of forests; but, in their stead, at least in Egypt, Syria, Arabia, and Persia, there are numerous species of viverridæ and mustelidæ, to which, in common phrase, we apply the word cat, as civet cat and polecat. These are species that hunt in open grounds and visit ruined buildings; and among them, perhaps, some wild canidæ may be collectively those denominated, with obvious propriety, חַיָּט *Tziyim*.

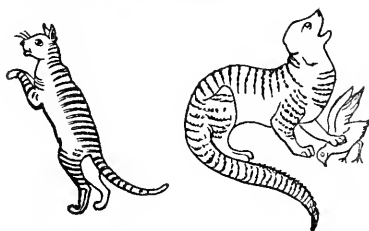

212.

With regard to the neighbouring nations just named, they all had domestic cats, it is presumed, derived from a wild species found in Nubia, and first described by Ruppel under the name of *Felis Maniculata*. The typical animal is smaller, more slender, and more delicately limbed than the European. The fur is pale yellowish grey, with some dark streaks across the paws, and at the tip of the tail. In the domesticated state it varies in colours and markings, for the ancient monuments of Egypt contain many painted figures, which show them cross-banded like our wild species in Europe. Two specimens are here given from these paintings; one clearly a cat; the other, in the original, figured as catching birds; acting like a retriever for his master, who is fowling in a boat. It is not, apparently, a cat, but a species of genet or *paradoxurus*, one of the genera before hinted at. Both are nearly allied to the celebrated *Ichneumon*, the *Herpestes* of authors, the modern *Nems*, which is even now occasionally

domesticated; it differs in manners, for the *Herpestes pharaonis* does not frequent the uplands, but willingly takes the water.—C. II. S.

CATERPILLAR. [CHASIL.]

CATTLE. [BEASTS; BULL.]

CAVES. The geological formation of Syria is highly favourable to the production of caves. It consists chiefly of limestone, in different degrees of density, and abounds with subterranean rivulets. The springs issuing from limestone generally contain carbonate of lime, and most of them yield a large quantity of free carbonic acid upon exposure to the air. To the erosive effect upon limestone rocks, of water charged with this acid, the formation of caves is chiefly to be ascribed (*Enc. Metropol.* art. 'Geology,' pp. 692, 693). The operation of these causes is sometimes exemplified by a torrent perforating a rock, and forming a natural arch, like that of the Nair el Leben, which falls into the Nabr El Salib, called also the river of Beirout. The arch is upwards of 160 feet long, 85 feet wide, and nearly 200 feet above the torrent (*Kitto's Physical History of Palestine*, art. 'Geology and Mineralogy'). The *subordinate* strata of Syria, sandstone, chalk, basalt, natron, &c. favour the formation of caves. Consequently the whole region abounds with subterranean hollows of different dimensions. Some of them are of immense extent; these are noticed by Strabo, who speaks of a cavern near Damascus capable of holding 4000 men (xvi. p. 1096, edit. 1707). This cavern is shown to the present day. Modern travels abound with descriptions of the caves of Syria. The Crusade writers record the local traditions respecting them current in their times (William of Tyre; Quaresmius, *Elucid. Ter. Sanc.*). Tavernier (*Voyage de Perse*, part ii. chap. iv.), speaks of a grotto between Aleppo and Bir, which would hold near 3000 horse. Maundrell has described a large cavern under a high rocky mountain, in the vicinity of Sidon, containing 200 smaller caverns (*Travels*, pp. 158, 159). Shaw mentions the numerous dens, holes, and caves, in the mountains on the sea coast, extending through a long range on each side of Joppa. The accounts of the latest and most accurate travellers verify their statements. The *first* mention of a cave in Scripture relates to that into which Lot and his two daughters retired from Zoar, after the destruction of Sodom and Gomorrah (Gen. xix. 30). It was some cavern in the mountains of Moab, but tradition has not fixed upon any of the numerous hollows in that region. The next is the cave of *Machpelah*, in the field of Ephron, which Abraham purchased of the sons of Heth (Gen. xxv. 9, 10). There Abraham buried Sarah, and was himself afterwards buried; there also Isaac, Rebecca, Leah, and Jacob, were buried (Gen. xlix. 31; l. 13). The cave of Machpelah is said to be under a Mahometan mosque, surrounded by a high wall called the Haram; but even the Moslems are not allowed to descend into the cavern. The tradition that this is the burial-place of the patriarchs, is supported by an immense array of evidence (Robinson, *Biblical Researches in Palestine*, ii. 433-440).

The situation of the cave at *Makkedah*, into which the five kings of the Amorites retired upon their defeat by Joshua, and into which their carcasses were ultimately cast, is not known (Josh. x.

6, 27). Some of the caves mentioned in the Scriptures were *artificial*, or consisted of natural fissures enlarged or modified for the purposes intended. It is recorded (Judg. vi. 2), that 'because of the Midianites, the children of Israel made them dens which are in the mountains, and caves, and strongholds.' Caves made by art are met with in various quarters. An innumerable multitude of excavations are found in the rocks and valleys round Wady Musa, which were probably formed at first as sepulchres, but afterwards inhabited, like the tombs of Thebes (Robinson's *Researches*, ii. 529). Other excavations occur at Deir Dubbân (ii. 353); others in the Wady leading to Santa Hanneh (ii. 395). 'In the mountains of Kûl at Ibn Ma'an, the natural caverns have been united by passages cut in the rocks, in order to render them more commodious habitations. In the midst of these caverns several cisterns have been built; the whole would afford refuge for 600 men' (Burckhardt's *Travels*, p. 331). Caves were used as *dwelling-places* by the early inhabitants of Syria. The Horites, the ancient inhabitants of Idumæa Proper, were Troglodytes or dwellers in caves, as their name imports. Jerome records that in his time Idumæa, or the whole southern region from Eleutheropolis to Petra and Ailah, was full of habitations in caves, the inhabitants using subterranean dwellings on account of the great heat (*Comm. on Obad.* v. 6). 'The excavations at Deir Dubbân and on the south side of the Wady, leading to Santa Hanneh, are probably the dwellings of the ancient Horites' (Robinson, ii. 353), and they are peculiarly numerous around Beit Jibrin (Eleutheropolis) (ii. 425). The Scriptures abound with references to habitations in rocks; among others, see Num. xxiv. 21; Cant. ii. 14; Jer. xlix. 16; Obad. 3. Even at the present time many persons live in caves. The inhabitants of Anab, a town on the east of the Jordan, lat. 32°, long. 35° E., all live in grottoes or caves hollowed out of the rock (Buckingham's *Travels among the Arab Tribes*, p. 61). In the neighbourhood of Hebron peasants still live in caves, and especially during the summer, to be near their flocks (Wilkinson's *Travels*, i. 313). Poor families live in caverns in the rocks which seem formerly to have been inhabited as a sort of village, near the ruins of El Burj. So also at Siloam, and in the neighbourhood of Nazareth. Caves afforded excellent *refuge in the time of war*. Thus the Israelites (1 Sam. xiii. 6) are said to have hid themselves in caves, and in thickets, and in rocks, and in high places, and in pits. See also Jer. xli. 9; Joseph. *Antiq.* xii. 11. 1. Hence, then, to 'enter into the rock, to go into the holes of the rocks, and into the caves of the earth' (Isa. ii. 19), would, to the Israelites, be a very proper and familiar way to express terror and consternation. The *pits* spoken of seem to have consisted of large wells, in 'the sides' of which, excavations were made, leading into various chambers. Such pits were sometimes used as *prisons* (Isa. xxiv. 22; li. 14; Zech. ix. 11); and with *niches* in the sides, for *burying-places* (Ezek. xxxii. 23). Many of these vaulted pits remain to this day. The cave in which *Lazarus was buried* was probably something of this kind. The tomb shown as his, at Bethany, is not attended with the slightest probability (Robinson, ii. 100). The *strongholds of Engedi*, which

afforded a retreat to David and his followers (1 Sam. xxiii. 29; xxiv. 1), can be clearly identified. They are now called 'Ain Tidy by the Arabs, which means the same as the Hebrew, namely, 'The Fountain of the Kid.' 'On all sides the country is full of caverns, which might serve as lurking-places for David and his men, as they do for outlaws at the present day. The whole scene is drawn to the life' (Robinson, ii. 203). The *cave of Adullam*, to which David retired to avoid the persecutions of Saul (1 Sam. xxii. 1, 2), and in which he cut off the skirt of Saul's robe (1 Sam. xxiv. 4), is an immense natural cavern at the Wady Kluureitun, which passes below the Frank mountain (Herodius: see the *Map of Palestine*). For a description of this cave by Irby and Mangles, and the reasons for believing its identity, see article ADULLAM. Dr. Pococke refers to a tradition that 30,000 persons once retired into it to avoid a malaria. Such is the extent of the cavern, that it is quite conceivable how David and his men might 'remain in the sides of the cave,' and not be noticed by Saul (*Travels*, vol. ii. p. 41). Caverns were also frequently *fortified* and occupied by soldiers. Josephus often mentions this circumstance. He relates also that Herod sent horsemen and footmen to destroy the *robbers that dwell in caves*, and did much mischief in the country. They were very near to a village called Arbela (now called Kûlat Ibn Ma'an); the adjacent ruins are known by the name of Irbid, a corruption of Ibib, Arabic for Arbela (Burckhardt's *Travels*, p. 331). On the fortieth day after, Herod came with his whole army to exterminate them. The robbers laid out of their caves and boldly gave him battle, and even caused the left wing of his army to give way, though they were ultimately defeated. Herod then laid *siege* to certain other caverns containing robbers, but found operations against them very difficult. These were situated on the middle of abrupt and precipitous mountains, and could not be come at from any side, since they had only some winding pathways, very narrow, by which they got up to them. The rock that lay on their front overhung valleys of immense depth, and of an almost perpendicular declivity. To meet these difficulties Herod caused large boxes filled with armed men to be lowered from the top of the mountain. These men had long hooks in their hands with which they might pull out those who resisted them, and tumble them down the mountains. From these boxes they at length slipped into the caverns, destroyed the robbers and set fire to their goods (*Antiq.* xiv. 15, § 4, 5; *De Bell. Jud.* i. 16, § 2-4). This description of *caves of robbers* reminds us of our Lord's words, in which he reproaches the Jews with having made the Temple a *den of thieves*, *σπηλαιον ληστῶν* (Matt. xxi. 13). In the former of these passages Josephus calls them *τοὺς ἐν τοῖς σπηλαίοις ληστας*, and in the latter, *ληστων τινων ἐν σπηλαίοις κατοικούντων*. Certain caves were afterwards fortified by Josephus himself during his command in Galilee under the Romans. In one place he speaks of these as the caverns of Arbela (*Vita*, § 37), and in another as the caverns near the lake Gennesareth (*De Bell. Jud.* ii. 20. 6). A fortified cavern existed in the time of the Crusades. It is mentioned by William of Tyre (xxii. 15-21), as situate in the country beyond the Jordan,

sixteen Roman miles from Tiberias. The cave of Elijah is pretended to be shown, at the foot of Mount Sinai, in a chapel dedicated to him; and a hole near the altar is pointed out as the place where he lay (Robinson, i. 152).—J. F. D.

CEDAR. [ERES.]

CEILING. The orientals bestow much attention upon the ceilings of their principal rooms. Where wood is not scarce, they are usually composed of one curious piece of joinery, framed entire, and then raised and nailed to the joists. These ceilings are often divided into small square compartments; but are sometimes of more complicated patterns. Wood of a naturally dark colour is commonly chosen, and it is never painted. In places where wood is scarce, and sometimes where it is not particularly so, the ceilings are formed of fine plaster, with tasteful mouldings and ornaments, coloured and relieved with gilding, and with pieces of mirror inserted in the hollows formed by the involutions of the raised mouldings of the arabesques, which enclose them as in a frame. The antiquity of this taste can be clearly traced by actual examples up to the times of the Old Testament, through the Egyptian monuments, which display ceilings painted with rich colours in such patterns as are shown in the annexed cut. The explanation thus obtained

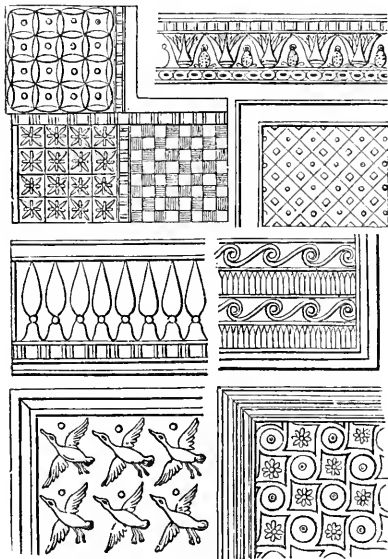

213.

satisfactorily illustrates the peculiar emphasis with which 'ceiled houses' and 'ceiled chambers' are mentioned by Jeremiah (xxiii. 14) and Haggai (i. 4).

CENCHREÆ (*Κενχρεαί*), one of the ports of Corinth, whence Paul sailed for Ephesus (Acts xviii. 18). It was situated on the eastern side of the isthmus, about seventy stadia from the city: the other port on the western side of the isthmus was called Lechæum. [CORINTH.]

CENSER, the vessel in which incense was presented in the temple (2 Chron. xxvi. 19; Ezek.

viii. 11; Eccclus. i. 9). Censers were used in the daily offering of incense, and yearly on the day

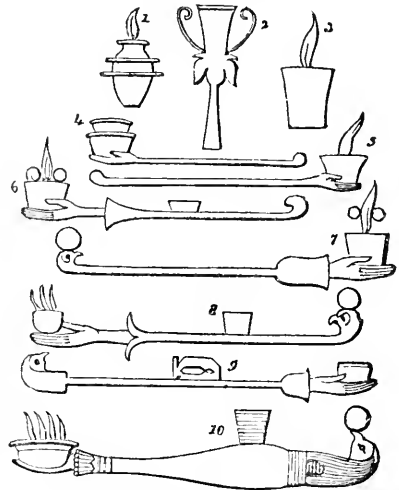

214. [Egyptian Censers.]

of atonement, when the high-priest entered the Holy of Holies. On the latter occasion the priest filled the censer with live coals from the sacred fire on the altar of burnt-offering, and bore it into the sanctuary, where he threw upon the burning coals the 'sweet incense beaten small' which he had brought in his hand (Lev. xvi. 12, 13). In this case the incense was burnt while the high-priest held the censer in his hand; but in the daily offering the censer in which the live coals were brought from the altar of burnt-offering was set down upon the altar of incense. This alone would suggest the probability of some difference of shape between the censers used on these occasions. The daily censers must have had a base or stand to admit of their being placed on the golden altar, while those employed on the day of atonement were probably furnished with a handle. In fact, there are different names for these vessels. Those in daily use were called מִקְטֶרֶת *miktereth*, from מִקְטֵר *'incense;'* whereas that used on the day of atonement is distinguished by the title of מִחְתָּה *nichtah* or 'coal-pan.' We learn also that the daily censers were of brass (Num. xvi. 39), whereas the yearly one was of gold (Joseph. *Antiq.* xvi. 4. 4). The latter is also said to have had a handle (Mishn. tit. *Yoma*, iv. 4), which, indeed, as being held by the priest while the incense was burning, it seems to have required. These intimations help us to conclude that the Jewish censers were unlike those of the classical ancients, with which the sculptures of Greece and Rome have made us familiar; as well as those (with perforated lids, and swung by chains) which are used in the church of Rome. The form of the daily censer we have no means of determining beyond the fact that it was a pan or vase, with a stand whereon it might rest on the golden altar. Among the Egyptians the incense was so generally burned in the hand of the officiating priest, that the only censers which we find in the least degree suited to this purpose are

those represented in figs. 2 and 3 of No. 214. But the numerous figures of Egyptian censers, consisting of a small cup at the end of a long shaft or handle (often in the shape of a hand), probably offer adequate illustration of those employed by the Jews on the day of atonement. There was, however, another kind of censer (fig. 1) less frequently seen on the Egyptian monuments, and likewise furnished with a handle, which will probably be regarded by many as offering a more probable resemblance. It is observable that in all cases the Egyptian priests had their costly incense made up into small round pellets, which they projected successively from between their finger and thumb into the censer, at such a distance, that the operation must have required a peculiar knack to be acquired only by much practice. As the incense used by the Jews was made up into a kind of paste, it was probably employed in the same manner.

CENSUS. [POPULATION.]

CENTURION (*ἐκατοντάρχης* and *ἐκατονταρχος*), a Roman military officer in command of a hundred men, as the title implies. Cornelius, the first Gentile convert to Christianity, held this rank (Acts x. 1, 22). Other Centurions are mentioned in Matt. viii. 5, 8, 13; xxvii. 54; Luke vii. 2, 6; Acts xxi. 32; xxii. 25, 26; xxiii. 17, 23; xxiv. 23; xxvii. 1, 6, 11, 31, 43; xxviii. 16.

CEPHAS (*Κηφᾶς*; in later Hebrew or Syriac כֶּפֶן), a surname which Christ bestowed upon Simon (John i. 42), and which the Greeks rendered by Πέτρος, and the Latins by Petrus, both words meaning a 'rock,' which is the signification of the original [PETER].

CERATIA, CERATONIA, is the name of a tree of the family of Leguminous plants, of which the fruit used to be called *Siliqua edulis* and *Siliqua dulcis*. By the Greeks, as Galen and Paulus Ægineta, the tree is called *κερατία*, *κερατωνία*, from the resemblance of its fruit to *κέρας*, a horn. The word *κεράτιον* occurs in Luke xv. 16, where it has been translated *hushk* in the Authorized Version: our Saviour, in the parable of the prodigal son, says that 'he would fain have filled his belly with the *hushk* that the swine did eat; and no man gave unto him.' In the Arabic Version of the New Testament, the word *خروب* *Kharooob*, often written

خرنوب *Kharnooob*, is given as the synonym of *Keratia*. According to Celsius, the modern Greeks have converted the Arabic name into *χάρουβα*, and the Spaniards into *Garrava* and *Algaroba*. The Italians call the tree *Caroba*, the French *Caroubier*, and the English Carob-tree. Though here, little more than its name is known, the Carob-tree is extremely common in the South of Europe, in Syria, and in Egypt. The Arabs distinguish it by the name of *Kharnooob shamee*—that is the Syrian Carob. The ancients, as Theophrastus and Pliny, likewise mention it as a native of Syria. Celsius states that no tree is more frequently mentioned in the Talmud, where its fruit is stated to be given as food to cattle and swine: it is now given to horses, asses, and mules. During the Peninsular war the horses of the British cavalry were often fed on the beans of the Carob-tree. Both Pliny (*Hist. Nat.* xv. 23) and Columella (vii. 9) mention that it was given as

food to swine. By some it has been thought, but apparently without reason, that it was upon the husks of this tree that John the Baptist fed in the wilderness: from this idea, however, it is often called St. John's Bread, and Locust-tree.



215. [Ceratonia Siliqua.]

The Carob-tree grows in the south of Europe and north of Africa, usually to a moderate-size, but it sometimes becomes very large, with a trunk of great thickness, and affords an agreeable shade. The quantity of pods borne by each tree is very considerable, being often as much as 500 or 900 pounds weight: they are flat, brownish-coloured, from 6 to 8 inches in length, of a sub-astringent taste when unripe, but, when come to maturity, they secrete, within the husks and round the seeds, a sweetish-tasted pulp. When on the tree, the pods have an unpleasant odour; but, when dried upon hurdles, they become eatable, and are valued by poor people, and during famine in the countries where the tree is grown, especially in Spain and Egypt, and by the Arabs. They are given as food to cattle in modern, as we read they were in ancient, times; but, at the best, can only be considered very poor fare.—J. F. R.

CETUBIM (כֶּטֻבִּים, *the Writings*), one of the three larger divisions of the Old Testament used by the Hebrews, and thus distinguished from the Law and the Prophets (the other two divisions); as being in the first instance committed to writing, and not delivered orally. Hence the book of Daniel is found in this division; his prophecies having been originally written down, and not orally delivered. This is the division of Scripture known also by the corresponding Greek name of HAGIOGRAPHIA. It contained Psalms, Proverbs, Job, Canticles, Ruth, Lamentations, Ecclesiastes, Esther, Daniel, Ezra and Nehemiah (reckoned as one), and Chronicles.

CHABAZZELETH (חַבְצֵזֶלֶת) occurs in two places in Scripture, first in the passage of Cant. ii. 1, where the bride replies, 'I am the

Rose of Sharon and the lily of the valleys; and secondly, in Isa. xxxv. 1, 'The wilderness and the solitary place shall be glad for them; and the desert shall rejoice, and blossom as the rose.' In both passages we see, that in the Auth. Vers., as also in some others, the word is considered to indicate the rose. The Sept. renders it simply by *flower* in the passage of the Canticles. In this it has been followed by the Latin Vulgate, Luther, &c. It is curious, however, as remarked by Celsius, *Hiero.*, i. p. 489, that many of those who translate *chabazzeleth* by *rose* or *flower* in the passage of the Canticles, render it by *lily* in that of Isaiah.

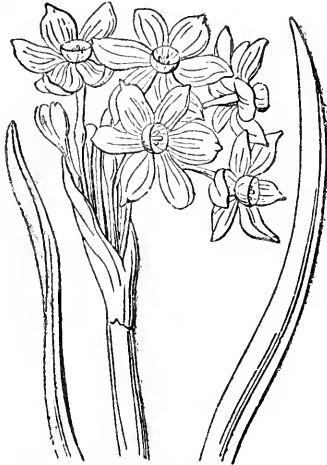

216. [*Narcissus tazetta*.]

The rose was, no doubt, highly esteemed by the Greeks, as it was, and still is, by almost all Asiatic nations, and, as it forms a very frequent subject of allusion in Persian poetry, it has been inferred that we might expect some reference to so favourite a flower in the poetical books of the Scripture, and that no other is better calculated to illustrate the above two passages. But this does not prove that the word *chabazzeleth*, or any similar one, was ever applied to the rose. Other flowers, therefore, have been indicated, to which the name *chabazzeleth* may be supposed, from its derivation, to apply more fitly. Scheuzer refers to Hiller (*Hierophyt.* p. 2), who seeks *chabazzeleth* among the bulbous rooted plants, remarking that the Hebrew word may be derived from *chabab* and *batzal*, a bulb, or bulbous root of any plant; as we have seen it applied to the onion in the article *BETZAL*. So Rosenmüller remarks that the substantial part of the Hebrew name shows that it denotes a flower growing from a bulb, and adds in a note 'that הבצלת is formed from בצל or bulb, the guttural ב being sometimes put before trilaterals, in order to form quadrilaterals from them' (see *Gesen. Gram.* p. 863). Some therefore have selected the asphodel as the bulbous plant intended; respecting which the author of 'Scripture Illustrated' remarks, 'It is a very beautiful and odiferous flower, and highly praised by two of the greatest masters of Grecian song. Hesiod says it grows commonly

in woods; and Homer (*Odys.*, i. 24) calls (βα Elysian fields 'meads filled with asphodel.'

Celsius (*l.c.*) has already remarked that Bochart has translated *chabazzeleth* by *narcissus*; and not without reason, as some Oriental translators have so explained it. In the Targum, Cant. ii. 1, instead of *chabazzeleth* we have *narkom*, which, however, should have been written *narkos* נַרְקוֹס, as appears from the words of David Cohen de Lara, '*Narkos idem est ac chabazzeleth Saron.*' So in Isa. xxxv. 1, *chabazzeleth* is written *chamzaloito* in the Syrian translation, 'quod maronita Lafine vertit narcissum' (Cels. *Hierobot.* i. p. 489). This, Rosenmüller informs us, according to the testimony of Syriac Arabic Dictionaries, denotes the 'colchicum autumnale,' that is, the meadow saffron. That plant certainly has a bulb-like root-stock; in form the flowers resemble those of the crocus, are of a light violet colour, but without any scent. *Narkom* and *narkos* are, no doubt, the same as the Persian *nurgus*, Arabic

نرجس, and which, throughout the East, indicates *Narcissus tazetta*, or the polyanthus *narcissus*. The ancients describe and allude to the *narcissus* on various occasions, and Celsius has quoted various passages from the poets indicative of the esteem in which it was held. As they were not so particular as the moderns in distinguishing species, it is probable that more than one may be referred to by them, and, therefore, that *N. tazetta* may be included under the same name as *N. poeticus*, which was best known to them. It is not unimportant to remark that the *narcissus* was also called *βολβός ἐμετικός*, and *Bulbus vomitorius*, and the Arabic *bust-al-kye*, no doubt refers to the same or a kindred species. It is curious also that an Eastern name, or the corruption of one, should be applied by gardeners even in this country to a species of *narcissus*—thus, *N. Trevrianus* and *crenulatus*,—the former, supposed by some to be a variety of *N. orientalis*, were once called *bazalman* major and *bazalman* minor. That the *narcissus* is found in Syria and Palestine is well known, as it has been mentioned by several travellers; and, also, that it is highly esteemed by all Asiatics from Syria even as far as India. Hence, if we allow that the word *chabazzeleth* has reference to a bulb-bearing root, it cannot apply to the rose. The *narcissus*, therefore, is as likely as any other of the bulbous tribe to have been intended in the above passages.—J. F. R.

CHAFF, the refuse of winnowed corn. It is used as a symbol for unprofitable and worthless characters (Ps. i. 4; Matt. iii. 12).

CHAIN. Chains of gold appear to have been as much used among the Hebrews, for ornament or official distinction, as they are among ourselves at the present day. The earliest mention of them occurs in Gen. xli. 42, where we are told that a chain of gold formed a part of the investiture of Joseph in the high office to which he was raised in Egypt; a later instance occurs in Dan. v. 29, from which we learn that a golden chain was part of a dress of honour at Babylon. In Egypt the judges wore chains of gold, to which was attached a jewelled figure of Thmei, or Truth; and in that country similar chains were also worn as ornaments by the women. It is not, however, necessary to suppose that the Hebrews derived this custom from the Egyptians; for the fact

that chains are mentioned among the spoil of the Midianites shows that they were in use among people whose condition of life more nearly resembled that of the Israelites before they obtained possession of Canaan. It would seem that chains were worn both by men and women (Prov. i. 9; Ezek. xvi. 11), and we find them enumerated among the ornaments of brides (Cant. i. 10; iv. 9).

It was a custom among the Romans to fasten a prisoner with a light chain to the soldier who was appointed to guard him. One end of it was attached to the right hand of the prisoner, and the other to the left hand of the soldier. This is the chain by which Paul was so often bound, and to which he repeatedly alludes (Acts xxviii. 20; Eph. vi. 20; 2 Tim. i. 16). When the utmost security was desired, the prisoner was attached by two chains to two soldiers, as was the case with Peter (Acts xii. 6).

CHALCEDONY (*χαλκηδών*, Rev. xxi. 19), a precious stone, supposed by some to be the same that occurs in the Hebrew Scriptures (Exod. xxviii. 18) under the name of *nophet* (translated 'emerald'); but this is doubtful. Chalcedony is a variety of amorphous quartz, and the distinction between it and agate is not very satisfactorily established. It is harder than flint (specific gravity 2.04), commonly semi-transparent, and is generally of one uniform colour throughout, usually a light brown and often nearly white; but other shades of colour are not infrequently, such as grey, yellow, green, and blue. Chalcedony occurs in irregular masses, commonly forming grotesque cavities, in trap rocks and even granite. It is found in most parts of the world; and in the east is employed in the fabrication of cups and plates, and articles of taste, which are wrought with great skill and labour, and treasured among precious things. In Europe it is made into snuff-boxes, buttons, knife-handles, and other minor articles.

CHALDÆAN PHILOSOPHY. This is a subject of interest to the student of the Bible, in consequence of the influence which the Babylonian philosophy exerted on the opinions and manner of thinking of the Israelites during their captivity in Babylon—an influence of a general and decided character, which the Rabbins themselves admit, in alleging that the names of the angels and of the months were derived by the house of Israel from Babylon (*Rosh Hashanah*, p. 56). The system of opinion and manner of thinking which the captives met with in Babylon cannot be characterized exclusively as Chaldæan, but was made up of elements whose birth-place was in various parts of the East, and which appear to have found in Babylon a not uncongenial soil, where they grew and produced fruit which coalesced into one general system. Of these elements the two principal were the Chaldæan and the Medo-Persian or Zoroastrian. It is to the first that the reader's attention is invited in this article.

The Chaldæans, who lived in a climate where the rays of the sun are never darkened, and the night is always clear and bright by means of the light of the moon and stars, were led to believe that light was the soul of nature. Accordingly it was by the light of the sun and stars that the universal spirit brought forth all things; and

therefore the Chaldæans offered their homage to the Supreme Being in the heavenly bodies, where he appeared to them in a special manner to dwell. As the stars form separate bodies, imagination represented them as distinct existences, which had each their peculiar functions, and exerted a separate influence in bringing forth the productions of nature. The idea of a universal spirit disappeared, as being too abstract for the people, and not without difficulty for cultivated minds; and worship was offered to the stars as so many powers that governed the world. It is easy to see how the Chaldæans passed from this early corruption of the primitive religion of the Bible to a low and degrading polytheism.

As light was regarded as the only moving-power of nature, and every star had its own influence, so natural phenomena appeared the result of the particular influence of that heavenly body which at any given time was above the horizon; and the Chaldæan philosophers believed that they found the cause of events in its position, and the means of foretelling events in its movements. These views, and perhaps the extraordinary heat and the pestilential winds which in certain months prevail in the country, and against which there is no protection except in the hills, led the Chaldæans to the mountains which gird the land. On these observatories, which nature seems to have expressly formed for the purpose, they studied the positions and movements of the heavenly host. They thought they saw that similar phenomena were constantly accompanied by the same conjunction of the stars, which seemed to observe regular movements and a similar course. On this the Chaldæan priests came to the conviction that natural events are bound together, and that sacrifices do not interrupt their course; that they all have a common origin, which works according to unknown principles and laws, whose discovery is so important as to deserve their best attention. The heavenly bodies themselves are obedient to these laws; their formation, position, and influence, are consequences of these universal laws, by which nature was controlled. This determined the Chaldæans to seek in the heavens the knowledge of the original cause which created the world, and of the laws which that cause followed in the formation of things, and in the production of phenomena, since in the heavens dwelt the power which brings all things forth.

The stars were masses of light; the space which held them was filled with light; no other power appeared to operate therein: accordingly the Chaldæans held light to be the moving-power which had produced the stars. It could not be doubted that this power possessed intelligence, and the operations of the mind appear to have so much resemblance to the subtlety and fleetness of light, that men who had only imagination for their guide had no hesitation to represent intelligence as a property of light, and the universal spirit or highest intelligence as light itself. The observations of the Chaldæans had taught them that the distances of the stars from the earth are unequal, and that light decreases in its approach to the earth, on which they concluded that light streams forth from an endless fountain far removed from the earth, in doing which it fills space with its beams, and forms the heavenly bodies in different positions and of different magnitudes. The

creative spirit was therefore set forth by them under the image of an eternal inexhaustible fountain of light; they thought this fountain was to the universe what the sun is to the regions lighted and warmed by his beams.

As light becomes less in propagating itself, its fountain must be of an inconceivable subtlety and purity, and accordingly, in its loftiest condition, intelligent. As its beams are removed from their source they lose their activity, and by the gradual waning of their influence sink from their original perfection; they therefore produced different existences and intelligences, in proportion as they became more distant from the fountain of light; at last, passing from one element into another, they lost their lightness, were pressed together, and made dense, till they became corporeal, and produced chaos. There accordingly was between the Supreme Being and the earth a chain of intermediate existences whose perfections decreased as they were more remote from the First Great Cause. This Supreme Being had communicated in a distinguished degree his primary radiations, intelligence, power, productiveness; all other emanations had, in proportion to their distance from the highest intelligence, a less and less share in these perfections; and thus were the different regions of light, from the moon to the dwelling-place of the Supreme, filled with various orders of spirits.

The space which contained the First Cause, or Fountain of radiations, was filled with pure and happy intelligences. Immediately beneath this region began the corporeal world, or the empyreum, which was a boundless space, lighted by the pure light which flowed immediately from the Great Source; this empyreum was filled with an infinitely less pure fire than the original light, but immeasurably finer than all bodies. Below this was the ether, or grosser region, filled with still grosser fire. Next came the fixed stars, spread over a wide region where the thickest parts of the ethereal fire had come together and formed the stars. The world of planets succeeded, which contained the sun, moon, and the wandering stars. Then came the last order of beings—the rude elements which are deprived of all activity, and withstand the motions and influence of light. The different parts of the world are in contact, and the spirits of the upper regions can influence the lower, as well as descend and enter into them. As the chaotic elements were without shape and motion, the spirits of the higher regions must have formed the earth, and human souls are spirits sprung from them. To these spirits from above the system of the Chaldeans ascribed all the productions, appearances, and movements upon the earth. The formation of the human body, the growth of the fruits, all the gifts of nature, were attributed to beneficent spirits. In the space below the moon, in the midst of night, tempests arose, lightnings threaded the dark clouds, thunder broke forth and laid waste the earth; there were found spirits of darkness, corporeal demons spread through the air. Often, too, were flames of fire seen to rise out of the bosom of the earth, and the mountains were shaken. Earthly powers or demons were supposed to dwell in the centre of the earth; and since matter was held to be without activity, all movements were attributed to spirits. Storms, volcanoes, tempests, appeared to have no other

object than to destroy human happiness; and these demons were held to be wicked spirits who produced these evils; to them every unfortunate event was ascribed, and a sort of hierarchy was formed of these evil beings, as had been done in the case of the good spirits. But why did not the Supreme mind put down, by an exertion of his power, this swarm of wicked spirits? Some thought it was beneath the dignity of the Primary Essence to contend with these demons; others were of opinion that these bad spirits were naturally indestructible, and as the Supreme could neither destroy nor improve them, he had banished them to the centre of the earth and to the region beneath the moon, where they indulged in their baseness and exercised their dominion: in order, however, to protect the human race against fields so numerous and fearful, he commissioned good spirits, whose office it was to defend men against these corporeal demons. As the good and the bad spirits had various degrees of power, and different offices, so they had names given to them which described their functions. As the good spirits were under an obligation to protect men and furnish succour in their need, they were compelled to learn human language; accordingly it was believed that a guardian angel against every evil was possessed by every one who bore his mysterious name—a name which was to be pronounced only when succour was needed. All manner of names were therefore devised, by which the good spirits were conjured or informed of human necessities; and all the combinations of the alphabet were exhausted in order to bring about a commerce between men and angels. Here is the origin of the Cabbala, which gave strange names to these spirits, in order to bring them into connection with men, and by this means to do wonderful things (Matt. xii. 21-27). These names also sometimes served to drive bad spirits away: they were a kind of exorcism. For since it was believed that these demons had been banished to the centre of the earth, and that they could do evil only in consequence of having baffled the vigilance of the guardian spirits and escaped to the outer world, so, it was held, they were compelled to flee as soon as they heard the name of the good angels whose business it was to keep them shut up in subterranean caverns, and to punish them if they ventured from their prisonhouse. A power, too, was ascribed to the name of the spirit, or to the image which marked his office—a power which forced the spirit to come on being called; and, accordingly, it was held that this name carved on a stone kept the spirit near the person who wore the stone—a notion in which is probably found the origin of Talismans, which were formed either by words or symbolical figures.

The fragments of Berosus, preserved by Eusebius and Josephus, and to be found in Scaliger (*De Emendat. Temp.*), and more fully in Fabricius (*Bib. Gr.* xiv. 175), afford some information on the subject of Chaldean philosophy. Berosus was a priest of the god Baal, at Babylon, in the time of Alexander the Great. The Talmud and other works of the Jewish Rabbins may also be advantageously consulted, together with the following authorities:—Euseb. *Præp. Evang.* ix. 10; Philo, *De Mig. Mun.*; Selden, *De Diis Syris*, Proleg. 3; Stanley's *History of Oriental Philosophy*; Knorrri de Rosewroth, *Cabbala de*

rudata, s. doctrina Ebræorum transcendentalis et metaphysica atque theologica, t. 1, Solish. 1677, t. 2. 'Liber Johan. restitutus,' Francof. 1684; Kleuker, *Ueber der Natur und den Ursprung der Emanationslehre bei den Kabbalisten*, Riga, 1786; Molitor, *Philosophie der Geschichte*, 1827-8; Hartman, *Die enge Verbindung des A. T. mit dem N.*, 1831; Ketzner, *Lexicon von P. Fritsch*, 1838; Brucker, *Hist. Crit. Phil.*; Ritter, *Geschich. der Phil.*; *Vergleichende Mythologie von Nork*, 1836.—J. R. B.

CHALDÆANS (כַּלְדָּאִים) is the name which is found appropriated in parts of the Old Testament to inhabitants of Babylon and subjects of the Babylonian kingdom. In 2 Kings xxv., where an account is given of the siege of Jerusalem in the reign of Zedekiah, by Nebuchadnezzar, the latter monarch is expressly designated 'King of Babylon,' while his troops in general are spoken of as 'Chaldees,' 'the army of the Chaldees.' In Isaiah xiii. 19, Babylon is called 'the glory of kingdoms, the beauty of the Chaldees' excellency;' and in xliii. 13 of the same book, the country is termed 'the land of the Chaldeans.' So in Daniel ix. 1, 'In the first year of Darius, of the seed of the Medes, which was made king over the realm of the Chaldeans.' Ptolemy uses the term *Χαλδαία* (*χώρα*), Chaldæa, for that part of Babylonia which, lying in the south-west, borders on Arabia Deserta. Strabo speaks to the same effect, and Pliny terms Babylon *Chaldaicarum gentium caput*, the head of the Chaldean nations. The origin and condition of the people who gave this name to the Babylonians, have been subjects of dispute among the learned. Probably, however, they were the same people that are described in Greek writers as having originally been an uncultivated tribe of mountaineers, placed on the Carduchian mountains, in the neighbourhood of Armenia, whom Xenophon describes as brave and fond of freedom (*Cyrop.* i. 31; *Anab.* iv. 3, 4, 7, 8, 25). In Habakkuk i. 6-10 the Chaldeans are spoken of in corresponding terms: 'Lo, I raise up the Chaldeans, that bitter and hasty nation, which shall march through the breadth of the land to possess the dwelling-places that are not theirs; they are terrible and dreadful; their horses are swifter than leopards and more fierce than evening wolves; their horsemen shall spread themselves; they shall fly as the eagle that hasteth to eat.' They are also mentioned in Job i. 17: 'Chaldeans fell upon the camels (of Job) and carried them away.' These passages show not only their warlike and predatory habits, but, especially that in Job, the early period in history at which they were known.

As in all periods of history hardy and brave tribes of mountaineers have come down into the plains and conquered their comparatively civilized and effeminate inhabitants, so these Armenian Chaldeans appear to have descended on Babylon, made themselves masters of the city and the government, and eventually founded a dominion, to which they gave their name, as well as to the inhabitants of the city and the country tributary to it, infusing at the same time young blood and fresh vigour into all the veins and members of the social frame. What length of time the changes herein implied may have

taken cannot now be ascertained. Winer (*Realwörterbuch*, s. v. *Chaldæer*) conjectures that the Chaldeans were at first subjects of the Assyrian monarchy, which, from 2 Kings xvii. 24, &c., also 2 Chron. xxxiii. 11, appears to have been established in Babylon; and that, while subjects of that empire, they became civilized, gained for themselves the government, and founded the Chaldee-Babylonian kingdom or dynasty.

Of the kingdom of Babylon, Nimrod (Gen. x. 8, sqq.) was the founder and first sovereign. The next name of a Babylonian monarch is found in Gen. xiv. 1, where 'Amraphel, king of Shinar,' is cursorily mentioned. A long interval occurs, till at last, in 2 Kings xx. 12, 13, the name of another is given: 'Berodach-baldan, the son of Baladan, king of Babylon,' it appears 'sent letters and a present unto Hezekiah; for he had heard that Hezekiah had been sick. And Hezekiah hearkened unto them, and shewed them all the house of his precious things: there was nothing in his house, nor in his dominion, that Hezekiah shewed them not.' On becoming acquainted with this fact, the prophet Isaiah announced that the treasures of the kingdom would be plundered and taken to Babylon along with the descendants of Hezekiah, who were to become eunuchs in the palace of the king of Babylon. The friendly act which passed between these two kings took place in the year b.c. 713. About a hundred years later, the prophets Jeremiah and Habakkuk speak of the invasion of the Chaldee army. Nebuchadnezzar now appears in the historical books, and, in Ezra v. 12, is described as 'the king of Babylon, the Chaldee, who destroyed this house (the temple), and carried the people away into Babylon.' How extensive and powerful his empire was, may be gathered from the words of Jeremiah xxxiv. 1.—'Nebuchadnezzar, king of Babylon, and all his army, and all the kingdoms of the earth of his dominion, and all the people, fought against Jerusalem.' The result was, that the city was surrendered, and the men of war fled, together with king Zedekiah, but were overtaken in the plains of Jericho and completely routed. The Israelitish monarch was carried before Nebuchadnezzar, who ordered his eyes to be put out, after he had been compelled to witness the slaughter of his sons: he was then bound in fetters of brass and conveyed a captive to Babylon. The next Chaldee-Babylonian monarch given in the Scriptures is the son of the preceding, Evil-merodach, who (2 Kings xxv. 27) began his reign (b.c. 562) by delivering Jehoiachin, king of Judah, after the unfortunate sovereign had endured captivity, if not incarceration, for a period of more than six and thirty years. Circumstances incidentally recorded in connection with this event serve to display the magnitude and grandeur of the empire; for it appears (ver. 28) that there were other captive kings in Babylon besides Jehoiachin, and that each one of them was indulged with the distinction of having his own throne. With Belshazzar (b.c. 538), the son of Nebuchadnezzar, closes the line of Chaldee monarchs. In the seventeenth year of his reign, this sovereign was put to death, while engaged with all his court in high revelry, by Cyrus, when he took the city of Babylon in the night season (Dan. v. 30), and established in the city and its

dependencies the rule of the Medo-Persians [BEL-SHAZZAR].

It has been seen, from the foregoing statements, that the history of Babylon supplied by the Scriptures is brief, imperfect, and fragmentary. Little additional light can be borrowed from other quarters, in relation to the period comprised within the Biblical accounts.

The oldest history of the land, as delivered by Berosus (Euseb. *Chron.*), gives no information capable of being annexed to the sacred narratives; whilst there is in the Canon of Ptolemy a list of Babylonian kings, which, in union with Berosus and Abydenus (Euseb. *Chron.*), leads to a not improbable result. This canon enumerates at the time of Nabonassar (B.C. 747), the first independent king of Babylon, nineteen Babylonian kings, whose united reigns, including two periods of interregnum, make a total of 210 years. The first name which is found alike in Ptolemy and Berosus is Belibus, or Elibus, and Berosus represents this monarch as immediately succeeding Merodach-baladai, with the remark that the last, after the murder of the Assyrian viceroy, had liberated Babylon from the Assyrian yoke, and Belibus, putting his predecessor to death, took the government as an independent prince, until, after a period of three years, Sanherib besieged the city, and made Babylon again an Assyrian province, under his son Esarhaddon, or Asordanius. With Nabopolassar, the father of Nebuchadnezzar, there begins a new and clearer epoch in Babylonian history. This prince, who was properly an Assyrian viceroy or satrap in Babylon, being supported by an alliance with the Median rulers, succeeded in making himself the independent sovereign of Babylon, destroyed the city of Nineveh, and established his dominion over Phœnicia and Cœle-Syria. His son (B.C. 604) pushed these conquests as far as Egypt. Evil-merodach, his son, succeeded him (B.C. 561), but was, in the second year of his reign, put to death by his brother-in-law Neriglissar. The latter, on the death of his wife, undertook the government, and after four years (B.C. 555) was succeeded by his son, Laboro-soarchod. But the youth could not sustain himself in power for longer than nine months. A conspiracy robbed him of his crown and life, and Nabonmidus (in Herodotus called Labynetus), that is, the Belshazzar of the Bible, ascended the throne, who, in the year B.C. 538 or 539, was overcome by Cyrus. From this event Babylon became a Persian province, and shared the fate of the Persian empire.

Authentic history affords no information as to the time when the Chaldean immigration took place. It is possible that, at a very early period, a tribe of Chaldees wandered into Babylon and gave to the land the seven Chaldee kings mentioned by Berosus; but it is possible also that the Chaldeans entered in a mass into the Babylonian territory for the first time not long before the era of Nabonassar (B.C. 747), which Michaelis and others have thought the words of Isaiah render probable, ch. xxiii. 13—'Behold the land of the Chaldeans, this people was not, till the Assyrian founded it for them that dwell in the wilderness.' The circumstance, moreover, that a Shemitic dialect is found to have prevailed in Babylon, corroborates the idea that the Chaldeans were immigrants, since the northern Chaldeans

must, from their position, have spoken a different form of speech.

The kingdom of the Chaldees is found among the four 'thrones' spoken of by Daniel (vii. 3, sqq.), and is set forth under the symbol of a lion having eagles' wings. The government was despotic, and the will of the monarch, who bore the title of 'King of Kings' (Dan. ii. 37), was supreme law, as may be seen in Dan. iii. 12; xiv. 28. The kings lived inaccessible to their subjects in a well-guarded palace, denominated, as with the ancient Persians (Xenop. *Cyrop.* 1), 'the gate of the king' (Dan. ii. 49, compared with Esther ii. 19, 21, and iii. 2). The number of court and state servants was not small; in Dan. vi. 1, Darius is said to have set over the whole kingdom no fewer than 'an hundred and twenty princes.' The chief officers appear to have been a sort of 'mayor of the palace,' or prime minister, to which high office Daniel was appointed (Dan. ii. 49), 'a master of the eunuchs' (Dan. i. 3), 'a captain of the king's guard' (Dan. ii. 14), and 'a master of the magicians,' or president of the Magi (Dan. iv. 9). Distinct probably from the foregoing was the class termed (Dan. iii. 24, 27) 'the king's counsellors,' who seem to have formed a kind of 'privy council' or even 'cabinet' for advising the monarch and governing the kingdom. The entire empire was divided into several provinces (Dan. ii. 48; iii. 1), presided over by officers of various ranks. An enumeration of several kinds may be found in Dan. iii. 2, 3. The head officers, who united in themselves the highest civil and military power, were denominated אַחֲרַיִם, 'presidents' (Dan. vi. 2); those who presided over single provinces or districts bore the title of פְּרוֹת (Hagg. i. 1; ii. 2), in the Chaldee dialect פְּרוֹתָא, 'governor.' The administration of criminal justice was rigorous and cruel, will being substituted for law, and human life and human suffering being totally disregarded. Nebuchadnezzar (Dan. ii. 5) declares to the college of the Magi—'If ye will not make known unto me the dream with the interpretation thereof, ye shall be cut in pieces, and your houses shall be made a dunghill' (see also Dan. iii. 19; vi. 8; Jer. xxix. 22). The religion of the Chaldees was, as with the ancient Arabians and Syrians, the worship of the heavenly bodies; the planets Jupiter, Mercury, and Venus were honoured as Bel, Nebo, and Meni, besides Saturn and Mars (Gesenius *On Isaiah*). Astrology was naturally connected with this worship of the stars, and the astronomical observations which have made the Chaldean name famous were thereby guided and advanced. The language spoken in Babylon was what is designated Chaldee, which is Shemitic in its origin, belonging to the Aramaic branch. The immigrating Chaldeans spoke probably a quite different tongue, which the geographical position of their native country shows to have belonged to the Medo-Persian stock.

The term Chaldeans represents also a branch of the order of Babylonian Magi (Hesych. Χαλδαῖοι γένος Μάγων). In Dan. ii. 2 they appear among 'the magicians, and the astrologers, and the sorcerers,' who were 'called for to shew the king his dream.' In the 10th verse of the same chapter they are represented as speaking in the name of the rest; or otherwise theirs was a general designation which comprised the entire class

(Dan. iv. 7; v. 7): a general description of these different orders is found in Dan. v. 8, as 'the king's wise men.' In the Greek and Roman writers the term *Chaldeans* describes the whole order of the learned men of Babylon, (Strabo, xv. p. 598; Diod. Sic. ii. 29; Cic. *De Div.* i. 1. 2). In later periods the name Chaldeans seems, without reference to place of birth, to have been applied in the western parts of the world to persons who lived by imposing on the credulity of others, going from place to place professing to interpret dreams and disclose the future. In this sense the word is obviously used by Josephus (*De Bell. Jud.* ii. vii. 38), when 'diviners and some Chaldeans' are said to have been called in by Archelaus to expound what was 'portended' by a dream he had had when he 'seemed to see nine ears of corn, full and large, but devoured by oxen.'—Winer's *Realwörterbuch*; *Real-Encyclopädie der Class. Alterthum*, W. von Pauly; Ideler, *Handbuch der Chron.* [BABYLON].—J. R. B.

CHALDEE LANGUAGE is the name by which the elder form of the Aramaic idiom is generally distinguished. Whether there is any authority in the Old Testament for applying this designation to the Aramaic language is a question which depends on the sense in which the expression 'tongue of the Chaldees,' in Dan. i. 4, is to be taken; and which involves such important historical points that it does not come within the scope of this article (see Hengstenberg, *Authentic des Daniel*, p. 310). Another preliminary question is, whether there is any propriety in the common definition of the Chaldee language as the *eastern*, and especially as the *Babylonian* dialect—or, indeed, even as a *dialect* at all—of the Aramaic. Hupfeld strenuously maintains the negative of all these propositions in the *Theologische Studien* for 1830, p. 290, sq. Avoiding these debateable points, however, we apply the name Chaldee language to that Aramaic idiom which, in our present text of the Old Testament, is employed in the passages of Daniel, from ii. 4 to vii. 28; in Ezra, from iv. 8 to vi. 18, and vii. from 12 to 26; in Gen. xxxi. 47; and in Jer. x. 11; as also to that in which several translations and paraphrases of portions of the Old Testament, the so-called Targums, are written. The language is thus distinguished, as to the nature of the documents in which it is employed, into Biblical and Targumical Chaldee. Winer, however, regarding linguistic characteristics chiefly, distinguishes three grades of its purity: the language, as found in the Targum of Onkelos, as most free from Hebraisms; the Biblical Chaldee, which, as it frequently intermixes certain peculiarities of Hebrew (as the η of the article, the plural ending *im*, the dual form, and the conjugation *Hophal*), ranks below the first class; and the idiom of the other Targums, which not only abounds with foreign words, but possesses several peculiar formations which border on those of the Syriac and of Rabbinical Hebrew. The language of the Talmud is also usually called Chaldee; and, if we except the Mishnah (which is written in an idiom not so very far removed from Biblical Hebrew, with a tincture of Chaldee), it is true of the Gemaras that they are written in such very *corrupt* Chaldee that their idiom is more properly designated as the Talmudical dialect.

We have already [ARAMAIC LANGUAGE] noticed those several features which the Chaldee possesses in common with the Syriac; and it now remains to define those, certainly not marked, characteristics by which it is distinguished from it. These are—the predominance of the *a*-sound where Syriac has *o*; the avoidance of diphthongs and of otiant letters; the use of daghes-forte; the regular accentuation of the last syllable; and the formation of the infinitives, except in *Peal*, without the preformative \mathfrak{D} . The mode of writing is also much less *defective* than in Syriac [TARGUM].—J. N.

CHAMBERS OF IMAGERY. The scenes of pictorial representation referred to by this phrase are connected with an interesting passage in the history of Ezekiel and the Jewish exiles, who were stationed in Assyria, on the banks of the Chebar. At one of their interesting prayer-meetings for the restoration of Israel, which had been held so often and so long without any prospect of brighter days, and when the faith and hopes of many of the unfortunates were waxing dim and feeble, Ezekiel, in presence of his friends, consisting of the exiled elders of Judah, was suddenly wrapt in mystic vision, and graciously shown, for his own satisfaction, as well as that of his pious associates, the reasons of God's protracted controversy with Israel, and the sad necessity there was for still dealing hardly with them. Transported by the Spirit (not bodily, indeed, nor by external force, but in imagination) to the city and temple of Jerusalem, he there saw, as plainly as if it had been with the eye of sense, atrocities going on within the precincts of the holy place—the perpetration of which in the very capital of Judæa, the place which God had chosen to put his name there, afforded proof of the woful extent of national apostasy and corruption, and was sufficient to justify, both to the mind of the prophet, and his circle of pious associates, the severity of the divine judgments on Israel, and the loud call there was for prolonging and increasing, instead of putting a speedy end to, the dire calamities they had so long been suffering (Ezek. viii.).

The first spectacle that caught his eye, as he perambulated, in mystic vision, the outer court of the Temple—that court where the people usually assembled to worship—was a colossal statue, probably of Baal, around which crowds of devotees were performing their frantic revelries, and whose forbidden ensigns were proudly blazoning on the walls and portals of His house, who had proclaimed himself a God jealous of his honour (ver. 3, Lowth *in loc.*). Scarcely had the prophet recovered from his astonishment and horror at the open and undisguised idolatry of the multitude in that sacred enclosure, when his celestial guide bade him turn another way, and he would see greater abominations. Leading him to that side of the court, along which were ranged the houses of the priests, his conductor pointed to a mud-wall (ver. 7), which, to screen themselves from observation, the apostate servants of the true God had raised; and in that wall was a small chink, by widening which he discovered a passage into a secret chamber, which was completely impervious to the rays of the sun, but which he found, on entering it, lighted up by a profusion of brilliant lamps. The sides of

it were covered with numerous paintings of beasts and reptiles—the favourite deities of Egypt; and, with their eyes intently fixed on these decorations, was a conclave of seventy persons, in the garb of priests—the exact number, and, in all probability, the individual members of the Sanhedrim, who stood in the attitude of adoration, holding in their hands each a golden censer, containing all the costly and odoriferous materials which the pomp and magnificence of the Egyptian ritual required. ‘There was every form of creeping things and abominable beasts, and all the idols of the house of Israel portrayed round about.’ The scene described was wholly formed on the model of Egyptian worship; and every one who has read the works of Wilkinson, Belzoni, Richardson, and others, will perceive the close resemblance that it bears to the outer walls, the sanctuaries, and the hieroglyphical figures that distinguished the ancient mythology of Egypt. What were the strange and unsightly images engraven on the walls of this chamber discovered by Ezekiel, and that formed the objects of the profane reverence of these apostate councillors, may be known from the following metrical description, which the late Mr. Salt, long the British Consul in Egypt, has drawn of the gods worshipped by the ancient idolatrous inhabitants of that country. Those who have prosecuted their researches among the rubbish of the temples, he says, have found in the deeply-sequestered chambers they were able to reach—

‘The wildest images, unheard of, strange,
That ever puzzled antiquarians’ brains:
Genii, with heads of birds, hawks, ibis, drakes,
Of lions, foxes, cats, fish, frogs, and snakes,
Bulls, rams, and monkeys, hippopotani;
With knife in paw, suspended from the sky,
Gods germinating men, and men turn’d gods,
Seated in honour, with gilt crooks and rods;
Vast scarabæi, globes by hands upheld,
From chaos springing, ’mid an endless field,
Of forms grotesque, the sphinx, the crocodile,
And other reptiles from the slime of Nile.’

In order to show the reader still further how exactly this inner chamber that Ezekiel saw was constructed after the Egyptian fashion, we subjoin an extract from the work of another traveller, descriptive of the great Temple of Edfou, one of the admired relics of antiquity; from which it will be seen that the degenerate priests of Jerusalem had borrowed the whole style of the edifice, in which they were celebrating their hidden rites—its form, its entrance, as well as its pictorial ornaments on the walls—from their idolatrous neighbours of Egypt:—‘Considerably below the surface of the adjoining building,’ says he, ‘my conductor pointed out to me a *chink in an old wall*, which, he told me, I should creep through on my hands and feet; the aperture was not two feet and a half high, and scarcely three feet and a half broad. My companion had the courage to go first, thrusting in a lamp before him: I followed. The passage was so narrow that my mouth and nose were almost buried in the dust, and I was nearly suffocated. After proceeding about ten yards in utter darkness, the heat became excessive, the breathing was laborious, the perspiration poured down my face, and I would have given the world to have got out; but my companion, whose person I could not distinguish,

though his voice was audible, called out to me to crawl a few feet farther, and that I should find plenty of room. I joined him at length, and had the inexpressible satisfaction of standing once more upon my feet. We found ourselves in a *splendid apartment of great magnitude*, adorned with an incredible profusion of sacred *paintings and hieroglyphics*’ (Madden’s *Trav. in Turkey, Egypt, &c.*; see also Maurice, *Indian Antiq.* vol. ii. p. 212). In the dark recesses of such a chamber as this, which they entered like the traveller through a hole in the outer wall, and in which was painted to the eye the grotesque and motley group of Egyptian divinities, were the chief men at Jerusalem actually employed when Ezekiel saw them. With minds highly excited by the dazzling splendour, and the clouds of fragrant smoke that filled the apartment, the performers of those clandestine rites seem to have surpassed even the enthusiastic zeal of their ancestors in the days of Moses, when, crowding round the pedestal of the golden calf, they rent the air with their cries of ‘These be thy gods, O Israel!’ Beneath a calmer exterior, the actors in the scene pointed out to Ezekiel concealed a stronger and more intense passion for idolatry. Every form of animal life, from the noblest quadruped to the most loathsome reptile that spawned in Egypt, received a share of their insane homage; and the most extraordinary feature of the scene was that the individual who appeared to be the director of these foul mysteries, the master of ceremonies, was Jaazaniah, a descendant of that zealous scribe who had gained so much renown as the principal adviser of the good king Josiah, and whose family had for generations been regarded as the most illustrious for piety in the land. The presence of a scion of this venerated house in such a den of impurity, struck the prophet as an electric shock, and showed better, than all the other painful spectacles this chamber exhibited, to what a fearful extent idolatry had inundated the land.

It might have been supposed impossible for men to have sunk to a lower depth of superstition than that of imitating the Egyptians in worshipping the monsters of the Nile, or the vegetable produce of their fields and gardens, had not the prophet been directed to turn yet again, and he would see greater abominations that they did. ‘Then he brought me to the gate of the Lord’s house, which was towards the north; and behold there sat women weeping for Tammuz’ (ver. 14). This, the principal deity of the Phœnicians, and who was often called also by that people Adoni, that is, My Lord, became afterwards famous in the Grecian mythology under the well-known name of Adonis; and the circumstance of his being selected for the subject of their most beautiful fiction by so many of the classic poets, is a sufficient proof of the great popular interest his name and ritual excited among the idolators of the ancient world. It is said to have originated in a tragic adventure that befel an intrepid and beautiful prince of Phœnicia, who was killed while hunting a wild boar, by which that land was infested, and whose untimely death in the cause of his country was bewailed in an annual festival held to commemorate the disastrous event. During the seven days that the festival lasted, the Phœnicians appeared to be a nation of mourners; and

In every town and village a fictitious representation of Tammuz was got up for the occasion, and the whole population assembled to pour forth their unbounded sorrow for his hapless fate, more especially at Byblos, in Syria, where a temple was erected in honour of this national deity. A strange imposture was practised to influence the public lamentations. There was on this temple a gigantic statue of the god, the eyes of which were filled with lead, which, on fire being applied within, of course melted and fell in big drops to the ground, a signal for the loud wailings of the bystanders, whose eyes in sympathetic imitation were dissolved in tears. Conspicuous among the crowd, on such occasions, a band of mercenary females directed the orgies; and, in conformity with an ancient custom of bewailing the dead on anniversaries at the *doors of houses* (Potter's *Grec. Antiq.* b. iv. ch. 3), others took their station at the *gate*, with their faces directed northward, as the sun was said to have been in that quarter of the heavens at the time when Tammuz died. These violent efforts in mourning were always followed by scenes of the most licentious and revolting revelry, which, though not mentioned, are manifestly implied among the 'greater abominations' which degraded this other group of idolaters.

Besides the hieroglyphics of Egypt and the orgies of Tammuz, there was another form of superstition still, which in Jerusalem, then almost wholly given to idolatry, had its distinguished patrons. 'Turn thee yet again,' said his celestial guide to the prophet, 'and thou shalt see greater abominations than these' (ver. 16). And he brought him 'unto the inner court of the Lord's house, and behold at the door of the temple of the Lord, between the porch and the altar, were about five-and-twenty men, with their backs towards the temple of the Lord, and their faces towards the east; and they worshipped the sun towards the east.' Perhaps of all the varieties of superstition which had crept in among the Hebrews in that period of general decline, none displayed such flagrant dishonour to the God of Israel as *this* (Clemens Alexandrinus, *Strom.* vii. p. 520); for, as the most holy place was situated at the west end of the Sanctuary, it was impossible for these twenty-five men to pay their homage to the rising sun without turning their backs on the consecrated place of the divine presence; and accordingly this fourth circle is introduced last, as if their employment formed the climax of abominations—the worst and most woful sign of the times. Could stronger proofs be wanted that the Lord had not forsaken Israel, but was driven from them? This was the lesson intended, and actually accomplished, by the vision; for while the prophet was made aware by this mystic scene of the actual state of things among his degenerate countrymen at home, he saw himself—and instructed the pious circle around him to see—a proof of the long-suffering and the just severity of God in deferring to answer their fervent and long-continued prayers for the emancipation of their country.—R. J.

CHAMELEON appears to be a satisfactory translation of תנשמת *tinshemeth*, which denotes a small species of lizard, celebrated for the faculty it has of changing the colour of its skin. This property, however, has no reference to the substance it may be placed on, as generally asserted, but is

solely derived from the bulk of its respiratory organs acting upon a transparent skin, and on the blood of the animal. The chameleons form a small genus of Saurians, easily distinguished by the shagreened character of the skin, and the five toes on the feet, divided differently from those of most other animals, there being, if the expression may be allowed, two thumbs opposed to three fingers. Their eyes are telescopic, move separately, and can be directed backwards or forwards. Chameleons are slow, inoffensive, and capable of considerable abstinence from food; which consists solely of flies, caught by the rapid protrusion of a

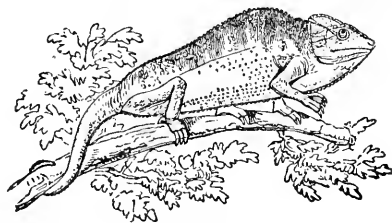

217. [Chameleon Africanus.]

long and viscous tongue. Among themselves they are irascible, and are then liable to change their colours rapidly: dark yellow or grey is predominant when they are in a quiescent state, but, while the emotions are in activity, it passes into green, purple, and even ashy black. The species found in Palestine and all Northern Africa, is the common *Chameleon Africanus*, and is that referred to in Lev. xi. 30, where unclean animals are mentioned.—C. H. S.

CHAMOIS. [ZEMER.]

CHAOS, a term taken from the Greek mythology, according to which Chaos was the first existence and the origin of all subsequent forms of being (Hesiod, *Theogon.* 116; Ovid, *Metamorph.* i. 5). The description which Ovid gives of Chaos itself, and of the formation of the world from the chaotic mass, bears so many striking resemblances to the Mosaic account of the creation, that one can scarcely fail to regard it as having been derived from traditions, the source of which is to be traced to the sacred record. There is, however, this great difference between the scriptural and the heathen cosmogonies—that the former sets out with the emphatic declaration that the unformed mass was the creation of God; whilst the latter speaks of it as the already existing materials out of which he formed the world, or even as itself the cause and author of all things. If, however, heathen philosophers have been indebted to the inspired narrative for their most consistent views of the formation of the world, on the other hand Christian philosophers have borrowed from them (with very little advantage, as we think) the term by which the unformed condition of the world was denoted, and, with the word, have too frequently associated some part of the heathen idea attached to it. Our present object is to inquire what the Chaos was of which Moses speaks (Gen. i. 2). Was it the first form in which matter was created? and do the succeeding operations described relate to the very beginning of material order and animal life? Or was it merely a condition preparatory to the re-

organization of the world, which had already been the abode of living beings?—in other words, is the first verse of the inspired record to be dissociated from the succeeding, and to be understood only as a declaration of the important truth, that the visible universe was not made from anything already existing (Heb. xi. 3); whilst the confusion and darkness which are described in the succeeding verse, relate to a state long subsequent to the 'beginning,' and were introductory to a new order of material existence, of which man is the chief and lord? The first of these opinions is not only in accordance with the ancient notions of chaos to which we have referred, but is that which would be naturally maintained, unless cause be shown to the contrary. No one would gratuitously assume a long interval, where it must be admitted there is no intimation of such an interval having occurred. Accordingly, most interpreters, who have been ignorant of geological phenomena, have at once decided that the chaos of which Moses speaks was the form in which matter was first created. Some have even declared that there cannot have been any such interval as we have spoken of (Prof. Stuart, in *Bib. Repos.* No. xxi., Jan. 1836). But, on the other hand, the world gives intimations, in the rocks which compose its crust, of various and long-continued changes both of condition and of inhabitants. Those who have carefully examined these different forms of being, and have attentively studied the circumstances in which their remains are now found, have been forced to the conviction, that in many cases the rocks have been gradually formed by deposition at the bottom of an ocean, which has been successively the habitation of races differing alike from each other and from those now existing; that the coeval land likewise has had its distinct races of inhabitants, and that the land and water have changed places many times in the history of the world. It is impossible to do more than barely glance at these geological facts; but it will be seen that they lead to these three conclusions—(1) that the world has existed during some long period before the Mosaic record of creation in six days—(2) that, during that period, it was the abode of animals differing in organization and structure from those now found on its surface—and (3) that it has been exposed to various convulsions and reorganizations, more or less general. In the face of these facts it appears impossible to hold the ordinarily received opinion that the universe was created only just before the creation of man; and the question then is, how are these facts to be reconciled with the Mosaic narrative? Not by denying the evidence of our senses (which is, in truth, a very dangerous mode of upholding the sacred record, though it has been adopted by those who especially claim to themselves the title of Scriptural Geologists), nor, on the other hand, by treating the Mosaic account as a *mythus*, or allegorical representation (a mode of explanation, which, if ever admissible, ought not to be resorted to without the most pressing necessity), but surely by re-examining the interpretation we have put on the words of Scripture, and by seeking to ascertain whether the discrepancy does not arise from *our view* of the narrative. A favourite mode of explaining the Mosaic account, a few years back, was to take the six days of cre-

ation for unlimited periods, during which the changes we are speaking of took place. This ground has, however, been almost completely abandoned, both because the account so understood does not agree with the physical phenomena, and because such an interpretation is, to say the least, hardly admissible on exegetical principles. If we keep in mind that the revelation of God to man is not intended to teach physical science—that it never speaks the language of philosophy, but of appearances—and that it tells of these only so far as they relate to the human race, we obtain a clue by which we may be safely guided through these difficulties. We shall not then wonder that no notice should be taken of previous conditions and inhabitants of this earth, supposing such to have existed. The first sentence of the inspired record will then be regarded as the majestic declaration of a fact, which the world had lost sight of, but which it deeply concerned men to know. What occurred subsequently, until the earth was to be furnished for the abode of man, is to be gathered not from the written word, but from the memorials engraven on the tablets of the world itself. The succeeding verse of the Mosaic account then relates to a state of chaos, or confusion, into which the world was thrown immediately before the last reorganization of it. The connection of the two sentences by the Hebrew copulative ו seems to us to furnish no serious difficulty. Every attentive reader knows that this particle is very frequently used to continue a narrative when the events so connected were by no means immediately consecutive. Nor is such a chaos opposed to geological phenomena, which plainly tell of 'critical periods' and of 'revolutions of organic life' (Phillips's *Geology*, in *Cab. Cycl.* vol. ii. p. 264). Geologists are not indeed at present (if ever they may be) in a condition to identify the disruption and confusion of which we suppose Moses to speak with any one of these violent convulsions; but that events which might be described in his language have taken place in the world's history, over considerable portions of its surface, seems to be fully established. Whether the chaos of which we are now speaking was universal, or was confined to those regions which formed the cradle of the human race, is a question on which we do not feel it needful to enter. We do not regard the evidence which geology furnishes as complete enough to decide such a point, though the latter supposition has been adopted by Dr. Pye Smith, in his lectures *On the Relation between the Holy Scriptures and some Parts of Geological Science*. To these lectures, as well as to the articles by Professor Hitchcock, in the *Biblical Repository* (Nos. 17, 18, 20, and 22), and to various papers which have appeared at different times in the *Christian Observer*, the reader is referred for a fuller discussion of this and kindred questions.—F. W. G.

CHARGOL (כַּרְגוֹל; Sept. Ὀφιομάχης; Vulg. *Ophiomachus*; Eng. Vers. *Beetle*; found only in Lev. xi. 22). This word cannot mean the *beetle*. No species of scarabæus was ever used as food by the Jews, or perhaps any other nation. Nor does any known species answer to the generic description given in the preceding verse: 'This ye may eat of every winged creeper which goeth upon four

(feet); that which hath joints at the upper part of its mind legs, to leap with them upon the earth' (comp. Niebuhr, *Descrip. de l'Arabie*, Copenhagen, 1773, p. 33). Hence it is plain that the chargol is some winged creeper, which has at least four feet, which leaps with its two hind jointed legs, and which we might expect, from the permission, to find actually used as food. This description agrees exactly with the *locust-tribe* of insects, which are well known to have been eaten by the common people in the East from the earliest times to the present day. This conclusion is also favoured by the derivation of the word, which comes from *חרגל*, to shake, and *רגל*, the foot, like the English grasshopper, and French sauterelle.

The Arabic *رجل* is derived from a word signifying a troop or swarm, and is explained by Golius as a *species of locusts without wings*. It seems, indeed, to be so generally agreed among the learned that chargol denotes the locust, that the matter of dispute is rather what particular *species* of locust is intended, or whether the word describes any one of those several *states* through which the locust passes, in each of which it greatly resembles the perfect insect, the only difference being, that in the larva state it is entirely *destitute of wings and wing-cases*, and that in the pupa state it possesses only the rudiments of those members gathered up so as to form four little buttons on the shoulders. Swammerdam observes that the want of attention to these particulars, in former writers, had led to a very unnecessary multiplication of names, Aldrovand, Johnson, Mousset, and others having described the locust in these several states under the names bruchi, atelabi, aselli, &c., supposing them to be so many distinct species. Michaelis, on the other hand, contends that the several words in this passage, *סלעם, חרנל, חנב, ארבה*, denote only the four successive states of locusts, produced by casting off their several skins or coverings.

Their *first* state, he thinks, is before they have cast off their first cuticle; but that, since in this state they are so small as not to be readily used for food, Moses enumerates only their *four* remaining states (*Supplement. ad Lexicon Hebraic.* pt. iii. pp. 667-669, and 910-912). To this view, however, it is justly objected by Rosenmüller (apud Bochart), that the phrase 'after its kind or species,' added to *each* of these terms, is not consistent with the various *states* merely through which the locust passes. Tychsen maintains that the words refer to four different *species* of locusts, and endeavours to show that *ארבה* is the *gryllus gregarius*, Forskalli; that *סלעם* is the *gryllus evorsor de asso* apud Roeselium; *חרנל*, the *gryllus gurges de asso*, et *gryllus verrucivorus*, Linn.; and that the *חנב* is the *gryllus coronatus*, Linn. (Tychsen, *Comment. de Locustis Biblicis*, subjoined to Don Ignacio de Asso y del Rio's, *Abhandlung von den Heuschrecken und ihren*, &c., Rostock, 1787-8).

In attempting to ascertain the particular *species* of locust intended by the word 'chargol,' great defence is due to the term adopted by the Septuagint and repeated by Jerome, which is evidently derived from *ῥῆσις* and *μάχη*, and indicates

a creature that fights with serpents. Inapplicable as such a description may seem to be to the habits of any known species of locust, it may, never-

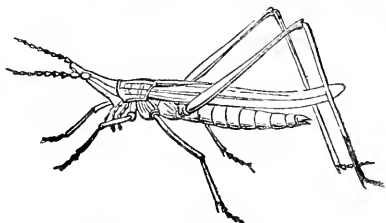

216. [Truxalis nasutus.]

theless, help to identify the species of which we are in search. Now the ancients have certainly referred to the notion of locusts fighting with serpents (Aristot. *Hist. Anim.* ix. 9; Plin. *Hist. Nat.* xi. 35). Although this notion is justly discarded by Cuvier (Grandsagne's edition of Pliny, Parisii, 1828, p. 451, note), yet it may serve to account for the application of the term *ῥησιμαχῆς* to a species of locust. For this word instantly suggests a reference to the *ichneumon*, the celebrated destroyer of serpents and other vermin; and it is remarkable that Hesychius, in the second century, applies the word *ῥησιμαχῆς* both to the *ichneumon*, and a species of locust having no wings. If then any species of locust can be adduced whose habits resemble those of the *ichneumon*, may not this resemblance account for the name, quasi the *ichneumon* (locust); just as the whole genus of insects called *Ichneumonidæ* were so denominated because of the *supposed* analogy between their services and those of the Egyptian *ichneumon*? and might not this name, given to that species of locust at a very early period, have afterwards originated the erroneous notion referred to by Aristotle and Pliny? Now, there is one kind of locusts, the genus *truxalis* (fierce or cruel), inhabiting Africa and China, and comprehending many species, which hunts and preys upon insects. It is also called the *truxalis nasutus*, or long-nosed. May not, then, this winged, leaping, insectivorous locust, and its various species, be 'the chargol, after its kind,' and the *ῥησιμαχῆς* of the Septuagint? or might the name have arisen from the similarity of *shape and colour*, which is striking, between the *truxalis nasutus* and the *ichneumon*; just as the locust generally, is, at this time, called *cavalette* by the Italians, on account of its resemblance in shape to the horse? We know that the ancients indulged in tracing the many resemblances of the several parts of locusts to those of other animals (Bochart, *Hieroz.* pt. ii. lib. iv. c. 5, p. 475). It may be observed, that it is no objection to the former and more probable supposition, that a creature which lives upon other insects should be allowed as food to the Jews, contrary to the general principle of the Mosaic law in regard to birds and quadrupeds, this having been unquestionably the case with regard to many species of fishes coming within the regulation of having 'fins and scales,' and known to exist in Palestine at the present time—as the perch, carp, barbel, &c. (Kitto's *Physical History of Palestine*, article FISHES). The fact that the Chargol is never made the means of the divine chastisements (for which purpose a

locust preying upon insects *could* scarcely be used), *concur*, at least, with the foregoing speculation—J. F. D.

CHARIOT RACES. [GAMES.]

CHARIOTS. The Scriptures employ different words to denote carriages of different sorts, but it is not in every case easy to distinguish the kind of vehicle which these words severally denote. We are now, however, through the discovery of ancient sculptures and paintings, in possession of such information respecting the chariots of Egypt, Assyria, Babylon, and Persia, as gives advantages in the discussion of this subject which were not possessed by earlier writers. The chariots of these nations are, in fact, mentioned in the Scriptures; and by connecting the known with the unknown, we may arrive at more determinate conclusions than have hitherto been attainable.

The first chariots mentioned in Scripture are those of the Egyptians; and by close attention to the various notices which occur respecting them, we may be able to discriminate the different kinds which were in use among that people.

The earliest notice on this head occurs in Gen. xli. 43, where the king of Egypt honours Joseph by commanding that he should ride in the second of the royal chariots. This was doubtless a state-chariot, and the state-chariots of the Egyptians do not appear to have been different from their war-chariots, the splendid military appointments of which rendered them fit for purposes of royal pomp. This view of the matter is confirmed by our finding that, although the same word (*מרכבה* *mercabah*) is again used for chariots of state in Gen. xli. 29, 1 Sam. viii. 11, 2 Sam. xv. 1, it undoubtedly denotes a war-chariot in Exod. xv. 4, Joel ii. 5. In Isa. ii. 7, the same word appears to comprehend chariots of every kind which were found in cities. This may be accounted for by the fact that chariots anciently in the east were used almost entirely for purposes of state or of war, being very rarely employed by private persons. We also observe that where private carriages were known, as in Egypt, they were of the same shape as those used in war, and only differed from them by having less complete military accoutrements, although even in these the case for arrows is not wanting. One of the most interesting of the Egyptian paintings represents a person of quality arriving late at an entertainment in his curricule, drawn (like all the Egyptian chariots) by two horses. He is attended by a

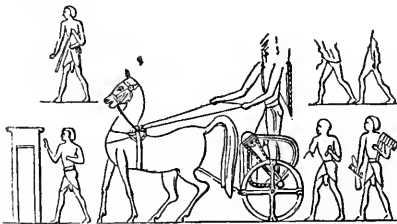

219. [Egyptian Curricule.]

number of running footmen, one of whom hastens forward to knock at the door of the house, another advances to take the reins, a third bears a stool

to assist his master in alighting, and most of them carry their sandals in their hands that they may run with the more ease. This conveys a lively illustration of such passages as 1 Sam. viii. 11, 2 Sam. xv. 1. The principal distinction between these private chariots and those actually used in war was, as appears from the monuments, that in the former the party drove himself, whereas in war the chariot, as among the Greeks, often contained a second person to drive it, that the warrior might be at liberty to employ his weapons with the more effect. But this was not always the case; for in the Egyptian monuments we often see even royal personages alone in their chariots, warring furiously, with the reins lashed round their waist (No. 223). So it appears that Jehu (who certainly rode in a war-chariot) drove himself; for his peculiar style of driving was recognised at a considerable distance (2 Kings ix. 20).

There has been some speculation as to any difference of meaning between the preceding word *mercabah* (*מרכבה*), and *mercab* (*מרכב*). In 1 Kings v. 6, the latter obviously means chariots, taken collectively. But in Lev. xv. 9 (rendered in the Auth. Vers. 'saddle') and Cant. iii. 10 (rendered 'the bottom') it has been understood by some to denote the seat of a chariot. To this view there is the fatal objection that ancient chariots had no seats. It appears to denote the seat of a litter (the only vehicle that had a seat), and its name *mercab* may have been derived from the general resemblance of the body of a litter (distinguished from the canopy, &c.) both in form and use, to that of a chariot.

Another word, *רעב* *receb*, from the same root, appears to signify a carriage of any kind, and is especially used with reference to large bodies of carriages, and hence most generally of war-chariots; for chariots were anciently seldom seen together in large numbers except when employed in war. It is applied indifferently to the war-chariots of any nation, as to those of the Egyptians (Exod. xiv. 9), the Canaanites (Josh. xvii. 18; Judg. i. 19 iv. 3), the Hebrews (2 Kings ix. 21, 24; x. 16), the Syrians (2 Kings v. 9), the Persians (Isa. xxi. 7, 9). By a comparison of these references with those passages in which *mercabah* occurs, we find the two words applied with so little distinction to all sorts of carriages as to suggest that they were used indifferently and interchangeably, just as we should say either 'carriage' or 'coach,'—neither of which is specific, and both of which differ more from each other than the Hebrew *receb* and *mercabah*—to denote the same vehicle. Indeed there are passages in which both words are manifestly applied to the same identical vehicle, as in 2 Kings v. 9, 21, and 1 Kings xxii. 35, 38; where no reader would suspect a change of vehicles, which some have endeavoured to establish in order to make out a difference between the *receb* and *mercabah*. Mr. Charles Taylor, in one of the fragments appended to his edition of Calmet, indulges in much ingenious speculation on this subject, and labours to make out that while the *mercabah* denoted a chariot of state drawn by four horses, the *receb* was a humbler chariot drawn by two horses, and sometimes a litter carried by two horses. To this it may be sufficient to answer that chariots of state were *not* drawn by four horses in the East; that no instance of such a practice can be produced; and that the best Hebrew scholars of the

continent deny that it can be proved that *reccb* anywhere denotes a litter, for which indeed there is a different word [LITTER].

There is another word which is sometimes rendered by chariot, viz. *אגלה* 'agalah; but as we have elsewhere [CART] shown that it denotes a plaustrum, cart, or waggon, drawn by oxen, we need not here return to the subject. It is indeed alleged that in Ps. xlvii. 9 the word manifestly imports a chariot of war. The plural 'agaloth, is there used, and the supposition that it means a chariot of war proceeds on the assumption that only chariots were used in war. But this is not the fact, for in the scenes of Egyptian warfare we find carts, drawn by oxen, brought into the field by certain nomade nations, and in which they endeavour to escape from their pursuers.

In the prophecy of Nahum, who was of the first captivity, and resident (if not born) at El-kosh in Assyria, there is much allusion to chariots, suggested doubtless by their frequency before his eyes in the streets of Nineveh and throughout the Assyrian empire. In fact, when prophesying the downfall of Nineveh, he gives a particular and animated description of their action in the streets of the great city:—

The shield of his mighties is made red :
The valiant men are clothed in scarlet :
The chariots are as the fire of lamps, in the
day when he prepareth them.
And the horsemen spread fear
In the streets, the chariots madden :
They run to and fro in the broad places :
Their appearance is as lamps, they run
as lightning. Nahum ii. 3, 4.

These allusions to the horsemen and chariots of Nineveh give much interest to one of the very recent discoveries of M. Botta, on the site of that very ancient city. In excavating a certain mass of building, which appears to have formed part of some much more extensive pile, he discovered various inscriptions and sculptures, which seem to show that the work was earlier than the age of Cyrus, and may be referred to the times of the Assyrian Empire. In one place is a bas-relief, representing a horseman at full gallop. Another part of the same wall represents two horsemen galloping side by side, with another following at a short distance. Further on, two armed horsemen are visible, one following the other at full gallop. The movement of the horses is very animated; and both men and horses show traces of colour. In another place are two horsemen walking their horses side by side. The only horseman visible has a sword; a quiver and bow are over his shoulder, and his legs are clothed in mail. These figures are very interesting, not only in connection with the prophecy which so distinctly mentions the 'horsemen' of Nineveh, but because they are, in fact, the only mounted figures which occur among the more ancient monuments of Asia. None have been found at Babylon, none at Persepolis; and among the numerous sculptures and paintings of Egypt, only one solitary unarmed figure, who seems to have crossed the back of the animal by accident. But the matter of greatest interest is the discovery of a curious bas-relief, representing a chariot drawn by two horses, and containing three persons. The principal of these appears to be a bearded man,

lifting his right arm, and holding in his left hand a bow. He wears a tiara painted red ('the valiant men are clothed in scarlet'); behind him is a beardless slave, carrying a fringed parasol, and at his left is the charioteer holding the reins and the whip. The principal person and the charioteer wear ear-rings. The chariot-wheels have eight spokes: the chariot itself has been covered with carving, now impossible to be made out. The most noticeable thing is a bench, which seems to be attached to the chariot by a double belt, and which M. Botta supposes to have been a metal rod, intended to secure the solidity of the whole. The horses are admirably drawn, and afford indications of pure Arabian blood. Their harness is very rich, and still bears evident traces of colouring, among which blue and red only can be distinguished, the rest having turned black. Behind the chariot rides a cavalier, bearing a lance, with a sword at his belt, and a quiver over his shoulder (*Athenæum*, July 29, 1843).

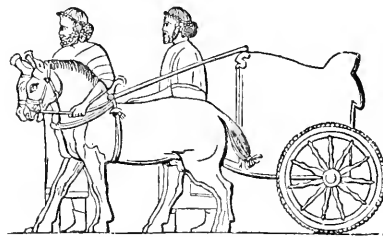

220. [Persian Chariot.]

From this description it would appear that the Assyrian chariots were considerably different from those of the ancient Egyptians, and even from those of the Persians, with which we are acquainted through the Persepolitan sculpture (now in the British Museum), here copied (No. 220), and which are of a much heavier build than those of Egypt, as perhaps the more mountainous character of the country required. The chariots of Assyria would seem in some respects to have occupied a middle place between the other two. Among other points we observe that the spokes of the wheels are never more than six in the Egyptian chariot, while in the Assyrian

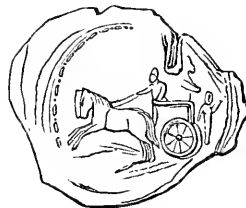

221. [Babylonian Chariot.]

there are eight, and in the Persian eleven. Not very different from the Persian chariot is one represented on a coin found at Babylon (No. 221); but the spokes of the wheels are eight, as in the Assyrian chariot. This coin has given occasion to much unsound speculation in the attempt to connect it with the history of Daniel.

CHARIOTS OF WAR. The Egyptians used horses in the equipment of an armed force

before Jacob and his sons had settled in Goshen; they had chariots of war, and mounted asses and mules, and therefore could not be ignorant of the art of riding; but for ages after that period Arab nations rode on the bare back, and guided the animals with a wand. Others, and probably the shepherd invaders, noosed a single rope in a slip-knot, round the lower jaw, forming an imperfect bridle, with only one rein; a practice still in vogue among the Bedouins. Thus cavalry were but little formidable compared with chariots, until a complete command over the horse was obtained by the discovery of a true bridle. This seems to have been first introduced by chariot-drivers, and there are figures of well-constructed harness, reins, and mouth-pieces, in very early Egyptian monuments, representing both native and foreign chariots of war. These differed little from each other, both consisting of a light pole, suspended between and on the withers of a pair of horses, the after end resting on a light axle-tree, with two low wheels. Upon the axle

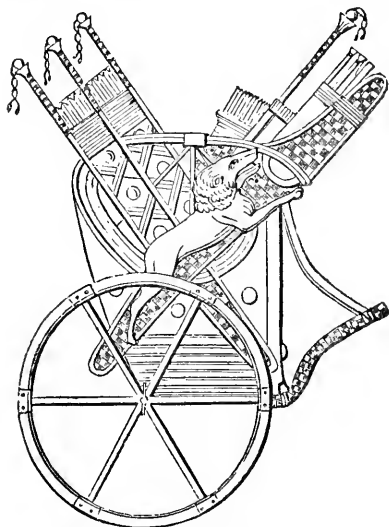

222. [Egyptian War Chariot.]

stood a light frame, open behind and floored for the warrior and his charioteer, who both stood within: on the sides of the frame hung the war-bow, in its case; a large quiver with arrows, and darts had commonly a particular sheath. In Persia, the chariots, elevated upon wheels of considerable diameter, had four horses abreast; and, in early ages, there were occasionally hooks or scythes attached to the axles. In fighting from chariots great dexterity was shown by the warrior, not only in handling his weapons, but also in stepping out upon the pole to the horses' shoulders, in order the better to attain his enemies, and the charioteer was an important person, sometimes equal in rank to the warrior himself. Both the kingdoms of Judah and Israel had war-chariots, and, from the case of king Josiah at the battle of Megiddo, it is clear they had also travelling-vehicles, for being wounded he quitted his fighting-chariot, and in a second, evidently more commodious, he was brought to Jerusalem (2 Chron. xxxv. 24). Chariots of war continued to be used in Syria

in the time of the Maccabees (2 Mac. xiii. 5), and in Britain when Cæsar invaded the island;

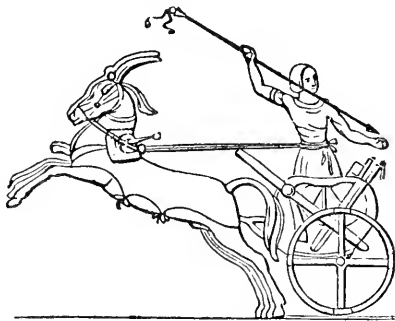

223. [Egyptian War Chariot.]

but it would lead us beyond our proper limits if we were to expatiate on the Biga and Quadriga, the Bessedum, Rheda, and Covinus of the ancients. The subject belongs more properly to a dictionary of classical antiquities.—C. H. S.

CHARITY. The Greek word *ἀγάπη*, frequently thus rendered in the Authorized Version of the New Testament (e. g. 1 Cor. xiii. throughout), is that which is more usually translated 'love' in the same version (e. g. John xv. throughout). The translation of the word by 'love' is the more proper, seeing that 'charity' has acquired a signification in our language which limits it to overt acts of beneficence. *Ἀγάπη* denotes that kindly state of mind or feeling which renders a person full of such goodwill or affectionate regard towards others as is always ready to evince itself in word or action. In short, it describes that state of feeling which the apostle enjoined the Romans (xii. 10) to entertain: 'Be ye kindly affectioned one to another.' This extended meaning of the word explains the pre-eminence which the apostle assigns to the virtue which it implies over every other Christian grace (1 Cor. xiii.).

CHARMING OF SERPENTS. [ADDER.]

CHARTUMMIM (חַרְטֻמִּים; Sept. *ἐπαιδοί, φαρμακοί*). This is the title rendered 'magicians' in our version, applied to the 'wise men' of Egypt (Gen. xli. 8, 22; Exod. vii. 11; viii. 7, 18, 19; ix. 11), and of Babylon (Dan. i. 20; ii. 2). The word 'magicians' is not in either case properly applied, as the magi belonged to Persia, rather than to Babylon or Egypt; and should be altogether avoided in such application, seeing that it has acquired a sense different from that which it once bore. The Hebrew word properly denotes 'wise men,' as they called themselves and were called by others; but, as we should call them, 'men eminent in learning and science,' their exclusive possession of which in their several countries enabled them occasionally to produce effects which were accounted supernatural by the people. Pythagoras, who was acquainted with Egypt and the East, and who was not unaware of the unfathomable depths of ignorance which lie under the highest attainable conditions of human knowledge, thought the modest title of philosopher (*φιλόσοφος*), 'lover of wisdom,' more becoming, and accordingly he brought it into use; but that of 'wise men' still retained its hold in the East.

Gesenius concludes that the Egyptian *Chartumwin* were those of the Egyptian priests who had charge of the sacred records. His etymological reasons may be seen in his Thesaurus. There can be little doubt that they belonged to some branch of the priesthood, seeing that the more recondite departments of learning and science were cultivated exclusively in that powerful caste.

CHARUL (חרול) occurs in three places in Scripture, and in them all is translated 'nettles' in the Auth. Version. Thus in Prov. xxiv. 30, 31, it is written, 'I went by the field of the slothful, &c., and, lo, it was all grown over with thorns, and nettles (*charullim*) had covered the face thereof.' So in Job xxx. 7 it is stated that he was insulted by the children of those whom he would formerly have disdained to employ, and who were so abject and destitute that 'among the bushes they brayed; under the nettles they were gathered together;' and in Zeph. ii. 9, 'Surely Moab shall be as Sodom, and the children of Ammon as Gomorrah, even the breeding of nettles, and salt-pits, and a perpetual desolation.' Considerable difficulty has been experienced in determining the plant which is alluded to in the above passages, which, as Celsius says, 'sacris scriptoribus parcius memorata, et notis paucissimis descripta, ac distincta.' The majority of translators and commentators have thought that some thorny or prickly plant, or a nettle, is intended by the charul, on account of the other plants which are mentioned along with it. Hence brambles, the wild plum, and thistles, have been severally selected; but nettles have had the greatest number of supporters. Celsius however prefers the *Zizyphus Paliurus*, or the plant which has been called Christ's thorn, as that best suited to the several contexts.

Of all these determinations, however, it must be observed that they amount to nothing more than conjectures, because, as Rosenmüller says, the cognate languages have not this word, and also because 'the Greek translators of Alexandria in the first and last of these three places (the only places in which the Hebrew word occurs) entirely deviate from our present Hebrew text; but in the passage of Job they translate *charul* by *wild shrubs*.' To us it does not appear, from the import of the above passages, that a thorny plant is necessarily meant by the term under review. All that is implied is that neglected fields, that is, fields in cultivation which are neglected, will become covered with weeds, and that these should be of a kind such as idlers, as in the passage of Job, might take shelter under, or lie down among. This passage, indeed, seems to preclude any thorny plant or nettle, as no one would voluntarily resort to such a situation; and one of the commentators, as quoted by Celsius (ii. p. 163), appears to have been of the same opinion: 'Bar Bahlul apud Castellum pisa vel cicerculas explicat: that is, he considers *pease*, or rather vetches, to be intended. Moreover, it is worthy of remark, that there is a word in a cognate language, the Arabic, which is not very dissimilar from *charul* or *kharul*, and which is applied to plants apparently quite suitable to all the above passages. The word خردل

kharul is applied in all old Arabic works, as well as at the present day, to different species of mustard, and also to plants which are employed

for the same purposes as mustard (as we hope to be able to show in the article *SINAPI*), and it is not very unlike the *kharul* or *charul* of Scripture. In fact, they do not differ more than many words which are considered to have been originally the same. Some of the wild kinds of mustard are well known to spring up in corn fields, and to be the most troublesome of all the weeds with which the husbandman has to deal: one of these, indeed, *sinapis arvensis*, is well known to be, and is specially mentioned by a modern botanical author, Sir James Smith, as abundant in corn-fields, where it is a very troublesome weed, and also in waste ground, when newly disturbed. So also, as old a writer as Gerarde, in his *Herbal*, says, 'There be three sorts of wild turneps; one our common rape, which beareth the seed whereof is made rape-oil, and feedieth singing birds: the other, the common enemy to come, which we call charlock.' He likewise mentions that this is also called *carlock*, *chadlock* and *kedlock*, words which it is curious to observe for their resemblance to *kharul*, *kharul*, or *charul*, and which are applied in our country to this wild kind of mustard, as *kharul* is to the species of mustard indigenous in different parts of Asia. That some of these are found in Syria and Palestine is well known, as Russel mentions the above *sinapis arvensis*, or charlock, as common in the neighbourhood of Aleppo, and, in fact, it is one of the most widely diffused of the species. Decandolle, in his *Syst. Natural.* ii. p. 615, describes it as 'Habitat arvis, vineis, agris Europæ interdum nimis copiosa, a Lusitania ad Petropoliim, a Sicilia ad Daniam, ab Anglia ad Taurium.'



224. [*Sinapis Orientalis.*]

Irby and Mangles moreover state, that in their journey from Bysan to Adjeloum they met with the mustard plant growing wild, and as high as their horses' heads. In fact, so large do some of the species grow in these countries, that one of them

has been supposed to be the mustard tree alluded to by our Saviour. *S. arvensis* being so widely diffused is probably also found in Palestine, though this can only be determined by a good botanist on the spot, or by a comparison of genuine specimens. But there is another species, the *S. orientalis*, which is common in corn-fields in Syria, and south and middle Europe, and which can scarcely be distinguished from *S. arvensis*. Either of these will suit the above passages, and as the name is not very dissimilar, we are of opinion that it is better entitled to be the *charul* of Scripture than any other plant that has hitherto been adduced. It would be the first to spring up in a carelessly cultivated field, and choke the neglected corn, while it would soon cover deserted fields, and might readily be resorted to for shelter from a hot wind, or even from the rays of the sun, when growing so large as is described by some of the travellers in the Holy Land.—J. F. R.

CHASE. [HUNTING.]

CHASIL (חֲסִיל; Sept. βροῦχος; Vulg. *bruchus*; Eng. Vers. *caterpillar*) occurs in Hebrew, 1 Kings viii. 37; 2 Chron. vi. 28; Ps. lxxviii. 46; Isa. xxxiii. 4; Joel i. 4; ii. 25.

In the Sept. Lev. xi. 22; 3 Kings viii. 37; 2 Chron. vi. 28; Ps. civ. 31; Joel i. 4; ii. 25; Amos vii. 1; Nahum iii. 15, 16.

In the Vulg. Lev. xi. 22; 2 Chron. vi. 28; Ps. civ. 31; Isa. xxxiii. 4; Jer. li. 14; Joel i. 4; Nahum iii. 15, 16.

In the Auth. Vers. 1 Kings viii. 37; 2 Chron. vi. 28; Ps. lxxviii. 46; cv. 31; Isa. xxxiii. 4; Jer. li. 14, 27; Joel i. 4; ii. 25.

The English word *caterpillar* belongs strictly to the larvæ of the genus *lepidoptera*, and more especially to the larvæ of a section of it, the *Papilionidæ*. It is, however, far from provable that the חֲסִיל is any species of caterpillar. The root חָסַל, from which it is derived, signifies to 'consume' or 'devour,' and it is especially used to denote the ravages of the locust (Deut. xxviii. 38, הַחֲסִילֵנוּ הָאֲרָבָה). The Arabic and Syriac cognates also signify to consume. The word βροῦχος, by which it is frequently rendered in the Septuagint, from βρώσκω, I eat up, conveys also the idea of ravenousness. All these names indicate a creature whose chief characteristic is voracity, and which also attaches to all the species of locusts. The ancients, indeed, concur in referring the word to the locust tribe of insects, but are not agreed whether it signifies any particular species of locust, or is the name for any of those states or transformations through which the locust passes from the egg to the perfect insect. The Latin Fathers take it to mean the larva of the locust, and the Greek understand it as the name of an adult locust. The Latins give the name *bruchus* to the young locust before it has wings, call it *attelabus* when it begins to fly, and *locusta* when it is fully able to fly. Thus Jerome, in his *Comm. on Nahum*, c. iii. 'Bruchus nihil aliud faciat, nisi semper in terra sit, et absque alis cibo et ventri serviat; attelabus autem saltem modicas assumat alas, et cum in altum volare non possit, tamen de terra exsilire notatur, et tandem perveniens in locustam volitat.' And again, 'Attelabus quem significantius commensorem interpretatus est Aquila, parva locusta est, inter locustam et bruchum, et modicis pennis

reptans, potius quam volans semperque subsilienta. Augustine also, on Ps. civ. says 'Bruchus est locustæ factus; una plaga est locustæ et bruchi, quoniam altera est parens, et alter est factus.' The same opinion is maintained by Gregorius 'in Jobum lib. xxxiii. c. 17.' These statements of Jerome, and the other Latins, are very remarkable, since the Vulgate, in Nahum iii. 16, reads Bruchus expansus est et avolavit, and flies away; and the Septuagint, also, in the same place, reads βροῦχος ὤρησε καὶ ἐξεπετάσθη, and what is still more remarkable, Jerome himself, Lev. xi. 22, puts the bruchus among the volucres. It is curious to see the Greek fathers ascribing wings and the power of flight to the bruchus, in their comments on the same passages. Thus Cyril upon Nahum iii.: Φασὶ γὰρ, ὅτι, πιπτοῦσης χαλάξης, καὶ δειπῶν καταρηγγυμένον ἀδρανῆς εἰς πῆσιν ὁ βροῦχος, καταδεδυμένον αὐτῶ τῶν πτέρων. And Theodoret upon the same passage: τῆς ἡλιακῆς προσβαλλούσης ἀκτύως ἀνίσταται καὶ πετανύσει τὰ πτερά, καὶ εἰς ἕτερον μεταβαίνει τόπον. The same writer on Amos vii. 1 plainly distinguishes the bruchus from the young of the locust. Ἐπιγονήν γε ἀκρίδων, he observes, ἐκάλησε τὸν Ἀσσύριον, βροῦχον δὲ τὸν Βαβυλωνίον. The Septuagint also in Lev. xi. 22, seems to distinguish the bruchus and its τὰ θύμια, 'and its kind,' from the ἀκρις, or common locust, and its τὰ θύμια as differing not in age but in species. Theophrastus also, Περὶ τῶν ἀθρόων φαινόμενων ζῴων says, χαλεπαὶ μὲν οὖν αἱ ἀκρίδες, χαλεπότεροι δὲ οἱ ἀπτελέβοι, καὶ τοῦτων μάλιστα οὓς καλοῦσι βροῦχους (βροῦχος). The testimony of Hesychius is very clear: Βροῦκος ἀκρίδων εἶδος Ἴωνες. Κύπριοι δὲ τὴν χλωρὰν ἀκρίδα, βροῦκαν. Ταραντίνοι δὲ, Ἀτελέβον, ἕτεροι, Ἀρουραῖαν μάντιν. The inconsistency of Jerome's statements, and the contrariety both of his notions on the subject and of the other Latins to those of the Greeks, may be owing to the circumstance that in his time the use of the words in question might have become arbitrary, or loose and uncertain. Even Pliny calls the attelabi, minimæ locustarum sine pennis (*Nat. Hist.* xxix. 4, 26). Thus Jerome translates חֲסִיל, in 1 Kings viii. 37, by rubigo; nor does the Septuagint observe strict uniformity; for, in Ps. lxxviii. 46, it has ἐρυσίβη and in Is. xxxiii. 4, ἀκρίδες.

The superior antiquity however of the Septuagint entitles its opinion to preference, and, in the passages already quoted, it ascribes flight to the βροῦχος, and speaks of it as a distinct species; and in the former particular especially, it is difficult to suspect it of an egregious error. The statement of Aristotle is also worthy of notice, who speaks of the attelabos as a mature insect, for he refers to its parturition and eggs (*Hist. An.* v. 29).

The arguments and speculations of the most eminent modern writers may be seen in Bochart, *Hierozo.*; Rosenmüller, vol. iii. p. 256, sqq. Lips. 1793-6. Upon those arguments and speculations, the learned editor gives an opinion, which appears to us the best that can be formed; it is this, that the Hebrew word does mean a locust, but of what species it is impossible to determine. One of his observations we cannot forbear to quote, namely, that in Ps. lxxviii. 46, the חֲסִיל is parallel to הָאֲרָבָה, the most certain name, for the locust; and that in Isa. xxxiii. 4, the חֲסִילִים answer to the

נְחִי in the other member of the sentence, a collocation which seems plainly to intimate different species.—J. F. D.

CHASMIL (חֲשָׁמִיל, Ezek. i. 4, 27; viii. 2) was probably a composition of several sorts of metal, since even *ἤλεκτρον*, by which the word is rendered by the ancients, frequently signifies a composition of gold and silver (Plin. *Hist. Nat.* xxxiii. 23; ix. 65). Nor were the ancients unacquainted with the art of amalgamating various species of metal; and the Latin *aurichalcum*, at least according to the derivation of Isidorus (*Orig.* xvi. 19; 'Aurichalcum dicitur, quod et splendorem auri et duritiam eris possideat'), would thus coincide with Bochart's etymology (*Hieroz.* iii. p. 893) of חֲשָׁמִיל; for he thinks the word composed of נחש *ææs*, and מלל *aurum*, and proposes to read חֲשָׁמִיל, instead of חֲשָׁמִיל. Neither can there be any doubt that aurichalcum is a mere Latinized form of the Greek *ἀρείχαλκος* (Homer, *Hymn.* v. 9; Hes. *Scut.* 122; Callim. *In lav. Pallad.* 19). According to Serv. (*ad En.* xii. 87), the aurichalcum possessed the *brightness of gold* and the *hardness of copper*, and might not improbably have been our present *platina*, which has been re-discovered in the Ural mountains, after having long been known as an American fossil. Pliny (*Hist. Nat.* xxxiv. 1) says of aurichalcum, 'Nec reperitur longo iam tempore, effeta tellure.' Perhaps by the Hebrew נְחִישֵׁת מְצִהָב (Ezek. viii. 27) was meant *aurichalcum*; at least the derivation of the words tallies with the properties of that metal.—E. M.

CHATZIR (חֲצִיר), or CHAZIR, also CHAJIR. This word occurs in several places in the Old Testament, where it is variously translated, as *grass*, in 1 Kings xviii. 5, 2 Kings xix. 26, Job xl. 15, Ps. xxxvii. 2, &c.; *herb* in Job viii. 12; *hay*, in Prov. xxvii. 25, and Isa. xv. 6; and *cowsl*, in Isa. xxxiv. 13; but in Num. xi. 5, it is translated *leeks*. Hebrew scholars state that the word signifies 'greens' or 'grass' in general; and it is no doubt clear, from the context of most of the above passages, that this must be its meaning. There is therefore no reason why it should not be so translated in all the passages where it occurs, except in the last. It is evidently incorrect to translate it *hay*, as in the above passages of Proverbs and Isaiah, because the people of Eastern countries, as it has been observed, do not make hay. The author of *Fragments*, in continuation of Calmet, has justly remarked on the incorrectness of our version, 'The *hay* appeareth, and the tender *grass* showeth itself, and the *herbs* of the mountains are gathered' (Prov. xxvii. 25):—'Now certainly,' says he, 'if the *tender grass* is but just beginning to show itself, the *hay*, which is grass cut and dried after it has arrived at maturity, ought by no means to be associated with it; still less ought it to be placed before it.' The author continues, 'The word, I apprehend, means the first shoots, the rising, just budding spires of grass.' So in Isa. xv. 6.

In the passage of Num. xi. 5, where the Israelites in the desert long for 'the melons, and the *leeks*, and the onions, and the garlic' of Egypt, it is evident that it was not *grass* which they desired for food, but some green, perhaps grass-like vegetable, for which the word *chatzir* is used, and which is above translated *leeks*. In the same

way that, in this country, the word *greens* is applied to a variety of cabbage, in India *subzee*, from *subz* 'green' is used as a general term for herbs cooked as kitchen vegetables. It is more than

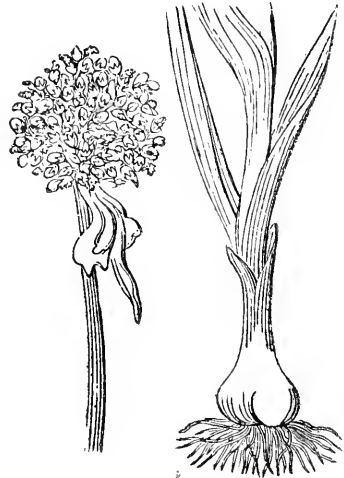

probable, therefore, that *chatzir* is here similarly employed, though this does not prove that *leeks* are intended. Ludolphus, as quoted by Celsius (*Hierobot.* ii. 264), supposes that it may mean lettuce, or salads in general, and others that the succory or endive may be the true plant. But Rosenmüller states, 'The most ancient Greek and the Chaldee translators unanimously interpret the Hebrew by the Greek *πράσσα*, or leeks.' The name moreover seems to have been specially applied to leeks from the resemblance of their leaves to grass, and from their being conspicuous for their green colour. This is evident from minerals even having been named from *πράσσον* on account of their colour, as *prasium*, *prasites*, and *chrysprasium*. The

Arabs use the word كرات *kooras*, or *koorath*, as the translation of the *πράσσον* of the Greeks, and with them it signifies the leek, both at the present day and in their older works. It is curious that of the different kinds described, one is called *kooras-al-bukl*, or leek used as a vegetable. That the leek is esteemed in Egypt we have the testimony of Hasselquist, who says, 'that the kind called *karrat* by the Arabs must certainly have been one of those desired by the children of Israel; as it has been cultivated and esteemed from the earliest times to the present time in Egypt.' So the Roman satirist—

'Porrum et cepe nefas violare et frangere morsu.

O sanctas gentes, quibus hæc nascuntur in hortis

Numina!'

The Romans employed it much as a seasoning to their dishes, as is evident from the number of recipes in Apicius referred to by Celsius. The leek (*Allium Porrum*) was introduced into this country about the year 1562, and, as is well known, continues to be esteemed as a seasoning to soups and stews.—J. F. R.

CHEBAR (כֶּבֶר; Sept. *Xoβάρ*), a river of Mesopotamia, upon the banks of which king Nebuchadnezzar planted a colony of Jews, among whom was the prophet Ezekiel (2 Kings xxiv. 15; Ezek. i. 1, 3; iii. 15, 23; x. 15, 22). This is without doubt the same river that was known among the Greeks as the Chaboras, and which now bears the name of Khabour. It flows to the Euphrates through Mesopotamia, and is the only considerable stream which enters that river. It is formed by the junction of a number of small brooks, which rise in the neighbourhood of a ruined town called Ras-el-Ain, 13 furlongs south-west of Merdin. It takes a southerly direction till it receives the waters of another stream equal to itself, when it bends westward to the Euphrates, which it enters at Kerkesia, the Carchemish of Scripture. [CARCHEMISH.] (Rosenmüller, *Bib. Geog.* ii. 180; Kinnier, *Geog. Mem. of the Persian Empire*, p. 211.)

CHEDEK. [THORNS.]

CHEDORLAOMER, King of Elam, and leader of the five kings who invaded Canaan in the time of Abraham (Gen. xiv). [ABRAHAM; ASSYRIA; ELAM.]

CHEESE. The most important passage in which this preparation from milk is mentioned in Scripture is that where Job, figuratively describing the formation of the fetus in the womb, says—

‘Hast thou not poured me out like milk,
And curdled (condensed, solidified) me like
cheese?’ (x. 10).

We know not how our Biblical illustrators have deduced from this that the cheese used in the East necessarily was in a semi-fluid state. It rather alludes to that progressive solidification which is common to all cheese, which is always soft when new, though it hardens when it becomes old. But for the tendency to seek remote and recondite explanations of plain things, it must seem perfectly obvious that to ‘curdle like cheese’ does not mean that curdled milk *was* cheese; but that milk was curdled to form eventually the hardened cheese. If the text proves anything as to the condition of cheese, it would rather show that, when considered fit for use, it was hard, than that it was soft or fluid; the process of solidification being the subject of allusion, of which curdling the milk is, in the case of cheese, only the first though the most essential operation. Undoubtedly the Orientals do eat curds, or curdled milk; but that therefore their cheese consists of curdled milk is not the correct inference. We also eat curds, but do not regard curds as cheese—neither do they. The other passages describe ‘cheese’ in the plural, as parts of military provision, for which the most solid and compact substances are always preferred. Persons on a march would not like to encumber themselves with curdled milk (2 Sam. xvii. 29).

There is much reason to conclude that the cheese used by the Jews differed in no respect from that still common in the East; which is usually exhibited in small cakes about the size of a tea saucer, white in colour, and excessively salt. It has no rind, and soon becomes excessively hard and dry—being, indeed, not made for long keeping. It is best when new and comparatively soft; and, in this state, large quantities are consumed in lumps or crumbs not made up into cakes. All

cheese in the East is of very indifferent quality; and it is within the writer’s own knowledge that the natives infinitely prefer English or Dutch cheese when they can obtain it. In making cheese, the common rennet is either butter-milk or a decoction of the great-headed thistle, or wild artichoke. The curds are afterwards put into small baskets made of rushes or palm leaves, which are then tied up close, and the necessary pressure applied.

There are several decisions in the Mishnah relative to the pressure by which cheese was made (*Cholim*, viii. 2). This proves that, as observed before, no preparation of milk was regarded as cheese while in a fluid state, or before being subjected to pressure. In another place (*Avoda Sara*, ii. 5) it is decided that cheese made by foreigners could not be eaten, from the fear that it might possibly be derived from the milk of some animal which had been offered in sacrifice to idols.

CH₂LBENAH (חֶלְבֵנָה) is mentioned in Exod. xxx. 34, as one of the substances from which the incense for the sanctuary was to be prepared: ‘Take unto thee sweet spices, stacte and onycha and (*chelbenah*) galbanum.’ The Hebrew word is very similar to the Greek *χαλβάνη*, which occurs as early as the time of Hippocrates. The substance is more particularly described by Dioscorides, who gives *μετώπιον* as an additional name, and states that it is an exudation produced by a ferula in Syria. So Pliny (xii. 25), as translated by Holland, ‘Moreover we have from Syria out of the same mountain, Amanus, another kind of gum, called galbanum, issuing out of an herb-like fennel-geant, which some call by the name of the said resin, others stagonotis. The best galbanum, and which is most set by, is grisly and clear, withal resembling hammoniacum.’ Theophrastus had long previously (*Hist. Pl.* ix. 7) said that galbanum flows from a Panax of Syria. In both cases it is satisfactory to find a plant of the same natural family of Umbelliferae pointed out as yielding this drug, because the plant has not yet been clearly ascertained. The Arabs, however, seem to have been acquainted with it, as they give its names. Thus, ‘galbanum’ in Persian works has *barzu* assigned to it as the Arabic, *bireeja* as the Hindoostanee, with *khulyan* and *metonion* as the Greek names (evident corruptions of *χαλβάνη* and *μετώπιον*, arising from errors in the reading of the diacritical points): *Kinneh* and *nafel* are stated to be names of the plant, which is described as being jointed, thorny, and fragrant (Royle, *Illustr. Himal. Bot.* p. 23). Lobel made an attempt to ascertain the plant by sowing some seeds which he found attached to the gum of commerce: ‘Oritur in hortis nostris hæc pervenusta planta semine copioso, lato, foliaceo, aromatico, reperto Antwerpiaë in *galbani lachryme*’ (*Obs.* p. 431). The plant which was thus obtained is the Ferula ferulago of Linnaeus, a native of N. Africa, Crete, and Asia Minor. It has been objected, however, that it does not yield galbanum in any of these situations; but the same objection might be made, though erroneously, to the mastich-tree, as not yielding mastich, because it does not do so except in a soil and climate suitable to it. Other plants, as the Bubon galbanum and gummiferum, have, in consequence, been selected, but with less claim,

as they are natives of the Cape of Good Hope. The late Professor Don, having found some seeds of an umbelliferous plant sticking to the galbanum of commerce, has named the plant, though yet unknown, Galbanum officinale. These seeds, however, may or may not have belonged to the galbanum plant. Dr. Lindley has suggested another plant, which he has named *Opoidia galbani fera*, and which grows in Khorassan, in Durrood, whence specimens were sent to this country by Sir John M'Niell, as yielding an inferior sort of ammoniacum. Upon the whole, it is evident that the plant is yet to be ascertained. Galbanum is in the present day imported into this country, both from the Levant and from India. That from the latter country is exported from Bombay, having been first imported thither, probably from the Persian Gulf. It is therefore probable that it may be produced in the countries at the head of that gulf, that is, in the northern parts of Arabia or in Persia, (portions of which, as is well known, were included in the Syria of the ancients;) perhaps in Kurdistan, which nearly corresponds with ancient Assyria. The later Greeks, finding the country to the north of Palestine subject to the Assyrians, called the country Assyria, or by contraction *Syria*. It is on this account that in classical writers the names Assyria and Syria are so often found interchanged (*l. c. p. 244*).

Galbanum, then, is either a natural exudation, or obtained by incisions from some umbelliferous plant. It occurs in commerce in the form either of tears or masses, commonly called *lump-galbanum*. The latter is of the consistence of wax, tenacious, of a brownish, or brownish yellow colour, with white spots in the interior, which are the agglutinated tears. Its odour is strong and balsamic, but disagreeable, and its taste warm and bitter. It is composed of 66 per cent. of resin, and 6 of volatile oil, with gum, &c., and impurities. It was formerly held in high esteem as a stimulant and anti-spasmodic medicine, and is still employed as such, and for external application to discuss indolent tumours. A French author enumerates various pharmacæutic preparations of which it formerly constituted an ingredient, as 'le Mithridate, l'orvietan, le dioscoridium de Fracasta, l'onguent des Apôtres ou dedacapharmaque d'Avicenna, &c., les emplâtres divins de Jacques Lemort, manus Dei magnetique d'Ange Sola,' &c. It is still more to our purpose that we learn from Dioscorides that, in preparing a fragrant ointment, galbanum was mixed with other aromatic substances; as under *Μερόπιον* he says, in the Latin translation of Sprengel, 'Paratur et in Ægypto unguentum, vernaculo nomine Metopium dictum, scilicet propter galbano permistiouem. Lignum enim e quo galbanum manat, metopium vocatur. Ex oleo omphacino et amygdalarum amararum, cardamomo, scheno, calamo, melle, vino, myrrha, balsami semine, galbano et resina componitur.' Hence we see that it was the practice of the ancients to mix galbanum with the most fragrant substances with which they were acquainted. The effect of such mixture must depend upon the proportion in which it or any other strong-smelling substance is intermixed, more than upon what is its peculiar odour when in a concentrated state. We need not, therefore, inquire into the reasons which have

been assigned to account for galbanum being intermixed with stacte and onycha as sweet spices. We see that the same practice existed among the Greeks and the Egyptians.—J. F. R.

CHEMOSH (שִׁמְשִׁי; Sept. *Χαμὸς*) is the name of a national god of the Moabites (1 Kings xi. 7; 2 Kings xxiii. 13; Jer. xlviii. 7; who are for this reason called the 'people of Chemosh,' in Num. xxi. 29), and of the Ammonites (Judg. xi. 24), whose worship was introduced among the Israelites by Solomon (1 Kings xi. 7). No etymology of the name which has been proposed, and no attempt which has been made to identify this god with others whose attributes are better known, are sufficiently plausible to deserve particular notice. Jerome's notion that Chemosh is the same as Baal Peor has no historical foundation; and the only theory which rests on any probability is that which assumes a resemblance between Chemosh and Arabian idolatry (cf. Beyer, *Addit. ad Selden. p. 322*; Pocock, *Specimen*, p. 307). Jewish tradition affirms that he was worshipped under the symbol of a black star; and Maimonides states that his worshippers went bare-headed, and abstained from the use of garments sewn together by the needle. The black star, the connection with Arabian idolatry, and the fact that Chemosh is coupled with Moloch, favour the theory that he had some analogy with the planet Saturn.—J. N.

CHENANIAH (חֲנַיָּה, *God's goodness*; Sept. *Χαρεία*), a master of the temple music, who conducted the grand musical services when the ark was removed from the house of Obed-edom to Jerusalem (1 Chron. xv. 22).

CHERETHITES and **PELETHITES** (כִּרְתִּי וּפְלִתִי, *Crethi and Plethi* without the final ם in the plural; Sept. *Χερεθῖ καὶ Φελεθῖ*), names borne by the royal life-guards in the time of David (2 Sam. viii. 18; 1 Chron. xviii. 17). Prevailing opinion translates their names, 'Headsmen and Foot-runners.' The word כִּרְתִּים is used for *woodcutters*, 2 Chron. ii. 10, and it might seem probable that the Cherethites, like the lictors of the Roman dictator, carried axes, both as a badge of office and for prompt use. In the later years of David, their captain, Benaiah, rose to a more commanding importance than the generals of the regular troops; just as in imperial Rome the præfect of the prætorian guards became the second person in the empire. It is evident that, to perpetrate any summary deed, Benaiah and the guards were chiefly relied on. That they were strictly a body-guard is distinctly stated in 2 Sam. xxiii. 23. The grammatical form of the Hebrew words is nevertheless not quite clear; and as the Cherethites are named as a nation of the south (1 Sam. xxx. 14), some are disposed to believe Crethi and Plethi to be foreign Gentile names used collectively. No small confirmation of this may be drawn from 2 Sam. xv. 18: 'All the Cherethites and all the Pelethites and all the Gittites, six hundred men,' &c. If the two first words were grammatical plurals, like the third (Gittites), it is scarcely credible that final ם should be added to the third, and not also to the other two. As the word *all* is repeated three times, and 600 men is the number intended the third time, the Cherethites and Pelethites must have been reckoned by the hundred; and since the Gittites were clearly foreigners, all

the à priori improbability which some have seen in David's defending himself by a *foreign* guard falls to the ground. His Gittite satellites are one more proof of the intensity of the tyrannical principle already come in; since equally among the Greeks and Romans, and in modern Europe, for a prince to trust the care of his person to foreign guards has ever been looked on as the most evident mark that he is keeping down his own subjects by force.

That in 2 Sam. xv. 1, Absalom's runners are called by the name רצים, which they also afterwards bear, may perhaps go to prove that Plethi or Pelethites does *not* mean 'runners.' Indeed, as such a meaning of the word cannot be got out of pure Hebrew, but recourse to the Arabic language is needed, the probability would in any case be, that the institution, as well as the name, was imported by David from the south. Ewald believes that *Plethi* means *Philistines*, and that it has been slightly corrupted to rhyme with *Crethi*. May not *Plethi* have been from another dialect? Be this as it may, these body-guards for the prince are not found under the reign of Saul.—

F. W. N.

CHERITH (כֶּרִית; Sept. Χορράθ), a river in Palestine, on the banks of which the prophet Elijah found refuge (1 Kings xvii. 3-7). Eusebius and others have conceived themselves bound by the words על פני הירדן, rendered 'east of the Jordan', to seek the river in the Trans-Jordanic country: but although the words sometimes require this translation (as in Gen. xxv. 18; Josh. xv. 18), they may also be rendered 'towards,' or 'before the Jordan' (comp. Gen. xvi. 22)—that is, in coming from Samaria. And this interpretation, which places the Cherith west of the Jordan, agrees with the history, with Josephus (*Antiq.* viii. 13, 7), and with the local traditions which have uniformly placed the river of Elijah on this side the Jordan. Dr. Robinson drops a suggestion that it may be the Wady Kelt, which is formed by the union of many streams in the mountains west of Jericho, issuing from a deep gorge, in which it passes by that village and then across the plain to the Jordan. It is dry in summer.

CHERUBIM (Cherub, pl. Cherubim) is the name of certain symbolical figures frequently mentioned in Scripture. Hebrew nouns of the masculine gender generally end in *im*, and our translators, in adopting this form into their version in preference to the English cherubs, have in several places improperly added the letter *s* to the termination of the word—a grammatical error, supposed by some to have originated in the circumstance of the writers of the preceding age employing in the vulgar Latin, then in use, the term *cherubini*, instead of *cherubi*. Parkhurst and other learned Hutchinsonians derive the word כֶּרֶב from כ, a particle of similitude, and רב, 'great' or 'powerful'—so as, according to the theory of their school, to constitute the cherubic figures emblems of the Almighty. Archbishop Newcome and others trace its origin to a Chaldee root כֶּרֶב, signifying 'to plough,' and hence, this operation being in ancient times and in Eastern countries the work of oxen, cherub is sometimes used in Scripture to denote that animal—as in Ezekiel (i. 10), where the face of a cherub is synonymous with that of an ox.

A third class of etymologists, considering that God is frequently described as riding on the cherubim as his chariot, propose by a transposition of the letters to deduce it from רכב, the Arabic word signifying 'to ride'; while another derivation, on the same principle of transposition, has lately been suggested by Dr. Kirby, who thinks that בֵּרַךְ, 'to bless' or 'curse,' is more likely to be the genuine root of the term. Without deciding to which of these etymological conjectures the preference is due, as they are all founded on the views which their respective authors have adopted of the character and design of those remarkable images, it may be observed in general, that they all involve the leading idea that the cherubim were symbols, either directly emblematic of Deity, or significant of the ruling powers by which the agency of God is carried on in the natural and moral world.

Figures of the cherubim were conspicuous implements in the Levitical tabernacle. Two of them were placed at each end of the mercy-seat, standing in a stooping attitude, as if looking down towards it, while they overshadowed it with their expanded wings—and, indeed, they were component parts of it, formed out of the same mass of pure gold as the mercy-seat itself (Exod. xxv. 19).

These figures were afterwards transferred to the most holy place in Solomon's temple, and it has been supposed from 1 Chron. xxviii. 19, that that prince constructed two additional ones after the same pattern, and of the same solid and costly material; but whether it was with a view to increase their number in accordance with the more spacious and magnificent edifice to which they were removed, or merely to supply the place of those made by Moses, which in the many vicissitudes that befel the ark might have been mutilated or entirely separated from the mercy-seat to which they were attached—is not ascertained. This much, however, is known, that Solomon erected two of colossal dimensions, in an erect posture with their faces towards the walls (2 Chron. iii. 13), covering with their outstretched wings the entire breadth of the *debir*, or most holy place. These sacred hieroglyphics were profusely embroidered on the tapestry of the tabernacle, on the curtains and the great veil that separated the holy from the most holy place (Exod. xxvi. 1-31), as well as carved in several places (1 Kings viii. 6-8) on the walls, doors, and sacred utensils of the temple. The position occupied by these singular images at each extremity of the mercy-seat—while the Shechinah, or sacred flame that symbolized the divine presence, and the awful name of Jehovah in written characters (Bates, *Critica Hebræa*, p. 288) were in the intervening space—gave rise to the well-known phraseology of the sacred writers, which represents the Deity dwelling between or inhabiting the cherubim; and, in fact, so intimately associated were they with the manifestation of the divine glory, that whether the Lord is described as at rest or in motion, as seated on a throne, or riding in a triumphal chariot, these symbolical figures were essential elements in the description (Numb. vii. 89; Ps. xviii. 10; lxxx. 1; xcix. 1-10; Isa. vi. 2; xxxvii. 16). It may be remarked, on the second last passage, that the clause which our translators have rendered 'above him stood the seraphim,' is in the

Septuagint 'the cherubim stood round about him.'

The prominent place assigned to these cherubic figures in the divinely-appointed place of ancient worship invests them with an interest and importance sufficient to stimulate the curiosity of the Biblical student to inquire both into their form and their design. The difficulties, however, attending the inquiry are neither few nor small. Josephus, a learned Jew of the sacerdotal tribe, declares that they resembled no animals that ever were seen by man, and that their form no man knew in his day (*Antiq.* iii. 6); and several modern Jews of great erudition, among whom is Abenezra, think that the term cherubim was indiscriminately applied to figures 'of any kind that were sculptured on stone, engraved on metal, carved on wood, or inwrought on cloth,' although that writer himself states it to be his opinion—founded apparently on no basis more solid than a conjectural idea of the comparative ease with which the human form admits of bending forward, and, therefore, adopted by the ancient masters in their paintings—that the figures which Moses placed looking down at the mercy-seat were those of winged men or boys. But although the later Jews lost all knowledge of these mystic symbols, and in the Scriptures—the only source whence true information is to be obtained—much obscurity as well as great diversity mark all the passages that contain allusions to the subject, yet sufficient data exist from which, if we cannot surmount all the difficulties that lie in the way of the investigation, we may at least approximate to the truth. Rejecting the opinion of those who maintain that the cherubim were of various shapes, we assume it to be, if not absolutely certain, at least highly probable, that in all the passages of Scripture where they are spoken of their figures were uniform. The first occasion on which they are mentioned is on the expulsion of our first parents from Eden, when the Lord placed cherubim on the east of the garden. The word *כַּרְבַּיִם*, translated 'on the east,' may signify as well 'before or on the edge of;' and the historian does not say that the Lord placed there cherubim, but *הַכַּרְבַּיִם*, the cherubim. Besides, *ישׁ*, rendered by our translators 'placed,' signifies properly 'to place in a tabernacle,' an expression which, viewed in connection with some incidents in the after history of the primeval family (*Gen.* iv. 14-16), seems a conclusive establishment of the opinion that this was a local tabernacle, in which the symbols of the Divine presence were manifested, suitably to the altered circumstances in which man after the Fall came before God, and to the acceptable mode of worship he was taught to observe. That consecrated place, with its striking symbols, called 'the presence of the Lord,' there is reason to believe, continued till the time of the deluge, otherwise there would have been nothing to guard the way to the tree of life; and thus the knowledge of their form, from the longevity of the antediluvians, could have been easily transmitted to the time of Abraham (*Faber, Horæ Mosaicæ*, b. ii. ch. 6). Moreover, it is an approved opinion that, when those emblems were removed at the close of the patriarchal dispensation from the place of public worship, the ancestors of that patriarch formed small models of them for domestic use, under the name of Seraphim, or Teraphim, according to the Chal-

dee dialect (*Faber, Origin of Pag. Idol.* i. 256). The next occasion in the course of the sacred history on which the cherubim are noticed is when Moses was commanded to provide the furniture of the tabernacle; and, although he received instructions to make all things according to the pattern shown him in the Mount, and although it is natural to suppose that he saw a figure of the cherubim, yet we find no minute and special description of them, as is given of everything else, for the direction of the artificers (*Exod.* xxvi. 31). The simple mention which the sacred historian makes, in both these passages, of the cherubim, conveys the impression that the symbolic figures which had been introduced into the Levitical tabernacle were substantially the same with those established in the primeval place of worship on the outskirts of Eden, and that by traditional information, or some other means, their form was so well known, both to Bezaleel and the whole congregation of Israel, as to render superfluous all further description of them. On no other ground can we account for the total silence as to their configuration, unless we embrace the groundless and unworthy opinion of those who impute to the author of the Pentateuch a studied concealment of some parts of his ritual, after the manner of the Mystics (*Landseer, Sabæan Researches*, p. 321). But there was no mystery as to those remarkable figures, for Ezekiel knew at once (*x.* 20) the living creatures which appeared in his vision supporting the throne of God, and bearing it in majesty from place to place, to be cherubim, from having frequently seen them, in common with all other worshippers, in the carved work of the outer sanctuary. Moreover, as is the opinion of many eminent divines, the visionary scene, with which this prophet was favoured, exhibited a transcript of the Temple, which was shown in pattern to David, and afterwards erected by his son and successor; and, as the chief design of that later vision was to inspire the Hebrew exiles in Babylon with the hope of seeing, on their return to Judæa, another temple, more glorious than the one then in ruins, it is reasonable to believe that, as the whole style and apparatus of this mystic temple bore an exact resemblance (*1 Kings* vi. 20) to that of Solomon's magnificent edifice, so the cherubs also that appeared to his fancy portrayed on the walls would be facsimiles of those that belonged to its ancient prototype. Taking then his description of them to be the proper appearance that belonged in common to all his cherubic creatures (*chaps.* i. x. xli.), we are led to conclude that they were compound figures, unlike any living animals or real object in nature; but rather a combination, in one nondescript artificial image, of the distinguishing features and properties of several. The ox, as chief among the tame and useful animals, the lion among the wild ones, the eagle among the feathery tribes, and man, as head over all—were the animals which, or rather parts of which, composed the symbolical figures. Each cherub had four distinct faces on one neck—that of a man in front, that of a lion on the right side, and of an ox on the left; while behind was the face of an eagle. Each had four wings, the two under ones covering the lower extremities (*Heb.* the feet), in token of decency and humility, while the upper ones, spread out on a level with the head and

shoulders, were so joined together, to the edge of his neighbours', as to form a canopy; and in this manner they soared rather than flew, without any vibratory motion with their wings, through the air. Each had straight feet. The Hebrew version renders it 'a straight foot'; and the probability is, that the legs were destitute of any flexible joint at the knee, and so joined together that its locomotions must have been performed in some other way than by the ordinary process of walking, or lifting one foot after another. Dr. Adam Clarke has explained this by referring 'to some ancient Egyptian images of Isis, Osiris, Anubis, &c. in his possession, where the legs were not separated, nor was there any bend at the knees; so that if there was any motion at all, it must have been by gliding, not progressive walking' (*Comment.* in loc.). The ideal picture, then, which Ezekiel's description would lead us to form of the cherub, is that of a winged man, or winged ox, according to the particular phase it exhibited or the particular direction from which it was seen. If viewed in one aspect, it showed conspicuously the face, hands, and body of a man; in another, the broad face, legs, and cloven foot of an ox appeared as the prominent features of the image. And this consideration may serve to reconcile the discrepancies that appear in the accounts which, in different parts of Scripture, are given of the cherubim. Thus, for instance, in certain parts of the lavers of Solomon's Temple were carved, between groups of palm-trees, the faces of lions and oxen, evidently as parts of the cherubim (1 Kings, vii. 29, 36), while no hint is given of the usual accompaniments of the man and the eagle; and in the mystic temple of Ezekiel, the cherubim, which, alternately with a palm-tree, were seen engraven on its walls and doors, exhibited the face of a man and a lion, while no mention is made of either an eagle or an ox, of the human hands, or the ox-like feet of these singular images. The difference in these several descriptions is to be accounted for from the circumstance of the living creatures being beheld by the prophet at one point of observation, and of the artificial ones being engraven, carved, or embroidered on a flat extended surface; and, consequently, one side or a small part only of the figure appeared to the eye of the beholder. To use the words of Dr. Watts, 'That figure which would have had all four faces visible if it had stood forth as a real animal or a statue, could have had but two faces, or at most three, visible when figured on a wall or curtain, the other being hid behind; and thus the cherubs may be in all places of Scripture the same four-faced animals, and yet only two or three of their faces appear, according to their designed situation and the art of perspective (*Remnants of Time*, xx.).

Whether the golden calf constructed by Aaron might be—not the Apis of Egypt—but a representation of the antediluvian Cherubim—as some suppose, from its being made on 'a feast to the Lord,' and called 'the gods of Israel' (Exod. xxxii. 5), and whether Jeroboam, in the erection of his two calves, intended a schismatic imitation of the sacred symbols in the Temple of Jerusalem rather than the introduction of a new species of idolatry (1 Kings xii. 28), we shall not stop to inquire. But, as paganism is a corruption of patriarchal worship—each nation having added something according to its own taste and fancy—

perhaps we may find a confirmation of the views given above of the compound form of the cherubim in the strange figures that are grouped together in the heathen deities. The numerous ox-heads, for instance, in the statue of the ancient Diana, and particularly the Asiatic idols, almost all of which exhibit several heads and arms attached to one person, or the heads of different animals combined, afford a collateral proof, similar to the universal prevalence of sacrifice, that the form of the primitive cherubim has been traditionally preserved and extended over a large portion of the world. See Calmet, *Fragments*; Clarke *On Ezekiel*; and, particularly, Parkhurst, *Heb. Lex.*

[This may indeed be shown by the following actual figures copied from ancient monuments, all of which illustrate some one or more of the notions which we attach to the cherubic forms; and while they afford material assistance to our ideas on the subject, they show that figures of this kind, as sacred symbols, were not peculiar to the Hebrews, and that their presence in the sanctuary was not calculated to excite any surprise among the neighbouring nations, or to lead to the notion that the Jews also were worshippers of idols, for even in the pagan monument they never appear as idols, but as symbols; and it was very possibly this fact—that the cherubic figures were not liable to be misunderstood—which induced the Divine wisdom to permit their introduction into the most holy place. Of all these, the most remarkable is the figure sculptured in bas-relief. The first group (No. 226) is from Egypt. The figures are the more remarkable from being such as appear upon the sacred *arks* of that country, and the disposition of their wings agrees much with one or another of the arrangements which have been ascribed to the cherubim of the Ark [ARK]. As such figures certainly existed in Egypt before the time of Moses, this may suggest another reason in addition to that already given, why a particular description of the cherubim was not judged necessary.

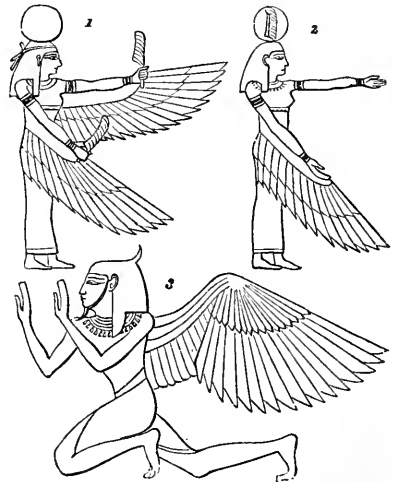

226.

The next group of figures (No. 227) is also Egyptian, and shows the diversity of the winged symbols which so often appear on the monuments.

Figs. 1 and 8 are such hovering winged figures as usually surmount the whole of a sacred tablet or shrine: and to such hovering wings there seem



227.

some symbolical allusions in Scripture even when the cherubim are not mentioned. Figure 4, that of a hawk with the face and symbols of Isis, and the crowned and winged serpents (figs. 6, 7), are



228.

the only compound images, and as such deserve particular attention.

If we proceed to Babylon, similar winged sym-



229.

bols are discovered. The cut (No. 228) is from an antique gem found at Babylon. It combines the human and quadrupedal forms with the wings of a bird, and is not unlike the Egyptian sphinx, excepting that the head is that of a man, not of a woman. The next (No. 229) is from a Babylonian cylinder, and is remarkable as giving not only the wings but the head of a bird to the human form.

In proceeding to the monuments of ancient Persia, the winged symbols become still more striking. The very remarkable example in the annexed engraving is from a bas relief at Mourg Aub (No. 230), representing a man arrayed in a richly embroidered robe, with such quadruple wings as the vision of Ezekiel ascribes to the cherubim, with the addition of ample horns (the well-known symbols of regal power) issuing from the head, and upbearing a symbolical crown or mitre, such as is often seen on the heads of the Egyptian gods and their ministering priests



230.



231.

The next group of figures (No. 231) is collected from different ancient Persian sculptures and gems. Fig. 1 is a hovering winged symbol,

which occurs as frequently in the Persian monuments as the similar figures do in those of Egypt. 1 and 4 are remarkable as offering a near approach to the traditional figure which has been assigned to angels; and 3 affords a very curious example of quadruple wings, resembling those in No. 230, but being much shorter.



232.

The 4th figure in the above cut (232) affords a rare example of the combination of the beast, bird, and man, and seems to be the same as the Babylonian sphinx in a different position. The other figures in the same cut are frequently repeated in the Persian sculptures. They are acknowledged Mithric symbols; and, as such, they go far to evince the purely symbolical character of the cherubic figures. In all of these, except the last, a warrior is represented grasping these winged symbols by the single horn, with which all of them are furnished, with one hand, while he thrusts his second into them with the other. It is observable that these figures, taken together, include all those

which Ezekiel's vision assigns to the Cheruoin—the head of a man, an eagle, a lion, and an ox (fig. 5): but we do not any where find all these combined in a single figure, as appears to have been the case in the visionary cherubim.

It is of some importance to remark, that the winged symbolical figures of this description are far more rare in the remoter East—in India—China, than in Western Asia.]

The opinions concerning the design of the cherubim are as diversified as those relative to their form. All are agreed that they had a symbolical meaning, although it is not easy to ascertain it. The ancients, as well as the fathers, considered that they had both a physical and a metaphysical object: thus, for instance, Philo regarded them as signifying the two hemispheres; and the flaming sword, the motion of the planets; in which opinion he is joined by some moderns, who consider them to have been nothing more than astronomical emblems—the Lion and the Man being equivalent to Leo and Aquarius—the signs of the zodiac (Landseer, *Sab. Resear.* p. 315). Irenæus views them as emblematic of several things, such as the four elements, the four quarters of the globe, the four gospels, the four universal covenants (*Adv. Hæres.* iii. 11). Tertullian supposed that the cherubic figures, particularly the flaming sword, denoted the torrid zone (*Apol.* cap. 47). Justin Martyr imagined that the living creatures of Ezekiel were symbolical of Nebuchadnezzar, the Assyrian monarch, in his distress; when he ate grass like an ox, his hair was like a lion's, and his nails like a bird's claws (*Quest.* xlv.). And Athanasius supposed that they were significant of the visible heavens (*Quest. ad Antioch.* cxxxv.). The opinions of the moderns may be reduced to three systems. Hutchinson and his followers consider the cherubim as emblems of the Trinity, with man incorporated into the divine essence: in proof of

which they remark that *הַרְבֵּי אַתְלֹוֹט* signify either a flaming fiery sword, as the words are rendered by the Septuagint, or rather, a flame of fire and a sword or knife; so that, in this figure, there was exhibited in visible form, to the minds of our first parents, fire—the emblem of divine wrath, as well as an instrument for sacrifice—which, as it enfolded or revolved round itself (*כַּמְתְּלֵקֶחֶת* or as Ezekiel writes *כַּמְתְּלֵקֶחֶת*), can mean nothing else than a picture of the satisfaction to be made by deity itself. But the grand objection to this theory, where it is at all intelligible, is, that not only are the cherubim, in all the places of Scripture where they are introduced, described as distinct from God, and no more than his attendants, but that it represents the divine Being, who is a pure spirit, without parts, passions, or anything material, making a visible picture of himself, when in all ages, from the beginning of time, he has expressly prohibited 'the likeness of anything in heaven above' (see Parkhurst, *Heb. Lexicon*, sub voce). Another system regards the cherubim as symbolical of the chief ruling powers by which God carries on the operations of nature. As the heaven of heavens was typified by the holy of holies in the Levitical tabernacle (Heb. ix. 3-12, 24-28), this system considers that the visible heavens may be typified by the holy place or the outer sanctuary, and accordingly finding, as its supporters imagine they do, the cherubim identified with the aerial firma-

ment and its elements in such passages as the following. 'He rode upon a *cherub*, and did fly, yea, he did fly upon the wings of the *wind*,' where the last hemistich is exegetical of the former (Ps. xviii. 10); 'Who rideth upon the heavens in thy help, and in his excellency upon the sky' (Deut. xxxiii. 26; Ps. lxxviii. 4); 'He maketh the clouds his chariot': he is said to descend in fire (Exod. ix. 18), and between which he dwelt in light (1 Tim. vi. 16); and it was in this very manner he manifested his divine glory in the tabernacle and temple—they interpret the cherubim, on which the Lord is described as riding, to be symbolical of the wind, the clouds, the fire, the light; in short, the heavens, the atmosphere, the great physical powers by which the Creator and preserver of the universe carries on the operations of nature.

A third system considers the cherubim, from their being instituted immediately after the Fall, as having particular reference to the redemption of man, and as symbolical of the great and active rulers or ministers of the church. Those who adopt this theory as the true explanation of their emblematic meaning, are accustomed to refer to the living creatures, or cherubim, mentioned in the Apocalyptic vision (Rev. iv. 6), improperly rendered in our English translation 'beasts' (ζῶα), and which, it is clear, were not angels, but redeemed men connected with the church, and deeply interested in the blessings and glory procured by the Lamb. The same character may be ascribed to the living creatures in Ezekiel's visions, and to the cherubim, which stood over and looked into the mercy-seat, sprinkled with the blood of the atonement, and on the Shechinah, or divine glory arising from it, as well as the cherubic figures which were placed on the edge of Eden; and thus the cherubim, which are prominently introduced in all the three successive dispensations of the covenant of grace, appear to be symbols of those who, in every age, should officially study and proclaim the glory and manifold wisdom of God (See on this curious subject Monceau, *Aaron Purgatus*; Shaw, *On the Cherubim*; Spencer, *De Legib. Hebræor.*; Grotius, *Notes on the Old Test.*; Borchart, *De Animal.*; Bryant's *Mythol.*; Kirby's *Introduct. to Bridgewater Treatise.*)—R. J.

CHESTNUT-TREE. [ARMON.]

CHILDREN. The word 'children' is sometimes used in the plural number, when meant to designate only one male issue (comp. 1 Chron. ii. 31; 2 Chron. xxiv. 25; xxxiii. 6). In such places the terms בְּנֵי, literally 'sons,' is equivalent to offspring, all of whom had probably died except the last-mentioned in the text. The more children—especially of male children—a person had among the Hebrews, the more was he honoured, it being considered as a mark of divine favour, while sterile people were, on the contrary, held in contempt (comp. Gen. xi. 30; xxx. 1; 1 Sam. ii. 5; 2 Sam. vi. 23; Ps. cxxviii. 3, *sg.*; cxxviii. 3; Luke i. 7; ii. 5). That children were often taken as bondsmen by a creditor for debts contracted by the father, is evident from 2 Kings iv. 1; Is. l. 1; Neh. v. 5. Among the Hebrews, a father had almost unlimited power over his children, nor do we find any law in the Pentateuch restricting that power to a certain age; it was indeed the parents who even selected wives for their sons (Gen. xxi. 21; Exod. xxi. 9, 10,

11; Judg. xiv. 2, 5). It would appear, however, that a father's power over his daughters was still greater than that over his sons, since he might even annul a sacred vow made by a daughter, but not one made by a son (Num. xxx. 4, 16). Children cursing or assaulting their parents were punished by the Mosaic Law with death (Exod. xxi. 15, 17; Lev. xx. 9); a remarkable instance of which is quoted by Christ (Matt. xv. 4, 6; Mark vii. 9, 13). Before the time of Moses a father had the right to choose among his male children, and declare one of them (usually the child of his favourite wife) as his first-born (בְּרִכְוּ), though he was perhaps only the youngest. Properly speaking, the 'first-born' was he who was first begotten by the father, since polygamy excluded all regard in that respect to the mother. Thus Jacob had sons by all his four wives, while only one of them was called the first-born (Gen. xlix. 3); we find, however, instances, where that name is applied also to the first-born on the mother's side (1 Chron. ii. 50; comp. v. 42; Gen. xxii. 21). The privileges of the first-born were considerable, as shown in **BIRTH-RIGHT.**

The first-born son, if not expressly deprived by the father of his peculiar rights, as was the case with Reuben (Gen. xlix.), was at liberty to sell them to a younger brother, as happened in the case of Esau and Jacob (Gen. xxv. 31, *sg.*). Considering the many privileges attached to first-birth, we do not wonder that the Apostle called Esau a *thoughtless person* (Heb. xii. 16). There are some allusions in Scripture to the modes in which children were carried. These appear to be adequately represented by the existing usages, as represented in the following cut (No. 233), in which fig. 1 represents a Nestorian woman bearing her child bundled at her back, and fig. 2, an Egyptian female bearing her child



233.

on her shoulder. The former mode appears to be alluded to in several places, and the latter in Isa. xlix. 22. For other matters regarding children, see **ADOPTION, BIRTH, BIRTHRIGHT, EDUCATION.**—E. M.

CHINNERETH. [CINNERETH.]

CHIOS (Χίος), one of the principal islands of the Ionian Archipelago, mentioned in Acts xx. 15. It belonged to Ionia, and lay between the islands Lesbos and Samos, and distant eight miles from the nearest promontory (Arenum Pr.) of Asia Minor. It is thirty miles long from N. to S., and its greatest breadth ten miles. It is very fertile in cotton, silk, and fruit, and was anciently celebrated for its wine. The principal town was also called Chios, and had the advantage of a good harbour (Strabo xiv. p. 645). The island is now called by the Greeks

Khio, and by the Italians Scio. The wholesale massacre and enslavement of the inhabitants by the Turks in 1822 forms one of the most shocking incidents of the Greek war.

CHISLEV (כִּסְלֵו; 1 Macc. i. 54, Χασελεύ) is the name of that month which is the third of the civil, and the ninth of the ecclesiastical year of the Jews, and which commences with the new moon of our December. It corresponds, in Josephus, to the Macedonian month Ἀπελλαῖος. As it is now admitted that Chislev is one of those Persian names of months which the Jews adopted after the captivity, it is fruitless to search for a Syro-Arabian etymology of the word. Benfey has shown that כסלו is a mutilated form of כסלו; and, by an ingenious, although adventurous, mode of derivation, deduces that word from the Zend *Khsathravairya*, through a series of commutations incident to its transit through the different dialects (*Monatsnamen einiger alter Völker*, p. 124).

The memorable days which were observed in this month were:—The feast of the dedication of the Temple, in commemoration of its being purified from the heathen abominations of the Syrians, which was celebrated by illuminations and great demonstrations of joy for eight days, beginning from the 25th of this month (1 Macc. iv. 59): and a fast on account of Jehoikim having, in this month, burnt the roll containing Jeremiah's prophecy (Jer. xxxvi. 22, 23). There is some dispute whether this fast was observed on the 6th or on the 28th of the month. It is an argument in favour of the earlier day that the other would fall in the middle of the eight days' festival of the dedication.—J. N.

CHITTAH. [WHEAT.]

CHITTIM, or KITTIM (כִּתִּיִּים, כִּתִּיִּים), a branch of the descendants of Javan, the son of Japheth (Gen. x. 4). The plural termination of Chittim, and other names in this ethnographical survey (ver. 13, 14), renders it probable that the term *son* must be understood (like its correlate, *father*; v. אב) not in the strict sense of that relation. On the authority of Josephus, who is followed by Epiphanius and Jerome, it has been generally admitted that the Chittim migrated from Phœnicia to Cyprus, and founded there the town of Citium, the modern Chitti. 'Chethimus possessed the island of Chethima, which is now called Cyprus, and from this, all islands and maritime places are called Chethim by the Hebrews' (Joseph. *Antiq.* i. 6, § 1). Cicero, it may be remarked, speaks of the Citians as a Phœnician colony (*De Finibus*, iv. 20), 'scis enim Citiaos clientes tuos a Phœnicia profectos.' Dr. Pococke copied at Citium thirty-three inscriptions in Phœnician characters, of which an engraving is given in his *Description of the East*, (vol. ii. p. 213), and which have recently been explained by Gesenius in his *Monum. Phœnic.* (p. 124-133). Some passages in the prophets (Ezek. xxvii. 6; Isa. xxiii. 1, 12) imply an intimate connection between Chittim and Tyre. At a later period the name was applied to the Macedonians (1 Macc. i. 1, Χερταίται; and viii. 1, Κερταῖων). Hengstenberg has lately endeavoured to prove that in every passage in the Old Testament where the word occurs, it means Cyprus, or

the Cyprians. On Numbers xxiv. 24, he remarks that the invaders of Ashur and Eber are said to come not from Chittim, but כְּתִיִּים, *from the coast of Chittim*, that being the track of vessels coming from the west of Palestine. In Dan. xi. 30, he contends that the use of the absolute form, כְּתִיִּים, instead of the construct, denotes a less intimate connection with the following word, and that the phrase means, like that in Balaam's prophecy (to which he supposes the prophet alludes), ships sailing *along the coast of Chittim*. The Vulgate translates Chittim, in this passage, *Romanos*, an interpretation adopted by several of the ancient Jewish and Christian writers. Bochart attempts to support it on etymological grounds, of which Michaelis presumes to say, 'etymologica autem quæ de Latio Bochartus habet, facile ipsi relinquæ, quæstiones geographicas his *crepundiis* carere cupiens.'

After a careful examination of the works of which the titles are given at the end of this article, the writer is disposed to acquiesce in the opinion expressed by the editor of the *Pictorial Bible*, 'Chittim seems to be a name of large signification (such as our Levant), applied to the islands and coasts of the Mediterranean, in a loose sense, without fixing the particular part, though particular and different parts of the whole are probably in most cases to be understood' (v. notes on Ezek. xxvii. 6; Michaelis, *Spicilegium Geographiæ Hebræorum Exteræ post Bochartum*, pars i. pp. 1-7, 103-114; Michaelis, *Supplementa ad Lexicæ Hebræicæ*, pp. 1138, 1377-1380; Bocharti *Geogr. Sacr.* c. 157-161; Gesenii *Thesaurus*, p. 726; Pococke's *Description of the East*, vol. ii. p. 213; Newton's *Dissertations on the Prophecies*, v.; Hengstenberg, *Die Geschichte Bileams und seine Weissagungen*, Berlin, 1842, pp. 200-202).
J. E. R.

CHIUN. [REMPHAN.]

CHLOE (Χλόη), a Christian woman at Corinth, some members of whose family afforded Paul intelligence concerning the divisions which reigned in the church at that place (1 Cor. i. 11).

CHOACH. [THORNS.]

CHORAZIN (Χοραζίν), a town mentioned in Matt. xi. 21; Luke x. 13, in connection with Bethsaida and Capernaum, not far from which, in Galilee, it appears to have been situated. Jerome makes it a village of Galilee, on the shore of the lake Tiberias, two miles from Capernaum (*Onomast.*, art. 'Chorozain'). Lightfoot and other Talmudical scholars have endeavoured to identify it with certain places named in the Mishnah; and travellers have hazarded various conjectures as to its site. But no place of the name has been historically noticed since the days of Jerome; and not only the town, but its very name appears to have long since perished. [BETHESDA; CAPERNAUM.]

CHRIST. [JESUS.]

CHRONICLES. *Name*.—This name seems to have been first given to two historical books of the Old Testament by Jerome (Prolog. Galeat.). The Hebrews call them כְּרִי הַיָּמִים, i. e. *words of days, diaries, or journals*, and reckon them but one book. The Alexandrian translators, who regarded them as two books, used the appellation Παράλειπόμενα, *things omitted*, as if they were *supplementary* to the other historical records belonging to the Old Testament canon.

Contents.—In 1 Chron. i-x. is given a series of genealogical tables interspersed with historical notices. These genealogies are not complete.

1 Chron. x-xxix. contains the history of David, partly agreeing with the account given of him in the books of Samuel, though with several important additions relating to the Levites.

2 Chron. i-ix. contains the history of Solomon.

2 Chron. x-xxviii. furnishes a succinct account of the kingdom of Judah while Israel still remained, but separate from the history of the latter.

2 Chron. xxix-xxxvi. describes the kingdom of Judah after the downfall of Israel, especially with reference to the worship of God.

From this analysis it appears that the Chronicles contain an epitome of sacred history, particularly from the origin of the Jewish nation to the end of the first captivity.

Diction.—The diction is such as suits the time immediately subsequent to the captivity. It is substantially the same with that of Ezra, Nehemiah, and Esther, which were all written shortly after the Babylonian exile. It is mixed with *Aramaicisms*, marking at once the decline of the Jews in power, and the corruption of their native tongue. The pure Hebrew had been then laid aside. It was lost during their sojourn in Babylon. The *orthography* is characterized by an adoption of the *matres lectionis*, particularly in the word דוד, which is written דודי. In one passage (2 Chron. xxv. 1) ירושלים occurs for ירושלם. In proper names *Aleph* is frequently interchanged with *he* quiescent at the end, as עזא for עזה (1 Chron. xiii. 7). A contrary interchange of the same letters is found at the commencement of a word, as איה for היה (1 Chron. xiii. 12). *Aleph prosthetic* occurs in אישי (1 Chron. ii. 13). We meet also with such peculiarities of *diction* as ארננון for ארננון (2 Chron. ii. 6); בוין, a Persian word (2 Chron. ii. 13); בירה, which appears also to be of Persian origin (1 Chron. xxix. 1); ננוך (1 Chron. xxviii. 11); התיחש (1 Chron. v. 17); מדרש (2 Chron. xxiv. 27; xiii. 22); נדן (1 Chron. xxi. 7); צרך (2 Chron. ii. 15); קבל (2 Chron. xxix. 16); תלמיד (1 Chron. xxv. 8). (See Gesenius's *Geschichte der Heb. Sprache und Schrift*; Gramberg's *Die Chronik nach ihrem Geschichtl. Charakter*, &c.; De Wette's *Einleitung*, 4th ed. § 189.)

Age and Author.—Internal evidence sufficiently demonstrates that the Chronicles were written after the captivity. Thus the history is brought down to the end of the exile, and mention is made of the restoration by Cyrus (2 Chron. xxxvi. 21, 22). It is certain that they were compiled after the time of Jeremiah (2 Chron. xxxv. 25), who lived to see the destruction of Jerusalem by the Chaldeans. The genealogy of Zerubbabel is even continued to the time of Alexander (1 Chron. iii. 19-24). The same opinion is supported by the character of the *orthography* and the nature of the *language* employed, as we have already seen, both which are Aramaean in complexion, and harmonize with the books confessedly written after the exile. The Jews generally ascribe the Chronicles to Ezra (*Baba Bathra*, f. xv. c. 1). Such is their most ancient tradition, however false it may be in the opinion of Ewald. With them agree Carpzov, Eichhorn, Keil, and Hävernick; but Calmet, Jahn,

De Wette, Bertholdt, Gramberg, and Movers attribute them to some unknown author. The following arguments may be adduced in favour of the current Jewish opinion:—

1st. The language of Ezra, who is generally thought to have written the book that bears his name, remarkably coincides with that of the Chronicles. Accordingly, Movers fully concedes that Chronicles and Ezra formed originally one book and proceeded from one author, although he argues that only a part of the book of Ezra was written by himself, while the other part and the books of Chronicles were compiled by some priest or Levite. But if Ezra wrote a portion of that book which is now called by his name, there is no good ground for supposing that he did not compose the whole; and if he compiled the whole, then we argue that the fragmentary character and the entire style present a remarkable similarity to the books of the Chronicles. They obviously point to the same writer (See Keil's *Apologetischer Versuch über die Chronik*, Berlin, 1833, 8vo.).

2ndly. Another argument in support of the same view is, that the book of Ezra begins with the same words with which the Chronicles terminate. The same person repeats his own words in order to connect his history.

This repetition, however, has been accounted for in other ways. Thus it has been conjectured that the last two verses were added by some transcriber, who, having finished the book of Chronicles at verse 21, proceeded, without leaving the usual distance between different books, to write the book of Ezra; but, soon finding his mistake, broke off abruptly and began Ezra at the usual distance, without erasing the lines which he had carelessly appended to Chronicles. This supposes that Ezra once followed Chronicles. Others account for the repetition by referring to a practice among the Jews, who, 'in the public reading of their Scriptures, to avoid ending with the recital of any calamity producing dejection, add the commencement of the next paragraph, or repeat a portion of that which precedes, in order to finish with something consolatory.' Gramberg thinks that such repetition proves the writer of Chronicles to have had the book of Ezra before him; but this is purely conjectural, and contrary to other evidence. Besides, why may it not as well establish the reverse? The wish of this Rationalist writer to bring down these books to a very late period prompted him to advance an argument so utterly baseless.

To the first mode, which attributes this remarkable recapitulation to a transcriber, we do not attach much probability. It may be objected that there are at least two verbal differences between the words as they appear in Chronicles and in Ezra, so that the careless transcriber must be supposed not only to have written so far without perceiving his mistake, but also to have copied inaccurately. Besides, it is not consistent with the habitual accuracy of the Jewish scribes to have committed so palpable an error; or, after having fallen into it, not to rectify it. The universality of its existence also militates against the hypothesis. Another copyist must soon have detected the mistake, unless he had chosen to shut his eyes. All copies contain the passage in both places; and it is found in the Septuagint translation both of Chronicles and Ezra.

The second mode of accounting for the fact is equally improbable. The practice to which appeal is made relates to the *public recital* of the Hebrew Scriptures, rather than to the *written state*. Besides, the *mnemonic* term פּוּרְנִי includes a definite number of books, viz. Isaiah, the twelve minor prophets, Lamentations, and Ecclesiastes, in reading which the Jews were accustomed to repeat the portion that precedes the termination. That they added the commencement of the paragraph *subsequent* to the sad portion, or that such a practice was extended to Ezra, or indeed to any other of the sacred books except those specified, can never be proved. It is a gratuitous supposition, destitute of all foundation.

In short, no method of accounting for the repetition is so probable as that which makes Ezra continue his own history *nearly* in his own words.

3dly. The portions peculiar to the Chronicles are just such as we might expect from Ezra. They correspond to his character as a zealous reformer and priest.

In opposition to these arguments it has been asserted—

1st. That the genealogy of Zerubbabel is brought down to the time of Alexander, who was later than Ezra. Hence some have even placed the writer in the time of Alexander the Great. So De Wette, in the third edition of his *Introduction to the Old Testament*. Eichhorn, Jahn, and Dahler assume, that 1 Chron. iii. 19-24 was appended by a modern hand. This conjecture may be true, though it does not commend itself to our approbation, because there is strong evidence in favour of the opinion that the canon was completed by Ezra and the learned men with whom he was associated (see Hävernick's *Einführung in das Alte Testament*, p. 49). Was it not possible, however, for Ezra to write the portion in question? If he was inspired, as we believe, is there ought to forbid the supposition that such knowledge was directly communicated to him? The fact of his inspiration is quite sufficient to account for his recording the genealogy of Zerubbabel.

2ndly. The difference of the genealogies in 1 Chron. vi. 3, etc., and Ezra vii. 1, etc., proves that Ezra was not the writer of both. So De Wette. This argument is weak. Ezra's design in writing the book that bears his name must have been different from his object in compiling the Chronicles. Most properly, therefore, does he vary in his accounts. Sometimes he relates more briefly what he had already narrated in detail, and *vice versa*.

3rdly. It is improbable that the histories contained in the books of Kings and Chronicles should be written by the same person, since they contain numerous discrepancies and contradictions. This objection is valid only against those who believe that the books of Kings were written by Ezra. So far from supposing, with Dr. Allix and others, that Ezra wrote the Chronicles about 26 years after the Kings, we believe, upon the ground of strong internal evidence, that there was almost an interval of a century between the composition of the two works.

4thly. Such passages as 2 Chron. v. 9 and viii. 8, the former of which speaks of the ark being in the holy place 'unto this day,' and the latter, of tribute being paid 'until this day,' seem to imply

that the Chronicles were written while the temple was standing, before the decline of Judah.

Were it supposed that Ezra was the *original* writer of these passages, they would prove fatal to the idea of his having composed these historical books. But, on the contrary, they were transcribed from records existing before the temple was demolished, and inserted verbatim as Ezra found them. But why, it may be asked, did he not accommodate them to his own time? Did he quote indiscriminately, as has been said, without taking the trouble to reconcile inconsistencies? Far be it from us to adopt or sanction such unguarded language as virtually sets aside the inspiration of the writer.

The Chronicles were intended as a *supplement* to other historical books, especially Samuel and Kings. Accordingly, the portions repeated from these for the sake of completeness, or derived from public annals, the compiler did not deem necessary or desirable to adapt in every instance to the time in which he himself lived. They were copied with the subordinate design of *connecting* such portions as he was prompted to write for the first time. They are *incidental*, not *essential*, to the author's purpose. They serve as links to give unity and compactness to such paragraphs as the Holy Spirit thought to be the most important. To change these extracts was not, therefore, regarded necessary. Minute and systematic effort for attaining accuracy does not characterize the sacred authors. With an ingenuous and noble negligence they disdain artificial trammels. Expressions like these show the scrupulous fidelity with which the compiler adhered to the ancient records. The same passages, it may be remarked, also occur in the books of Kings (1 Kings viii. 8; 1 Kings ix. 21), and show, from their exact similarity, that they were copied from the same original.

5thly. The difference of style and manner of narration in Ezra and Chronicles shows that Ezra was not the author. So Jahn. This assertion is certainly unfounded. The style, language, and idiom are remarkably alike, as will be manifest to the attentive reader of these works. The manner of narration in both partakes of no greater dissimilarity than the different objects with which they were written demand and justify. Other arguments in favour of Ezra may be seen in Keil's *Apologetischer Versuch über die Chronik*, Berlin, 1833, 8vo.

Scope.—The principal design of the writer seems to have been to maintain the proper distinctions between the tribes and families of the returning Hebrews, that the Messiah's descent out of the tribe and family whence he was to spring according to prophecy, might be made manifest. Accordingly, the family of David is specially noticed and prominently portrayed. The author also shows how the lands had been distributed before the captivity, that the people might obtain the ancient inheritance of their fathers. In doing so he goes back to the most ancient times, and presents to his countrymen their earliest history, lest, during their exile, they might have forgotten their original and lost the traces of their real ancestry. In addition to this object it was also intended to show how the worship of God should be properly resumed and orderly re-established. In accordance with such a purpose he gives the genea-

logy of the priests and Levites more fully than any other writer, records their functions and rank, and enters with particularity into the arrangements established among them by David and Solomon. These two purposes, which are closely allied, will serve to demonstrate the perfect congruity of all that is peculiar in the Chronicles. They account for the genealogical tables, the specifications of tribes and families with their situation, as also for a variety of references to the priests and Levites, to the preparations made by David for building the temple, the reformations which took place at different periods, the prosperity of such kings as feared Jehovah and walked in his ways, to the marvellous interpositions of Heaven on behalf of those who trusted in Him alone, to the idolatry of Israel and their consequent misfortunes.

The books of Chronicles as compared with those of Kings are more *didactic* than *historical*. The *historical* tendency is subordinated to the *didactic*. Indeed, the purely historic form appears to be preserved only in so far as it presented an appropriate medium for those religious and moral observations which the author was directed to adduce. Samuel and Kings are more occupied with the relation of *political* occurrences; while the Chronicles furnish detailed accounts of *ecclesiastical* institutions.

Scarcely.—A thorough examination of these books as compared with those of Samuel and Kings will satisfy the inquirer that the latter were known to Ezra and extensively used by him in the composition of Chronicles. It is impossible to believe, with Le Clerc, that the writer of the Chronicles did not know the books of Samuel and Kings. De Wette and Movers refer to the character of originality belonging to the earlier accounts of Samuel and Kings as contrasted with the compilation-manner of the records in the books before us, but this has a feeble and questionable existence. The earlier books themselves must have been compiled from annals. So far as the history contained in them is concerned, it bears little evidence of originality. It is true that the books of Samuel present no references to national records such as occur in Kings, but their internal character and structure evince their derivation from annals contemporaneous with the events they relate.

But the books of Samuel and Kings are not the only source from which the Chronicles have been taken. Public documents formed the common groundwork of the three histories. The Pentateuch has also been used in their compilation. A comparison of the first nine chapters of 1 Chron. with the Mosaic books will show the parallelism existing between them; and it should be especially noticed that 1 Chron. i. 43-54 agrees *verbatim* with Genesis xxxvi. 31-43. Perhaps, however, this passage in both has been drawn from the same source.

As the Almighty does nothing superfluously, and puts forth no exertion of his power where his infinite wisdom does not perceive a fitting necessity, it would have been unnecessary, as far as we can perceive, to suggest anew to the mind of the writer facts with which he must have been partially acquainted by tradition, and which he had an opportunity of knowing from the sacred records. It is evident that the Chronicles were compiled

not only from former inspired writings, but, for the most part, from public records, registers, and genealogies belonging to the Jews. That national annals existed there can be no doubt. They are expressly mentioned, as in 1 Chron. xxvii. 24. They contained an account of the most important events in the history of the Hebrews, and were generally lodged in the tabernacle or temple, where they could be most conveniently consulted.

The histories of kings appear to have been usually written by *prophets* (1 Chron. xxix. 29; 2 Chron. ix. 29; xii. 15; xiii. 22). Hence they constantly refer to the divine rewards and punishments characterizing the theocracy. These historical writings of the prophets were, for the most part, inserted in the public annals, as is evident from 2 Chron. xx. 34; xxxii. 32; xii. 15; xxiv. 27. Whether they were *always* so inserted is questionable, for they seem to be distinguished from the annals of the kingdom in 2 Chron. xxxiii. 19. From such sources Ezra extracted the accounts which he was prompted to write for the use of mankind in all ages. We cannot believe that his selection was indiscriminate or careless. His inspiration effectually secured him against everything that was inaccurate or unsuitable to the purposes for which he was supernaturally enlightened. That he committed mistakes cannot for a moment be admitted, else his history is impugned and its position in the canon inexplicable. His veracity, integrity, and scrupulous exactness must be held fast by every right-minded believer.

The following are the *references* to older memoirs or historical works:—1. The book of Samuel the seer, the book of Nathan the prophet, and the book of Gad the seer (1 Chron. xxix. 29). This cannot mean the inspired books of Samuel, because they do not contain the entire history of David ('his acts first and last'). It refers to a history of his own times written by Samuel, and to a continuation of it, embracing succeeding times, written by Nathan and Gad, from which it is probable that part of the contents of the present books of Samuel was drawn.—2. The book of Nathan the prophet, the prophecy of Abijah the Shilonite, and the visions of Iddo the seer (2 Chron. ix. 29).—3. The book of Shemaiah the prophet, and of Iddo the seer *concerning genealogies*; or, as De Wette translates it, *after the manner of family-registers* (2 Chron. xii. 15).—4. The *story*, or rather, the *interpretation* (*midrash*) of the prophet Iddo (2 Chron. xii. 22).—5. The book of Jehu the son of Hanani, inserted in the book of the Kings of Israel (2 Chron. xx. 34).—6. The history of Uzziab, by Isaiah the son of Amoz (2 Chron. xxvi. 22).—7. The vision of Isaiah the prophet, in the book of the Kings of Judah and Israel (2 Chron. xxxii. 32). (See Gesenius's *Commentar über den Jesaia*; *Einleit.* § 4.)—8. The sayings of Hosai (2 Chron. xxxiii. 19).—9. The interpretation of the book of the Kings (2 Chron. xxiv. 27).—10. The book of the Kings of Judah and Israel (2 Chron. xvi. 11; xxv. 26; xxvii. 7; xxviii. 26; xxxv. 27; xxxvi. 8). This could not have been our present books of Kings, but *public annals*, because in several instances where the reader is referred to them for further information, our books of Kings contain less than what is stated in the Chronicles.—11. The book of the Kings of Israel (2 Chron. xx. 34),

—12. The words or histories of the Kings of Israel (2 Chron xxxiii. 18). It is probable that Nos. 10, 11, and 12 refer to the same historical work.

—13. The Chronicles of King David (1 Chron. xxvii. 24).—14. The Lamentations (2 Chron. xxxv. 25). This does not mean the Lamentations of Jeremiah which we now have, but other Lamentations composed by the prophet on the death of Josiah, and long since lost.

Discrepancies between the books of Chronicles and former histories.—These discrepancies may be arranged under three heads: I., variations in orthography and diction; II., in arrangement; III., in facts and numbers.

I. Older and more difficult expressions are usually changed for such as are later and easier.

Those variations that respect orthography alone are of a threefold kind.

(a.) The *Scriptio plena* instead of the *defectiva* (comp. 2 Chron. viii. 18 with 1 Kings ix. 27).

(b.) Variations adapted to the later and, for the most part, the *Aramaean* form of the language (comp. 2 Chron. x. 18 with 1 Kings xii. 18).

(c.) Corrections of anomalous forms (comp. 2 Chron. xxi. 9 with 2 Kings viii. 21).

Variations of a grammatical nature exhibit the same endeavour to accommodate the text of the older and more difficult original to later usage, thus:—

(a.) The older form of a substantive is changed for a later form from the same root (comp. 1 Chron. xiv. 2 with 2 Sam. v. 12).

(b.) The more ancient or irregular flexion of a substantive or verb is altered into that belonging to later usage (comp. 2 Chron. ix. 19 with 1 Kings x. 20; 1 Chron. xix. 12 with 2 Sam. x. 11).

(c.) Alterations adapted to the later *usus loquendi* are made in the construction. Thus, in place of the *infinitive absolute*, joined to the finite verb of the same root, the writer of the Chronicles uniformly omits the infinitive (comp. 1 Chron. xiv. 10 with 2 Sam. v. 19; 2 Chron. vii. 19 with 1 Kings ix. 6).

(d.) Grammatical corrections. Thus, in verbs *Lamed He*, the writer of the Chronicles uses the *apocopated future conversive*, instead of the *full form* (comp. 2 Chron. xviii. 23, 33 with 1 Kings xxii. 24, 34).

Thus far with regard to the orthography and grammatical character. In respect to the language of these books we find—

(a.) That an older or unusual expression is changed for one later or more current (comp. 1 Chron. xxi. 2 with 2 Sam. xxiv. 2; 1 Chron. x. 12 with 1 Sam. xxxi. 12).

(b.) Names that had become rare or antiquated, are altered into such as had become current and better known (comp. 2 Chron. xvi. 4 with 1 Kings xv. 20).

(c.) *Definiteness and precision* are given to indefinite expressions used in the sources whence the writer drew (comp. 2 Chron. xxxiv. 24 with 2 Kings xxii. 16).

(d.) Expressions liable to be taken in an erroneous or bad sense are changed for others which are synonymous (comp. 2 Chron. xxii. 12 with 2 Kings xi. 3; 1 Chron. xix. 4 with 2 Sam. x. 4).

II. Discrepancies in arrangement.

Even a cursory perusal of these books, as compared with those of Samuel and Kings, will show that several sections are differently placed. This fact, however, is of no weight against the *authenticity* or *authority* of the Chronicles. The sacred writers do not profess to follow the order of time. The historical writings of Moses, the prophecies of Isaiah and Jeremiah, the Gospels of Matthew, Mark, and Luke, are not placed in the exact order of time: 1 Chron. xiv. (comp. 2 Sam. v. 11-25), 2 Chron. i. 14-17 (comp. 1 Kings x. 26-29), and 2 Chron. ix. 25, &c., are evidently out of their true chronological position.

III. Under this head may be classed—

(a.) Omissions of words, phrases, sentences, and paragraphs; as also abbreviations of former statements.

(b.) Additions, longer or shorter, as compared with preceding accounts relative to the same topics.

If we remember that these books are *supplementary*, we shall not be surprised at such particulars, but rather be prepared to expect them. Several localities had changed their names or undergone alterations. The restored Jews knew certain things under other appellations and by other definitive marks than those which had formerly distinguished them. The writers had also different purposes, requiring an adaptation of their narratives to the circumstances amid which they lived, and the state of knowledge possessed by their contemporaries. Besides, the materials were more numerous after the captivity. So far, then, from accusing the writer of *incorrectness, senselessness, and confusion*, as De Wette does, because of these discrepancies, we regard them as evidences of his fidelity and proofs of his artlessness. *Variations are not contradictions.* No two historians in narrating the same events will give exactly the same circumstances, although both their narratives may be most true.

(c.) Discrepancies and contradictions. But not only do discrepancies exist between the Chronicles and former histories, there are also contradictions. Looking at the Masoretic text, the fact cannot be questioned. However disagreeable or unwelcome, it must be admitted.

Many passages, however, which are usually adduced under this head, do not belong to it. Thus—

2 Chron. ix. 25	1 Kings iv. 26.
" xxii. 2	2 Kings viii. 26.
1 Chron. xxi. 1	2 Sam. xxiv. 1.
" xxi. 5	" xxiv. 9.
" xxi. 11, 12	" xxiv. 13.
" xxi. 25	" xxiv. 24.
2 Chron. xiii. 2	1 Kings xv. 10.

are not opposed to one another. There is no contradiction in them; they are quite reconcilable. Dr. Kennicott and others have hastily inferred that there is corruption, because they did not perceive their right meaning. Our space will not allow us to point out the true mode of harmonizing them; we may therefore be permitted to refer to Davidson's *Sacred Hermeneutics*, where they are fully resolved. The preceding are not *all* the passages frequently quoted as contradictory. They furnish a *specimen* of those that appear to be so. In Movers, Kennicott, and Gramberg, others may be found which are injudiciously

brought forward as truly at variance; yet there are *real contradictions*. Thus—

2 Chron. viii. 18 1 Kings ix. 28.

1 Chron. xi. 11 2 Sam. xxiii. 8.

” xxi. 5 ” xxiv. 9, where the numbers of Judah are different.

” xviii. 4 2 Sam. viii. 4.

” xix. 18 ” x. 18.

and other places that might be quoted, present *real contradictions*. How then are they to be disposed of? To this we reply, that the text is corrupt. It is well known that the text of the books of Samuel, Kings, and Chronicles is in a worse condition than that of the other inspired writings. The fact is unquestionable, in whatever way it may be explained. Here, transcribers fell into more mistakes than they have elsewhere committed. Many of the names and words that are differently written, should be referred to this head. Some omissions and some interpolations also belong to it. They are nothing but corruptions in the text. But the principal contradictions relate to *numbers*. These seem to have been expressed in various ways; and copyists, having different methods of marking them, were naturally exposed to errors. Sometimes numbers were designated by *letters*, occasionally by *ciphers*; and again they were marked by *words*.

It is time that the text of these historical books should be rectified in those instances where an unquestionable necessity exists. If there be not manuscript evidence to warrant certain changes, we should not be deterred from making them. Common sense, the credit of the inspired writers, and, above all, their sacred authority, outweigh all scruples about correcting by *conjecture*. *Real contradictions* should never be allowed to tarnish a text written under the immediate superintendence of the Holy Spirit. Errors committed by copyists should be at once removed, else evil-minded men may charge them on the original authors. Some are averse to believe that they have originated, since the close of the canon, in the unavoidable changes incident to the multiplication of copies during many centuries. It is marvellous to observe the attachment with which Rationalists adhere to the Masoretic text as if it were *perfect*. On the ground of its *absolute correctness*, they attribute to the sacred writers ignorance, falsification, and error. We greatly admire a conscientious zeal for the general purity of our present text, and envy not the motives of the man who emends it rashly. A disposition to alter it frequently and frivolously is not far from scepticism. But we equally dislike that rigid adherence to its present condition which individuals having no concern for the truth of God or the honour of his word exhibit—an adherence, so far from being commendable, that it subserves the very worst purpose, even to impugn the truthfulness of the most honest historians.

But De Wette affirms that the writer of Chronicles contradicts *himself*, as well as preceding historians. In proof of this assertion he quotes the following passages:—

2 Chron. xiv. 1 2 Chron. xv. 19, and

1 Kings xv. 32.

” xiv. 2 2 Chron. xv. 17.

” xvii. 6 ” xx. 33.

” xxx. 26 ” xxxv. 18.

From a careful perusal and comparison of these

places, we affirm that they are not contradictory. It is only the superficiality of rationalism or the blindness of infidelity that discovers opposition in them.

The character of such statements as are peculiar to the Chronicles.—From an inspection of 1 Chron. xvi. 4-11; 1 Chron. xxii.-xxvi. 28; xxviii.; xxix.; 2 Chron. xv. 1-15; 2 Chron. xvii. 7, &c.; xxvi. 16-21; xxx.; xxxi., it will be manifest, that it was one design of Ezra to notice with particularity the order of the divine worship as established by David and Solomon, with various reformations in the theocracy that took place at different times. The Levitical priesthood, and the public service of God, are specially noticed and prominently brought into view. From 2 Chron. xiii.; xx. 21, &c.; xix. 2, &c.; xxv. 7, &c., it is evident that God's miraculous interference on behalf of Judah, and his displeasure with idolatrous Israel, were also intended to be depicted. In accordance with the same object, pious kings evincing appropriate zeal for the glory of Jehovah are commended, and their efforts marked with approval (comp. 2 Chron. xiv. 6-15; xvii. 10, &c.; xx.; xxvi. 5, &c.; xxvii. 4-6, &c.), while the ruin of idolatrous practices is forcibly adduced (2 Chron. xxi. 11, &c.; xxviii. 5, &c.; xxxiii. 11, &c.; xxv. 14, &c.; xxxvii. 6).

Such are the characteristic peculiarities of these books; and we now ask the impartial reader to consider if they be not worthy of the Holy Spirit under whose guidance the Chronicles were written. Are they not admirably in unison with the character of Ezra the high-priest and reformer? What more natural, or more accordant with the solitudes of this holy man, than to dwell upon such matters as relate to the worship of Jehovah, to the priests, and Levites? Surely *he* was appropriately directed to record the reformations effected by godly kings, and the disastrous consequences of forsaking the true God, whose zeal was abundantly manifested in reform, and to whom idolatry was peculiarly offensive. And yet upon these very chapters and paragraphs charges the most flagrant have been founded. The author of them has been accused of hatred to Israel, predilection for the Levites, love of the marvellous, design to magnify pious kings and to lighten the mistakes of the kingdom of Israel. It is unnecessary to enter into any refutation of these monstrous accusations. They bear with them their own condemnation. They are the offspring of that Rationalism which resolves to see nothing but what it relishes. On every page of these historical books are impressed *genuineness* and *honesty*. The writer candidly refers to the sources whence his information was derived; and contemporary readers, placing implicit reliance on his statements, allowed the original documents to perish. He relates many things disgraceful to Judah and its kings, while he evinces no desire to palliate or conceal sin. He even retains, as we have seen before, expressions incongruous with his own age, and therefore exactly copied from the ancient records. Surely a writer guilty of falsification would have been careful to alter these into exact correspondence with his own times. Transparent simplicity of character needs not such minutiae.

We have alluded to the attacks made upon

these books in Germany, because they are of a most serious nature. Nor have they yet ceased. They are still continued. Since De Wette put forth his energies in the unholy service (in his *Beiträge zur Einleitung in das Alte Testament*, Halle, 1806, 8vo.), he has repeated and enlarged his objections in every edition of a popular Introduction to the Old Testament, although Dahler, *De Librorum Paralipomenon auctoritate atque fide historica*, Argentor. 1819, 8vo., successfully combated his statements. He has been aided too and strengthened by Gramberg, in his *Die Chronik nach ihrem Geschichtl. Charakter und ihrer Glaubwürdigkeit neu geprüft*, Halle, 1823, 8vo., and indirectly encouraged by Gesenius, in his *Geschichte der Hebr. Sprache und Schrift*, Leipzig, 1815, 8vo.; and in his *Commentar über den Jesaja*. Yet the credibility of the books has stood these various attacks, uninjured. In opposition to De Wette and Gramberg, two scholars have appeared who have successfully vindicated the Chronicles from their superficial accusers. We refer to F. C. Movers, who, in his *Kritische Untersuchungen über die Biblische Chronik*, Bonn, 1831, 8vo., has entered into an examination of all the points connected with these books with great skill and minuteness. His work is of a masterly and most satisfactory character. It is immeasurably the best on the subject that has ever appeared. In addition to Movers, we allude to C. F. Keil, whose *Apologetischer Versuch über die Chronik*, Berlin, 1833, 8vo., forms a very valuable treatise on the same side. Differing in various respects from Movers, he takes up some interesting topics in connection with the Chronicles, and occasionally advances opinions more correct than those of the pastor in Bonn. To these may be subjoined the observations of Eichhorn, in his *Introduction*, who is wondrously judicious and sound on this subject; as also the *Introduction* of Jahn, who displays here his wonted ability. Nor should the old but valuable *Introduction* of Carjzov be neglected.—S. D.

CHRONOLOGY is the science which measures time by the periodic revolutions of the heavenly bodies, particularly of the sun, moon, and stars. The idea of time is derived from the succession of events which happen in the heavens or on the earth. The entrance of events in human history is accidental and irregular, but in the history of the heavens it is subject to fixed and certain laws. Accordingly the heavenly phenomena afford the surest basis for the division of time, and serve best to give orderly arrangements to the irregular and accidental events which succeed each other in civil history. Chronology is divided into two kinds, theoretical and practical, or mathematical and historical. The first teaches the division of time in reference to the phenomena of the heavens; the second teaches it in regard to the succession of human events. The culmination of a star, or, what is the same thing, the daily turning of the earth on its axis, offers a regular and constantly-recurring event as a measure of time, and answers for this purpose better than the varying period of time which is derived from the revolution of the earth round the sun.

The knowledge of the Hebrews in chronology rested altogether on appearances; not a trace of anything like a scientific view is to be found in

their literature. The books of the Old Testament recognise none of the great eras which other nations have employed. Nor is it until the first book of the Maccabees that any such guide is found. Times and periods are for the most part left relatively undetermined; and consequently it is difficult, if not impossible, to establish any satisfactory chronology for the succession of events in the history of the Hebrew people. Genealogical tables indeed are not wanting, but they are of little service for the general purposes of chronology. Neither the new moon nor the year were the ancient Hebrews able to measure and foretell with astronomical accuracy, so as to possess some standard for chronological purposes; and they were content, so far as regards the moon, with such information as marks and traces on the hills, or messengers could afford, after the new moon had made her appearance.

The last thing which appears of importance to the annalist of a rude age is to mark the precise order of the occurrences which he records, and more especially to afford the means of determining their place in the map of time, by noting their distance from some common point to which they may all be referred. In the more ancient portion of the Old Testament we have to rely almost solely upon the uncertain standard which is founded upon the average duration of human life and the length of a generation—a mode of reckoning which, as it proceeds upon a principle at no time fixed, and assumes the constancy of elements which are subject to an incessant, but irregular variation, cannot be applied with any degree of confidence to establish the date of events removed from one another by the lapse of centuries. From the flood to the days of Abraham the generation or period between the birth of a father and that of his eldest son became gradually contracted; but as the rate of diminution was far from being uniform, no satisfactory conclusion can hence be deduced in regard to the number of years which passed from the nativity of Arphaxad to the infancy of the patriarch. Had the sacred historians been led to measure the lapse of time and the succession of events by a reference to the epoch of creation, or even to that of the deluge, there would have been no difficulty in finding the proper place of every other occurrence, as well as the true limits of every particular epoch. From the Exode down to the era of Christianity, the life of the human being, having fallen more nearly to its present extent, supplies a better standard; and hence from the death of Moses to the decline of the Jewish state, chronology shines with a clearer and more steady light.

Chronology finds it no easy task to harmonize the discrepancies which present themselves alike in regard to the length of the entire period which elapsed from the Creation to the birth of Christ, and the several great periods into which, for the sake of convenience, the lengthened whole has been divided. The distance of the Creation from the Christian era, which has been stated with about 140 different variations, is given in the *Indian Chronology*, as computed by Gentil, at 6174 years; in the *Babylonian*, by Bailly, at 6158; in the *Chinese*, by Bailly, at 6157; in the *Septuagint*, by Abulfaragius, at 5508; while *Jewish*

writers bring it down below the computation of Capellus, namely, 4000, and one, Rabbi Lipman, to so contracted a sum as 3616 The separate

numbers which compose this chronological period are thus stated by Usher, Playfair, Jackson, and Hales:—

	USHER. Years.	PLAYFAIR. Years.	HALES. Years.	JACKSON. Years.
From Creation to Deluge	1656	1656	2256	2256
„ Deluge to Birth of Abraham	292	292	1002	1072
„ Birth to his leaving Haran	134	75	75	75
„ that event to the Exode	430	430	430	430
„ Exode to foundation of Temple	479	510	621	579
„ Temple to Christian era	1013	1014	1027	1014
	<hr/> 4004	<hr/> 4007	<hr/> 5411	<hr/> 5426

The chronology of the English Bible was regulated by the views of Usher, who followed, in general, the authority of the Hebrew text. Jackson and Hales put themselves under the guidance of the Septuagint and Josephus, maintaining that the modern Hebrew text has been greatly vitiated in the whole department of chronology, and more especially in the genealogical tables which respect the antediluvian patriarchs, as well as the ten generations immediately after the Flood. The computation of Jackson places the Creation B.C. 5126; that of the modern Hebrew for the same era is 4004, making a difference of 1422 years. According to Hales the world was created B.C. 5111; according to the modern Hebrew Bible, 4004—difference, 1407 years. The shortened scheme, adopted by Usher from the Masorite Jews, is recent in its origin, when compared with the more comprehensive chronology of the Septuagint. This last was used before the advent of our Lord, was followed by the fathers of the church, and appears not to have been called in question till, in the eighth century, a disposition to exchange it for the Rabbinical method of reckoning was first manifested by the venerable Bede. The preference given, in consequence of the reformation from Popery, to everything Hebrew, or connected therewith, led, at an early period after that great protest against the corruptions of the Western church, to the adoption and general use, at least in this country, of the numbers of the original Hebrew text. In time, however, opponents to this system appeared. Isaac Vossius, in his treatise *De Vera Etate Mundi*, was the first of any note. He was feebly answered by Hornius. Pezron, in his work *L'Antiquité des Temps rétablie et défendue contre les Juifs et les nouveaux Chronologistes*, produced a great impression in favour of the lengthened period advocated by Vossius. The positions of Pezron were assailed by Martianay, whose chief merit lies in having given occasion for Pezron's reply, entitled *Défense de l'Antiquité des Temps*. The treatise of Mr. Hayes on the chronology of the Septuagint is the first considerable work by an English author on the genealogical numbers of the Greek Scriptures compared with those of the Hebrew text, and it is peculiarly valuable for a successful attempt to prove that the Chaldean and Egyptian antiquities are consistent with the sacred history of the Jews, when viewed through the medium of the Septuagint. It was not, however, till the middle of the last century that the indefatigable Jackson produced, in three volumes, quarto, his great work,

the *Chronological Antiquities*. Adopting the principles of Vossius, Pezron, and Hayes, he made the interval between Adam and Christ 5126 years. In the beginning of the present century Dr. Hales published the first volume of a laborious work entitled, *A New Analysis of Chronology*, an undertaking which ultimately extended to three volumes, without adding anything of much value to the conclusions of Jackson. Mr. Faber, in his work on Pagan idolatry, offers some judicious observations on the chronology of ancient history, treading generally in the footsteps of Hales. The *Origines* of Sir William Drummond proceeds also on the ground supplied by the Septuagint chronology.

The contracted scheme of the Hebrew text is rejected by the greatest names in this branch of Biblical literature, as being glaringly inconsistent not only with the records of other nations, but even with the history of the ancient Hebrews themselves. A detailed statement of grounds for admitting the authority of the Septuagint in preference to that of the original Hebrew may be found in a preliminary dissertation prefixed to the first volume of Dr. Michael Russell's *Connection of Sacred and Profane History, from the Death of Joshua to the Decline of the Kingdoms of Israel and Judah*, London, 1827. The computation which Dr. Russell considers to 'accord best with the ancient Scriptures, as well as with the several histories which have been derived from them, does not extend the number of years from the creation to the advent of Christ beyond 5441.' The same writer undertakes to prove that the great difference which is found between the chronology of the modern Hebrew Scriptures and the system of dates which determine the order of the corresponding events, as recorded in the Samaritan Pentateuch, in the Septuagint version, and in the works of Josephus, did not always exist, but must have been occasioned by an alteration introduced into the Jewish registers between the period at which the translation of the Seventy was first made public and the middle of the second century of the Christian era. Evidence is also adduced to show that this difference was not accidental and such as might have originated in the ignorance or carelessness of transcribers, but was regularly planned and effected for an unworthy object. The chronology of the Hebrew Scriptures and that of the Greek version, the author contends, were originally the same; and that the accuracy of the latter was not called in question by the

Jews for nearly four hundred years—that is, until the rapid progress of Christianity awakened the enmity of certain unprincipled individuals of that 'nation,' who were induced to alter the dates of their ancient chronicles in order to weaken the arguments derived from them in support of the new religion.

The entire period which elapsed from the Creation till the birth of Christ is usually divided for chronological purposes into the following ages:—From the Creation to the Deluge; from the Deluge to the birth of Abraham; from the birth of Abraham to the Exode of the Israelites; from the

Exode to the building of Solomon's temple; from the building of the temple to the destruction of the same; from the destruction of the temple to the restoration of the Jews; and from that event to the Christian era. In the first of the above periods a very great discrepancy is found to prevail between the numeration of the modern Hebrew text and that of the Septuagint and Josephus. The amount of the difference between these ancient authorities, as well as the singular variation which appears in the Samaritan Pentateuch, will be understood from the following table:—

Number of Years from the CREATION to the DELUGE.

	Lived before Birth of Eldest Son.				After the Birth of Eldest Son.				Total Length of Life.			
	Hebr.	Samar.	Sept.	Josep.	Hebr.	Samar.	Sept.	Josep.	Hebr.	Samar.	Sept.	Josep.
Adam	130	130	230	230	800	800	700	700	930	930	930	930
Seth	105	195	205	205	807	807	707	707	912	912	912	912
Enos	90	90	190	190	815	815	715	715	905	905	905	905
Cainan	70	70	170	170	810	810	710	710	910	910	910	910
Malaleel	65	65	165	165	830	830	730	730	895	895	895	895
Jared	162	62	162	162	800	785	800	800	962	847	962	962
Enoch	65	65	165	165	300	300	200	200	365	365	365	365
Methuselah	187	67	187	187	782	653	782	782	969	720	969	969
Lamech	182	53	188	182	595	600	595	595	777	653	753	777
Noah, at the Flood	600	600	600	600								
To the Flood . .	1656	1307	2262	2256								

Thus, from the Creation to the Deluge, the number of years, according to the

Hebrew text, is 1656
Samaritan Pentateuch 1307
Septuagint Version 2262
Josephus 2256

Between Josephus and the Septuagint the difference is only six years; while both of these differ from the modern Hebrew Bible not less than six hundred. The cause of this remarkable variation, or rather what has been considered the manner in which it was occasioned, may be discovered in the principle according to which the Jews constructed their chronological tables. They measured the several eras of their ancient history not by adding together the full lives of their successive patriarchs, but by taking the sum of their *generations*—that is, the age to which they had respectively attained at the birth of their eldest son. For example, the generation of Enos, or his age at the birth of Cainan, is estimated by the Hebrew and Samaritan texts as having extended to 90 years; the residue of his life, according to the same authorities, is 815 years; and the total length of life, being the amount of both these sums, is 905 years; whereas, in the Septuagint and Josephus, the generation is enlarged to 190 years; the residue of life is diminished to 715 years; while the full length of life, or 905 years, is the same in all these ancient

records. Hence, in order to lengthen or shorten any particular era, it was only necessary to alter the proportion between the generation and the residue of life, and such, Dr. Russell states, was the method actually adopted.

An era properly so called the ancient Hebrews did not possess. Signal events seem to have been made use of as points from which to date. Moses, like Herodotus, reckoned by generations. The Exodus, as may be seen in Exod. xix. 1, and Num. xxxiii. 38, probably, also, the building of the first temple (1 Kings ix. 10; 2 Chron. iii. 2), were employed as starting-points to aid in assigning events their position in historical succession. Also the destruction of the first temple, or the beginning of the Babylonish captivity (in the summer of the year B.C. 586), and the liberation of the Jews from the Syrian yoke by the valour of the Maccabees (in the autumn of the year n.c. 143), were used as epochs from which time was reckoned. After the manner of other nations, the Hebrews computed time by the succession of their princes, as may be seen throughout the books of Kings and Chronicles. At a later period, and in the first book of the Maccabees, what is termed the Greek era, or that of the Seleucidæ, began to be employed. This era, which is also called the era of the Syro-Macedonians, commences from the year of Rome 412, twelve years after the death of Alexander, and 311 years and four months before

The birth of our Saviour, the epoch of the first conquest of Seleucus Nicator in that part of the West which afterwards composed the immense empire of Syria. The Julian year, formed of the Roman months, to which Syrian names were given, was used. This era prevailed not only in the dominions of Seleucus, but among almost all the people of the Levant, where it still exists. The Jews did not abandon the use of this era until within the last 400 years. At present they date from the Creation, which they hold to have taken place 3760 years and three months before the commencement of the Christian era. In order to fix their new moons and years, as well as their feasts and festivals, they were obliged to make use of astronomical calculations and cycles. The first cycle they used for this purpose was one of 84 years; but this being discovered to be faulty, they had recourse to the Metonic cycle of 19 years, which was established by the authority of Rabbi Hillel, prince of the Sanhedrim, about the year 360 of the Christian era. This they still use, and say it is to be observed till the coming of the Messiah. Indeed, some contend that their present practice of dating from the Creation of the world is of great antiquity. Their year is lunisolar, consisting either of 12 or 13 months each, and each month of 29 or 30 days; for in the compass of the Metonic cycle there are 12 common years, consisting of 12 months, and seven intercalary years, consisting of 13 months, which are the third, sixth, eighth, eleventh, fourteenth, seventeenth, and nineteenth of the cycle.

The birth of the Saviour of the world probably took place somewhat earlier than the date which is usually assigned to it. Usage, however, has long fixed the era to which it gave rise, namely the *Christian era*, or the era of the Incarnation, to begin on the 10th day of January, in the middle of the fourth year of the 194th Olympiad, the 753rd year of the building of Rome, and in the 4714th of the Julian period. The use of the Christian era was introduced in the sixth century; in France it was first employed in the seventh. About the eighth it was generally adopted; but considerable difference has existed not only in various countries but even in the same place in the same country and at the same

period, respecting the commencement of the year. Nor did the use of the era become universal in Christendom till the fifteenth century. The Christian year consists of 365 days for three successive years, and of 366 in the fourth, which is termed leap-year. This computation subsisted for 1000 years without alteration, and is still used by the followers of the Greek church. The simplicity of this form has brought it into very general use, and it is customary for astronomers and chronologists, in treating of ancient times, to date back in the same order from its commencement. There is unfortunately a little ambiguity on this head, some persons reckoning the year immediately before the birth of Christ as 1 *b.c.*, and others noting it with 0, and the second year before Christ with 1, thus producing one year less than those who use the former notation. The first, however, is the usual mode.

The Christian year, arranged as has been shown, was 11' 11" too long, an error which amounted to a day in nearly 129 years. Towards the end of the sixteenth century the time of celebrating the Church festivals had advanced ten days beyond the periods fixed by the Council of Nice in 325. It was, in consequence, ordered by a Bull of Gregory XIII. that the year 1582 should consist of only 355 days, which was brought about by omitting ten days in the month of October, namely from the 5th to the 14th. And to prevent the recurrence of a like irregularity, it was also ordered that in three centuries out of four the last year should be a common instead of a leap-year, as it would have been by the Julian Calendar. The year 1600 remained a leap-year, but 1700, 1800, and 1900 were to be common years. This amended mode of computing was called 'The New Style.' It was immediately adopted in all Catholic countries, but Protestants came to use it only gradually. In England the reformed calendar was adopted in the year 1752 by omitting eleven days, to which the difference between the styles then amounted. The alteration was effected in the month of September, the day which would have been the third being called the fourteenth.

The following summary shows the correspondence of the principal epochs, eras, and periods with that of the birth of Christ, or Christian era.

Epochs, Eras, and Periods.	Months and Years of Commencement.
The Grecian year of the World	September 1, <i>b.c.</i> 5598.
The ecclesiastical era of Constantinople	March 21, or April 1, <i>b.c.</i> 5508.
The civil era of Constantinople	September 1, <i>b.c.</i> 5508.
The Alexandrian era	August 29, <i>b.c.</i> 5502.
The ecclesiastical era of Antioch	September 1, <i>b.c.</i> 5492.
The Julian period	January 1, <i>b.c.</i> 4713.
The Mundane era	October, <i>b.c.</i> 4008.
The Jewish Mundane era	Vernal equinox, <i>b.c.</i> 3761.
The civil Jewish era	October, <i>b.c.</i> 3761.
The era of Abraham	October 1, <i>b.c.</i> 2015.
The destruction of Troy	June 12 or 24, <i>b.c.</i> 1184.
The epoch of the building of Solomon's temple	May, <i>b.c.</i> 1015.
The era of the Olympiads	New moon of Summer solstice, <i>b.c.</i> 776.
The Roman era	April 21, <i>b.c.</i> 753.
The era of Nabonassar	February 26, <i>b.c.</i> 747.
The epoch of Daniel's 70 weeks	Vernal equinox, <i>b.c.</i> 458.
The Metonic cycle	July 15, <i>b.c.</i> 432.
The Calippic period	New moon of Summer solstice, <i>b.c.</i> 330.
The Philippean era	June, <i>b.c.</i> 323.

Epochs, Eras, and Periods.	Months and Years of Commencement.
The Syro-Macedonian era	September 1, B.C. 312.
The Tyrian era	October 19, B.C. 125.
The Sydonian era	October, B.C. 110.
The Cæsarean era of Antioch	September 1, B.C. 48.
The Julian era	January 1, B.C. 45.
The Spanish era	January 1, B.C. 38.
The Actian era	January 1, B.C. 30.
The Actian era in Egypt	September 1, B.C. 30.
The Augustan era	February 11, B.C. 27.
The Pontifical indiction	December 25, or January 1, B.C. 3.
The indiction of Constantinople	September 1, B.C. 3.
The vulgar Christian era	January 1, A.D. 1.
The destruction of Jerusalem	September 1, A.D. 69.
The era of the Maccabees	November 24, A.D. 166.
The era of Dioclesian	September 17, A.D. 284.
The era of Ascension	November 12, A.D. 295.
The era of Martyrs	February 23, A.D. 303.
The era of the Armenians	July 7, A.D. 552.
The era of the Hegira	July 16, A.D. 622.
The era of Yezdegird, or Persian era	June 16, A.D. 632.

In addition to the works mentioned in the article, the following will be found of service to the student of Biblical Chronology: Prideaux, *Old and New Testament Connected*; Shuckford, *The Sacred and Profane History of the World Connected*; *Mémoires de l'Académie des Inscriptions et Belles Lettres*; Michaelis, *Schreiben an Schlozer, die Zeitrechnung von der Sündfluth bis Salomo betreffend*, im 'Gotting. Mag. der Wissensch.' 1 Jahrg.; Gesenius, *De Pentateuchi Samarit. Origine*, Hal. 1815. On the era of the Seleucidæ see Petavii *Doctr. Temp.* ix. 40. Herzewisch, *Eiml. in die Hist. Chron.* Alt. 1811; Vignoles, *Chronologie de l'Histoire Sainte*, &c., Berlin, 1783; Beer's *Abhandlungen zur Erläut. d. alten Zeitrechn.* Leipz. 1752; Frank's *Astronom.-Grundrechnung der Bibl. Gesch.* Leipz. 1753; Lud. Capelli *Chronol.*; Bengelii *Ordo Temp.*; Silberschlag, *Chronologie der Welt*, Berlin, 1783; *Chronology of History*, by Sir H. Nicholas, in Lardner's *Cabinet Cyclopædia*. A valuable treatise on Eras of Ancient and Modern Times may be found in the *Companion to the Almanac*, 1830.—J. R. B.

CHRYSOLITE. [THARSHISH.]

CHRYSOPRASUS. [SHOHAM.]

CHURCH (Ἐκκλησία). The original Greek word, in its larger signification, denotes a number of persons called together for any purpose, an assembly of any kind, civil or religious. As, however, it is usually applied in the New Testament to religious assemblages, it is very properly translated by 'assembly,' in the few instances in which it occurs in the civil sense (Acts xix. 32, 39, 41). It is, however, well to note that the word rendered 'assembly' in these verses is the same which is rendered 'church' everywhere else.

In a few places the word occurs in the Jewish sense, of a congregation, an assembly of the people for worship, either in a synagogue (Matt. xviii. 17) or generally of the Jews regarded as a religious body (Acts vii. 38; Heb. ii. 12). The text last cited is quoted from Psalm xxii. 22; where the Septuagint uses ἐκκλησία for the Hebrew קָהָל, which has the same meaning, namely, assem-

bled or congregation. Elsewhere also this word, which we render 'church' in the New Testament, is used by the Sept. for the Hebrew word which we render 'congregation' in the Old Testament.

But the word most frequently occurs in the Christian sense of an assemblage (of Christians) generally (1 Cor. xi. 18). Hence it denotes a church, the Christian church; in which, however, we distinguish certain shades of meaning, viz.—1. A particular church, a church in a certain place, as in Jerusalem (Acts viii. 1; xi. 22, &c.), in Antioch (Acts xi. 26; xiii. 1, &c.), in Corinth (1 Cor. i. 2; 2 Cor. i. 1), &c. &c. 2. Churches of (Gentile) Christians, without distinguishing place (Rom. xvi. 4). 3. An assembly of Christians which meets anywhere, as in the house of anyone (Rom. xvi. 5; 1 Cor. xvi. 19; Philem. 2). The Church universal—the whole body of Christian believers (Matt. xvi. 18; 1 Cor. xii. 28; Gal. i. 13; Eph. i. 22; iii. 10; Heb. xii. 23, &c.).

CHUSHAN-RISHATHAIM (כּוּשָׁן רִישָׁתַּיִם), Sept. Χουσαρσαθαίμ), a king of Mesopotamia, by whom the Israelites were oppressed for eight years (B.C. 1394 to B.C. 1402), until delivered by Othniel (Judg. iii. 8-10).

CHUZA (Χουζᾶς), steward of Herod Antipas, whose wife Joanna was one of those who employed their means in contributing to the wants of Christ and his apostles (Luke viii. 3).

CILICIA (Κιλικία), the south-eastern part of Asia Minor, bounded on the W. by Pamphylia; separated on the N. from Cappadocia by the Taurus range, and on the E. by Amanus from Syria; and having the gulf of Issus (Iskenderoon) and the Cilician Sea (Acts xxvii. 5) on the South. By the ancients the eastern part was called Cilicia Propria (ἡ ἰδίως Κιλικία, Ptolemy), or the level Cilicia (ἡ πεδιάς, Strabo); and the western, the rough (ἡ τραχία, Strabo, xiv. 5), or mountainous (ἡ ὄρειή, Herod. ii. 34). The former was well-watered, and abounded in various kinds of grain and fruits (Xenoph. *Anab.* i. 2. § 22. Cilicia—dives bonis omnibus terra. Ammianus Marcell. xiv. 8. § 1. The chief towns in this division were Issus (Xenoph. *Anab.* i. 4), and

the south-eastern extremity, celebrated for the victory of Alexander over Darius Codomanus (B.C. 333), and not far from the passes of Amanus (τῶν Ἀμανίδων λεγομένων Πυλῶν. Polyb. xii. 8); *Solæ*, originally a colony of Argives and Rhodians, the birth-place of Menander, the comic poet (B.C. 262); the stoic philosopher Chrysippus (B.C. 206), and of Aratus, author of the astronomical poem τὰ Φαινόμενα (B.C. 270); and *Tarsus*, the birth-place of the Apostle Paul [TARSUS]. Cilicia Trachea furnished an inexhaustible supply of cedars and firs for ship-building; it was also noted for a species of goat, of whose skins cloaks and tents were manufactured. Its breed of horses was so superior, that 360 (one for each day of the year) formed part of the annual tribute to the king of Persia (Herod. iii. 90). The neighbourhood of Corycus produced large quantities of saffron (*Crocum sylvestre optimum*). *Prima novitas Cilicio, et ibi in Coryco monte*, Plin. *Nat. Hist.* xxi. 17). Herodotus says that the first inhabitants of the country were called Hypachæi, *Ἰπᾶχαιοί*; and derives the name of Cilicia from Cilix, son of Agenor, a Phœnician settler (vii. 91). He also states that the Cilicians and Lycians were the only nations within the Halys who were not conquered by Cræsus (i. 28). Though partially subjected to the Assyrians, Medes, Persians, Syrians, and Romans, the Eleuthero- (or free) Cilicians, as the inhabitants of the mountainous districts were called, were governed by their own kings (Reguli, Tacit. ii. 78), till the time of Vespasian. The sea-coast was for a long time occupied by pirates, who carried on the appropriate vocation of slave-merchants, and found ample encouragement for that nefarious traffic among the opulent Romans (Mannert, vi. 1; Strabo, xiv. 5); but at last their depredations became so formidable, that Pompey was invested with extraordinary powers for their suppression, which he accomplished in forty days. He settled the surviving freebooters at Solæ, which he rebuilt and named Pompeiopolis. Cicero was proconsul of Cilicia (A.U.C. 702), and gained some successes over the mountaineers of Amanus, for which he was rewarded with a triumph (*Epist. ad Fam.* xv. 4). Many Jews were settled in Cilicia. (Acts vi. 9; Philo, *De legat. ad Caium*, § 36.)

According to the modern Turkish divisions of Asia Minor, Cilicia Proper belongs to the Pashalic of Adana; and Cilicia Trachea to the Liwah of Itchil in the Mousselimlik of Cyprus. (Malte-Brun's *Geography*, Edinb. 1822, vol. ii. p. 97.) A copious account of the ancient Geography of Cilicia is given in Mannert's *Geographie der Griechen und Römer*. vi. 2, pp. 32-113.—

CINNAMON. [KINNEMON.]

CINNERETH, or CINNEROTH (כִּנְרֶת or כִּנְרוֹת), one of the 'fenced cities' of the tribe of Naphtali (Josh. xix. 35; Deut. iii. 17; Josh. xi. 2). In the last of the texts cited it seems to indicate a district. It is also the earlier name of the lake Gennesareth (which is supposed to be a corruption of Cinnereth), from which we may collect that the town lay on the western border of the lake, and was of sufficient consequence to give its own name to it. It is even supposed that Cinnereth, afterwards Gennesareth, was the earlier name of the town of Tiberias, and under the

latter change still extended its own denomination to the lake; nor is there anything improbable in this conjecture.

CIRCUMCISION. The history of Jewish Circumcision lies on the surface of the Old Testament. Abraham received the rite from Jehovah, Moses established it as a national ordinance, and Joshua carried it into effect before the Israelites entered the land of Canaan. Males only were subjected to the operation, and it was to be performed on the eighth day of the child's life: foreign slaves also were forced to submit to it, on entering an Israelite's family. Those who are unacquainted with other sources of information on the subject besides the Scriptures might easily suppose that the rite was original with Abraham, characteristic of his seed, and practised among those nations only who had learned it from them. This, however, appears not to have been the case; and the principal object of the present article is to put together what is known on the *extra-Jewish* Circumcision.

The topic has been treated with much research by so many learned writers that it may seem improbable that any passages of ancient authors which bear upon it can have escaped notice. Michaelis (*Lives of Moses*, vol. iv.), to whom we are indebted for various references, has dedicated forty-one pages to the subject: nor does it appear that any important addition has been made by later inquirers. It remains, therefore, to form our own judgment upon the facts which have been ascertained.

First of all, *the Egyptians* were a circumcised people. Vonck, followed by Wesseling (*ad Herod.* ii. 37) and by numerous able writers, alleged that this was not true of the whole nation, but of the priests only; that at least the priests were circumcised is beyond controversy. No one can for a moment imagine that they adopted the rite from the despised shepherds of Goshen; and we are immediately forced to believe that Egyptian circumcision had an independent origin. A great preponderance of argument, however, appears to us to prove that the rite was universal among the old Egyptians, as long as their native institutions flourished; although there is no question that, under Persian and Greek rule, it gradually fell into disuse, and was retained chiefly by the priests and by those who desired to cultivate ancient wisdom (see Origen, quoted by Michaelis, § 185, p. 25).

Herodotus distinctly declares that the Egyptians practised circumcision; and that he meant to state this of the whole nation is manifest, not only since he always omits to add any restriction, but because, immediately following his first statement of the fact, he annexes this remark—'The priests moreover shave their whole body every other day,' &c. (Herod. ii. 37). It is difficult to suppose that the historian could have been mistaken on this point, considering his personal acquaintance with Egypt. Further, he informs us that the Colchians were a colony from Egypt, consisting of soldiers from the army of Sesostris. With these he had conversed (ii. 104), and he positively declares that they practised circumcision. Yet if the rite had been confined to the priestly caste of Egypt, it could hardly have been found among the Colchians at all. The same remark will apply to the savage Troglodytes of Africa, every branch of whom, except one (the Kolobi), as Diodorus in-

teaches us (iii. 31), was circumcised, having learnt the practice from the Egyptians. The Troglodytes appear to have been widely diffused through Libya, which argues a corresponding diffusion of the rite; yet, from the silence of Diodorus concerning the other savage nations whom he recounts as African Ethiopians, we may infer that it was not practised by them. The direct testimony of Diodorus, Philo, and Strabo is to the same effect as that of Herodotus respecting Egypt; yet this can hardly be called confirmatory, since in their days the rite was no longer universal. Josephus (*Contra Ap.* ii. 13) speaks of it as practised by the priests only; he however reproaches Apion for neglecting the institutions of his country in remaining uncircumcised. Origen, in the passage above referred to, confirms the statement of Josephus. In Kenrick's *Herodotus* (ii. 37) the French commissioners who examined some Egyptian mummies, are quoted, as establishing from them the fact of Egyptian circumcision.

Herodotus, moreover, tells us that the Ethiopians were also circumcised; and he was in doubt whether they had learned the rite from the Egyptians, or the Egyptians from them. By the Ethiopians we must understand him to mean the inhabitants of Meroë or Sennaar. In the present day the Coptic Church continues to practise it, according to C. Niebuhr (quoted by Michaelis); the Abyssinian Christians do the same (Ludolf. *Hist. Ethiop.* do. do.); and that it was not introduced among the latter with a Judaical Christianity appears from their performing it upon both sexes. (It is scarcely worth while to invent a new name, resection, or resection, for accuracy's sake.) Oldendorp describes the rite as widely spread through Western Africa—16° on each side of the Line,—even among natives that are not Mohammedan. In later times it has been ascertained that it is practised by the Kafir nations in South Africa, more properly called Kosa, or Amakosa, whom Prichard supposes to form 'a great part of the native population of Africa to the southward of the Equator.' He remarks upon this:—'It is scarcely within probability that they borrowed the custom from nations who profess Islâm, or we should find among them other proofs of intercourse with people of that class. It is more probable that this practice is a relic of ancient African customs; of which the Egyptians, as it is well known, partook in remote ages' (Prichard, *Physical Hist. of Man*, 3rd ed. vol. ii. p. 287).

How far the rite was extended through the Syro-Arabian races is uncertain. In the 9th section of the Epistle of Barnabas (which, whether genuine or not, is very old), the writer comments as follows:—'But you will say, the Jews were circumcised for a sign. And so are all the Syrians and the Arabians, and the idolatrous priests; and even the Egyptians themselves are circumcised.' This language is vague and popular; yet it shows how notorious was the wide diffusion of the custom. The Philistines, in the days of Saul, were however uncircumcised; so also, says Herodotus (ii. 104), were all the Phœnicians who had intercourse with the Greeks. That the Canaanites, in the days of Jacob, were not all circumcised, is plain from the affair of Dinah and Shechem. The story of Zipporah (*Exod.* iv. 25) who did not circumcise her son,

until fear came over her, that Jehovah would slay her husband Moses, proves that the family of Jetho, the Midianite, had no fixed rule about it, although the Midianites are generally regarded as children of Abraham by Keturah. On the other hand, we have the distinct testimony of Josephus (*Antiq.* i. 12, 2) that the Ishmaelite Arabs, inhabiting the district of Nabathæa, were circumcised after their 13th year: this must be connected with the tradition which no doubt existed among them, of the age at which their forefather Ishmael underwent the rite (*Gen.* xvii. 25). St. Jerome also (quoted by Michaelis) informs us that, to his day, 'usque hodie,' the tribes dwelling round Judæa and Palestine were circumcised, 'especially all the Saracens who dwell in the desert.' Elsewhere he says that, 'except the Egyptians, Idumæans, Ammonites, Moabites, and Ishmaelites of the desert, of whom the greater part are circumcised, all other nations in the world are uncircumcised.' A negative argument is more or less dangerous: yet there is something striking in the fact, that the books of Moses, of Joshua, and of Judges, never bestow the epithet *uncircumcised* as a reproach on any of the seven nations of Canaan, any more than on the Moabites or Ammonites, the Amalekites, the Midianites, or other inland tribes with whom they came into conflict. On the contrary, as soon as the Philistines become prominent in the narrative, after the birth of Samson, this epithet is of rather common occurrence. The fact also of bringing back, as a trophy, the foreskins of slain enemies, never occurs except against the Philistines (1 Sam. xviii.). We may perhaps infer, at least until other proof or disproof is attained, that while the Philistines, like the Sidonians and the other maritime Syrian nations known to the Greeks, were wholly strangers to the practice, yet among the Canaanites, and all the more inland tribes, it was at least so far common that no general description could be given them from the omission.

It appears from Josephus (*Antiq.* xiii. 9), that when Hyrcanus subdued the Idumæans, he forced them to be circumcised on pain of expatriation. This shows that they had at least disused the rite. But that is not wonderful, if it was only a custom, and not a national religious ordinance; for, as Michaelis observes, the disuse of it may have dated from the edict of Antiochus Epiphanes, of which it is said (1 Macc. i. 41, 42), 'The King Antiochus wrote to all his kingdom, that all should be one people; and that all should keep the ordinances of his country: and all the nations acquiesced according to the word of the king.'

The rather obscure notices which are found in Jeremiah and Ezekiel of the circumcision of the nations who were in immediate contact with Israel, admit of a natural interpretation in conformity with what has been already adduced (*Jer.* ix. 25; *Ezek.* xxxi. 18; also xxxii. 19, *et passim*). The difficulty turns on the new *moral* use made of the term 'uncircumcised,' to mean simply *impure*. The passage in Jeremiah is thus translated by Ewald:—

'Behold, the days come, that I visit all the uncircumcised circumcised ones; Egypt and Judah, Edom and the children of Ammon and Moab; and all the dwellers in the wilderness that are shaven on the temples: for all the heathen are

uncircumcised, and so is all the house of Israel uncircumcised in heart.'

The shaving of the temples appears to be a religious custom of the same kind: Herodotus (iii. 8) ascribes it to the Arabs generally, and Josephus rather strangely regards the epithet *τροχοκούριδες*, in the ancient Greek poet Chærilus (*c. Ap. i. 22*), as a description of his own countrymen. Knowing that the Egyptians were circumcised, it no longer remains doubtful how *the reproach of Egypt* (Josh. v. 9) should be interpreted.

How far the rite of circumcision spread over the south-west of Arabia no definite record subsists. The silence of the Korân confirms the statement of Abulfedâ (*Hist. Ante-Islamica*, p. 180, ed. Fleischer, 1831), that the custom is older than Mohammed, who, it would appear, in no respect regarded it as a religious rite. Nevertheless it has extended itself with the Mohammedan faith, as though it were a positive ordinance. Pocock (*Specimen Hist. Arab.*, p. 309) cites a tradition, which ascribes to Mohammed the words—

الختان سنة الرجال مكرومة النساء

Circumcision is an ordinance for men, and honourable in women. This extension of the rite to the other sex might, in itself, satisfy us that it did not come to those nations from Abraham and Ishmael. We have already seen that Abyssinian circumcision has the same peculiarity: so that it is every way probable that Southern Arabia had the rite from the same source or influence as Ethiopia. In fact, the very closest relations are known to have subsisted between the nations on the opposite coasts of the Red Sea. Another passage of Abulfedâ (*Annales Muslemici*, vol. i. p. 92) gives specific information on this subject. In the battle of Ohod, in the third year of the Hégira, 'Hamza, the uncle of the prophet, committed great slaughter. When Sabba' ben' Abd ul Uzza', whose mother was a circumciser in Mecca, passed by him, Hamza called out, Come on, you son of a she-circumciser! [*resectricis nympharum!*] The form of the word proves that this was strictly the trade of the old woman, and that the custom, as applied to females, was no innovation of those days.

Pocock quotes the ecclesiastical historian Philostorgius, for the fact that the Himyarite Arabs circumcise their children on the *eighth day*. He adds a passage from Al Gazzâlî, in which the writer says, that the Arabs differ from the Jews as to the time; for they postpone it until the child has teeth, which he thinks safer. Finally, he cites Ibn Athîr, who, writing of the times antecedent to Mohammed, says that the Arabs were accustomed to circumcise between the tenth and fifteenth years.

The statement of Philostorgius may receive light from the Arab historians, who relate (Jost, *Geschichte der Israeliten*, vol. v. p. 236, sqq.) that about a century before the Christian era, several Jewish sovereigns reigned in the region called Shebâ by the Jews, and Yemen by the moderns, where the Himyarites (or Homeritæ) dwelt. The few facts preserved show that they were not close observers of the Mosaic Law, and the suspicion might arise that they were called Jews chiefly from their having received Jewish

circumcision. We have, however, a collateral evidence of much importance, to prove that the influence acting on them had really come from Judæa; namely, it is well known that in Abyssinia a nation called the Falasha still exists, which has very thoroughly adopted the Jewish religion, inasmuch as to have invented legends that allege their descent from the Hebrews. They possess the Old Testament in the Gheez language and character, but their own language is said to be quite alien from the Hebrew; facts which prove that they were really *proselyted* by the Jews at some early period. [ABYSSINIA.] At that same time, it is credible, the Hebrew faith met with similar success on the opposite coast of the Red Sea. Jost believes that, during the war of the Maccabees, great numbers of Jews migrated into Arabia; and it is certain that in later times they were very numerous in Yemen, and their influence great. Wherever they were settled proselytes must have been made; and great zeal was doubtless used to induce them to circumcise their children duly according to the Mosaic rite. We can then quite understand Philostorgius's fact, if we are allowed to suppose that he spoke loosely of 'the Himyarites' doing that which was done by a great many of them. [Concerning the connection of the Jews with Yemen, see farther under SOLOMON.]

An interesting story is told by Josephus—the date so late as the reign of the Emperor Claudius (*Antiq. xx. 2*)—how Izates, the young king of Adiabene, and his mother Helena, were converted by Jewish teachers to a belief in the one true God, the God of the Hebrews: and how, when Izates was desirous of being circumcised, and his mother dreaded that it would alienate his subjects, his Jewish instructor Ananias warmly seconded her views, with a heart like that of Paul; telling him that if he was resolved to imitate Jewish institutions, he could, without being circumcised, adore the true divinity; and that this was far more important than circumcision. At the time he satisfied the young monarch; but afterwards, another Jew, named Eleazar, came from Galilee, and inveighed so strongly on the impiety of his disobedience, that, without more delay, Izates submitted to the rite. It is evident that, in a controversy of this sort, the more narrow-minded teacher had the advantage: and, in consequence, it appears that 'proselytes of righteousness' were always circumcised (Judith xiv. 10, and Tacit. *Hist. v. 5*). The facility with which whole nations have adopted the practice from the Mohammedans proves that it is not so serious an obstacle to the spread of a religion as some have thought it.

The moral meaning of the word 'uncircumcised' was a natural result of its having been made legally essential to Hebrew faith. 'Uncircumcised in heart and ears' was a metaphor to which a prophet would be carried, as necessarily as a Christian teacher to such phrases as 'unbaptized in soul,' or 'washed by regeneration.' If, however, we try to take a step farther back still, and ask *why* this ordinance in particular was selected, as so eminently essential to the seed of Abraham, we probably find that we have reached a point at which we must be satisfied with knowing the fact without the reason. *Every external ordinance, as for instance baptism, must have*

more or less that is arbitrary in it. It is, however, abundantly plain that circumcision was *not* intended to separate the Jews from other nations generally, for it could not do so: and, least of all, from the Egyptians, as the words in Joshua v. 9 show. Rather, it was a well known and already understood *symbol of purity*.

A great deal of speculation and argument has been employed on the utility and origin of the rite to the Egyptians and others. Herodotus, long ago, declared that it was adopted for cleanliness, *καθαριότητος ἕνεκα*: and a slight acquaintance with the ideas of the Turks, concerning personal defilement, will make it easy to believe that an idea of cleanliness continued the practice among nations which had once become habituated to it. In the ancient Egyptians this Turkish spirit was carried to a great height; nor is it wonderful that in hot climates detailed precepts of cleanliness form a very large part of primitive religion. But we can hardly rest in this as a sufficient account of the *origin* of the rite. A sort of circumcision has been found in various parts of the Indian Seas and Pacific Ocean; many notices of which have been collected in the *Penny Cyclopædia* (art. *Circumcision*); but nothing would be gained by reproducing them here. It is more important to state that an adequate physical reason for performing the operation on females of several African races has been fully substantiated. The curious reader will find in Laurence's *Lectures* (chap. v.), the decisive testimony of Mr. Barrow and Dr. Somerville on this point; with an allusion to the efforts of the Romish missionaries to forbid the practice in Abyssinia, and the unexpected consequences which thwarted them. No positive evidence has yet been obtained, that the operation is equally expedient for the males in any of the same races: yet the analogy of the two cases forces us to believe that in both the custom has a physical or medical ground; especially when it is remarked to predominate so much in Africa, where alone (as far as yet appears) such physical peculiarities of structure exist. It was practised, moreover, by the males of African tribes so savage and so little addicted to religious ceremonialism, that a broader ground must be sought for it than simple cleanliness. We have already named the Troglodytes. Strabo mentions two other tribes of Africa, whom he calls Kreophagi and Kolobi (xvi. 4; pp. 387-390, 392. ed. Tauch.), who practised on themselves a yet more shocking mutilation (*κολοβολὴ τὰς βαλάνους*), ascribed to the Kolobi by Diodorus also. The fact, also, that most of these nations performed whatever operation it was, *not* on infants, but on those who were advancing towards marriageable age, conspires to indicate that some physical inconvenience gradually showed itself (as with the Bushmen females), of which they desired to get rid. Jost looks upon *infant* circumcision as the distinguishing mark of Judaism; and this may be nearly correct, though we have seen that, according to Abulfedâ, some Arabs delayed it only till after teething. In fact Diodorus (iii. 31), when speaking of that branch of the Troglodyte nations, which was called Kolobi, declares that they were subjected to the operation in infancy (*ἐκ νηπίου*). Their unnatural and cruel custom is possibly to be referred to superstition. Some indeed have looked on circum-

cision itself as a softened form of the barbarous rite by which the Galli, or priests of Cybele, were qualified for their office. The Kolobite custom might, on the contrary, be a carrying out of that barbarity to the extreme point possible, short of exterminating the population of a tribe. In Winer's *Realehrerbuch* (art. Beschneidung) will be found details of the mode in which the Jews carry their law into effect; and of the still more singular and painful process by which a circumcised person was in some sort restored to his natural condition. (see 1 Macc. i. 15; Joseph. *Antiq.* xii. 5. 1; and Paul, 1 Cor. vii. 18, *ἐπισπᾶσθαι*).

If an independent and human origin has been discovered for Egyptian circumcision, the thought of necessity arises that the Israelites must have had it from the same sources as the nations around them; and it has been discussed (Spencer, *De Leg. Heb.*) whether they even borrowed it from the Egyptians. The idea has naturally given much offence: but in truth the question involves no peculiar difficulty; it is only part of another far wider inquiry. It is notorious that many other ancient nations had various ceremonies and institutions in common with the Jews, and that the Hebrew law is by no means in all points original. That sacrifice pre-existed, is on the surface of the Bible History. The same, however, is true of temples, tabernacles, priests, ever-burning fire, oracles, &c. The fact has been often denoted by saying that the Jewish institutions are a selection, revision and re-enactment of an older patriarchal religion.—F. W. N.

CISTERN. In a country which has scarcely more than one perennial stream, where fountains are not abundant, and where the months of summer pass without rain, the preservation of the rain-water in cisterns must always have been a matter of vast importance, not only in the pasture-grounds, but in gardens, and, above all, in towns. Hence the frequent mention of cisterns in Scripture, and more especially of those which are found in the open country. These were, it seems, the property of those by whom they were formed (Num. xxi. 22). They are usually little more than large pits, but sometimes take the character of extensive subterranean vaults, open only by a small mouth, like that of a well. They are filled with rain water, and (where the climate allows) with snow during winter, and are then closed at the mouth with large flat stones, over which sand is spread in such a way as to prevent their being easily discovered. If by any chance the waters which the shepherd has thus treasured up are lost by means of an earthquake or some other casualty, or are stolen, both he and his flocks are exposed to great and imminent danger; as are also travellers who hasten to a cistern and find its waters gone. For this reason a failure of water is used as the image of any great calamity (Isa. xli. 17, 18; xliv. 3). There is usually a large deposit of mud at the bottom of these cisterns, so that he who falls into them, even when they are without water, is liable to perish miserably (Gen. xxxvii. 22, sq.; Jer. xxxviii. 6; Lam. iii. 53; Ps. xl. 2; lxix. 15). Cisterns were sometimes used, when empty, as prisons, and indeed prisons which were constructed underground received the same name, *בּוּר* (Gen. xxxix. 20; xl. 15).

In cities the cisterns were works of much

labour, for they were either hewn in the rocks or surrounded with subterraneous walls, and lined with a fine incrustation. The system which in this respect formerly prevailed in Palestine is, doubtless, the same that exists at present; and indeed there is every probability that most of the cisterns now in use were constructed in very ancient times. Professor Robinson assures us, that 'the main dependence of Jerusalem at the present day is on its cisterns; and this has probably always been the case.' He then mentions the immense cisterns now and anciently existing within the area of the Temple; supplied partly by rain water, and partly by an aqueduct from Solomon's Pools, and which, of themselves, would furnish a tolerable supply in case of a siege. 'But, in addition to these, almost every private house in Jerusalem, of any size, is understood to have at least one or more cisterns, excavated in the soft limestone rock on which the city is built. The house of Mr. Lanneau, in which we resided, had no less than four cisterns; and as these are but a specimen of the manner in which all the better class of houses are supplied, I subjoin here the dimensions:

	Length.	Breadth.	Depth.
I.	15 feet	8 feet-	12 feet.
II.	8 "	4 "	15
III.	10 "	10 "	15
IV.	30 "	30 "	20

This last is enormously large, and the numbers given are the *least* estimate. The cisterns have usually merely a round opening at the top, sometimes built up with stonework above, and furnished with a curb and a wheel for the bucket; so that they have externally much the appearance of an ordinary well. The water is conducted into them from the roofs of the houses during the rainy season; and, with proper care, remains pure and sweet during the whole summer and autumn. In this manner most of the larger houses and the public buildings are supplied. The Latin convent, in particular, is said to be amply furnished; and in seasons of drought is able to deal out a sufficiency for all the Christian inhabitants of the city.

Most of these cisterns have undoubtedly come down from ancient times; and their immense extent furnishes a full solution of the question as to the supply of water for the city. Under the disadvantages of its position in this respect, Jerusalem must necessarily have always been dependent on its cisterns; and a city which thus annually laid in its supply for seven or eight months could never be overtaken by a want of water during a siege. Nor is this a trait peculiar to the Holy City; for the case is the same throughout all the hill-country of Judah and Benjamin. Fountains and streams are few, as compared with Europe and America; and the inhabitants, therefore, collect water during the rainy season in tanks and cisterns in the cities, in the fields, and along the high roads, for the sustenance of themselves and of their flocks and herds, and for the comfort of the passing traveller. Many, if not the most, of these are obviously antique; and they exist not infrequently along the ancient roads which are now deserted. Thus, on the long-forgotten way from Jericho to Bethel, 'broken cisterns' of high antiquity are found at regular intervals. That Jerusalem was thus actually

supplied of old with water is apparent also from the numerous remains of ancient cisterns still existing in the tract north of the city, which was once enclosed within the walls' [RESERVOIRS].

CITIES. [TOWNS.]

CITIES OF REFUGE. Places of refuge where, under the cover of religion, the guilty and the unfortunate might find shelter and protection were not unknown among the ancient heathen. The jus asyli, or right of shelter and impunity, was enjoyed by certain places reputed sacred, such as groves, temples and altars. This protective power commonly spread itself over a considerable district round the holy spot, and was watched over and preserved by severe penalties. Yet the fate of Pausanias, were there no other similar case, shows that it could not always stand against the assaults of popular indignation. Pausanias, having tampered with the great enemies of his native country, the Persians, was tried at Sparta and condemned. In order to escape from the consequent punishment, he fled into a temple of Minerva. With a view to keep him there and thus punish him with death, the Ephori blocked up the doors and destroyed the roof, the mother of the criminal bringing the first stone.

Among the Greeks and Romans the number of these places of asylum became in process of time very great, and led, by abuse, to a fresh increase of criminals. Tiberius, in consequence, caused a solemn inquiry into their effects to be made, which resulted in a diminution of their number and a limitation of their privileges (Suet. *Tib.* 37, compared with Eusebius, *Eccursus ad h. l.*; Osiander, *De Asylius Gentium*, in Gronov. *The-saur.* t. vi.).

In the Apocrypha (2 Macc. iv. 33) mention is made of a city having the jus asyli—'Onias withdrew himself into a sanctuary at Daphne that lieth by Antiochia.' The temple of Diana at Ephesus (Acts xix. 27) was also a heathen asylum, whose privileges in this respect increased with the progress of time.

This pagan custom passed into Christianity. As early as Constantine the Great, Christian churches were asylums for the unfortunate persons whom an outraged law or powerful enemies pursued. Theodosius, in 431, extended this privilege to the houses, gardens, and other places which were under the jurisdiction of the churches, and the synod of Toledo, in 681, widened the right of asylum to thirty paces from every church. Since then this ecclesiastical privilege prevailed in the whole of Catholic Christendom, and was preserved undiminished, at least in Italy, so long as the papal independence remained. The right acted beneficially in ages when violence and revenge predominated, and fixed habitations were less common than now; but its tendency to transfer power from the magistrate to the priesthood was injurious to the inviolability of law and the steady administration of justice. It has accordingly in recent times been abrogated by most governments (*Conversations Lexicon*, in voc.).

Among the Jews the 'cities of refuge' bore some resemblance to the asylum of the classic nations, but were happily exempt from the evil consequences to which reference has been made, and afford, even to the present day, no mean

proof of the superior wisdom and benignant spirit of the Jewish laws.

The institution was framed with a view to abate the evils which ensued from the old established rights of the blood-avenger [BLOOD-REVENGE], and thereby to further the prevalence in the nation of a mild, gentle, and forgiving spirit.

From the laws on this point (Exod. xxi. 13; Num. xxxv. 9-35; Deut. xix. 1-13) it appears that Moses set apart out of the sacerdotal cities six as 'cities of refuge.' There were, on the eastern side of the Jordan, three, namely, 'Bezer in the wilderness, in the plain country of the Reubenites, and Ramoth in Gilead of the Gadites, and Golan in Bashan of the Manassites' (Deut. iv. 43); on the western side three, namely, 'Kedesh in Galilee in Mount Naphtali, and Shechem in Mount Ephraim, and Kirjath-arba, which is Hebron, in the mountain of Judah' (Josh. xx. 7). If found desirable, then other cities might be added. An inspection of the map will show how wisely these places were chosen so as to make a city of refuge easy of access from all parts of the land. To any one of these cities a person who had unawares and unintentionally slain any one might flee, and if he reached it before he was overtaken by the avenger of blood, he was safe within its shelter, provided he did not remove more than a thousand yards from its circuit, nor quit the refuge till the decease of the high-priest under whom the homicide had taken place. If, however, he transgressed these provisions, the avenger might lawfully put him to death. The roads leading to the cities of refuge were to be kept in good repair. Before, however, the fugitive could avail himself of the shelter conceded by the laws, he was to undergo a solemn trial, and make it appear to the satisfaction of the magistrates of the place where the homicide was committed that it was purely accidental. Should he, however, be found to have been guilty of murder, he was delivered 'into the hand of the avenger of blood, that he might die.'

And the Israelites were strictly forbidden to spare him either from considerations of pity or in consequence of any pecuniary ransom. This disallowal of a compensation by money in the case of murder shows a just regard for human life, and appears much to the advantage of the Hebrew legislation when compared with the practice of other countries (Athens, for instance, and Islam), in which pecuniary atonements were allowed, if not encouraged, and where, in consequence, the life of the poor must have been in as great jeopardy as the character of the wealthy.

The asylum afforded by Moses displays the same benign regard to human life in respect of the homicide himself. Had no obstacle been put in the way of the Goel, instant death would have awaited any one who had the misfortune to occasion the death of another. By his wise arrangements, however, Moses interposed a seasonable delay, and enabled the manslayer to appeal to the laws and justice of his country. Momentary wrath could hardly execute its fell purposes, and a suitable refuge was provided for the guiltless and unfortunate.

Yet as there is a wide space between the innocence of mere homicide and the guilt of actual murder, in which various degrees of blame might easily exist, so the legislator took means to make

the condition of the manslayer less happy than it was before the act or the mischance, lest entire impunity might lead to the neglect of necessary precaution and care. With great propriety, therefore, was the homicide made to feel some legal inconvenience. Accordingly he was removed from his patrimony, restricted in his sphere of locomotion, affected indirectly in his pecuniary interests, and probably reduced from an affluent or an easy station to one of service and labour (Michaelis, *Mos. Recht*, vi. 4). Should any reader still think that this treatment of a manslayer was unnecessarily severe, let him advert to the spirit of the age, and especially study the recognised rights of the next of kin to a slain person, and he will most probably be ready to allow that everything was done in this matter which circumstances admitted. The benefit of the protection afforded was common to strangers and sojourners with native Israelites.

What ensues rests on the authority of the Rabbins. In order to give the fugitive all possible advantage in his flight, it was the business of the Sanhedrim to make the roads that led to the cities of refuge convenient by enlarging them and removing every obstruction that might hurt his foot or hinder his speed. No hillock was left, no river was allowed over which there was not a bridge, and the road was at least two and thirty cubits broad. At every turning there were posts erected bearing the words *Refuge, Refuge*, to guide the unhappy man in his flight; and two students in the law were appointed to accompany him, that, if the avenger should overtake him before he reached the city, they might attempt to pacify him till the legal investigation could take place.

When once settled in the city of refuge, the manslayer had a convenient habitation assigned him gratuitously, and the citizens were to teach him some trade whereby he might support himself. To render his confinement more easy, the mothers of the high-priests used to feed and clothe these unfortunate fugitives, that they might not be impatient and pray for the death of their sons, on whose decease they were restored to their liberty and their property. If the slayer died in the city of refuge before he was released, his bones were delivered to his relations, after the death of the high-priest, to be buried in the sepulchre of his fathers (Lewis, *Origines Hebraicæ*).

That the right of asylum among the Jews was in later periods of their history so extended as to open the door to great abuses may be inferred from 1 Macc. x. 43, where unqualified impunity and exemption from both liabilities and penalties are promised, under the influence, not of the Mosaic law, but of heathen morals and ambition, to 'whosoever they be that flee unto the temple at Jerusalem, or be within the liberties thereof.'

In the words now cited reference appears to be made to a custom which prevailed from very early times, both among the chosen people and the nations of the world, of fleeing, in case of personal danger, to the altar. With the Jews it was customary for the fugitive to lay hold of the horns of the altar, whether in the tabernacle or temple; by which, however, shelter and security were obtained only for those who had committed sins of ignorance or inadvertence: thus true did Moses

remain to his principle that the wilful shedding of human blood could only by blood be atoned—a principle which the advances of civilization and the spread of the gentle spirit of the Gospel have caused to be questioned, if not exploded (Exod. xxi. 14; 1 Kings i. 50; ii. 28). From the two last passages it seems that state criminals also sought the protection of the altar, probably more from the force of custom than any express law. Their safety, however, depended on the will of the king; for in the passages referred to it appears that in one case (that of Adonijah) life was spared, but in the other (that of Joab) it was taken away even 'by the altar.' Compare Matt. xxiii. 35.—J. R. B.

CITIZENSHIP. Strict isolation did by no means, as some suppose, form the leading principle in the system of theocracy as laid down by Moses, since even non-Israelites, under the various names of גֵּר, נִכְרִי, and תּוֹרֵשׁ, not only were allowed to reside in Palestine, but had the fullest protection of the law, equally with the native Israelites (Exod. xii. 19; Lev. xxiv. 22; Num. xv. 15; xxxv. 15; Deut. i. 16; xxiv. 17; the law of usury, Deut. xxiii. 2), made, however, an exception, and were besides recommended in general terms by Moses to humanity and charity (Exod. xxii. 21; xxiii. 9; Lev. xix. 33, 34; Deut. x. 18; comp. Jer. vii. 6; Mal. iii. 5; Joseph. *Contra Ap.* ii. 28), as well as to a participation in certain prerogatives granted to the poor of the land, such as a share in the tithe and feast-offering, and the harvest in the Jubilee-year (Deut. xiv. 29; xvi. 10, 14; xxvi. 11; Lev. xxv. 6). In return, it was required on the part of non-Israelites not to commit acts by which the religious feelings of the people might be hurt (Exod. xx. 10; Lev. xvii. 10; xviii. 26; xx. 2; xxiv. 16; Deut. v. 14. The eating of an animal which had died a natural death, Deut. xiv. 21, seems to have been the sole exception). The advantage the Jew had over the Gentile was thus strictly spiritual, in his being a citizen, a member of the theocracy, of the קְהֵל הַיהוָה (community of God), on whom positive laws were enjoined. But even to this spiritual privilege Gentiles were admitted under certain restrictions (Deut. xxiii. 1-9); thus we find among the Israelites, גֵּר, an Edomite (1 Sam. xxi. 8.), as also אֲדוֹמִי, an Hittite (a Canaanite). The only nations that were altogether excluded from the citizenship of the theocracy by especial command of the Lord, were the Ammonites and Moabites, from a feeling of vengeance against them: and in the same situation were all castrated persons, and bastards, from a feeling of disgrace and shame (Deut. xxiii. 1-6). In the time of Solomon, no less than 153,600 strangers were resident in Palestine (2 Chron. ii. 17).

Roman citizenship (*πολιτεία*, Acts xxii. 28, *jus civitatis*, *civitas*) was granted in the times of the Emperors to whole provinces and cities (Dio Cass. xli. 25; Suet. *Aug.* 47), as also to single individuals, for some service rendered to the state or the imperial family (Suet. *Aug.* 47), or even for a certain sum of money (Acts xxii. 28; Dio Cass. xli. 24). The Apostle Paul was a Roman citizen by family (Acts. *l. c.*), and hence his protesting against corporal or capital punishment (Acts xvi. 37; comp. Cic. *Verr.* v. 57, 65; Euseb. *Hist. Eccl.* v. 1, *etr.*)—E. M.

CITRON. [ΤΑΡΑΧΗ.]

CLAUDA (Κλαύδη), a small island off the S.W. coast of Crete, mentioned in Acts xxvii. 16. It was also called Gaudos (Mela, ii. 7; Plin. *Hist. Nat.* iv. 42), and now bears the name of Gozzo.

CLAUDIA (Κλαυδία), a Christian female of Rome, mentioned in 2 Tim. iv. 21.

CLAUDIUS (Κλαύδιος), the fifth Roman emperor, and successor of Caligula, A.D. 41-54 (Acts xi. 28; xviii. 2). His full name was Tiberius Claudius Nero Germanicus. Previously to his accession he led rather a dissolute life, and the throne was in a great measure secured to him through the address and solicitations of Herod Agrippa (Joseph. *Antiq.* xix. 2. 1, c. 3 and 4; comp. Suet. *Claud.* 10). This obligation he returned by great and peculiar favours to that personage; and the Jews were generally treated with indulgence till the ninth year of his reign, when those who abode at Rome were all banished thence (Acts xviii. 2; comp. Suet. *Claud.* 25). Several famines occurred under Claudius, one of which, in the fourth year of his reign, extended to Palestine and Syria, and appears to be that which was foretold by Agabus (Acts xi. 28, and Kuinoel, *in loc.*; also Krebs, *Obs. in N. T.* p. 219).

CLAUDIUS LYSIAS. [LYSIAS.]

CLAUDIUS FELIX. [FELIX.]

CLAY, a substance frequently mentioned in Scripture, chiefly with reference to its employment by the potter, the elegant and useful forms assumed by the rude material under his hands supplying a significant emblem of the Divine power over the destinies of man (Isa. lxiv. 8; Rom. ix. 21). A remarkable allusion to the use of clay in sealing occurs in Job xxxviii. 14, 'He tuneth it as clay to the seal.' This may be explained by reference to the ancient practice of impressing unburnt bricks with certain marks and inscriptions which were obviously made by means of a large seal or stamp. We trace this in the bricks of Egypt and Babylon [BRICKS]. Modern Oriental usages supply another illustration. Travellers, when entering the khans in towns, often observe the rooms in which goods have been left in charge of the *khanjee* sealed on the outside with clay. A piece of clay is placed over the lock, and impressed by a large wooden stamp or seal.

CLEMENT (Κλήμης), a person mentioned by Paul (Phil. iv. 3), as one whose name was in the book of life. For the meaning of this phrase, see **BOOK OF LIFE**. This Clement was, by the ancient church, identified with the bishop of Rome of the same name (Euseb. *Hist. Eccl.* iii. 4; *Constitut. Apost.* vii. 46); and that opinion has naturally been followed by Roman Catholic expositors. It cannot now be proved incorrect; but the suspicion exists that the case here may be as with many other names in the New Testament, which have been assigned to celebrated persons of a later period. Clement is said to have lived to the third year of the emperor Trajan (A.D. 100), when he suffered martyrdom.

There is an epistle of Clement to the Corinthians, which was highly esteemed by the ancient church, and was publicly read in many churches [EPISTLES, APOSTOLICAL].

1. **CLEOPAS** (Κλεόπας), one of the two disciples to whom Jesus appeared in the way to Emmaus (Luke xxiv. 18). He is not to be con-

founded with the other Cleophas, who was also called Alphæus.

2. CLEOPHAS (Κλωπᾶς), or rather Clopas, who was also called Alphæus, which see.

CLIMATE. [PALESTINE.]

CLOUD. The allusions to clouds in Scripture, as well as their use in symbolical language, must be understood with reference to the nature of the climate, where the sky scarcely exhibits the trace of a cloud from the beginning of May to the end of September, during which period clouds so rarely appear, and rains so seldom fall, as to be considered phenomena—as was the case with the harvest rain which Samuel invoked (1 Sam. xii. 17, 18), and with the little cloud, not larger than a man's hand, the appearance of which in the west was immediately noticed as something remarkable not only in itself, but as a sure harbinger of rain (1 Kings xviii. 44).

As in such climates clouds refreshingly veil the oppressive glories of the sun, clouds often symbolize the Divine presence, as indicating the splendour, insupportable to man, of that glory which they wholly or partially conceal (Exod. xvi. 10; xxiii. 9; xxxiv. 5; xl. 34, 35; Num. xi. 25; xxi. 5; Job xxii. 14; Ps. xviii. 11, 12; xcvi. 2; civ. 3; Isa. xix. 1; Matt. xvii. 5; xxiv. 30, &c.; Acts i. 9; Rev. i. 7; xiv. 14, 16). Somewhat allied to this use is that which makes clouds the symbols of the Divine power (2 Sam. xxii. 12; Ps. lxxviii. 34; lxxxix. 6; civ. 3; Nabum i. 3).

Clouds are also the symbol of armies and multitudes of people (Jer. iv. 13; Isa. lx. 8; Heb. xii. 1). This is often very scientifically explained by the information that clouds are composed of innumerable drops of rain or vapour. This, although true, is certainly not the truth which the Hebrew poets had in view. Any one who has noticed the effect of a large and compact body of men upon the surface of an extensive plain, moving like a cloud in the clear sky, or who has seen a similar body of men upon the side of a distant hill, will find a more obvious source of the comparison.

There are many other dispersed symbolical allusions to clouds in Scripture not coming under these descriptions; but their purport is in every case too obvious to need explanation (see particularly Prov. xvi. 15; Eccles. xii. 2; Isa. iv. 5; xlv. 22; 2 Pet. ii. 17; Jude 12).

CLOUD, PILLAR OF. [EXODUS.]

CNIDUS (Κνίδος), otherwise GNIDUS, a town and peninsula of Doris in Caria, jutting out from the south-west part of Asia Minor, between the islands of Rhodes and Cos. It was celebrated for the worship of Venus (Strabo, xiv. p. 965; Plin. *Hist. Nat.* xxxvi. 15; Hom. *Odys.* i. 30). The Romans wrote to this city in favour of the Jews (1 Macc. xv. 23), and St. Paul passed it in his way to Rome (Acts xxvii. 7).

COAL. It is generally assumed that, in those numerous passages of our version in which the word coal occurs, *charcoal*, or some other kind of artificial fuel, is to be understood; at all events, that the word has not its English meaning. The idea is founded upon the supposition that fossil coal was not known to the ancients as an article of fuel, and especially to the ancient inhabitants of Syria, whose country it is generally imagined did not produce it. It has indeed been strongly maintained that coal has not been used for fuel,

even in England, much more than 400 years notwithstanding the reasons alleged by Horsley and others that the Romans worked coal-mines in this country; and by Whittaker, that it was used as fuel by the Saxons. Truth, however, here, perhaps, as usually, lies in the middle. Although the general use of coal for fuel is even in this country of comparatively recent date, and certainly so in every other, yet the conclusion that it was totally unknown and unemployed for any purpose, either here or in other countries, including even Syria, does not necessarily follow. The existence of coal in Syria is now placed beyond a doubt. Many indications of coal occur in the Lebanon mountains; the seams of this mineral even protrude through the superincumbent strata in various directions. At Cornale, eight hours from Beirut, at 2500 feet above the level of the sea, where the coal-seams are three feet in thickness, a mine is actually being worked by order of Mohammed Ali, in which more than 100 men are employed. The coal is of good quality, and mixed with iron pyrites. In 1837 the quantity of coal extracted was 14,700 cantars of 217 okes, each making about 4000 tons. A furnace for smelting the ore and a railroad to convey the coals to Beirut were then in contemplation. (Elliot, vol. ii. p. 257; and Dr. Bowring's 'Report').

The following passage from the *Περὶ τῶν λίθων* of Theophrastus, proves beyond a doubt, in the opinion of his learned translator and annotator Sir John Hill, that fossil coal was employed at least by 'the smiths,' οἱ χαλκεῖς, in the time of that ancient naturalist. Οὗς δὲ καλοῦσιν εὐθὺς ἄνθρακας, τῶν θρυπτομένων, διὰ τὴν χρειάν, εἰς γέωδεις. ἐκκαίονται δὲ καὶ πυροῦνται καθάπερ οἱ ἄνθρακες. εἰς δὲ περὶ τε τὴν Λιγυστικήν, ὅπου καὶ τὸ ἤλεκτρον, καὶ ἐν τῇ Ἠλείᾳ, βαδίζοντων Ὀλυμπιάζε τῆν δ' ὕρου, οἷς καὶ οἱ χαλκεῖς χράνται, κτ. On this passage Sir John Hill observes, 'The substance here denoted, whatever mistakes there have been among authors since about it, appears to me to be evidently no other than the common pit-coal; and I have made it appear as clearly so in the translation, only by having properly rendered the word ἄνθρακες, the carelessly misunderstanding which word alone has been the occasion of all the erroneous guesses about the substance denoted. The authors of these seem all to have understood the word ἄνθραξ as signifying fossil or pit-coal; and therefore as the author compares the burning of this substance to that, they were necessitated to think of some other substance that he might here mean, as it was impossible he should compare a thing to itself, ἐκκαίονται καθάπερ οἱ ἄνθρακες, evidently, "they kindle and burn like wood coals," or, as we call it, charcoal, for that is the genuine and determinate sense of the word ἄνθραξ in Greek and *carbo* in Latin, as is evident from the other works of Theophrastus, Pliny, and all the older naturalists. Even the more correct of the moderns, when they would express what we call *pit-coal*, the substance here described by the author, never use the words *ανθραξ* or *carbo*, but always *λίθωνανθραξ* or *carbo fossilis* (see Woodward, Charlton, and Merritt). The similar use of this bitumen got it the name of coal, but always with an addition that distinguished it from what was more commonly and properly so called, and expressed its being not of

vegetable but of fossil origin' (London, 1774, pp. 64-66). So clear a testimony to the use of pit-coal by artificers in Greece, nearly 300 years B.C., with the well-ascertained existence of coal in Syria, emerging to the very surface, may, in conjunction with some particulars respecting the mention of coal in the Scriptures, tend to show the possibility that coal, in the proper sense, was not wholly unknown or unemployable by the ancient Hebrews, &c. The Hebrew words most frequently and properly translated coal are two, נחלת and פחם. Though the Hebrews seem to have frequently used the word נחלת in the same generic sense as we do when we say a ton of coals, meaning coals not yet burnt, a pan of coals, meaning coals on fire, and as the Greeks, though not so loosely, apply άνθρακας, and the Romans *carbo*, yet when precision required it, the Hebrews, as well as ourselves and the Greeks and Romans, knew how to express the difference in the case of ignited coals, which they most commonly do by the addition of שן, a distinction preserved in the Septuagint by the word πύρ (though the Septuagint often introduces this word when the sense of the single Hebrew word seems to require it, and generally with great correctness); and which distinction is also generally preserved in the Vulgate by the use of the appropriate word *pruna*:—*Serv. ad Æn.* xi. 788: 'Docet hoc esse discrimen inter *prunam* et *carbonem*, quod, illa accensa sit, hic vero extinctus. Sed etiam dum ardet *carbo* dicitur' (Facciolati). The following classification is offered, comprehending all the instances in which the word נחלת occurs:—First, in its generic and indefinite application, that is, meaning coal whether ignited or not: 2 Sam. xiv. 7, 'they shall quench my coal which is left'; Sept. άνθρακα; Vulg. scintillam; evidently ignited, used tropically for posterity, like 1 Kings xv. 4, and several other passages: Job xli. 21, 'his breath kindleth coals,' άνθρακες, *prunas*, i. e. coals not before ignited: Isa. xlvi. 14, 'not a coal to warm at,' but here the word לחם decides the ignition, άνθρακας πυρός, *prunas*: Ps. xviii. 8, 'coals were kindled at it,' άνθρακες, *carbones succensi sunt*: Ps. cxx. 4, 'with coals of juniper,' Sept. σὺν τοῖς άνθραξι τοῖς ἐρημικοῖς; Vulg. cum carbonibus desolatoris: Prov. vi. 28, English version supplies (hot) coals: Sept. adds πυρός to άνθράκων, *prunas*: Prov. xxv. 22, 'shall heap coals of fire upon his head,' Sept. supplies πυρός, *prunas*: Isa. xliv. 19, 'upon the coals,' άνθράκων, *carbones*: Ezek. xxiv. 11, 'upon the coals,' άνθρακας, *prunas*.

Our second class consists of instances in which the word שן is added, in order to fix the sense of ignition:—Lev. xvi. 12, 'a censer full of burning coals of fire,' άνθράκων πυρός, *prunis*: 2 Sam. xxii. 9, 13, 'coals of fire were kindled at it,' άνθρακες πυρός, *carbones ignis*: Ps. xviii. 12, 'the coals of fire passed,' άνθρακες πυρός, *carbones ignis*: Ps. cxi. 10, 'let burning coals fall on them,' άνθράκες πυρός, *carbones*: Ezek. i. 13, 'coals of fire,' άνθράκων πυρός, *carbonum ignis*: Ezek. x. 2, 'coals of fire,' άνθράκων πυρός, *prunis ignis*.

The other Hebrew word translated coal is פחם. It occurs only three times:—Prov. xxvi. 21, לנחלים פחם, 'as coals are to burning coals, and wood to fire,' &c., Ἐσχάρα άνθραξι, sicut *carbones*

ad *prunas*: here the word פחם plainly means unignited coal (Qu. mineral coal?), as appears from the parallel comparison, and 'as wood to fire.' Isa. xliv. 12, 'the smith worketh in the coals: the Sept. has no corresponding word, but old commentators read ἐν άνθραξι, in *prunis*. Isa. liv. 16, 'the smith that bloweth the coal in the fire,' άνθρακας, *prunas*. From the foregoing analysis it appears that the word נחלת often means coals thoroughly ignited; but פחם, coal before being ignited.

There are several instances in which the word 'coal' in our version is an improper translation. 1 Kings, xix. 6, ענת רצפים, 'a cake baked on the coals,' ἐγκροφίλας, *subcinericius panis*. רצפה here properly means a hot stone (a pavement, Esth. i. 6, and elsewhere), and ענת רצפים properly mean small cakes baked under ashes—a common food to this day among the Orientals, especially when travelling [BREAD]. רצה is also a hot stone thrown into milk or broth in order to heat it (*Gesenius*). Another mis-translation occurs (Hab. iii. 5), 'burning coals went forth at his feet' in the margin 'burning diseases' (Deut. xxx. 24). The Sept. varies widely; and the Vulgate still more widely—'egredietur diabolus,' which is, however, explained as *pestis* by the commentators. Another mis-translation is (Lam. iv. 8), 'Their visage is blacker than a coal;' margin, 'darker than blackness; יסוף כשחור, ὑπερ άνθράκη, *super carbones*. Another mis-translation occurs (Cant. viii. 6), 'the coals thereof are coals of fire; רשפיה רשפי שן, περίπτερα αὐτῆς, περίπτερα πυρός, Ald. άνθρακες πυρός, ut *lampades ignis*. A questionable translation occurs (Is. vi. 6), 'a live coal, רצפה, άνθρακα πυρός, *calculus*; but the Rabbis render it 'coal.' The instances of the word coal in the New Testament remain to be noticed:—(John xviii. 18), 'a fire of coals,' άνθρακιά, ad *prunas*. The word here evidently means a mass of live charcoal (so Suid. άνθρακιά πεφυρακτωμένοι *anthracas*, who give an adage which makes a plain difference—μη τὴν φέγγαν φέγγαν, εἰς άνθρακίαν πέσης, which may be exactly paralleled by a well-known English adage). (Ecc. viii. 10; xi. 32, occur in the same sense in the Apocrypha.) From the foregoing analysis the following passages are selected as countenancing the idea that the ancient Hebrews were acquainted with natural coal. In the sublime description of the leviathan (Job xli. 21), 'his breath kindleth coals,' the representation, though highly hyperbolic, is of course supported by a consistency and proportion of ideas. But to suppose that the word here rendered coals means any kind of artificial fuel, reduces the whole scene to an intolerable bathos; whereas if we refer the word to the natural production, it is admirably preserved. The association of charcoal with a creature which 'makes the deep to boil like a caldron,' and which, when on land, 'is king of the children of pride,' is too incongruous to be attributed to the sublimest of ancient poets; but it is a conception worthy of his powers to represent a mass of coal ignited by the breath of leviathan. A similar remark is due to the magnificent representation (2 Sam. xxii. 9, 13, and Ps. xviii. 8), 'through the brightness before Him were coals of fire kindled.' This oft-repeated expression suits only, but it suits well, the idea of

a stratum of mineral matter as being ignited by the material splendors attending on the Divine appearance and interposition.—J. F. D.

COCK (*ἀλέκτωρ*; in Hebrew possibly *גבר* *Gaber*, if Jerome's version of Isa. xxii. 17, 18 be correct: our version of the passage is obscure). It is somewhat singular that this bird and poultry in general should not be distinctly noticed in the Hebrew Scriptures; especially as rearing gallinaceous fowls was an object of considerable economical importance in Egypt, and their flesh one of the principal resources for the table in every part of Southern and Western Asia. It is true, the date when the practice of obtaining them by artificial heat commenced in Egypt is sufficiently disputable, and birds of the genus *Gallus*, properly so called, are not indigenous in Western Asia, but belong in their original condition to lower India, Indo-China, and the great islands of Austral-Asia. They were, it may be surmised, unknown in Egypt when the Mosaic law was promulgated, and, though imported soon after, they always remained in an undetermined condition, neither clean nor unclean, but liable to be declared either by decisions swayed by prejudice, or by fanciful analogies; or perhaps chiefly the latter; because poultry are devourers of unclean animals, scorpions, scolopendra, small lizards, and young serpents of every kind.

But although rearing of common fowls was not encouraged by the Hebrew population, it is evidently drawing inferences beyond their proper bounds, when it is asserted that they were unknown in Jerusalem, where civil wars, and Greek and Roman dominion, had greatly affected the national manners. The excess of pharisaical punctiliousness is evidence that opinions and customs widely opposed to their own were prevalent, and, in the dependant state of the nation, were openly professed even by the numerous resident foreigners, the Pagan garrisons, and by many Jews, under the influence of the Epicurean philosophy.

In the denials of Peter, described in the four Gospels, where the cock-crowing is mentioned by our Lord, the words are plain and direct, not we think admitting of cavil, or of being taken to signify anything but the real voice of the bird, the *ἀλεκτοροφωνία*, as it is expressed in Mark xiii. 35, in its literal acceptation, and not as denoting the sound of a trumpet, so called, because it proclaimed a watch in the night; for, to what else than a real hen and her brood does our Saviour allude in Luke xiii. 34, where the text is proof that the image of poultry was familiar to the disciples, and consequently that they were not rare in Judæa? To the present time in the East, and on the Continent of Europe, this bird is still often kept, as amongst the Cæltæ (Cæsar, *Bell. Gall.* iv. 12), not so much for food as for the purpose of announcing the approach and dawn of day.—C. H. S.

COCKATRICE. [SERPENT.]

COCKCROWING. The cock usually crows several times about midnight, and again about break of day. The latter time, because he then crows loudest, and his 'shrill clarion' is most useful by summoning man to his labours, obtained the appellation of the cockcrowing emphatically, and by way of eminence; though sometimes the distinctions of the *first* and *second* cockcrowing

are met with in Jewish and heathen writers (Bochart, vol. iii. p. 119). These times, and these names for them, were, no doubt, some of the most ancient divisions of the night adopted in the East, where 'the bird of dawning' is most probably indigenous. The latter *ἀλεκτοροφωνία* was retained even when artificial divisions of time were invented. In our Lord's time the Jews had evidently adopted the Greek and Roman division of the night into four periods, or watches; each consisting of three hours; the first beginning at six in the evening, *ἐν τῇ δευτέρᾳ φυλακῇ, καὶ ἐν τῇ τρίτῃ φυλακῇ* (Luke xii. 38); *τετάρτῃ δὲ φυλακῇ τῆς νυκτός* (Matt. xiv. 25; Mark vi. 48). These watches were either numbered first, second, third, and fourth, as now specified, or were called *ὀψέ, μεσονύκτιον, ἀλεκτοροφωνία, πρωί*. These are all mentioned (Mark xiii. 35; Veget. *Re Milit.* iii. 8, 'In quatuor partes ad clepsydram sunt divisæ vigiliæ, ut non amplius quam tribus horis nocturnis, necesse est vigilare,' Censorin, *de Die Natal.* Περὶ φ. τετάρτην, vide Joseph. *Antiq.* xviii. 9, C. Περὶ φ. δευτέραν, Diod. Sic. 18. 40; Xen. *Anab.* iv. 1. 5).

It has been considered a contradiction that Matthew (xxvi. 34), records our Lord to have said to Peter, *πρὶν ἀλέκτορα φωνῆσαι, τρίς ἀπαρῆσθαι*, whereas St. Mark (xiv. 30), says, *πρὶν ἢ εἰς φωνῆσαι*. But Matthew, giving only the *general sense* of the admonition (as also Luke xxii. 34; John xiii. 38), evidently alludes to that only which was *customarily* called the cockcrowing, but Mark, who wrote under Peter's inspection, more accurately recording *the very words*, mentions the *two* cockcrowings (Wetstein on Mark xiv. 30 Scheuchzer, *Phys. Sacr.* on Mark xiii. 35. Whitby's *Note* on Matt. xxvi. 34). Another objection to this part of the Evangelical history has been founded upon an assertion of the Mischna.

אין מנדלן הרנגולין, vii. 7, *אין מנדלן הרנגולין, בירושלם מפני קדושים*. They do not breed cocks at Jerusalem because of the holy things': because it is interpreted, cocks turn up the dung-hills, and set free the reptiles by which the sacrifices might be polluted which were eaten as food; and that, consequently, Peter could not hear one crow. But this is sufficiently answered in the preceding article. Even the traditions themselves on this subject are not uniform; witness the story in *Eruvin*, p. 26. 1, of a cock which killed a child, and was stoned by order of the council. Other instances are given by Reland, which show that the cock might crow, though not *in the city*, and yet be heard by Peter in the stillness of the night, especially as the palace of Caiaphas stood on an elevated situation, at the distance of scarcely 400 yards from the city walls. At the same time the word *ἀλέκτωρ*, being everywhere *anarthrous* in the New Testament (except Luke xxii. 60, where, however, the article is rejected by Griesbach upon the authority of a multitude of MSS.), it may be inferred from this indefiniteness, that cocks, if at all tolerated in Jerusalem, were far less common than with us. *Δίς*, in Mark, is for *ἐκ δευτέρου*, and *τρίς* is explained, *semel iterumque*, plus simpliciter vice, a certain for an uncertain number, as 1 Cor. xii. 28. So Eusth. *ap. Schl. Lex.* says *τρίς* is for *πολλάκις*. Thus the seeming contradiction, at least, between Mark and the other Evangelists is removed (Lightfoot, *Hor. Heb.*; Bynæus

Je mortz Christi, ii. 6; Reland, *Oyat. de Gall. Centu*; Altmann *De Gallicin*; Biel, *Animad. ad J. G. Altmann*; Ansaldo *Comment.*, the four last in Ugolini, *Thesaur.* vol. xxvii. Ven. 1763; Adam's *Roman Antiq.* p. 33; Winer, *Biblisches Real-Wörterbuch*, Leipzig, 1833, art. Hühner.—

COCKLE. [BESHA.]

CŒLESYRIA (*ἡ κοίλη Συρία*), the hollow Syria. This name, which is evidently of Grecian origin in the times of the Seleucidæ, was originally applied to the valley lying between the mountain-ranges of Libanus and Anti-Libanus. It was also used to denote the whole tract of country (with the exception of Judæa and Phœnicia) reaching from Seleucis to Arabia and the confines of Egypt (Strabo, xvi. 2, vol. iii. p. 365, ed. Tauch.; Polyb. *Hist.* v. 80, § 3). In the time of David, Cœlesyria was probably included in 'Syria of Damascus,' which was conquered by that monarch (2 Sam. viii. 6), but recovered from Solomon by Rezon the son of Eliadah (1 Kings xi. 24). The possession of it was an object of many struggles between the Seleucidæ and the kings of Egypt (Polyb. i. 3; ii. 74; iii. 1; v. 40; xvi. 39; xxvii. 17). *Amyce*, the name of the plain through which the Orontes flowed (*τὸ Ἀμύκης πεδίου*, Polyb. v. 59), is derived by Bochart from the Syriac *אמיצה* *Amica*, which means *deep*, and is nearly synonymous with the Greek *Cœle* (vid. *Geogr. Sac. Pars poster.* i. 1.) The same learned writer supposes that Syrophœnicia is the same as Cœlesyria. Scythopolis and Gadara are mentioned by Josephus as cities of Cœlesyria (*Antiq.* xiii. 13 § 2, § 3). The name frequently occurs in the Apocrypha (1 Macc. x. 69; 2 Macc. viii. 8; x. 11; Esdr. ii. 17, 24; iv. 48; vii. 1); in Esdr. vi. 3, it is called simply Syria. Under the emperor Diocletian, Phœnicæ and Cœlesyria formed one province, called Phœnicia Libanica. Under the present Turkish government the western part of Cœlesyria is in the Pashalic of Saïde, and the eastern in the Pashalic of Damascus.—J. E. R.

COFFIN. [BURIAL.]

COLONY (*Κολώνια*). This distinction is applied to Philippi in Macedonia (Acts xvi. 12). Augustus Cæsar had deported to Macedonia most of the Italian communities which had espoused the cause of Antony; by which means the towns of Philippi, Dyrrachium, &c., acquired the rank of Roman colonies (Dio Cass. p. 455). They possessed the *jus coloniarium* (Plin. *Hist. Nat.* v. 1), i. e. so-called *jus Italicum* (*Digest. Leg.* viii. 8), consisting, if complete, in a free municipal constitution, such as was customary in Italy, in exemption from personal and land taxes, and in the commerce of the soil, or the right of selling the land.

COLOSSÆ (*Κολοσσαί*), a city of Phrygia, on the river Lycus (now Gorduk), not far from its confluence with the Mæander, and near the towns of Laodicea, Apamea, and Hieropolis (Col. ii. 1; iv. 13, 15; comp. Plin. *Hist. Nat.* v. 41; Strabo, xii. p. 576). A Christian church was formed here very early, probably by Epaphras (Col. i. 7; iv. 12, sq.), consisting of Jews and Gentiles, to whom Paul, who does not appear to have ever visited Colossæ in person (Col. ii. 1) addressed an Epistle from Rome. Not long after, the town was, together with Laodicea and Hierapolis, de-

stroyed by an earthquake. This, according to Eusebius, was in the ninth year of Nero; but the town must have been immediately rebuilt, for in his twelfth year it continued to be named as a flourishing place (Nicet. *Chron.* p. 115). It still subsists as a village named Khonas. The

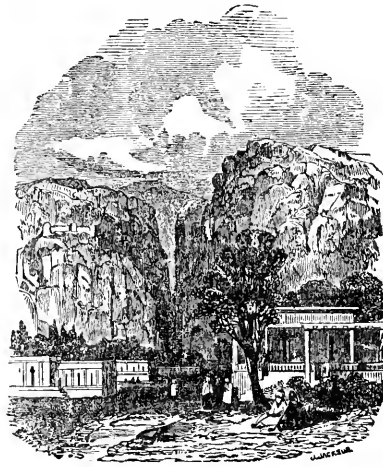

234. [Colossæ: Khonas.]

nuge range of Mount Cadmus rises immediately behind the village, close to which there is in the mountain an immense perpendicular chasm, affording an outlet for a wide mountain torrent. The ruins of an old castle stand on the summit of the rock forming the left side of this chasm. There are some traces of ruins and fragments of stone in the neighbourhood, but barely more than sufficient to attest the existence of an ancient site; and that this site was that of Colossæ is satisfactorily established by the Rev. F. V. J. Arundell, whose book (*Discoveries in Asia Minor*) contains an ample description of the place.

COLOSSIANS, EPISTLE TO THE.—That this Epistle is the genuine production of the apostle Paul is proved by the most satisfactory evidence, and has never indeed been seriously called in question. It is less certain, however, *when* and *where* it was composed by him. The common opinion is that he wrote it at Rome during his imprisonment in that city (Acts xviii. 16, 30). Erasmus, followed by others, supposes that Ephesus was the place at which it was composed; but this suggestion is obviously untenable from its incompatibility with the allusions contained in the Epistle itself to the state of trouble and imprisonment in which the Apostle was whilst composing it (i. 24; iv. 10, 18). In Germany, the opinions of theologians have been divided of late years between the common hypothesis and one proposed by Dr. David Schulz in Ullmann and Umbreit's *Theologische Studien und Kritiken* for 1829, s. 612 ff., viz., that this Epistle, with those to the Ephesians and Philemon, was written during the Apostle's two years' imprisonment at Cæsarea previous to his being sent to Rome. This opinion has been adopted and defended by Schott, Böttger, and Wiggers, whilst it has been opposed by Neander, Steiger, Harless, Rückert,

Credner, and others. The following is a synopsis of the leading arguments in favour of this opinion, and of the counter-arguments of those who oppose it:—1. It is highly improbable that Paul would allow two years of easy imprisonment (Acts xxiv. 23-27) to pass away without writing to some of the churches at a distance, especially as he tells us that upon him 'came daily the care of all the churches' (2 Cor. xi. 28), and as we find that he secured time for this even when most actively employed in his public apostolic labours. To this it is replied that, admitting the facts here assumed, they only prove that Paul might have employed himself during these two years in epistolary correspondence with distant churches, but afford no certain evidence that he really did so, far less that he wrote then the very epistles in question. 2. These epistles bear evident marks of having been written in consequence of communications made personally to Paul by parties connected with the churches to which they were addressed; and there is greater probability of his receiving such communications at Cæsarea than at Rome, especially during the earlier part of his residence there, to which these epistles (if written at Rome) must be ascribed. But it is replied to this that, distant as Rome was from the churches of Asia Minor, there is nothing unlikely in the supposition that Epaphras and others may have undertaken a journey thither to consult the Apostle about the state of these churches, threatened as they were with danger; and, for anything we know to the contrary, many of the Asiatic Christians may have had occasion to be at Rome at any rate on affairs of their own. 3. There is no small difficulty in supposing that in the early part of the Apostle's residence at Rome, all the parties mentioned in these epistles, viz., Timothy, Aristarchus, Mark, Jesus-Justus, Epaphras, Luke, Demas, Onesimus, Tychicus, should be found there with him, especially as we are told (Acts xxvii. 2) that only Aristarchus accompanied Paul and Luke from Cæsarea, and as, in the epistles known to have been written from Rome, only two of the parties above-mentioned, Timothy and Luke, are referred to as with the Apostle (Phil. i. 1; ii. 19; 2 Tim. iv. 11); whilst, on the other hand, from Acts xx. 4, we learn that some, at least, of these parties were with Paul at Cæsarea. In answer to this, it is said that it does not appear other than natural that Paul should have gathered around him in his imprisonment those young men who had elsewhere been the companions and instruments of his operations, and have used them for the purpose of maintaining a continual intercourse with distant churches according to their circumstances and wants. 4. The appearance of Onesimus, the slave of Philemon, at the place where Paul was, *very soon* (*πρὸς ἔργον*) after he had left his master at Colossæ (Philem. ver. 15), agrees better with the supposition that Paul was at Cæsarea, than with the supposition that he was at Rome. To this it is replied, that Rome was the most likely of all places for a fugitive slave to betake himself to, and that with respect to the expression *πρὸς ἔργον*, it is so vague, and is used so obviously as an antithesis to *αἰώνιον* in the same verse, that nothing certain can be argued from it. 5. The request of Paul to Philemon (ver. 22), that he would provide him a lodging at Colossæ,

as he hoped to visit that place shortly, agrees better with the supposition that this epistle was written at Cæsarea, whilst yet hopes might be entertained of his liberation, than that it was written at Rome, when his expectations of freedom must have become faint, and whence, according to his avowed purpose (Rom. xv. 28), he was more likely, in case of being liberated, to travel westwards into Spain, than to return to Asia. The answer to this is, that though the Apostle had originally designed to journey from Rome to Spain, the intelligence he received of the state of things in the churches of Asia Minor may have determined him to alter his resolution; and upon the whole, we know so little of the Apostle's relations during his imprisonment at Rome, that it is not safe to build much upon any such allusions (Schulz, *loc. cit.*; Neander, *Hist. of the Apostolic Churches*; Eng. Transl. vol. i. p. 373; Credner, *Einleit. in das N. T.* s. 390; Schott, *Isagoge in N. T.* § 66; Steiger, *Der Br. Pauli an d. Kolosser u. s. w.* s. 335; Harless, *Comment. üb. d. Br. Pauli an d. Epheser. u. s. w.* s. 63; Rückert, *Der Br. Pauli an d. Ephes. u. s. w.* s. 305; Böttger, *Beiträge, &c.* 3 Abth.) In a very able article in a recent number of the *Studien und Kritiken*, the whole question has been subjected to a new investigation by Dr. Julius Wiggers of the University of Rostoch, who comes to the conclusion, that of the facts above appealed to, none can be regarded as *decisive* for either hypothesis. He inclines, however, to the opinion of Schulz, chiefly on the grounds that Paul, in writing to the Ephesians, makes no mention of Onesimus, who accompanied Tychicus, the bearer of his epistle to that church, and that *both* in this epistle and in that to the Colossians, he states that he had sent Tychicus *εἰς αὐτὸ τοῦτο, ἵνα γνῶτε τὰ περὶ ἡμῶν, καὶ παρακαλέσῃ τὰς καρδίας ὑμῶν* (Eph. vi. 22; Col. iv. 8 [according to the best MSS.]) The former of these, Wiggers thinks, can be accounted for only on the supposition that Tychicus and Onesimus having to set out from Cæsarea, would reach Colossæ *first*, where the latter would tarry, so that he did not *need* to be commended to the church at Ephesus; the latter of these, he thinks, indicates that the place whence Tychicus was to set out was one from which he might proceed *either* to Colossæ or to Ephesus first, not one from which he had, as a mere matter of course, to pass through Ephesus in order to reach Colossæ; and hence he infers that Cæsarea, and not Rome, was the place whence these epistles were despatched (*Stud. u. Krit.* 1541, s. 436). We cannot say that these two considerations appear to us so cogently decisive of this question as they do to Dr. Wiggers. For, not to insist upon the obvious incoherence of the one with the other, it does not by any means appear *necessary* that Paul should have commended Onesimus to the care of the church at Ephesus in case of his passing through that city, seeing he was the companion of one whose introduction would be enough to secure their kind offices on his behalf; and surely there is nothing improbable in the supposition that Paul should have sent Tychicus on the same errand both to Colossæ and to Ephesus, even though he must needs pass through the one to reach the other. In a case where the internal evidence produces so exact an equipoise, the testimony of tradition may fairly be permitted to

settle the question; and this is unequivocally in favour of the opinion that these epistles were written from Rome during the earlier part of the Apostle's confinement there.

In what order these three epistles were written, it is not possible clearly to determine. Between that to the Colossians and that to the Ephesians the coincidences are so close and numerous (see Horne's *Introduction*, vol. iv. p. 381) that the one must have been written immediately after the other, whilst the mind of the Apostle was occupied with the same leading train of thought. By the greater part the priority is assigned to the Epistle to the Colossians; though for this no more convincing argument has been adduced than that which Harless, Steiger, and Wiggers have urged, viz.: that this supposition best explains the force of the conjunction *καὶ* before *ὑμεῖς* in Eph. vi. 21. The expression 'that you also may know, &c.' seems to imply that the same knowledge had been conveyed to others; and as Paul makes the same statement to the Colossians, but without the *καὶ ὑμεῖς*, it is argued that the recollection of having made that statement being in his mind when he was writing to the Ephesians, he expressed himself in the manner above noted. This, it must be allowed, is not very satisfactory, for, as an argument, it holds good only on the supposition either that the Epistle to the Colossians was to be read also and first by the Ephesians, or that the Apostle fell unconsciously into the mistake of supposing that because what he had written to the Colossians was fresh in his own recollection, it must be as well known to the Ephesians. The Epistle to Philemon being a mere friendly letter, intended chiefly to facilitate the reconciliation of Onesimus to his master, was probably written immediately before the departure of the party by whom it was to be carried.

The Epistle to the Colossians was written, apparently, in consequence of information received by Paul through Epaphras concerning the internal state of their church (i. 6-8). Whether the Apostle had ever himself before this time visited Colossæ is matter of uncertainty and dispute. From ch. ii. 1, where he says, 'I would that ye knew what great conflict I have for you and for them at Laodicea, and for as many as have not seen my face in the flesh,' &c., it has by some been very confidently concluded that he had not. To this it is replied by Theodoret, Lardner, and others, that Paul does not intend to include the Colossians and Laodiceans among those who had not seen his face, but specifies the latter as a distinct class; as is evident, they think, from his using the *third* person in ver. 2. This latter consideration, however, is of no weight, for the use of the third person here is easily accounted for on the principle that the pronoun takes the person of the nearer noun rather than that of the more remote (cf. Gal. i. 8); and it certainly would be absurd to maintain that all contained in the second verse has no relation to the Colossians and Laodiceans, notwithstanding the reference to them in ver. 1, and again in ver. 4. As respects the words in ver. 1, they will, in a mere philological point of view, bear to be understood in either way. It has been urged, however, that when, in ver. 5, the Apostle says, 'though I am absent in the flesh, yet am I with you in the spirit,' &c., his language is strongly indicative of his having formerly been

amongst the Colossians, for the verb *ἀπέμει* is used properly only of such absence as arises from the person's *having gone away* from the place of which his absence is predicated. In support of the same view have been adduced Paul's having twice visited and gone through Phrygia (Acts xvi. 6; xviii. 23), in which Colossæ was a chief city; his familiar acquaintance with so many of the Colossian Christians, Epaphras, Archippus, Philemon (who was one of his own converts, Phil. 13, 19), and Apphia, probably the wife of Philemon [ΑΡΡΗΙΑ]; his apparent acquaintance with Onesimus, the slave of Philemon, so that he recognised him again at Rome; the cordiality of friendship and interest subsisting between the Apostle and the Colossians as a body (Col. i. 24, 25; ii. 1; iv. 7, &c.); the Apostle's familiar acquaintance with their state and relations (i. 6; ii. 6, 7, &c.); and their knowledge of so many of his companions, and especially of Timothy, whose name the Apostle associates with his own at the commencement of the epistle, a circumstance which is worthy of consideration from this, that Timothy was the companion of Paul during his first tour through Phrygia, when probably the Gospel was first preached at Colossæ. Of these considerations it must be allowed that the cumulative force is very strong in favour of the opinion that the Christians at Colossæ had been privileged to enjoy the personal ministrations of Paul. At the same time, if the Colossians and Laodiceans are not to be included among those of whom Paul says they had not seen his face, it seems unaccountable that in writing to the Colossians he should have referred to this class at all. If, moreover, he had visited the Colossians, was it not strange that he should have no deeper feeling towards them than he had for the multitudes of Christians scattered over the world whose faces he had never seen? In fine, as it is quite possible that Paul may have been twice in Phrygia without being once in Colossæ, is it not easy also to account for his interest in the church at Colossæ, his knowledge of their affairs, and his acquaintance with individuals among them, by supposing that members of that church had frequently visited him in different places, though he had never visited Colossæ? (Lardner's *Credibility*, *Suppl.*, ch. xiv.; Schulz in *Stud. und Krit.*, Jahrg. 1829, s. 536; Wiggers, *Ibid.* Jahrg. 1838, s. 165; Steiger, *Collosserbr.* s. 200; Whitby, *Pref.* to *Coloss.*)

A great part of this Epistle is directed against certain false teachers who had crept into the church at Colossæ. To what class these teachers belonged has not been fully determined. Heinrichs (*Nov. Test. Koptian.* vol. vii. part ii. p. 156) contends that they were disciples of John the Baptist. Michaelis and Storr, with more show of reason, conclude that they were Essenes. Hug (*Introd.* vol. ii. p. 449, E. T.) traces their system to the Magian philosophy, of which the outlines are furnished by Iamblichus. But the best opinion seems to be that of Neander (*ibid.* cit. i. 374, ff.), by whom they are represented as a party of speculatists who endeavoured to combine the doctrines of Oriental theosophy and asceticism with Christianity, and promised thereby to their disciples a deeper insight into the spiritual world, and a fuller approximation to heavenly purity and intelligence than simple Christianity could yield. Against this party the Apostle argues by reminding the Co-

Colossians that in Jesus Christ, as set before them in the Gospel, they had all that they required—that he was the image of the invisible God, that he was before all things, that by him all things consist, that they were complete in him, and that he would present them to God holy, unblamable, and unreprouvable, provided they continued steadfast in the faith. He then shows that the prescriptions of a mere carnal asceticism are not worthy of being submitted to by Christians; and concludes by directing their attention to the elevated principles which should regulate the conscience and conduct of such, and the duties of social and domestic life to which these would prompt.

In the conclusion of the Epistle, the Apostle, after sending to the Colossians the salutations of himself and others who were with him, enjoins the Colossians to send this Epistle to the Laodiceans, and that they likewise should read τὴν ἐκ Λαοδικείας. It is disputed whether by these concluding words Paul intends an Epistle from him to the Laodiceans or one from the Laodiceans to him. The use of the preposition ἐκ favours the latter conclusion, and this has been strongly urged by Theodoret, Chrysostom, Jerome, Philastrius, Œcumenius, Calvin, Beza, Storr, and a multitude of other interpreters. Winer, however, clearly shows that the preposition here may be under the law of attraction, and that the full force of the passage may be thus given—'that written to the Laodiceans and to be brought from Laodicea to you' (*Grammatik d. Neutestamentl. Sprachidioms*, s. 434, Leipzig, 1830). It must be allowed that such an interpretation of the Apostle's words is in itself more probable than the other; for supposing him to refer to a letter from the Laodiceans to him, the questions arise, How were the Colossians to procure this unless he himself sent it to them? And of what use would such a document be to them? To this latter question it has been replied that probably the letter from the Laodiceans contained some statements which influenced the Apostle in writing to the Colossians, and which required to be known before his letter in reply could be perfectly understood. But this is said without the slightest shadow of reason from the Epistle before us; and it is opposed by the fact that the Laodicean epistle was to be used by the Colossians after they had read that to themselves (ὄραν ἀναγνώσθη, κ. τ. λ.). It seems, upon the whole, most likely that Paul in this passage refers to an epistle sent by him to the church in Laodicea at the same time with that to the church at Colossæ. It is probable also that this Epistle is now lost, though the suggestion of Grotius that it was the same with the Canonical Epistle to the Ephesians has found some advocates [EPHESIANS, EPISTLE TO THE]. The extant epistle to the Laodiceans is on all hands allowed to be a clumsy forgery (Michaelis, *Introd.* vol. iv. p. 124, ff.; Hug, *Introd.* ii. 436; Steiger, *Colosserbr. in loc.*; Heinrichs, *in loc.*; Raphael, *in loc.*).

Besides the commentaries mentioned in this article the following are deserving of notice:—Davenant, *Expositio Ep. D. Pauli ad Colossenses*, Cantab. 1627, fol., translated by the Rev. J. Allport, 2 vols. 8vo. Lond. 1831-32; Böhmer, *Isaogoe in Ep. a Paulo ad Coloss. datam*, &c. 8vo. Berol. 1829; Bähr, *Commentar üb. d. Dr. Pauli an die Kolosser* 8vo. Basel, 1830; Storr,

Interpretatio Ep. ad Coloss. (in *Opusc. Acad.* 7. 120).—W. L. A.

COMFORTER. [PARACLETUS.]

COMMENTARY. In the discussion of this subject we propose to pursue the following arrangement:—

1. To inquire what is meant by commentary.
2. To notice different kinds of commentary.
3. To mention the prominent defects of existing commentaries.
4. To review the leading and best known commentaries.

1. By *commentary*, in its theological application, is usually meant an exhibition of the meaning which the sacred writers intended to convey; or a development of the truths which the Holy Spirit willed to communicate to men for their saving enlightenment. This is usually effected by notes more or less extended—by a series of remarks, critical, philological, grammatical, or popular, whose purport is to bring out into view the exact sentiments which the inspired authors meant to express. The ideas contained in the Old and New Testaments are thus transferred into other languages, and rendered intelligible by the help of oral or written signs. There is a high and holy meaning in the words of holy men who spake as they were moved. To adduce this in a perspicuous form is the important office of the commentator. As there never has been, and from the nature of the case there never can be, a universal language, God selected for the revelation of his will those languages which were in all respects the fittest media for such a purpose. Hence arises the necessity of transplanting from these individual dialects the momentous truths they were selected to express; and of clothing in the costume of various people, as far as that costume can be adapted to such an object, the precise sentiments which were in the minds of the inspired writers. It is true that this can only be imperfectly done, owing to the various causes by which every language is affected; but the *substance* of revelation may be adequately embodied in a great variety of garb. The truths that make wise unto salvation are capable of being fairly represented in every tongue and dialect under heaven. There is an adaptation in their nature to the usage of every language that can possibly arise. The relation of immortal beings to their great Creator is every where the same; and the duties consequent upon such a relation are also identical. Their wants and necessities, too, are essentially alike. Hence there is a peculiar fitness in divine truth for appearing without injury in the linguistic costumes of different tribes.

The characteristics of commentary are,—

(a.) An elucidation of the meaning belonging to the words, phrases, and idioms of the original.

The signification of terms is generic or specific. A variety of significations also belongs to the same term, according to the position it occupies. Now a commentary points out the particular meaning belonging to a term in a particular place, together with the reason of its bearing such a sense. So with phrases. It should likewise explain the construction of sentences, the peculiarities of the diction employed, the difficulties belonging to certain combinations of words, and the mode in which they affect the general meaning. But this is only a small part of the business

belonging to a commentator. He may be able to unfold the significations of words with discriminating nicety; with the genius of language he may be familiar; he may clearly perceive all its idioms, and rightly apprehend its difficult phrases. In short, as far as verbal criticism is concerned, he may be a consummate master, while yet he may prove an indifferent commentator. True commentary embraces much more than an acquaintance with isolated words and phrases, or with the grammatical principles of the Hebrew and Greek languages. It fills a more extended and elevated sphere than simple philology. It takes a higher range than grammatical minutæ or rhetorical adjustment. These, indeed, form one of its elements, but they are far from being the only feature by which it is distinguished.

(b.) Another characteristic of commentary is an exhibition of the writer's scope, or the end he has in view in a particular place. It ascertains the precise idea he intended to inculcate in a given locality, and how it contributes to the general truth enforced. Every particle and word, every phrase and sentence, forms a link in the chain of reasoning drawn out by an inspired author—a step in the progress of his holy revelations. It is therefore essential to perceive what contribution it makes to the import of an entire passage, whether in the way of enriching or qualifying the sentiments embodied. A commentary should thus exhibit the design of a writer in a certain connection,—the arguments he employs to establish his positions, their coherence with one another, their general harmony, and the degree of importance assigned to them. The drift of a discourse should never be lost sight of, else an author will be misunderstood and misinterpreted.

(c.) In addition to this, the train of thought or reasoning pursued throughout an entire book or epistle, the various topics discussed, the great end of the whole, with the subordinate particulars it embraces, the digressions made by the writer,—these, and other particulars of a like nature, should be pointed out by the true commentator. The connection of one argument with another, the consistency and *ultimate* bearing of all the statements advanced—in short, their various relations, as far as these are developed or intimated by the author, should be clearly apprehended and intelligently stated. There is a plan or purpose that pervades every book, epistle, or prophecy of the sacred writers; a plan which does not, indeed, wholly exclude, but which usually takes precedence of, other objects to which the book may be subservient. To trace such a plan, as it is carried out by the original writer, and to unfold the precise mode in which it promotes the highest interests of mankind, is one of the chief characteristics of commentary.

(d.) Another characteristic of commentary is, that it presents a comparison of the sentiments contained in one book, or one entire connected portion of Scripture, with those of another, and with the general tenor of revelation. A beautiful harmony pervades the Bible. Diversities, indeed, it exhibits, just as we should expect it *à priori* to do; it presents difficulties and mysteries which we cannot fathom; but, with this variety, there is a uniformity worthy of the wisdom of God. All his works are distinguished by the same beautiful

arrangement; and the revelation of his will forms no exception. A commentator should therefore bring into juxtaposition the various portions of the divine word, and point out their divine symmetry. He should be able to account for diversities of sentiment, in reference to the same topic, that appear in the pages of books written at different periods, and addressed to individuals or communities whose circumstances, intellectual and physical, were dissimilar. An exposition that fails to do this is deficient in one of its highest qualities. Without it, religious truth will be seen in disjointed fragments; no connected system, compact and harmonious in its parts, will meet the eye. The adaptation of the entire scheme of revelation to the salvation of mankind will be dimly apprehended, while there is no comprehensive survey of its fair proportions.

From what has been stated in regard to the constituents of commentary, it will also be seen that it differs from *translation*. The latter endeavours to find in another language *equivalent terms* expressive of the ideas which the words of the Hebrew and Greek languages were framed to convey. It seeks to embody the same sentiments as are contained in the Scriptures, by means of phraseology closely corresponding in its symbolical character to the diction of the Bible. It is easy to see, however, that in many cases this cannot be done, and that in others it can be effected very imperfectly. There are and must be a thousand varieties of conception expressed in the original languages of Scripture, of which no other can afford an adequate representation. The inhabitants of the countries where the sacred books were written lived amid circumstances in many respects diverse from those of other people. These circumstances naturally gave a colouring to their language. They affected it in such a way as to create terms for which there are no equivalents in the languages of tribes who are conversant with different objects, and live amid different relations. Translation fails in numerous instances, just because the language of one people contains words and idioms to which that of none other presents fit counterparts. In such a case, no expedient is left but *circumlocution*. By the help of *several phrases*, we must try to approximate at least the sentiment or shade of thought which the inspired writers designed to express. Where *exact representatives* cannot be found, we bring together *various terms* which may give as vivid a representation of the original as can be effected through the medium of the language in which the interpretation is given. *Commentary* is thus more diffuse than *translation*. Its object is not to find words in one language corresponding to those of the original languages of the Scriptures, or nearly resembling them in significance, but to set forth the meaning of the writers in notes and remarks of considerable length. *Paraphrase* occupies a middle place between translation and commentary; partaking of greater diffuseness than the former, but of less extent than the latter. It aims at finding equivalent terms to those which the sacred writers employ, accompanied with others that appear necessary to fill up the sense, or to spread it out before the mind of the reader in such a form as the authors themselves might be supposed to have employed in reference to the

people to whom the paraphrast belongs. *Scholia* differ from commentary only in brevity. They are short notes on passages of Scripture. Sometimes difficult places alone are selected as their object; at other times they embrace continuously an entire book. In every case *brevity* is, or ought to be, their distinguishing feature.

2. There are two kinds of commentary which we shall notice, viz. the *critical* and the *popular*. The former contains grammatical and philological remarks, unfolds the general and special significations of words, points out idioms and peculiarities of the original languages, and always brings into view the Hebrew or Greek phraseology employed by the sacred writers. It dilates on the peculiarities and difficulties of construction which may present themselves, referring to various readings, and occasionally bringing into comparison the sentiments and diction of profane writers where they resemble those of the Bible. In a word, it takes a wide range, while it states the processes which lead to results, and shrinks not from employing the technical language common to scholars. In this way the meaning of the original is brought out. Extended dissertations are sometimes given, in which the language is made the *direct subject* of examination, and the aid of lexicons and grammars called in to support or confirm a certain interpretation. *Popular* commentary states in perspicuous and untechnical phraseology the sentiments of the holy writers, usually without detailing the steps by which that meaning has been discovered. It leaves philological observations to those whose taste leads them to such studies. All scientific investigations are avoided. Its great object is to present, in an *attractive form*, the thoughts of the sacred authors, so that they may vividly impress the mind and interest the heart. It shuns all peculiarities that might repel the simple-minded, reflecting reader of the Bible, and endeavours to adduce the truth of God without minute details or tedious digressions. It avoids every thing that a reader unacquainted with Hebrew and Greek would not understand; and occupies itself solely with the *theology* of the inspired authors—that holy sense which enlightens and saves mankind. This, however, is rather what popular commentary *should do*, than what it *has hitherto done*. We have described the *appropriate sphere* of its duty, rather than the province which it has actually occupied.

The limits of *critical* and *popular* commentary are not so wide as to prevent a partial union of both. Their ultimate object is the same, viz. to present the exact meaning which the Holy Spirit intended to express. Both may state the import of words and phrases; both may investigate the course of thought pursued by prophets and apostles. They may develop processes of argumentation, the scope of the writers' remarks, the bearing of each particular on a certain purpose, and the connection between different portions of Scripture. In these respects *critical* and *popular* commentary may substantially coincide. Perhaps the union of both presents the best model of commentary, provided the former be divested of learned parade and repulsive technicalities, and the latter be perspicuously full. Yet there is much difficulty in combining their respective qualities. In *popularising* the critical, and in elevating the popular

to the standard of intelligent interpretation, there is room for the exercise of great talent. The former is apt to degenerate into *philological sterility*; the latter into *trite reflection*. But by *vivifying* the one, and *solidifying* the other, a good degree of affinity would be effected. The results which learning has attained, by processes unintelligible to all but the scholar, might surely be presented to the unlearned reader so as to be perceived and relished. And what are the results which it is the great object of every commentator to realise? They are simply the *ideas* which the inspired writers designed to set forth. These constitute *theology*. They are emphatically *the truth*. They are the holy mind of God, as far as he has thought fit to reveal it to men—the pure and paramount realities which metamorphose the sinner into the saint. The commentator who comes short of this important end, or fails in exhibiting the whole counsel of God in its harmonious proportions, is not successful. It matters little whether he be possessed of profound learning, if he cannot exhibit in all their strength and richness the exact thoughts of the holy men who wrote. To this all his erudition should be subordinate. Critical and antiquarian knowledge should only be regarded as a mean of arriving at such an object. Geographical, chronological, and historical remarks should solely subserv the eduction or confirmation of Jehovah's will. The building about which they are employed they should *raise, strengthen, or consolidate*. As long as they contribute nothing to the rearing or cementing of its parts, they are useless lumber. The grand question with every commentator should be, what did the Holy Ghost mean to express by such a phrase or sentence? What train of thought does the inspired writer pursue? what truth does he design to teach, what doctrine to embody, what duty to inculcate? Am I exhibiting as the mind of the Spirit what I have sufficient reason to believe to be really such? Have I examined every thing within my reach, which could be supposed to throw light on the original, or aid in understanding it? Has every known circumstance been taken into account? These and similar questions should never be lost sight of by the intelligent commentator; for in proportion as he is actuated by the motives they imply will he produce a solid and safe exposition, such as the sacred original was truly meant to exhibit.

3. The prominent defects of existing commentaries.

(a.) *Prolixity*. This defect chiefly applies to the older works; hence their great size. It is not uncommon to meet with a large folio volume of commentary on a book of Scripture of moderate extent. Thus Byfield, on the Epistle to the Colossians, fills a folio volume; and Venema, on Jeremiah, two quartos. Peter Martyr's 'most learned and fruitful commentaries upon the Epistle to the Romans' occupy a folio, and his 'commentarie upon the book of Judges' another tome of the same extent. But Venema on the Psalms, and Caryl on Job, are still more extravagant, the former extending to no less than six volumes quarto, the latter to two goodly folios. It is almost superfluous to remark that such writers wander away, without confining themselves to exposition. We do not deny that even their extraneous matter may be good and edifying

to those who have the patience to wade through its labyrinths, but still it is not *commentary*. It is not a simple elucidation of the meaning which the sacred writers intended to express. To say every thing that it is almost possible to say on a passage, or to write down what first comes up in the mind, and nearly in the same form in which it suggests itself, is far from giving the true sense, which ought ever to be *the one object* in view. It is very easy to write, *excurrente calamo*, any thing however remotely connected with a passage, or to note down the thoughts as they rise; but to *think out* the meaning of a place, to exercise independent mental effort upon it, to apply severe and rigid examination to each sentence and paragraph of the original, is quite a different process. To exhibit in a lucid and self-satisfying manner the results of deep thought and indomitable industry, is far from the intention of those prolix interpreters, who, in their apparent anxiety to compose a *full* commentary, present the reader with a chaos of annotations, and bury the holy sense of the inspired writers beneath the rubbish of their prosaic musings.

(b.) Some commentators are fond of detailing various opinions, without sifting them. This also we reckon a defect. They procure a number of former expositions, and write down out of each what is said upon a text. They tell what one and another learned annotator affirms, but do not search or scrutinise his affirmations. No doubt an array of names looks imposing; and the reader may stare with surprise at the extent of research displayed; but nothing is easier than to fill up pages with such patchwork, and to be as entirely ignorant of the nature of commentary as before. The intelligent reader will be inclined to say, What matters it to me what this rabbi has said, or that doctor has stated? I am anxious to know *the true sense* of the Scriptures, and not the varying opinions of men concerning them. I long to have the refreshing truths of the Bible presented to me in their native purity, just as they are found in the pages of inspiration. Do not perplex me with the notions of numerous commentators, many of whom were utterly incompetent for their task; but let me see the mind of the Spirit fully and fairly exhibited, without the artificial technicalities of scholastic theology. It is a work of supererogation to collect a multitude of annotations from various sources, most of which the industrious collector knows to be improbable or erroneous. It is folly to adduce and combat interpretations, from which the common sense and simple piety of the unsophisticated reader turn away with instinctive aversion. If *plausible views* be stated, they should be thoroughly analysed. But in all cases the *right meaning* ought to be a *prominent* thing with the commentator, and *prominently* should it be manifested, surrounded, if possible, with those hues which Heaven itself has given it, and qualified by such circumstances as the Bible may furnish.

(c.) Another defect consists in dwelling on the *easy*, and evading the *difficult passages*. This feature belongs especially to those English commentaries which are most current among us. By a series of appended remarks, plain statements are expanded; but wherever there is a real perplexity, it is glozed over with marvellous superficiality. It may be that much is said *about* it,

but yet there is no penetration beneath the surface; and when the reader asks himself what is the true import, he finds himself in the same state of ignorance as when he first took up the Commentary in question. *Pious reflections*, and *multitudinous inferences* enter largely into our popular books of exposition. They *spiritualise*, but they do not *expound*. They *sermonise* upon a book, but they do not catch its spirit, or comprehend its meaning. All this is out of place. A *preaching, spiritualising* commentary does not deserve the appellation of *commentary* at all. When a writer undertakes to educe and exhibit the true sense of the Bible, he should not give forth his own meditations, however just and proper in themselves. Put in the room of *exposition*, they are wholly out of place. The simple portions of the Bible are precisely those which require little to be said on them, while to the more difficult superlative attention should be paid. But the reverse order of procedure is followed by our popular commentators. They piously descant on what is well known, leaving the reader in darkness where he most needs assistance.

The intelligent part of the public are beginning to see that no one man, be his industry what it may, is competent to write a commentary on the whole Bible. Let him possess vast learning, great abilities, sound judgment, mental acumen, and indefatigable zeal, he will still find it impossible to produce a solid commentary on all the canonical books. It is true that one person may write *what is commonly styled* a *commentary* embracing the entire Bible, but how little of independent inquiry does such a work present! How feebly does it trace out the course of thought pursued by each of the inspired writers, the numerous allusions to manners and customs, the whole meaning of the original. Much, very much is left by it untouched. It pursues an easy path, and difficulties vanish before it, because the *highest object* of the right-minded interpreter, so far from being attained, is not sought to be realized. There may be a great amount of writing—the thoughts of preceding commentators may be given in another costume with appended reflections; but, in all this, there is no profound or satisfying investigation. The mere surface of revelation is skimmed. The work is performed perfunctorily. Nothing of value is added to former interpretations. The essence and spirit of the original are to a great extent unperceived. The shades and colourings of thought are unreflected. Two or three books are quite sufficient for one man, to whatever age he may attain. By *intelligently expounding* them, he will do more to advance the cause of sacred interpretation, than if he were to travel over the entire field of the Bible. We had rather see a sound and able commentary on one book, than a prosing expansion of stale remarks on all. It displays more real talent, as it exhibits more independent thought. We value highly the labours of those men who devote themselves to a few books, with an honest determination to ascertain their true meaning, and with such qualifications intellectual, moral, and literary, as have been already noticed. If they be men of the right stamp, we may expect great benefit from their investigations. As for those who have the self-confidence to undertake the exposition of all Scripture, we are inclined to

pass by their harmless drudgery, never looking to it for true exposition. They are mere hewers of wood and drawers of water. They collect the observations of others; but it will be found that *sermonising* and *discursive* annotations fill up their lengthened pages.

4. We shall very briefly refer to the principal commentators on the Bible.

Calvin.—In all the higher qualifications of a commentator Calvin is pre-eminent. His knowledge of the original languages was not so great as that of many later expositors; but in developing the meaning of the sacred writers, he has few equals. It has been well remarked that he chiefly attended to the *logic* of commentary. He possessed singular acuteness, united to a deep acquaintance with the human heart, a comprehension of mind by which he was able to survey revelation in all its features, and an enlightened understanding competent to perceive sound exegetical principles, and resolute in adhering to them. He can never be consulted without advantage, although all his opinions should not be followed. His works present specimens of exegesis that deserve to be ranked among the best extant, because they are occupied with the *spiritual essence* of the Bible—with the *theology* of the inspired writers.

Beza.—Beza's talents are seen to great advantage in expounding the argumentative parts of the Bible. He possessed many of the best exegetical qualities which characterized his great master. In tracing the connection of one part with another, and the successive steps of an argument, he displays much ability. His acuteness and learning were considerable. He was better acquainted with the *theology* than the *criticism* of the New Testament.

Hammond.—This learned annotator was well qualified for interpretation. His paraphrase and annotations on the New Testament possess considerable value; and many good specimens of criticism are found in his notes. Yet he has not entered deeply into the spirit of the original, or developed with uniform success the meaning of the inspired writers. Many of the most difficult portions he has superficially examined, or wholly mistaken.

Poole.—Poole's annotations on the Holy Bible contain several valuable, judicious remarks. But their defects are numerous. The pious author had only a partial acquaintance with the original. He was remarkable neither for profundity nor acuteness. Yet he had piety and good sense, amazing industry, and an extensive knowledge of the older commentators.

Poli Synopsis Criticorum.—In this large work, the annotations of a great number of the older commentators are collected and condensed. But they are seldom sifted and criticised, so that the reader is left to choose among them for himself. Such a chaos of remarks is apt to confuse the mind. Whoever has time, and patience, and discrimination, may find correct exegesis scattered through the whole; but simpler and more direct commentary is much to be preferred.

Grotius.—This very learned writer investigates the literal sense of the Scriptures with great diligence and success. He had considerable exegetical tact, and a large acquaintance with the *heathen* classics, from which he was accustomed to adduce parallels. His taste was good, and

his mode of unfolding the meaning of a passage simple, direct, and brief. His judgment was sound, free from prejudice, and liberal beyond the age in which he lived. As a commentator he was distinguished for his uniformly good sense. But he wanted the depth and acuteness of Calvin. It has been said without reason, that he found Christ nowhere in the Old Testament. It is true that he opposed the Cocceian method, but in this he should be commended. His chief defect is in *spiritual discernment*. Hence he rests in the literal meaning in many cases, where there is a higher or ulterior reference.

Le Clerc.—Excellent notes are interspersed throughout the commentaries of this author, which the younger Rosenmüller transcribed into his *Scholia*. His judgment was good, and his mode of interpretation perspicuous. From his richly stored mind he could easily draw illustrations of the Bible both pertinent and just. Yet he was very defective in theological discrimination. Hence, in the *prophetic* and *doctrinal* books, he is unsatisfactory. It has been thought, not without truth, that he had a rationalistic tendency. It is certain that he exalted his own judgment too highly, and pronounced dogmatically where he ought to have manifested a modest diffidence.

Calmet.—Calmet is perhaps the most distinguished commentator on the Bible belonging to the Roman Catholic Church. In the higher qualities of commentary his voluminous work is very deficient. It contains a good collection of historical materials, and presents the meaning of the original where it is already plain; but his historical apparatus needs to be purified of its irrelevant, erroneous statements; while on the difficult portions no new light is thrown.

Patrick, Lowth, Arnald, and Whitby.—Bishop Patrick had many of the elements belonging to a good commentator. His learning was great when we consider the time at which he lived, his method brief and perspicuous. Lowth was inferior to Patrick. Whitby presents a remarkable compound of excellences and imperfections. In philosophy he was a master. In critical elucidations of the text he was at home. Nor was he wanting in acuteness or philosophical ability. His judgment was singularly clear, and his manner of annotating straightforward. Yet he had not much comprehensiveness of intellect, or a deep insight into the spiritual nature of revelation. The sublime harmony of the New Testament was but dimly seen by him. In the spirit of a high relish for the purity of the Gospel he seldom mounts up into its mysteries. Deeply baptized in the Spirit's influences he could not have been, else many of his expository notes would have been different.

Henry.—The name of this good man is venerable, and will be held in everlasting remembrance. His commentary does not contain much *exposition*. It is full of *sermonising*. It is surprising, however, to see how far his good sense and simple piety led him into the doctrine of the Bible, apart from many of the higher qualities belonging to a successful commentator. In thoroughness and solidity of exposition he is not to be named with Calvin. His prolixity is great. *Practical preaching* is the burden of his voluminous notes.

Gill.—The prominent characteristic of Gill's

commentary is *heaviness*. It lacks condensation and brevity. The meaning of the inspired authors is often undeveloped, and more frequently distorted. It has the lumber and rubbish of learning, without learning itself.

Doddridge.—The taste of this pious commentator was good, and his style remarkably pure. He had not much acumen or comprehension of mind; but he had an excellent judgment, and a calm candour of inquiry. His paraphrase leaves much unexplained, while it dilutes the strength of the original. It is too discursive and sermonising. The notes are few, and ordinarily correct.

Scott.—The prevailing characteristic of Scott's commentary is judiciousness in the opinions advanced. The greater portion of it, however, is not *proper exposition*. The pious author preaches about and paraphrases the original. His simplicity of purpose generally preserved him from mistakes; but as a commentator he was neither acute nor learned. He wanted a competent acquaintance with the original, power of analysis, a mind unprepossessed by a doctrinal system, and penetration of spirit.

A. Clarke.—In most of the higher qualities by which an interpreter should be distinguished, this man of much reading was wanting. His historical and geographical notes are the best. But he had no philosophical ability. His prejudices warped his judgment. His philology is not unfrequently puerile. Acuteness and penetration are not seen in his writings. There is no deep insight into the mind of the sacred writers.

The modern Germans, prolific as they are in theological works, have seldom ventured to undertake an exposition of the whole Bible. Each writer usually confines himself to the task of commenting on a few books. In this their wisdom is manifested. Yet they do not excel in good specimens of commentary. They are *word-explainers*. In pointing out various readings, in grammatical, historical, and geographical annotations, as also in subtle speculations respecting the genius of the times in which the writers of the Bible lived, they are at home. In the *lower criticism* we willingly sit at their feet and learn. But with regard to the *higher*, in all that pertains to the *logic* of commentary, in development of the sense in its holy relations, they are lamentably wanting. Refined notions usurp the place of practical piety in their minds; and the minutæ of verbal criticism furnish them nutriment apart from the rich repast of theological sentiment and sanctifying truth. But there are some noble exceptions.

E. F. C. Rosenmüller.—The *Scholia* of this laborious writer extend over the greater part of the Old Testament. Looking to the last editions, they are unquestionably of high value. They bring together a mass of annotation such as is sufficient to satisfy the desires of most Biblical students. Yet the learned author undertook too much to perform it in a masterly style. Hence his materials are not properly sifted, the chaff from the wheat. He has not drunk deeply into the spirit of the inspired authors. He seems indeed not to have had a soul attuned to the spirituality of their utterances, or impregnated with the celestial fire that touched their hallowed lips. His father, the author of the *Scholia* on the New Testament, is a good *word-explainer* for students

beginning to read the original. He has not produced a masterly specimen of commentary on any one book or epistle.

Olshausen.—The best example of commentary on the New Testament with which we are acquainted has been given by this writer. It is a model of exposition unrivalled in any language. Verbal criticism is but sparingly introduced, although even here the hand of a master is apparent. He is intent, however, on higher things. He investigates the thought, traces the connection, puts himself in the same position as the writers, and views with philosophic ability the holy revelations of Christ in their comprehensive tendencies. The critical and the popular are admirably mingled. Greatly do we lament that the writer was cut off before he completed so excellent a performance.

Tholuck.—The commentaries of this eminent writer on various books of the New Testament, especially those on the Epistles to the Romans and Hebrews, exhibit the highest exegetical excellences. While he critically investigates phrases and idioms, he ascends into the pure region of the ideas, unfolding the sense with much skill and discernment. His commentary on John is of a more popular cast. His interpretation of the *Bergpredigt*, or Sermon on the Mount, is very valuable.

In addition to these, Germany has produced other specimens of commentary that occupy a high place in the estimation of competent judges. Lücke, on John's writings, especially in the *third* edition now in progress; Gesenius, on Isaiah; De Wette, on the Psalms; Hävernick, on Ezekiel and Daniel; Billroth, on the Corinthians; Harless, on Ephesians; and Baehr, on the Colossians, possess much merit, accompanied, it is true, with some serious faults. As examples of thorough and solid commentary, the English language presents none equal to those of Professor Stuart on the Epistles to the Romans and Hebrews. The learned author has fully entered into the spirit of the great Apostle, evading no difficulty, and tracing the course of his reasoning with considerable success. He has consequently thrown more light on these difficult Epistles than many are willing to allow. A valuable commentary on the Epistle to the Romans we also possess in that of Professor Hodge, although the author cannot be said to have gone far beyond Calvin, in whose steps he has closely trod.

Our space will not allow us to mention other expository treatises. Those we have noticed are best known in this country, and most perused.

S. D.

COMMERCE. The idea conveyed by this word is represented in the sacred writings by the word trade; the Hebrew term רכל *rekel* signifying literally 'trade' or 'traffic.'

Commerce, in its usual acceptation, means the exchange of one thing for another—the exchange of what we have to spare for what we want, in whatever country it is produced. The origin of commerce must have been nearly coeval with the world. As pasture and agriculture were the only employments of the first inhabitants, so cattle, flocks, and the fruits of the earth were the only objects of the first commerce, or that species of it called barter. It would appear that some progress had been made in manufactures in the ages before the flood

The building of a city or village by Cain, however insignificant the houses may have been, supposes the existence of some mechanical knowledge. The musical instruments, such as harps and organs, the works in brass and in iron exhibited by the succeeding generations, confirm the belief that the arts were considerably advanced. The construction of Noah's ark, a ship of three decks, covered over with pitch, and much larger than any modern effort of architecture, proves that many separate trades were at that period carried on. There must have been parties who supplied Noah and his three sons with the great quantity and variety of materials which they required, and this they would do in exchange for other commodities, and perhaps money. That enormous pile of building, the tower of Babel, was constructed of bricks, the process of making which appears to have been well understood. Some learned astronomers are of opinion that the celestial observations of the Chinese reach back to 2249 years before the Christian era; and the celestial observations made at Babylon, contained in a calendar of above nineteen centuries, transmitted to Greece by Alexander, reach back to within fifteen years of those ascribed to the Chinese. The Indians appear to have had observations quite as early as the Babylonians.

Such of the descendants of Noah as lived near the water may be presumed to have made use of vessels built in imitation of the ark—if, as some think, that was the first floating vessel ever seen in the world—but on a smaller scale, for the purpose of crossing rivers. In the course of time the descendants of his son Japhet settled in 'the isles of the Gentiles,' by which are understood the islands at the east end of the Mediterranean sea, and those between Asia Minor and Greece, whence their colonies spread into Greece, Italy, and other western lands.

Sidon, which afterwards became so celebrated for the wonderful mercantile exertions of its inhabitants, was founded about 2200 years before the Christian era. The neighbouring mountains, being covered with excellent cedar-trees, furnished the best and most durable timber for ship-building. The inhabitants of Sidon accordingly built numerous ships, and exported the produce of the adjoining country, and the various articles of their own manufacture, such as fine linen, embroidery, tapestry, metals, glass, both coloured and figured, cut, or carved, and even mirrors. They were unrivalled by the inhabitants of the Mediterranean coasts in works of taste, elegance, and luxury. Their great and universally acknowledged pre-eminence in the arts procured for the Phœnicians, whose principal seaport was Sidon, the honour of being esteemed, among the Greeks and other nations, as the inventors of commerce, ship-building, navigation, the application of astronomy to nautical purposes, and particularly as the discoverers of several stars nearer to the north pole than any that were known to other nations; of naval war, writing, arithmetic, book-keeping, measures and weights; to which it is probable they might have added money.

Egypt appears to have excelled all the neighbouring countries in agriculture, and particularly in its abundant crops of corn. The fame of its fertility induced Abraham to remove thither with his numerous family (Gen. xii. 10).

The earliest accounts of bargain and sale reach no higher than the time of Abraham, and his transaction with Ephron. He is said to have weighed unto him '400 shekels of silver, current money with the merchant' (Gen. xxiii. 16). The word merchant implies that the standard of money was fixed by usage among merchants, who comprised a numerous and respectable class of the community. Manufactures were by this time so far advanced, that not only those more immediately connected with agriculture, such as flour ground from corn, wine, oil, butter, and also the most necessary articles of clothing and furniture, but even those of luxury and magnificence, were much in use, as appears by the ear-rings, bracelets of gold and of silver, and other precious things presented by Abraham's steward to Rebecca (Gen. xxiv. 22, 53).

In the book of Job, whose author, in the opinion of the most learned commentators, resided in Arabia, and was contemporary with the sons of Abraham, much light is thrown upon the commerce, manufactures, and science of the age and country in which he lived. There is mention of gold, iron, brass, lead, crystal, jewels, the art of weaving, merchants, gold brought from Ophir, which implies commerce with a remote country, and topazes from Ethiopia; ship-building, so far improved that some ships were distinguished for the velocity of their motion; writing in a book, and engraving letters or writing on plates of lead and on stone with iron pens, and also seal-engraving; fishing with hooks, and nets, and spears; musical instruments, the harp and organ; astronomy, and names given to particular stars. These notices tend to prove that, although the patriarchal system of making pasturage the chief object of attention was still maintained by many of the greatest inhabitants where the author of the book of Job resided, the sciences were actively cultivated, the useful and ornamental arts in an advanced state, and commerce prosecuted with diligence and success; and this at a period when, if the chronology of Job is correctly settled, the arts and sciences were scarcely so far advanced in Egypt, from whence, and from the other countries bordering upon the eastern part of the Mediterranean Sea, they afterwards gradually found their way into Greece.

The inhabitants of Arabia appear to have availed themselves, at a very early period, of their advantageous situation between the two fertile and opulent countries of India and Egypt, and to have obtained the exclusive monopoly of a very profitable carrying trade between those countries. They were a class of people who gave their whole attention to merchandise as a regular and established profession, and travelled with caravans between Arabia and Egypt, carrying upon the backs of camels the spiceries of India, the balm of Canaan, and the myrrh produced in their own country, or of a superior quality from the opposite coast of Abyssinia—all of which were in great demand among the Egyptians for embalming the dead, in their religious ceremonies, and for ministering to the pleasures of that superstitious and luxurious people. The merchants of one of these caravans bought Joseph from his brothers for twenty pieces of silver, that is about 2*l.* 1*1s.* 8*d.* sterling, and carried him into Egypt. The southern Arabs were eminent traders, and enjoyed a

large proportion, and in general the entire monopoly, of the trade between India and the western world, from the earliest ages, until the system of that important commerce was totally overturned when the inhabitants of Europe discovered a direct route to India by the Cape of Good Hope.

At the period when Joseph's brethren visited Egypt, inns were established for the accommodation of travellers in that country and in the northern parts of Arabia. The more civilized southern parts of the peninsula would no doubt be furnished with caravanserais still more commodious.

During the residence of the Israelites in Egypt manufactures of almost every description were carried to great perfection. Flax, fine linen, garments of cotton, rings and jewels of gold and silver, works in all kinds of materials, chariots for pleasure, and chariots for war, are all mentioned by Moses. They had extensive manufactories of bricks. Literature was in a flourishing state; and, in order to give an enlarged idea of the accomplishments of Moses, it is said he was 'learned in all the wisdom of the Egyptians' (Acts xii. 22).

The expulsion of the Canaanites from a great part of their territories by the Israelites under Joshua, led to the gradual establishment of colonies in Cyprus, Rhodes, and several islands in the Ægean Sea; they penetrated into the Euxine or Black Sea, and, spreading along the shores of Sicily, Sardinia, Gaul, Spain, and Africa, established numerous trading places, which gradually rose into more or less importance. At this period mention is first made of Tyre as a strong or fortified city, whilst Sidon is dignified with the title of Great.

During the reign of David, king of Israel, that powerful monarch disposed of a part of the wealth obtained by his conquests in purchasing cedar-timber from Hiram, king of Tyre, with whom he kept up a friendly correspondence while he lived. He also hired Tyrian masons and carpenters for carrying on his works. Solomon, the son of David, cultivated the arts of peace, and indulged his taste for magnificence and luxury to a great extent. He employed the wealth collected by his father in works of architecture, and in strengthening and improving his kingdom. He built the famous Temple and fortifications of Jerusalem, and many cities, among which was the celebrated Tadmor or Palmyra. From the king of Tyre he obtained cedar and fir, or cypress-timbers, and large stones cut and prepared for building, which the Tyrians conveyed by water to the most convenient landing-place in Solomon's dominions. Hiram also sent a vast number of workmen to assist and instruct Solomon's people, none of whom had skill 'to hew timber like the Sidonians.' Solomon, in exchange, furnished the Tyrians with corn, wine, and oil, and received a balance in gold. Solomon and Hiram appear to have subsequently entered into a trading speculation or adventure upon a large scale. Tyrian shipwrights were accordingly sent to build vessels for both kings at Eziongeber, Solomon's port on the Red Sea, whither he himself went to animate them with his presence (2 Chron. viii. 17). These ships, conducted by Tyrian navigators, sailed in company to some rich countries called Ophir and

Tarshish, regarding the position of which the learned have multiplied conjectures to little purpose. The voyage occupied three years; yet the returns in this new found trade were very great and profitable. This fleet took in apes, ebony, and parrots on the coasts of Ethiopia, gold at Ophir, or the place of traffic whither the people of Ophir resorted; it traded on both sides of the Red Sea, on the coasts of Arabia and Ethiopia, in all parts of Ethiopia beyond the straits when it had entered the ocean; thence it passed up the Persian Gulf, and might visit the places of trade upon both its shores, and run up the Tigris or the Euphrates as far as these rivers were navigable.

After the reign of Solomon the commerce of the Israelites seems to have very materially declined. An attempt was made by Jehoshaphat, king of Judah, and Abaziah, king of Israel, to effect its revival; but the ships which they built at Eziongeber having been wrecked in the harbour, the undertaking was abandoned. It does not appear that they had any assistance from the Phenicians in fitting out this fleet. Great efforts were made by the Egyptians to extend the commerce of their country, among which, not the least considerable was the unsuccessful attempt to construct a canal from the Nile to the Arabian Gulf.

The rising prosperity of Tyre soon eclipsed the ancient and long-flourishing commercial city of Sidon. About 600 years before Christ her commercial splendour appears to have been at its height, and is graphically described by Ezekiel (xxvii). The imports into Tyre were fine linen from Egypt; blue and purple from the isles of Elisha; silver, iron, tin, and lead from Tarshish—the south part of Spain; slaves and brazen vessels from Javan or Greece, Tubal, and Meshech; horses, slaves bred to horsemanship, and mules from Togarmah; emeralds, purple, embroidery, fine linen, corals, and agates from Syria; corn, balm, honey, oil, and gums from the Israelites; wine and wool from Damascus; polished iron-ware, precious oils, and cinnamon from Dan, Javan, and Mezo; magnificent carpets from Dedan; sheep and goats from the pastoral tribes of Arabia; costly spices, some the produce of India, precious stones, and gold from the merchants of Sheba or Sabæa, and Ramah or Regma, countries in the south part of Arabia; blue cloths, embroidered works, rich apparel in corded cedar-chests, supposed to be original India packages, and other goods from Sheba, Ashur, and Chilmad, and from Haran, Canneh, and Eden, trading ports on the south coast of Arabia. The vast wealth that thus flowed into Tyre from all quarters brought with it its too general concomitants—extravagance, dissipation, and relaxation of morals.

The subjection of Tyre, 'the renowned city which was strong in the sea, whose merchants were princes, whose traffickers were the honourable of the earth,' by Cyrus, and its subsequent overthrow by Alexander, after a determined and most formidable resistance, terminated alike the grandeur of that city and the history of ancient commerce, as far as they are alluded to in Scripture (Anderson's *History of Commerce*; Vincent's *Commerce and Navigation of the Indian Ocean*; Heeren's *Researches*; Barnes's *Ancient Commerce of Western Asia*, in *American Biblical Repository*, 1841).—G. M. B.

COMMON (*κοινός*). The Greek term properly signifies *what belongs to all* (as in Wisd. vii. 3, *κοινὸς ἀήρ*), but the Hellenists applied it (like the Hebrew כּוּן) to what was profane, *i. e.* *not holy*, and therefore of common or promiscuous use (Acts x. 14). They also applied the term to what was *impure*, whether naturally or legally (as in Mark vii. 2, compared with Macc. i. 47, 62). And, finally, it was used of meats forbidden, or such as had been partaken of by idolaters, and which, as they rendered the partakers thereof impure, were themselves called *κοινὰ* (common), and *ἀκάθαρτα* (unclean) (see Kuinoel on Acts x. 14).

COMMUNION (*κοινωνία*), a fellowship or agreement, when several persons join and partake together of one thing (2 Cor. vi. 14; 1 John i. 3); hence its application to the celebration of the Lord's supper as an act of fellowship among Christians (1 Cor. x. 16): and it is to this act of participation or fellowship that the word 'communion' is now restricted in the English language, the more familiar application of it having fallen into disuse.

CONCORDANCE, the name assigned to a book which gives the words contained in the Holy Scriptures in alphabetical order, with a reference to the place where each may be found. This is the essential idea of a concordance; other ancillary information may be presented in concordances, such as a separate order of proper names, the meanings which in the compiler's opinion important words are found to bear, and the etymological signification of appellatives, &c. There are two great distinctive principles on which concordances may be constructed—either to present every word found in the Bible, or only the leading and most important words. The adoption of the first necessarily swells a book to inconvenient dimensions, and renders its use in the ordinary purposes of study somewhat onerous and inconvenient. But great judgment is requisite in compiling a concordance on the other principle, lest words of less importance should be preferred to those of greater; and as importance is altogether a relative matter, the selection made by the author may omit words which some, if not many, readers would desiderate. The Germans also make a distinction between concordances of things and concordances of words: the first comprising in detailed and alphabetical form the subject-matter of the sacred volume; the second corresponding with the ordinary English notion of a concordance. Concordances, too, vary with the languages in which, or for which, they are constructed, as for the original Hebrew and Greek, or for the several versions of the Scriptures, such as the Vulgate, the German, the English, &c.

It is not here intended to present a full or a chronological history of all the concordances which have been produced, but to put down those particulars which seem to combine interest and utility.

Writings of this kind imply that the sacred Scriptures are regarded with reverence, held to be authoritative in religion, and are made the subject of appeal alike in learning, teaching, and disputation. So long therefore as the Bible was scattered piecemeal up and down the world in convents and libraries, and so long as it was rarely studied even by the professed ministers of religion,

concordances were neither needed nor produced; yet there never ceased, in the darkest ages of the Church, to be some who felt a profound interest in the study of the venerable book, and consequently some rude essays appear to have been made in this way before the age in which concordances may properly be said to have had their origin. It is to the Reformation and the deep and general concern which it awakened touching the truths contained in the Scriptures; it is to the primary principle of the Reformation—the appeal from tradition to the Bible, from the Church to the word of God; it is to the wide-spread conviction of the plenary and even verbal inspiration of the Bible, that the world is indebted for the care, diligence, learning, and self-denial which have been employed in constructing and perfecting the concordance.

The utility of concordances in the way of exegesis, that is, to assist the student in the discovery and explanation of the meaning of the sacred writings, is based on the position that the several parts of divine revelation are consistent with each other and form harmonious elements in one grand system of spiritual truth, so that by comparing together parallel passages what is clear may be exemplified and confirmed, and what is dark may be expounded. Books of this sort, too, are of service to the Christian teacher, as affording facilities by means of those fragmentary recollections of words and things which the mere hearing of the Scriptures read leave in the mind, for readily discovering the particular book and verse where any desired passage is to be found; and also as enabling him, with comparatively little trouble, to take a survey of what the Bible contains in regard to any particular subject which he may have to handle.

Antony of Padua (born A.D. 1195, died 1231) is said to have produced the first work of the kind, entitled *Concordantie Morales*, which was formed from the Vulgate translation. Hugo de Santo Caro, better known as Cardinal Hugo, a Dominican monk, who died about 1262, followed Antony in 1244, by compiling for the Vulgate a concordance of the Scriptures. Having given himself sedulously to the study of holy writ, with a view of writing a commentary thereon, he was, in order to facilitate his labour, led to project and undertake to form a concordance, calling to his aid his brother monks to the number of no fewer than five hundred. Their labours have been a rich storehouse for subsequent compilers. The concordance thus made was improved by Conrad of Halberstadt, who flourished about 1290, and by John of Segovia in the ensuing century.

These works seem to have led to the first Hebrew concordance, which was produced by Rabbi Mordecai Nathan, which he began in 1438, and finished in 1448, after ten years' hard labour by himself and some assistants. It was first printed at Venice in 1523, fol., by Dan. Bomberg, then in Basle in 1581, and afterwards at Rome in 1621. It is entirely Hebrew, and entitled *The Light of the Way*. In 1566 it was translated into Latin by Reuchlin, but both the Hebrew and the Latin editions are full of errors.

These errors were for the most part corrected and other deficiencies supplied by Calasio, a Franciscan friar, who published *Concordantiæ Sacr. Bibl. Hebr. et Latin.* Romæ, 1621, 4

vols. fol. Referring the reader for details respecting this work to Orme's *Bibliotheca Biblica*, p. 112, we dwell a little more on a work which is found less seldom than the former in private theological libraries—*Concordantie Bibl. Ebraicæ, novæ et artificiosæ methodo dispositæ*, Basil, 1632, fol. This is the production of John Buxtorf, the father, but was published by his son. It takes for its basis the work of Rabbi Nathan, though it is much better arranged, more correctly printed, the roots more distinctly ascertained, and the meanings more accurately given; but as the references are made by Hebrew letters, and relate to the Rabbinical divisions of the Old Testament, it is of little service, unless the student is familiar with the Masoretic system. This work was abridged under the title of *Fons Leonis*, &c., Bero- lini, 1677, 8vo. The concordance of Calasio was republished in London under the direction of W. Romaine, 1747-9, 4 vols. fol., and under the patronage of all the monarchs in Europe, not excepting the pope himself. Before this republication, however, there appeared, in 1679 (Kopenh. fol.), Ch. Nolde *Concor. particularum Ebr. Chaldaicarum*. Reference may also be made to Simonis *Onomasticon V. T.* Halle, 1741, fol. But the best and, at least to the English reader, most important work on this subject is, *The Hebrew Concordance, adapted to the English Bible, disposed after the manner of Buxtorf*, by John Taylor, D.D., London, 1754, 2 vols. fol. Dr. Taylor was an eminent Presbyterian divine at Norwich, the author of several publications which show great industry and learning. His concordance is by far the most complete work of the kind. It was the fruit of many years' labour, and has left little room for improvement. The patronage of all the English and Irish bishops recommended the work to the world.

An edition of Buxtorf's *Hebrew Concordance*, which has received so much care and attention on the part of the author, as nearly to deserve the name and bear the character of a new work—*Hebræischen und Chaldäischen Concordanz zu den Heiligen Schriften Alten Testaments*, von Dr. Julius Fürst (Leipzig, Tauchnitz; London, Nutt) offers one of the most useful aids to the study of the Bible that have ever appeared. The necessity of such a work as the present arises not only from the errors found in Buxtorf and the comparative rarity of the work, but also from the great advances which, since the time when Buxtorf's work appeared (A.D. 1632), have been made both in the knowledge of the Shemitic languages, in the general science of theology, and the particular department of Biblical exegesis. We may specify one or two of the advantages offered by this work. In addition to those of a more mechanical kind, such as a good type and clear arrangement, there are, 1. A corrected text, founded on Halm's *Vanderhoogt*; 2. The Rabbinical significations; 3. Explanations in Latin, giving the etymology of the Rabbinical; illustrations from the three Greek Versions, the Aramaic Paraphrase, the Vulgate, &c.; the Greek words employed by the Seventy as renderings of the Hebrew; together with philological and archæological notices, so as to make the Concordance contain an ample Hebrew lexicon. This work is far preferable to Taylor's *Hebrew Concordance*, which is now not easily met with. Every theo-

logical library which has not a copy of Fürst must be considered as wanting an essential requisite. The work, when known, will, we are assured, be welcomed by English scholars.

The best Greek concordance to the Septuagint is that which bears the title—A. Trommii *Con. Græc. Vers. vulgo dic. LXX. Interpre.* Amst. 1718, 2 vols. fol. The author of this learned and most laborious work was minister of Groningen, and published the concordance in the eighty-fourth year of his age. He was born in 1623 and died in 1719. It follows the order of the Greek words of which it first gives a Latin translation, and then the Hebrew word or words for which the Greek term is used in the Seventy. Then the different places in which the words occur follow in the order of the several books and chapters. When the word occurs in any of the ancient Greek translators, Aquila, Symmachus, or Theodotion, the places where it is found are referred to at the end of the quotations from the Sept. The words of the Apocrypha are placed at the end of each enumeration. There are two indices at the end of the work: one Hebrew and Chaldaic, by examining which the Greek term used in the Septuagint for any Hebrew or Chaldaic word is seen at once, with the Latin version and the place where it is found in the concordance, so that Tromm serves in a measure for a Hebrew concordance; the other index contains a lexicon to the Hexapla of Origen, and comprehends the Greek words in the fragments of the old Greek translators published by Montfaucon.

The first Greek concordance to the New Testament, now exceedingly rare, is entitled *Xysti Betuleii Concordantiæ Græcæ Novi Testamenti*, Basil. 1546, fol. The author, whose real name was Birk, was a minister of the Lutheran church; he was born in 1500, and died at Augsburg in 1554. A concordance to the Greek New Testament, projected and partly executed by Robert Stephens, and completed and published by his son Henry (Genev. 1594, fol.), is too inaccurate to merit more than a passing notice. The ensuing is the work which the divine should possess—*Erasmii Schmidii Novi Testamenti J. C. Græci; hoc est, originalis linguæ τρωμαίων*, &c. Vetemb. 1638, fol. The author, a Lutheran divine, was a professor of the Greek language in the university of Wittemberg, where he died in 1637. In 1717 a revised edition was published at Gotha, of which a handsome reprint, in 2 vols. 8vo., was issued from the Glasgow University press in 1819. The same work, edited by Greenfield, has been printed by the Messrs. Bagster of London, in a thin, flat pocket volume, and in another form, 32mo., being one of their 'Polymicrian Series.' By omitting the unimportant proper names, the indeclinable particles, the pronouns and the verb substantive, by substituting simple references for citation under such circumstances as allow of the change, the ponderous labours of the Stephenses and Schmid are in these editions compressed into neat, low-priced, and convenient pocket volumes, without any deduction from utility.

A new and very superior edition of Schmid's *τρωμαίων* has recently been put forth by C. H. Bruder, who has improved the work so as to bring it into accordance with the advanced and enlightened views on critical and hermeneutical subjects which characterize what may be termed

the scientific theology of Germany in the present day. Among the advantages of this edition, let it suffice to specify, 1. Fulness, accuracy, and correspondence with Griesbach's edition; 2. Regard has been paid to the editions of Lachmann and Scholz; all the readings of the Elzevirs, Mill, Bengel, Knapp, Tittmann, Scholz, and also of Erasmus, Robert Stephens' third edition, and of Schmid himself, are either given or pointed out. The student is presented also with a selection of readings from the most ancient MSS., from the interpreters of Scripture who lived in the earlier ages of the church, and the works of the ecclesiastical fathers: no various reading possessing critical value is omitted. This, indeed, is a work of so much value, that no good theological library can be without it; and when its worth and utility come to be known in this country, it will soon supersede the ordinary editions and reprints of Schmid's *Concordance*. It is put forth under the auspices of that spirited publisher Tauchnitz of Leipsic.

One of the most valuable aids for the general study of the New Testament which modern times have produced is '*The Englishman's Greek Concordance of the New Testament*'; being an attempt at a Verbal Connexion between the Greek and the English Texts. London, 1839.' The work, which is carefully compiled and beautifully got up, takes Schmid as its basis. The plan is to present in alphabetical succession every word which occurs in the Greek New Testament with the series of passages (quoted from the English translation) in which each such word occurs; the word or words exhibiting the Greek word under immediate consideration being printed in italic letters. The utility of such a work is various. We will give one instance. Let it be supposed that the student is engaged in endeavouring to learn the import of the words 'that it might be fulfilled.' If his acquaintance with Greek is small, he has to refer to an index at the end of the volume in order to ascertain what is the Greek word which our translators have rendered by 'fulfilled.' If he is familiar with the Greek New Testament, he at once turns to the word πληρόω, which he finds in both Greek and English characters, immediately followed by the several passages in English which are renderings of πληρόω in the original. For the sake of completing our illustration, we transcribe several of these renderings, taking them in the order in which they are found in this *Concordance*—the order, that is, in which the books of the New Testament stand in the Common Version: these renderings are, 'fulfilled,' 'to fulfil,' 'was full,' 'fill ye up,' 'filled,' 'had ended,' 'full come,' 'make full,' 'were (years) expired,' 'were ended,' 'fulfil ye my joy,' 'God shall supply,' 'ye are complete,' 'works perfect.' Now enough of the context is given to enable a diligent reader of the English New Testament to learn, as his eye runs down the column of citations, on which subject each quoted passage bears, and generally which therefore is the general import and bearing of each rendering of the Greek original. First impressions are thereby at once gained—perhaps definite convictions as well—without once referring to the Greek Testament itself, though the citations may extend throughout the volume, and require hours to be consumed had they to be sought without aid. These first impressions may

lead to sustained thought or careful investigation: indeed, the most profound study of the New Testament may, with the assistance here provided, be carried on with no less ease than satisfaction, by any one who is intent on learning 'the mind of the Spirit,' though but scantily provided with erudition.

In consequence of the revived study of the Bible and of the Christian fathers, as well as the greater interest felt in religion and religious inquiries which the last quarter of a century has witnessed in France, and especially in Paris, a new Concordance to the Latin Vulgate has recently been produced: '*Concordantiæ Biblior. Sacr., Vulgatæ Editionis, Recensitæ, multoque prioribus auctores, emendatæ, accuratius denuo colligente et cum omnibus Bib. textibus conferente T. P. Dutripon.*' London, Nutt, Fleetstreet. This work is founded on that of Cardinal Hugo, which, though executed by fifty different compilers (chiefly Benedictine monks), is far from being either accurate or complete. The editor appears to have discharged his duty with great care and labour; and the printer has well performed his part. The points in which this edition contains improvements, in comparison with the last of those which preceded it, are numerous and important. It may be sufficient to state that it contains 22,000 passages not to be found in previous Concordances to the Vulgate. Some of the additions, indeed, seem rather suited to the peculiar condition of Biblical study in the Catholic communion than to the requirements of the general theologian; nevertheless, the work is a valuable contribution to Biblical literature, and must in this country be regarded with peculiar pleasure, as both a result and an instrument of an increase of Scriptural knowledge on the part of our Catholic brethren. The Archbishop of Paris has accepted the dedication of the Concordance to himself; and it has been approved by most of the archbishops and bishops of France and Belgium.

The work of Andrew Synson, *Lexicon Anglo-Græco-Latin. N. T.*, London, 1658, fol., is rather a dictionary than a concordance, and formed on so bad a plan as to be of little service. A much better book is *A Concordance to the Greek Testament, with the English Version to each Word, the principal Hebrew roots corresponding to the Greek words of the Septuagint, with short Critical Notes, and an Index*, by John Williams, LL.D., Lond. 1767, fol.

The first concordance to the English version of the New Testament was published without date, but certainly before 1540, by 'Mr. Thomas Gybson,' being chiefly, as appears probable from the prefatory epistle to the reader, the work of the famous printer John Day. It is entitled *The Concordance of the New Testament, most necessary to be had in the hands of all soche as desire the communication of any place contained in the New Testament*. The first English concordance to the entire Bible was by John Marbeck—*A Concordance, that is to saie, a Worke wherein by the order of the letters of the A, B, C, ye maie redely find any worde conteigned in the whole Bible, so often as it is there expressed or mentioned*, Lond. 1550, fol. Till the year 1555, when Robert Stephens published his concordance, it was not customary to mark the verses in books

of this sort. At first it was thought sufficient to specify the chapter with the letters *a, b, c, d*, as marks to point out the beginning, middle, and end of each chapter. But in 1545 Robert Stephens divided the Bible into verses, thus preparing the way for a more exact reference in concordances, &c.; but Marbeck does not appear to have been under the influence of this improvement, as his work refers merely to the chapters. In Townley's *Bib. Lit.* vol. iii. p. 118, may be found some interesting particulars respecting Marbeck's condition in life, labours, and ill-treatment.

The following work, which appeared in the same year as the last, is a translation from the German—*A Briefe and a Compendious Table, in manner of a Concordance, opening the waye to the principall Histories of the whole Bible and the most comon articles grounded and comprehended in the Newe Testament and Olde, in manner as amply as doeth the great Concordance of the Bible. Gathered and set forth by Henry Bullinger, Leo Jude, Conrade Pellicane, and by the other ministers of the Church of Ligyrie. Translated from the Hygh Almayne into Englysh by Walter Lynne. To which is added, a Translation of the Third Boke of Machabees*, Svo. 1550. Lynne, the translator, was an English printer, who flourished about the middle of the sixteenth century, a scholar, author, and translator of several books. Bullinger, the author, was a Swiss reformer, born near Zurich in Switzerland, 1504.

Several English concordances of greater or less value were superseded by the correct and valuable work of Alexander Cruden, entitled *A Complete Concordance to the Holy Scriptures of the Old and New Testament, &c.; to which is added, a Concordance to the books called Apocrypha*, 1737, 4to. Three editions were published by the author during his life, and many have appeared since his death. The London edition of 1810 is the best standard edition. The work is complete, the definitions accurate, and the references correct. Several useful editions of Cruden have been put forth by the Messrs. Bagster, which are worth far more than their cost. The same publishers have issued *An Alphabetical Index of the Holy Scriptures, comprising the Names, Characters, and Subjects, both of the Old and New Testament*, in two different sizes, which the Biblical student will find very serviceable. In a 'Memoir of Mr. Alexander Cruden,' prefixed to an edition published in 1823, and since, are given some interesting but painful particulars respecting this worthy and industrious man, to whom the religious world is so deeply indebted.

At a time when German theological literature is beginning to receive some of its merited attention, it may not be unacceptable to mention a valuable concordance for the German Bible—*Biblishe Hand-Concordanz für Religionslehrer und alle Freunde der Heiligen Schrift*, Leipzig, 1841. The work is more comprehensive than similar writings in the English language. It is divided into three parts:—1. A full and complete register of all the words found in the Bible; 2. An index of the most important things, subjects, and ideas found in the Bible, with references to the places where they lie in the sacred volume; as for instance, under the head—'Lord's Supper—a meal commemorative of the death of

Jesus—it brings us into intimate fellowship with Christ;—the worthy participation of the same; spiritual enjoyment of the flesh and blood of Christ,' &c. The third part gives the leading doctrines of Christianity systematically arranged, drawn up according to Luther's *Catechism*, and accompanied by Scriptural proofs. (Orme's *Bibliotheca Biblica*; Watts's *Bibliotheca Britannica*; Winer's *Handbuch*; Röhr's *Kritische Prediger-Bibliothek*, 1841.)—J. R. B.

CONCUBINAGE, in a scriptural sense, means the state of cohabiting lawfully with a wife of second rank, פלגיש *pligash*, who enjoyed no other conjugal right but that of cohabitation, and whom the husband could repudiate, and send away with a small present (Gen. xxi. 14). In like manner, he could by means of presents, exclude his children by her from the heritage (Gen. xxv. 6). Such concubines, פלגישים, had Nahor (Gen. xxii. 24), Abraham (xxv. 6), Jacob (xxxv. 22), Eliphas (xxxvi. 12), Gideon (Judg. viii. 3), Saul (2 Sam. iii. 7), David (1 Sam. v. 13; xv. 16; xvi. 21), Solomon (1 Kings xi. 3), Caleb (1 Chron. ii. 46), Manasseh (*ib.* vii. 14), Rehoboam (2 Chron. xi. 21), Abiah (2 Chr. xiii. 21), and Belshazzar (Dan. v. 2). To judge from the conjugal histories of Abraham and Jacob (Gen. xvi. and xxx.), the immediate cause of concubinage was the barrenness of the lawful wife, who in that case introduced her maid-servant, of her own accord, to her husband, for the sake of having children. Accordingly we do not read that Isaac, son of Abraham, had any concubine, Rebecca, his wife, not being barren. In process of time, however, concubinage appears to have degenerated into a regular custom among the Jews, and the institutions of Moses were directed to prevent excess and abuse in that respect, by wholesome laws and regulations (Exod. xxi. 7-9; Deut. xxi. 10-14). It would seem that the unfaithfulness of a concubine was not regarded as an act of real adultery (Lev. xix. 20). To guard adult male offspring from debauchery before marriage, their parents, it appears, used to give them one of their female slaves, as a concubine. She was then considered as one of the children of the house, and she retained her rights as a concubine, even after the marriage of the son (Exod. xxi. 9, 19). When a son had intercourse with the concubine of his father, a sort of family punishment, we are informed, was inflicted on him (Gen. xxxv. 22; 1 Chron. v. 1).

In the Talmud (*tit. Cetuboth*), the Rabbins differ as to what constitutes concubinage; some regarding as its distinguishing feature the absence of the betrothing ceremonies (*sponsalia*), and of the כתובה (*ketubah*) (*ibellus dotis*), or portion of property allotted to a woman by special engagement, and to which she was entitled on the marriage day, after the decease of the husband, or in case of repudiation; others, again, the absence of the latter alone.

The Roman law calls concubinage, an allowed custom (*licita consuetudo*). When this expression occurs in the constitutions of the Christian emperors, it signifies what we now sometimes call a *marriage of conscience*. The concubinage tolerated among the Romans, in the time of the Republic and of the heathen emperors, was that between persons not capable of contracting legal marriage. Inheritances might descend to children that sprung from such a tolerated cohabitation.

Concubinage between such persons they looked on as a kind of marriage, and even allowed it several privileges; but then it was confined to a single person, and was of perpetual obligation, as much as marriage itself. Hottoman observes, that the Romans had allowed concubinage long before Julius Caesar enacted the law by which every one was at liberty to marry as many wives as he pleased. The emperor Valentinian, Socrates tells us, allowed every man two. Concubinage is also used to signify a marriage with a woman of inferior condition, to whom the husband does not convey his rank. Dajos (Paratilla) observes, that the ancient laws allowed a man to espouse, under the title of concubine, certain persons who were esteemed unequal to him, on account of the want of some qualities requisite to sustain the full honour of marriage; and he adds, that though such concubinage was beneath marriage both as to dignity and civil rights, yet was concubine a reputable title, and very different from that of 'mistress' among us. The connection was considered so lawful that the concubine might be accused of adultery in the same manner as a wife.

This kind of concubinage is still in use in some countries, particularly in Germany, under the title of half-ehe (half-marriage), or left-hand marriage, in allusion to the manner of its being contracted, namely, by the man giving the woman his left hand instead of the right. This is a real marriage, though without the usual solemnity, and the parties are both bound to each other for ever, though the female cannot bear the husband's name and title.—E. M.

CONEY. [SHAPHAN.]

CONFLAGRATION, GENERAL. The opinion that the end of the world is to be effected by the agency of fire is very ancient, and was common amongst heathen philosophers (Quid was common amongst heathen philosophers (Quid, *Metamorph.* i. 256). Other testimonies are quoted by Grotius (*De Veritate Rel. Chr.*, lib. i. § 22). It is not easy to discover the origin of this opinion; it can scarcely be traced to tradition derived from revelation, since there is no distinct reference to such a catastrophe in the Old Testament. It is, moreover, remarkable, considering how universal and definite is the ordinary belief on the subject, that there is only one passage in the New Testament, viz., 2 Pet. iii. 7-10, which can be adduced as speaking distinctly of this event. This passage is, indeed, very explicit, but it should not be forgotten that some learned and able expositors have referred it altogether to the destruction of Jerusalem and of the Jewish polity. Amongst those who have held this opinion are Dr. Lightfoot (*Horæ Hebr.* in Job. 21, 22) and Dr. John Owen (*Θεολογούμενα*, ed. Bremen, 1684, p. 147, quoted by Dr. Pye Smith, *Scripture and Geology*, sect. 6, p. 233, 1st ed.). If, however, with the majority of interpreters, we refer the prediction to the end of the world, to which it seems most naturally to apply, we could not have a more distinct statement of the fact that the present order of things is to be terminated by the world we inhabit and all the works of man it contains being 'burnt up.' There is no reason for assuming that the whole material universe is to be involved in this catastrophe; the mention of the heavens leads our thoughts no further than the atmosphere and vapours surrounding this planet. Nor should we regard this

conflagration as involving the absolute *destruction* or annihilation of the world: it is more consistent with the narrative itself, as well as with physical science, to consider it as introductory to a new and better state of things—'new heavens and a new earth wherein dwelleth righteousness' (ver. 11). By what means the conflagration is to be effected we are not informed, and all attempts to explain how this is to be accomplished must be mere speculation, into which we do not think it necessary or advantageous to enter. We have only at present to remark that such an event is not inconsistent with physical facts. We know that the temperature of the earth increases gradually and with considerable regularity as we descend below the surface (Phillips, *Geology*, vol. ii. p. 232), and have every reason to believe that the central mass is intensely hot. We know, moreover, that there are subterranean fires of great extent, if not forming part of this heated central mass. The means, therefore, of combustion are near at hand. But even if there were no such central heat, chemistry points out very easy means by which the conflagration may be effected through the agency of various elementary substances (Phillips, *Geology*, vol. ii. p. 211). We find evidence also in the pyrogenous rocks which form so large a part of the crust of the earth, that the world has already been subjected, if not to conflagration, yet to a more intense and general action of heat than any which is now observed on the surface of the earth; and it is clearly not impossible that the action may be yet more intense and more general. In speculating on this subject, however, the caution of Calvin should not be disregarded—'Mali ergo sunt interpretes, qui in argutis speculationibus multum consumunt operæ, quum apostolus totam hanc doctrinam ad pias exhortationes accommodet' (Calvin, *Comm. in 2 Pet.* iii. 10).—

F. W. G

CONIAH. [JECONIAH.]

COOS (Κῶς), Cos or Co (now Stan-Co or Stanchio), a small and fertile island in the *Ægeæ* Sea, near the coast of Caria, in Asia Minor, almost between the promontories on which the cities Cnidus and Halicarnassus were situated. It was celebrated for its wine, silks, and cotton of a beautiful texture. The island is mentioned in 1 Macc. xv. 23; Acts xxi. 1.

COPPER (תְּנַיִם). Tubal-cain is recorded as the first artificer in brass and iron (Gen. iv. 22). In the time of Solomon, Hiram of Tyre was celebrated as a worker in brass (1 Kings vii. 14; comp. 2 Chron. ii. 14). To judge from Hesiod (*Op. et Dies*, 131), and Lucret. (v. 1285), the art of working in copper was even prior to that in iron, probably from its being found in larger masses, and from its requiring less labour in the process of manufacture. Palestine abounded in copper (Deut. viii. 9), and David left behind him an immense quantity of it to be employed in building the temple (1 Chron. xxii. 3-14). Of copper were made all sorts of vessels in the Tabernacle and Temple (Lev. vi. 28; Num. xvi. 39; 2 Chron. iv. 16; Ezr. viii. 27), weapons, and more especially helmets, armour, shields, spears, (1 Sam. xvii. 5, 6, 38; 2 Sun. xxi. 16), also chains (Judg. xvi. 21), and mirrors (Exod. xxxviii. 8). The larger vessels were moulded in founderies, as also the pillar

for architectural ornaments (1 Kings vii.) It would however appear (1 Kings vii. 14) that the art of copper-founding was, even in the time of Solomon, but little known among the Jews, and was peculiar to foreigners, particularly the Phœnicians. Michaelis (*Mos. Recht*, iv. 217, 314) observes, that Moses seems to have given to copper vessels the preference over earthen, and on that ground endeavours to remove the common prejudice against their use for culinary purposes. From copper, also, money was coined (Matt. x. 9).—E. M.

CORAL, a hard, cretaceous marine production, arising from the deposit of calcareous matter by a minute polytous animal, in order to form the cell or polygidium into whose hollows the tenant can wholly or partially retire. The corals thus produced are of various shapes, most usually branched like a tree. The masses are often enormous in the tropical seas, where they top the reefs and cap the submarine mountains, frequently rising to or near the surface so as to form what are called coral islands and coral reefs. These abound in the Red Sea; from which, most probably, was derived the coral with which the Hebrews were acquainted; but coral is also found in the Mediterranean. It is of different colours, white, black, red. The red kind was anciently, as at present, the most valued, and was worked into various ornaments. Coral is usually understood to be denoted by the word רַמּוֹת *ramoth*, in Job xxviii. 18; Ezek. xxviii. 16; and this interpretation is not unsuitable, although the etymology is not well made out, and the dialects afford little support. The ancient translators were evidently much perplexed to determine whether the word פְּנִינִים *peninim* (Job. xxviii. 18; Prov. iii. 15; viii. 11; xx. 15; xxxi. 10; Lam. iv. 7) meant corals or pearls. This will always be doubtful: but the text in Lament. iv. 7, by describing the article as *red*, suggests a preference of the former. Winer indeed remarks (*Realwörterbuch*, s. v. Korallen), that it is scarcely credible such a product should have circulated under two different names (if *ramoth* also means coral): but surely there is no difficulty in conceiving that one word may have denoted coral generally, while another may have distinguished that *red coral*, which was the most esteemed and the most in use for ornament.

CORBAN (קֶרְבָּן; N. T. Κορβάν), a Hebrew word employed in the Hellenistic Greek, just as the corresponding Greek word δῶρον was employed in the Rabbinical Hebrew (Buxtorf, *Lex. Rab.* col. 579) to designate an oblation of any kind to God. It occurs only once in the New Testament (Mark vii. 11), where it is explained (as also by Josephus, *Antiq.* l. 4, c. 4, § 4, *Contra Ap.* l. 1, § 22) by the word δῶρον. There is some difficulty in the construction and exact meaning of this passage and the corresponding one, Matt. xv. 5. The grammatical difficulty arises from the sentence being apparently incomplete. This difficulty our translators, following Beza, solve by supplying the words 'he shall be free' (*insons erit*). Most critics, however, regard the following verse (Matt. x. 6, Mark vii. 12) as the apodosis of the sentence, the *kal* being redundant 'more Hebraeo,' according to Grotius, or rather serving to indicate the conclusion (De Wette, *Kurze Erklärung des Ev. Matt.*, p. 151; see also Winer, *Gram. der N. T. Sprachidioms*,

§ 66, p. 537). The more important point, however, is to ascertain the precise meaning of the expression κορβάν (ὃ ἐστὶ δῶρον) ὃ ἐὰν ἐξ ἐμοῦ ὠφελῆθῃς. Many interpreters, at the head of whom stands Beza, supply ἐστὶ after the word κορβάν, and suppose that a gift of the property of the son had actually been made to the service of God (see Olshausen, *Biblischer Commentar.* on Matt. xv. 5). The sense is then, 'Whatever of mine might benefit thee is corban, is already dedicated to God, and I have therefore no power over it.' Others, more correctly, as we think, supply ἔσω rather than ἐστὶ, and translate, 'Be it corban. (that is, devoted) whatever of mine shall profit thee' (Campbell's translation, see his note on the passage). Lightfoot (*Hor. Hebr.* on Matt. xv. 5) notices a formula of frequent occurrence in the Talmud (in the treatises Nedarim and Nazir) which seems to be exactly that quoted by our Lord, קֶרְבָּן שְׂאֵנִי נִהְנֶה לִי, '[Be it] corban, [as to] which I may be profitable to thee.' He, as well as Grotius, shows that this and similar formulæ were not used to signify that the thing was actually devoted, but was simply intended to prohibit the use of it from the party to whom it was thus made corban, as though it were said, 'If I give you anything or do anything for you, may it be as though I gave you that which is devoted to God, and may I be accounted perjured and sacrilegious. This view of the passage certainly gives much greater force to the charge made by our Lord that the command 'Whoso curseth father or mother let him die the death' was nullified by the tradition. It would, indeed, seem surprising that such a vow as this (closely analogous to the modern profanity of imprecating curses on one's self if certain conditions be not fulfilled) should be considered to involve a religious obligation from which the party could not be freed even if afterwards he repented of his rashness and sin. It appears, however, from Rabbinical authority that anything thus devoted was irreclaimable (Grotius, *Annotations in Matt.* xv. 5), and that the hasty utterance of a word implying a vow was equivalent to a vow formally made (Lightfoot, *Hor. Hebr.*). This, indeed, seems to be the force of the expression used in Mark, καὶ οὐκέτι ἀφιέτε, κ. τ. λ., 'ye suffer him no more to do ought for his father or his mother.' A more striking instance of the subversion of a command of God by the tradition of men can hardly be conceived.—F. W. G.

CORIANDER. [GAD.]

CORINTH, a Grecian city, placed on the isthmus which joins Peloponnesus (now called the Morea) to the continent of Greece. A lofty rock rises above it, on which was the citadel, or the Acrocorinthus (Livy, xlv. 28). It had two harbours: Cenchræa, on the eastern side, about 70 stadia distant; and Lechæum, on the modern Gulf of Lepanto, only 12 stadia from the city (Strabo, viii. 6). Its earliest name, as given by Homer, is *Ephyre*; and mysterious legends connect it with Lycia, by means of the hero Belleophon, to whom a plot of ground was consecrated in front of the city, close to a cypress grove (Pausanias, ii. 2). Owing to the great difficulty of weathering Malea, the southern promontory of Greece, merchandise passed through Corinth from sea to sea; the city becoming an *entrepôt* for the

goods of Asia and Italy (Strabo, viii. 6). At the same time it commanded the traffic by land from north to south. An attempt made to dig through the isthmus was frustrated by the rocky nature of the soil; at one period, however, they had an invention for drawing galleys across from sea to sea on trucks. With such advantages of position, Corinth was very early renowned for riches, and seems to have been made by nature for the capital of Greece. The numerous colonies which she sent forth, chiefly to the west and to Sicily, gave her points of attachment in many parts; and the good will, which, as a mercantile state, she carefully maintained, made her a valuable link between the various Greek tribes. The public and foreign policy of Corinth appears to have been generally remarkable for honour and justice (Herod. and Thucyd. *passim*); and the Isthmian

games, which were celebrated there every other year, might have been converted into a national congress, if the Corinthians had been less peaceful and more ambitious.

When the Achaean league was rallying the chief powers of southern Greece, Corinth became its military centre; and as the spirit of freedom was active in that confederacy, they were certain, sooner or later, to give the Romans a pretence for attacking them. The fatal blow fell on Corinth (B.C. 146), when L. Mummius, by order of the Roman Senate, barbarously destroyed that beautiful town (Cicero, *Ferr.* i. 21), eminent even in Greece for painting, sculpture, and all working in metal and pottery; and as the territory was given over to the Sicyonians (Strabo, *l. c.*), we must infer that the whole population was sold into slavery.

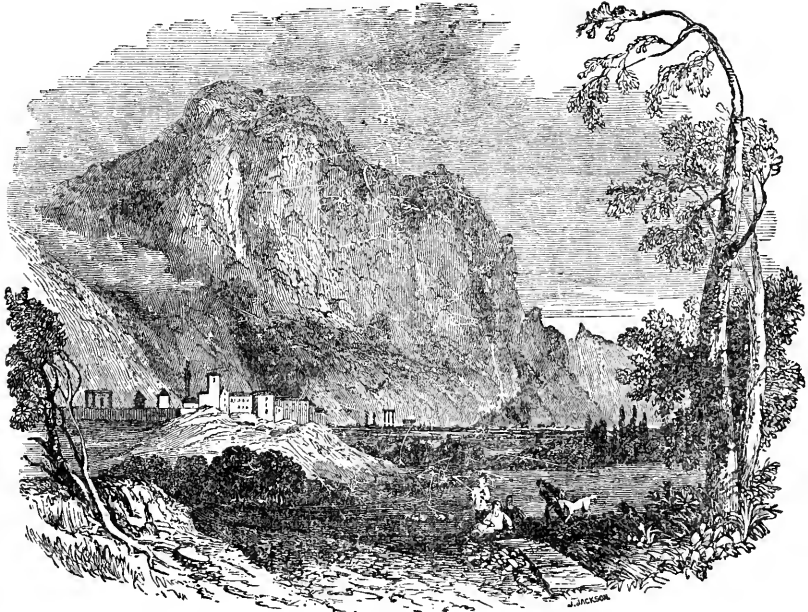

235. [Corinth.]

The Corinth of which we read in the New Testament was quite a new city, having been rebuilt and established as a Roman colony, and peopled with freedmen from Rome (Pausanias and Strabo, *u. s.*) by the dictator Cæsar, a little before his assassination. Although the soil was too rocky to be fertile, and the territory very limited, Corinth again became a great and wealthy city in a short time, especially as the Roman proconsuls made it the seat of government (Acts xviii.) for southern Greece, which was now called the province of Achaia. In earlier times Corinth had been celebrated for the great wealth of its Temple of Venus, which had a gainful traffic of a most dishonourable kind with the numerous merchants resident there—supplying them with harlots under the forms of religion. The same phenomena, no doubt, reappeared in the later and Christian age. The little which is said in the New Testament seems to indicate a wealthy and

luxurious community, prone to impurity of morals; nevertheless, all Greece was so contaminated, that we may easily overcharge the accusation against Corinth.

The Corinthian Church is remarkable in the Epistles of the Apostle Paul by the variety of its spiritual gifts, which seem for the time to have eclipsed or superseded the office of the elder or bishop, which in most churches became from the beginning so prominent. Very soon, however, this peculiarity was lost, and the bishops of Corinth take a place co-ordinate to those of other capital cities. One of them, Dionysius, appears to have exercised a great influence over many and distant churches, in the latter part of the second century (Eusebius, *Hist. Eccles.* iv. 23).—F. W. N.

CORINTHIANS, EPISTLES TO THE.—FIRST EPISTLE. The testimony of Christian antiquity is full and unanimous in ascribing this inspired production to the pen of the Apostle Paul

(Lardner's *Credibility*, Works, vol. ii. *plur. loc.*; see also Heydenreich, *Comment. in priorem D. Pauli ad Cor. epist. Proleg.* p. 30; Schott, *Isagoge in N. T.* pp. 236, 239, sqq.), and with this the internal evidence arising from allusions, undesigned coincidences, style, and tone of thought, fully accords. The epistle seems to have been occasioned partly by some intelligence received by the Apostle concerning the Corinthian church from the domestics of Chloe, a pious female connected with that church (i. 11), and, probably, also from common report (*ἀκοῦσαι*, v. i.); and partly by an epistle which the Corinthians themselves had addressed to the Apostle, asking advice and instruction on several points (vii. 1), and which probably was conveyed to him by Stephanas, Fortunatus, and Achaicus (xvi. 17). Apollos, also, who succeeded the Apostle at Corinth, but who seems to have been with him at the time this epistle was written (xvi. 12), may have given him information of the state of things among the Christians in that city. From these sources the Apostle had become acquainted with the painful fact that since he had left Corinth (Acts xviii. 18) the church in that place had sunk into a state of great corruption and error. One prime source of this evil state of things, and in itself an evil of no inferior magnitude, was the existence of schisms or party divisions in the church. 'Every one of you,' Paul tells them, 'saith I am of Paul, and I of Apollos, and I of Cephas, and I of Christ' (i. 12). This has led to the conclusion that four great parties had arisen in the church, which boasted of Paul, Apollos, Peter, and Christ, as their respective heads. By what peculiarities of sentiment these parties may be supposed to have been distinguished from each other it is not difficult, with the exception of the last, to conjecture. The existence in many of the early churches of a strong tendency towards the ingrafting of Judaism upon Christianity is a fact well known to every reader of the New Testament; and though the church at Corinth was founded by Paul and afterwards instructed by Apollos, yet it is extremely probable that as in the churches of Galatia so in those of Achaia this tendency may have been strongly manifested, and that a party may have arisen in the church at Corinth opposed to the liberal and spiritual system of Paul, and more inclined to one which aimed at fettering Christianity with the restrictions and outward ritual of the Mosaic dispensation. That this party received any countenance from Peter cannot for a moment be supposed; but that they might, for the sake of giving greater authority to their own doctrines, have made use of the name of the great 'Apostle of the circumcision' by assigning it to their party, appears extremely probable. The vehement opposition of this party to Paul, and their pointed attack upon his claims to the Apostolic office, would naturally lead those who had been Paul's converts and who probably formed the major part of the church to rally round his pretensions and the doctrines of a pure and spiritual Christianity which he taught. Closely allied with this party, and in some respects only a subdivision of it, was that of Apollos. This distinguished individual was not only the friend of Paul, but had followed up Paul's teaching at Corinth in a congenial spirit and to a harmonious result (iii. 5, &c.). Between

the party, therefore, assuming his name and that ranking itself under the name of the Apostle there could be no substantial ground of difference. Perhaps, as Apollos had the advantage of Paul in mental polish, and especially in facility in public speaking (Acts xviii. 24; comp. 2 Cor. x. 10), the sole ground on which his party may have preferred him was the higher gratification he afforded by his addresses to their educated taste than was derived from the simple statements of the Apostle concerning 'Christ and him crucified.' Thus far all, though almost purely conjectural, is easy and probable; but in relation to the fourth party—that which said, 'I am of Christ,'—it has been found extremely difficult to determine by what peculiar sentiments they were distinguished. The simplest hypothesis is that of Eichhorn (*Eintleit.* iii. 107), Schott (*Isagoge in Nov. Test.* p. 233), Pott (*Nov. Test. Koppian.* vol. v. part i. p. 25), and others, viz. that this party was composed of the better sort in the church, who stood neutral and did not mingle in the contentions of the other parties. This opinion is chiefly based on 1 Cor. iii. 22, 23, where it is supposed the four parties are alluded to and that of Christ alone commended. But this seems a forced and improbable interpretation of that passage; the words *ἡμεῖς δὲ Χριστοῦ* being much more naturally understood as applying to all the Corinthians, than as describing only a part of them. This opinion, moreover, hardly tallies with the language of the Apostle concerning the Christ-party, in 1 Cor. i. 12, and 2 Cor. x. 7, where he evidently speaks of them in terms of censure, and as guilty of dividing Christ. Another hypothesis is that suggested by Storr (*Notitia Historica epistoll. ad Cor. interpretationi servientes. Opusc. Acad.* vol. ii. p. 212), and which has been followed, among others, by Hug (Introd. II. p. 371, Eng. Tr.), Bertholdt (*Eintl.* s. 3320), and Krause (*Pauli ad Cor. Epistole Græce. Perpetua annot. illustr. Proleg.* p. 35), viz. that the Christ-party was one which, professing to follow James and the other brethren of the Lord, as its heads, claimed to itself, in consequence of this relationship, the title *οἱ τοῦ Χριστοῦ*, by way of eminence. To this it has been objected, that had the party in question designed, by the name they assumed, to express the relationship of their leader to Jesus Christ, they would have employed the words *οἱ τοῦ κυρίου*, not *οἱ τοῦ Χριστοῦ*, the former being more correctly descriptive of a personal, and the latter of an official, relationship. Besides, as Olshausen remarks, 'the party of James could not be precisely distinguished from that of Peter; both must have been composed of strenuous Jew-Christians. And, in fine, there is a total absence of all positive grounds for this hypothesis. . . . The mere naming of "the brethren of the Lord" in 1 Cor. ix. 5, and of James in 1 Cor. xv. 7, can prove nothing, as this is not in connection with any strictures on the Christ-party, or indeed on any party, but entirely incidentally; and the expression *γινώσκου Χριστὸν κατὰ σάρκα* (2 Cor. v. 16) refers to something quite different from the family-relations of the Saviour: it is designed to contrast the purely human aspect of his existence with his eternal heavenly essence' (*Biblische Comment.* bd. iii. abt. 1, s. 457; Comp. Billroth's *Commentary on the Corinthians*, vol. i. p. 11, Eng. Tr.). In an able treatise which appeared

in the Tübingen *Zeitschrift für Theologie* for 1831, part iv. p. 61, Professor Baur has suggested that, properly speaking, there were only two parties in the Corinthian Church—the Pauline and the Petrine; and that, as that of Apollos was a subdivision of the former, that of Christ was a subdivision of the latter. This subdivision, he supposes, arose from the opposition offered by the Petrine party to Paul, which led some of them to call in question the right of the latter to the apostleship, and to claim for themselves, as followers of Peter, a closer spiritual relationship to the Saviour, the honour of being the alone genuine and apostolically-designated disciples of Christ. This opinion is followed by Billroth, and has much in its favour; but the remark of Neander, that ‘according to it the Christ-party would be discriminated from the Petrine only in name, which is not in keeping with the relation of this party-appellation to the preceding party-names,’ has considerable weight as an objection to it. Neander himself, followed by Olshausen, supposes that the Christ-party was composed of persons ‘who repudiated the authority of all these teachers, and independently of the apostles, sought to construct for themselves a pure Christianity, out of which probably they cast everything that too strongly opposed their philosophical ideas as a mere foreign addition. From the opposition of Hellenism and Judaism and from the Helleno-philosophical tendency at Corinth, such a party might easily have arisen. . . . To such the Apostles would seem to have mixed too much that was Jewish with their system, and not to have presented the doctrines of Christ sufficiently pure. To Christ alone, therefore, would they professedly appeal, and out of the materials furnished them by tradition, they sought, by means of their philosophic criticism, to extract what should be the pure doctrine of Christ’ (*Apostol. Zeitalt.* s. 205; vol. i. p. 273 of Eng. Tr.). The reasoning of the Apostle in the 1st, 2nd, 12th, 13th, 14th, and 15th chapters of the 1st Epistle seems clearly to indicate that some such notions as these had crept into the Church at Corinth; and, upon the whole, this hypothesis of Neander commends itself to our minds as the one which is best maintained and most probable. At the same time, we have serious doubts of the soundness of the assumption on which all these hypotheses proceed, viz. that there really were in the Corinthian church sects or parties specifically distinguished from each other by peculiarities of doctrinal sentiment. That erroneous doctrines were entertained by individuals in the church, and that a schismatical spirit prevailed it, cannot be questioned; but that these two stood formally connected with each other may fairly admit of doubt. Schisms often arise in churches from causes which have little or nothing to do with diversities of doctrinal sentiment among the members; and that such were the schisms which disturbed the church at Corinth appears to us probable, from the circumstance that the existence of these is condemned by the Apostle, without reference to any doctrinal errors out of which they might arise; whilst, on the other hand, the doctrinal errors condemned by him are denounced without reference to their having led to party strifes. From this we are inclined to the opinion that the schisms arose merely from quarrels among the Corinthians as to the comparative

excellence of their respective teachers—those who had learned of Paul boasting that he excelled all others, and the converts of Apollos and Peter advancing a similar claim for them, whilst a fourth party haughtily repudiated all subordinate teaching, and pretended that they derived all their religious knowledge from the direct teaching of Christ. The language of the Apostle in the first four chapters, where alone he speaks directly of these schisms, and where he resolves their criminality not into their relation to false doctrine, but into their having their source in a disposition to glory in men, must be regarded as greatly favouring this view. Comp. also 2 Cor. v. 16.

Besides the schisms and the erroneous opinions which had invaded the Church at Corinth, the Apostle had learned that many immoral and disorderly practices were tolerated among them, and were in some cases defended by them. A connection of a grossly incestuous character had been formed by one of the members, and gloried in by his brethren (v. 1, 2); law-suits before heathen judges were instituted by one Christian against another (vi. 1); licentious indulgence was not so firmly denounced and so carefully avoided as the purity of Christianity required (vi. 9-20); the public meetings of the brethren were brought into disrepute by the women appearing in them unveiled (xi. 3-10), and were disturbed by the confused and disorderly manner in which the persons possessing spiritual gifts chose to exercise them (xii.-xiv.); and in fine the *αἰῶναι*, which were designed to be scenes of love and union, became occasions for greater contention through the selfishness of the wealthier members, who, instead of sharing in a common meal with the poorer, brought each his own repast, and partook of it by himself, often to excess, while his neely brother was left to fast (xi. 20-34). The judgment of the Apostle had also been solicited by the Corinthians concerning the comparative advantages of the married and the celibate state (vii. 1-40), as well as, apparently, the duty of Christians in relation to the use for food, of meat which had been offered to idols (viii. 1-13). For the correction of these errors, the remedying of these disorders, and the solution of these doubts, this epistle was written by the Apostle. It consists of four parts. The first (i.-iv.) is designed to reclaim the Corinthians from schismatic contentions; the second (v.-vi.) is directed against the immoralities of the Corinthians; the third (vii.-xiv.) contains replies to the queries addressed to Paul by the Corinthians, and strictures upon the disorders which prevailed in their worship; and the fourth (xv.-xvi.) contains an elaborate defence of the Christian doctrine of the resurrection, followed in the close of the epistle by some general instructions, intimations, and greetings.

From an expression of the Apostle in ch. v. 9, it has been inferred by many that the present was not the first epistle addressed by Paul to the Corinthians, but that it was preceded by one now lost. For this opinion, however, the words in question afford a very unsatisfactory basis. They are as follows:—*ἔγραψα ὑμῖν ἐν τῇ ἐπιστολῇ, κ. τ. λ.* Now these words must be rendered either ‘I have written to you in this epistle,’ or ‘I wrote to you in that epistle;’ and our choice between these two renderings will depend partly on grammatical and partly on historical grounds. As the

οριστ ἔγραψα may mean either 'I wrote' or 'I have written,' nothing can be concluded from it in either way. It may be doubted, however, whether, had the Apostle intended to refer to a former epistle, he would have used the article τῆ simply, without adding προτέρα; whilst on the other hand there are cases which clearly show that had the Apostle intended to refer to the present epistle, it was in accordance with his practice to use the article in the sense of 'this' (comp. ἡ ἐπιστολὴ Coloss. iv. 16, τὴν ἐπιστ. 1 Thess. v. 27). In support of this conclusion it may be added, 1st, that the Apostle had really in this epistle given the prohibition to which he refers, viz., in the verses immediately preceding that under notice; and that his design in the verses which follow is so to explain that prohibition as to preclude the risk of their supposing that he meant by it anything else than that in the church they should not mingle with immoral persons; 2nd, that it is not a little strange that the Apostle should, only in this cursory and incidental manner, refer to a circumstance so important in its bearing upon the case of the Corinthians as his having already addressed them on their sinful practices; and 3rd, that had such an epistle ever existed, it may be supposed that some hint of its existence would have been found in the records of the primitive Church, which is not the case. On these grounds we strongly incline to the opinion that the present is the first epistle which Paul addressed to the Corinthians (Bloomfield, *Recessio Synopt.* in loc.; Billroth's *Commentary*, Eng. Tr., vol. i. p. 4, note a).

From 2 Cor. xii. 14, and xiii. 1, compared with 2 Cor. ii. 1, and xiii. 2, it appears that before the writing of that epistle Paul had twice visited Corinth, and that one of these visits had been after the Church there had fallen into an evil state; for otherwise his visit could not have been described as one ἐν λύπῃ, and one during which God had humbled him before them. Did this second visit to Corinth precede also the writing of the first epistle? On this point the Acts give us no help, as the writer is totally silent concerning this second visit of Paul to Corinth. But we may safely infer from 2 Cor. i. 15, 16, 23, that Paul had not been at Corinth between the writing of the first and second epistles, so that we must place his second visit before the writing of the first epistle. When this second visit took place we can only conjecture; but Billroth's suggestion that it was made some time during the period of Paul's residence of three years at Ephesus (Acts xx. 31), perhaps on the first reception of unpleasant news from Corinth, is extremely probable. Supposing the Apostle to have made this short visit and to have returned to Ephesus, this first epistle may have been written either in that city or in Macedonia, through which Paul probably journeyed on his way from Corinth to Ephesus. This latter is the traditional opinion (see the addition to ch. xiii. in some MSS.), and is greatly favoured by the way in which Paul speaks of Ephesus (1 Cor. xv. 32) as a place in which he had been rather than one in which he was when writing this epistle. From the allusion to the Passover in ch. v. 7, 8, most have inferred that the epistle was written at the time of Easter; but this does not necessarily follow from the Apostle's allusion. As to the year, great diversity of opinion prevails, but most

are agreed that it was not earlier than 56 no., later than 59.

The subscription above referred to intimates that this epistle was conveyed to Corinth by Stephanus, Fortunatus, Achaicus, and Timothy. As respects the last named there is evidently a mistake, for from ch. xvi. 10, it appears that Timothy's visiting Corinth was a thing not certain when this letter was finished, and from 2 Cor. viii. 17, 18, it appears that Timothy did not visit Corinth till afterwards. Comp. also Acts xix. 22. As respects the others, this tradition is probably correct.

SECOND EPISTLE. Not long after the transmission of the first epistle, the Apostle left Ephesus in consequence of the uproar excited against him by Demetrius the silversmith, and betook himself to Troas (Acts xix. 23, sq.). Here he expected to meet Titus with intelligence from Corinth of the state of things in that church. According to the common opinion Titus had been sent by Paul to Corinth, partly to collect money in aid of the distressed Christians in Palestine, partly to observe the effect of the Apostle's first epistle on the Corinthians; but Billroth, Rückert, and others, rather suppose him to have been sent before the writing of the first epistle solely for the former of these purposes, and that he remained in Corinth till after the reception by the church there of that epistle, while Bleek (*Studien und Kritiken*, Jahrg. 1830, s. 625; comp. Neander's *Hist. of the Apostolic Age*, vol. i. p. 312, Eng. Tr.) suggests that Titus may have been despatched with an epistle now lost, and written between the first and second of those still extant. This hypothesis of a 'lost epistle' seems to be the convenient resource of the German critics for the removal of all difficulties, but in the absence of any direct evidence in its support, it cannot, in this case, be admitted to be worthy of consideration. Billroth's hypothesis rests also upon a very unstable basis, as Neander shows, by whom the common opinion is espoused and defended (vol. i. p. 312). In this expectation of meeting Titus at Troas, Paul was disappointed. He accordingly went into Macedonia, where, at length, his desire was gratified, and the wished-for information obtained (2 Cor. ii. 13; vii. 15, sq.).

The intelligence brought by Titus concerning the church at Corinth was on the whole favourable. The censures of the former epistle had produced in their minds a godly sorrow, had awakened in them a regard to the proper discipline of the church, and had led to the exclusion from their fellowship of the incestuous person. This had so wrought on the mind of the latter that he had repented of his evil courses, and showed such contrition that the Apostle now pities him, and exhorts the church to restore him to their communion (2 Cor. ii. 6-11; vii. 8, sq.). A cordial response had also been given to the appeal that had been made on behalf of the saints in Palestine (ix. 2). But with all these pleasing symptoms there were some of a painful kind. The anti-Pauline influence in the church had increased, or at least had become more active; and those who were actuated by it had been seeking by all means to overturn the authority of the Apostle, and discredit his claims as an ambassador of Christ.

This intelligence led the Apostle to compose

his second epistle, in which the language of commendation and love is mingled with that of censure, and even of threatening. This epistle may be divided into three sections. In the first (i.-iii.) the Apostle chiefly dwells on the effects produced by his first epistle and the matters therewith connected. In the second (iv.-ix.) he discourses on the substance and effects of the religion which he proclaimed, and turns from this to an appeal on behalf of the claims of the poor saints on their liberality. And in the third (x.-xiii.) he vindicates his own dignity and authority as an apostle against the parties by whom these were opposed. The divided state of feeling in the Apostle's mind will account sufficiently for the difference of tone perceptible between the earlier and later parts of this epistle, without our having recourse to the arbitrary and capricious hypothesis of Semler (*Dissert. de duplici appendice Ep. ad Rom. Hal. 1767*) and Weber (*Prog. de numero epp. ad Cor. rectius constituendo, Vitem. 1798*) whom Paulus follows, that this epistle has been extensively interpolated.

Besides the commentaries of Pott, Krause, Heydenreich, Billroth, Rückert, and Olshausen, to which reference has already been made in this article, that of Emmerling on the Second Epistle (*Ep. Pauli ad Cor. Posterior Græcæ. Perpet. Comment. illust. Lips. 1823*); that of Barnes on the First Epistle (New York, 1838, 12mo.; Lond. 1841, 8vo.); and that of Flatt on both Epistles (*Vorlesungen üb. die Br. an d. Corinth. Tüb. 1827*) deserve to be noticed.—W. L. A.

CORMORANT. [SALACH.]

CORN. The word כֹּרֶן *dagan*, which is rendered 'grain,' 'corn,' and sometimes 'wheat' in the Authorized Version, is the most general of the Hebrew terms representing 'corn,' and is more comprehensive than any word in our language, seeing that it probably includes not only all the proper corn-grains, but also various kinds of pulse and seeds of plants, which we never comprehend under the name of 'corn' or even of 'grain.' כֹּרֶן may, therefore, be taken to represent all the commodities which we describe by the different words corn, grain, seeds, pease, beans. Among other places in which this word occurs, see Gen. xxvii. 28-37; Num. xviii. 27; Deut. xxviii. 51; Lam. ii. 12, &c. There is another word, בָּר *bar*, which denotes any kind of cleansed corn, that is, corn purified from the chaff and fit for use (Gen. xli. 35-49; *Prov.* xi. 26; Jer. iv. 11; Joel ii. 24). The same word is more rarely used to describe corn in a growing state (Ps. lxxv. 13), in which sense it may be compared with the Arabic كَرْم, and the Latin *far*. The word שֶׁבֶר *sheber*, which is sometimes rendered corn, denotes in a general sense 'provisions' or 'victuals,' and by consequence 'corn,' as the principal article in all provisions (Gen. xlii. 1, 2, 20; Exod. viii. 5; Neh. x. 32, &c.).

The different products coming under the denomination of corn, are noticed under the usual heads, as BARLEY, WHEAT, &c.; their culture, under AGRICULTURE; their preparation, under BREAD, FOOD, MILK, &c.

CORNELIUS. The centurion of this name, whose history occurs in Acts x., most probably belonged to the Cornelii, a noble and distinguished

family at Rome. He is reckoned by Julian the Apostate as one of the few persons of distinction who embraced Christianity. His station in society will appear upon considering that the Roman soldiers were divided into legions, each legion into ten cohorts, each cohort into three bands, and each band into two centuries or hundreds; and that Cornelius was a commander of one of these centuries (*ἐκατοντάρχης*), belonging to the *Italic* band; so called from its consisting chiefly of Italian soldiers, formed out of one of the six cohorts granted to the procurators of Judæa, five of which cohorts were stationed at Cæsarea, the usual residence of the procurators (Jahn, *Biblische Archæologie*, ii. Th., s. 215, Wien, 1821). The religious position of Cornelius, before his interview with Peter, has been the subject of much debate. On the one side it is contended, that he was what is called a *proselyte of the gate*, or a Gentile, who, having renounced idolatry and worshipping the true God, submitted to the seven (supposed) precepts of Noah, frequented the synagogue, and offered sacrifices by the hands of the priests; but, not having received circumcision, was not reckoned among the Jews. In support of this opinion it is pleaded that Cornelius is styled *φοβούμενος τὸν Θεὸν* (a man fearing God), ver. 2, the usual appellation, it is alleged, for a proselyte of the gate, as in chap. xiii. 16, 26, and elsewhere; that he prayed at the usual Jewish hours of prayer (x. 30), that he read the Old Testament, because Peter refers him to the prophets (x. 43), and that he gave much alms to the Jewish people (x. 2, 22). On the other side it is answered that the phrases *φοβούμενοι τὸν Θεὸν*, and the similar phrases *εὐλαβεῖς*, and *εὐσεβεῖς*, are used respecting any persons imbued with reverence towards God (x. 35; Luke i. 50; ii. 25; Col. iii. 22; Rev. xi. 18); that he is styled by Peter *ἀλλόφυλος* (a man of another race or nation), with whom it was *unlawful* for a Jew to associate, whereas the law *allowed* for foreigners a perpetual residence among the Jews, provided they would renounce idolatry and abstain from blood (Lev. xvii. 10, 11, 13), and even commanded the Jews to love them (Lev. xix. 33, 34); that they mingled with the Jews in the synagogue (Acts xiv. 1), and in private life (Luke vii. 3); that, had Cornelius been a proselyte of the gate, his conversion to Christianity would not have occasioned so much surprise to the Jewish Christians (Acts x. 45), nor would 'they that were of the circumcision' have contended with Peter so much on his account (xi. 2); that he is expressly classed among the Gentiles by James (xv. 14), and by Peter himself, when claiming the honour of having first preached to the Gentiles (xv. 7); that the remark of the opposing party at Jerusalem, when convinced, 'thien hath God also to the Gentiles granted *repentance unto life*,' would have been inapplicable upon the very principles of those who assert that Cornelius was a proselyte, since they argue from the traditions of modern Jews, the most eminent of whom, Maimouides, admits a sincere proselyte *to be in a state of salvation*. The other arguments, derived from the observance of the Jewish hours of prayer by Cornelius, and his acquaintance with the Old Testament, are all resolvable into a view of his religious position, which will shortly be stated. The strongest objection against the supposition that Cornelius was

a proselyte of the gate arise from the very reasonable doubt whether any such distinction existed in the time of the apostles. Maimonides, indeed, speaks of it, but the lateness of the period at which he flourished, A.D. 1160, and the absence of any scriptural authority, require us to consider his assertions as referring to a time much later than that of the apostles. 'According to my idea,' says Bishop Tomline, 'proselytes were those, and those only, who took upon themselves the obligation of the whole Mosaic law, but retained that name till they were admitted into the congregation of the Lord, as adopted children. Gentiles were allowed to worship and offer sacrifices to the God of Israel in the outer court of the temple; and some of them, persuaded of the sole and universal sovereignty of the Lord Jehovah, might renounce idolatry without embracing the Mosaic law; but such persons appear to me never to be called proselytes in Scripture, or in any ancient Christian writer' (*Elements of Christian Theology*, vol. i. pp. 266, 267). Dr. Lardner has remarked that the notion of two sorts of proselytes is not to be found in any Christian writer before the fourteenth century (*Works*, vol. vi. pp. 522-533, 8vo. and vol. xi. pp. 313-321. See also Jennings's *Jewish Antiquities*, book i. chap. iii.). The arguments on the other side are ably stated in Townsend's *Chronological Arrangements of the New Testament*, vol. ii. p. 115, &c. London. On the whole, the position of Cornelius, in regard to religion, appears to us to have been in the last class of persons described by Bishop Tomline, consisting of Gentiles who had so far benefited by their contact with the Jewish people as to have become convinced that theirs was the true religion, who consequently worshipped the true God, were acquainted with the Scriptures of the Old Testament, most probably in the Greek translation, and observed several Jewish customs, as, for instance, their hours of prayer, or anything else that did not involve an act of special profession. This class of persons seems referred to in Acts xiii. 16, where they are plainly distinguished from the Jews, though certainly mingled with them. To the same class is to be referred Candace's treasurer (Acts viii. 27, &c.); and in earlier times, the midwives of Egypt (Exod. i. 17), Rahab (Josh. vi. 25), Ruth, Araunah the Jebusite (2 Sam. xxiv. 18, &c.), the persons mentioned 1 Kings viii. 41, 42, 43, Naaman (2 Kings v. 16, 17). See also Josephus, *Antiq.* xiv. 7, § 2, and his account of Alexander the Great going into the temple, and offering sacrifice to God, according to the direction of the High Priest, (*ibid.* xi. 8, § 5); of Antiochus the Great (*ibid.* xii. 3, § 3, 4), and of Ptolemy Philadelphus, (*ibid.* xii. 2, § 1, &c.). Under the influence of these facts and arguments, we regard Cornelius as having been selected of God to become *the firstfruits of the Gentiles*. His character appears suited, as much as possible, to abate the prejudices of the Jewish converts against what appeared to them so great an innovation. It is well observed by Theophylact, that Cornelius, though neither a Jew nor a Christian, lived the *life of a good Christian*. He was *εὐσεβής*, influenced by spontaneous reverence to God. He practically obeyed the restraints of religion, for he feared God, and this latter part of the description is extended to all his family or household (ver. 2). He was liberal in alms to the

Jewish people, which showed his respect for them; and he 'prayed to God always,' at all the hours of prayer observed by the Jewish nation. Such piety, obedience, faith, and charity, prepared him for superior attainments and benefits, and secured to him their bestowment (Ps. xxv. 9; 1. 23. Matt. xiii. 12; Luke viii. 15; John vii. 17).

The remarkable circumstances under which these benefits were conferred upon him are too plainly and forcibly related in Acts x. to require much comment. While in prayer, at the ninth hour of the day, he beheld, in waking vision, an angel of God, who declared that 'his prayers and alms had come up for a memorial before God,' and directed him to send to Joppa for Peter, who was then abiding 'at the house of one Simon, a tanner.' Cornelius sent accordingly; and when his messenger had nearly reached that place, Peter was prepared by the symbolical revelations of a nounday ecstasy, or trance, to understand that nothing which God had cleansed was to be regarded as common or unclean.

It is well remarked by Paley, that the circumstances of the two visions are such as to take them entirely out of the case of momentary miracles, or of such as may be accounted for by a *false perception*. 'The vision might be a dream; the message could not. Either communication taken separately might be a delusion; the concurrence of the two was impossible to happen without a supernatural cause.' (*Evidences*, prop. i. chap. 2). The inquiries of the messengers from Cornelius suggested to Peter the application of his vision, and he readily accompanied them to Joppa, attended by six Jewish brethren, and hesitated not to enter the house of one whom he, as a Jew, would regard as unclean. The Apostle waived the too fervent reverence of Cornelius, which, although usual in the East, was rendered by Romans only to their gods; and mutual explanations then took place between him and the centurion. After this the Apostle proceeded to address Cornelius and his assembled friends, and expressed his conviction that the Gentiles were no longer to be called unclean, and stated the leading evidence and chief doctrines of the Gospel. While he was discoursing, the miraculous gifts of the Holy Spirit, contrary to the order hitherto observed of being preceded by baptism and imposition of hands, fell on his Gentile auditors. Of this fact Peter and his companions were convinced, for they heard them speak with tongues, foreign and before unknown to them, and which Peter and his companions knew to be such by the aid of their own miraculous gifts, and, under divine impulse, glorify God as the author of the Gospel. The Jewish brethren who accompanied Peter were astonished upon perceiving, by these indubitable indications, that the Holy Spirit was poured out upon the Gentiles, as upon themselves at the beginning (x. 45). Peter, already prepared by his vision for the event, and remembering that baptism was by the command of Jesus, *associated* with these miraculous endowments, said, 'Can any man forbid water that these should be baptized, who have received the Holy Ghost as well as we?' and yet, agreeably to the apostolic rule of committing the administration of baptism to others, and, considering that the consent of the Jewish brethren would be more explicit if they performed the duty, he ordered *them* to baptize Cornelius and

his friends, his household, whose acceptance as members of the Christian church had been so abundantly testified.—J. D. F.

CORNER-STONE. The symbolical title of 'chief corner stone' (*λίθος ἀκρογωνιαίος*) is applied to Christ in Eph. ii. 20, and 1 Pet. ii. 8, 16, which last passage is a quotation from Isa. xxviii. 16, where the Septuagint has the same words for the Hebrew פִּנֵּה אֲבֵן. There seems no valid reason for distinguishing this from the stone called 'the head of the corner' (*κεφαλὴ γωνίας*, Matt. xxi. 42; which is the Sept. translation of פִּנֵּה רֶאִשׁ in Ps. cxviii. 22), although some contend that the latter is the top-stone or coping. The *λίθος ἀκρογωνιαίος* or 'corner-stone' was a large and massive stone so formed as when placed at a corner, to bind together two outer walls of an edifice. This properly makes no part of the *foundation*, from which it is distinguished in Jer. li. 56; though, as the edifice rests thereon, it may be so called. Sometimes it denotes those massive slabs which, being placed towards the bottom of any wall, serve to bind the work together, as in Isa. xxviii. 16. Of these there were often two layers, without cement or mortar (Bloomfield, *Recess. Synop.* on Eph. ii. 20). This explanation will sufficiently indicate the sense in which the title of 'chief corner-stone' is applied to Christ.

COTTON. On account of the uncertainty attending the subject, and the difference of opinion among writers who have discussed it, reference was made from Byssus to this article, in order that we might proceed from a knowledge of the article itself to its history in early ages, and thus endeavour to discover the names by which it was first known. Cotton is well known to be a wool-like substance which envelopes the seeds, and is contained within the roundish-pointed capsule or fruit of the cotton-shrub. Every one also knows that cotton has, from the earliest ages, been characteristic of India. Indeed, it has been well remarked, that as from early times sheep's wool has been principally employed for clothing in Palestine and Syria, in Asia Minor, Greece, Italy, and Spain, hemp in the northern countries of Europe, and flax in Egypt, so cotton has always been employed for the same purpose in India, and silk in China. In the present day, Cotton, by the aid of machinery, has been manufactured in this country on so extensive a scale, and sold at so cheap a rate, as to have driven the manufacture of India almost entirely out of the market. But still, until a very recent period, the calicoes and chintzes of India formed very extensive articles of commerce from that country to Europe. For the investigation of the early history of cotton, we are chiefly indebted to the earliest notices of this commerce; before adducing these, however, we may briefly notice the particular plants and countries from which cotton is obtained. India possesses two very distinct species: 1. *K. Gossipium herbaceum* of botanists, of which there are several varieties, some of which have spread north, and also into the south of Europe, and into Africa. 2. *Gossipium arborescens*, or cotton-tree, which is little cultivated on account of its small produce, but which yields a fine kind of cotton. This must not be confounded, as it often is, with the silk-cotton tree, or *Bombyx heptaphyllum*, which does not yield a cotton fit for spinning. Cotton is now chiefly cultivated in Central India, from whence it is carried to and

exported from Broach. It is also largely cultivated in the districts of the Bombay Presidency, as also in that of Madras, but less in Bengal, except for home manufacture, which of course requires a large supply, where so large a population are all clothed in cotton. The supplies of cotton which we derive from America are obtained from two entirely distinct species—*Gossipium Barbadense*, of which different varieties yield the Sea Island, Upland, Georgian, and the New Orleans cottons; while *G. Peruvianum* yields the Brazil, Pernambuco, and other South American cottons. These species are original natives of America.

In the first place we must notice the names by which cotton is known in the East.—'The European names have evidently been derived from

قطن *qutn*, *kutn*, or *kootn*, which is the most common Arabic name, though others are assigned it in that copious language. The other Asiatic names do not appear to have any connection with this, or with one another; as Persian *poombet*, and Hindee, the plant (as well as cotton with its seed), *kupas*, the cotton *rose*; Bengalee, *kapase*, *tula*, *banga*; Sanscrit, *karpasec*. From the last, the Hindee and Bengalee have, no doubt, had their origin; and the resemblance between these and the term *Gossipium*, which has been considered of Egyptian origin, from being written with so many of the same consonants, is remarkable' (Royle, *Himal. Botany*, p. 86). To these may be added that the Tamul name of cotton is *partie*, and that at Bombay it is known as *kapoos*. We may now proceed to the earliest distinct notice of the export of cotton goods from India.



236. [*Gossipium herbaceum*.]

Arrian, who is supposed to have been an Egyptian Greek, who lived in the first or second century of the Christian era, and who was both a merchant and a navigator, gives, in his *Periplus of the Erythraean Sea*, an account of the articles of commerce to be met with at the different ports; and

It is to be remarked, that on reaching the ports of India and Barbarike, cotton cloths of various kinds (*ἄθρονιον*) are mentioned as articles of export. Syrastræne, or Cutch, is described as producing cotton for ordinary manufacture. From Ozeze, the modern Ouzein, *Σινδόνες Ἰνδικαί*, fine muslins; *Σινδόνες Μολόχιναι*, muslins of the colour of melons; *Ἰκανῶν χυδαῖον ἄθρονιον*, a large quantity of ordinary cottons (Vincent, ii. p. 407; al Barygaza, *z. e. Baroch*); *ἄθρονιον παντοῖον*, cottons of all sorts. Both in the Periplus and in the *Digest of the Roman Law* the word *Καρπάδος*, or *Karpasus*, occurs, and is translated 'fine muslins' by Dr. Vincent; and there can be no doubt that the cloths were manufactured of cotton then, as they are now, in India. Pliny mentions cotton in several passages; in one of which he says, that the inhabitants of Tylos called their cotton-trees *gossypini*; in another he gives the Indian name, '*ibi primum carbasis repertis*;' and in a third he represents cotton to be the native growth of Egypt, and says that it is called *gossipion*. Mr. Yates, in his *Texturum Antiquorum*, adduces these passages, but doubts of their all being genuine. There is no doubt, however, that cotton was known by its Indian name long previously, as Mr. Yates himself traces it to Statius, and infers 'that the Greeks made use of muslins or calicoes, or at least of cotton cloths of some kind, which were brought from India as early as 200 years B.C.' (*l. c. p. 341*). Subsequent to the expedition of Alexander, the Greeks first became well acquainted with the cotton plant. Nearchus, the admiral of his fleet, reported that there were in India trees bearing, as it were, flocks or bunches of wool; that the natives made linen garments of it, &c. Quintus Curtius, speaking of the Indians, says, '*Corpora usque pedes carbaso velant, soleis pedes, capita linteis vinciunt*.' Theophrastus, the disciple of Aristotle, says,— 'The trees from which the Indians make cloths have a leaf like that of the black mulberry; but the whole plant resembles the dog-rose. They set them in rows so as to look like vines at a distance.' In another part of the same book he thus writes of the island of Tylos— 'The wool-bearing trees, which grow abundantly in this island, had a leaf like that of the vine, but smaller; they bore no fruit, but the capsule, containing the wool, was, when closed, about the size of a quince; when ripe, it expanded so as to emit the wool, which was woven into cloths, either cheap or of great value.' (iii. 106).

Herodotus, however, gives the earliest notice of the cotton of India, as he states that the wild trees in that country bear fleeces as their fruit, surpassing those of sheep in beauty and excellence; and that the Indians use cloth made from those trees. So the thorax, or cuirass, sent by Amasis, king of Egypt, to Sparta, 'was adorned with gold and rich fleeces from trees.' This probably refers to the practice of the Indians wearing coats, something of the form of frock-coats, which are padded with cotton, so as often to be sword-proof. Ctesias, who resided so long at the Persian court, and was contemporary with Herodotus, was also acquainted with Indian wool of trees, as he mentions their *ξύλινα ἱμάτια*. That this was meant to refer to cotton 'may be inferred from the testimony of Varro, as we find it in Servius (*Comm. in Virg. Æn. i. 649*): 'Ctesias ait in India

esse arbores quæ lanam ferant' (Yates, *l. c. p. 335*). As Herodotus and Ctesias were contemporaries, years B.C. 400, they are not far removed from the time when the earliest extra-Indian notice of the name of cotton occurs, B.C. 519; and that is in the Book of Esther, i. 6, where the word corresponding to 'green' in the Authorized Version is *כרפס karpas*, and which no doubt means cotton [*KARPAS*]. (See Baines's *History of Cotton Manufacture*; Yates's *Texturum Antiquorum*, p. 335; Royle, *Illustr. of Himal. Bot.*, p. 84.)

Having thus traced cotton upwards from the time of the Periplus of Arrian to that of Herodotus and Ctesias, there is no difficulty in conceiving that its Indian name (*karpas*) may have reached the Persian court of Susa in the time of Ahasuerus, whose dominions extended to India, and between which country and Persia there was constant communication at a much earlier period. Heeren has clearly shown the course of the Indian trade, both by caravans from Northern India, and by boats up the Euphrates, whence the commodities of India crossed over to Syria by Tadmor, or Palmyra (2 Chron. viii. 4). In like manner there was early communication by the Red Sea between Egypt and the countries of the South. Among these India must be included, from the various products which reached the West, and which are described or clearly indicated by Greek authors, and in the earliest parts of the Bible, as the present writer has endeavoured to prove in his *Essay on the Antiquity of Hindoo Medicine*. In the time of the Periplus of Arrian, it is very evident that the communication between India and Egypt was frequent and extensive, and that cotton cloths at that time formed an article of export from the latter to the former. That they did so at still earlier periods we cannot but believe probable; for the muslins of India, though stigmatized by one as only 'the shadow of a commodity,' yet having early earned for themselves the poetical description of 'webs of woven air,' could not have escaped the scrutiny of those who sought in the countries of the South for agile wood and almgum trees, and who brought from India cinnamon and cassia, spikenard and sweet cane, all well-known products of that far-famed country.

Though it is probable that cotton was imported into Egypt and known to the Hebrews, it is extremely difficult to prove the fact. Thus Mr. Yates, the most recent writer on the subject, is of opinion, with Celsius and others, that *bad, batz, shesh*, and *byssus*, all mean linen; while Forster, in his work *De Byssu Antiquorum*, proved to the satisfaction of many that *shesh* and *byssus* both indicate cotton. In this discrepancy it is difficult to come to a satisfactory conclusion. From the time that the mummies of Egypt were found to be enveloped in pieces and rolls of cloth, different authors have adduced these as evidence that the Egyptians were acquainted with cotton. Thus Rouelle in 1750, and Dr. Forster, with Dr. Solander, were of opinion that the cloth was cotton. So also Blumenbach and others. Previous to the time of Rouelle, and by some subsequently, the cloth was thought to be linen. This question was settled by J. Thomson, Esq. of Clitheroe, who obtained a great variety of specimens of mummy-cloth, and employed Mr. Bauer to examine them with his excellent microscopes, aided by his unrivalled skill in using them. The result was to

prove that all the specimens were of linen, and not of cotton; and there can be no doubt about the correctness of the text as the ultimate fibre of cotton is a transparent flattened tube, without joints, and twisted like a corkscrew; whilst the fibres of linen and of the various mummy-cloths were transparent cylinders jointed like a cane, and neither flattened nor spirally twisted. Hence, as Mr. Thomson concludes his paper, 'Herodotus states that the Egyptians wrapped their dead in cloth of the byssus. It has been shown that, without exception, every specimen of mummy-cloth yet examined has proved to be linen. We owe, therefore, the satisfactory establishment of the fact, that the byssus of the ancients was *flax*, to the microscope of Mr. Bauer.' This might be supposed to have settled the question for ever; but Rosellini has since 'found the seeds of the cotton-plant in a vessel' in the tombs of Egypt, and Dr. Bowring has ascertained that 'the mummy-cloth of a child was formed of cotton, and not of linen, as is the case with adult mummies.' The question, therefore, remains still unsettled. We knew before that the cultivation of flax and the use of linen among the Egyptians were very general; and the doubt was whether they were acquainted with cotton or not. Cotton is found apparently wild in Upper Egypt; it is cultivated on the west coast of Africa, but it has not yet been settled whether these are indigenous or introduced plants. If these should be proved to be African plants, the production of the above seeds would be easily accounted for; and cotton *might* have been cultivated in the remote parts of Egypt without its being recorded by the earliest writers. That it was not employed as mummy-cloths for adults might have arisen from prejudice or some religious scruple; for we are told that persons were not allowed to be buried in the woollen cloths which they wore outside of their linen garments.

The difficulty of ascertaining whether cotton was known to the Egyptians having been shown to be sufficiently great, even when we have such a substance as mummy-cloth to deal with, it is hardly necessary to add that it is still more difficult to say whether it is mentioned in the Scriptures elsewhere than in the Book of Esther, because we have only the Hebrew names to assist us in our inquiries; because the same names have been applied by the ancients, and by writers in later times, sometimes to cotton and sometimes to linen; and because we are unable to ascertain whether the earlier authors were more precise than their successors. Thus, fine linen was called *θήβη*. This is considered by Celsus and Forster to be an Egyptian word, and to correspond to *ἄθων* or *ethon*; which, when 'put into Greek letters and with Greek terminations, becomes *θήβη* and *θήβιον*' (Yates, p. 265). But we have seen that *θήβιον* was, in the time of the Periplus, applied to what must have been cotton goods exported from Indian ports. *Σινδών* (*σινδών*) also is thought to be of Egyptian origin, as Coptic scholars inform us that it is found in the modern Shento, which has the same signification. Although *σινδών* originally denoted linen, we find it applied, like *θήβη*, to cotton-cloth likewise' (Yates, *l. c.* p. 266). *Βύσσος* or *byssus*, until the time of Forster, was always considered to indicate linen. Mr. Yates continues to be of this opinion (p. 267),

and objects to the argument of Dr. Forster (p. 274). The passage of Julius Pollux, which states that *Byssus* is a kind of flax among the Indians, he considers with Celsus to be an incorrect reading; that, according to the current text, Pollux only asserts that *βύσσος* is a kind of flax, without adding that it grew among the Indians. With respect to Philostratus, who mentions cotton in two passages, he admits that he uses *βύσσος* to denote cotton, and says 'besides its proper and original sense, this word was occasionally used, as *λίβον*, *θήβη*, *Σινδον*, *Carbasus*, and many others were, in a looser and more general application,' and considers the evidence of Philostratus as being of too late an age (the third century), to decide the original meaning of the term. But to us it appears equally doubtful whether some of the older authors did not use the same terms in an equally loose manner, for whenever the new product appeared it would be designated by an old name, as few would be able to distinguish the material of which a new or a fine kind of cloth was made. This looseness of expression has descended to modern times, as authors might be cited who, even when writing on the subject of cotton, sometimes use the incorrect term of linen. Thus Orme, a writer well acquainted with India, in his *Hist. Frag. of the Mogul Empire*, p. 413, says 'the rigid clumsy fingers of an European would scarcely be able to make a piece of canvas with the instruments which are all that an Indian employs in making a piece of *cambric*,' where he no doubt means muslin, though using a word which designates a manufacture of flax. Considering, therefore, that different names are applied in the Scriptures to the finer kinds of cloth; that cotton was certainly known in the time of Esther (B.C. 500); that the term *Butz* does not occur until the book of Chronicles, at a time when the commerce with India was well established; and that *Byssus* was undoubtedly applied in later times to cotton-cloth; we are not satisfied that *Butz*, at least, does not signify cotton-cloth in all the passages referred to under *Byssus*, as well as those where the word *Butz* occurs [FLAX AND SHEET].—J. F. R.

COUCH. [BED; SEAT.]
COVENANTS. Among other instances of anthropomorphic forms of speech [ANTHROPOMORPHISM] employed in Scripture is the use of the term *covenant*, to designate the divine dealings with mankind, or with individuals of the race. In all such cases, the *proper* idea of a covenant or mutual contract between parties, each of which is bound to render certain benefits to the other, is obviously excluded, and one of a merely *analogical* nature substituted in its place. Where God is one of the parties, and man the other, in a covenant, all the benefits conferred must be on the part of the former, and all the obligations sustained on the part of the latter. Such a definition, therefore, of a divine covenant as would imply that both parties are under conditions to each other is obviously incorrect, and incompatible with the relative position of the parties. Even such a definition as the following:—'Fœdus Dei cum hominibus est promissio bonorum cum conditione,' which is that given by Morus (*Epitom. Theol. Christ.* p. 160), is objectionable, on the ground of its implying that the exercise of God's grace to man is *dependent* upon something which man has to render to God.

We should prefer defining God's covenant with man as a gracious engagement on the part of God to communicate certain unmerited favours to men, in connection with a particular constitution or system, through means of which these favours are to be enjoyed. Hence in Scripture the covenant of God is called his 'counsel,' his 'oath,' his 'promise' (Ps. lxxxix. 3, 4; cv. 8-11; Heb. vi. 13-20; Luke i. 68-75; Gal. iii. 15-18, &c.); and it is described as consisting wholly in the gracious bestowal of blessing on men (Is. lix. 21; Jer. xxxi. 33, 34). Hence also the application of the term covenant to designate such fixed arrangements, or laws of nature, as the regular succession of day and night (Jer. xxxiii. 20), and such religious institutions as the Sabbath (Exod. xxxi. 16); circumcision (Gen. xvii. 9, 10); the Levitical institute (Lev. xxvi. 15); and in general any precept or ordinance of God (Jer. xxxiv. 13, 14); all such appointments forming part of that system or arrangement in connection with which the blessings of God's grace were to be enjoyed. In accordance with this is the usage of the verbs הָקִים, נָתַן, and שָׁמוּ to denote the forming of a divine covenant with man, all of which indicate the perfect sovereignty of God in the matter.

The divine covenants were ratified with the sacrifice of a peculiar victim, the design of which was to show that without an atonement there could be no communication of blessing from God to man. Thus when God made a covenant with Abraham certain victims were slain and divided into halves, between which a smoking furnace and a burning lamp, the symbols of the divine presence, passed, to indicate the ratification of the promises conveyed in that covenant to Abraham; and here it is deserving of notice, as illustrating the definition of a divine covenant above given, that the divine glory *alone* passed between the pieces; whereas had the covenant been one of mutual stipulation, Abraham also would have performed the same ceremony (Gen. xv. 1-18; cf. Rosenmüller, *in loc.*). In like manner, the Levitical covenant was ratified by sacrifice (Exod. xxiv. 6-8); and the Apostle expressly affirms, on this ground, the necessity of the death of Christ, as the mediator of the new covenant; declaring that where a covenant is, there also of necessity must be the death of the appointed victim (Heb. ix. 16; cf. Macknight, *in loc.*). With this accords the etymology of בְּרִית, the Hebrew word for 'covenant,' which, by the best lexicographers, is derived from ברַה *cecidit, secuit*; and the usage of the phrase בְּרִית סֵדֶר, *fœdus secare, percutere* (comp. Gr. ὄρκια τέμνειν).

Of the divine covenants mentioned in Scripture the first place is due to that which is emphatically styled by Jehovah, 'My covenant.' This is God's gracious engagement to confer salvation and eternal glory on all who come to him through Jesus Christ. It is called sometimes 'the everlasting covenant' (Isa. lv. 3; Heb. xiii. 20), to distinguish it from those more temporary arrangements which were confined to particular individuals or classes; and the *second*, or *new*, or *better covenant*, to distinguish it from the Levitical covenant, which was *first* in order of time, because first ratified by sacrifice, and became *old*, and was shown to be *inferior*, because on the appearance of the Christian dispensation it was superseded, and passed away (Jer. xxxi. 31; Gal. iv. 24; Heb.

vii. 22; viii. 6-13; ix. 15-23; xii. 24). Though this covenant was not, strictly speaking, ratified before the death of Christ, the great sacrificial victim (Heb. xiii. 20), yet it was revealed to the saints who lived before his advent, and who enjoyed salvation through the retrospective power of his death (Rom. iii. 25; Heb. ix. 15). To the more highly favoured of these God gave specific assurances of his gracious purpose, and on such occasions he was said to establish or make his covenant with them. Thus he established his covenant with Noah (Gen. ix. 8, 9); with Abraham (Gen. xvii. 4, 5); and with David (Ps. lxxxix. 3, 4). These were not distinct covenants, so much as renewals of the promises of the everlasting covenant, coupled with certain temporal favours, as types and pledges of the fulfilment of these promises.

The old or Sinaitic covenant was that given by God to the Israelites through Moses. It respected especially the inheritance of the land of Canaan, and the temporal blessings therewith connected; but it stood related to the new covenant, as embodying a typical representation of those great truths and blessings which the Christian dispensation unfolds and conveys.

In the system of a certain class of theologians great importance is attached to what they have technically called 'the covenant of works.' By this they intend the constitution established by God with Adam, during the period of his innocence. So far as this phraseology is not understood to imply that man, even in his sinless state, was competent to bind Jehovah by any conditions, it cannot be objected to. It seems also to have the sanction of one passage of Scripture, viz. Hos. vi. 7, which Montanus, Grotius, Castalio, Burk, Rosenmüller, Newcome, Hitzig, and almost all the best interpreters, agree in rendering thus: 'But they like Adam have transgressed the covenant.'

Theologians have also spoken of 'the covenant of redemption,' by which they mean an engagement entered into between God the Father and God the Son from all eternity, whereby the former secured to the latter a certain number of ransomed sinners, as his church or elect body, and the latter engaged to become their surety and substitute. By many the propriety of this doctrine has been doubted; but the references to it in Scripture are of such a kind that it seems unreasonable to refuse to admit it. With it stand connected the subjects of election, predestination, the special love of Christ to his people, and the certain salvation of all that the Father hath given him.

Sometimes a mere human contract is called God's covenant, in the sense of involving an appeal to the Almighty, who, as the Judge of the whole earth, will hold both parties bound to fulfil their engagement. Compare 1 Sam. xx. 8; Jer. xxxiv. 18, 19; Ezek. xvii. 18, 19. (Witsius, *De Economâ Fœderum*; Russell, *On the Old and New Covenants*, 2nd edit. 1843).—W.L.A.

CRANE (Isa. xxxviii. 14, Jer. viii. 7). כִּסֵּס *agur*, occur in these passages as names of birds, and have been generally considered as denoting the 'crane' and 'swallow;' but translators are by no means agreed as to the appropriation of these names to the Hebrew terms. Our version renders *sis* by 'crane,' but Bochart, more correctly, as we think, decides in favour of 'swallow;' while Luther, rejecting both, prefers 'heron.

Where so much diversity of opinion reigns, it will be most safe to search for the true meaning by examining the internal evidence furnished by the texts in question, the two names occurring in no other instance. In Isaiah, allusion is made to the voice of both the species, which is described by the verb 'to chatter,' in accordance, or nearly so, with all the critical authorities that we have consulted. In Jeremiah, where both names occur in the same order, the birds are represented as 'observing the time of their coming.' Now, if the

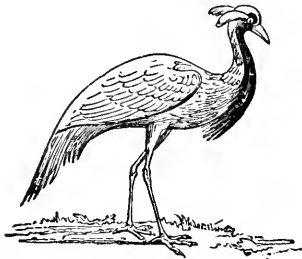

237. [Numidian Crane: *Grus Virgo*.]

'crane' of Europe had been meant by either denomination, the clamorous habits of the species would not have been expressed as 'chattering;' and it is most probable that the striking characteristics of that bird, which are so elegantly and forcibly displayed in Hesiod and Aristophanes, would have supplied the lofty diction of prophetic inspiration with associations of a character still more exalted. 'Sus' or 'Sis' is the name of a fabulous long-legged bird in Arabian legends, but it also indicates the expressive sound of the swallow's voice; while 'agur' is transferred with slight alteration to the stork, in those northern tongues which have similarly altered the Chaldee version (כורכיא) *kurkeya*, into *kurg* and *curki* (see Nemnich, s. v. Ardea). The Teutonic *Aiber*, Dutch *Oyevaer*, Esthonian *Aigr* and *Aigro*, therefore, support the view that, Agur is a tribal appellation of one of the great wading birds; but neither the Hebrew text nor the Teutonic names point to the crane of Europe (*Ardea Grus*, Linn., *Grus Cinerea* of later ornithologists); since that species has a loud trumpet voice, and therefore does not 'chatter;' but especially, because in its migrations it crosses the Mediterranean into Africa, and does not appear in Palestine, unless by accident (driven thither possibly by a western storm of wind); and, when a troop of cranes alight under these circumstances, it is only for a moment; they do not give evidence of purposely assembling like the swallow. Thus the few characteristics indicated might seem to point out the stork, which does assemble in Syria in flocks, before its departure, and is not a clamorous bird, having little or no voice. But as the stork is clearly designated by a different appellation in the original, we must search for another species as the representative of *agur*; and we fortunately find one which completely answers to the conditions required; for, being neither a genuine crane, a stork, nor a heron, having a feeble voice, and striking but distinct manners; it is remarkable for beauty, numbers, residence, and periodical arrival and departure. The '*Ardea virgo*' of Linn. the '*Grus virgo*' of later writers,

and '*Anthropoides virgo*' of some, is the bird, we have every reason to conclude, intended by 'agur, though not coming from the north, but from Central Africa, down the Nile (the very circumstance which puzzled Hasselquist), and in the Spring arriving in Palestine, while troops of them proceed to Asia Minor, and some as far north as the Caspian. They are frequently found portrayed on Egyptian monuments, and the naturalist just quoted, who saw them on the Nile, afterwards shot one near Smyrna: they visit the swamp above that city, and the lake of Tiberias, and depart in the fall, but do not utter the *clangor* of the crane, nor adopt its flight in two columns, forming an acute angle, the better to cleave the air. This bird is not more than three feet in length; it is of a beautiful bluish grey, with the cheeks, throat, breast, and tips of the long hinder feathers and quills black, and a tuft of delicate white plumes behind each eye. It has a peculiar dancing walk, which gave rise to its French denomination of 'demoiselle.'—C. H. S.

CREATION. In the ideas implied by this term a subject of vast extent and most profound interest is suggested; at the same time, one in reference to which but little can be said to be so certainly known or distinctly understood, as to afford adequate satisfaction to that curiosity which is so naturally excited in the human mind with respect to it, and which has evinced itself in all ages by the discussions, whether of a theological or of a philosophical nature, which have so largely occupied the attention both of religious and scientific writers.

In the present article, on a point of so much importance in Biblical literature, we shall endeavour to give as comprehensive a sketch of existing views as our limits will permit; and to do this the more satisfactorily we must, in the first instance, observe the due distinction between the several branches of the inquiry, and the attainable sources of knowledge on the subject. These are, of course, comprised under the two main heads of *reason* and *revelation*. We shall, in the first instance, offer some elucidations of the views derived from each of these sources *separately*, and then advert to the degree in which they bear *upon each other*, and to the connection and degree of accordance or discordance between them, real or apparent: and though, in so doing, we must necessarily touch upon some points on which considerable and even violent controversy has been called forth, yet we shall endeavour most strictly to avoid all discussion in a polemical spirit, and to confine ourselves to the dispassionate statement of what appears to be the best established views of the actual facts.

In the first place, then, the doctrine of revelation on this point, in the most general view, is chiefly founded on the simple ascription of the original formation of all things to Divine power, and on the title of the 'Creator' applied to the Deity. This is the constant language of all parts of Scripture, both of the Old and New Testaments; and in the meaning of the term 'create' we must seek the origin of those views which constitute the theological and revealed belief respecting the mode in which the world had its beginning.

The meaning of this word has been commonly associated with the idea of 'making out of nothing.' But when we come to inquire more

precisely into the subject, we can of course satisfy ourselves as to the meaning only from an examination of the original phrases.

Now, in the Hebrew Scriptures three distinct verbs are in different places employed with reference to the same divine act, viz. בָּרָא *create*, עָשָׂה *make*, יָצַר *form* or *fashion*: now, though each of these has its shade of distinction, yet the best critics understand them as so nearly synonymous that, at least in regard to the idea of making out of nothing, little or no foundation for that doctrine can be obtained from the use of the first of these words. They are used *indifferently* and *interchangeably* in many passages; as, e. g. in Isa. xliii. 7, where they all three occur applied to the same divine act. The Septuagint renders בָּרָא indifferently by ποιῶν and κτίζειν. But especially in the account of the Creation in Gen. i. the verbs are used irrespectively in verses 7, 16, 21, 25, &c.; and, comparing Gen. i. 27 and ii. 7, man is said to have been *created*, yet he is also said to have been *formed out of the ground*. Again, in the Decalogue (Exod. xx. 11), the verb is עָשָׂה, *made*, not *created*. In Gen. i. the Septuagint has ἐποίησεν throughout.

On such a point much weight will be ascribed to the opinion of Dr. Pusey, professor of Hebrew at Oxford, who has distinctly stated his view that the word בָּרָא implies neither positively, on the one hand, a formation out of nothing, nor, on the other, positively a formation out of existing materials, but that it is absolutely indefinite and neutral as to either of these conditions (Buckland's *Bridgewater Treatise*, note, p. 22). Thus he observes that the original expression 'let there be light' (Gen. i. 3), by no means necessarily implies that light had never before existed (*ibid.* note, 26). Upon the whole, he considers the only difference between the three verbs to lie in the *degree of force* in the expression; בָּרָא, *create*, being simply the stronger and more emphatic word to express more forcibly the absolute power of the Creator.

In the New Testament we have a similar indifferent use of the words κτίζειν and ποιῶν in a great number of passages. The former is applied to the origin of the world in Mark xiii. 19, and to the formation of man in 1 Cor. xi. 9, and in some other places; but most remarkably in Col. i. 16. The same word is also applied in a spiritual sense in Eph. ii. 10 and other passages, in which the figure clearly involves formation out of what existed before; as also in Eph. iv. 24, Col. iii. 10, &c. It manifestly implies previous materials in Heb. ix. 11, as in the Septuagint version of the corresponding passage in Lev. xvi. 16. But more particularly in Rom. i. 20, the expression τὰ γὰρ ἀόρατα αὐτοῦ ἀπὸ κτίσεως κόσμου τῆς ποιήμασι νοούμενα places in synonym the substantives corresponding to the verbs 'create' and 'fashion' or 'form.' This appears to be nearly the whole substance of what we can collect from the Scriptures, whether Jewish or Christian, as to the force of the verbal expressions and the idea implied by the term 'Creation.'

If from the subject of the *general idea* of creation we turn to that of the particular *mode* in which the 'formation' of existing things (whether the crude material existed previously or not) is represented to have taken place, we find

more extensive and express declarations in various parts of the Bible. It is not our purpose to furnish a concordance of texts, nor to introduce quotations of all that bear upon the subject, any more than our readers probably would look for it. It will suffice to observe that we have many *general* statements of the kind, and one or two very *circumstantial* representations. Of the former kind we may remark that almost all refer to the *attributes* and *perfections* of the Deity evinced in the work of creation, rather than to any precise explanation of *how* it was accomplished. The sacred writers also refer largely to the *Divine will* and the announcement of that will by His *word* as the immediate agent, as in Ps. xxxiii. 6, 9, and cxlviii. 5; Rev. iv. 11, and many other places; and this reference to the *Divine word* is considered by many to be in effect the same with the more direct ascription of the work of creation to the *Divine λόγος* in John i. 3; which again is explicitly referred to the Son of God in Eph. iii. 9, and Heb. i. 2, 3; and again, Col. i. 16. It would lead us too far from our immediate object here to discuss more minutely the precise doctrinal bearing of the passages last referred to, and others of similar import; and our readers will find full information on these topics under other more appropriate heads. We will merely observe further, that these *general* representations of the creation all agree in speaking of it in terms of the most unbounded extent and *universality* of operation: this is observable in the last cited texts, and not less pointedly in Acts xiv. 15, and xvii. 24; Rev. x. 6; besides many others; but it is to be observed, it is not expressed that this universal act took place *at one and the same time*, nor whether it was *instantaneous* or *gradual*.

We come next to those Scriptural representations of the Creation, which are more precise and circumstantial. Of these the earliest in order of time is that stated to have been announced by the Divine voice from Mount Sinai, in the delivery of the law to the Israelites (Exod. xx. 11), where the entire and complete work of Creation is described as carried on and ended in six days. The description pointedly applies to the *whole* universe; and the Great Work was succeeded by a seventh day, of rest or cessation, implying, that is, the *final* perfection of the process.

When the books of the Old Testament were afterwards written, the Mosaic history naturally opened with a general statement to the same effect. It is well known to be the opinion of some of the most learned critics, that the book of Genesis, in its existing form, is properly a compilation of more than one ancient document, portions of each being mixed in different parts of the narrative. Thus the short account of the Creation in Gen. ii. 4, is considered to have been the commencement of the most ancient record, while the more expanded and circumstantial account in Gen. i. and ii. 1-3, was prefixed from a later document [See Bauer's *Theology of the Old Test.* p. 11, Eng. Tr. 1838.] But it will not be material to our present purpose to follow this distinction. We are principally concerned with the *terms* of the description, from whatever source its materials may have been derived.

The points most important to be noticed are the following.—The first sentence is taken by

mary to stand distinct from what follows, as a first general announcement, or title, as it were; then, after a break, the account of the six days' work is supposed to begin. The description in the second verse (commonly conveyed by the term Chaos) is supposed by some connected with the first verse; by others, with the subsequent. Either way it positively expresses a state of universal ruin, disorder, and darkness. Out of this chaos the divine word evokes light, and, by degrees, order and organization; but by several successive and beautifully appropriate stages, divided into periods called nights and days; in which first the grander distribution of the inert materials of the universe into their respective places occurs, and then, progressively, the stages of organized existence from the lower up to the higher forms: until at length the whole is crowned by the introduction of man, who is constituted lord of the inferior world, and the spirit of life breathed into him:—when the majestic scene closes with the final cessation put to the work in the Divine rest on the seventh day, and the pronouncing of a peculiar benediction and sanctification of it.

On the sublime and unapproachable magnificence of this description it is not to our present purpose to dilate; but there is a peculiar character of unity of design and subordination and connection of parts observable throughout it, which, in any human composition, we should instantly refer to the most exalted poetical genius, and recognize as marking the most profound skill in the composition and invention of the narrative, the disposition, as it were, of the whole machinery of the great drama.

Very different is the view which some modern commentators have been induced to take of it. It will neither be necessary nor pleasing to enter into detailed descriptions of them. But the following very brief sketch of some of them is necessary:—Some do *not* make the separation of the first verse, before alluded to, but, taking the whole to refer to one single creative process, stretch that process out to a vast, and, in fact, unlimited length of time, by interpreting each of the six days (though most expressly described as alternations of day and night) as meaning periods of thousands or millions of years; and alleging, as their authority, that in certain parts of the prophetic writings, the term 'day' is used for an indefinitely long period, and that it is said with God 'a thousand years are as one day!' When, however, they come to the seventh day at the close (which is, nevertheless, obviously spoken of in the very same terms), they then go back to the ordinary sense of a natural day.

Others suppose the first verse, or the first two, to refer to an original formation of all things, the time, manner, and circumstances of which are left wholly undetermined. Then, after an indefinitely long interval, this original universe was totally overwhelmed and destroyed; and then, in six natural days, the whole existing world called into being in its place, in accordance with the literal terms of the remainder of the narrative.

A different class of interpreters contend that the whole account is to be taken together, as in the first of the instances just stated, but the days understood literally; the whole however is to be interpreted as referring to a more remote period

than is commonly imagined, and as not intended to describe the *existing* species of plants and animals, but various other species, now extinct, which have been, by *subsequent* convulsions of nature, destroyed, while others have been successively, by fresh acts of creation, introduced in their place.

We will allude only to one other interpretation, the most recent which has been proposed, and which possesses every claim to attention which can be commanded by piety, learning, and devotedness to the sole cause of truth on the part of its author, Dr. J. Pye Smith, whose volume on the *Relations of Scripture to Geology, &c.*, we earnestly recommend to the attentive perusal of all who wish to acquire a comprehensive knowledge of the whole subject, as well as to be enlightened by the philosophical views and scriptural eloquence of the venerable and excellent writer.

His interpretation is briefly of this kind: the separation of the first verse he adopts as above; this refers to the original universal creation: and in the vast undefined interval, an almost unlimited series of changes in the structure and products of the earth may have taken place. After this, at a comparatively recent epoch, a *small portion* of the earth's surface was brought into a state of disorder, ruin, and obscurity; out of which the creation of the existing species of things, with the recall of light, and the restored presence of the heavenly bodies, took place literally, according to the Mosaic narrative, in six natural days. All this is supported by profound critical distinctions as to the sense of the original words. The brevity of this sketch we trust will be productive of no misconception, as we hope all our readers will satisfy themselves out of the original work.

In this cursory review of different interpretations we have made a passing allusion to geology, and the changes which it indicates as having taken place at remote periods on the earth's surface. We shall presently recur particularly to this subject. But it will be evident to most of our readers that some consideration of these scientific conclusions has been the main motive which suggested the various interpretations, some few of which we have mentioned. Our present concern with them is, however, on purely critical and philological grounds. And in this point of view, with the utmost respect for the several authors, without going into any details of controversy, we would wish simply to put all such interpretations, on their own intrinsic merits, to the judgment of any perfectly unbiassed inquirer. Yet for ourselves (without wishing to press any decision), we must confess they all appear to suggest senses which are of a very different nature from any which the plain tenor of the narrative would seem almost unavoidably to convey. We cannot here go into details of verbal criticism: but we are fully disposed to grant all that may be urged as to the precise signification of some of the terms; which may doubtless, by long established custom and association, have been commonly received in senses which a more exact knowledge of the original language may not warrant. At the same time we do not think anything of this kind can materially affect the broad view of the subject. We are disposed to look at the narrative as a *whole*:—and even allowing the greatest latitude as to the precise shades of meaning in its particular

features, to ask whether the *general* impression of its design can be rationally conceived to fall in with these views of it? Whether, rather, any such signification imposed on it does not seem to do palpable violence to its integrity, its distinctness, its majestic sublimity, its special purport, bearing, and manifest object?

We will, however, add one general remark applicable to all such interpretations in a philological point of view. In attempting to ascertain the true sense of a passage in any ancient book, we ought surely to decide in our own minds distinctly *what* it is at which we aim, whether to find some sense, to our apprehensions consistent, and such as the terms of the passage in question *may be made to bear*,—or to seek, as well as we can, what meaning it was the probable *intention of the writer* to convey. These two considerations, it should be observed, though really very distinct, are too often confounded together; or rather, the latter is almost wholly lost sight of.

In the case before us, we cannot help thinking, there has been generally a great want of attention to this distinction. Some of the commentators indeed appear to allow that Moses himself may have individually intended to convey only that meaning which, they seem to confess, appears upon the face of his narrative, but at the same time they conceive there was a *hidden sense* really designed, accordant with the views they suggest, and which has not really been developed till the present day. The probability of such a doctrine in general it would be beyond our limits to discuss. But in reference to the immediate subject, we must confess, it appears to us yet more involved in complexity than the difficulties it is called in to solve.

Lastly, others have thought that the whole description must be taken literally as it stands; but yet, *if* found contradicted by facts, may, without violence to its obvious design and construction, be regarded as rather intended for a mythic poetical composition, or religious apologue, than for a matter-of-fact history.

To these points we shall recur; meanwhile, to follow the order of our discussion, we must here advert to another question.

The idea of 'creation,' as meaning absolutely 'making out of nothing,' or calling into existence that which did not exist before, in the strictest sense of the terms (as we have seen), is *not* a doctrine of *Scripture*, but it has been held by many, on the grounds of *natural theology*, as enhancing the ideas we form of the divine power, and more especially since the contrary must imply the belief in the *eternity* and *self-existence* of *matter*. It has hence been a point largely discussed by those who have gone into the metaphysical arguments in support of the existence and attributes of the Deity. To maintain the eternity of matter is held to be the basis of materialism: and the sole self-existence of God has been upheld as essential to our idea of divinity, and the belief in a similar quality in matter strenuously objected to as either investing matter with the attributes of Deity, and thus involving us in Pantheism, or else derogatory from the divine perfections so entirely, as to leave us in a state of opinion differing little from atheism. Thus Dr. S. Clarke has argued at length against the self-existence of matter, on the ground that self-existence implies necessary existence; and

this again implies that it would be contradictory to suppose the world not to exist; which it does not, since we *can* conceive the possibility of its non-existence (see *Demonstration of the Being and Attrib. &c.*, prop. iii.). In general, we would observe that the abstract belief in a creation, as a calling into existence of the material world out of nothing, according to the definition of the schoolmen, 'Dicitur aliquid esse factum de nihil cum intelligimus esse quidem factum, sed non esse aliquid unde sit factum' (Anselm, *Monol.* c. 8), must be regarded as an opinion which rests wholly upon arguments of a metaphysical kind. It must, on the one hand, be distinguished clearly from the creation spoken of in the Bible, and, on the other, from the process by which the present order of physical existence was introduced, so far as it may be disclosed to us by the evidence of physical science. The metaphysical arguments will of course possess different degrees of weight to different minds: at all events they should be most carefully examined. And though Scripture and nature do not absolutely assert this view of the matter; yet they offer nothing at variance with it.

The *creation, or origin*, of the world, in a philosophical sense, is a subject which, as might be expected, has engaged the attention of philosophers of all classes and sects from the earliest times. To attempt to give any correct account of the innumerable theories and speculations which have been started on this subject would be beyond our design; but some few remarks by way of illustration may be desirable.

In general, we may observe that of these theories, many which have passed current as philosophical speculations have been framed *not* on *purely* philosophical grounds, but on a mixture of philosophical with legendary and fabulous systems among the heathen writers of antiquity;—and, among the moderns, with an attempt to combine the deductions of physical science with the real or supposed statements of revelation. All such speculations appear to us essentially faulty. In all such inquiries we should preserve a distinct idea of the ground on which we are proceeding. In the attempt to mix up considerations of so very different a nature in one view we shall pervert and injure both. Let the inductive conclusions stand on their own ground, and revelation on its proper evidence, then both will obtain their proper and distinct authority.

Those theories in earlier times, which were professedly based on purely philosophical grounds, were most frequently of an extremely hypothetical character. Such were the speculations of most of the ancient philosophical sects; they rather sought to make out some plausible system couched in the technical language of their schools, than fairly to trace what was really the order of nature, and follow by the humble but sure path of induction, the actual laws by which she is regulated, and which, when diligently studied, never fail to lead us on from one step of generalization to another, until we arrive at the surest conviction of that universal order and profoundly-regulated unity and harmony of physical causes, which form the irresistible evidence of the all-pervading influence of the one great moral cause of the universe. We will, however, just mention one or two illustrative instances:—

Among the ancient philosophers, Plato distinctly ascribed the formation of all things to a supreme being, but seems also to have held the independent existence of matter; that is, he maintained three principles—God, matter, idea: the idea being an incorporeal archetype existent in the Divine mind, according to which matter was moulded and fashioned (Plutarch, *De Placitis*, i. 3). This doctrine, indeed, seems to be nearly the same with that of Thales and Pythagoras, from whom it was probably borrowed. Cicero expressly tells us that 'Thales held water to be the principle of all things; and God, that mind which fashioned all things out of water' (*De Nat. Deor.* i.). Aristotle held the pre-existence of matter; and observes, 'It is the common opinion of naturalists that nothing can be made out of nothing;' and that it is impossible that it should be otherwise (*Phys.* i. 4. 8). And further: 'neither can everything be made out of everything, but out of some subject fitted thereto; as animals and plants out of their seed' (*l. c.* 9). Here, indeed, he seems to be approaching the argument of simple physical induction, the legitimate result of which ought to be to remind us of the proper boundaries of all physical argument, and to show that the question of the original constitution of matter is one which no such induction can ever solve. And though probably they did not view the subject in this philosophical light, yet some of the fathers of the Christian Church, in their discussions of these speculative questions, have expressed the truth in terms exactly harmonising with the most rigid modern philosophy. 'It is impossible,' says St. Chrysostom, 'for man's nature by curious inquiry to penetrate into the workmanship of God' (*In Gen. λογ. β'*): and Lactantius observes, 'His works are seen with the eyes, but how he made them, the mind itself cannot see' (§ 2). There are those who condemn all such speculations as evincing but the empty presumption of human reason: but they do not perceive that the real fault lies, not in the *use* of reason, but in the *perversion* of it; not in trusting to its guidance, but in refusing its cautions, and arrogantly imagining that we can penetrate regions where the only safe path of induction is manifestly closed to us.

In modern times there have not been wanting those who have pursued cosmogonical speculations on what they considered purely philosophical grounds: though to the adherents of strict inductive science their philosophical character will appear to stand on no better ground than the reveries of the ancients. For the sake of those readers who may feel interested in such theories, we may just name some of the most celebrated of these authors:—Buffon, in his *Histoire Naturelle*; Wolfe, in his *Cosmologia*; Holbach, in his *Système de la Nature* (incorrectly ascribed to Mirabaud or to Lagrange); and the disciples of Kant, as Hegel, Oken, and others, among whom the most prominent is J. Müller. As a specimen of the kind of speculation pursued, we may briefly state that his work, *Ueber die Entschung der Welt aus Nichts*, is founded on the old maxim, 'ex nihilo nihil fit;' from whence he deduces the existence of an original governing power possessing omnipresence and omniscience. But the production of a world could only take place in one of two ways, 'either in a pantheistical or a spiritual

mode;' that is, the original power might create a world of which he, or an emanation from him, is the all-pervading soul, or might part with portions of his own intelligence, which might animate portions of the creation. Müller adopts the second of these, and contends that this distribution of the divine intelligence is what produces duration or time: the continued existence of time is the evidence of the continuance of divine power. This power (if we have the least idea of the author's meaning), by indefinite continuance alone becomes concentrated, as it were, in some kind of effect, which produces, or at least brings together, a sort of original matter or ether, which subsequently undergoes changes owing to three principal forces or forms of power—attraction, repulsion, and inertia; after which, rotation being communicated, worlds and systems may result. But as we cannot pretend to say that from any statements we have seen we can render the subject at all more intelligible, we must hope this specimen may suffice.

If we turn to the more strict and proper investigation of physical science, it will be important to inquire what amount of testimony with respect to the origin of the world they may be able to supply.

The science of *astronomy* has sometimes been appealed to as having reference to the probable origin and antiquity of the solar system; but on a closer examination the degree of evidence which it furnishes will be found little more than conjectural.

The most recent and complete investigations of the theory of gravitation have totally excluded all idea of the action of adventitious causes in sustaining or disturbing the system. Its apparent irregularities have been all analyzed and reduced to calculation, to system, and order, and shown to be, in fact, but portions of the exact regularity by which the whole fabric is sustained, and which recur in a perfectly determinate cycle through determinate periods, though some of them are of immense length.

All this does not, however, prove that the universe *has existed* through those immensely long periods: astronomical science *does not show* us any commencement; but there is no evidence whatever at variance with it.

Observations on the motions of Encke's comet have disclosed the *high probability* of the existence of a certain extremely rare medium through the celestial space, which offers a certain resistance to that small comet, itself composed of extremely rarified matter. This medium, or ether, must therefore oppose *some* resistance, however inexpressibly small, to the solid planets; and the result must be, in an inconceivably long period of time, that they will approach, and finally fall into, the sun.

Astronomy, then, may point to the *termination* of the present order of things. It has been argued, as a sort of analogous presumption, that that which will have an end had also a beginning; but this, considered in the light of evidence of creation, is surely far too slight and inconclusive to be of much value. Another argument has been sometimes dwelt on to which we must refer rather more particularly. This is what is termed 'the Nebular Hypothesis,' which may be thus very briefly explained: La Place suggested it (purely

as an *hypothesis*), which might give a plausible representation from analogy of the origin of the *motions* of the solar system. In all parts of the heavens powerful telescopes show us star-like objects which are not, like the other stars, brilliant luminous points, but extended bodies of comparatively little lustre. These are called *nebulae*, and manifestly appear to be in various stages of *condensation*, from great diffuseness up to actual stars, and many of them having within them points of greater brightness. La Place perceived an analogy between these and the solar system: he conceived that our whole system was once in the state of a nebula; that it has undergone gradual condensation, the sun being the central star; and that in this process each of the planets also formed a distinct centre of condensation, while in and by the process their respective motions were communicated to them, supposing the whole mass to have had originally impressed upon it a general rotatory motion, without which, and the centrifugal force resulting, all its particles must at once have been attracted together into one central mass. Thus other planetary masses would be found revolving round that centre at different distances. As the cooling and consequent condensation advanced, similar effects on a smaller scale would take place in each of those planetary masses, until they formed solid planets accompanied by rings or satellites. The resulting motions would be orbits not much differing from circles, and in planes not greatly inclined to each other, which accords generally well enough with the actual constitution of the solar system.

All this was (as we have said) thrown out merely as a mechanical hypothesis: it does *not* (as has been sometimes represented) account for the *creation* of the solar system; but merely shows how, on mechanical suppositions, we may explain its possible formation, in conformity with more general pre-existent laws. So far then as the evidence of Creation is concerned, it amounts to this, that the same evidence which we have of infinite power and wisdom in the actual adjustment of the *existing* system, by certain fixed laws of inimitable unity and simplicity, is by *probability* carried a step further back into past time; and the sufficiency of the same unvarying principles not only to the *preservation* but to the original arrangement of the system, may yet more widely extend and enlarge our notions of the same sublime inferences, which the contemplation of the system, in its existing relations, is so transcendently calculated to "each.

While speaking of astronomical evidence we must not omit to notice an idea, which often prevails, of some connection between astronomical epochs and events on our globe; or, at least, a disposition to attach importance to coincidences of this kind. Thus some have dwelt upon the circumstance that by calculation of the motion of apses of the earth's orbit, La Place found that the major axis of the orbit coincided with the line of the equinoxes in the year 4004 B.C. [*Mec. Cel.* iii. 113], which, according to Archbishop Usher's system, is the date assigned to the Mosaic Creation. But it is difficult to see any physical reason why the globe should be more likely to be brought into its present state, or man placed upon it, under that particular combination of circumstances rather than any other.

There is, however, another branch of science from which information of a more positive kind may be extracted.

In referring to the evidence which **GEOLOGY** may give on the subject of the *origin* of the world we must premise, 1st. That the *object* of this science is not that of attempting any such discovery: the testimony which it may afford is but incidental. 2nd. The science itself is but of very modern origin, and its researches have as yet been carried but a little way, compared with what we must reasonably expect they will be: yet to that small extent its foundations have been laid in absolutely determined facts, and general results, which are real, settled, inductive truths, which no subsequent investigations can overthrow; which, in fact, can only be called in question on grounds which, if true, must overthrow not only geology, but all inductive science whatever, that is, the whole extent of human knowledge, and render our reasoning faculties useless, and all philosophy a mere illusion. 3rd. The evidence to which alone we can look on such a question as the present must be restricted to those portions of the subject which are of this strictly inductive character, and we must not mix up with them those conjectural hypotheses (however just and valuable for their proper purposes) in which geologists of all schools occasionally indulge.

In very briefly stating the general results of this evidence, which, little as it is, is yet undeniably certain, we shall, of course, not attempt any thing like geological *discussion*, or elementary explanation: we shall presume that the reader is either moderately acquainted with the elements of the science, or at least can have recourse to the works of the most eminent geologists, in which he will find ample proof of the assertions we bring forward, which in our narrow limits, of course, pretend to be no more than a recapitulation or summary of the evidence. For our facts then we simply refer the reader to Mr. Lyell's *Principles of Geology*, 4 vols.; his *Elements of Geology*, 1 vol.; Professor Phillip's *Treatise on Geology* (extracted from the *Encyclopædia Britannica*); Sir H. De la Beche's *Geological Manual*; Dr. Buckland's *Bridgewater Treatise*; and, for more general discussion, to Dr. J. Pye Smith's work before named, and to Professor Powell's *Connexion of Natural and Divine Truth*.

The pursuit of geological inquiry discloses the evidence and monuments of successive changes which have occurred in the state of the earth's surface (including under that term the solid portion extending to some depth below). In the attempt to trace these to their causes, sound induction recognises the one grand principle of referring to those which are both true and 'sufficient' to explain the phenomena. We cannot find true causes except in such as are really proved to exist, and are found by experience to be in operation. The action of the waters on the land (whether the continual action of the rivers and the ocean, or the occasional force of inundations and torrents), the subterranean force of earthquakes, and the external operations of volcanoes; the contractions and expansions which must accompany changes in the temperature of any considerable thickness of the earth's crust; the fractures, flexures, and varieties of form which must arise from subterranean upheaving forces;—these and the like

are the *real* causes to which alone the sound geologist refers.

The accumulation of soil at the bottom of the waters, the imbedding of animal and vegetable remains in those depositions, the elevations of portions of the land out of the sea, are operations really and continually going on. When therefore we find fossil remains of organized beings imbedded in rocks, bearing also marks of a similar mode of deposition, we refer to such operations as those just mentioned as true causes to explain the phenomena: and numerous series and successions of such depositions, containing the remains of species now extinct, and successively, in the order of deposition, containing fewer of recent and more of extinct kinds, even to whole general classes and orders of being, call for the like reference to the continued action of similar causes through periods of countless duration.

Numerous large districts of the earth contain immense deposits of marine shells, which must therefore once have formed the bed of the ocean above which they are now elevated; and as they exhibit an unbroken level, we infer that they were gradually elevated without disturbance by similar slowly-acting subterranean causes, such as have been shown to produce elevating forces now gradually raising parts of existing continents.

Again; in other districts we trace the marks of sudden and violent local inundations at remote epochs: precisely such inundations have been known to be produced by submarine volcanic action. Such effects may clearly be supposed to have taken place upon a larger scale where the phenomena indicate it, but we are still not departing from just analogies.

All the changes of which we have evidence in past epochs have been manifestly *local*; just as the operation of existing causes is confined to a series of the like partial and local alterations. Thus no sound inductive geologist at the present day can admit anything like a universal simultaneous formation, or sudden action, applying at once to the entire surface of the present dry land. One small portion after another has been successively deposited, elevated, peopled with animal and vegetable life, again in the course of profoundly-adjusted changes to be obliterated and overwhelmed, while another has been in progressive advance.

Just and sober inductive science, applied to the examination of the actual structure of the earth's crust, enables us with satisfaction and certainty to trace the changes which have taken place on the surface of a globe possessing the same general nature as the existing earth, and in the structure and habits of organized beings *analogous* to those now inhabiting the world. It investigates the alterations which have been effected by physical agents resembling those now in operation, and in accordance with general laws the same as those now recognised in the economy of nature. But it does not and cannot rise to the disclosure of what might have occurred under a different state of things, or owing to the action of causes of a different order from those now discovered by physical research. It cannot show a *chaos*, or trace the evolution of a world out of it. It cannot reason upon a supposed state of universal confusion and ruin, and the immediate reduction of it into order and arrangement.

It can investigate the changes of things, but *not* their origin. In a word, sound *geology* will never aspire to the character of *cosmogony*. Yet geology is peculiarly distinguished from other branches of physical science, in this, that, while they teach us only the *existing* order of nature, it carries us back in time, and shows a period when the present races of organized beings did *not* exist, and by consequence establishes the *fact of their having in some way received a commencement of being*, and in truth the occurrence of *many such events*; and these not brought about at any one marked period, or extending to all animated nature at once, but by the slow and gradual introduction of each new species while yet the older partially remained; and each in turn thus progressively yielding its place to be filled up with fresh forms of organization. All that geology establishes in respect to organized life is the *fact of the gradual origination of new species*, but by no means the *particular method or process* by which it was brought about.

It is true there have not been wanting theories to explain these processes on supposed natural principles: yet these have not been altogether satisfactory or free from material objections. Physical research, indeed, in its nature, cannot bring us to any distinct conception of what we term an act of creation. If we consider the simple case of the introduction of a single species, or even an individual of a new species, there is an obvious limit imposed on our speculations. On the other hand, it is certainly quite open to the physiological inquirer to trace, as closely as he can, the secondary means, if any, as far as the nature of the case admits, by which it is conceivable that such changes may have been brought about or modified. Such inquiries may produce no satisfactory results, but certainly it is the *only legitimate channel* open to the inductive inquirer, to examine carefully all the possible effects which different combinations of natural conditions, as temperature, domestication, crossing of breeds, and the like, may produce. Theories, indeed, of this kind have been proposed and carried out by some to a most singular and preposterous extent, and a series of transmutations of species imagined which seem more like the hallucinations of insanity than the sober deductions of science. Yet the broad question respecting the immutability of species, and the abstract possibility of a transition from one into another, of the modifications of intermediate races being perpetuated, of new species being thus eventually introduced, have fairly formed subjects of debate among physiologists. At all events, if natural science ever should be able to conduct us to any satisfactory knowledge on such a subject, it can only be by some such route as this. But in comparing what may have occurred in remote epochs with the analogous facts of modern observation on the modifications of species, there is one point most carefully to be remembered—the *limited time* during which existing operations have been contemplated—from which it would be unsafe to argue what may have taken place in the vast and almost unlimited periods of past duration.

In those rocks, of whatever date, which are of igneous origin, or show marks of having undergone fusion, if organic remains ever existed, it is clear they must have been destroyed, so

that we can argue nothing from their non-appearance.

With reference to the present question, it will be readily apparent that our knowledge of the subject can go no higher than the evidence of fossil remains carries us.

In the earliest rock in which any organic remains have *yet been found*, these remains are *not* those of *plants*, but of *animals*, and these not absolutely of the *lowest* kind; and from this first *observed* origin of organic life there is no break in the vast chain of organic development till we reach the existing order of things—no one geological period, long or short—no one series of stratified rocks everywhere devoid of traces of life: the world, once inhabited, has apparently never, for any ascertainable period, been totally despoiled of its living wonders; but there have been many changes in individual forms, great alterations in generic assemblages, entire revolutions in the relative number and development of the several classes. The systems of life have been varied from time to time, to suit the altered condition of the globe, but never extinguished.

The proportionate *number* of species has gone on increasing in the successive generations up to the multitudes of existing species. The change in organic *structure* also has been in some degree proportioned to the time elapsed; but we cannot lay down any distinct principle as to the law by which its progression, its greater or less complexity or perfection in the scale of existence, can be decided; though *generally* we may say that the higher forms of life are not found till we come to the more recent strata.

Throughout the whole we trace one unbroken continuity of plan and design: different races of animals and plants have successively arisen as others disappeared, the disappearance of the one and the introduction of the other being each coincident with changes in the state of the globe.

The existing forms of life *resemble* those of times gone by, as the general aspect of the physical conditions of the world has always been analogous; and they *differ* from them as the co-relations of life and physical conditions are strict and necessary: so that all the variations of these conditions are represented in the phases of organic structure, while all their general agreements are also represented by the conformity of the great principles of structure in the creatures of every geological age, and the often-repeated analogies and parallels of series of forms between different geological periods, which we find as a law of nature, when comparing the most distant regions with each other. We are not then in a *different* system of nature, properly so called, from those which have been created and have been suffered to pass away before the origin of the human race; but in an *advanced part* of the *same* system, whose law of progression is fixed, though from time to time the signification of the term varies. The full and complete system of organic life now on the globe includes all the effects of sea and land, warmth and cold, divided regions, and all other things which are the diversifying causes of nature; and it is no wonder if, before the present land was raised from the deep, and the present distinction of natural regions was produced, there was not the same ex-

treme variety of natural productions which we now witness, and which is not without its end in rendering the globe a more fitting residence for intellectual beings.

Looking to the very latest periods to which Geology refers, we find detached portions of the surface composed of beds containing remains of species nearly the same as those now existing; and every indication presented by the nature, form, structure and obvious mode of formation, deposition, and elevation of these beds, is precisely similar to what is now found actually going on, and especially to the results of exactly similar modes of action which we trace in operations which have gone on within the period of the existing order of things. The imbedding of existing races of animals and plants in ancient peat bogs, in dried-up lakes, in new-formed deltas and shoals, and the destruction of other portions of the actual surface and its productions, by the action of the sea, landslips, and submergencies; as well as, above all, the exact identity of the action of modern earthquakes and volcanoes with those of old formations—all attest the unbroken uniformity of the chain of causation which unites the present state of things with all those varying conditions which we trace in earlier epochs, and which have only appeared to some to present so much more strongly-marked vicissitudes, because we are apt to crowd those events together in the perspective, and measure them too much according to our narrow ideas of duration. Thus, whether we look at these changes in time or in space, we find in the one no definite assignable period at which we can fix any one grand revolution or distinct era—no one portion of the earth's surface which we can say was all produced, with its organized inhabitants, at one time. All the epochs of change were gradual; the different orders of things passed by insensible gradations from one into another; all parts of the globe were brought into their present state by small local instalments.

In the tertiary strata (and to some extent in the older also) it must be borne in mind that the precise line of demarcation is by no means so absolute as is often imagined. The broad classification into different periods, according as a majority or a minority of existing species may appear in the several beds, is, in a great degree, conventional: *e. g.*, we cannot positively fix on any one epoch when the miocene period ended and the pleiocene began; and as those changes or modes of physical action which produced the tertiary beds were manifestly of exactly the same nature as those now going on upon the earth's surface, and as those changes were at least the accompanying conditions of the extinction of some species and the introduction or creation of others, so we can by no means infer that we have now arrived at a stationary or permanent condition, whether of unorganized or of organized existence.

The more the details of the *latest* geological phenomena are studied, the less shall we be able to imagine that there has been, at any comparatively recent period, a *clearly defined epoch* at which what we call the present order of things was completely and at once established, and a *cessation of all change* has occurred; or that further examples of creative power may not again take place by the same *slow and gradual process*

by which they probably were carried on in past eras. The more the examination of the most superficial parts of the earth's surface is extended, the more evidence is accumulated of partial and local changes exactly similar to those which distinguish the tertiary functions, going on uninterruptedly up to the present time; and it is clearly contradictory to all principles of inductive analogy to assert that in the progress of these changes new modifications of local temperature, moisture, and other physical conditions, will not occur, and that their occurrence will not be accompanied by the extinction of races of beings to which the localities will then be unsuited, and that fresh instances of providential adaptation, in the creation of new species, fitted to supply their places, will not be displayed. With regard to the most material point, *the origin of the human race*, the evidence is chiefly negative. It is positive only thus far: that in the earlier formation the physical conditions of the globe, and the nature of the animals which did exist on it, concur in showing that it would have been impossible for the human race to have been sustained in life or well-being. In the latter stages of things there is no such reason why man might not have existed. But the fact is, no human remains have been found. In the tertiary strata the nearest approach has been the distinct discovery of remains of the monkey tribe. It is clearly impossible, then, on geological grounds, to affirm that human remains may not be discovered in the latest tertiary beds, or to place any such positive limit of antiquity to the possible existence of the human species. It can only be asserted, at present, that, as far as research has yet gone (1843), it has detected no human remains older than those deposits which are probably within the period of history.

As bearing, then, on the subject of *creation*, or the origin of life and organized structures, the whole evidence which geology furnishes is certainly irreconcilable with the idea of one simultaneous general development of organized existence. It points, indeed, to a commencement of organized life; but shows that as successive forms and species of organization from time to time disappeared, new forms and new species were produced to supply their places; that these changes corresponded to others in the physical conditions of the globe; but that none of them were at once universal in extent and simultaneous in time; lastly, that the human race (*probably*) did not come into existence till the period to which the present state of things belongs.

In offering this imperfect summary of the general results derivable from *geology* which bear upon the subject of *creation*, we conceive enough may have been stated to enable the discerning reader at once to perceive the nature and extent of the discrepancy which exists between the changes, thus incontestably disclosed to us by the existing monuments of past ages of terrestrial existence, and the entire character and scope of the descriptive narrative of the Creation in the Hebrew Scriptures. We referred to certain interpretations of that narrative which have, in truth, been framed expressly with the view of attempting to reconcile the contradiction. After all we have before said, we shall not think it necessary here to press the matter much further on the notice of our

readers: they have before them the materials for forming their own judgment. We will merely say for our own parts that we fail to perceive how those interpretations can be supported on any rational basis so as really to explain the discrepancy, or effectually to defend the cause to whose aid they are summoned, since the main points of the discrepancy still remain untouched, viz., that there are no traces of any such catastrophe as must be supposed, even over a limited portion of the earth's surface, subsequent to the latest tertiary formation; and any of the other interpretations are absolutely contradicted by the whole tenor of the facts in reference to the suddenness and universality implied in the description, if natural days are maintained, and in long periods the total want of correspondence between those periods and any order of succession which can be made out from geological evidence.

With regard to the nature and extent of the discrepancy thus disclosed, we would observe, that it is not a case merely involving the question of the literal acceptance of a word or a phrase—it is not a parallel case (*e. g.*) with that of the incidental scriptural expressions, implying, in their letter, the motion of the sun, or the existence of a solid firmament—nor is the difficulty of the same nature with any sceptical objections to a supernatural narration: but it is the contradiction of existing monuments of past events with the obvious sense of what is recorded as a part of Divine revelation, in the form of a circumstantial narrative of the same events. And the discrepancy is not one with any theory, or partial discovery of science, which is not yet thoroughly made out, and which future investigations may modify or set aside; but with broad primary facts which involve nothing hypothetical, and which are in reality identified with the first principles of all inductive truth. It is also a circumstance which, taken any way, involves a train of consequences. It is not an isolated difficulty like that attaching to some single detached point, which we can pass over and not allow to weigh against the evidence preponderating on the other side; but it essentially involves a broad principle, and must affect, in its consequences, the entire view we take of the authority and application of the Old Testament.

That the existence of a discrepancy or difficulty of this kind, especially at the first announcement of those discoveries which disclosed it, should have been viewed by many with astonishment and alarm, is no more than might have been expected. That in the first instance the whole weight of censure should have been directed against the science of geology, is what numerous and somewhat parallel cases in former times would have led us to anticipate. It would be improper in this place to advert even remotely to topics of dispute or irritation. We shall merely observe that, at the present day, a happier spirit seems beginning to prevail. There are few now who venture upon open expressions of hostility; and this is no doubt from the simple cause that earnest attention and diligent examination have been called forth: the subject is beginning to be generally understood; misconception and acrimony, alarm and suspicion, have been gradually set to rest; and those who feel most forcibly the amount and nature of the contradiction are most

ready to confess the unsatisfactory character of those solutions of it to which we have adverted, and which rather gloss over and elude the real difficulty than fairly meet it. The main source of objection and offence has doubtless been the prevalence of certain views of the tenor and design of the Old Testament, which have by long custom passed current, among certain classes of Christians more especially, and in virtue of which the particular points involved in the narrative of the creation have come to bear a meaning and application connected directly with the existing institutions of religion. On the other hand, a more careful view of the actual design of the Hebrew Scriptures may do much towards removing this source of embarrassment.

In speaking of the Scripture narrative we have already remarked its striking characteristics as a *composition*—this of course applies in detail to the narrative in Genesis; but the brief statement in the Decalogue preserves also, as far as it goes, the same features. No reader of the Scriptures, especially of the Old Testament, can be otherwise than aware of the entire system which pervades all its representations, more or less, of *adaptation* in the manner of expression, form of imagery, and the like, to the apprehensions, the prejudices, and previous belief of the Jewish people; nay, the whole dispensation, in all its parts and institutions, is but one grand exemplification of the same thing. And this character in it we find expressly recognised and dwelt upon by our Lord and his apostles, in addressing that people, as the very ground of argument for introducing to those who were then living under the law a better and more spiritual religion: 'Moses, because of the hardness of your hearts,' gave you this precept (Matt. xix. 8); 'The law was a schoolmaster to bring them to Christ' (Gal. iii. 24)—a scheme of instruction and education (as it were) suited to their capacities and accommodated to their apprehensions. And not to dwell on instances which can only be accounted for as *adaptations* of this kind, such as the various sanguinary enactments, the visitation of sin on the posterity of the offender, the toleration of polygamy, the extreme facility of divorce, and the like, we cannot but recognise a similar object, as well in the general anthropopathism of the Old Testament, as in more special instances of many parts of those compositions in which poetic imagery, parable, and apologue were employed; and it is therefore nothing at variance with the nature or design of that revelation, but rather eminently conformable to it, to suppose that in other instances similar forms of narrative may have been adopted in like manner as the vehicles of religious instruction; still less to admit that they may have long been mistaken for historical matter-of-fact statements.

In the present instance the adaptation to the people of Israel was manifestly of the greatest importance, in order to secure their attention to points of vital moment in connection with the worship of the one true God, and their renunciation of idolatrous superstition. With this end, the first great truth with which they were to be impressed was the unity, omnipotence, and beneficence of the Creator: but these great doctrines were not put before them as abstract philosophical propositions, which their narrow and uncultivated minds would have been wholly incapable of

comprehending: they were therefore embodied and illustrated in a narrative, proceeding step by step, in a minute detail, to assert, in each individual instance, the power and goodness which they were thus led to recognise in every familiar detail of the natural world, and which could thus alone be effectually impressed upon their minds.

Another very material object was to remind them, in like manner, that those very beings, the animals which formed the objects of the idolatry of the Egyptians, to which they were so prone, were in truth but the creatures of the true God: hence the importance of dwelling, with minute particularity, on their creation and subordination to man; as well as the express prohibition of worshipping even the images of them, or so much as making such images. In all this we cannot but trace the same wise system of exact accommodation to the peculiar capacity and condition of this people, so little advanced at that time in moral or intellectual cultivation, and even exhibiting at all times a considerable national and constitutional incapacity for higher views, as the tenor of their after-history abundantly testifies. To this 'hard-hearted and stiff-necked generation,' then, so necessary was the utmost condescension and adaptation of all institutions (especially of a religious nature), and of the language and illustrations in which the communication of religious truths and precepts was to be made, that we find a reference to this principle perpetually pressed upon us to interpret much which otherwise seems singular in their sacred books, and which, unless so considered, is almost inevitably liable to be greatly misunderstood; and which from want of attention to this distinction has been, and continually is, misapplied, and even made a ground of sceptical objection.

These remarks refer yet more directly to what doubtless was the third and chief object in this representation of the creation—the institution of the Sabbath. This remarkable observance—the peculiar badge of the chosen people, to distinguish them from all other nations (Exod. xxxi. 13; Ezek. xx. 12)—was appointed them before the delivery of the rest of the law (Exod. xvi. 25); and as the work of creation, with reference to the different classes of beings, was associated in their minds with each of the six days, so the Seventh was identified, in the order of the narrative, with the entire completion of the work, the Divine rest and cessation from it, and the solemn sanctification of it pronounced, to consist in a precise abstinence from any kind of labour by themselves, their household, and even cattle. They were thus led to adhere to this duty by reflections connected with the highest truths impressed under the most awful sanctions; and the wisdom of the injunction, not less than the means thus taken to promote and secure its fulfilment, cannot but the more fully appear the more we examine the character and genius of this singular people, for whom it was ordained, and to whose peculiar condition it was in every way so remarkably adapted.

The narrative, then, of six periods of creation, followed by a seventh similar period of rest and blessing, was clearly designed, by adaptation to their conceptions, to enforce upon the Israelites the institution of the Sabbath: and in whatever way its details may be interpreted, it clearly can-

not be regarded as an *historical* statement of a *primeval* institution of a sabbath: a supposition which is, indeed, on other grounds, sufficiently improbable, though often adopted. But on this subject we refer the reader to our article 'SABBATH.'

If, then, we would avoid the alternative (otherwise inevitable) of being compelled to admit what must amount to impugning the truth of these portions, at least, of the Old Testament, we surely are bound to give fair consideration to the only suggestion which can set us entirely free from all the difficulties arising from the geological contradiction which does and must exist against any conceivable interpretation which retains the assertion of the *historical* character of the details of the narrative, as referring to the distinct transactions of each of the seven periods.

The one grand fact, couched in the general assertion that all things were created by the sole power of one Supreme Being, is the whole of the representation to which an historical character can be assigned. As to the particular form in which the descriptive narrative is conveyed, we merely affirm that it *cannot* be *history*—it may be *poetry*.

But there is one consideration further, to which we must advert in connection with this topic, viz. that in the repetition which Moses gives of the Decalogue (Deut. v. 14, 15), the latter part of the fourth commandment relative to the Creation is omitted, and a different reason for the observance of the sabbath inserted. This has led some commentators to suppose that in *neither* case is that latter clause to be considered as having really formed a portion of the commandment as delivered from Mount Sinai; but that it was in both cases added as a sort of comment by Moses himself. This, if it be so, will manifestly on reflection be seen to remove some portion of the difficulty of conceiving the *poetical* nature of the description. The Divine command may have been given *simply* to the Israelites; and Moses may have been authorized to recommend and impress it further by the addition of such topics as would best coincide with the preconceptions of popular belief, where it was not at variance with any real truth of religion.

In regard both to this and many other difficulties of the Old Testament, there has been too great a proneness to overlook the consideration of its original exclusive design of adaptation to the purposes of a limited dispensation addressed to one people only. When we bear this more distinctly in mind, many of those difficulties are in a very great degree removed. And this is surely the true view to be taken of it by *Gentile* Christians, to whom it is *only* a guide and instructor *second and subordinate* to the *New Testament*—a dead letter without it; but 'able to make us wise unto salvation "ONLY" through faith which is in Christ Jesus' (2 Tim. iii. 15).

Another objection of a very different kind has been started with reference to this subject, which it certainly would not have occurred to us to notice, had it not really been entertained as a serious difficulty by many; and so much so as to have called forth a printed discourse from so distinguished a person as Dr. Buckland—the alleged objection, that the existence of *death* in the animal world (of which certainly the whole

series of organic remains furnishes un-interrupted evidence through all epochs) is at variance with the Scripture doctrine that death was first introduced as the penalty attached to sin in the instance of Adam's transgression. We can only say that to us it was a new idea that the inferior animals were in any way involved in the consequences of man's obedience or disobedience. To those who really feel any degree of difficulty on the subject we can only recommend a perusal of what Dr. Pye Smith has remarked upon it in his work before referred to (p. 286, &c.).

We must also add a brief remark on one further point which has sometimes formed a topic of controversy, closely connected with the subject of *Creation*—the origin of the human race from a single primeval pair.

Viewed as a question of natural history simply, all the different races of men are but *varieties* of one *species*; since the physiological distinction of a *species* is that any of its *varieties* are capable of producing a *mixed* offspring which shall be itself *prolific*; with the mixture of *species* it is not so. A *species*, therefore, however widely spread, and however distinct its subordinate varieties, may in *theory* have originated from a single pair. Physiology, then, thus far shows nothing at variance with the belief that the human species *did* thus derive its origin.

There may, however, obviously be questions of another kind, such as the existence of local obstacles, the probable rate of increase, and the like, which must influence our belief as to the *fact*. These apparent difficulties, such as the peopling of America, and of the multitudes of islands especially in the midst of the Pacific Ocean, together with the length of time necessary for the spread and growth of such immense populations as even at very remote epochs must have inhabited many large districts, where we trace remains of high civilization of unknown antiquity, have induced many to adopt the idea that there must have been original creations of man in many different parts of the globe; and this, too, subsequently to the Mosaic deluge, if we are to understand it in a strictly universal sense [DELUGE].

It seems also incumbent on those who adhere so strictly to the letter of the Scriptural narrative to bear in mind that the existence of other races besides the family of Adam seems to be almost unavoidably implied in several particulars of that narrative. Thus in Gen. iv. 14, Cain complains that when he wanders forth on the earth, 'every one that findeth me shall slay me,' and accordingly a mark is set upon him, 'lest any finding him should kill him.' Again (ver. 17), Cain, going forth with his wife and child only, built a city, which at least must imply some collected number of persons. When Cain's wife is mentioned (ver. 17), it is without the slightest allusion to her origin; and the extraordinary nature of the vulgar belief on that subject ought certainly (on all grounds) to be fairly balanced along with the alleged religious necessity for imagining only one descent for the human race. To these may be added the consideration of the very obscure passage (Gen. vi. 2, 4) respecting the progeny of 'the sons of God' and 'the daughters of men.'

These and other topics, though we can do no more than thus briefly allude to them, must

nevertheless he carefully taken into consideration in whatever opinion we form on the subject. It is doubtless a question of great difficulty, in whatever light we view it; but more particularly so from the connection which it holds in the minds of many with the doctrine of original sin as connected with the fall of Adam. But for a discussion of so very wide and important a point we must refer the reader to other heads.—E. P.

CRESCENS (Κρήσκης), an assistant of St. Paul's, and generally supposed to have been one of the seventy disciples of Christ. It is alleged in the *Apostolical Constitutions* (vii. 46), and by the fathers of the church, that he preached the Gospel in Galatia, a fact probably deduced conjecturally from the only text (2 Tim. iv. 10) in which his name occurs. There is a less ancient tradition (in Sophronius), according to which Crescens preached, went into Gaul, and became the founder of the church in Vienna; but it deserves no notice, having probably no other foundation than the resemblance of the names Galatia and Gallia.

CRETE (Κρήτη), one of the largest islands in the Mediterranean, now called Candia, and by the Turks, Kirid. It is 160 miles long, but of very unequal width—varying from thirty-five to six miles. It is situated at the entrance of the Archipelago, having the coast of the Morea to the southwest, that of Asia Minor to the north-east, and that of Libya to the south. Great antiquity was affected by the inhabitants, and it has been supposed by some that the island was originally peopled from Egypt; but this is founded on the confusion that Crete was the Caphthor of Deut. ii. 23, &c., and the country of the Philistines, which seems more than doubtful [ΚΑΠΤΗΘΟΡ]. Surrounded on all sides by the sea, the Cretans were excellent sailors, and their vessels visited all the neighbouring coasts. The island was highly prosperous and full of people in very ancient times: this is indicated by its 'hundred cities' alluded to in the epithet *ἑκατόμυτος*, applied to it by Homer (*Il.* ii. 649). The chief glory of the island, however, lay in its having produced the legislator Minos, whose institutions had such important influence in softening the manners of a barbarous age, not in Crete only, but also in Greece, where these institutions were imitated. The natives were celebrated as archers. Their character was not of the most favourable description; the Cretans or Kretans being, in fact, one of the three K's against whose unfaithfulness the Greek proverb was intended as a caution—Καρπαδοκία, Κρετε, and Κιλίκια (τρία κάππα κίκιονα, Καρπαδοκία, και Κρήτη, και Κιλίκια). In short, the ancient notices of their character fully agree with the quotation which St. Paul produces from 'one of their own poets,' in his Epistle to Titus (i. 12), who had been left in charge of the Christian church in the island:—'The Cretans are always liars (ψεύσται, eternal liars), evil beasts (κακά θηρία, Angl. 'brutes'), slow bellies' (γαστέρες ἀργαί, gorbellies, bellies which take long to fill). The quotation is usually supposed to have been from Callimachus's *Hymn on Jove*, 8; but Callimachus was not a Cretan, and he has only the first words of the verse, which Jerome says he borrowed from Epimenides, who was of Crete. Ample corroboration

of the description which it gives may be seen in the commentators.

Crete is named in 1 Macc. x. 67. But it derives its strongest scriptural interest from the circumstances connected with St. Paul's voyage to Italy. The vessel in which he sailed, being forced out of her course by contrary winds, was driven round the island, instead of keeping the direct course to the north of it. In doing this, the ship first made the promontory of Salmone on the eastern side of the island, which they passed with difficulty, and took shelter at a place called Fair-Havens, near to which was the city Lasea. But after spending some time at this place, and not finding it, as they supposed, sufficiently secure to winter in, they resolved, contrary to the advice of St. Paul (the season being far advanced), to make for Phœnice, a more commodious harbour on the western part of the island; in attempting which they were driven far out of their course by a furious east wind called Euroclydon, and wrecked on the island of Melita (*Acts* xviii.).

CRIMSON. [PURPLE; SCARLET.]

CRISPUS (Κρίσπος), chief of the Jewish Synagogue at Corinth (*Acts* xviii. 8), converted by St. Paul (1 Cor. i. 14). According to tradition (*Constitut. Apost.* vii. 46) he was afterwards bishop of Ægina.

CRITICISM, BIBLICAL. This phrase is employed in two senses. Some take it to signify not only the restoration of the text of Scripture to its original state, but the principles of interpretation. This is an extensive and improper application. The science is strictly occupied with the *text* of the Bible. It is limited to those principles and operations which enable the reader to detect and remove corruptions, to decide upon the genuineness of disputed readings, and to obtain as nearly as possible the original words of inspiration. Its legitimate object is to ascertain the purity or corruption of the text. It judges whether an alteration has been made in a passage; and when it discovers any change, it labours to restore the primitive readings that have been displaced. There are three sources from which Biblical criticism derives all its aid, both in detecting the changes made upon the original text, and in restoring genuine readings.

1st. MSS. or written copies of the Bible.

2nd. Ancient translations into various languages.

3rd. The writings and remains of those early ecclesiastical writers who have quoted the Scriptures.

Some add a fourth, viz., *critical conjecture*, but the authority of this we are disinclined for the most part to allow.

Criticism employs the ample materials furnished by these sources. To attain its end it must work upon them with skill and discrimination. They afford wide scope for acuteness, sobriety, and learning; and long experience is necessary in order that they may be used with efficiency and success.

The present article will contain a brief historical sketch of Biblical criticism, or a history of the texts of the Old and New Testaments; the condition in which they have been at different periods; the evidences on which our knowledge of their purity or corruption rests, and the

chief attempts that have been made to rectify or amend them. A history of criticism must describe the various stages and forms through which the texts have passed. It will be expedient to reserve an enumeration of the *causes* which gave rise to various readings to a future article [VARIOUS READINGS], and, on the present occasion, to detail the phases which the Hebrew and Greek texts of the Old and New Testaments have presented both in their unprinted and printed state, in connection with the labours of scholars to whom such texts presented an object of interesting attention and diligent inquiry.

We shall commence with the text of the Old Testament. There are four marked periods in the history of the Hebrew text.

1. *That period in the history of the unprinted text which preceded the closing of the canon.*—Of this we know nothing except what is contained in Scripture itself. The Jews bestowed much care on their sacred books. They were accustomed to hold them in great veneration even in the darkest times of national apostasy from Jehovah. How often the separate book; were transcribed, or with what degree of correctness, it is impossible to tell. Many German critics suppose that the Hebrew text met with very unfavourable treatment; that it was early subjected to the carelessness of transcribers and officious critics. Hence they assume that it suffered great alteration and corruption. Differences, however, between parallel sections do not prove what Neologists adduce them to demonstrate. They show rather the genuineness and integrity of the books in which they occur. Had such paragraphs *exactly harmonized*, we might have suspected design or collusion; but their variations discover the artlessness of the writers. We disagree with Eichhorn, Bauer, Gesenius, De Wette, and others, who have given lists of parallel passages in some books in order to show that the text was early exposed to extensive alterations.

The most important particular in this part of the history is the Samaritan recension of the Pentateuch [PENTATEUCH]. This edition (if so it may be called) of the Pentateuch is indeed uncritical in its character. While we freely acquit the Jews of tampering with the text of the Mosaic books, the Samaritans cannot be so readily exonerated from the imputation. As far as the latter are concerned, we are compelled to believe, that the words of the Most High were not always treated by them with sacred respect. Additions, alterations, and transpositions, are quite apparent in their copy of the Pentateuch. A close alliance between the text which lies at the basis of the Septuagint Version and that of the Samaritan Pentateuch has been always noticed. Hence some think that they flowed from a common recension. One thing is certain, that the Seventy agree with the Samaritan in about 2000 places in opposition to the Jewish text. In other books, too, of the Old Testament, besides the five books of Moses, the Seventy follow a recension of the text considerably different from the Jewish. Thus in Jeremiah and Daniel we find a different arrangement of sections, as well as a diversity in single passages. The books of Job and Proverbs present a similar disarrangement and alteration, which must be put down to

the account of the Alexandrian Jews and Greek translators. Far different was the conduct of the *Palestinian* Jews in the treatment of the sacred books. They were very scrupulous in guarding the text from innovation, although it is impossible that they could have preserved it from all corruption. But whatever errors or mistakes had crept into different copies were rendered apparent at the time when the canon was formed. We believe with Hävernick (*Einleitung in das Alte Testament*, p. 49) that 'Ezra, in unison with other distinguished men of his time, completed the collection of the sacred writings.' He revised the various books, corrected inaccuracies that had crept into them, and rendered the Old Testament text perfectly free from error. Thus a correct and genuine copy was furnished under the sanction of Heaven. Ezra, Nehemiah, and those with whom he was associated, were infallibly guided in the work of completing the canon.

2. *From the establishment of the canon to the completion of the Talmud, i. e. the commencement of the sixth century after Christ.*—The Targumists Onkelos and Jonathan closely agree with the *Masoretic* text. The Greek translations of Aquila, Symmachus, and Theodotion, belonging to the second century, deviate from the form of the text afterwards called the *Masoretic* much less than the Seventy. The Hebrew column of Origen's Hexapla presents a text allied to the *Masoretic* recension. Jerome's Latin version, made in the fourth century, is conformed to the same Hebrew original. In the two Gemaras, viz. the Jerusalem and the Babylonian, belonging to the fourth and sixth centuries respectively, we discern many traces of critical skill applied to the preservation of a pure text. Different readings in MSS. are mentioned, precepts are given respecting Biblical calligraphy, and true readings are restored. By far the most important fact which they present is the adducement of *classes* of critical corrections made at an earlier period, and which Morinus (*Exercitationes Biblicæ*, p. 408) justly calls the *fragments or vestiges of recensions*. These are—(1) עטור סופרים *Ab-latio scribarum*. (2) תיקון סופרים *Correctio scribarum*. (3) *Puncta extraordinaria*. (4) כתיב ולא קרי *K'ri v'lo K'thib*. (5) כתיב ולא קרי *K'thib v'lo K'ri*. (6) The Talmud also mentions different readings which the Masoretes call קרי וכתב *K'ri uk'thib*.

The writings of Jerome afford evidence, that, in the fourth century, the Hebrew text was without the vowel-points, and even the *diacritic* signs.

3. *From the sixth century, in which the Talmud was completed, to the invention of printing.*—The learned Jews, especially those at Tiberias, where there was a famous school till the eleventh century, continued to occupy themselves with the Hebrew language and the criticism of the Old Testament. The observations of preceding Rabbis were enlarged, new remarks were made, and the vowel-system was invented, the origin of which can hardly be placed earlier than the sixth century. The name Masora has usually been applied to that grammatico-historical tradition, which, having been handed down orally for some centuries, became afterwards so extensive as to demand its committal to writing.

Much of what is contained in the Masora exists also in the Talmud. Part of it, however, is older than the Talmud, though not reduced to its present form till a much later period. The various observations comprised in the Masora were at first written in separate books, of which there are MSS. extant. Afterwards they were put in the margin of the Bible MSS.

When we speak of the *Masoretic recension* of the text, it is not meant that the Masoretes gave a certain form to the text itself, or that they undertook and executed a new revision. They made the *textus receptus* of that day the basis of their remarks, and gave their sentiments concerning it. Had the text been altered in every case where they recommend; had it been made conformable to their ideas of what it should be, it would have been appropriate to have called it the *Masoretic recension*. The designation, however, though not applicable in strictness, is customary.

The most important part of the Masora consists of the marginal readings or *K'ris*, which the Masoretes always preferred to the textual, and which the later Jews have adopted. The *K'ris* are *critical, grammatical, orthographical, explanatory, and euphemistic*. It has been a subject of dispute among scholars from what source the Masoretes derived the *K'ris*. It is highly probable, that they were generally taken from *MSS.* and *tradition*, though they may have been in part the offspring of conjecture. It is but reasonable to suppose that these scholars *sometimes* gave the result of their own judgment. In addition to the *K'ris* the Masora contains an enlargement of critical remarks found in the Talmud. Besides, the verses, words, and consonants of the different books of the Bible are counted, a task unparalleled in point of minute labour, though comparatively unprofitable.

The application of the Masora in the criticism of the Old Testament is difficult, because its text has fallen into great disorder. It was printed for the first time in the first Rabbinical Bible of Bomberg, superintended by Felix Pratensis. In the second Rabbinical Bible of Bomberg, R. Jacob Ben Chayim bestowed considerable care upon the printing of the Masora. At the end of this second Rabbinical Bible there is a collection of *oriental* and *western* readings, or, in other words, *Babylonian* and *Palestinian*, communicated by the editor, and the result of an ancient revision of the text. The number is about 216. Of the sources from which the collection was drawn we are entirely ignorant. Judging by the contents, it must be older than many observations made by the Masoretes. It should probably be referred to a period anterior to the introduction of the vowel system, as it contains no allusion to the vowels. It is certainly of considerable value, and proves that the *oriental* no less than the *western* Jews had always attended to the state of the sacred text.

In addition to this list, we meet with another in the Rabbinical Bibles of Bomberg and Buxtorf, and in the sixth volume of the London Polyglott, belonging to the eleventh century. It owes its origin to the labours of Ben Asher and Ben Naphtali, the respective presidents of academies in Palestine and Babylon. These readings, with a single exception, refer to the vowels and accents.

The vowel system had, therefore, been completed when this collection was made.

Here the history of the unprinted text may be said to close. The old unvowelled copies perished. New ones furnished with points and accents came into use. But although the ancient copies are now irrecoverably lost, there is no reason for supposing that their preservation to the present time would have had any essential influence in altering the form of the text. The text appears to have been established and settled when the punctuation-system was completed. The labours of the Masoretic doctors have been of substantial benefit in maintaining its integrity.

4. *From the invention of printing to the present time.*—There are three early editions from which all others have been taken. 1. That published at Soncino, A.D. 1488, which was the first entire copy of the Hebrew Scriptures ever printed. The text is furnished with the points and accents, but we are ignorant of the MSS. employed by the editor. 2. The second great edition was that in the Complutensian Polyglott, 1514-17, taken from seven MSS. 3. The third was the second Rabbinical Bible of Bomberg, superintended by R. Jacob Ben Chayim, Venice, 1525, 6 vols. fol. The text is formed chiefly after the Masora, but Spanish MSS. were used. Almost all modern printed copies have been taken from it.

The Antwerp Polyglott has a text compounded of those in the second and third recensions just mentioned.

Among the editions furnished with a critical apparatus, that of Buxtorf, published at Basel, 1619, occupies a high place. It contains the commentaries of the Jewish Rabbis, Jarchi, Abenesra, Kimchi, Levi Ben Gerson, and Saadiah Haggaaon. The appendix is occupied with the Jerusalem Targum, the great Masora corrected and amended, with the various readings of Ben Asher and Ben Naphtali.

The principal editions with various readings are those of Seb. Münster, Jablonski, Van der Hooght, J. H. Michaelis, C. F. Houbigant, and Benjamin Kennicott.

Münster's edition appeared at Basel in 1536, 2 vols. 4to. The text is supposed to be founded upon that of Brescia, 1494, 4to., which resolves itself into the Soncino edition of 1488.

Jablonski's edition was published at Berlin in 1699, 8vo., and again at the same place in 1712, 12mo. It is founded upon the best preceding editions, but chiefly the second edition of Leusden (1667). The editor also collated various MSS. The text is remarkably accurate.

Van der Hooght's edition appeared at Amsterdam, 1705. The text is taken from Athias' (1661 and 1667). The Masoretic readings are given in the margin; and at the end are collected the various readings of the editions of Bomberg, Plantin, Athias, and others.

The edition published by J. H. Michaelis in 1720, is accompanied with the readings of twenty-four editions which the editor examined, besides those of five MSS. in the library at Erfurt. There is a want of accuracy in his collations.

In 1753, C. F. Houbigant published a new edition in folio. The text is that of Van der Hooght, without the points. In the margin of the Pentateuch, the Samaritan readings are added. For it he collated, but hastily, twelve MSS. He

has been justly blamed for his rash indulgence in conjectural emendation.

Dr. Kennicott's edition, which is the most important hitherto published, appeared at Oxford—the first volume in 1776, the second in 1780. The number of MSS. collated by himself and his associates, the chief of whom was Professor Bruns of Helmstadt, amounted to 694. In addition to his collation of MSS. and printed editions, he followed the example of various editors of the Greek Testament in having recourse to Rabbinical writings, especially the Talmud. He has given quotations from Jewish writers. The immense mass of various readings here collected is unimportant. It serves, however, to show that, under the influence of the Masora, the Hebrew text has attained a considerable degree of uniformity in all existing MSS.

In 1784-88, John Bernard de Rossi published at Parma, in 4 vols. 4to., an important supplement to Kennicott's collection. These various readings were taken from 88 MSS. used by Kennicott, and collated anew by De Rossi, from 479 in his own possession and 110 in other hands, from many editions and Samaritan MSS., and also from ancient versions.

In 1793, Doederlein and Meisner published at Leipzig an edition intended in some measure to supply the want of the extensive collations of Kennicott and De Rossi. It contains the most important readings. The edition of Jahn, published at Vienna in 1806, is very valuable and convenient.

The most accurate edition of the Masoretic text is that of Van der Hooght as lately edited by Hahn at Leipzig, and stereotyped. The text of Van der Hooght may now be reckoned the *textus receptus*. (For accurate and complete lists of the printed editions of the Hebrew Bible, the reader is referred to Le Long's *Bibliotheca*, edited by Masch; and to Rosenmüller's *Handbuch für die Literatur der biblischen Kritik und Exegese*, i. pp. 189-277.)

Notwithstanding all these editions, something is still wanted. In the best of them there are passages requiring emendation. It is curious to observe how contradictions are allowed to remain on the face of the Old Testament history. It may be that the Masora has produced so great uniformity, as that extant MSS. do not sanction any departure from the present text; but where passages are manifestly corrupt, it is time that they should be rectified. The criticism of the Hebrew Bible is still behind that of the Greek Testament. The latter was earlier begun, and has been more vigorously prosecuted. We remain nearly in the same state with regard to the Old Testament text in which Kennicott and De Rossi left us, and it is time that some advance should be made in this department.

We shall now give a brief history of the New Testament text in its *unprinted* and *printed* form. The criticism of the New Testament is rich in materials, especially in ancient MSS. But, although the history of New Testament criticism records the industrious collection of a large amount of materials, it is not equally abundant in *well-accredited facts*, such as might be of essential benefit in enabling us to judge of the changes made in the text. History is silent

respecting the period when the two parts of the New Testament, viz. the *εὐαγγέλιον* and *ἀποστολος*, or, in other words, the four Gospels and the Pauline and remaining epistles, were put together, so as to form *one whole*. About the beginning of the third century, it is certain that all the books of the New Testament which we now possess were acknowledged to be divine, and regarded as canonical.

In the middle of the same century, Hesychius and Lucian undertook to amend the MSS. of the New Testament. Of their critical labours Jerome seems not to have entertained a high opinion. The MSS. they revised did not meet with general approval, and Pope Gelasius issued a decree against them. It is highly probable that they were not the authors of recensions which were widely circulated, or generally adopted. Origen did not revise the text of the New Testament.

At a comparatively recent period, certain internal marks were observed to belong to documents containing the same text. A similarity in characteristic readings was noticed. Bengel appears to have been the first to whom the idea suggested itself of dividing the materials according to the peculiarities which he faintly perceived. It was afterwards taken up by Semler, and highly elaborated by Griesbach. Later editors and critics have endeavoured to improve upon Griesbach's system. The different forms of text observed by Semler and Griesbach they called *recensions*, although the appellation of *family* is more appropriate. Perhaps the data that have been so much regarded in classifying the documents containing the New Testament text are insufficient to establish any system. The subject of recensions, though frequently discussed, is not yet settled. In the history of the *unprinted* text it is the chief topic which comes before the inquirer. Reserving it for future notice [RECENSIONS], we pass to the history of the *printed* text, and the efforts made to amend it.

The *whole* of the New Testament was first printed in the Complutensian Polyglott, 1514, though not published till 1517. The first published was that of Erasmus, at Basel, in 1516. Both were issued independently of one another, and constitute the basis of the *received text*. Yet the best materials were not employed in preparing them, and on both the Vulgate was allowed to exert an undue influence. Even critical conjecture was resorted to by Erasmus. No less than five impressions were published by Erasmus, into the third of which 1 John v. 7 was first put. In the last two he made great use of the Complutensian Polyglott.

The third place among the early editors of the Greek Testament has been assigned to Robert Stephens, whose first edition was printed at Paris, 1546, 12mo., chiefly taken from the Complutensian, and generally styled the *Mirifica* edition, from the commencement of the preface. His second edition was published in 1549; the third in 1550, in folio. In this last he followed the fifth of Erasmus, with which he compared fifteen MSS., and the Complutensian Polyglott. In 1551 appeared another edition, accompanied by the Vulgate and the translation of Erasmus. It is remarkable for being the first into which the division of verses was introduced.

The next person that contributed to the criti-

cism of the Greek Testament was Theodore Beza. The text of his first edition, 1565, folio, was the same as that of the third of Stephens, altered in about fifty places, accompanied with the Vulgate, a Latin version of his own, and exegetical remarks. In his second edition, 1582, he had the benefit of the Syriac version and two ancient codices. A third impression appeared in 1589, and a fourth in 1598. The *Elzevir* editions exhibit partly the text of the third of Stephens, and partly that of Beza. The first appeared at Leyden in 1624. The second edition of 1633 proclaims its text to be the *textus receptus*, which it afterwards became. Subsequently three other editions issued from the same press. The editor does not appear to have consulted any Greek MSS. All his readings are either in Beza or Stephens.

Brian Walton, the learned editor of the London Polyglott, gave a more copious collection of various readings in the sixth volume of that work than had before appeared; which was further enlarged by Dr. Fell, in his edition, published at Oxford in 1675, and reprinted by Gregory in 1703, folio.

Dr. John Mill, encouraged and supported by Fell, gave to the world a new edition in 1707, folio. The text is that of Stephens' third edition. In it the editor exhibited, from Gregory's MSS., a much greater number of readings than is to be found in any former edition. He revised and increased the extracts formerly made from ancient versions. Nor did he neglect quotations from the fathers. It is said that the work contains thirty thousand various readings. This important edition, so far superior to every preceding one, cost the laborious editor the toilsome study of thirty years, and excited the prejudices of many who were unable to appreciate its excellence. It commenced a new era in the criticism of the New Testament. Ludolph Kuster reprinted Mill's Greek Testament at Amsterdam, in 1710, enriching it with the readings of twelve additional MSS. The first attempt to emend the *textus receptus* was made by John Albert Bengel, abbot of Alpirspach. His edition appeared at Tübingen, quarto, 1731, to which was prefixed his "Introductio in crisin Novi Testamenti." Subjoined is an *apparatus criticus*, containing his collection of various reading, chiefly taken from Mill, but with important additions.

Dr. John James Wetstein contributed, in no small degree, to the advancement of sacred criticism, by his large edition of the Greek Testament, published at Amsterdam in 1751-2, 2 vols. folio. In 1730 he had published *prolegomena*. It was his desire to give a new and corrected text, but he was compelled by circumstances to exhibit the *textus receptus*. Yet he noted, partly in the text itself, partly in the inner margin, such readings as he preferred. His collection of various readings, with their respective authorities, far exceeds all former works of the same kind in copiousness and value. He collated anew many important MSS. that had been superficially examined, gave extracts from many for the first time, and made use of the Harclean (improperly called the Philoxenian) version, hitherto uncollated. For convenience he marked the *uncial* MSS. with the letters of the alphabet, and the *cursorie* with numerical letters. His exegetical notes are chiefly extracts from Greek, Latin, and Jewish writers. The edition of the Greek Testament,

under consideration, is indispensable to every critic, and will always be reckoned a marvellous monument of indomitable energy and unwearied diligence. The *Prolegomena* contain a treasure of sacred learning that will always be prized by the scholar. They were republished, with valuable notes, by Semler, in 1774, 8vo.

The scholar who is pre-eminently distinguished in the history of New Testament criticism, is Dr. John James Griesbach. He enriched the materials collected by Wetstein with new and important additions, by collating MSS., versions, and early ecclesiastical writers, particularly Origen, with great labour. The idea of *recensions*, recommended by Bengel and Semler, he adopted, and carried out with much acuteness and sagacity. His first edition appeared at Halle, in 2 vols., 1774-5. The first three gospels were synoptically arranged, but in 1777 he published them in their natural order. The text is founded on a comparison of the copious materials which he possessed. Nothing was adopted from conjecture, and nothing received which had not the sanction of codices as well as versions. A select number of readings is placed beneath the text. In his *Symbolæ Criticæ*, he gave an account of his critical labours, and of the collations of new authorities he had made. Such was the commencement of Griesbach's literary labours.

Between the years 1782-88, C. F. Matthæi published a new edition of the Greek Testament in 12 vols. His text was founded on a collation of more than 100 Moscow MSS., which he first examined. It is accompanied with the Vulgate, *schoiia*, and *excursus*. He avowed himself an enemy to the idea of *recensions*, despised the ancient MSS. (especially *cod. Bezae*), and the quotations of the fathers, while he unduly exalted his Moscow MSS. His chief merit lies in the careful collation he made of a number of MSS. hitherto unknown.

Before the completion of Matthæi's edition, appeared that of Alter, 1786-7, 2 vols. The text is that of the Vienna MS., with which he collated 22 others in the Imperial library. To these he added readings from the Coptic, Slavonian, and Latin versions.

In 1788, Professor Birch of Copenhagen enlarged the province of sacred criticism by his splendid edition of the four Gospels in folio and quarto. The text is a reprint of Stephens' third, but the materials appended to it are highly valuable. They consist of extracts taken by himself and Moldenhauer, in their travels, from many MSS. not examined by Wetstein, and of Alter's selections from the Jerusalem-Syriac version discovered in the Vatican. Birch was the first who carefully collated the *Codex Vaticanus*. The publication of the second volume was prevented by a fire that destroyed many of the materials. In 1798, he published his various readings on the remainder of the New Testament, except the Apocalypse. In 1800 he published those relating to this book also.

In 1796 appeared the first volume of a new and greatly-improved edition of Griesbach's New Testament. For it he made extracts from the Armenian, Slavonic, Latin, Sahidic, Coptic, and other versions, besides incorporating into his collection the results of the labours of Matthæi, Alter, and Birch. The second volume

appeared in 1806, both published at Halle. At the end of the second volume is a dissertation on 1 John v. 7. The work was reprinted at London in 1809, and again in 1818. The prolegomena are exceedingly valuable. This edition cannot be too highly rated. It is indispensable to every critic and intelligent theologian.

In 1827, many new materials having been procured since the date of Griesbach's last edition, it was thought necessary to publish a third. It appeared accordingly, under the superintendence of Dr. Scholz. The first volume contains the prolegomena, and the Gospels. It exhibits various readings from about 20 new sources, many corrections of Griesbach's references and citations, besides considerable improvements in other respects. The second volume has not yet been published (1843).

The editions of Knapp, Schott, Tittmann, Vater, Næbe, and Goeschel, are chiefly founded upon that of Griesbach. Of these the most esteemed is that of Knapp, which has passed through five editions, and is characterized by sound judgment, especially in the punctuation and accents.

In 1830 appeared the first volume of a large critical edition, superintended by Dr. J. Martin Augustus Scholz, professor at Bonn, containing the Gospels. The second volume, in 1836, completed the work. Both are in quarto. The editor spent twelve years of incessant labour in collecting materials for the work, and travelled into many countries for the purpose of collating MSS. The prolegomena prefixed to the first volume occupy 172 pages, and contain ample information respecting all the codices, versions, fathers, acts of councils, &c. &c., which are used as authorities, together with a history of the text, and an exposition of his classification system. In the inner margin are given the general readings characteristic of the three great families. The total number of MSS. which he has added to those previously collated is 606. Little reliance, however, can be placed on the accuracy of the extracts which he has given for the first time. His researches have tended to raise the *textus receptus* higher than Griesbach placed it. In consequence of his preferring the *Constantinopolitan* family, his text comes nearer the Elzevir edition than that of Griesbach. The merits of this laborious editor are considerable. He has greatly enlarged our critical apparatus. Yet in acuteness, sagacity, and scholarship he is far inferior to Griesbach. His collations appear to have been superficial. They are not to be depended on. Hence the text cannot command the confidence of Protestant critics. We cannot believe, with the editor, that the Byzantine family is equal in value or authority to the Alexandrine which is confessedly more ancient, nor can we put his junior codices on a level with the very valuable documents of the Oriental recension. His text is, on the whole, inferior to that of Griesbach. In a few important passages alone it is superior.

The edition of Lachmann, though small in compass, deserves to be mentioned. It was published in 1831, 12mo. The editor says that he has nowhere followed his own judgment, but the usage of the Oriental churches. The text of Lachmann has been well received in Germany, and much importance has been attached to it. From the authority it has obtained, it would ap-

pear that the Constantinopolitan text of Scholz is not very favourably regarded. De Wette, in his *Introduction to the Bible*, shows a leaning towards the views of Lachmann. Rinck coincides, on the whole, with the same. The last named scholar has enlarged the critical apparatus of the New Testament, by collating and describing several MSS. (*Lucubratio Critica in Acta Apost. epp. Cath. et Paulin., &c. &c.*, Basel, 1830, 8vo.)

Since the appearance of Lachmann's edition, another has been published in Germany by Dr. Tischendorf, which requires some notice. It exhibits a corrected text, taken from the most ancient and best MSS., with the principal various readings, together with the readings of the Elzevir, Knapp, Scholz, and Lachmann editions. Great pains have manifestly been bestowed on the text and the critical apparatus subjoined to it. The prolegomena, consisting of 85 pages, are exceedingly valuable. They treat of recensions, with an especial reference to Scholz's system; enumerate the readings peculiar to the third edition of Stephens and that of Mill, to the editions of Matthæi and Griesbach; and specify the critical materials employed in the elaboration of a pure text. The work under consideration appeared in 1841, 8vo., Leipzig. A careful perusal of the editor's able preface, and a collation of his text and critical apparatus beneath it, have convinced us of the sound judgment, minute diligence, extreme accuracy, and admirable skill by which this edition of the Greek Testament is characterized.

Very recently we have been favoured with the first volume of a large edition by Lachmann (*Novum Testamentum, Græce et Latine. Carolus Lachmannus recensuit. Philippus Buttmannus Ph. F. Græcæ lectionis auctoritates apposit.* Tomus prior. Berolini, 1842, 8vo.).

This is by far the most important edition that has appeared since the days of Griesbach, and must produce results highly favourable to the advancement of New Testament criticism. The principles on which Lachmann proceeds were expounded in the *Theolog. Studien und Kritiken* for 1830, pp. 817-845, and again in 1835, p. 570, sq. The path which he first pursued in his smaller edition was indicated by Bentley, who purposed to publish the Greek Testament on similar principles.*

In order to discover his *Oriental* text (a text which is substantially the same as the *Alexandrian*), Lachmann makes use of the following authorities:—1. A. B. C. D., as also P. Q. T. Z., in the Gospels, and in the Pauline epistles, H. in addition. 2. *Latin interpretations*, viz. in the Gospels the Vercellian, Veronian, Colbertine, Cambridge; in the Acts the Cambridge and Laudian; in the Pauline epistles the Clermont, St. Germain, Boernerian; in the Apocalypse the Primasian. In addition to these, the Vulgate,

* Hare wrote thus concerning Bentley, in 1724:—'Ad novum Fœdus ex antiquissimis edd. pristino nitore restituendum animum adiecit, ut Græcum textum ab insanâ variarum lectionum mole quam recentiores edd. invexerunt liberaret, et Hieronymi versionem ab erroribus purgatam talem daret, qualis e doctissimi patris manu exiit; opus profecto grande, et tanti viri diligentia, acumine, judicio imprimis dignum.'

as edited by Jerome, is everywhere employed. Of the fathers he consults Irenæus, Origen, Cyprian, Hilary, and Lucifer. The immense mass of later MSS. and fathers is entirely overlooked as useless.

The authorities for the Greek readings are given below the text; and, when it is considered how few materials are employed, it will be readily supposed that the various readings noted are not numerous. They are, however, most valuable and important.

In addition to the Greek text and critical apparatus, the Hieronymian Vulgate is given, in the same form, as nearly as possible, in which it proceeded from Jerome, with important readings extracted from the Fuldensian codex, from the same corrected by Victor bishop of Capua, and from the Laurentian codex. The great aim of the editor has been to exhibit a text in which the most ancient authorities are entirely agreed. Wherever this cannot be done with certainty, his critical apparatus shows the degree of probability attached to the text as given by him. To the volume is prefixed a preface of 55 pages (a few of them from Buttmann), in which the learned editor expounds his mode of procedure, and the authorities consulted. Respecting the opponents of his system, he does not speak in the most courteous or becoming language, nor is his Latinity the purest. Yet the preface is instructive withal, and must be studied by him who uses Lachmann's text.

We are inclined to attach primary importance to this edition, the remaining volume of which we shall look for with anxiety. Were we disposed to follow the text of any one editor *absolutely*, we should follow Lachmann's. But it may be doubted whether he has not confined himself to a range of authorities too circumscribed. By keeping within the *fourth* century, he has been occasionally compelled to rest upon one or two testimonies. We should therefore like to see more authorities consulted. We are persuaded, however, that this author has entered upon a right path of investigation which will lead to results both permanently useful and unusually successful.

The operations of sacred criticism have established the genuineness of the Old and New Testament texts in every matter of importance. All the doctrines and duties remain unaffected by its investigations. It has proved that there is no material corruption in the inspired records. It has shown that during the lapse of many centuries the Holy Scriptures have been preserved in a surprising degree of purity. The text is substantially in the same condition as that in which it was found seventeen hundred years ago. Let the plain reader take comfort to himself when he reflects that the received text which he is accustomed to read is *substantially* the same as that which men of the greatest learning and the most unwearied diligence have elicited from an immense heap of documents.

For a copious account of the various editions of the Greek Testament the reader is referred to Le Long's *Bibliotheca*, edited by Masch; or to Rosenmüller's *Handbuch für die Literatur der biblischen Kritik und Exegese*, i. pp. 278-422. See also an article on the 'Manuscripts and Editions of the New Testament,' by Moses Stuart, in

Robinson's *Bibliotheca Sacra*, No. 2, May, 1843. For an account of the principal authors on Biblical criticism, see Davidson's *Lectures on Biblical Criticism*, from which chiefly this article is abridged and condensed.—S. D.

CROCODILE. Although the term *κροκόδειλος* occurs in the Greek version, there is no specific word in the Hebrew of which it is the acknowledged representative. Reserving, however, our remarks on this subject for the articles **DRAGON**, **LEVIATHAN**, and **WHALE**, we shall in this place confine ourselves to some notice of crocodiles strictly so called, and, while we shall endeavour to simplify the discussion as much as possible, we shall point out some leading characters in the animal coinciding with allusions to it in the Scriptures, which could not be properly noticed elsewhere.

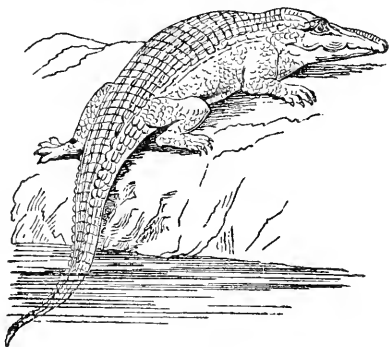

238.

The crocodiles which we have to notice at present consist of three varieties, or perhaps species, all natives of the Nile, distinguishable by the different arrangement of the scute or bony studs on the neck, and the number of rows of the same processes along the back. Their general lizard form is too well known to need particular description; but it may be remarked that of the whole family of crocodiles, comprehending the sharp-beaked gavials of India, the alligators of the west, and the crocodiles properly so called, the last are supplied with the most vigorous instruments for swimming, both from the strength and vertical breadth of their tails, and from the fingers of their paws having deeper webs. Although all have from thirty to forty teeth in each jaw, shaped like spikes, without breadth so as to cut, or surface so as to admit of grinding, the true crocodile alone has one or more teeth on each side in both jaws, exerted, that is, not closing within but outside the jaw. They have no external ear beyond a follicle of skin, and the eyes have a position above the plane of the head, the pupils being contractile, like those of a cat, and in some having a luminous greenish tinge, which may have suggested the allusion to 'the lids of the morning' (Job xli. 18). The upper jaw is not movable, but, as well as the forehead, is extremely dense and bony; the rest of the upper surface being covered with several rows of bosses, or plated ridges, which on the tail are at last reduced from two to one, each scale having a high bony crest, which acts as part of a great fin. Although destitute of a real voice, crocodiles when

angry produce a snorting sound, something like a deep growl; and occasionally they open the mouth very wide, remain for a time thus exposed facing the breeze, and, closing the jaws with a sudden snap, cause a report like the fall of a trap-door. It is an awful sound, which we have heard more than once in the stillness of the night in tropical South America; and we are informed that the same phenomenon occurs on the Ganges, and on the west coast of Africa. The gullet of the crocodile is very wide, the tongue being completely tied to the lower jaw; and beneath it are glands exuding a musky substance. On land the crocodile, next to the gavia, is the most active, and in the water it is also the species that most readily frequents the open sea. Of the immense number of genera which we have seen or examined, none reached to 25 feet in length, and we believe the specimen in the vaults of the British Museum to be one of the largest. Sheep are observed to be unmolested by these animals; but where they abound, no pigs can be kept, perhaps from their frequenting the muddy shores; for we have known only one instance of crocodiles being encountered in woods not immediately close to the water's side: usually they bask on sandy islands. As their teeth are long, but not fitted for cutting, they seize their prey, which they cannot masticate, and swallow it nearly entire, or bury it beneath the waves to macerate. Having very small excretory organs, their digestion requires, and accordingly they are found to possess, an immense biliary apparatus. They are oviparous, burying the eggs in their sand; and the female remains in the vicinity to dig them out on the day the young have broken the shell. What is said in ancient history of the ear-rings fastened to crocodiles must be understood of ornaments fixed to follicles of the skin; the Sudara-oron, or man-crocodile of the Malays, and the sacred otter of the ancient Irish, are described with similar ornaments. Crocodiles are caught with hooks, and they seldom succeed in cutting the rope when properly prepared. Though a ball fired point blank will penetrate between the scales which cover the body, the invulnerability of these great Saurians is sufficiently exemplified by the following occurrence. One being brought well bound to the bazaar at Cawnpore on the Ganges, it was purchased by the British officers on the spot, and carried farther inland, for the purpose of being baited. Accordingly, the ligatures, excepting those which secured the muzzle, being cut asunder, the monster, though it had been many hours exposed to the heat, and was almost suffocated with dust, fought its way through an immense crowd of assailants, soldiers and natives, armed with staves, lances, swords, and stones, and worried by numerous terriers, hounds, and curs; overturning all in its way, till, scenting the river, it escaped to the water at a distance of two miles, in spite of the most strenuous opposition!

According to Strabo, the crocodiles of Egypt were known by the name of Suchus (*Σούχος*), from an Egyptian word supposed to have been Souch or Soucha, perhaps applied solely to the sacred animals of the species. Spanheim, in his remarks on the life of Isidorus by Damascius, thinks that *Σούχος* may be referred to the monitor lizard known by the name of Waran; and it is not improbable that the same laxity in the appli-

cation of proper names which is traceable in the Oriental languages, and in the Greek, where the original meaning of *κροκόδειλος*, in the Ionic, is 'lizard,' and even in modern tongues, has allowed the word to be vaguely employed to denote Saurians. Herodotus says that the Egyptians called crocodiles *Χάμψαι*, which, according to Sir J. G. Wilkinson, is a corruption of *Mseh*, or *Emsooh*. The Arabic retains *Temsah*, and a similar name, *Temsche* or *Temesche*, was anciently applied on the Danube and the Scheldt to the sturgeon. Kimsak is the Turkish; Kimbuta the Ceylonese; but the Leng of the Malays, still venerated by them, is of the gavia subdivision of the genus: it is the horned crocodile, or Makaira of Budha lore; it figures in the zodiac of the utmost east, and there becomes confounded with the dragon—an emblem assumed by all the nations of Mongolic origin. During the Roman sway in Egypt, crocodiles had not disappeared in the lower Nile, for Seneca and others allude to a great battle fought by them and a shoal of dolphins in the Heracleotic branch of the Delta. During the decline of the state even the hippopotamus re-appeared about Pelusium, and was shot at in the seventeenth century (Radzivil). In the time of the Crusades crocodiles were found in the Crocodilon river of early writers, and in the Crocodilorum lacus, still called Moiat al Temsah, which appear to be the Kerseos river and marsh, three miles south of Casarea, though the nature of the locality is most appropriate at Nahr-el-Arsoof or el-Haddar.

The exploit of Dieudonné de Bozon, knight of St. John, who, when a young man, slew the dragon of Rhodes, must be regarded as a combat with a crocodile, which had probably been carried northward by the regular current of the eastern Mediterranean; for so the picture still extant in the harem of a Turkish inhabitant represents the Hawan Kebir or Great Beast—a picture necessarily painted anterior to the expulsion of the knights in 1480. As De Bozon died Grand Master of the Order at Rhodes in 1353, and the spoils of the animal long remained hung up in a church, there is not, we think, any reason to doubt the fact, though most of the recorded circumstances may be fabulous.*

That crocodiles and alligators take the sea, and are found on islands many leagues distant from other land, we have ourselves witnessed; and the fact is particularly notorious at the Grand Caymanas in the sea of Mexico, which is almost destitute of fresh water. It is indeed owing to this circumstance that the same species may frequent all the rivers of a great extent of coast, as is the case with some found in Africa, whence they spread to India and the Malayan islands. We have been thus explicit on the natural history of these formidable Saurians, in order that we may have less occasion to notice the mis-statements of the ancients when we shall have to

* Other paintings by the same artist, said to have been Sebast. de Firenze, pupil of Cimabue, show that he did not represent grand masters later than Gio de Lartin, who was elected 1437, and died 1454. All the ancient Greek and the later Mediterranean dragons, as those of Naples, Arles, &c., where they are not allegorical, are no doubt derived from crocodiles.

comment on the Hebrew words which are assumed to indicate them. We omit for the present all particulars respecting the crocodile divinities, their worship and preservation in the mummy state, which Sir J. G. Wilkinson's interesting works have lately made known to all readers.—

C. H. S.

CROSS. This word is derived from the Latin *crux*. Respecting the origin of its Greek representative there is some diversity of opinion. According to Eustathius and Hesychius, the Greek *σταυρός* is so called *παρὰ τὴν εἰς ἄρα στάσειν, ἢ παρὰ τὸ εἰς εὐρος ἵστασθαι*, from its standing erect, or from its standing with its arms horizontal. Latin etymologists also derive the word from *ἵστημι*, to place. In its general acceptation the cross is an instrument of punishment, and, metaphorically, punishment itself, as well as the pain which it inflicts, and generally any severe suffering or heavy trial. Instead of *σταυρός* the Greek word *σκόλοψ* is sometimes found as equivalent to the Latin *crux*. Both are in frequent use on the part of the writers who transferred the events of Roman history into the Greek tongue.

In its simplest form, consisting of two pieces of wood, one standing erect, the other *crossing* it at right angles, the cross was known at an early age in the history of the world. Its use as an instrument of punishment was probably suggested by the shape so often taken by branches of trees, which seem to have been the first crosses that were employed. It was certainly customary to hang criminals on trees—*arbor infelix*; Cicero (*Pro Rabir.* 3) appears to consider hanging on a tree and crucifixion as of the same import, and Seneca (*Ep.* 101) names the cross *infelix lignum*, which may with no undue liberty be rendered 'the accursed tree.' Trees are known to have been used as crosses (Tertull. *Ap.* viii. 16), and to every kind of hanging which bore a resemblance to crucifixion, such as that of Prometheus, Andromeda, &c., the name was commonly applied. Among the Scythians, Persians, Carthaginians, Greeks, Romans, and the ancient Germans, traces are found of the cross as an instrument of punishment. The sign of the cross is found as a holy symbol among several ancient nations, who may accordingly be named, in the language of Tertullian, *crucis religiosos, devotees of the cross*. Among the Indians and Egyptians the cross often appears in their ceremonies, sometimes in the shape of the letter T, at others in this shape \perp . At Susa, Ker Porter saw a stone cut with hieroglyphics and cuneiform inscriptions, on which in one corner was a figure of a cross, thus \perp . The cross, he says, is generally understood to be symbolical of the divinity or eternal life, and certainly a cross was to be seen in the temple of Serapis as the Egyptian emblem of the future life, as may be learnt in Sozomen and Rufinus. Porter also states that the Egyptian priests urged its being found on the walls of their temple of Serapis, as an argument with the victorious army of Theodosius to save it from destruction. From the numerous writings on this subject by La Croze, Jablonski, Zoega, Visconti, Pococke, Pluche, Petit Radel, and others, the symbol of the cross appears to have been most various in its significations. Sometimes it is the Phallus, sometimes the planet Venus, or the *Nümmeter*, or an emblem of the four elements, or

the seasons (Creuzer's *Symbolik*, pp. 168-5). It is not therefore surprising that ancient and even modern Christian writers should on this subject have indulged in some degree of refinement and mysticism. Justin Martyr (*Apol.* i. § 72) says. 'The sign of the cross is impressed upon the whole of nature. There is hardly a handicraftsman but uses the figure of it among the implements of his industry. It forms a part of man himself, as may be seen when he raises his hands in prayer.' In like manner Minutius Felix (c. 29): 'Even nature itself seems to have formed this figure for us. We have a natural cross on every ship whose sails are spread, in every yoke that man forms, in every outspreading of his arms in prayer. Thus is the cross found both in the arrangements of nature, and among the heathen.'

According to Lipsius (*De Cruce*, i. 5-9) and Gretser (*De Cruce Christi*, vol. i. c. 1) there were in general two kinds of crosses;—1, *crux simplex*; 2, *crux composita* or *compacta*. The first consisted of a stake on which the criminal was fastened or by which he was impaled. For the first kind of punishment a tree or a specially prepared stake was used, on which the criminal was bound, and either left to perish, or immediately put to death. For *impaling* (*infixio*) a long and sharpened piece of wood (*pale*) was employed, on which the criminal was put as on a spit. Seneca describes this kind of execution (*Consolat. ad Marc.* c. 20): 'I behold these crosses, not of one kind, but made differently by different people. Some suspended the criminal with his head turned towards the earth; others drove a stake through his body.' This cruel mode of execution was formerly very customary in Russia, China, Turkey, and other countries, and is not yet universally abolished by law.

Of the *crux composita* or compound cross there were three sorts: 1, *crux decussata*; 2, *crux commissa*; 3, *crux immissa*. The *crux decussata* is also called Andrew's cross, because tradition reports that on a cross of this kind the Apostle Andrew suffered death. Jerome (*Comment. on Jerem.* c. 31) describes this cross in the following terms:—*Decussare est per medium secare velut si dæ regulæ concurrant ad speciem literæ X quæ figura est crucis*: saying in effect that the name indicates two lines cutting each other after the manner of the letter X. So Isidorus Hisp. (*Orig.* 1. 1. 3) says that the letter X denotes a cross and the number ten (in Roman numerals).

The *crux commissa*, Lipsius states, was formed by putting a cross piece of wood on a perpendicular one, so that no part of the latter may stand above the former. This form is found in the figure \perp . Of the *crux immissa*, or, as others prefer to term it, *crux capitata*, the following is given as the description:—'a cross in which the longer piece of wood or pale stands above the shorter piece which runs across it near the top.' It is distinguished from the preceding by the part of the longer beam which is above the shorter or transverse, th is \perp . This form is found in paintings more frequently than any other, and on a cross of this kind our Saviour is believed to have suffered death.

Of the nature of the cross on which Jesus was crucified, and of every particular connected with

it, exact information ought to be accessible, since four ecclesiastical historians (Socrates, i. 13, Sozomen, ii. 1, Rufinus, i. 7, Theodoret, i. 18) concur in stating that it was found by the Empress Helena, mother of Constantine the Great. This event is assigned to the year of our Lord 326. Eusebius alone is silent on the discovery. The other writers state that Helena, when seventy-nine years of age, was induced by the warmth of her piety to visit the places which the Saviour had rendered sacred by his presence and sufferings. The hatred of the heathen had led them to obliterate as much as possible all traces of the memorable events which the life and death of Jesus had hallowed; and to cover Mount Calvary with stones and earth and raise thereon a temple to the goddess Venus. A Jew, however, had treasured up what traditions he could gather, and was thus enabled to point out to Helena the spot where our Lord had been buried. The place being excavated three crosses were found, and the title which that of Jesus bore was also found lying apart by itself. The question arose how the cross of Christ was to be distinguished from the other two. Macarius, bishop of Jerusalem, suggested that their respective efficacy should be tried as to the working of miracles. Sick persons were brought forward and touched by each separately. One only wrought the desired cures, and was accordingly acknowledged to be the true cross. A full view of all the authorities on this matter may be seen in Tillemont (*Mem. Eccles.* chapter on Helena).

Having built a church over the sacred spot, Helena deposited within it the chief part of the real cross. The remainder she conveyed to Constantinople, a part of which Constantine inserted in the head of a statue of himself, and the other part was sent to Rome, and placed in the church of Sta. Croce in Gerusalemme, which was built expressly to receive the precious relic. When subsequently a festival to commemorate the discovery had been established, the Bishop of Jerusalem, on Easter Sunday, exhibited to the grateful eyes of eager pilgrims the object to see which they had travelled so far, and endured so much. Those who were persons of substance were further gratified by obtaining, at their full price, small pieces of the cross set in gold and gems; and that wonder might not pass into incredulity, the proper authorities gave the world an assurance that the holy wood possessed the power of self-multiplication, and, notwithstanding the innumerable pieces which had been taken from it for the pleasure and service of the faithful, remained intact and entire as at the first—*ut detrimenda non sentiret, et quasi intacta permaneret.* (Paulinus, *Ep. xi. ad Sev.*)

The capture of Jerusalem by the Persians, A.D. 614, placed the remains of the cross in the hands of Chosroes II., who mockingly conveyed them to his capital. Fourteen years afterwards, Heraclius recovered them, and had them carried first to Constantinople, and then to Jerusalem, in such pomp, that on his arrival before the latter city, he found the gate barred, and entrance forbidden. Instructed as to the cause of this hindrance, the Emperor laid aside the trappings of his greatness, and, barefooted, bore on his own shoulders the sacred relic up to the gate, which then opened of itself, and allowed him to enter,

and thus place his charge beneath the dome of the sepulchre.

From this time no more is heard of the true cross, which may have been destroyed by the Saracens on their conquest of Jerusalem, A.D. 637. The wooden title, however, is said to be still preserved in Rome, not entire, indeed, for only diminutive fragments remain of the Hebrew letters, so that no one can say what in reality the characters are. The Greek and Latin, excepting the letter Z, are both written after the Eastern manner, from right to left. This is said to have happened either because they were written by a Jew, following a national custom, or from a desire on the part of the writer, if a Roman, to accommodate himself to what was usual among the Jews. Nicetus (*Titulus Sanct. Crucis*) holds that it is not all the work of one hand, since the Roman letters are firmly and distinctly cut, but the Greek letters, very badly. He thinks that a Jew cut the Hebrew (or Aramæan) and Greek, and a Roman the Latin. All that remains of the Greek is ΝΑΖΑΡΕΟΥΣ Β , of the Latin, Nazarenus. It is somewhat extraordinary that there should appear in the sole Greek word, what some have thought two mistakes, namely, ϵ for η , a short for a long e ; and the termination *ous* for *os*. The history of the discovery of this title

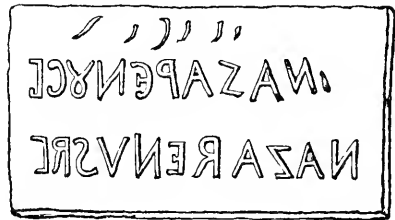

239.

is worthy of a brief notice. When sent by Constantine to Rome, it was deposited in a leaden chest, above the vaulted roof of the Church Sta. Croce, in a little window, and then bricked into the wall; its position being recorded in a Mosaic inscription without. Time rendered the inscription almost illegible; and the window, owing to the carelessness of workmen engaged in repairing the church, was accidentally broken open, when the holy relic was discovered. This discovery and the genuineness of the title, Alexander III. authenticated by a bull. The letters found on the title, if taken according to their numerical value, make 1532, a circumstance which led Stifelius to fix that as the year for the termination of the world.

Jortin has, in his own manner (*Remarks*, vol. iii.), discussed the evidence which bears on the discovery and genuineness of the cross, to which discussion those who desire satisfaction may refer. One or two remarks seem required in this place. None of the authorities give a close description of the three crosses said to have been found in the rubbish under the temple of Venus, which is the less surprising, since they were not eye-witnesses. The three crosses, it appears, were very much alike, and nothing short of miracles could distinguish and mark that of the Saviour (σωτηριον ξυλον). That the crosses were of wood, all declare, but no one states the peculiar kind of wood; nor is any

mention found in the four historians of the tradition, which may be traced back to the days of Chrysostom, that the true cross consisted of three kinds, cypress, pine, and cedar, or of four kinds, cedar, cypress, palm, and olive.

Quatuor ex lignis Domini crux dicitur esse; — Pes crucis est cedrus; corpus tenet alta cupressus; Palma manus retinet; titulo latetur oliva.

Lipsius (*De Cruce*) supposes that the cross was made of oak, since it is likely it would be constructed of such wood as was most abundant, and therefore probably nearest at hand, and oak grew plentifully in Judæa: the relics too are said to resemble oak.

According to Ambrosius (*Oratio de Obitu Theodor.* p. 498), the piece which bore the title stood on the top of the cross of our Lord (John xix. 19-22, ἐπὶ τοῦ σταυροῦ; comp. Matt. xxvii. 37; Mark xv. 26; Luke xviii. 18): the form then would be somewhat thus ☩. This fact

would lead to the expectation of more accurate information from those who are said to have found the cross. The language of the scriptural writers seems to imply that it was only on the cross of Jesus that a title was placed; and it does not therefore appear to be a case in which human sagacity could have been so wholly at a loss as the accounts imply; yet Rufinus says, *Hic jam humanæ ambiguitatis incertum, divinum flagitat testimonium.* Probably a divine testimony was required by other considerations than such as arose from the essential ambiguity of the case. But the conduct of Helena in dividing the cross, setting aside one part for Jerusalem, another for Constantinople, and another as a phylacterion for her son, and the subdivisions thereof, which subsequently took place, rendered it impossible to ascertain in any satisfactory manner, not only whether the alleged was the real cross, but also of what wood and in what shape it had been made.

This only then as to the shape of the Saviour's cross can be determined, that the prevalent form was that of the *crux capitata*, and that this form is generally found on coins and in the so-called monogram (Munter's *Simbilder*, I. iv).

Much time and trouble have been wasted in disputing as to whether three or four nails were used in fastening the Lord to his cross. Nonnus affirms that three only were used, in which he is followed by Gregory Nazianzen. The more general belief gives four nails, an opinion which is supported at much length and by curious arguments by Curtius, an Augustine friar, who wrote a treatise *De Clavis Dominicis*, in the beginning of the seventeenth century. Others have carried the number of nails so high as fourteen. Of the four original nails, the Empress Helena is reported to have thrown one into the Adriatic, when furiously raging, thereby producing an instant calm. The second is said to have been put by Constantine into either his helmet or crown. This nail, however, was afterwards to be found in a mutilated state in the church of Sta. Croce. In the Duomo of Milan is a third nail, which Eutropius affirms was driven through one of Jesus' hands, and which Constantine used as a bit, intending thereby to verify the prophecy of Zechariah (xiv. 20): 'In that day shall be upon the bells (margin, *bridles*) of the horses, *Holiness unto the Lord.*' Treves possesses the fourth nail,

which is alleged to have been driven through the sufferer's right foot. Those who maintain the number of nails to have been more than four have had no difficulty in finding as many nails as their hypothesis in each case needed, and as many sacred places for their safe keeping.

Another dispute has been agitated relative to the existence of a *hypopodium* or tablet whereon the feet were supported. Gregory of Tours, who had seen the alleged true cross, affirms that it had such a footstool; but his dictum has been called in question. It is, however, doubted whether the hands alone, without a prop beneath, could sustain the weight of the body, and some have supposed that a kind of seat was placed, on which the sufferer may be said to have in some way sat. The controversy is treated at length in the first of the four *Hypomnemata de Cruce* of Bartholinus. J. R. B.

CROW. [RAVEN.]

CROWNS are often mentioned in Scripture, and in such a manner as in most cases to indicate the circumstances under which, and the persons by whom, they were worn; for crowns were less exclusively worn by sovereigns than among modern nations. Perhaps it would be better to say that the term 'crowns' was applied to other ornaments for the head than those exclusively worn by royal personages, and to which modern usage would give such distinctive names as coronet, band, mitre, tiara, garland, &c.

The royal crown originated in the diadem, which was a simple fillet fastened round the head, and tied behind. This obviously took its rise among a people who wore long hair, and used a band to prevent it from falling over the face. The idea occurred of distinguishing kings by a fillet of different colour from that usually worn; and being thus established as a regal distinction, it continued to be used as such even among nations who did not wear the hair long, or was employed to confine the head-dress. We sometimes see

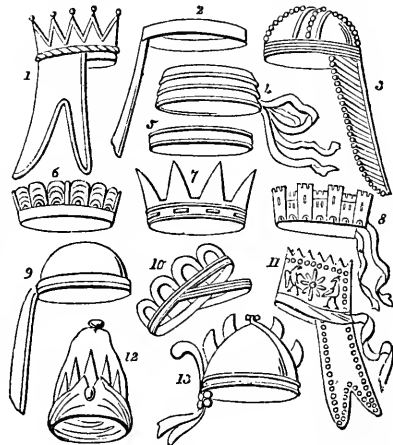

240. [Ancient Asiatic Crowns.]

this diadem as a simple fillet, about two inches broad, fastened round the otherwise bare head; we then find it as a band of gold (No. 240, figs. 2, 5). In this shape it sometimes forms

the basis of raised ornamental work (figs. 6, 7, 8, 10), in which case it becomes what we should consider a crown; and indeed the original diadem may be traced in most ancient crowns. Fig. 10 is curious, not only from the simplicity of its form, but on account of the metallic loop to be passed under the chin—a mode of securing the crown probably adopted in war or in the chase. Then we find the diadem surrounding the head-dress or cap (figs. 3, 9, 13), and when this also is ornamented, the diadem may be considered as having become a crown. The word *נֶזֶר* *nezzer* is supposed to denote a diadem. It is applied to the inscribed plate of gold in front of the high-priest's mitre, which was tied behind by a ribbon (Exod. xxix. 6; xxxix. 30), and which was doubtless something of the same kind that we see in figs. 8, 11. This word is also employed to denote the diadem which Saul wore in battle, and which was brought to David (2 Sam. i. 10), and also that which was used at the coronation of the young Joash (2 Kings xi. 12); and, as another word is applied elsewhere to the crown used in this ceremonial, the probability is that the Hebrew kings wore sometimes a diadem and sometimes a crown, and that the diadem only was accessible to the high-priest, by whom Joash was crowned, the crown itself being most likely in the possession of Athaliah. As Psalm lxxxix. was certainly composed by David, the regal use of the diadem is further indicated in verse 39.

The more general word for a crown is *עֹרֶה* *atarah*; and it is applied to crowns and head ornaments of different sorts, including those used by the kings. When applied to their crowns, it appears to denote the state crown as distinguished from the diadem. This, the Rabbins allege, was of gold set with jewels; such was the crown which David took from the king of the Amorites (2 Sam. xii. 30), and afterwards wore himself, as did probably his successors. Of its shape it is impossible to form any notion, unless by reference to the examples of ancient crowns contained in the preceding cut. These figures, however, being taken mostly from coins, are not of that very remote antiquity which we should desire to illustrate matters pertaining to the period of the Hebrew monarchies. In Egypt and Persia there are sculptures of earlier date, representing royal crowns in the shape of a distinguishing tiara, cap, or helmet, of metal, and of

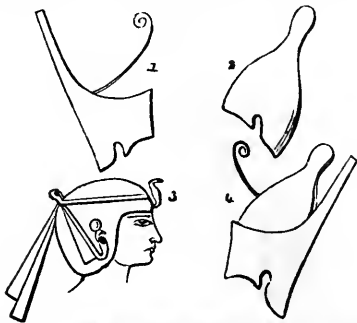

241. [Ancient Egyptian Crowns.]

cloth, or partly cloth and partly metal. Such are the Egyptian crowns as represented in the

above engraving (No. 241). Fig. 1 is the crown of Lower, and fig. 2 that of Upper Egypt; and when both kingdoms were under one sovereign, the two crowns were united, as in fig. 3. Such union of the crowns of different countries upon one head is matter of historical record. Thus when Ptolemy Philometer entered Antioch as a conqueror, he placed on his head the crowns of Egypt and of Asia. This would, in fact, form three crowns, as his previous one was doubtless the double crown of Upper and Lower Egypt. The diadem of two or three fillets (figs. 3, 4, No. 240) may have been similarly significant of dominion over two or three countries. There are allusions to this custom in Scripture (Rev. xii. 3; xix. 12). These Egyptian tiaras were worn in war, and on occasions of state; but on ordinary occasions a fillet or diadem was used, affording corroboration of a previous remark.

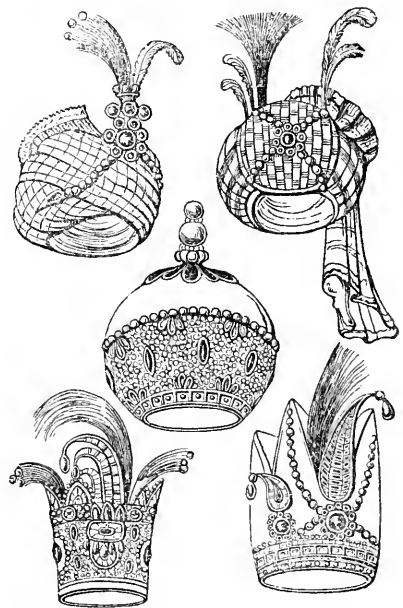

242. [Modern Asiatic Crowns.]

It is important to observe that the mitre of the high-priest, which is also called a crown (Exod. xxxix. 30) was of similar construction, if not shape, with the addition of the golden fillet or diadem. Similar also in construction and material, though not in form, was the ancient Persian crown, for which there is a distinct name in the book of Esther (i. 2; ii. 17; vi. 8), viz. *כֶּתֶר* *ceter*, which was doubtless the *cidaris* or *citaris* (*κιδάρις* or *κίταρις*), the high cap or tiara, so often mentioned by the Greek historians. From the descriptions given of it, this seems to have been a somewhat conical cap, surrounded by a wreath or fold; and this would suggest a resemblance to fig. 12, No. 240; which is in fact copied from a Parthian or later Persian coin. This one is worthy of very particular attention, because it forms a connecting link between the ancient and modern Oriental crowns, the latter consisting either of a cap, with a fold or turban, variously enriched with aigrettes, as

this is; or of a stiff cap of cloth, studded with precious stones. It must often occur to the student of Biblical antiquities that the modern usages of the East have more resemblance to the most ancient, than have those which prevailed during that intermediate or classical period in which its peculiar manners and institutions were subject to much extraneous influence from the domination of the Greeks and Romans. So, in the present instance, we are much impressed with the conviction that such head ties and caps as those represented in Nos. 241 and 242, more correctly represent the regal 'crowns' of the Old Testament, than those figured in No. 240 (with the exception of fig. 12, and the simple diadems); which however may be taken to represent the style of the crowns which prevailed in and before the time of the New Testament.

Crowns were so often used symbolically to express honour and power, that it is not always safe to infer national usages from the passages in which they occur. Hence we would scarcely conclude from Ezek. xxiii. 42, that crowns were worn by Jewish females, although that they wore some ornament which might be so called is probable from other sources. Mr. Lane (*Arabian Nights*, i. 424) mentions that until about two centuries ago a kind of crown was worn by Arabian females of wealth and distinction. It was generally a circle of jewelled gold (the lower edge of which was straight, and the upper fancifully heightened to a mere point), surmounting the lower part of a dome-shaped cap, with a jewel or some other ornament at the summit.

It is certain that 'crowns' of this or some similar kind were worn at marriages (Cant. iii. 11; Isa. lxi. 10); and it would appear that at feasts and public festivals 'crowns of rejoicing' were customary. These were probably garlands (Wisd. ii. 8; iv. 2; Eccles. i. 11). The 'crowns' or garlands which were given to the victors in the public games are more than once alluded to in the Epistles (1 Cor. ix. 25; 2 Tim. ii. 5; iv. 8; 1 Pet. v. 4).

CROWN OF THORNS [ΤΗΡΑΝΣ].

CRUCIFIXION—in Greek ἀποσταυρῶν; in Latin *cruci affigere, in crucem agere or tollere*, in later times *cruci figere*, whence our crucifixion. To describe this punishment the Jews used the general term חַוְוָה, for crucifixion is a kind of hanging; whence Christ in the polemical writings of the Jews is designated חַוְוָה, 'the hanged one.' Crucifixion was a most cruel and disgraceful punishment; the terms applied to it by ancient writers are, 'the most cruel and disgraceful' (Cic. *Verr.*; Lactan. *Instit.* iv. 26); 'the worst possible punishment' (Ulpian); 'the worst punishment in the world' (Paul. v. 17). It was the punishment chiefly of slaves; accordingly the word *furcifer*, 'cross-bearer,' was a term of reproach for slaves, and the punishment is termed *servile supplicium*, 'a slave's punishment' (*De Infami quo Chr. adfectus est crv. supp.*, in C. H. Lange's *Observatt. Sacr.*). Free-born persons also suffered crucifixion, but only *humiles*, those of low condition and provincials. Citizens could not be crucified (Cic. *Verr.* i. 5; Quintil. viii. 4; Suet. *Galb.*). This punishment was reserved for the greatest crimes, as robbery, piracy (Sen. *Epp.* vii. Cic. *Petron.* 71); assassination, perjury (Firmic.

vi. 26); sedition, treason, and (in the case of soldiers) desertion (Dion, v. 52; Joseph. *Antiq.* xiii. 22; Apul. *Asin.* 3). Its origin is ancient. In Thucydides (i. 110) we read of Inarus, an African king, who was crucified by the Egyptians. The similar fate of Polycrates, who suffered under the Persians, is detailed by Herodotus (iii. 125), who adds, in the same book (159), that no less than 300 persons were condemned to the cross by Darius, after his successful siege of Babylon. Valerius Maximus makes crucifixion the common military punishment of the Carthaginians. That the Greeks adopted it is plain from the cruel executions which Alexander ordered after the capture of Tyre, when 2000 captives were nailed to crosses along the sea-shore (Q. Curtius, iv. 4; Justin, xviii. 3). With the Romans it was used under their early monarchical government, and was the death to which Horatius was adjudged for the stern and savage murder of his sister (Liv. i. 26), where the terms employed show that the punishment was not at that time limited to any rank or condition. It appears also from the passage that scourging (*verberato*) then preceded crucifixion, as undoubtedly was customary in later times. The column to which Jesus was fastened during this cruel infliction is stated by Jerome (*Epist. ad Eustach.*) to have existed in his time in the portico of the holy sepulchre, and to have retained marks of his blood. The Jews received the punishment of crucifixion from the Romans (Joseph. *Antiq.* xii. 14, 2; xx. 6. 2; *De Bell. Jud.* i. 12). Though it has been a matter of debate, yet it appears clear that crucifixion, properly so called, was not originally a Hebrew punishment (Bornitz *de cruce num Ebræor. supp. fuerit*). The condemned, after having been scourged (Liv. xxxvi. 26; Prud. *Enchir.* xli. 1), had to bear their cross, or at least the transverse beam, to the place of execution (Plut. *De Tard. Dei Vind.* 9; Artemid. 11, 41), which was generally in some frequented place without the city (Cic. *Verr.* v. 66). The cross itself, or the upright beam, was fixed in the ground (Cic. *ad Quint. Fr.* i. 2; *Pro Rat.* iv. 2). Arrived at the spot the delinquent was supplied with an intoxicating drink, made of myrrh and other bitter herbs (Pipping, *Exercit. Acad.* lv.), and having been stripped of his clothing, was raised and affixed to the cross, by nails driven into his hands, and more rarely into his feet; sometimes the feet were fastened by one nail driven through both (Tertull. *Adv. Jud.* x.; Sen. *De Vita Beat.* 19; Lactan. iv. 13). The feet were occasionally bound to the cross by cords, and Xenophon asserts that it was usual among the Egyptians to bind in this manner not only the feet but the hands. A small tablet (*titulus*), declaring the crime, was placed on the top of the cross (Sueton. *Cal.* 38; *Dom.* 10; Euseb. *Hist. Eccles.* v. 1). The body of the crucified person rested on a sort of seat (πίγμα) (Iren. *Adv. Her.* ii. 42). The criminal died under the most frightful sufferings—so great that even amid the raging passions of war pity was sometimes excited. Josephus (*De Bell. Jud.* v. xi. 1) narrates of captives taken at the siege of Jerusalem, that 'they were first whipped, and tormented with all sorts of tortures, and then crucified before the walls of the city. The soldiers, out of the wrath and hatred they bore the Jews, nailed those they caught one after one way and another after another to crosses, hav'

way of jest, when their multitude was so great that room was wanting for the crosses, and crosses wanting for the bodies. This miserable procedure made Titus greatly pity them.' Sometimes the suffering was shortened and abated by breaking the legs of the criminal—*crura fracta* (Cic. *Phil.* xiii. 12). After death, among the heathens, the bodies commonly remained on the cross till they wasted away, or were devoured by birds of prey (Horat. *Epist.* i. 16, 48; *Non pasces in cruce corvos*; Plaut. *Mil. Glor.* ii. 4, 19; Plin. *Hist. Nat.* xxxvi. 24). A military guard was set near the cross, to prevent the corpse from being taken away for burial (Plut. *Cleomen.* 39; Petron. *Satyr.* iii. 6; Sen. *Ep.* 101). But among the Jews the dead body was customarily taken down and buried. Josephus says (*De Bell. Jud.* v. 2), 'the Jews used to take so much care of the burial of men that they took down those that were condemned and crucified, and buried them before the going down of the sun.' In order that death might be hastened, and the law might not be violated, the Jews were accustomed to break the legs (John xix. 21; Dent. xxi. 22; Casaub. *Exerc. Antibarbar.* p. 537; Lipsius, *De Cruc.* lib. iii.). There was a bare possibility in some cases of those who had suffered this punishment recovering after being taken down, under medical treatment. Josephus thus writes (*Vit.* 75), 'I saw many captives crucified, and I remembered three of them as my former acquaintance. I was very sorry at this, and went with tears in my eyes to Titus; so he immediately commanded them to be taken down, and to receive the greatest care in order to their recovery; yet two of them died under the physician's hands, while the third recovered.' Compare Bretschneider, in *d. Studien u. Krit.*, 1832, vol. ii. p. 625. The execution took place at the hands of the *caruifex*, or hangman, attended by a band of soldiers, and in Rome, under the supervision of the *Triumviri Capiteles* (Tac. *Ann.* xv. 60; Lactan. *iv.* 26). The accounts given in the Gospels of the execution of Jesus Christ are in entire agreement with the customs and practices of the Romans in this particular (Tholuck, *Glaubwürdigkeit der Evangel. Gesch.* p. 361). The punishment continued in the Roman empire till the time of Constantine, when it was abolished through the influence of the Christian religion. Examples of it are found in the early part of the emperor's reign, but the reverence which, at a later period, he was led to feel for the cross, induced him to put an end to the inhuman practice. (Aur. *Vict. Cæs.* 41; Sozom. i. 8; Niceph. vii. 46; Firmic. viii. 20). There is a classical work on the subject by Lipsius, Antwerp, 1594 and 1637. Other valuable works, besides those which have been named in this and the article *Cross*, are by Vossius, Gretser, Calixtus, Salmasius, and Kipping. Sagittarius, Binæus, Dilber, &c. have treated specially on the application of this punishment in the case of our Lord. The more ancient literature on the subject is detailed in Fabric. *Bibliogr. Antiquar.* Hamb. 1760, p. 755, §19.—J. R. B.

CRUCIFIXION, DEATH BY (physically considered), is to be attributed to the sympathetic fever which is excited by the wounds, and aggravated by exposure to the weather, privation of water, and the painfully constrained position of the body. Traumatic fever corresponds, in in-

tensity and in character, to the local inflammation of the wound. In the first stage, while the inflammation of the wound is characterized by heat, swelling, and great pain, the fever is highly inflammatory; and the sufferer complains of heat, throbbing headache, intense thirst, restlessness, and anxiety. As soon as suppuration sets in, the fever somewhat abates, and gradually ceases as suppuration diminishes and the stage of cicatrization approaches. But if the wound be prevented from healing, and suppuration continue, the fever assumes a hectic character, and will sooner or later exhaust the powers of life. When, however, the inflammation of the wound is so intense as to produce mortification, nervous depression is the immediate consequence; and if the cause of this excessive inflammation of the wound still continues, as is the case in crucifixion, the sufferer rapidly sinks. He is no longer sensible of pain, but his anxiety and sense of prostration are excessive; hiccup supervenes, his skin is moistened with a cold clammy sweat, and death ensues. It is in this manner that death on the cross must have taken place, in an ordinarily healthy constitution. The wounds in themselves were not fatal; but, as long as the nails remained in them, the inflammation must have increased in intensity until it produced gangrene. De la Condamine witnessed the crucifixion of two women of those fanatic Jansenists called *Convulsionnaires*. One of them, who had been crucified thrice before, remained on the cross for three hours. They suffered most pain from the operation of extracting the nails; and it was not until then that they lost more than a few drops of blood from their wounds. After they were taken down, they seemed to suffer little, and speedily recovered (*Correspond. de Grimm et Diderot*, ii. 75). The probabilities of recovery after crucifixion would of course depend on the degree of constitutional irritation that had been already excited. Josephus (*Vita*, 71) relates that of three of his friends, for whom he had obtained a release from the cross, only one survived. The period at which death occurred was very variable, as it depended on the constitution of the sufferer, as well as on the degree of exposure, and the state of the weather. It may, however, be asserted that death would not take place until the local inflammation had run its course; and though this process may be much hastened by fatigue and the alternate exposure to the rays of the sun and the cold night air, it is not completed before forty-eight hours, under ordinary circumstances, and in healthy constitutions; so that we may consider thirty-six hours to be the earliest period at which crucifixion would occasion death in a healthy adult. Many of the wounded at Waterloo were brought into the hospitals after having lain three days on the field, and even then sometimes recovered from severe operations. It cannot be objected that the heat of an Eastern climate may not have been duly considered in the above estimate; for many cases are recorded of persons having survived a much longer time than is here mentioned, even as long as eight or nine days. Eusebius (*Hist. Eccles.* iii. 8) says that many of the martyrs in Egypt, who were crucified with their heads downward, perished by hunger. This assertion, however, must not be misunderstood. It was very natural to suppose that hunger was the cause of death, when it

was known that no food had been taken, and when, as must have happened in lingering cases of crucifixion, the body was seen to be emaciated. But it has been shown above that the nails in the hands and feet must inevitably have given rise to such a degree of inflammation as to produce mortification, and ultimately death; and it is equally certain that food would not, under such circumstances, have contributed to support life. Moreover, it may be added that after the first few hours, as soon as fever had been fully excited, the sufferer would lose all desire for food. The want of water was a much more important privation. It must have caused the sufferer inexpressible anguish, and have contributed in no slight degree to hasten death. As-Sujuti, a celebrated Arabic writer, gives an interesting account of a young Turk who was crucified at Damascus A.D. 1247. It is particularly mentioned that his hands and feet were nailed, and even his arms (but not as if it was in any way remarkable). He complained of intense thirst on the first day, and his sufferings were greatly increased by his continually seeing before him the waters of the Baradâ, on the banks of which he was crucified. He survived two days, from the noon of Friday to the noon of Sunday (Kosegarten, *Chrestomathia Arabica*, p. 63, sq.).—W. A. N.

CRUSE. Three Hebrew words are thus translated in the Authorized Version (1 Sam. xxvi. 11; 1 Kings xiv. 3; 2 Kings ii. 20). This now obsolete English word denotes a small vessel for holding water or other liquids. Such are noticed under BOTTLE, DISH, PITCHER.

CRYSTAL (קֶרֶחַ *kerach*, and גַּבִּישׁ *gabish*, both rendered in the Sept. by κρυσταλλος, which also occurs in Rev. xxi. 11). There seems to be no doubt that crystal is intended by the Greek word in Rev. xxi. 11, as indeed the phrase of comparison 'clear as crystal' would seem naturally to suggest. It is not very certain, nor very likely, that the Hebrew word *gabish* (Job xxviii. 18) means crystal; but as the other word so rendered (*kerach*) denotes ice, to which crystal bears so much external resemblance; and as in Ezek. i. 22 it occurs with an application so similar to the κρυσταλλος of Rev. xxi. 11, we may with much confidence take this to be its meaning. Indeed, this is the more apparent when we recollect that crystal was anciently held to be only pure water, congealed by great length of time into ice harder than the common (Diod. Sic. ii. 52; Plin. *Hist. Nat.* xxxvii. 2), and hence the Greek word for it, in its more proper signification, also signifies ice. From this it necessarily followed that crystal could only be produced in the regions of perpetual ice; and this was accordingly the ancient belief; but we now know that it is found in the warmest regions. Theophrastus (54) reckons crystal among the pellucid stones used for engraved seals. In common parlance we apply the term *crystal* (as the ancients apparently did) to a glass-like transparent stone, commonly of a hexagonal form, which, from being found in rocks, is called by mineralogists rock-crystal. It is a stone of the flint family, the most refined kind of quartz.

CUBIT is a word derived immediately from the Latin *cubitus*, the lower arm. The length of the cubit has varied in different nations, and at

different times. Derived as the measure is from a part of the human body, and as the human stature has been of very dissimilar length, the cubit must of necessity have been various. The lower arm, moreover, may take in the entire length from the elbow to the tip of the third or longest finger, or it may be considered as extending from the elbow merely to the root of the hand at the wrist, omitting the whole length of the hand itself. If the definition of Celsus (viii. 1) is taken, and the cubit is identified with the Ulna, the under and longer of the two bones of which the arm consists, still a fixed and invariable measure is not gained. That the cubit (כֶּבֶד) among the Hebrews was derived as a measure from the human body, is clear from Deut. iii. 11—'after the cubit of a man.' But it is difficult to determine whether this cubit was understood as extending to the wrist or the end of the third finger. As however the latter seems most natural, since men, when ignorant of anatomy, and seeking in their own frames standards of measure, were likely to take both the entire foot and the entire fore-arm, the probability is that the longer was the original cubit, namely, the length from the elbow to the extremity of the longest finger. To this opinion Wiener (*Handwörterbuch*, art. 'Elle') inclines, and he denies that they are right who make the cubit merely four hand-breadths. He mentions in corroboration that the Egyptian cubit, which it is likely the Hebrews would adopt, consisting of six hand-breadths, is found on the ruins of Memphis (*Journal des Savans*, 1822, Nov. Dec. comp. Herod. ii. 149). The Rabbins also (*Mishn. Chelim*. xvii. 9) assign six hand-breadths to the Mosaic cubit. By comparing Josephus (*Antiq.* iii. 6. 5) with Exod. xxv. 10, it will, moreover, be found that the weight of his authority is in the same scale. According to him, a cubit is equal to two spans. Now, a span is equal to three hand-breadths (Schmidt, *Bibl. Mathematica*. p. 117; Eisen-Schmidt, *De Ponderibus*, p. 110); a cubit therefore is equal to six hand-breadths.

The hand-breadth (טַפַּח) is found as a measure in 1 Kings vii. 26, comp. Jer. lii. 21. In the latter passage, the finger-breadth (אֶצְבָּע) is another measure. The span (אָרְת) also occurs Exod. xxviii. 16. So that, it appears, measures of length were, for the most part, borrowed by the Hebrews from members of the human body. Still no absolute and invariable standard presents itself. If the question, What is a hand or a finger-breadth? be asked, the answer can be only an approximation to fact. If, however, the palm or hand-breadth is taken at $3\frac{1}{2}$ inches, then the cubit will amount to 21 inches.

In addition to the common cubit, the Egyptians had a longer one of 6 palms 4 inches. The Hebrews also have been thought to have had a longer cubit; for, in Ezek. xl. 5, we read of a cubit which seems to be an ordinary 'cubit and an hand-breadth'; see also Ezek. xliii. 13, where it is expressly said 'the cubit is a cubit and an hand-breadth.' The prophet has been supposed to refer here to the then current Babylonian cubit—a measure which it is thought the Jews borrowed during the period of their captivity. The Rabbins make a distinction between the common cubit of 5 hand-breadths, and the sacred cubit of 6 handbreadths, a distinction which is held to be insufficiently supported both by Wiener (*Hand.* in

voc.) and De Wette (*Archæologie*, p. 178). Consult Lamy, *De Tabernaculo*, c. 8; Carpov, *Apparat.* p. 676. In the New Testament, our Lord characteristically employs the term cubit (Matt. xxvii. 6; Luke xii. 25) for the enforcement of a moral and spiritual lesson. The term also occurs in John xxi. 8, and in Rev. xxi. 17. In Lev. xix. 35, justice in measures, as well as in weights, is strictly enjoined.—J. R. B.

CUCKOW. שַׁחַפִּי *shachaph*, occurs only in Lev. xi. 16, among birds of prey not clearly identified, but declared to be unclean. Our version and others have rendered it 'cuckow,' which, if correct, stands certainly out of the order of all affinity with the other species enumerated; and although the cuckow is a winter and spring bird, distinctly heard, it appears, by Mr. Buckingham, early in April, while crossing the mountains between Damascus and Sidon, at that time covered with snow, it could scarcely deserve to be included in the prohibited list—for the species is every where scarce. *Shachaph* may be an imitation of its voice, since the Arabs call it *Teer-el-Yakoub*, or the bird of Jacob, because in its song it seems to repeat the patriarch's name. Bochart and Dr. A. Clarke derive *Shachaph* from *Sachepeth*, 'a wasting,' and thence apply it to the sea-gull or sea-mew, a bird pretended to be incapable of becoming plump or fleshy. Etymology thus applied cannot fail to lead to error; for the gull tribe, so far from being lean, are usually very fat, but exceedingly oily and redolent of fish.

With regard to Dr. Shaw's proposed identification of *Shachaph* with his *Zaf Zaf* or *Rhaad*, it may be observed that hard-billed species feeding on grain, like all gallinæ, are also very prone to devour reptiles, and therefore are not necessarily clean birds; but, unfortunately, what the *Rhaad* may be is a question which the characters assigned to both the species leave undetermined. The black tuft of feathers beneath the throat, the white belly, and bulk of body, seem to imply that he alluded to two species of smaller Bustards or Pterocles, such as the *Otis Torquata*, *Otis Kuba*, *Otis Hobará*, *Tetrix Campestris*, or the *Katta*, *Pterocles Alchata*, all of which reside in or near Palestine, or make their passage through that country in the proper season (Kitto's *Pictorial Palestine*, i. 406); have a low flight with beating wings, and voices which may have suggested the name *Rhaad*. And as for 'Zaf Zaf,' Hasselquist notices a *Salix*, to which he has given the local name of 'Saf Saf,' proving that the same disyllable by which Shaw designates a bird is likewise applied to a tree of the willow genus, and that perhaps some mistake has been made in referring it to the *Rhaad*.

Upon the whole, while so much obscurity still remains on the subject, the interpretation of *Shachaph* by Cuckow should, we think, remain undisturbed.—C. H. S.

CUMMINS. [KISHUIM.]

CUMMIN (כִּשְׁמִים; N. T. κύμινον), or KAMMON, is an umbelliferous plant, mentioned both in the Old and New Testaments, and which, like the dill and the coriander, continues to be cultivated in modern, as it was in ancient times, in Eastern countries. These are similar to, and used for many of the same purposes as the

anise and caraway, which supply their place, and are more common in Europe. All these plants produce fruits, commonly called seeds, which abound in essential oil of a more or less grateful flavour, and warm stimulating nature; hence they were employed in ancient as in modern times, both as condiments and as medicines. So we find the Cummin mentioned by Hippocrates, and also by Dioscorides, under the name of κύμινον. The latter writer distinguishes several varieties, but the principal is called ἡμερον, or eativum, which the Arabs, following Dioscorides, describe under the name of *kumoon baghee*, a garden that cultivated cummin. The Arabic name

كُمُون *kumon*, is too similar to the Hebrew Kammon to allow us to doubt their identity, especially as we find it, in the Greek form of κύμινον, employed as early as the time of Hippocrates.



243.

Cummin is first mentioned in Isaiah (xxviii. 25): 'When he (the ploughman) hath made plain the face thereof, doth he not cast abroad the fitches, and scatter the cummin;' showing that it was extensively cultivated, as it is in the present day, in Eastern countries, as far even as India. In the south of Europe it is also cultivated to some extent. England is chiefly supplied from Malta and Sicily; 53 cwt. having been imported in the year 1839 from these islands. In the above chapter of Isaiah (ver. 27) cummin is again mentioned: 'For the fitches are not threshed with a threshing instrument, neither is a cart-wheel turned about upon the cummin; but the fitches are beaten out with a staff, and the cummin with a rod.' This is most applicable to the fruit of the common cummin, which, when ripe, may be separated from the stalk with the slightest stroke, and would be completely destroyed by the turning round of a wheel, which, bruising the seed, would press out the oil on which its virtues depend.

In the New Testament, cummin is mentioned in Matt. xxiii. 23, where our Saviour denounces the scribes and Pharisees, who paid their 'tribute of mint, and anise, and cummin,' but neglected the weightier matters of the law. In the Talmudical tract *Demai*, quoted by Celsius (i. p. 519), cummin is mentioned as one of the things regularly tithed: 'Res istæ decimantur dubiæ omni loco

palatha, dactyli, siliquæ, oryza et cuminum.' Notwithstanding the numerous distinct notices of cummin, and its difference from caraway, it is curious how Celsius (*l. c.* p. 516) could have adduced the *carum* of Theophrastus and Dioscorides as identical with the *cuminum*. So in the translation of Rosenmüller (*Bibl. Bot.* p. 99) we have *carum Carvi* given as the systematic name of cuminum, making the latter the caraway plant, which it is not.—J. F. R.

CUSH (כּוּשׁ; *Xoûs*), the eldest son of Ham (Gen. x. 6; 1 Chron. i. 8), from whom seems to have been derived the name of the land of Cush, which is commonly rendered by the Sept., Αἰθιοπία, and by the Vulgate, Æthiopia; in which they have been followed by almost all other versions, ancient and modern. The German translation of Luther has *Mohrenland*, which is equivalent to Negroland, or the Country of the Blacks. A native was called *Cushi*, כּוּשִׁי, Αἰθίοψ, Æthiops (Jer. xiii. 23), the feminine of which was *Cushith*, כּוּשִׁית, Αἰθίοπισσα, Æthiopia (Num. xii. 1), and the plural *Cushiim*, כּוּשִׁימ, Αἰθίοπες, Æthiopes (Amos ix. 7).

The locality of the land of Cush is a question upon which eminent authorities have been divided; for while Bochart (*Phaleg*, iv. 2) maintained that it was exclusively in Arabia, Gesenius (*Lex.* in voce) held with no less pertinacity that it is to be sought for no where but in Africa. In this opinion he is supported by Schulthess of Zurich, in his '*Paradies*' (p. 11, 101). Others again, such as Michaelis (*Spicileg. Geogr. Heb. Est.* cap. 2, p. 237), and Rosenmüller (*Bibl. Geogr.* by Morren, vol. i. p. 80; vol. iii. p. 280), have supposed that the name Cush was applied to tracts of country both in Arabia and Africa—a circumstance which would easily be accounted for, on the very probable supposition, that the descendants of the primitive Cushite tribes, who had settled in the former country, emigrated across the Red Sea to the latter region of the earth, carrying with them the name of Cush, their remote progenitor. This idea had been developed by Eichhorn, in his Dissertation entitled *Verosimilitudo de Cuschæis*, 1774.

The existence of an African Cush cannot reasonably be questioned, though the term is employed in Scripture with great latitude, sometimes denoting an extensive but undefined country (Ethiopia), and at other times one particular kingdom (Meroë). It is expressly described by Ezekiel as lying to the south of Egypt beyond Syene (xxix. 10; comp. xxx. 4-6.—Strabo, xvii. p. 817; Pliny, *Hist. Nat.* vi. 35; Joseph. *De Bell. Jud.* iv. 10, 5). Hence we find Mizraim and Cush (*i. e.* Egypt and Ethiopia) so often classed together by the prophets, *e. g.* Ps. lxxviii. 31; Isa. xi. 11; xx. 4; xliii. 3; xlv. 14; Nahum iii. 9. The inhabitants are elsewhere spoken of in connection with the Lubim and Sukkiim (2 Chron. xii. 3; xvi. 8; Jer. xlvi. 7; Dan. xi. 43), supposed to be the Libyans and Ethiopic Troglodytes, and certainly nations of Africa, for they belonged to the vast army with which Shishak, king of Egypt, 'came out' of that country, against Rehoboam, king of Judah. In these, and indeed in most other passages where 'Cush' occurs, Arabia is not to be thought of; the Ethiopia of Africa is beyond all doubt exclusively intended, and to the article 'ÆTHIOPIA' we refer the reader for the Scriptural notices regarding it.

That some of the posterity of Cush settled in the south of Arabia may readily be granted; but that he gave a permanent name to any portion either of the country or people, is by no means so evident: it is, at least, more a matter of inferential conjecture than of historical certainty. Almost all the passages usually cited in support of the averment are susceptible of a different interpretation. For example, in Num. i. 21, Miriam and Aaron are said to have taken offence at Moses for having married 'a Cushite;' and upon the presumption that this was the same person as Zipporah, daughter of the priest of Midian (Exod. ii. 16, 21), it is inferred that Midian was in Cush. But to say nothing of Zipporah's high rank, or of the services of her family to Israel, there would have been something so grossly incongruous and absurd in Moses' brother and sister complaining for the first time of his selection of a wife, after the marriage had subsisted for more than forty years, that it is evident Zipporah was now dead, and this second wife, though doubtless a proselyte to Judaism, was (whether born in Asia or Africa) a descendant of Cush, and therefore a *Iamite*, and not one of the Midianites, who were of *Shemitic* origin, being the children of Abraham by Keturah. Others discover a supposed connection between Cush and Midian, because in Hab. iii. 7, the clause, 'I saw the tents of Cushan in affliction,' finds a parallelism in 'the curtains of the land of Midian did tremble'—Cushan being held to be the poetical and high-sounding form of Cush. But this idea is merely conjectural; and while it is acknowledged that part of the sublime description in that chapter refers to the Exodus and the transactions at Sinai, other portions (such as the passage of the Jordan, verse 8, and the standing still of the sun, verse 11) have plainly a reference to incidents in the books of Joshua and Judges. Now in the latter book (iii. 10; viii. 12) we find a record of signal victories successively obtained by Othniel over *Cushan* Rishbathaim, king of Mesopotamia, and by Gideon over the princes of *Midian*. Again, it has been rashly concluded that Zerah, the Cushite, who attacked Asa, king of Judah, with so immense a host (2 Chron. xiv. 9), could not have been an Ethiopian of Africa, and yet the fact of his army having included Libyans (xvi. 8) as well as Ethiopians, seems decisive of the fact, that the latter were of African origin. Their ancestors may have belonged to the 'people without number,' whom Shishak had led forth against Asa's grandfather, Rehoboam (xii. 3), and these, their descendants, may have retained possession of the north of Arabia Petræa, between Palestine and Egypt (see Bruce's *Travels*, vol. i. p. 30).

Yet, though there is a great lack of evidence to show that the name of Cush was ever applied to any part of Arabia, there seems no reason to doubt that a portion of the Cushite race did early settle there. According to the ethnographic table in the 10th chapter of Genesis, Cush was the father of Seba, Havilah, Sabta, Raamah (whose sons were Sheba and Dedan), Sabthecah, and also of Nimrod (Gen. x. 7, 8; 1 Chron. i. 9, 10). The last mentioned appears to have moved northward, first into Babelonia, and then into Assyria, but the others seem to have migrated to the south, though it is impossible accurately to trace out their settle-

ments. Yet, even if we give Seba to Africa, and pass over as doubtful the names of Havilah, Sheba, and Dedan (for these were also the names of Semitic tribes, Gen. x. 28, 29; xxv. 3) still, in Ezek. xxvii. 22, Raamah is plainly classed with the tribes of Arabia, and nowhere are any traces of Sabtah and Sabtheba to be found but in the same country. By referring, however, to the relative geographical positions of the south-west coast of Arabia and the east coast of Africa, it will be seen that nothing separates them but the Red Sea, and it is not unlikely that while a part of the Cushite population immigrated to Africa, others remained behind, and were occasionally called by the same name. Thus in 2 Chron. xxi. 16, among those who were stirred up against the Hebrews are mentioned the Philistines, and 'the Arabs that were near, the Cushites,' and the expression 'near' (על יד) in this connection, can scarcely apply to any but dwellers in the Arabian peninsula. In the fifth century of our era the Himyarites, in the south of Arabia, were styled by Syrian writers Cushæans and Ethiopians (Assemani, *Bibl. Orient.* i. 360; iii. 568). The Chaldee Paraphrast Jonathan, at Gen. x. 6, and another paraphrast at 1 Chron. i. 8, explain 'Cush' by Arabia. Niebuhr found in Yemen a tribe called Beni Chusi. The book of Job (xxviii. 19) speaks of the topaz (*pidtah*) of Cush, and there was a Topaz Island in the Red Sea (Diod. Sic. iii. 39; Pliny, *Hist. Nat.* xxxvii. 8; Strabo, xvi. 4. 6). Yet most of these are circumstances upon which we can lay but little stress; and the passage in 2 Chron. xxi. 16 is the only direct evidence we possess of the name 'Cush' being applied in Scripture to any part of Arabia, and even that does not amount to absolute demonstration.

Some have sought for another Cush in more northerly regions of Asia, as in the Persian province of Chusistan or Susiana, in Cuthah, a district of Babylonia, &c.; and as Nimrod, the youngest son of Cush, spread his conquests in that direction, it is, no doubt, possible that his father's name might be preserved in the designation of some part of the territory or people. But here again the data are very unsatisfactory; and, indeed, the chief thing which led to the supposition is the mention in the description of the site of Paradise (Gen. ii. 13), of a land of Cush, compassed by the river Gihon [EDEN]. But even though the name of Cush were more variously applied in Scripture than it really is, it would not be more so than was the corresponding term Ethiopia, among the Greeks and Romans, which comprised a great many nations far distant, as well as wholly distinct from each other, and having nothing in common but their swarthy, sun-burnt complexion—*Αἰθιοψ* *q. d.* *αἰθερὸς τῆς ὄψεως*, *i. e.* 'burnt-black in the face.' Homer (*Odys.* i. 22) speaks of them as 'a divided race—the last of men—some of them at the extreme west, and others at the extreme east.' Strabo (i. p. 60) describes them as a 'two-fold people, lying extended in a long tract from the rising to the setting sun.' Herodotus (vii. 69, 70) distinguishes the eastern Ethiopians in Asia from the western Ethiopians in Africa, by the straight hair of the former, and the curly hair of the latter. The ancients, in short, with the usual looseness of their geographical definitions, understood by Ethiopia

the extreme south in all the earth's longitude and which, lying, as they thought, close upon the fiery zone, exposed the inhabitants to the sun's scorching rays, which burnt them black. It is the mistaken idea of the Scriptural term 'Cush' being used in the same vague and indeterminate manner, that has led to so much confusion on this subject; and one writer (Buttmann, *Allg. Erdk. d. Morgentl.* p. 40 note), in his desire to carry out the parallel between Ethiopia and Cush, derives the latter word from the root כוה (*kava, kau, ku*) 'to burn;' but that is opposed to all the rules of etymological analogy in the formation of Hebrew proper names (comp. Ritter's *Erdkunde* Th. i. p. 222; Heeren's *African Nations*, Engl. Transl. vol. i. p. 289).—N. M.

CUTHAH, (כּוּתָא; Sept. *Xouθα*), a district in Asia, whence Shalmaneser transplanted certain colonists into the land of Israel, which he had desolated (2 Kings xvii. 24-30). From the intermixture of these colonists with the remaining natives sprung the Samaritans, who are called Cuthites (כּוּתִיִּם) in the Chaldee and the Talmud, and for the same reason a number of non-Semitic words which occur in the Samaritan dialect are called Cuthian. The situation of the Cuthah from which these colonists came is altogether unknown. Josephus places it in central Persia, and finds there a river of the same name (*Antiq.* ix. 14. 3; x. 9. 7). Rosenmüller and others incline to seek it in the Arabian Irak, where Abulfeda and other Arabic and Persian writers place a town of this name, in the tract near the Nahr-Malca, or royal canal, which connected the Euphrates and Tigris to the south of the present Bagdad. Winer seems to prefer the conjecture of Stephen Morin and Le Clerc, which identifies the Cuthites with the Cossæi in Susiana (Arrian, *Indic.* xl.; Plin. *Hist. Nat.* vi. 31; Diod. Sic. xvii. 111; Mannert, ii. 493). All these conjectures refer essentially to the same quarter, and any of them is preferable to the one suggested by Michaelis, that the Cuthites were Phœnicians from the neighbourhood of Sidon, founding it upon reasons which no one regards as satisfactory, and which it is therefore unnecessary to re-produce.

CUTHITES. [SAMARITANS.]

CUTTINGS IN THE FLESH. Amongst the prohibitory laws which God gave the Israelites there was one that expressly forbade the practice embraced in those words, *viz.* 'Ye shall not make any cuttings in your flesh for the dead' (Lev. xix. 28). It is evident from this law that such a species of *self-inflicted* torture obtained amongst the nations of Canaan; and it was, doubtless, to guard His people against the adoption of so barbarous a habit, in its idolatrous form, that God led Moses to reiterate the prohibition: 'They shall not make baldness upon their heads, neither shall they shave off the corner of their heads, nor make any cuttings in their flesh' (Lev. xxi. 5; Deut. xiv. 1).

Investing his imaginary deities with the attributes of *cruelty*, man has, at all times and in all countries, instituted a form of religion consisting in cruel rites and bloody ceremonies. If then we look to the practices of the heathen world, whether of ancient or modern times, we shall find that almost the entire of their religion consisted of rites of *deprecation*. Fear of the Divine di-

pleasure would seem to have been the leading feature in their religious impressions. The universal prevalence of *human* sacrifices throughout the Gentile world is, in itself, a decisive proof of the light in which the human mind, unaided by revelation, is disposed to view the Divinity.

It was doubtless such *mistaken* views of the character of God that led the prophets of Baal (1 Kings xviii. 28) to cut their bodies with lancets, supposing that, by mingling their own blood with that of the offered sacrifice, their god must become more attentive to the voice of entreaty. Agreeably to the inference which all this furnishes, we find Tacitus declare (*Hist.* i. 4), 'Non esse curæ Diis securitatem nostram, sed *ultionem.*' In fact it was a current opinion amongst the ancient heathen that the gods were *jealous* of human happiness; and in no part of the heathen world did this opinion more prevail, according to Sanchoniathon's account, than amongst the inhabitants of those very countries which surrounded that land where God designed to place his people Israel. Hence we see why God would lay them under the wholesome influence of such a prohibitory law as that under consideration: 'Ye shall not make any cutting in your flesh for the dead.' The ancients were very violent in their expression of sorrow. Virgil represents the sister of Dido as tearing her face with her nails, and beating her breast with her fists:—

'Unguibus ora soror fœdans et pectora pugnis.'
Æn. iv. 672.

The present writer has seen in India the same wild exhibition of grief for the departed relative or friend. Some of the learned think that that law of Solon's, which was transferred by the Romans into the Twelve Tables, *that women in mourning should not scratch their cheeks*, derived its origin from this law of Moses (Lev. xix. 28). But, however this opinion may be questioned, it would appear that the simple tearing of their flesh out of grief and anguish of spirit is taken, in other parts of Scripture, as a *mark of affection*: thus (Jer. xlviii. 37), 'Every head shall be bald, every beard clipped, and upon all *cuttings.*' Again (ch. xvi. 6): 'Both the great and the small shall die in the land: they shall not be buried, neither shall men lament for them, *nor cut themselves.*' So (ch. xli. 5): 'There came from Samaria fourscore men having their heads shaven and their clothes rent, and having cut themselves, with offerings to the house of the Lord.'

The spirit of Islam is less favourable than that of heathenism to displays of this kind; yet examples of them are not of rare occurrence even in the Moslem countries of Western Asia, including Palestine itself. The annexed figure is copied from one which is represented in many of the books of travel in Egypt and Palestine which were printed in the seventeenth century. It is described by the missionary Eugene Roger (*La Terre Sainte*, &c. 1646, p. 252) as representing 'one of those calenders or devotees whom the Arabs name *Balhoaua*,' and whom the simple people honour as holy martyrs. He appears in public with a scimitar stuck through the fleshy part of his side, with three heavy iron spikes thrust through the muscles of his arm, and with a feather inserted into a cut in his forehead. He moves about with great composure, and endures

all these sufferings, hoping for recompense in the Paradise of Mohammed.—'Aveuglement digne de larmes (adds the monk), que ces misérables commencent ici une vie pleine de souffrance, pour la continuer éternellement dedans les gehennes de l'Enfer!' Add to this, the common



244.

accounts of the gashes which the Persian devotees inflict upon themselves, in the frenzy of their love and grief, during the annual mourning for Hassan and Hossein (Morier, Malcolm, &c.), and the curious particulars in Aaron Hill's *Account of the Ottoman Empire* (ch. 13), respecting the proceedings of young Turks in love:—'The most ridiculous and senseless method of expressing their affection is their singing certain amorous and whining songs, composed on purpose for such mad occasions, between every line whereof they cut and slash their naked arms with daggers, each endeavouring in this emulative madness to exceed the other by the depth and number of the wounds he gives himself.'

From the examples which have been produced, we may very safely conclude that the expression '*cuttings in the flesh*,' in these passages of Scripture, was designed, as already intimated, to declare the feeling of *strong affection*; as though the living would say, 'See how little we regard the pleasures of life, since now the object of our affection is removed from us!' We must therefore come back to our former position, that it was against those self-inflicted tortures, by which the unhappy devotees vainly thought to deprecate the wrath of their angry gods towards their deceased relatives and friends, this law of Moses was especially aimed.—J. W. D.

CYMBALS. [Music.]

CYPRESS. [BEROSII.]

CYPRUS (*Kύπρος*), the modern *Kebris*, one of the largest islands in the Mediterranean, and next to Sicily in importance. It is about 140 miles in length, and varies in breadth from 50 to 5 miles. From its numerous headlands and promontories, it was called *Κεραστis*, *Kerastis*, or *the Horned*; and from its exuberant fertility, *Μακαρα*, *Macaria*, or *the blessed (beatam Cyprum)*: Hor. Carm. iii. 26. 9). Its proximity to Asia Minor, Phœnicia, and Egypt, and its numerous havens, made it a general rendezvous for merchants. 'Corn, wine, and oil,' which are so often mentioned in the Old Testament as the choicest productions of Palestine (Deut. xii. 17; 1 Chron. ix. 29; Neh. x. 39; Jer. xxxi. 12), were found here in the highest perfection. The forests also furnished large supplies of timber for ship-building, which rendered the conquest of the island a favourite project of the Egyptian kings. It was

the boast of the Cyprians that they could build and complete their vessels without any aid from foreign countries (Ammian. Marcell. xiv. 8, § 14). Among the mineral products were diamonds, emeralds, and other precious stones, alum, and asbestos; besides iron, lead, zinc, with a portion of silver, and, above all, copper, the far-famed *æs Cyprium*. The principal mines were in the neighbourhood of Tamassus (Strabo, xiv. 6, vol. iii. p. 245, ed. Tauchn.). 'In Cyproubi prima fuit aris inventio' (Plin. *Nat. Hist.* xxxiv. 2).

Cyprus was originally peopled from Phœnicia [Χηρτίμ]. Amasis I., king of Egypt, subdued the whole island (Herod. ii. 182). In the time of Herodotus the population consisted of Athenians, Arcadians, Phœnicians, and Ethiopians (vii. 90). Under the Persians and Macedonians the whole island was divided into nine petty sovereignties. After the death of Alexander the Great it fell to the share of Ptolemy, the son of Lagus. It was brought under the Roman dominion by Cato. Under the Emperor Augustus it was at first an imperial province, and afterwards, with Gallia Narbonensis, made over to the senate (Dion Cass. liv. iv.). When the empire was divided it fell to the share of the Byzantine emperors. Richard I. of England conquered it in 1191, and gave it to Guy Lusignan, by whose family it was retained for nearly three centuries. In 1473 the republic of Venice obtained possession of it; but in 1571 it was taken by Selim II., and ever since has been under the dominion of the Turks. The majority of the population belong to the Greek church; the archbishop resides at Leikosia. Cyprus was one of the first places out of Palestine in which Christianity was promulgated, though at first to Jews only (Acts xi. 19), by 'those who were scattered abroad' after Stephen's martyrdom. It was visited by Barnabas and Paul on their first missionary tour (Acts xiii. 4), and subsequently by Barnabas and John Mark (Acts xv. 39). Paul sailed to the south of the island on his voyage to Rome (Acts xxvii. 4). [ELYMAS; PAPHOS; SERGIUS PAULUS; SALAMIS.] (Mannert, *Geographie der Griechen und Römer*, vi. 2, pp. 422-454; *Penny Cyclopædia*, art. 'Cyprus'; Dr. R. Pococke's *Description of the East*, &c. Lond. 1745, vol. ii. book iii. ch. i. pp. 210-235; Wilson's *Travels in the Holy Land, Egypt*, &c. Lond. 1831, vol. ii. ch. xii. pp. 174-197).—J. E. R.

CYRENE (Κυρήνη; *Ghenna*, in modern Arabic), a city in Upper Libya, founded about the year b.c. 632, by a colony of Greeks from Thera (Santorini), a small island in the Ægean sea (Thirlwall's *History of Greece*, vol. ii. ch. 12). Its name is generally supposed to be derived from a fountain (but according to Justin, *Hist.* xiii., a mountain), called Κυρή, Cyre, near its site. It was built on a table-land, 1800 feet above the level of the sea, in a region of extraordinary fertility and beauty. It was the capital of a district, called from it Cyrenaica (Barca), which extended from the Gulf of Platea (Bomba) to the Great Syrtis (Gulf of Sidra). With its port Apollonia (Musa Soosa), about 10 miles distant, and the cities Barca, Teuchira, and Hesperis, which at a later period were named Ptolemias, Arsinoe, and Berenice (Strabo, xvii. vol. iii. p. 496, ed. Tauchn.), it formed the Cyrenaic Pentapolis. For above 180 years the form of government was monarchical; it then became republican; and at last, the country

became tributary to Egypt, under Ptolemy Soter. It was bequeathed to the Romans by Apion, the natural son of Ptolemy Physcon, about 97 b.c. (Tacitus, *Annal.* xiv. 18; Cicero, *De leg. Agrar.* ii. 19), and was then formed into a province with Crete (Strabo, xvii. 3). Strabo (quoted by Josephus, *Antiq.* xiv. 7) says, that in Cyrene there were four classes of persons, namely citizens, husbandmen, foreigners, and Jews, and that the latter enjoyed their own customs and laws. At the commencement of the Christian era, the Jews of Cyrene were so numerous in Jerusalem that they had a synagogue of their own (Acts ii. 10; vi. 9). Some of the first Christian teachers were natives of Cyrene (Acts xi. 20; xiii. 1). Simeon, who was compelled to assist in bearing the cross of the Saviour, was a Cyrenian (Matt. xxvii. 32; Mark xv. 21; Luke xxiii. 26).

The ruins of Cyrene and the surrounding country have been diligently explored within the last few years; in 1817 by Dr. Della Cella, in 1821-22 by Capt. Beechey, and in 1826 by M. Pacho, a French traveller. A very interesting account of the results of their investigations is given in the *Penny Cyclopædia*, under the article *Cyrenaica*.

J. E. R.

CYRENIUS (Κυρήνιος, or, according to his Latin appellation, P. SULPITIUS QUIRINIUS), governor of Syria (Luke ii. 1, 2). The mention of his name in connection with the census which was in progress at the time of our Lord's birth, presents very serious difficulties, of which, from the want of adequate data, historical and critical inquiry has not yet attained a satisfactory solution. The passage is as follows: *αὕτη ἡ ἀπογραφὴ πρώτη ἐγένετο ἡγεμονεύοντος τῆς Συρίας Κυρήνιου*, translated in the Authorized Version thus: 'Now this taxing was first made when Cyrenius was governor of Syria.' Instead of 'taxing' it is now agreed that the rendering should be 'enrolment,' or 'registration' (of which use of the word ἀπογράφεσθαι many examples are adduced by Wetstein), as it is clear from Josephus that no taxing did take place till many years after this period. The whole passage, as it now stands, may be properly read, 'This enrolment was the first while Cyrenius was governor of Syria.'

This appears very plain, and would suggest no difficulty, were it not for the knowledge which we obtain from other quarters, which is to the effect, 1. that there is no historical notice of any enrolment at or near the time of our Lord's birth; and, 2. that the enrolment which actually did take place under Cyrenius was not until ten years after that event.

The difficulty begins somewhat before the text now cited; for it is said that, 'in those days there went out a decree from Cæsar Augustus that the whole world should be taxed' (enrolled). But since no historian mentions any such general enrolment of the whole empire, and since, if it had taken place, it is not likely to have been mentioned in connection with the governor of Syria, it is now usually admitted that Judæa only is meant by the phrase rendered 'the whole earth' (but more properly 'the whole land'), as in Luke xxi. 25; Acts xi. 28; and perhaps in xxi. 20. The real difficulties are thus reduced to the two now stated. With regard to the enrolment, it may be said that it was probably not deemed of sufficient importance by the Roman historians to *deserve*

mention, being confined to a remote and comparatively unimportant province. Nor was it perhaps of such a nature as would lead even Josephus to take notice of it, if it should appear, as usually supposed, that no trace of it can be found in his writings.

Of the remaining difficulties various solutions have been offered; and some, despairing of any satisfactory solution, have supposed the verse in question to have been a marginal gloss which has crept into the text; while others have even ventured to suggest that St. Luke must have been mistaken. The following explanations are, however, those which are the most generally received.—

1. Assuming, on the authority of Luke, that an enrolment actually did take place at the time of our Lord's birth, the hypothesis proceeds to make out a probability that Cyrenius was then joint-governor of Syria along with Saturninus. It is known that a few years previous to this date, Volumnius had been joined with Saturninus as the procurator of that province; and the two, Saturninus and Volumnius, are repeatedly spoken of together by Josephus, who styles them equally governors of Syria (*Antiq.* xvi. 9, 1; xvi. 9, 8). Josephus does not mention the recall of Volumnius; but there is certainly a possibility that this had taken place before the birth of Christ, and that Cyrenius, who had already distinguished himself, had been sent in his place. He would then have been under Saturninus, a ἡγεμῶν, 'governor,' of Syria, just as Volumnius had been before, and as Pilate was afterwards, of Judæa. That he should here be mentioned as such by Luke, rather than Saturninus, is very naturally accounted for by the fact, that he returned, ten years afterwards, as procurator or chief governor, and then held a second and more important census for the purpose of registration and taxation, when Archelaus was deposed, and Judæa annexed to the Roman province of Syria. The only real objection to this solution is the silence of all other history. But although profane history does not affirm the fact of Cyrenius having formerly been procurator of Syria, yet it does not in any way deny it; and we may therefore safely rest upon the authority of the sacred writer for the truth of this fact, just as we do for the fact of the existence of the first enrolment itself.

2. Another explanation would read the passage thus:—'This enrolment was made *before* Cyrenius was governor of Syria.' The advocates of this view suppose that Luke inserted this verse as a sort of parenthesis, to prevent his readers from confounding this enrolment with the subsequent census made by Cyrenius. The positive, or rather the superlative, πῶντη, is thus understood in the sense of the comparative πῶντερά, and is made to govern the following genitive. That both the positive and superlative are sometimes used in place of the comparative is doubtlessly true; but such a construction would in the present case be very harsh, and very foreign to the usual simplicity of Luke.

3. Another mode of getting over the difficulty is sanctioned by the names of Calvin, Valesius, Weistain, Hales, and others. First, changing ἀντη into ἀντή they obtain the sense:—'In those days there went forth a decree from Augustus, that the whole land should be enrolled; but the

enrolment itself was first made when Cyrenius was governor of Syria.' The supposition here is, that the census was commenced under Saturninus, but was not completed till two years after, under Quirinus. Dr. Robinson (*Addit. to Calmet*, in 'Cyrenius') objects to this view the entire absence of any historical basis for it. But he must at the time have been unmindful of Hales, who, in his *Chronology*, has worked out this explanation with more than his usual care and success.

Hales reminds us that a little before the birth of Christ, Herod had marched an army into Arabia to redress certain wrongs which he had received; and this proceeding had been so misrepresented to Augustus that he wrote a very harsh letter to Herod, the substance of which was, that 'having hitherto treated him as a friend, he would now treat him as a subject.' And when Herod sent an embassy to clear himself, the emperor repeatedly refused to hear them, and so Herod was forced to submit to all the injuries (ἡρπαγῶνας) offered to him (*Joseph. Antiq.* xvi. 9). Now it may be collected that the chief of these injuries was the performance of his threat of treating him as a subject, by the degradation of his kingdom to a Roman province. For soon after Josephus incidentally mentions that 'the whole nation of the Jews took an oath of fidelity to Cæsar and the king jointly, except 6000 of the Pharisees, who, through their hostility to the regal government, refused to take it.' The date of this transaction is determined by its having been shortly before the death of Pheroras, and coincides with the time of this decree of enrolment and of the birth of Christ. The oath which Josephus mentions would be administered at the same time, according to the usage of the Roman census, in which a return of persons, ages, and properties, was required to be made upon oath, under penalty of confiscation of goods, as we learn from Ulpian. That Cyrenius, a Roman senator and procurator, was employed to make this enrolment, we learn not only from St. Luke, but by the joint testimony of Justin Martyr, Julian the Apostate, and Eusebius; and it was made while Saturninus was president of Syria (to whom it was attributed by Tertullian) in the thirty-third year of Herod's reign, corresponding to the date of Christ's birth. Cyrenius, who is described by Tacitus as 'impiger militiæ et acribus ministeriis,' 'an active soldier and rigid commissioner,' was well qualified for an employment so odious to Herod and his subjects; and probably came to execute the decree with an armed force. The enrolment of the inhabitants, 'each in his own city,' was in conformity with the wary policy of the Roman jurisprudence, to prevent insurrections and to expedite the business; and if this precaution was judged prudent even in Italy, much more must it have appeared necessary in turbulent provinces like Judæa and Galilee.

At the present juncture, however, it appears that the census proceeded no further than the first act, namely, of the enrolment of persons in the Roman register. For Herod sent his trusty minister, Nicolsus of Damascus, to Rome; who, by his address and presents, found means to mollify and undeceive the emperor, so that he proceeded no further in the design which he had entertained. The census was consequently at this time suspended; but it was afterwards carried into effect.

upon the deposal and banishment of Archelaus, and the settlement of Judea as a Roman province. On this occasion the trusty Cyrenius was sent again, as president of Syria, with an armed force, to confiscate the property of Archelans, and to complete the census for the purposes of taxation. This taxation was a poll tax of two drachmæ a-head upon males from fourteen, and females from twelve to sixty-five years of age—equal to about fifteen pence of our money. This was the 'tribute money' mentioned in Matt. xvii. 24-27. The payment of it became very obnoxious to the Jews, and the imposition of it occasioned the insurrection under Judas of Galilee, which Luke himself describes as having occurred 'in the days of the taxing' (Acts v. 37).

By this statement, connected with the slight emendation of the text already indicated, Hales considers that 'the Evangelist is critically reconciled with the varying accounts of Josephus, Justin Martyr, and Tertullian; and an historical difficulty satisfactorily solved, which has hitherto set criticism at defiance.' This is perhaps saying too much; but the explanation is undoubtedly one of the best that has yet been given (*Analysis of Chronology*, iii. 48-53; Lardner's *Credibility*, i. 248-329; Robinson, *Addit. to Calmet*, in 'Cyrenius'; Wetstein, Kuinoel, and Campbell, on Luke ii. 2, &c.).

CYRUS (כורש *Khoresh*, *Kûpos*), the celebrated Persian conqueror of Babylon, who promulgated the first edict for the restoration of the Jews to their own land (Ezra i. 1, &c.). We are informed by Strabo that his original name was Agra-dates (xv. 3, p. 320, ed. Tauchn.); but he assumed that of Kouros, or Khoresh (whichever was the most accurate Persian form) doubtless on ascending the throne. For Ctesias tells us (Photius, *Epit. Ctes.* ch. xlix.) that the word means *the Sun*. We may perhaps compare it with the Hebrew כהרש *kheres*, which bears the same sense; and with the name of the Egyptian deity *Horus*, or *Apollo*.

The authorities on which we have to rest for our knowledge of the life of Cyrus are chiefly three. *First*, Herodotus, who reported the tales concerning him current in Asia a century later; but selected from them with the taste of a Greek epic or romance writer. *Secondly*, Xenophon, who has made the life of Cyrus the foundation of a philosophical novel, written in a moral spirit, as unhistorical as that of Fenelon's *Télémaque*. *Thirdly*, the epitome of Ctesias, preserved for us by the patriarch Photius. Ctesias was a Greek physician, who stayed seventeen years at the Persian court towards the end of the reign of Darius Nothus, about b.c. 416-400. (See Bähr's *Ctesias*, p. 15.) According to Diodorus, he drew his histories from the royal archives; and, in part, that may be true. But a large number of the facts recorded by him would certainly never have been allowed a place in them; and several great *anachronisms* which he commits are mistakes of a kind which can scarcely ever occur in books written in the form of annals. It would seem then that his sources of knowledge were not much better than those of Herodotus; but his lengthened stay in Persia so familiarized him with Persian institutions, and multiplied his opportunities of access to those sources, that, *cæteris paribus*, he appears to be a better authority. Unfortu-

nately, nothing remains to us but a mere epitome of his work.

From these and a few subordinate authorities, we must endeavour to give as good a reply as we can to the chief problems concerning the life of Cyrus.

On the parentage of Cyrus.—Herodotus and Xenophon agree that he was son of Cambyses prince of Persia, and of Mandane daughter of Astyages, king of the Median empire. Ctesias denies that there was any relationship at all between Cyrus and Astyages. According to him, when Cyrus had defeated and captured Astyages, he *adopted* him as a grandfather, and invested Amytis, or Amyntis, the daughter of Astyages (whose name is in all probability only another form of Mandane), with all the honours of queen dowager. His object in so doing was to facilitate the submission of the more distant parts of the empire, which were not yet conquered; and he reaped excellent fruit of his policy in winning the homage of the ancient, rich, and remote province of Bactria. Ctesias adds, that Cyrus afterwards married Amytis. It is easy to see that the latter account is by far the more historical, and that the story followed by Herodotus and Xenophon is that which the courtiers published in aid of the Persian prince's designs. Yet there is no reason for doubting that, on the father's side, Cyrus belonged to the Achæmenidæ, the royal clan of the military tribe of the Persians.

On the elevation of Cyrus.—It was the frequent practice of the Persian monarchs, and probably therefore of the Medes before them, to choose the provincial viceroys from the royal families of the subject nations, and thereby to leave to the vanquished much both of the semblance and of the reality of freedom. This will be sufficient to account for the first steps of Cyrus towards eminence. But as the Persian armies were at that time composed of ruder and braver men than the Medes—(indeed, to this day, the men of Shirâz are proverbially braver than those of Isfahân)—the account of Xenophon is credible, that in the general wars of the empire Cyrus won the attachment of the whole army by his bravery; while, as Herodotus tells, the atrocious cruelties of Astyages may have revolted the hearts of the Median nobility.

On the transition of the empire from the Medes to the Persians.—Xenophon's romance omits the fact that the transference of the empire was effected by a civil war; nevertheless, the same writer in his *Anabasis* confesses it (iii. 4, 7, 12). Herodotus, Ctesias, Isocrates, Strabo, and, in fact, all who allude to the matter at all, agree that it was so. In Xenophon (*l. c.*) we find the Upper Tigris to have been the seat of one campaign, where the cities of Larissa and Mespila were besieged and taken by Cyrus. From Strabo we learn that the decisive battle was fought on the spot where Cyrus afterwards built Pasargadæ, in Persis, for his native capital. This agrees with Herodotus's account of two armies being successively lost, which may mean that the war was ended in two campaigns. Yet Ctesias represents Astyages as finally captured in the palace of Ecbatana. Cyrus (says Herodotus) did Astyages no harm, but kept him by his side to the end of his life. This is like the generosity of the Persian kings to vanquished foreigners, but

very unlike the conduct of fortunate usurpers, east or west, towards a fallen superior. The tale in Ctesias is more like the current imperial craft. There we read that Cyrus at first made Astyages ruler of the Barcians (see Tzetzes, in Bähr's *Ctes.* p. 222), and afterwards sent for him by the eunuch Petisacas to visit his daughter and son-in-law, who were longing to see him. The eunuch, however, put him to death on the road; and Cyrus, indignant at the deed, gave up the murderer to the cruel vengeance of the queen. Astyages had certainly lived long enough for the policy of Cyrus; who, by the Roman Cassius's test of *Cui bono?* 'Who gained by it?' cannot be accounted innocent.

The Medes were by no means made subject to the Persians at first. It is highly probable that, as Herodotus and Xenophon represent, many of the noblest Medes sided with Cyrus, and during his reign the most trusted generals of the armies were Medes. Yet even this hardly explains the phenomenon of a Darius the Mede, who, in the book of Daniel, for two years holds the government in Babylon, after the capture of the city by the Medes and Persians. Indeed, the language used concerning the kingdom of Darius might be explained as Oriental hyperbole, and Darius be supposed a mere satrap of Babylon, only that Cyrus is clearly put forward as a *successor* to Darius the Mede. Many have been the attempts to reconcile this with the current Grecian accounts; but there is one only that has the least plausibility, viz., that which, with Xenophon, teaches that Astyages had a son still living (whom Xenophon calls Cyaxares), and that this son is no other than Darius the Mede; to whom Cyrus, by a sort of nephew's piety, conceded a nominal supremacy at Babylon. Objections to this likewise are evident, but they must be discussed under 'Darius the Mede,' or the book of 'Daniel.'

In the reign of the son of Cyrus the depression of the Medes probably commenced. At his death the Median conspiracy took place; after the defeat of which the Medes doubtless sunk lower still. At a later time they made a general insurrection against the Persian power, and its suppression seems to have brought them to a level with Hyrcanians, Bactrians, and other vassal nations which spoke the tongue of Persia; for the nations of the poetical *Iran* had only dialectal variations of language (Strabo, xv. 2, p. 311).

Conquests and Wars of Cyrus.—The descriptions given us in Ctesias, and in Plutarch's Artaxerxes (which probably are taken from Ctesias), concerning the Persian mode of fighting, are quite Homeric in their character. No skill seems to be needed by the general; no tactics are thought of: he does his duty best by behaving as the bravest of common soldiers, and by acting the part of champion, like a knight in the days of chivalry. We cannot suppose that there was any greater advance of the military art in the days of Cyrus. It is agreed by all that he subdued the Lydians, the Greeks of Asia Minor, and the Babylonians: we may doubtless add Susiana, which must have been incorporated with his empire before he commenced his war with Babylon; where also he fixed his military capital (Susa, or Shushan), as more central for the necessities of his administration than Pasargadæ. Yet the latter

city continued to be the more sacred and beloved home of the Persian court, the place of coronation and of sepulture (Strabo, xv. 3, p. 318; and Plut. *Artax.* init.). All Syria and Phœnicia appear to have come over to Cyrus peaceably.

In regard to the Persian wars, the few facts from Ctesias, which the epitomator has extracted as differing from Herodotus, carry with them high probability. He states that, after receiving the submission of the Bactrians, Cyrus made war on the Sacians, a Scythian (*i. e.* a Slavonic) people, who seem to have dwelt, or perhaps rather roved, along the Oxus, from Bokhara to Khiva; and, that, after alternate successes in battle, he attacked the whole nation to himself in faithful allegiance. Their king is called Amorges by Ctesias. They are undoubtedly the same people that Herodotus (vii. 64) calls *Amyrgian* Sacians; and it is highly probable that they gave to the district of Margiana its name. Their women fought in ranks, as systematically as the men. Strabo has cursorily told us of a tradition (xv. 2, p. 307) that Cyrus escaped with but seven men through the deserts of Gedrosia, fleeing from the 'Indians'—which might denote an unsuccessful war against Candahar, &c., a country which certainly was not reduced to the Persian empire until the reign of Darius Hystaspis.

The closing scene of the career of Cyrus was in battle with a people living on one or both banks of the river Iaxartes, now the Syr-daria. Herodotus calls the enemy the Massagetans, who roamed along the north bank of the river: according to Ctesias it was the Derbices, who seem to have been on the south. Both may in fact have combined in the war. In other respects the narrative of Ctesias is beyond comparison more credible, and more agreeable with other known facts, except that he introduces the fiction of Indians with elephants aiding the enemy. Two battles were fought on successive days, in the former of which Cyrus was mortally wounded, but was carried off by his people. In the next, the Sacian cavalry and the faithful Amorges came to support him, and the Derbices sustained a total and bloody defeat. Cyrus died the third day after his wound: his body was conveyed to Pasargadæ, and buried in the celebrated monument, which was broken open by the Macedonians two centuries afterwards (Strabo, xv. 3; Arrian, vi. 29). The inscription, reported by Aristobulus, an eye-witness, is this:—'O man, I am Cyrus, who acquired the empire for the Persians, and was king of Asia. Grudge me not then this monument.'

Behaviour of Cyrus to the Jews.—The kings of Assyria and Babylon had carried the Jews into captivity, both to remove a disaffected nation from the frontier, and to people their new cities. By undoing this work, Cyrus attached the Jews to himself, as a garrison at an important post. But we may believe that a nobler motive conspired with this. The Persian religion was primitively monotheistic, and strikingly free from idolatry; so little Pagan in its spirit, that, whatever of the mystical and obscure it may contain, not a single impure, cruel, or otherwise immoral practice was united to any of its ceremonies. It is credible, therefore, that a sincere admiration of the Jewish faith actuated the noble Persian, when he exclaimed, in the words of the book of

Ezra, 'Go ye up, and build in Jerusalem the house of Jehovah, God of Israel; *He is God!*'—and forced the Babylonian temples to disgorge their ill-gotten spoil. It is the more remarkable, since the Persians disapproved the confinement of temples. Nevertheless, impediments to the fortification of Jerusalem afterwards arose, even during the reign of Cyrus (Ezra iv. 5).

Perhaps no great conqueror ever left behind him a fairer fame than Cyrus the Great. His mighty achievements have been borne down to us on the voice of the nation which he elevated; his evil deeds had no historian to record them. What is more, it was his singular honour and privilege to be the first Gentile friend to the people of Jehovah in the time of their sorest trouble, and to restore them to the land whence light was to break forth for the illumination of all nations. To this high duty he is called by the prophet (Isa. xlv. 28; Jer. l. 1), and for performing it he seems to be entitled 'The righteous man' (xli. 2; xlv. 13).—F. W. N.

D.

DABERATH (דַּבְּרָת; Sept. Δαβιρόθ and Δεββά), a town in the tribe of Issachar, assigned to the Levites (Josh. xix. 12; xxi. 28; 1 Chron. vi. 72). It is probably the same as the Dabaritta, in the great plain, of Josephus (*Vita*, 62; *De Bell. Jüd.* ii. 21. 3); and the Dabira, which Eusebius and Jerome place by Mount Tabor, in the region of Dio-Cæsarea. It is recognised in the present Debürich, a small village lying on the side of a ledge of rocks, just at the base of Taboon on the north-west (Robinson's *Researches*, iii. 210).

DAGAN. [Corn.]

DAGON (דַּגּוֹן; Sept. Δαγών) is the name of a national god of the Philistines at Gaza and Ashdod (Judg. xvi. 21, 23; 1 Sam. v. 1 sq.; 1 Chron. x. 10). As to the meaning of the name, the expressions of Philo Byblius, Δαγών, ὅς ἐστι Σίτων, and Δαγών ἐπειδὴ εὖρε σίτον καὶ ἄροτρον, ἐκλήθη Ζεὺς Ἀρότριος (*Sanchoniathon*, ed. Orelli, p. 26, 32), show that he assumed the word to be derived from דַּגּ, *corn*. This derivation is admitted by Bochart, who argues that the fields of the Philistines were laid waste by mice, in order to show that Dagon was not the true god of agriculture, as he was thought to be (*Hieroz.* ed. Rosenm. i. 381); and by Beyer, who makes the extraordinary assertion that we may conclude, from the sending of the five golden mice (to the God of Israel! 1 Sam. vi. 4), that golden mice were offered to Dagon as an acknowledgment of his care in freeing their fields from mice (*Ad ditamenta ad Selden.* p. 285). Each of these arguments is open to the objection that the five golden piles—which were sent at the same time, and which, if they bore any reference to Dagon, would possibly not be reconcilable with his character as the god of agriculture—are here altogether disregarded; when yet it is evident that no conclusions can be legitimately drawn from the one unless they apply with equal force to the other. There are much better arguments, however, for the other etymology, which deduces the name from דַּג, *fish*, with the ending *ón* (Ewald,

Hebr. Gram. § 341). This derivation is not only more in accordance with the principles of formation (for if Dagon comes from the root דַּג, it must belong to the adjective formation in § 322, c, which does not appear so suitable for the force of a proper name), but it is most decisively established by the terms employed in 1 Sam. v. 4. It is there said that Dagon fell to the earth before the ark, that his head and the palms of his hands were broken off, and that 'only Dagon was left on him.' If Dagon is derived from דַּג, *fish*, and if the idol, as there is every reason to believe, had the body of a fish with the head and hands of a man, it is easy to understand why a part of the statue is there called Dagon in contradistinction to the head and hands; but not otherwise. That such was the figure of the idol is asserted by Kimchi, and is admitted by most modern scholars. It is also supported by the analogies of other fish deities among the Syro-Arabians. Besides the ΑΤΕΡΓΑΤΙΣ of the Syrians, the Babylonians had a tradition, according to Berosus (*Berosi Quæ supersunt*, ed. Richter, p. 48. 54), that at the very beginning of their history an extraordinary being, called Oannes, having the entire body of a fish, but the head, hands, feet, and voice of a man, emerged from the Erythræan sea, appeared in Babylonia, and taught the rude inhabitants the use of letters, arts, religion, law, and agriculture; that, after long intervals between, other similar beings appeared and communicated the same precious lore in detail, and that the last of these was called Odakon (Ὀδάκων). Selden is persuaded that this Odakon is the Philistine god Dagon (*De Diis Syris*, p. 265). The resemblance between Dagon and Atergatis, or Derketo, is so great in other respects, that Selden accounts for the only important difference between them—that of sex—by referring to the audacious nature of many heathen gods. It is certain, however, that the Hebrew text, the Sept., and Philo Byblius, make Dagon masculine. The temple of Dagon at Ashdod was destroyed by Jonathan the brother of Judas the Maccabee, about the year B.C. 148 (1 Mac. x. 84).—J. N.

DALMANUTHA (Δαλμανουθά), a village near Magdala (Mark viii. 10; comp. Matt. xv. 39); probably on the western shore of the lake of Genesareth, a little to the north of Tiberias.

DALMATIA (Δαλματία), a province of Europe on the east of the Adriatic Sea, forming part of Illyricum, and contiguous to Macedonia. Titus was sent into this region by Paul to spread the knowledge of the Gospel.

DAMARIS (Δάμαρις), a woman of Athens, who was led to embrace Christianity by the preaching of St. Paul (Acts xvii. 34). Some suppose she was the wife of Dionysius the Areopagite, who is mentioned before her; but the construction in the Greek will not sanction this conclusion. The name Damaris does not occur elsewhere, whence some suppose it a corruption of Damalis (Δάμαλις), which was not an uncommon name; but the *r* and *l* are in Greek so constantly interchanged as to render this emendation superfluous.

DAMASCUS (Δαμασκός; Δαμασκός), called by the natives Es-Sham, a city of Syria, capital of an important pashalic of the same name, and indeed the chief or capital city of Syria, lies in a

plain at the eastern foot of Anti-Libanus. It was sometimes spoken of by the ancients as an Arabian city, but in reality it belongs to Syria. In 2 Sam. viii. 5, 6, 'the Syrians of Damascus' are spoken of, and the words, 'Syria of Damascus' are found in Isa. vii. 8. It is expressly said, 'the head of Syria is Damascus;' also, Isa. xvii. 3, 'the kingdom' is to cease 'from Damascus.' So that this place was obviously the metropolis of a Syrian empire. It gave name (Syria Damascusena, Plin. *Hist. Nat.* v. 13) to a district of Syria, which, in 1 Chron. xix. 6, is distinguished as דַמַשְׁקַיִם, rendered 'Syria-Maachah,' in the Common English Version. The plain is about 400 stadia from the Mediterranean, and from six to eight days' journey from Jerusalem. It lies on the Chrysorroas (Barrada), by which, and its off-shoots, it is, with the aid of canals, abundantly watered. Its celebrity is of early date. Strabo (xvi. p. 756) speaks of it in eulogistic terms. In a religious point of view also its repute was great. Julian (*Ep.* 24.) terms it 'the great and sacred Damascus, surpassing every city both in the beauty of its temples and the magnitude of its shrines, as well as the timeliness of its seasons, the limpidness of its fountains, the volume of its waters, and the richness of its soil.' The locality would seem to have been expressly created for a large, flourishing, and durable city.

Damascus—by some held to be the most ancient city in the world—is called by the Orientals, 'a pearl surrounded by emeralds.' Nothing can be more beautiful than its position, whether approached from the side of Mount Lebanon, from the Desert to the east, or by the high-road from the north from Aleppo and Hamah. For many miles the city is girdled by fertile fields, or gardens, as they are called, which, being watered by rivers and sparkling streams, give to the vegetation, consisting principally of olive-trees, a remarkable freshness and beauty. Of all the cities of the East, Damascus is probably the most oriental.

The plain of Damascus owes its fertility and loveliness to the river Barrada, which is supposed to be either the Abana or Pharpar of 2 Kings v., and has been noticed under another head [ABANA].

The view of Damascus, when the traveller emerges from Anti-Libanus, is of the most enchanting kind. 'One of the most magnificent prospects in the world,' says Addison (*Damascus and Palmyra*, vol. ii. p. 92), 'burst upon my sight: like the first view of Constantinople, it is unique. We were looking down from an elevation of a thousand feet upon a vast plain, bordered in the distance by blue mountains, and occupied by a rich, luxuriant forest of the walnut, the fig, the pomegranate, the plum, the apricot, the citron, the locust, the pear, and the apple, forming a waving grove of more than fifty miles in circuit; possessing a vast variety of tint, a peculiar density and luxuriance of foliage, and a wildly-picturesque form, from the branches of the loftier trees throwing themselves up above a rich underwood of pomegranates, citrons, and oranges, with their yellow, green, and brown leaves; and then conceive our sensations, to see grandly rising in the distance, above this vast superficies of rich luxuriant foliage, the swelling leaden domes, the gilded crescents, and the marble minarets of Damascus; while in the centre of all, winding towards the city, ran

the main stream of the river Barrada. As we descended, here and there the openings in the trees displayed little patches of green verdure or a glimpse of richly-cultivated gardens: the whole of the rich tract was surrounded by a mud-wall, beyond which all was arid and desert.' A more ample description to the same effect is given by Lamartine (*Travels in the East*).

The interior of the city does not correspond with the exquisite beauty of its environs. In the Armenian quarter the houses are built with mud, and pierced towards the street by a very few small grated windows with red painted shutters. They are low, and the flat arched doors resemble those of stables. A filthy dunghill and a pool of stinking water are almost invariably before the doors. In some of these dwellings, belonging to the principal Armenian merchants, there is great internal richness and elegance. The furniture consists of magnificent Persian or Bagdad carpets, which entirely cover the marble or cedar floor, and of numerous cushions and mattresses, spread in the middle of the saloon, for the members of the family to sit or lean against. There is a fine wide street, formed by the palaces of the agas of Damascus, who are the nobility of the land. The fronts of these palaces, however, towards the street, are like long prison or hospital walls, mere grey mud walls, with few or no windows, whilst at intervals is a great gate opening on a court. But the interior is magnificent. The ornaments of many of their saloons alone cost upwards of 1000*l.* sterling. The bazaars are very striking. The great bazaar is about half a league long. They are long streets covered in with high wood-work, and lined with shops, stalls, magazines, and cafés. The shops are narrow, and go only a short way back. The merchant is seated in front, with his legs doubled up below him, and the pipe in his mouth. The magazines are stored with merchandise of all sorts, and particularly with Indian manufactures, which are brought in great profusion by the caravans from Bagdad. In the midst of the bazaars stands the finest khan in the East, that of Hassan Pasha. It is an immense cupola, whose bold springing arch recalls that of St. Peter at Rome; it is in like manner borne on granite pillars. The gate of this khan is a piece of Moorish architecture, the richest in detail and most imposing in effect that can be seen in the world. The khan has been built only about fifty years. Not far distant is the principal mosque, formerly a church consecrated to St. John, whose skull and sepulchre, found in this holy place, give it such a sanctity that it is death for even a Mohammedan to enter the room where the relics are kept. Situated at the edge of the desert, at the mouth of the plains of Cœle-Syria and the valleys of Galilee, of Idumæa, and of the coasts of the Sea of Syria, Damascus was needed as a resting-place for the caravans to India. It is essentially a commercial town. Two hundred merchants are permanently settled in it. Foreign trade is carried on by the Great Mecca caravan, the Bagdad caravan, the Aleppo, and by several small ones to Beirut (its sea-port), Tripoli, Acre, &c. Lamartine makes its population to be some 300,000, of whom 30,000 are Christians. Another estimate (McCulloch, *Geograph. Dict.*) gives only from 120,000 to 150,000 inhabitants, comprising 12,000

Christians and as many Jews. Damascus is an eminently interesting town. It is thoroughly Oriental, though now representatives, in person and costume, of most other distinguished countries of the world may be seen in its streets. Its proximity to Baalbec and Palmyra, which are mere ruins, and its still highly flourishing condition, after having existed for perhaps a longer period than any other city on the face of the earth, combine, with many facts connected with its history, to throw around it a calm and attractive, not to say sacred, light.

Political changes and social influences have lessened and mitigated the proverbial bigotry of the Damascenes. The lower classes, indeed, are still fanatical, but a better feeling on religion prevails in the higher. All Christians in Damascus were, when Lamartine visited the city, compelled to wear black turbans. He states that on his last day's journey towards Damascus he and his companions assumed the complete Turkish costume, to escape being recognised as Franks, adding, 'the fanatical population of Damascus and the surrounding country render these precautions necessary. The Damascenes nourish hatred of the European name and costume. They alone amongst the Orientals have refused to admit consuls or even consular agents for Christian powers. Damascus is a holy, fanatical, and free city—nothing must pollute it.' Till within the last few years the appearance in the city of a Frank costume was a signal for a riot. Christians and Jews were alike forbidden to ride any beast but an ass. Addison, however (in 1835), found a greatly improved state of feeling. The insolence of the Damascenes was curbed. He and his companions used horses, and saw Christians in great numbers mixing with others, and pursuing their business or taking recreation in their own garb unmolested. 'Here and there,' he says, 'a scowling look or a smothered cry of *Yavor*, or "infidel," after we had passed, were all the tokens of discount we perceived.' The improvement Addison ascribes in part to the residence in the place of a British consul. He adds:—'As "the gate of Mecca," the place of rendezvous for the great caravan of pilgrims, Damascus has always been considered one of the most sacred of the Moslem cities; and, being annually filled with a vast crowd of religious fanatics, hurrying on to the tomb of the prophet, it is not strange that the population has always been so remarkable for its fanaticism and bigotry towards Christians. Even now, at the period of the assembling of the great caravan, it would hardly be prudent for Franks to exhibit themselves in their hats and coats before the crowd of bald-headed wretches which then throng all the thoroughfares, burning with religious zeal' (vol. ii. p. 449).

Mr. Addison was conducted to the spot where, according to tradition among the Christians, Saul saw the light from heaven. Winding round the walls on the outskirts of the city, he and his companions came to a point where they were broken at the top, at which Paul is said to have been let down in a basket, to escape the indignation of the Jews, when (Acts ix.) 'the disciples took him by night, and let him down by the wall in a basket.' From hence, passing on through some pretty lanes, they came to an open green

spot, surrounded by trees, over the tops of which were seen the distant summits of Mount Hermon. At this place they were 'informed Saul had arrived when (Acts ix. 3) as he journeyed he came near Damascus, and suddenly there shined round about him a great light from heaven.' These localities are pointed out with the greatest confidence by the Damascene Christians of all sects, and are held in great veneration; nor is it difficult to suppose that the true spots have been handed down by tradition among the followers of the cross. 'The street which is called Straight' (Acts ix. 11) is still found in Damascus, or at any rate a street bearing that name. Addison says it is 'a mile in length,' and 'so called because it leads direct from the gate to the castle or palace of the Pasha.' The house of Judas, also, to which Ananias went, is still pointed out, as well as that of Ananias himself. How much credulity may have had to do in fixing on and perpetuating the recollection of these localities, it is probably easier to suspect than to ascertain.

Of the origin of Damascus nothing certain is known. The building of it has been ascribed both to Abraham and to his 'steward, Eliezer of Damascus.' That the city existed as early as the days of Abraham is clear from Gen. xiv. 15; xv. 2; but the way in which it is spoken of in these passages shows that even at the time to which they refer it was not a new nor an unknown place; for Abraham's steward is characterized as being of Damascus, and the locality of another town (Hobah) is fixed by stating that it lay 'on the left hand of Damascus.' L. Müller (*Ad Orig. Reg. Damas.*) has undertaken to show that it was even then governed by its own rulers. How long it may have retained its independence cannot be determined; but it appears (2 Sam. viii. 5, 6; 1 Chron. ix. 4) that its monarch having unadvisedly attacked the victorious David, the Hebrew sovereign defeated the Syrians, making a great slaughter of them, and, in his turn, subdued Damascus, and exacted tribute from its inhabitants. This subjection was not of long duration, for under his successor (1 Kings xi. 24) one Rezon, a servant of Hadadezer, king of Zobah, made himself master of Damascus, and, ruling over Syria, 'was an adversary to Israel all the days of Solomon.' After Rezon, Hezion occupied the throne; he was succeeded by his son Tabrimon (1 Kings xv. 18, 19), who was in alliance with Asa, king of Judah. Preserving the same direct line, the crown then fell to Benhadad, who, having been in a league with Baasha, king of Israel, was bribed by Asa to desert his ally, and join himself in attacking Baasha, on whom the united forces inflicted great injury (1 Kings xv. 19, 20). In the time of Benhadad, son of the preceding monarch, Damascus was the head of a very powerful empire, since it appears (1 Kings xx. 1) that 'thirty and two kings' (doubtless petty princes or pashas, governors of provinces) accompanied him in a campaign which he undertook against Samaria. Of Ahab, its king, he insolently demanded, 'thy silver and thy gold, thy wives also and thy children, even the goodliest.' The Israelitish monarch saw no alternative but obedience:—'I am thine, and all that I have.' This yieldingness sharpened the rapacity of Benhadad, who proceeded to take the most offensive measures, which had their natural effect in rousing

Ahab. The king of Israel therefore took counsel of 'all the elders of the land,' and, being advised to resist, met the threats of Benhadad with these famous words:—'Let not him that girdeth on his harness boast himself as he that putteth it off.' The Damascene king, undismayed, gave himself up to drinking and revelry. Ahab was under religious influences. The battle took place; the Syrians were defeated, and their king effected his retreat with difficulty. The subsequent operations of the Damascenes, under their king, have already been stated [BENHADAD]. Hazael, the successor of Benhadad, unwilling to give up hope of being master of Ramoth-Gilead, was attacked by the united forces of Judah and Israel, whom he vanquished, wounding Joram (2 Kings viii. 28); and, at a later period, under Jehu (2 Kings x. 32), laid waste a large portion of the Israelitish kingdom, and 'threshed Gilead with threshing

instruments of iron' (Amos i. 3). Determined on revenge (2 Kings xii. 17), Hazael marched to Jerusalem, and was bought off by king Jehoash by a most costly sacrifice. He, however, took the kingdom of Israel (2 Kings xiii. 3), and, though he treated the people oppressively, he was able to hand them over in subjection to his son, Benhadad III., who was thrice beaten (2 Kings xiii. 24) by the Israelitish king Jehoash, and deprived of all his conquests. Jeroboan II. (2 Kings xiv. 28) pursued these advantages, and captured Damascus itself. Subsequently a junction took place between Israel and Damascus, when (2 Kings xv. 37) Rezin, king of the latter, and Pekah, king of the former, entered into a confederacy, and undertook an expedition against Ahaz, king of Judah (Isa. vii. 1). They succeeded in 'recovering Elath to Syria,' but could not prevail against Jerusalem (2 Kings xvi. 6). Ahaz, how-

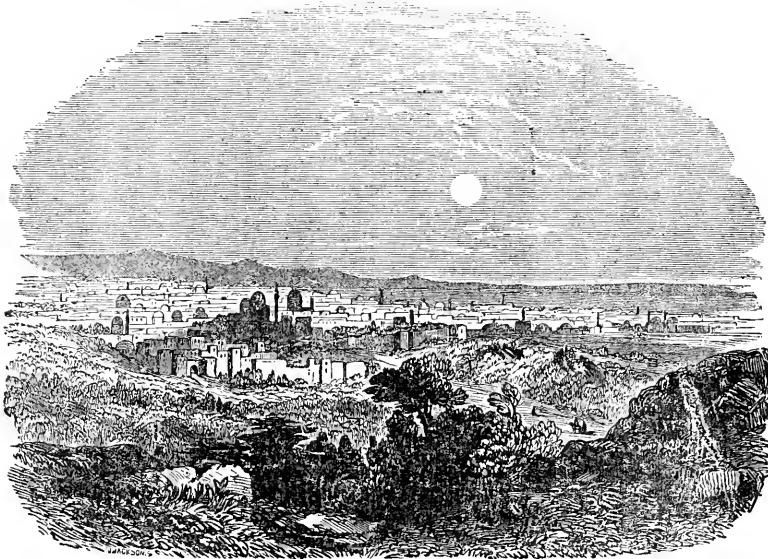

245. [Damascus.]

ever, urged by necessity, applied for aid to Tiglath-pileser, king of Assyria, who, being bribed by a munificent present, fell on Damascus, took it, carried the people of it captive to Kir (on the river Kur), slew Rezin, and united the Damascene territory with his own kingdom (2 Kings xvi. 9; Isa. viii. 4; x. 9; xvii. 1). Damascus after this fell under the power of the Babylonians and Persians, from whom it was taken by Alexander the Great, as one consequence of his victory at Issus (Arrian, *Exped. Alex.* ii. 11, 15; Curt. iii. 12). Then it made a part of the kingdom of the Seleucidæ, from whom it passed into the hands of the Romans (Flor. iii. 5; Diod. Sic. xxxix. 30). In the time of the Apostle Paul it belonged to the dependent kingdom of the Arabian prince Aretas. At a later period it was reckoned among the cities of Decapolis (Plin. *Hist. Nat.* v. 16); then it was added to the province of Phœnicia (Amm. Marc. xiv. 8; Tertull. *Contra Marc.* iii. 13); and at last made a part of the province of Phœnicia Li-

banesia (Hierocles, *Synec.*). From the time of Hadrian it bore the honorary title of Metropolis, without enjoying the rights of a metropolis (Wesseling, *ad Hierocl.* p. 717). Under the Greek emperors of Constantinople Damascus was the most celebrated city of the East, remarkable for its wealth, luxury, magnificence, and its numerous Christian population. A great era in its history is its conquest by the Saracens, of which an account may be found in the Arabic historian Alwakidi (Ockley's *Hist. of the Saracens*). The war was begun about A.D. 633, by the celebrated Abubeker, the successor of Mohammed; and ended in the capture of the city, and the substitution of Islamism for Christianity. It then became the capital of the whole Mussulman world, till the Caliphate was removed from it to Bagdad. The city continued under the sway of the caliphs of Bagdad, till it came into the hands of the Turks, and was held and rendered famous by Noureddin and Saladin. In 1301 Timour the Tartar captured the city and

barbarously treated its inhabitants. From Josephus (*De Bell. Jud.* i. 2; xxv. 2; comp. Acts ix. 2) it appears that its population contained great numbers of Jews.

Damascus is famous in the first age of Christianity for the conversion and first preaching of the Apostle Paul (Acts ix. 3, 20; Gal. i. 12). The consequences might have been fatal to the Apostle, for his life was endangered in this fanatical city. 'In Damascus the governor under Aretas, the king, kept the city of the Damascenes with a garrison, desirous to apprehend me; and through a window in a basket was I let down by the wall, and escaped his hands' (2 Cor. xi. 32-3). (Walch, *Antiquitates Damas. illustratæ*, 1757; Phot. *Bib.* p. 348; Burckhardt, *Arabia*, p. 194; Lamartine, *Travels in the East*; Addison's *Damascus and Palmyra*, ii. 100; Bowring's *Report on Syria*.)—J. R. B.

DAN (דָּן, *a judge*; Sept. Δάν), son of Jacob by the concubine Bilhah (Gen. xxx. 3; xxxv. 25), and founder of one of the tribes of Israel. Dan had but one son, called Hushim (Gen. xlv. 23): notwithstanding which, when the Israelites came out of Egypt, this tribe contained 62,700 adult males (Num. i. 39), which made it the second of the tribes in number, Judah only being above it. Its numbers were less affected in the desert than those of many other tribes; for at the census, before entering Canaan, it mustered 64,400 (Num. xxvi. 43), being an increase of 1700, which gave it still the second rank in population. But there is nothing in the history of the tribe corresponding to this eminence in population: the most remarkable circumstance in its history, however, is connected with this fact. The original settlement assigned to the tribe in south-western Palestine being too small for its large population, a body of them went forth to seek a settlement in the remote north, and seized and remained in permanent occupation of the town and district of Laish, the inhabitants of which dwelt in greater security and were more easily conquered than the neighbours of the tribe in its own proper territory (Josh. xix. 47; Judg. i. 34; xviii.). The district regularly allotted to the tribe, although contracted, was very fertile. It had the country of the Philistines on the west, part of Judah with Benjamin on the east, Ephraim on the north, and Simeon on the south. The territory proved inadequate chiefly from the inability of the Danites to expel the Philistines and Amorites, who occupied parts of the land assigned to them. There is no doubt that the territory as allotted, but not possessed, extended to the Mediterranean through the country of the Philistines. Samson was of this tribe, and its proximity to the Philistines explains many circumstances in the history of that hero. It appears from that history that there was an under-current of private and social intercourse between the Philistines and the Danites, notwithstanding the public enmity between Israel and the former (Judg. xiii.—xvi.).

DAN, the town, anciently called LAISH, or LENHEM, mentioned in the preceding article as having been conquered by a warlike colony of Danites, who named it after their tribe. The terms in which the condition of Laish is described, previously to the conquest, indicate that

the place belonged to the Sidonians, and that the inhabitants lived quiet and secure, 'after the manner of the Sidonians,' enjoying abundance of all things (Judg. xviii. 7). They seem to have derived their security from the absence of any adverse powers in their neighbourhood, and from confidence in the protection of Sidon, which was, however, too far off to render aid in the case of such a sudden assault as that by which they were overpowered. This distance of Sidon was carefully noted by the Danite spies as a circumstance favourable to the enterprise; and it does not appear that Sidon ever made any effort to dispossess the intruders. Dan afterwards became a chief seat of Jeroboam's idolatry, and one of the golden calves was set up there (1 Kings xii. 28, 29). It was conquered, along with other towns, by the Syrians (1 Kings xv. 20); and the name is familiar from the recurrence of the proverbial expression, 'from Dan to Beersheba,' to denote the extent of the Promised Land (Judg. xx. 1; 1 Sam. iii. 20; xvii. 11). [BEERSHEBA.] In the days of Eusebius, Dan was still a small village, which is placed by him four miles from Paneas, towards Tyre. As this distance corresponds to the position of the fountain at Tel el-Kady, which forms one of the sources of the Jordan, and is doubtless that which is called Dan by Josephus (*Antiq.* i. 10. 2), the situation of the city of Dan could not therefore have been that of Paneas itself with which it has been in later times confounded. [CESAREA PHILIPPI.] There are no longer any ruins near the spring at Tel el-Kady, but at about a quarter of an hour north, Burckhardt noticed ruins of ancient habitations; and the hill which overhangs the fountains appears to have been built upon, though nothing is now visible (Burckhardt, *Syria*, p. 42; Robinson, *Researches*, iii. 351-358).

DANCE. The words in the original, rendered in our translation by this term, denote, properly, to leap for joy; and this radical signification, suggesting the idea of abrupt and boisterous gesticulations rather than a series of regular and tasteful movements, seems well to comport with what we may suppose to have been the primitive character of the dance. On the other hand, some writers of great erudition have maintained that no allusions whatever are to be found in the Old Testament history to this kind of bodily exercise; and that in most, if not in all the passages, where, in our version, dancing is mentioned, the etymology of the Hebrew, supported in some places by the strain of the context, seems to point to some kind of musical instrument as being intended by the inspired penmen. Thus, in Exod. xv. 20, where the first notice is taken of dancing, מִנְחֵלָה, coming as it does from מָחַל, 'to pierce' or 'perforate,' and applied naturally enough as the name of any tube that may be blown by the breath, is, according to them, used to describe some instrument of the pipe or flute class, as conjoined with timbrels; and in this interpretation they are supported by the Arabic and Persian versions. But this word, or some derivatives from the same root, occurs in Exod. xxxii. 19; Judg. xvi. 21, 23; 1 Sam. xviii. 5; Jer. xxxi. 4, 13; where dancing alone can be intended. Moreover, in the Septuagint χορός, a dance, is employed in all the passages of the Old Testament just referred to, and in several others; and it is no small collateral proof that

this is the right interpretation, that people in eastern countries are accustomed to mingle the dance with tabrets to this day.

The character of the ancient dance was very different from that of ours, as appears from the conduct of Miriam, who 'took a timbrel in her hand, and all the women went out after her with timbrels and with dances.' Precisely similar is the Oriental dance of the present day, which, accompanied of course with music, is led by the principal person of the company, the rest imitating the steps. The evolutions, as well as the songs, are extemporaneous—not confined to a fixed rule, but varied at the pleasure of the leading dancer; and yet they are generally executed with so much grace, and the time so well kept with the simple notes of the music, that the group of attendants show wonderful address and propriety in following the variations of the leader's feet. The missionary Wolff describes a festival of some Eastern Christians, where one eminent individual, who led the song as well as the dance, conducted through the streets of the city a numerous band of people, who leaped and danced in imitation of the gestures used by him. When the late deputation of the Church of Scotland were on their way through Palestine, their young Arab guides, to relieve the tedium of the journey, sometimes 'commenced a native song and dance; one of them advancing a little before the rest, began the song, dancing forward as he repeated the words; when the rest, following him in regular order, joined in the chorus, keeping time by a simultaneous clapping of hands. They sang several Arabian songs, responding to one another, dancing and clapping their hands.'

At a very early period, dancing was enlisted into the service of religion among the heathen; the dance, enlivened by vocal and instrumental music, was a usual accompaniment in all the processions and festivals of the gods (Strabo, x.); and, indeed, so indispensable was this species of violent merriment, that no ceremonial was considered duly accomplished—no triumph rightly celebrated, without the aid of dancing. The Hebrews, in common with other nations, had their sacred dances, which were performed on their solemn anniversaries, and other occasions of commemorating some special token of the divine goodness and favour, as means of drawing forth, in the liveliest manner, their expressions of joy and thanksgiving. The performers were usually a band of females, who, in cases of public rejoicing, volunteered their services (Exod. xv. 20; Sam. xviii. 6), and who, in the case of religious observances, composed the regular chorus of the temple (Ps. cxlix. 3; cl. 4), although there are not wanting instances of men also joining in the dance on these seasons of religious festivity. Thus David deemed it no way derogatory to his royal dignity to *dance* on the auspicious occasion of the ark being brought up to Jerusalem. The word used to describe his attitude is כִּרְכַר, in the reduplicate form, intimating violent efforts of leaping; and, from the apparent impropriety and indecency of a man advanced in life, above all a king, exhibiting such freaks, with no other covering than a linen ephod, many learned men have declared themselves at a loss to account for so strange a spectacle. It was, unquestionably,

done as an act of religious homage: and when it is remembered that the ancient Asiatics were accustomed, in many of their religious festivals, to throw off their garments even to perfect nudity, as a symbol sometimes of penitence, sometimes of joy, and that this, together with many other observances that bear the stamp of a remote antiquity, was adopted by Mahomet, who has enjined the pilgrims of Mecca to encompass the Kaaba, clothed only with the *ihram*, we may perhaps consider the linen *ephod*, which David put on when he threw off his garments and danced before the ark, to be symbolic of the same objects as the *ihram* of the Mahomedans (see Foster's *Mahomedanism Unveiled*). The conduct of David was imitated by the later Jews, and the dance incorporated among their favourite usages as an appropriate close of the joyous occasion of the feast of Tabernacles. 'The members of the Sanhedrim, the rulers of the synagogues, doctors of schools, and all who were eminent for rank or piety, accompanied the sacred music with their voices: and leaped and danced with torches in their hands, for a great part of the night; while the women and common people looked on.' This strange and riotous kind of festivity was kept up till exhaustion and sleep dismissed them to their homes (Buxtorf, *De Synag. Jud.* cap. 21).

From being exclusively, or at least principally, reserved for occasions of religious worship and festivity, dancing came gradually to be practised in common life on any remarkable seasons of mirth and rejoicing (Jer. xxxi. 4; Ps. xxx. 11). In early times, indeed, those who perverted the exercise from a sacred use to purposes of amusement were considered profane and infamous; and hence Job introduces it as a distinguishing feature in the character of the ungodly rich, that they encouraged a taste for dancing in their families (Job xxi. 11). During the classic ages of Greece and Rome society underwent a complete revolution of sentiment on this subject; inasmuch that the Grecian poets represent the gods themselves as passionately fond of the diversion (Potter's *Grec. Antiq.* ii. 400), and that not only at Rome, but through all the provinces of the empire, it was a favourite pastime, resorted to not only to enliven feasts, but in the celebration of domestic joy (Luke xv. 25; Matt. xiv. 6). Notwithstanding, however, the strong partiality cherished for this inspiring amusement, it was considered beneath the dignity of persons of rank and character to practise it. The well-known words of Cicero, that 'no one dances unless he is either drunk or mad,' express the prevailing sense as to the impropriety of respectable individuals taking part in it; and hence the gay circles of Rome and its provinces derived all their entertainment, as is done in the East to this day, from the exhibitions of professional dancers. Under the patronage of the emperors, and of their luxurious tributaries, like Herod, the art was carried to the utmost perfection, the favourite mode being pantomime, which, like that of the modern Almeas, was often of the most licentious description. A story of love was chosen—generally an adventure of the gods—as the plan of the dance, and the address of the performer consisted in representing, by the waving of his hands, the agility of his limbs, and the innumerable attitudes into which he threw himself, all the various passions of love

jealousy, disgust, that sway the human breast. (See at large Lucian's *Treatise on Dancing*.)

Amateur dancing in high life was, as that writer informs us, by no means uncommon in the voluptuous times of the later emperors. But in the age of Herod it was exceedingly rare and almost unheard of; and therefore the condescension of Salome, who volunteered, in honour of the anniversary of that monarch's birthday, to exhibit her handsome person as she led the mazy dance in the saloons of Machærus—for though she was a child at this time, as some suppose (Michaelis, *Introd.*), she was still a princess—was felt to be a compliment that merited the highest reward. The folly and rashness of Herod in giving her an unlimited promise, great as they were, have been equalled and even surpassed by the munificence which many other Eastern monarchs have lavished upon favourite dancers. Shah Abbas (to mention only one anecdote of the kind), having been on a particular occasion extremely gratified with a woman who danced before him, and being at the time much intoxicated, made her a present of a magnificent khan that yielded him a considerable revenue. Next morning his minister reminded him of his extravagant liberality, whereupon, being now cool and ashamed of his folly, he sent for the dancer, and obliged her to be contented with a sum of money (Thevenot's *Trav. in Persia*, p. 100). It is by no means improbable that Herod, too, was flushed with wine; and that it was from fear he should retract his promise, if she delayed till the morning, that Herodias sent *immediately* for the head of the Baptist.

It remains to notice further that the Jewish dance was performed by the sexes separately. There is no evidence from sacred history that the diversion was promiscuously enjoyed, except it might be at the erection of the deified calf, when, in imitation of the Egyptian festival of Apis, all classes of the Hebrews intermingled in the frantic revelry. In the sacred dances, although both sexes seem to have frequently borne a part in the procession or chorus, they remained in distinct and separate companies (Ps. lxxviii. 25; Jerem. xxxi. 13)—R. J.

DANIEL (דָּנִיֵּאל, i. e. *God is my judge*), a celebrated prophet in the Chaldean and Persian period. There are in the Bible two other persons of the same name: a son of David (1 Chron. iii. 1), and a Levite of the race of Ithamar (Ezra viii. 2; Neh. x. 6). The latter has been confounded with the prophet in the apocryphal Addenda to the Septuagint (Dan. xiv. 1, Sept.), where he is called *ἱερεὺς ὄνομα Δανιήλ υἱὸς Ἀββᾶ* (Hieronym. *Præfat. in Daniel.*).

Daniel was descended from one of the highest families in Judah, if not even of royal blood (Dan. i. 3; comp. Joseph. *Antiq.* x. 10. 1). Jerusalem was thus probably his birth-place, though the passage (Dan. ix. 24) quoted in favour of that opinion, is considered by many commentators as not at all conclusive.

We find the lad Daniel, at the age of twelve or sixteen years, already in Babylon, whither he had been carried together with three other Hebrew youths of rank, Ananiah, Mishael, and Azariah, at the first deportation of the people of Judah in the fourth year of Jehoiakim. He and his companions were obliged to enter the service of the

royal court of Babylon, on which occasion he received the Chaldean name of *Belschatzar* (i. e. *Beli princeps, princeps cui Belus favet*), according to eastern custom when a change takes place in one's condition of life, and more especially if his personal liberty is thereby affected (comp. 2 Kings xxiii. 34; xxiv. 17; Esth. ii. 7; Ezra v. 14).

In this his new career, Daniel received that thorough polish of education which Oriental etiquette renders indispensable in a courtier (comp. iii. 6; Plat. *Alcib.* § 37), and was more especially instructed 'in the writing and speaking Chaldean' (Dan. i. 4), that is, in the dialect peculiar to the Chaldeans [CHALDEE LANGUAGE]. In this dialect were composed all the writings of the ecclesiastical order, containing the substance of all the wisdom and learning of the time, and in the knowledge of which certainly but few favoured laymen were initiated. That Daniel had distinguished himself, and already at an early period acquired renown for high wisdom, piety, and strict observance of the Mosaic law (comp. Ezek. xiv. 14, 20; xxviii. 3; Dan. i. 8-16), is too evident from passages in the truly authentic Scriptures to require any additional support from the ill-warranted Apocryphal stories concerning the delivery of Susannah by the wisdom of the lad Daniel, etc. A proper opportunity of evincing both the acuteness of his mind, and his religious notions, soon presented itself in the custom of the Eastern courts to entertain the officers attached to them from the royal table (Athenæus, iv. 10. p. 145, ed. Casaub.). Daniel was thus exposed to the temptation of partaking of unclean food, and of participating in the idolatrous ceremonies attendant on heathen banquets. His prudent proceedings, wise bearing, and absolute refusal to comply with such customs, were crowned with the Divine blessing, and had the most splendid results.

After the lapse of the three years fixed for his education, Daniel was attached to the court of Nebuchadnezzar, where, by the Divine aid, he succeeded in interpreting a dream of that prince to his satisfaction, by which means—as Joseph of old in Egypt—he rose into high favour with the king, and was entrusted with two important offices—the governorship of the province of Babylon, and the head-inspectorship of the sacerdotal caste (Dan. ii.).

Considerably later in the reign of Nebuchadnezzar, we find Daniel interpreting another dream of the king's, to the effect that, in punishment of his pride, he was to lose, for a time, his throne, but to be again restored to it after his humiliation had been completed (Dan. iv.). Here he displays not only the most touching anxiety, love, loyalty, and concern for his princely benefactor, but also the energy and solemnity becoming his position, pointing out with vigour and power the only course left for the monarch to pursue for his peace and welfare.

Under the unworthy successors of Nebuchadnezzar, Daniel and his deservings seem to have been forgotten, and he was removed from his high posts. His situation at court appears to have been confined to a very inferior office (comp. Dan. viii. 27); neither is it likely that he should have retained his rank as head-inspector of the *order of the magians* in a country where these

were the principal actors in effecting changes in the administration whenever a new succession to the throne took place.

We thus lose sight of Daniel until the first and third year of king Belshazzar (Dan. v. 7, 8), generally understood to have been the last king of Babylon (called by profane writers Nabonnedus), but who—to judge from Dan. v. 11, 13, 18, 22—was, more probably, the son and successor of Nebuchadnezzar, usually called Evil-Merodach, though passing in Daniel by his Chaldean title and rank. After a reign of two years, this monarch was assassinated by his brother-in-law Neriglissar (Berosus in Joseph. *contra Apion.* i. 20). Shortly before this event Daniel was again restored to the royal favour, and became moral preacher to the king, who overwhelmed him with honours and titles in consequence of his being able to read and solve the meaning of a sentence miraculously displayed, which tended to rouse the conscience of the wicked prince.

Under the same king we see Daniel both alarmed and comforted by two remarkable visions (Dan. vii., viii.), which disclosed to him the future course of events, and the ultimate fate of the most powerful empires of the world, but in particular their relations to the kingdom of God, and its development to the great consummation.

After the conquest of Babylon by the united powers of Media and Persia, Daniel seriously busied himself under the short reign (two years) of Darius the Mede or Cyaxares II. with the affairs of his people and their possible return from exile, the term of which was fast approaching, according to the prophecies of Jeremiah. In deep humility and prostration of spirit, he then prayed to the Almighty, in the name of his people, for forgiveness of their sins, and for the Divine mercy in their behalf: and the answering promises he received far exceeded the tenor of his prayer, for the visions of the Seer were extended to the end of time (Dan. ix.).

In a practical point of view also Daniel appeared at that time a highly-favoured instrument of Jehovah. Occupying, as he did, one of the highest posts of honour in the state, the strictness and scrupulousness with which he fulfilled his official duties could not fail to rouse envy and jealousy in the breasts of his colleagues, who well knew how to win the weak monarch, whom they at last induced to issue a decree imposing certain acts, the performance of which, they well knew, was altogether at variance with the creed of which Daniel was a zealous professor. For his disobedience the prophet suffered the penalty specified in the decree: he was thrown into a den of lions, but was miraculously saved by the mercy of God—a circumstance which enhanced his reputation, and again raised him to the highest posts of honour under Darius and Cyrus (Dan. vi.).

He had, at last, the happiness to see his most ardent wishes accomplished—to behold his people restored to their own land. Though his advanced age would not allow him to be among those who returned to Palestine, yet did he never for a moment cease to occupy his mind and heart with his people and their concerns (Dan. x. 12).

In the third year of Cyrus, he had a series of visions, in which he was informed of the minutest details respecting the future history and sufferings of his nation, to the period of their true redemp-

tion through Christ, as also a consolatory notice to himself to proceed calmly and peacefully to the end of his days, and then await patiently the resurrection of the dead at the end of time.

From that period the accounts respecting him are vague, sometimes confused, and even strange; and we hardly need mention the various fables which report his death to have taken place in Palestine, Babylon, or Susa.—H. A. C. H.

DANIEL, BOOK OF. This important and in many respects remarkable book takes its name not only from the principal person in it, but also and chiefly from him as its real author; there being no doubt whatever that, as the book itself testifies, it was composed by Daniel (comp. vii. 1, 28; viii. 2; ix. 2). It occupies, however, but a third rank in the Hebrew canon; not among the *Prophets*, but in the *Hagiographa*, owing, no doubt, to the correct view of the composers of the canon, that Daniel did not exercise his prophetic office in the more restricted and proper sense of the term 'prophecy'; but stood to the theocracy in a different relation from those real prophets whose calling and profession consisted exclusively in declaring the messages they received, and in the communion which they held with God. These latter are termed, in the ancient Hebrew idiom, נְבִיאִים, *prophets*, in contradistinction to מְשִׁנֵּי, *seers*, who, though they were equally favoured with divine revelations, were nevertheless not prophets by profession, a calling that claimed the entire service of a man's whole life.

The book of Daniel divides itself into two parts, *historical* (ch. i.-vi.) and *prophetic* (ch. vii.-xii.), arranged respectively in chronological order. Its object is by no means to give a summary historical account of the period of the exile, or of the life of Daniel himself, since it contains only a few isolated points both as to historical facts and prophetic revelations. But the plan or tendency which so consistently runs through the whole book, is of a far different character; it is to show the extraordinary and wonderful means which the Lord made use of, in a period of the deepest misery, when the theocracy seemed dissolved and fast approaching its extinction, to afford assistance to his people, proving to them that he had not entirely forsaken them, and making them sensible of the fact, that His merciful presence still continued to dwell with them, even without the Temple and beyond the Land of Promise. In this way alone was it possible to render the time of punishment also a period of rich blessing. The manifestations of the Lord to that effect consisted, among others, of the wonders recorded in this book, and the glorious prophecies of the seer. The book thus sets forth a series of miraculous tokens, by which God proclaimed amidst the heathen world, and in a period of abject degradation, that Israel was still his people, the nation of his covenant, still marching steadily onward to the goal marked out for them by the Lord.

The wonders related in Daniel (ch. i.-vi.) are thus mostly of a peculiar, prominent, and striking character, and resemble in many respects those performed of old time in Egypt. Their divine tendency was, on the one hand, to lead the heathen power, which proudly fancied itself to be the conqueror of the theocracy, to the acknowledgment that there was an essential difference between the

world and the kingdom of God ; and, on the other, to impress degenerate and callous Israel with the full conviction, that the power of God was still the same as it was of old in Egypt.

Neither do the prophecies contained in the book (ch. vii.-xii.) bear a less peculiar and striking character. We cannot, indeed, fail to discover in the writer, to a very great extent, a person of vast information, and well-versed in the management of political affairs, these prophecies having for their object—more than any other in the Old Testament—the political vicissitudes of the empires of the world. Nor are we less reminded of Daniel's domicile in Chaldæa, by the colouring imparted to his visions, by their symbols, and more especially by those drawn from beasts (Dan. vii. 8), the grotesque manner in which the figures are put together, and the colossal majesty imprinted on those sketches. All these peculiarities belong to the *individuality* of the prophet himself, which is conspicuous even in the accounts he gives of the revelations imparted to him, though that individuality is then greatly modified by the sanctified, exalted, and glorified state of his mind.

The language of the book is partly Chaldæan (ii. 4 ; vii. 28) and partly Hebrew. The latter is not unlike that of Ezekiel, though less impure and corrupt, and not so replete with anomalous grammatical forms. The Chaldæan is noways that of the Chaldæans *proper*, but a corrupt vernacular dialect, a mixture of Hebrew and Aramaic, formed during the period of the exile. It resembles mostly the Chaldæan pieces in Ezra, but differs greatly from the dialect of the later Targums.

The style is, even in the prophetic parts, more prosaic than poetical, as Lowth has already observed : 'Totum Danielis Librum e Poeticorum cœnu excludo.' The historical descriptions are usually very broad and prolix in details ; but the prophecies have a more rhetorical character, and their delivery is frequently somewhat abrupt ; their style is descriptive, painting with the most lively colours the still fresh impression which the vision has made on the mental eye.

The following are the essential features of the prophetic tenor of the book of Daniel, while the visions in ch. ii. and vii., together with their different symbols, may be considered as embodying the leading notion of the whole. The development of the whole of the heathen power, until the completion and glorification of the kingdom of God, appeared to the prophet in the shape of four powers of the world, each successive power always surpassing the preceding in might and strength, namely, the Babylonian, Medo-Persian, Greek, and Roman. The kingdom of God proves itself conqueror of them all ; a power which alone is everlasting, and showing itself in its utmost glorification in the appearance of the Messiah, as Judge and Lord of the world. Until the coming of the Messiah, the people of God have yet to go through a period of heavy trials. That period is particularly described, ch. viii. and xi., in the struggles of the Maccabæan time, illustrative of the last and heaviest combats which the kingdom of God would have to endure. The period until the appearance of the Messiah is a fixed and sacred number : seventy weeks of years (ch. ix.). After the lapse of that period ensues the death of the Messiah ; the expiation of the people is realised ; true justice

is revealed, but Jerusalem and the Temple are in punishment given up to destruction. The true rise from this fall and corruption ensues only at the end of time, in the general resurrection (ch. xii.).

The *unity* of the book has been disputed by several critics, and more especially by Eichhorn and Bertholdt, who conceived it to have been written by more than one author, on account of some contradictions which they thought they had discovered in it, such as in i. 21, compared with x. 1 ; and in i. 5-18, compared with ii. 1. With regard to the first supposed contradiction, we consider the meaning of i. 21 to be, that Daniel had lived to see the first year of the reign of Cyrus, as a particularly memorable, and, for the exiled people, a very important year. This does by no means exclude the possibility of his having lived still longer than up to that period.

Respecting the second presumed contradiction, the matter in ch. i. 5-18 belongs properly to the co-regency of Nebuchadnezzar, which term is there added to his period of government, while in ch. ii. 1 his reign is counted only from the year of his actual accession to the throne. These attempts to disturb the harmony of the work are also discountenanced by the connecting thread which evidently runs through the whole of the book, setting the single parts continually in mutual relation to each other. Indeed, most critics have now given up that hypothesis, and look at the book as a closely connected and complete work in itself.

Much greater is the difference of opinion respecting the *authenticity* of the book. The oldest known opponent of it is the heathen philosopher Porphyry, in the third century of the Christian era. The greater the authority in which the book of Daniel was held at that time by both Jews and Christians in their various controversies, the more was he anxious to dispute that authority, and he did not disdain to devote one whole book (the twelfth)—out of the fifteen which he had composed against the Christians—to that subject alone. He there maintains that the author of the book of Daniel was a Palestine Jew of the time of Antiochus Epiphanes, that he wrote it in Greek, and fraudulently gave to *past* events the form of prophecies. Porphyry has been answered by Eusebius of Cæsarea, Methodius of Tyre, and Apollinarius of Laodicea. But their works, as well as that of Porphyry himself, are lost ; and we know the latter only from the numerous quotations and refutations in the Commentary of Jerome.

Porphyry found no successor in his views until the time of the English deists, when Collins attempted to attack the authenticity of Daniel, as was done by Semler in Germany. After this a few critics, such as J. D. Michaelis and Eichhorn, disputed the authenticity of the six first chapters. The learned Swiss, Corrodi, went still farther, and, reviving the views of Porphyry, questioned the genuineness of the *whole* book. The strongest, most elaborate, and erudite attacks against the book, came from the pens of Bertholdt, Bleck, De Wette, Lengerke, and others. But there have also not been wanting voices in its defence, such as those of Lüdewald, Stäudlin, Jahn, Lack, Steudel, Hengstenberg, Hävernick, and others.

The arguments advanced against the genuine character of Daniel are more directed against the *internal* than *external* evidence of the work.

The wonders and prophecies recorded in it are always the foremost stumbling-block, and much objection is made to them. The contents of the historical part is declared to be fictitious and replete with improbabilities—nay, even with historical inaccuracies; such as the sketches regarding the relations of the sacerdotal order, the sages and astrologers (ii. 2; iv. 7; v. 7-15), the mention of Darius the Mede (vi. 1; ix. 1; xi. 1), and the regulations concerning the satraps (iii. 3; vi. 2, &c.).

In the prophetic part, particular objection is taken to the apocalyptic character of the book, by which it differs from all the other books of the Prophets. Not less suspicious, in their eyes, is the circumstance that all the accounts in it relating to very remote future events, and the fate of empires which had not then yet risen into existence, are described in so positive and exact a manner, and with so much circumstantial detail, even to the very *date* of their occurrence. Yet, as this does not extend farther than the time of Antiochus Epiphanes, it will naturally lead to the conclusion of 'vaticinia post eventum.' Other objections against the genuineness of the book are, that Daniel is frequently spoken of in it in high terms of respect and honour (i. 17, 19, sq.; v. 11, sq.; vi. 4; ix. 23; x. 11, &c.); that the language, both Hebrew and Chaldean, is very corrupt, and that the Greek words occurring in them (iii. 5, 7, 10) naturally betray the book to have been written in a later age, at least the Alexandrian, when Greek words began to be introduced into Asia; that the doctrines in the book, the Angelology (iv. 14; ix. 21; x. 13, 21), Christology (vii. 13, sq.; xii. 1, sq.), the ascetic discipline (i. 8, sq.), also betray a later age; that the book stands in the canon in the Hagiographa, a proof that it had become known only *after* the collection of the Prophets had been completed; a suspicion which is still more strengthened by the circumstance that the name of Daniel is wanting in the book of Sirach, ch. xlix., probably because the book of Daniel did not then exist.

These few objections have been variously met and confuted. They rest, to a great extent, partly on historical errors, partly on the want of a sound exegesis, and, lastly, on the perversion of a few passages in the text. Thus it has turned out that several of the arguments have led to a far different and even opposite result from what was originally meant, namely, to the *defence* of the authenticity of the book. The existence, *ex. gr.*, of a king Darius of the Medians, mentioned in ch. vi., is a thorough historical fact; and the very circumstance that such an insignificant prince, eclipsed as his name was by the splendour of Cyrus, and therefore unnoticed in the fabulous and historical chronicles of Persia, should be known and mentioned in this book, is in itself a proof of the high historical authority of Daniel. Nor does the whole dogmatic tenor of the book speak less in favour of its genuineness, since the dogmatic spirit of the Maccabæan period is essentially different from that which it exhibits, as, *ex. gr.*, in the Christology, which forms the substance and basis of Daniel,

The following are the more important of the arguments which evidence the genuineness of the book.

1. The existence and authority of the book are most decidedly testified by the New Testament. Christ himself refers to it (Matt. xxiv. 15), and gives himself (in virtue of the expression in Dan. vii. 13) the name of *Son of Man*; while the Apostles repeatedly appeal to it as an authority (*ex. gr.*, 1 Cor. vi. 2; 2 Thess. ii. 3; Heb. xi. 33, sq.). To the objection that Christ and the writers of the New Testament are here no *real* authority, inasmuch as they accommodate themselves to the Jewish notions and views, we reply that the genuineness of the book of Daniel is so closely connected with the truth of its contents—in other words, that the *authenticity* of the book is so immediately connected with its *authority*—that it is impossible to doubt the *genuineness*, without suspecting at the same time a wilful fraud and cheat in its contents; so that the *accommodation* in this case to national views would be tantamount to wilfully confirming and sanctioning an unpardonable fraud.

2. The period of the exile would be altogether incomprehensible without the existence of a man like Daniel, exercising great influence upon his own people, and whose return to Palestine was effected by means of his high station in the state, as well as through the peculiar assistance of God with which he was favoured. Without this assumption, it is impossible to explain the continued state of independence of the people of God during that period, or to account for the interest which Cyrus took in their affairs. The exile and its termination are indicative of uncommon acts of God towards highly-gifted and favoured men; and the appearance of such a man as Daniel is described in that book to have been, is an indispensable requisite for the right understanding of this portion of the Jewish history.

3. An important hint of the existence of the book in the time of Alexander is found in Josephus, *Antiq.*, xi. 8, 4, according to which the prophecies of Daniel had been pointed out to that king on his entrance into Jerusalem. It is true that the fact may have been somewhat embellished in its details by Josephus; yet is it historically undeniable that Alexander did bestow great favours on the Jews, a circumstance which is not easily explained without granting the fact recorded by Josephus to be true in the main.

4. The first book of the Maccabees, which is almost contemporary with the events related in it, not only pre-supposes the existence of the book of Daniel, but actually betrays acquaintance with the Alexandrian version of the same (1 Macc. i. 54; comp. Dan. ix. 27; ii. 59; comp. Dan. iii.)—a proof that the book must have been written long before that period.

5. If the book had been written in the Maccabæan period, there would probably have been produced in that period some similar prophetic and apocalyptic productions, composed by Palestine Jews. Of such, however, not the slightest notice can anywhere be found; so that our book—if of the Maccabæan time—thus forms an isolated enigmatic phenomenon in the later Jewish literature.

6. The reception of the book into the canon is also an evidence of its authenticity. In the Maccabæan age the canon had long been completed and closed; but even doubting that point, it is not likely that, at a time when so much scrupulous adherence was shown towards all that was hallowed by time and *old* usage, and when Scriptural literature was already flourishing—it is not probable, we say, that a production then recent should have been raised to the rank of a canonical book.

7. We have an important testimony for the authenticity of the book in Ezekiel xiv. 14, 20; xxviii. 3. Daniel is there represented as an unusual character, as a model of justice and wisdom, to whom had been allotted superior divine insight and revelation. This sketch perfectly agrees with that contained in our book.

8. The book betrays such an intimate acquaintance with Chaldean manners, customs, history, and religion, as none but a contemporary writer could fairly be supposed to possess. Thus, *ex. gr.*, the description of the Chaldean magians and their regulations perfectly agrees with the accounts of the classics respecting them. The account of the illness and insanity of Nebuchadnezzar is confirmed by Berosus (in Joseph. *c. Apion.* i. 20). The edict of Darius the Mede (Dan. v.) may be satisfactorily explained from the notions peculiar to the Medo-Persian religion, and the importance attached in it to the king, who was considered as a sort of incarnate deity.

9. The religious views, the ardent belief in the Messiah, the purity of that belief, the absence of all the notions and ceremonial practices of later Judaism, &c., the agreement of the book in these respects with the genuine prophetic books, and more especially with the prophets in and after the exile,—all this testifies to the genuineness of Daniel.

10. The linguistic character of the book is most decisive for its authenticity. In the first instance, the language in it, by turns Hebrew and Aramaean, is particularly remarkable. In that respect, the book bears a close analogy to that of Ezra. The author must certainly have been equally conversant with both languages—an attainment exactly suited to a Hebrew living in the exile, but not in the least so to an author in the Maccabæan age, when the Hebrew had long since ceased to be a living language, and had been supplanted by the Aramaean vernacular dialect. The Hebrew in Daniel bears, moreover, a very great affinity to that in the other later books of the Old Testament; and has, in particular, idioms in common with Ezekiel. The Aramaic, also, in the book differs materially from the prevailing dialect of the later Chaldean paraphrastic versions of the Old Testament, and has much more relation to the idiom of the book of Ezra.

With regard to the OLD VERSIONS of the book of Daniel, we must in the first place observe that there is not extant, or even known ever to have existed, any Chaldean paraphrase (Targum) of Daniel, any more than of Ezra. The reason of this lies, no doubt, in the scrupulosity of the later Jews, who believed that the Chaldean version of the two books might afterwards easily be confounded with the original texts, and thus prove injurious to the pure preservation of the latter. There is something peculiar and remarkable in

the Alexandrian version of the canonical book of Daniel. Not only has it taken liberties with regard to single expressions and sentences, but has actually dared to re-model the text altogether in ch. iii-vi., either by numerous additions (as iii. 24, sq., the prayer of Azariah; iii. 51, sq., the song of the Three Children), or by omissions and deviations. There are, besides, two great supplements to that version—the story of Susannah (xiii.), and of Bel and the Dragon in Babel (xiv.). Both apocryphal stories were originally written in Greek; a conclusion drawn already by Porphyry from the quibbles in xiii. 54, 55, 58, 59, who at the same time derided the Christians for considering those stories as genuine writings of Daniel. The authenticity of the two stories was, however, already before him questioned by the fathers of the church; and a very interesting discussion took place between Origen and Julius Africanus regarding the authenticity of the story of Susannah. Jerome condemns the two stories in plain terms as fables, and as additions not belonging to the Hebrew text. Some erroneously assume that, besides our canonical text, there also existed a sort of critical revision of the former in the Chaldean language, which the Seventy had consulted in their translation. But the mistakes in the translation, which are brought forward in favour of that view, cannot stand a strict criticism, while the above-named peculiarities may be satisfactorily explained from the character of that translation itself. It plainly shows that the writers had endeavoured themselves to furnish a collection of legends, and a peculiar re-cast of the book, in accordance with the spirit of the age and the taste of Judaism then prevailing at Alexandria. The wonderful character of the book, and the many obscure and enigmatic accounts in it, were the rocks on which the fanciful, speculative, and refining minds of the Alexandrians ran foul. No book was ever more favourable to the intermixture of legends, disfigurations, and misconceptions of all sorts, than Daniel; while the period of the exile was generally a favourite topic for the fantastical embellishments of the Alexandrian Jews. In like manner may also be explained the mutilations which the books of Esther and Jeremiah have received at the hands of the Alexandrians, to whom hermeneutic scruples were of but little moment. The more important the book of Daniel was to the Christian church, and the more arbitrary the re-modelled Sept. version of it was, the more conceivable is it why in the old church the version of Theodotion became more general than that of the Sept. It is true that some of the fathers still made use of the Alexandrian version; but, in the time of Jerome, Theodotion was already read in nearly all the churches; and that this custom had been introduced long before him is evident from the circumstance that Jerome was ignorant of the historical principles by which the church was guided in adopting that version. For a long time it was believed that the version of the Seventy had been lost, until it was discovered at Rome, in the latter half of the last century, in the codex Chisianus. It was published at Rome, 1772, in folio, from the MS. copy of Blanchini, with a translation by P. de Magistris, which edition is, however, very defective and incorrect, though it was afterwards repeatedly re-published. The version of Theodotion, generally

published together with that of the Septuagint, of which it is a revision, is upon the whole literal and correct. In the present copies of Theodotion, however, are already found the apocryphal interpolations and additions of the Sept. This is owing to the fact that Theodotion's version has in later times been re-modelled, interpolated, and falsified after that of the Seventy, so that it would now be altogether an idle task to attempt to restore the original text of Theodotion. A very useful guide for the criticism of the Greek versions, is the Syriac Hexaplarian version, published by Buggati, at Milan, in 1788. The Arabic Polyglott version is an offspring of Theodotion's, which it follows with literal exactness.

The Syriac version in the Peshito does some good service in explaining the words in Daniel, but is, nevertheless, not free from gross mistakes. The apocryphal parts it has copied from the later interpolated Theodotion. The Vulgate also has these additions translated after Theodotion.

The most important commentators on Daniel are, among the fathers, Ephræm Syrus, Jerome, Theodoret; among the rabbins, Jarchi, Kimchi, Abenezra, Joseph Jacchiades; among the Protestant theologians, Melancthon, Calvin, Martin Geier, de Dieu, Venema, Chr. Bened. Michaelis, J. D. Michaelis. In more recent times, critical works on Daniel have appeared by Bertholdt (1806), Rosenmüller (1832), Hävernick (1832), Lengerke (1835), Maurer (1836). In English there are many works on the prophecies and visions of Daniel, but those which take the character of commentaries are, the *Six-fold Commentary* by Willet (1610); the *Translation and Commentary* by Hugh Broughton (1611); the *Improved Version* by Wintle (1807).—H. A. C. H.

DANIEL, Apocryphal Addenda to [DEUTERO-CANONICAL]. In the version of the Seventy, and that of Theodotion, are found some considerable additions to the book of Daniel which are wanting in the Hebrew canon. These are,

1. The Prayer of Azarias, &c. (Dan. iii. 24-51);
 2. The Song of the Three Children (Dan. iii. 52-90, *i. e.* according to Robert Stephen's division into verses, which has been adopted into the Latin Vulgate). [VERSES].
 3. The History of Susanna (Dan. xiii.).
 4. The Narrative of Bel and the Dragon (Dan. xiv.).
- These are in our Authorized English Bible printed separately, and numbered accordingly, the Prayer of Azarias and the Song of the Three Children making sixty-eight verses.

St. Jerome, who translated these together with the canonical parts of the book of Daniel from the Greek version of Theodotion, observes: 'Daniel, as received among the Hebrews, contains neither the History of Susanna, nor the Hymn of the Three Children, nor the Fables of Bel and the Dragon, all of which, as they are dispersed throughout the world, we have added, lest to the ignorant we should seem to have cut off a considerable part of the book, transfixing them at the same time with a dagger (*veru anteposito, easque jugulante*).'*

* This Latin phrase is translated by the American editors of Jahn's *Introduction* thus: 'but we have given the precedence in order, to that part which is true, and evinces the falsity of these.' They evidently mistake the word *veru*, an obelisk or dagger, [† for *vero*.

Jerome gives us the following account of these additions to the Hebrew text:—'We ought to know that Porphyry, attacking the authenticity of the book of Daniel, maintains that it is a forgery unknown to the Hebrews, and entirely of Greek origin, inasmuch as in the story of Susanna (*fabulâ Susannæ*), Daniel says to the elders, in allusion to the word *σχίσις* (*lentiscus* or a mastich tree), *σκισει σε*, &c., and to the word *πίπρον* (*ilex*, a holm), *πίπρω σε*, which etymological allusion is Greek and not Hebrew. To whom both Eusebius and Apollinarius, with one voice, replied, that the fables of Bel and the Dragon are not contained in the Hebrew, but that they are part of the prophecy of Habakkuk, son of Joshua, of the tribe of Levi, as is stated in the Septuagint Version in the title to this same fable of Bel.' . . . 'Therefore, when I translated Daniel many years ago, I marked these visions with an obelus, in order to intimate that they are not in the Hebrew, and I am not a little surprised that certain fault-finders are offended with me, as if I had curtailed the book, for both Origen, Eusebius, Apollinarius, and other churchmen and Greek doctors, confess, as I have said, that these visions are not in the Hebrew.' And again—'I heard one of the Jewish teachers, deriding the history of Susanna, and asserting it to be the fable of some Greek, make the same objection which was made to Origen by Africanus, namely, that the etymological paronomasia between *σχίσις* and *σκισει*, *πίπρον* and *πίπρω*, was derived from the Greek language. The objection may be rendered intelligible to those acquainted only with the Latin language, by supposing that from the answer of one elder *under an ilex tree* (*sub ilice*), Daniel had taken occasion to say to him, *illicio* pears, and that to the answer of the others *under a lentisk-tree* (*sub lentisco*), the reply had been, *in lente* to comminuat angelus, or, *non lente* pears, or *lentus*, *id est flexibilis, ducaris ad mortem*.'

Eusebius and the others who replied to Porphyry, maintained that Daniel the prophet was a different person from the Daniel of the Seventy, which commences with the words, 'There was a certain priest, named Daniel, son of Abdias, who ate at the table of the king of Babylon.'

The other objections made by the Jewish teacher to St. Jerome consisted in his ridiculing the idea of the three youths in the fiery furnace having leisure to compose a metrical hymn; in asking what miracle or mark of inspiration it was in Daniel to kill a serpent with a cake of pitch, or to detect the frauds of the priests of Bel, such sagacity being rather the effect of common prudence than of a prophetic spirit. But his chief objection referred to the idea of Habakkuk (*ver. 36*) being carried by an angel through the air to Babylon, with regard to which he challenged him to show a similar miracle recorded in the Scriptures; and when a young man present adduced the case of Ezekiel, he at once pointed out that this is said to have taken place in the *spirit*; and Jerome observes that he did not venture to refer to St. Paul, who would not say of himself whether he was rapt up in the spirit or in the body. This Jew endeavoured to maintain by such arguments the apocryphal character of these portions of Daniel. Jerome further observes that the history of Susanna is considered

by nearly all the Hebrews as a fable; and that it is not read in the synagogues: for who, say they, could believe that captives had the power of starving their princes and judges? (*Præf. ad Daniëlem*).

The subject of the Prayer of Azarias, and of the Song of the three youths, Azarias, Ananias, and Misael (the Hebrew names of Shadrach, Meshach, and Abed-nego), consists in a petition for deliverance from the furnace, and a hymn of thanksgiving, on the part of the young men, for their preservation in the midst of the flames. De Wette (*Lehrbuch*) conceives that the Prayer and the Hymn betray marks of two different authors (*Dan.* iii. 38; comp. with 53, 55, 84, 85, Stephen's *Division*), and that the latter has the appearance of being written with a liturgical object. Certain it is that, from a very early period, it formed part of the church service (see Rufinus, in *Symbol. Apost.*, who observes that this hymn was then sung throughout the whole church); and Athanasius (*De virginitate*); it is one of the canticles still sung on all festivals in the Roman, and retained in the daily service of the Anglican church. In its metrical arrangement it resembles some of the ancient Hebrew compositions. De Wette adduces (*loc. cit.*) several proofs from the style to show that it had a Chaldee original, and had undergone the labours of various hands. It is maintained by those who contend for the divine authority of this Hymn that the context requires its insertion, as without it there would be an evident hiatus in the narrative (*Dan.* iii. 23). 'Then these men, Shadrach, Meshach, and Abed-nego, fell down bound into the midst of the burning fiery furnace,' after which, we find immediately (*ver.* 24, *Heb.*) 'then Nebuchadnezzar was astonished,' &c. The cause of this astonishment is said to be supplied by the Greek translation,—'And they walked in the midst of the fire praising God, and blessing the Lord (*ver.* 1, *Auth. Vers. Apocr.*) . . . but the angel of the Lord came down into the oven,' &c. (*ver.* 27). But this addition seems by no means necessary in order to account for Nebuchadnezzar's astonishment, as the cause of it is given in Daniel, *ver.* 92 (*ver.* 25 in the *Heb.* and *Auth. Vers.*).

The *History of Susanna* is probably a moral parable, founded perhaps on some fact, and affording a beautiful lesson of chastity.

The object of the Jewish author of the history of the destruction of *Bel* and the *Dragon* was, according to Jahn, 'to warn against the sin of idolatry some of his brethren, who had embraced Egyptian superstitions. The book was, therefore, well adapted to the time, and shows that philosophy was not sufficient to keep men from apostatising into the most absurd and degrading superstitions.' The time of the writing Jahn ascribes to the age of the Ptolemies, when serpents were still worshipped at Thebes.

Among the difficulties attending these Deutero-canonical portions of Daniel, Jahn enumerates the denominating Daniel a priest (*xiv.* 1), which he conceives to be a confounding of Daniel the prophet with Daniel the priest (*Ezra* vii. 2; *Neh.* x. 7); the order of the king to destroy the idol of *Bel*, and the assertion that serpents were worshipped at *Babylon*; but he conceives all these difficulties to be removed by regarding the whole as a

parable, pointing out the vanity of idols, and the impostures of the priests. We are informed by Herodotus that the temple of *Bel* was destroyed by Xerxes.

De Wette (*Lehrbuch*), while he points out some Hebraisms in *Susannah*, considers the etymological allusions already noticed as decisive of its having been originally written in Greek. *Bel* and the *Dragon* has no marks whatever of any other than a Greek original. It is no doubt remarkable that we should have a version of the deuterocanonical as well as of the canonical portions of Daniel, from Theodotion as well as from the Seventy. This is accounted for by supposing that Theodotion only altered and corrected the version of the Seventy in these parts. The discrepancies are very great between these two versions, so much so, as almost in some instances to give the appearance of a different narration. It is well known that so early as the second century the Septuagint version of Daniel was superseded by that of Theodotion, and that it was supposed the former had been lost, until it was discovered in Rome, and published in 1772. De Wette considers the deuterocanonical portions to be interpolations in Theodotion's translation. These additions are also found in the Syriac and old Latin versions.

Professor Alber of Pesth (who contends against Jahn for the historic truth of these narratives), in reference to the term *fables* bestowed by Jerome on some of the deuterocanonical portions of the book of Daniel, endeavours to maintain, from the fact of Jerome having used the word *fabula* (*a fando*) of a true narrative, 'Tibi fabulam referam, quæ infantia meæ temporibus accidit;' that he employs it here in the same sense; but it is evident from the whole context (in which he had been already speaking of *apocryphal fables*), that Jerome, who also applies these Greek additions to the book of Daniel, contrasts them with the authority of the canonical Scriptures, 'nec se debere respondere Porphyrio, pro his quæ nullam Scripturæ sacræ auctoritatem habeant.' (*Præf. ad Daniëlem*.) Jerome, however, observes, that with a due regard to the order of time, Theodotion had placed the history of *Susannah* at the head of the book of Daniel, and it is thus placed in the *Cod. Alex.*, &c.

Bel and the *Dragon* is read in the Roman office on Ash-Wednesday, and in the Church of England on the 23rd of November. *Susanna* is read in the Anglican Church on the 22nd of November, and in the Roman on the vigil of the fourth Sunday in Lent.

We shall conclude with the following observation of Erasmus. 'It is astonishing that what Jerome stabbed with his dagger is now everywhere read and sung in the churches; nay, we read, without any mark of distinction, what Jerome did not fear to call a fable, the history of *Bel* and the *Dragon*, and which he would not have added, had he not been apprehensive of seeming to have cut off a considerable portion of the sacred volume. But to whom did he fear to seem to do so? To the ignorant, as he himself observes. Of so much more weight to the ignorant multitude is custom, than the judgment of the learned!' (*Schol. super Præf. Hieron. in Daniël.*) And again, 'Whether the church receives these books

with the same authority as the others, the spirit of the church knoweth.' (*De Symbol. et Decalog.*)

W. W.

DAR (77). This word occurs in Esth. i. 6, as the name of one of the stones in the pavement of the magnificent hall in which Ahasuerus feasted the princes of his empire. This would suggest that it must have denoted a kind of marble. Some take it to signify Parian marble, others white marble; but nothing certain is known about it. In Arabic, the word *dar* signifies a large pearl. Now pearls were certainly employed by the ancients in decorating the walls of apartments in royal palaces; but that pearls were also used in the pavements of even regal dining-rooms is improbable in itself, and unsupported by any known example. The Septuagint refers the Hebrew word to a stone resembling pearls (*πυρίνου λίθου*); by which, as J. D. Michaelis conjectures, it intends to denote the *Alabastrites* of Pliny (*Hist. Nat.* xxxvi. 7, 8), which is a kind of alabaster with the gloss of mother-of-pearl [ALABASTER].

DARCONIM. [ADARCONIM.]

DARICS. [ADARCONIM.]

DARIUS, or rather DARJAVESH (דָּרְיָוֶשׁ), is the name under which three Medo-Persian kings are mentioned in the Old Testament. The original form of the name, to which the Hebrew and Greek words are only approximations, has been read by Grotend, in the cuneiform inscriptions of Persepolis, as Darheush, or Darjeush (Heeren's *Ideen*, i. 2. p. 350). Herodotus assigns to the name the sense of *ἐργίης*, or, according to another reading, *ἐρξείης* (vi. 98); the former meaning *coercitor*, the latter *man of great achievements*. The former accords with *holding fast*, which is the sense of *Dārā*, the modern Persian name of Darius.

The first Darius is 'Darjavesch, the son of Achashverosh, of the seed of the Medes,' in the book of Daniel (ix. 1). Much difference of opinion has prevailed as to the person here intended; but a strict attention to what is either actually expressed in, or fairly deduced from, the terms used in that prophet, tends to narrow the field for conjecture very considerably, if it does not decide the question. It appears, namely, from the passages in ch. v. 30, 31; vi. 28, that Darjavesch, the Mede, obtained the dominion over Babylon on the death of Belshazzar, who was the last Chaldean king, and that he was the immediate predecessor of Koresh (Cyrus) in the sovereignty. The historical juncture here defined belongs, therefore, to the period when the Medo-Persian army, led by Cyrus, took Babylon (A.D. 538); and Darjavesch, the Mede, must denote the first king of a foreign dynasty, who assumed the dominion over the Babylonian empire, before Cyrus. These indications all concur in the person of Cyaxares the Second, the son and successor of Astyages [AHASUERUS], and the immediate predecessor of Cyrus. It may be objected to this view that Herodotus, Ctesias, and other pagan historians who perhaps chiefly rely on their authority, make no mention of any such person. But, it may be answered, Xenophon states that Astyages did have a son of that name who succeeded him; by describing him as a prince given up to sensuality, he explains how he came to surrender all autho-

riety so entirely into the hands of his enterprising son-in-law and nephew Cyrus, that his reign was naturally sunk in that of his distinguished successor; and he dates the commencement of the reign of Cyrus from the death of this Cyaxares (*Cyrop.* i. 5; viii. 7). Moreover, a passage in Æschylus (*Persæ*, 763-5), seems to bear an obscure but intelligible testimony to the same account. Josephus also, when speaking of the same person, whom he calls Darius, adds, 'He was the son of Astyages, but was known to the Greeks by another name' (*Antiq.* x. 11). Lastly, an important chronological difficulty is best adjusted by assuming the existence and reign of this Cyaxares, as is shown in Clinton's *Fasti Hellenici*, p. 301, sq. Bertholdt has written a satisfactory 'Excurs über den Darius Medus' in his *Commentary on Daniel*.

The second 'Darjavesch king of Persia' is mentioned in the book of Ezra (iv.-vii.) in Haggai, and in Zechariah, as the king who, in the second year of his reign, effected the execution of those decrees of Cyrus which granted the Jews the liberty to rebuild the temple, the fulfilment of which had been obstructed by the malicious representations which their enemies had made to the immediate successors of Cyrus. It is agreed that this prince was Darius Hystaspis, who succeeded the usurper Smerdis B.C. 521, and reigned thirty-six years. For some arguments to show that he is not mentioned in the Old Testament by any other name than that of Darjavesch, see the article AHASUERUS.

The third, 'Darjavesch the Persian,' occurs in Neh. xii. 22, in a passage which merely states that the succession of priests was registered up to his reign. The question as to the person here intended bears chiefly on the authorship of the passage. It may be briefly stated thus:—If, as is more commonly believed, this king be Darius Nothus, who came to the throne (B.C. 423), and reigned nineteen years, we must (assuming that the Jaddua here mentioned is the high-priest who went out to meet Alexander the Great on his entry into Jerusalem; Josephus, *Antiq.* xi. 8) conceive, either that Jaddua reached an age exceeding a century—for so long he must have lived, if he was already high-priest in the reign of Darius Nothus, and saw Alexander's entry; or that the Jaddua of Nehemiah and of Josephus are not the same person. Carpov has tried to show, from this very chapter, that the Jaddua of ver. 22 was a Levite, and not the high-priest (*Introduct. ad Libr. Vet. Test.* p. 347). If, on the other hand, this king be Darius Codomannus, who came to the throne B.C. 336, and reigned four years, then we must either assume that Nehemiah himself attained the age of 130 years at least, or that this passage is an interpolation by a later hand (Bertholdt, *Einleit.* iii. 1031).

Darius Codomannus is evidently the Persian king alluded to in 1 Macc. i. 1.—J. N.

DARKNESS. In the Gospels of Matthew (xxvii. 45) and Luke (xxiii. 44) we read that, while Jesus hung upon the cross, "from the sixth hour there was darkness over all the land unto the ninth hour." Most of the ancient commentators believed that this darkness extended to the whole world. But their arguments are now seldom regarded as satisfactory, and their proofs

even less so. Of the latter the strongest is the mention of an eclipse of the sun, which is referred to this time by Phlegon Trallianus, and, after him, by Thallus, ap. Africanum. But even an eclipse of the sun could not be visible to the whole world; and neither of these writers names the place of the eclipse. Some think it was Rome; but it is impossible that an eclipse could have happened from the sixth to the ninth hour both at Rome and Jerusalem. It is, therefore, highly probable that the statement of Phlegon, which in the course of time has come to be quoted as independent authority, was taken from the relation of the Christians or from the Scriptures. That the darkness could not have proceeded from an eclipse of the sun is further placed beyond all doubt by the fact that, it being then the time of the Passover, the moon was at the full. This darkness may therefore be ascribed to an extraordinary and preternatural obscuration of the solar light, which might precede and accompany the earthquake which took place on the same occasion. For it has been noticed that often before an earthquake such a mist arises from sulphureous vapours as to occasion a darkness almost nocturnal (see the authors cited in Kuinoel *ad Matt.* xxiv. 29, and compare Joel iii. 3; Rev. vi. 12, sq.). Such a darkness might extend over Judæa, or that division of Palestine in which Jerusalem stood, to which the best authorities agree that here, as in some other places, it is necessary to limit the phrase *πᾶσαν τὴν γῆν*, rendered 'all the land.'

Darkness is often used symbolically in the Scriptures as opposed to light, which is the symbol of joy and safety, to express misery and adversity (Job xviii. 6; Ps. cvii. 10; cxliii. 3; Isa. viii. 22; ix. 1; lix. 9, 10; Ezek. xxx. 18; xxxii. 7, 8; xxxiv. 12). 'He . . . that maketh the morning darkness,' in Amos iv. 13, is supposed to be an allusion to the dense black clouds and mists attending earthquakes. 'The day of darkness,' in Joel ii. 2, alludes to the obscurity occasioned by the flight of locusts in compact masses [Locust]. In Ezek. viii. 12, darkness is described as the accompaniment of idolatrous rites. Darkness of the sun, moon, and stars is used figuratively to denote a general darkness or deficiency in the government or body politic (Isa. xiii. 10; Ezek. xxxii. 7; Joel ii. 10-31). In Eph. v. 11, the expression 'works of darkness' is applied to the heathen mysteries, on account of the impure actions which the initiated performed in them. 'Outer darkness' in Matt. viii. 12, and elsewhere, refers to the darkness outside, in the streets or open country, as contrasted with the blaze of cheerful light in the house, especially when a convivial party is held in the night time. And it may be observed that the streets in the East are utterly dark after nightfall, there being no shops with lighted windows, nor even public or private lamps to impart to them the light and cheerfulness to which we are accustomed. This gives the more force to the contrast of the 'outer darkness' with the inner light.

Darkness is used to represent the state of the dead (Job x. 21; xvii. 13). It is also employed as the proper and significant emblem of ignorance (Isa. ix. 2; lx. 2; Matt. vi. 23; John iii. 9; 2 Cor. iv. 1-6).

DAROM (דָּרוֹם). This word means 'the south,' and as a proper name is usually understood to be applied to the southernmost part of Judæa, in Job xxxvii. 17; Deut. xxxiii. 23; Eccles. i. 6; Ezek. xxi. 2; xl. 24. Hence the name of 'Daroma' is given by Eusebius and Jerome to the region which they describe as extending about twenty miles from Eleutheropolis on the way towards Arabia Petæa, and from east to west as far as from the Dead Sea to Gerara and Beersheba. A little to the south of Gaza there is now a spot called Babed-Daron, a name probably derived from the fortress Daron, celebrated in the time of the Crusades. That fortress was built on the ruins of a Greek convent of the same name, which, being traced so far back, may well be identified with Darom as the ancient name of this territory.

DATES. [PALM TREE.]

DATHAN (דָּתָן, *fontanus*; Sept. Δαθάν), one of the chiefs of Reuben who joined Korah in the revolt against the authority of Moses and Aaron (Num. xvi. 1) [AARON].

DAUGHTER. In the Scriptures the word daughter is used in a variety of senses, some of which are unknown to our own language, or have only become known through familiarity with Scriptural forms of speech. This amounts to saying that the Hebrew word *בַּת* *bath*, has more extended applications than our word *daughter*. Besides its usual and proper sense of—1. A daughter sent or adopted, we find it used to designate—2. A uterine sister, niece, or any female descendant (Gen. xx. 12; xxiv. 48; xxviii. 6; xxxvi. 2. Num. xxv. 1; Deut. xxiii. 17).—3. Women, natives, residents, or professing the religion of certain places, as 'the daughter of Zion' (Isa. iii. 16); 'daughters of the Philistines' (2 Sam. i. 20); 'daughter of a strange God' (Mal. ii. 11); 'daughters of men,' *i. e.* carnal women (Gen. vi. 2); &c.—4. Metaphorically, small towns are called daughters of neighbouring large cities—metropolises, or mother cities—to which they belong, or from which they were derived, as 'Heshbon and all the daughters' [Auth. Vers. *villages*] thereof' (Num. xxi. 25); so Tyre is called the daughter of Sidon (Isa. xxii. 12), as having been originally a colony from thence; and hence also the town of Abel is called 'a mother in Israel' (2 Sam. xx. 19); and Gath is in one place (comp. 2 Sam. vii. 1; 1 Chron. xviii. 1) called Gath-Ammah, or Gath the *mother* town, to distinguish it from its own dependencies, or from another place called Gath. See other instances in Num. xxi. 32; Judg. xi. 26; Josh. iv. 45, &c.—5. The people collectively of any place, the name of which is given; as 'the daughter (*i. e.* the people) of Jerusalem hath shaken her head at thee' (Isa. xxxvii. 22; see also Ps. xlv. 13; cxxxvii. 8; Isa. x. 30; Jer. xlvi. 19; Lam. iv. 22; Zech. ix. 9). This metaphor is illustrated by the almost universal custom of representing towns under the figure of a woman.—6. The word 'daughter' followed by a numeral, indicates a woman of the age indicated by the numeral, as when Sarah (in the original) is called 'the daughter of ninety years' (Gen. xvii. 17).—7. The word 'daughter' is also applied to the *produce* of animals, trees, or plants. Thus, 'daughter of the she-ostrich' (supposed) for, 'female ostrich'

(Lev. xi. 16); Joseph is called 'a fruitful bough whose daughters (branches) run over the wall,' (Gen. xlix. 22).

The significations of the word 'daughter' in its scriptural use might be more minutely distinguished; but they may all be referred to one or other of these heads.

Respecting the condition of daughters in families, see art. WOMEN and MARRIAGE.

DAVID (דָּוִד); Chron. דָּוִד; Sept. Δαβιδ; New Test. Δαβιδ. The word probably means *beloved*: Gesenius). The reign of David is the great critical era in the history of the Hebrews. It decided that they were to have for nearly five centuries a national monarchy, a fixed line of priesthood, and a solemn religious worship by music and psalms of exquisite beauty; it finally separated Israel from the surrounding heathen, and gave room for producing those noble monuments of sacred writ, to the influence of which over the whole world no end can be seen. His predecessor, Saul, had many successes against the Philistines, but it is clear that he made little impression on their real power; for he died fighting against them, not on their own border, but at the opposite side of his kingdom, in Mount Gilboa. As for all the other 'enemies on every side'—Moabites, Ammonites, Edomites, and the kings of Zobah,—however much he may have 'vexed them' (1 Sam. xiv. 47), they, as well as the Amalekites, remained unsubdued, if weakened. The real work of establishing Israel as lord over the whole soil of Canaan was left for David.

Ample as are at first sight the materials for his history, a closer examination shows that great judgment and caution are needed in the use of them. His battle with Goliath, it is well known, involves difficulties of an embarrassing kind. In fact, it represents Saul and Abner as unacquainted with the person of David (1 Sam. xvii. 55-58), while the preceding chapter makes David the favourite attendant and musician of Saul. The Vatican Sept. employs the bold remedy of cutting out from ch. xvii. the twenty verses, 12-31, and the last four, 53-58, as well as the five first verses of the next chapter. But even so, David's unacquaintance with arms and preference of the sling to the sword and spear, which remains in vers. 33-40, is in conflict with ch. xvi. 18, which represents him as 'a mighty valiant man, and a man of war,' and Saul's 'armour-bearer' (ver. 21). It is, moreover, morally impossible that the verses wanting in the Vatican Sept. can have been added to the Hebrew text *after* its first translation into Greek. The same codex has extirpated vers. 9-11 of ch. xviii., and has re-modelled ver. 23, obviously in order to give continuity and consistency to the narrative. We must, then, look on the text here contained in our common version as having neither more nor less *external* authority than all the rest of the first book of Samuel. As a softer remedy, mere transposition may be attempted; but it will not succeed. The jealousy instantly kindled in Saul's bosom by the songs of the women when David was returning from slaying the Philistines, is inconsistent with the unsuspecting affection felt by Saul towards the simple shepherd in ch. xvi. 19-22. It has been argued from ch. xvii. 12-14, where David is introduced to us as if anew, that the original writer of these

words did not also pen the preceding chapter. There is some weight in this; yet it is not so decisive as the contradictory representation of David above alluded to. On the other hand, ch. xvii. 15 was written by one who had ch. xvi. before his eyes, and wished to account for David's not being with Saul, though he was his armour-bearer. So, indeed, Josephus distinctly perceived. 'Saul,' says he, '*sent* David to his father Jesse; *being satisfied with his three sons,*' &c. &c. (Joseph. *Antiq.* vi. 9, 2). Once more, even the Vatican codex of the Sept. leaves, in xvii. 54, the startling statement that David brought the head of the Philistine to Jerusalem. At that time not Jerusalem only, but its suburbs also, were in the power of the Jebusites, who, in 1 Chron. xi. 4, are called 'the inhabitants of the land.' Now, even allowing that in time of peace Israelites were admissible into Jerusalem, there is no conceivable reason why David should have carried his trophy thither, while it was a foreign and heathenish city. On the other hand, a late writer who was accustomed to think of Jerusalem as the metropolis of Judæa, might easily introduce such a statement. These difficulties, collectively, have induced some to regard the whole seventeenth chapter as from a later hand than the rest; but it is evident that if we omit it, we lose the clue to the rapid elevation of David and the jealousy of Saul, to say nothing of ch. xix. 5 and xxi. 9. Every theory, in short, is intrinsically unphilosophical, which fancies that it may cut out what it finds to be inconsistent, and then imagines that the authority of what is left is unimpaired; for the same hand which has introduced the passages which we reject, may have taken many liberties with that which we receive.

We learn from 1 Chron. xxix. 29 that the life of David was written by Samuel, Nathan, and Gad; also, from 2 Sam. i. 18 it may be probably inferred that other information concerning him was contained in the poems of Jasher. None of these works are before us in their original form. Materials from them have, however, been worked up by a later hand, which, it would seem, has sometimes adopted whole passages from them, sometimes has modified them and added connecting parts and explanations. Such, at least, is the conclusion to which every one will find himself strongly pressed by a close criticism of the whole narrative. The change of name from *Ishui* to *Ishbosheth* (1 Sam. xiv. 49 and 2 Sam. ii. 8, &c.) appears to indicate that compositions by different hands have been put together. That a duplicate account is found of the origin of the proverb, 'Is Saul also among the prophets?' seems undeniable (ch. x. 1-12 and xix. 20-24); and if a single clear case of this sort is admitted to exist, various others must probably fall under the same head. On this ground, doubtless, it is, that the Vatican Sept. has omitted ch. xviii. 10-11, since this attack of Saul on David's life 'on the morrow' is hard to reconcile with all that follows, and the verses appear to be a duplicate of ch. xix. 9, 10. Less certain duplicates, and yet not free from difficulty, are the following. The men of Ziph twice betray David to Saul (ch. xxiii. 19 and xxvi. 1); David twice spares Saul's life under circumstances highly unlikely to recur (ch. xxiv. and xxvi.), and on each occasion Saul is melted into tenderness. The former event ends with an

oath of David to Saul, which appears like a final termination of hostility; while the opening of ch. xxvii. embarrasses us by its extreme abruptness, when the very opposite result might have been expected from that which immediately precedes. Comparing also ch. xxi. 10-15 with ch. xxvii., it may seem that David's sojourn at Gath has been told twice over; for though each pair of events separately might, without physical impossibility, happen twice, yet, viewed collectively, the repetition of so many pairs surpasses all human probabilities. It has been necessary to promise so much, to show why we are disposed to be satisfied with rough results from the accounts of David's earlier life; which, as happens with all celebrated men who rise from a humble station, can hardly have been chronicled with the same precautions as those of his reign.

Even in regard to matters properly public, obscurity attaches both to the *numbers* which we read in our text, and occasionally to the *order* of events. On the difficulties found in the chronology of this period some remarks will be needed under the article SAUL. It more properly belongs to this place to observe that David is made thirty years old, and Ishbosheth forty, when Jonathan, elder brother of Ishbosheth, dies (2 Sam. ii. 10, 11); which appears to make too great a disparity of age between Jonathan and David. A sort of fatality seems attached to the number forty, which constantly occurs very inopportunistically. In 2 Sam. xv. 7 this number is extravagantly erroneous; yet the reading is at least older than the Sept. version, and Van der Hooght gives no various reading of the Hebrew. We seem justified in doubting whether forty years can have been the real age of Ishbosheth: twenty would agree better with the probabilities of the case. Again, Ishbosheth reigned two years, though David reigned over the tribe of Judah alone in Hebron for seven years and a half; where is the interval of five years and a half to be placed? Since it is certain that a *part* of David's reign over all Israel was spent by him at Hebron (for Jerusalem was not conquered by him till after all the tribes had joined him, 1 Chron. xi. 4). The easiest and perhaps a necessary solution is this, that the words in 2 Sam. ii. 11 and v. 5 are lax, and ought to be re-written thus: 'In Hebron he reigned seven years and six months, at first over the tribe of Judah only [viz. for two or three years], and afterwards over all Israel.'

Three chapters in the second book of Samuel chiefly contain the military successes of David; but there is some reason to believe that we cannot adhere to the order of the events there given. The mention of the Ammonites in ch. viii. 12 seems to be by anticipation; for in the opening of ch. x. we find that relations of personal friendship still subsisted between David and the king of the Ammonites. Reasons will shortly be stated for thinking that his first campaign against the king of Zobah has been placed too early; and the numbers of the chariots and horsemen engaged in the war can scarcely be defended. Of this further notice will be taken. Again, when the tribes of Israel came to Hebron to welcome David to the kingdom, his own tribe of Judah, in the midst of which Hebron lay, brought only 6800 men, less than those of the insignificant tribe of Simeon, who are reckoned there at 7100 (1 Chron. xii. 24, 25), while of the equally petty tribe of Dan there

are 28,600. It has been said in defence of these numbers that Judah had been miserably reduced by the proximity of the Philistines; but why should Simeon and Dan have suffered less? Nor would that account for the fact, that in the celebrated numbering of the people by Joab (2 Sam. xxiv. 9) there are 800,000 warriors in Israel, and 500,000 in Judah alone; or, according to 1 Chron. xxi. 5, in Israel 1,100,000, and in Judah 470,000. The two results in Kings and in Chronicles are here inconsistent; in both also we see the marks of a later narrator, who is accustomed to use the words Israel and Judah to mean *the ten* and *the two* tribes. Abundant illustration might be accumulated to the same effect, if this were the proper place for it.

The life of David naturally divides itself into three portions:—I. The time which he lived under Saul. II. His reign over Judah in Hebron. III. His reign over all Israel.

I. In the first period we may trace the origin of all his greatness. His susceptible temperament, joined to his devotional tendencies, must, at a very early age, have made him a favourite pupil of the prophets, whose peculiar mark was the harp and the psalm (1 Sam. x. 1-12 and xix. 20-24; see also 2 Kings iii. 15). His hospitable reception, when in distress, by Ahimelech the priest, and the atrocious massacre innocently brought by him on Nob, the city of the priests (1 Sam. xxi. and xxii. 9-19), must have deeply affected his generous nature, and laid the foundation of his cordial affection for the whole priestly order, whose ministrations he himself helped to elevate by his devotional melodies. At an early period he attracted the notice of Samuel; and if we are to arrange events according to their probable connection, we may believe that *after* David had been driven away from Saul and his life several times attempted, Samuel ventured on the solemn step of anointing him king. Whenever this took place, it must have produced on David a profound impression, and prepared him to do that in which Saul had so eminently failed, viz. to reconcile his own military government with a filial respect for the prophets and an honourable patronage of the priesthood. Besides this, he became knit into a bond of brotherhood with his heroic comrades, to whom he was eminently endeared by his personal self-denial and liberality (1 Sam. xxx. 21-31; 1 Chron. xi. 18). This, indeed, drew after it one most painful result, viz. the necessity of enduring the turbulence of his violent but able nephew Joab; nor could we expect that of a band of freebooters many should be like David. Again, during his outlawry David became acquainted in turn not only with all the wild country in the land, but with the strongholds of the enemy all round. By his residence among the Philistines he must have learned all their arts and weapons of war, in which it is reasonable to believe the Israelites previously inferior (1 Sam. xiii. 19-23). With Nalash the Ammonite he was in intimate friendship (2 Sam. x. 2); to the king of Moab he entrusted the care of his parents (1 Sam. xxii. 3); from Achish of Gath he received the important present of the town of Ziklag (1 Sam. xxvii. 6). It must, however, be confessed that the details of the last passage, without professing to be miraculous, go beyond the limits of probability; for if we even suppose that David could

commit the massacres there described, merely in order to hide his own perfidy, it is still incredible that the secret could have been kept and Achish continue to trust him (xxviii. 2, and xxix. 3). That Ziklag was a strong place may be inferred from 1 Chron. xii. 1, 20. The celebrity acquired in successful guerilla warfare, even in modern days, turns the eyes of whole nations on a chieftain; and in an age which regarded personal heroism as the first qualification of a general (1 Chron. xi. 6) and of a king, to triumph over the persecutions of Saul gave David the fairest prospects of a kingdom. That he was able to escape the malice of his enemy was due *in part* to the direct help given him by the nations round, who were glad to keep a thorn rankling in Saul's side; *in part* also to the indirect results of their invasions (1 Sam. xxiii. 27).

The account transmitted to us of David's dangers and escapes in this first period is too fragmentary to work up into a history: nevertheless, it seems to be divisible into two parts, differing in character. During the former he is a fugitive and outlaw in the land of Saul, hiding in caves, pitching in the wilderness, or occasionally with great risk entering walled cities (1 Sam. xxiii. 7); in the latter he abandons his native soil entirely, and lives among the Philistines as one of their chieftains (xxvii. 1). While a rover in the land of Judah, his position (to our eyes) is anything but honourable; being a focus, to which 'all who were in distress, in debt, or discontented gathered themselves' (xxii. 2). Yet as the number of his followers became large (six hundred, we read, xxiii. 13), and David knew how to conciliate the neighbouring sheep-masters by his urbanity and kind services, he gradually felt himself to be their protector and to have a right of maintenance and tribute from them. Hence he resents the refusal of Nabal to supply his demands, as a clear injustice; and, after David's anger has been turned away by the prudent policy of Abigail, in blessing her for saving him from slaying Nabal and every male of his family, the thought seems not to have entered his mind that the intention of such a massacre was more guilty than Nabal's refusal to pay him tribute (xxv. 34). This whole narrative is characteristic and instructive. By his marriage with Abigail he afterwards probably became rich (for she seems to have been a widow at her own disposal), and on passing immediately after into the land of the Philistines, he was enabled to assume a more dignified place. Becoming possessed of the stronghold of Ziklag, he now appeared like a legitimate chieftain with fixed possessions, and no longer a mere vagabond and freebooter. This was accordingly a transition-state in which David was prepared for assuming the kingdom over Judah. In Ziklag he was joined, not, as before, by mere outcasts from Israelitish life, but by men of consideration and tried warriors (1 Chron. xii. 1-22), not only of the tribe of Judah, but from Gad, Manasseh, and even 'from Saul's brethren of Benjamin.' Respecting the arms of these some remarks will be made at the close of this article.

II. Immediately upon the death of Saul the tribe of Judah invited David to become their prince. Internal probabilities lead us to believe that this was acceptable to the Philistines, who, it would seem, must have had the means of hin-

dering it, if they had been disposed. We are not informed why they neglected to improve the decisive victory which they had gained in Mount Gilboa. They vanish from the scene, and Abner quietly hands over the kingdom of the eleven tribes to Ishbosheth, son of Saul. Among many conjectures which may be made, one is that they despaired of keeping the whole land under subjection, since their numbers were too few to keep up all their garrisons; and their superiority must have been that of weapons and discipline only. They may, therefore, have gladly acquiesced in a partition of the monarchy, foreseeing that the fame and popularity of David would soon bring on a civil war between him and the house of Saul; and as he was on excellent terms with Achish, and had long been ostensibly an adherent of the Philistine cause, it is not wonderful that during his early reign David was able to maintain peace with his most dangerous neighbours.

His first step, after his election, was to fix on Hebron as the centre of his administration—an ancient city, honourable by its association with the name of Abraham, and in the middle of his own tribe. He then strengthened himself by a marriage with Maacah, daughter of Talmai, king of Geshur (2 Sam. iii. 3); a petty monarch whose dominions were near the sources of the Jordan, and whose influence at the opposite end of the land must have added a great weight into David's scale. From Abigail, widow of the churlish Nabal, David, as we have already observed, seems to have received a large private fortune. Concerning his other wives we know nothing in particular; only it is mentioned that he had six sons by six different mothers in Hebron. The chief jealousy was between the two tribes of Benjamin and Judah, as Saul had belonged to the former; and a tournament was turned by mutual ill-will into a battle, in which Abner unwillingly slew young Asahel, brother of Joab. (On the synchronism of Abner and Asahel, see SAUL.) 'Long war,' after this, was carried on between 'the house of Saul and the house of David.' We may infer that the rest of Israel took little part in the contest; and although the nominal possession of the kingdom enabled the little tribe of Benjamin to struggle for some time against Judah, the skill and age of Abner could not prevail against the vigour and popular fame of David. A quarrel between Abner and Ishbosheth decided the former to bring the kingdom over to David. The latter refused to treat unless, as a preliminary proof of Abner's sincerity, Michal, daughter of Saul, was restored to David. The possession of such a wife was valuable to one who was aspiring to the kingdom. Accordingly, the unhappy Michal was torn away from a most affectionate husband, and passed over into the increasing harem of the man to whom in his earliest youth she had been a virgin bride; but who now cared not for *her*, but for her name and its political uses. It is not wonderful that she could not adapt herself to her new lord, and that as soon as he was firm in the kingdom he disgraced her. After giving her back, Abner proceeded to win the elders of Israel over to David; but Joab discerned that if this should be so brought about, Abner of necessity would displace him from his post of chief captain. He, therefore, seized the opportunity of murdering him when he was come on a peaceful embassy,

and covered the atrocity by pleading the duty of revenging his brother's blood. This deed was perhaps David's first taste of the miseries of royal power. He dared not proceed actively against his ruthless nephew, but he vented his abhorrence in a solemn curse on Joab and his posterity, and followed Abner to the grave with weeping. Anxious to purge himself of the guilt, he ordered a public wearing of sackcloth, and refused to touch food all the day. His sincere yet ostentatious grief won the heart of all Israel. The feeble Ishbosheth, left alone, was unequal to the government, and shortly suffered the same fate of assassination. David, following the universal policy of sovereigns (Tac. *Hist.* i. 44), and his own profound sense of the sacredness of royalty, took vengeance on the murderers, and buried Ishbosheth in Abner's tomb at Hebron. During this period, it is not stated against what people his marauding excursions were directed. It is distinctly alleged (2 Sam. iii. 22) that his men brought in a great spoil at the very time at which he had a truce with Abner; possibly it may have been won from his old enemies the Amalekites (1 Sam. xxx.).

3. The death of Ishbosheth gave to David supremacy over all Israel. The kingdom was not at first a despotic, but a constitutional one; for it is stated, 'David made a league with the elders of Israel in Hebron before Jehovah; and they anointed David king over Israel' (2 Sam. v. 3). This is marked out as the era which determined the Philistines to hostility (ver. 17), and may confirm our idea, that their policy was to hinder Israel from becoming united under a single king. Two victories of David over them follow, both near the valley of Rephaim: and these were probably the first battles fought by David after becoming king of all Israel.

Perceiving that Hebron was no longer a suitable capital, he resolved to fix his residence farther to the north. On the very border of the tribes of Judah and Benjamin lay the town of Jebus, which with its neighbourhood was occupied by Jebusites, a remnant of the old Canaanitish nation so called. In spite of the great strength of the fort of Zion, it was captured, and the Jebusites were entirely expelled or subdued; after which David adopted the city as his new capital, greatly enlarged the fortifications, and gave or restored the name of Jerusalem [JERUSALEM]. In the account of this siege, some have imagined the Chronicles to contradict the book of Samuel, but there is no real incompatibility in the two narratives. Joab was, it is true, *already* David's chief captain; but David was heartily disgusted with him, and may have sought a pretence for superseding him, by offering the post to the man who should first scale the wall. Joab would be animated by the desire to retain his office, at least as keenly as others by the desire to get it; and it is credible that he may actually have been the successful hero of that siege also. If this was the case, it will further explain why David, even in the fulness of power, made no further effort to expel him until he had slaughtered Absalom. After becoming master of Jerusalem, David made a league with Hiram, king of Tyre, who supplied him with skilful artificers to build a splendid palace at the new capital. That the mechanical arts should have been in a very low state

among the Israelites, was to be expected; since, before the reign of Saul even smiths' forges were not allowed among them by the Philistines. Nothing, however, could have been more profitable for the Phœnicians than the security of cultivation enjoyed by the Israelites in the reigns of David and Solomon. The trade between Tyre and Israel became at once extremely lucrative to both, and the league between the two states was quickly very intimate.

Once settled in Jerusalem, David proceeded to increase the number of his wives, perhaps in part from the same political motive that actuates other Oriental monarchs, viz. in order to take *hostages* from the chieftains round in the least offensive mode. This explanation will not apply to the concubines. We know nothing further concerning David's family relations, than the names of eleven sons born in Jerusalem (2 Sam. v. 14, 15), of whom four were children of Bathsheba (1 Chron. iii. 5), and therefore much younger than the elder sons.

Jerusalem, now become the civil metropolis of the nation, was next to be made its religious centre; and the king applied himself to elevate the priestly order, to swell the ranks of attending Levites and singers, and to bring the ark to Jerusalem. The priests or Aaronites must, for a long time, have had little occupation in their sacred office; for the ark was at Kirjath-jearim, under the care of a private family. Indeed, during the reign of Saul, we find shewbread to have been set forth at Nob (1 Sam. xxi. 4-6), by Ahimelech the priest; and it is possible that many other ceremonies were performed by them, in spite of the absence of the ark. But after the dreadful massacre perpetrated on the priestly order by Saul, few Aaronites are likely to have felt at ease in their vocation. To wear an ephod—the mark of a priest who is asking counsel of Jehovah—had almost become a crime; and even after the death of Saul, it may seem that the Aaronites, like the other Israelites, remained organized as bands of soldiers. At least Jehoiada (who, according to 1 Chron. xxvii. 5, was high-priest at this time, and joined David at Hebron with 3700 Aaronites) was father of the celebrated warrior Benaiah, afterwards captain of David's body-guard; a man whose qualities were anything but priest-like: and Zadok, afterwards high-priest, who joined David 'with twenty-two captains of his father's house' at the same time as Jehoiada, is described as 'a young man mighty of valour' (1 Chron. xii. 27, 28). How long Jehoiada retained the place of high-priest is uncertain. It is probable that no definite conception then existed of the need of having *one* high-priest; and it is certain that David's affection for Abiathar, because of his father's fate, maintained him in chief place through the greater part of his reign. Not until a later time, it would seem, was Zadok elevated to a co-ordinate position. (A difficulty, indeed, exists about Abiathar, which can hardly be removed, except by supposing that 'Ahimelech, son of Abiathar,' has several times been inadvertently written for 'Abiathar, son of Ahimelech;' viz. in 2 Sam. viii. 17; 1 Chron. xxiv. 3, 6, 31. A similar error of 'Jehoiada, the son of Benaiah,' we shall afterwards have to remark on, in 1 Chron. xxvii. 34. We find Abiathar in the place of chief-priest in 1 Kings i. 7, &c., without any notice of his having

a son called Ahimelech.) Any further remarks concerning the orders and courses of the PRIESTS will be better reserved for the article on that subject. It is enough here to add, that the slaughter suffered from Saul by the Aaronites of the line of Ithamar, whom Abiathar now represented, naturally gave a great preponderance of numbers and power to the line of Eleazar, to which Zadok belonged. We must also refer to the article LEVITES for further information concerning them. The bringing of the ark from Kirjath-jearim to Jerusalem established the line of high-priests in direct service before it; and from this time we may presume that the ceremonies of the great day of Atonement began to be observed. Previously, it would appear, the connection between the priesthood and the tabernacle had been very loose. The priests fixed their abode at Nob, when the ark was at Kirjath-jearim, a very short distance; yet there is nothing to denote that they at all interfered with Abinadab in his exclusive care of the sacred deposit. (Concerning the chronological difficulties involved in the stay of the ark at Kirjath-jearim, see the article SAUL.)

When the ark entered Jerusalem in triumph, David put on a priest's ephod and danced before it. This proved the occasion of the rupture between him and his royal spouse, Michal, which sooner or later was inevitable. Accustomed to see in her father's court a haughty pre-eminence of the monarch over the priest, she could not sympathize with the deeper piety which led the royal Psalmist to forget his dignity in presence of the ark. The words of David to her, 'Jehovah chose me before thy father and before all his house' (2 Sam. vi. 21), sufficiently show Michal to have felt that she had been taken from her husband Phaltiel, merely to give colour to David's claim to the kingdom, and that David scorned to allow that he was in any way indebted to her for it. After this event, the king, contrasting his cedar palace with the curtains of the tabernacle, was desirous of building a temple for the ark; such a step, moreover, was likely to prevent any future change of its abode. The prophet Nathan, however, forbade it, on pious and intelligible grounds. The prohibition has been ascribed by some learned men to a cunning policy in Nathan; but it is not clear how the building of a temple would have injured the interest of the prophets. There are no indications that the prophets as yet regarded the priests with jealousy, nor that it was likely to increase the king's power over both. Great as might appear the advantage of establishing the same city as the religious and civil metropolis, the effect was, in one respect, most unfortunate: it offended the powerful and central tribe of Ephraim. They had been accustomed to regard Shiloh as the rightful abode of the ark. Against Kirjath-jearim no envy was felt, especially while the ark and its priests were in obscurity. But when so much honour attended it; when it became a peculiar glory to Judah and Benjamin—tribes already too much favoured; when a magnificent edifice was erected to receive it; the seeds were sown of that disaffection which ended in a rending of the tribes apart. Nor was the argument unreasonable, that a more central spot was needed for Israel to assemble at year by year.

David's further victories are narrated in the following order—Philistines, Moab, Zobah, Edom,

Northern League stirred up by the Ammonites, Ammon. 1. The short and dry notice concerning the Philistines just gives us to understand that this is the era of their decisive, though not final, subjugation. Their towns were despoiled of their wealth (2 Sam. viii., xii.), and doubtless all their arms and munitions of war passed over into the service of the conqueror. 2. The Moabites were a pastoral people, whose general relations with Israel appear to have been peaceful. The slight notice of Saul's hostilities with them (1 Sam. xiv. 47) is the only breach recorded since the time of Eglon and Ehud. In the book of Ruth we see them as friendly neighbours, and much more recently (1 Sam. xxii. 3, 4) David committed his parents to the care of the king of Moab. We know no cause, except David's strength, which now drew his arms upon them. A people long accustomed to peace, in conflict with a veteran army, was struck down at once, but the fierceness of his triumph may surprise us. Two-thirds of the population (if we rightly interpret the words, 2 Sam. viii. 2) were put to the sword; the rest became tributary. 3. Who are meant by the Syrians of Zobah, is still a problem [ZOBAN]. We here follow the belief that it was a power of northern Syria, then aiming at extensive empire, which had not only defeated and humbled the king of Hamath, but had obtained homage beyond the Euphrates. The trans-Jordanic tribes in the time of Saul had founded a little empire for themselves by conquering their eastern neighbours, the Hagarenes; and, perhaps, occasionally overran the district on the side of the Euphrates, which Hadadezer, king of Zobah, considered as his own. His efforts 'to recover his border at the river Euphrates' first brought him into collision with David, perhaps by an attack which he made on the roaming Eastern tribes. David defeated not merely his army, but those of Damascus too, which came, too late, with succour; and put Israelite garrisons into the towns of the Damascenes. In this career of success, we see, for the first time in history, the uniform superiority over raw troops of a power which is always fighting; whose standing army is ever gaining experience and mutual confidence. Nevertheless, the details of this victory over Hadadezer exceed all ordinary possibilities. It is not easy even to form a conception of the nature of the war. As the Eastern tribes of Israel had camels in abundance (for they are said to have taken 50,000 from the Hagarenes, 1 Chron. v. 21), David did not want the means of transporting an army of infantry and its baggage (see 1 Sam. xxx. 17). But with what troops are we to suppose him to fight against the powerful cavalry of the enemy? We may imagine horsemen to have been *repulsed* either by archers or by a phalanx of spearmen; of which, however, no mention is made, nor does it appear probable that the Israelites fought in phalanx. But neither by these nor by a squadron of camels—if any one supposes David to have used such a force, as Cyrus against Croesus—can 1000 chariots and 700 horsemen (which the Chronicler makes 7000, 1 Chron. xviii. 4) have been defeated and *captured*; to say nothing of the 20,000 captive footmen, or of the 22,000 Damascenes slain immediately after. 4. Another victory, gained 'in the valley of salt,' ought, perhaps, to be read, as in 1 Chron. xviii. 12, and in the superscription, of Ps. lx., 'over the *Edomites*,' not 'over the

Syrians. The difference of the Hebrew textual letters is very slight, אָרָם and אֲרָם. The verse which follows (2 Sam. viii. 14) seems to tell the result of this victory, viz. the complete subjugation and garrisoning of Edom, which, like Moab, was incorporated with David's empire. Immediately before this last conquest, as would appear, he wrote the 60th Psalm; and as that Psalm gives no hint of his achievements against the king of Zobah and the Damascenes, this is a strong ground for believing that those successes were not gained till somewhat later in time. 5. After David had become master of all Israel, of the Philistine towns, of Edom, and of Moab, while the Eastern tribes, having conquered the Hagarenes, threatened the Ammonites on the north, as did Moab on the south, the Ammonites were naturally alarmed, and called in the powers of Syria to their help against a foe who was growing dangerous even to them. The coalition against David is described as consisting of the Syrians of Bethrehab and of Maacah, of Zobah and of Tob. The last country appears to have been in the district of Trachonitis, the two first immediately on the north of Israel. In this war, we may believe that David enjoyed the important alliance of Toi, king of Hamath, who, having suffered from Hadadezer's hostility, courted the friendship of the Israelitish monarch (2 Sam. viii. 9, 10). We are barely informed that one division of the Israelites under Abishai was posted against the Ammonites; a second under Joab met the confederates from the north, 30,000 strong, and prevented their junction with the Ammonites. In both places the enemy was repelled, though, it would seem, with no decisive result. The spirit of exaggeration is certainly displayed in the statement—whoever is answerable for it—(1 Chron. xix. 7), that the Syrian confederates brought with them 32,000 chariots, which are not noticed in the parallel place of 2 Sam. Perhaps the text is corrupt; for 1000 talents of silver (ver. 6) appears a small sum to hire such a force with. A second campaign took place. The king of Zobah brought in an army of Mesopotamians, in addition to his former troops, and David found it necessary to make a levy of all Israel to meet the pressing danger. A pitched battle on a great scale was then fought at Helam—far beyond the limits of the twelve tribes—in which David was victorious. He is said to have slain, according to 2 Sam. x. 18, the men of 700 chariots, and 40,000 horsemen; or, according to 1 Chron. xix. 18, the men of 7000 chariots, and 40,000 footmen. Here, as on the former occasion, the Chronicler multiplies by 10 the number found in the older book. If we had access to the court-records of Hamath, we should probably find that Toi had assembled his whole cavalry to assist David, and that to him was due the important service of disabling or destroying the enemy's horse. Such foreign aid may explain the general result, without our obtruding a miracle, for which the narrative gives us not the least warrant. The Syrians henceforth left the Ammonites to their fate, and the petty chieftains who had been in allegiance to Hadadezer hastened to do homage to David. 6. Early in the next season Joab was sent to take vengeance on the Ammonites in their own home, by attacking their chief city, or Rabbah of Ammon. The natural strength of their border could not keep out veteran

troops and an experienced leader; and though the siege of the city occupied many months (if, indeed, it was not prolonged into the next year), it was at last taken. It is characteristic of Oriental despotism, that Joab, when the city was nearly reduced, sent to invite David to command the final assault in person. David gathered a large force, easily captured the royal town, and despoiled it of all its wealth. His vengeance was as much more dreadful on the unfortunate inhabitants than formerly on the Moabites, as the danger in which the Ammonites had involved Israel had been more imminent. The persons captured in the city were put to death by torture, some of them being sawed in pieces, others chopped up with axes or mangled with harrows, while some were smothered in brick-kilns (2 Sam. xii. 31; 1 Chron. xx. 3). This cruelty was perhaps effectual in quelling future movements of revolt or war; for, until insurrections in Israel emboldened them, foreign foes after this remain quiet.

During the campaign against Rabbah of Ammon the painful and never-to-be-forgotten outrage of David against Bathsheba and her husband Uriah the Hittite took place. It is principally through this narrative that we know the tediousness of that siege; since the adultery with Bathsheba and the birth of at least one child took place during the course of it.

The latter years of David's reign were afflicted by the inevitable results of polygamy and despotism, viz. the quarrels of the sons of different mothers, and their eagerness to seize the kingdom before their father's death. Of all his sons, Absalom had naturally the greatest pretensions, being, by his mother's side, grandson of Talmai, king of Geshur; while through his personal beauty and winning manners he was high in popular favour. It is evident, moreover, that he was the darling son of his father. When his own sister Tamar had been dishonoured by her half-brother Amnon, the eldest son of David, Absalom slew him in vengeance, but, in fear of his father, then fled to his grandfather at Geshur. Joab, discerning David's longings for his son, effected his return after three years; but the conflict in the king's mind is strikingly shown by his allowing Absalom to dwell two full years in Jerusalem before he would see his face.

The insurrection of Absalom against the king was the next important event; in the course of which there was shown the general tendency of men to look favourably on young and untried princes, rather than on those whom they know for better and for worse. Absalom erected his royal standard at Hebron first, and was fully prepared to slay his father outright, which might probably have been done, if the energetic advice of Ahithophel had been followed. While they delayed, David escaped beyond the Jordan, and with all his troop met a most friendly reception, not only from Barzillai and Machir, wealthy chiefs of pastoral Gilead, but from Shobi, the son of the Ammonite king Nahash, whose power he had destroyed, and whose people he had hewed in pieces. We likewise learn on this occasion that the fortunes of David had been all along attended by 600 men of Gath, who now, under the command of Ittai the Gittite, crossed the Jordan with all their households, in spite of David's generous advice that they would return to their

own country. Strengthened by the warlike eastern tribes, and surrounded by his experienced captains, the king no longer hesitated to meet Absalom in the field. A decisive victory was won at the wood of Ephraim, and Absalom was slain by Joab in the retreat. The old king was heart-stricken at this result, and, ignorant of his own weakness, superseded Joab in the command of the host by Amasa, Absalom's captain. Perhaps Joab on the former occasion, when he murdered Abner, had blinded the king by pleading revenge for the blood of Asahel; but no such pretence could here avail. The king was now probably brought to his determination, partly by his disgust at Joab, partly by his desire to give the insurgents confidence in his amnesty. If Amasa is the same as Amasai, David may likewise have retained a grateful remembrance of the cordial greeting with which he had led a strong band to his assistance at the critical period of his abode in Ziklag (1 Chron. xii. 18); moreover, Amasa, equally with Joab, was David's nephew, their two mothers, Abigail and Zeruiah, being sisters to David by at least one parent (2 Sam. xvii. 25; 1 Chron. ii. 13, 16). The unscrupulous Joab, however, was not so to be set aside. Before long, catching an opportunity, he assassinated his unsuspecting cousin with his own hand; and David, who had used the instrumentality of Joab to murder Uriah, did not dare to resent the deed.

A quarrel which took place between the men of Judah and those of the other tribes in bringing the king back, had encouraged a Benjamite named Sheba to raise a new insurrection, which spread with wonderful rapidity. 'Every man of Israel,' are the strong words of the text, 'went up from after David, and followed Sheba, the son of Bichri,' a man of whom nothing besides is known. This strikingly shows that the later despotism of David had already exhausted the enthusiasm once kindled by his devotion and chivalry, and that his throne now rested on the rotten foundation of mere military superiority. Amasa was collecting troops as David's general at the time when he was treacherously assassinated by his cousin, who then, with his usual energy, pursued Sheba, and blockaded him in Beth-maachah before he could collect his partisans. Sheba's head was cut off, and thrown over the wall; and so ended the new rising. Yet this was not the end of trouble; for the intestine war seems to have inspired the Philistines with the hope of throwing off the yoke. Four successive battles are recorded (2 Sam. xxi. 15-22), in the first of which the aged David was nigh to being slain. His faithful officers kept him away from all future risks, and Philistia was once more, and finally, subdued.

The last commotion recorded took place when David's end seemed nigh, and Adonijah, one of his elier sons, feared that the influence of Bathsheba might gain the kingdom for her own son Solomon. Adonijah's conspiracy was joined by Abiathar, one of the two chief priests, and by the redoubted Joab; upon which David took the decisive measure of raising Solomon at once to the throne. Of two young monarchs, the younger and the less known was easily preferred, when the sanction of the existing government was thrown into his scale; and the cause of Adonijah immediately fell to the ground. Amnesty was pro-

vided to the conspirators, yet it was not very faithfully observed [SOLOMON].

Numerous indications remain to us that, however eminently David was imbued with faith in Jehovah as the national God of Israel, and however he strove to unite all Israel in common worship, he still had no sympathy with the later spirit which repelled all foreigners from co-operation with Jews. In his early years necessity made him intimate with Philistines, Moabites, and Ammonites: policy led him into league with the Tyrians. He himself took in marriage a daughter of the king of Gesbur: it is the less wonderful that we find Uriah the Hittite (2 Sam. xi.), Gether the Ishmaelite (1 Chron. ii. 17), and others, married to Israelitish wives. The fidelity of Ittai the Gittite, and his six hundred men, has been already alluded to. It would appear, on the whole, that in tolerating foreigners Solomon did not go beyond the principles established by his father, though circumstances gave them a fuller development.

It has been seen that the reign of David began, as that of a constitutional monarch, with a league between him and his people: it ends as a pure despotism, in which the monarch gives his kingdom away to whomsoever he pleases, and his nominee steps at once into power without entering into any public engagements. The intensity of the despotism is strikingly shown in the indirect and cautious device by which alone Joab dared to hint to the king the suitability of recalling Absalom from banishment, though he believed the king himself to desire it (2 Sam. xiv.). All rose necessarily out of the standing army which David kept up as an instrument of conquest and of power, by the side of which constitutional liberty could not stand. The maintenance of this large force perhaps was not oppressive, since rich tributes were received from the surrounding nations; and the civil government was not yet become very expensive [SOLOMON]. We nevertheless need not wonder that those who joyfully welcomed David as their heroic deliverer were sick of heart when forced to address him with unmanly adulation.

One more dreadful tragedy is recorded in this reign—the immolation of seven sons of Saul (2 Sam. xxi.), on the occurrence of three years' bad harvests. A priestly response imputed the famine to Saul's violation of the oath of Joshua with the Gibeonites, and used the name and authority of Jehovah in proof. It has been suspected that the whole was contrived by the revenge of the priesthood for the barbarous massacre perpetrated by Saul on the priestly city of Nob; and that David the more easily acquiesced, since it was desirable, for the peace of his successors, that the house of Saul should be exterminated. Both suspicions are too probable to be easily set aside; and the latter receives painful confirmation from the cold injustice of David towards Mephibosheth, son of Jonathan, whom he first stripped of his whole patrimony, on a false and most improbable accusation, and afterwards, instead of honourably redressing the injury, restored to him the half only of his estate (2 Sam. xvi. 3; xix. 24-30). Such conduct proves that he was conscious of his own wrong, but was too desirous of weakening the house of Saul to renounce entirely the opportunity of damaging it, at

which he had snapt. That David did not give up Mephiboseth to be hanged by the Gibeonites is imputed to the oath between him and Jonathan; but it does not appear that their covenant was or could be more binding than his most explicit oath to Saul on the very same matter (1 Sam. xxiv. 21, 22). Five of the innocent men thus 'hanged up before Jehovah' as if he had been a Moloch, are stated in the common Hebrew and Greek text, and in our received version, to be children of Michal, David's youthful spouse; and Josephus imagines that they were born of her after a second divorce from David. But it is certain, from 1 Sam. xviii. 19, that *Michal* is here a mistake for *Merab*; which name De Wette has introduced into his version. The touching description of the other bereaved mother, Rizpah, the daughter of Aiah, is in refreshing contrast to the rest of the history, and shows the sympathy of the narrator's heart, while he had evidently no suspicion that the name of Jehovah could have been wrongly used to command the deed. Even after this atonement, it was thought that a thorough cleansing of the land was not yet effected. The bones of Saul and his three sons were disinterred from Jabesh-Gilead, and were buried in the sepulchre of Kish, in Benjamin; as if to obliterate every monument that Saul and his sons had ever been leaders of the hosts of Israel. After this the famine was removed.

It has been seen that, on one occasion (2 Sam. viii. 3), David fought against Hadadezer about a district on the river Euphrates. Yet it is not to be imagined that he had any fixed possession of territory so distant, which indeed could have had no value to him. A warrior from his youth, he seems to have had little perception of the advantages of commerce; and although the land of Edom was long under his power, he made no effort to use its ports of Eziongeber and Elath for maritime traffic. Much less was he likely to value the trade of the Euphrates, from which river he was separated by a tedious distance of desert land, over which, without the possession of superior cavalry, he could not maintain a permanent sovereignty. No attempt seems to have been made in David's reign to maintain horses or chariots for military purposes. Even chieftains in battle, as Absalom on his fatal day, appear mounted only on mules. Yet horses were already used in state equipages, apparently as a symbol of royalty (2 Sam. xv. 1).

That in the opening of Saul's reign the Philistines had deprived the Israelites of all the most formidable arms, is well known. It is probable that this may have led to a more careful practice of the sling and of the bow, especially among the southern tribes, who were more immediately pressed by the power of the Philistines. Such weapons cannot be kept out of the hands of rustics, and must have been essentially against wild beasts. But, from causes unknown, the Benjamites were peculiarly celebrated as archers and slingers (Judg. xx. 16; 1 Chron. viii. 40; xii. 2; 2 Chron. xiv. 8; xvii. 17), while the pastoral tribes beyond the Jordan were naturally able to escape all attempts of the Philistines to deprive them of shield, spear, and sword. Hence the Gadites, who came to David at Ziklag, are described as formidable and full-armed warriors, 'with faces like lions, and swift as mountain roes' (1 Chron. xiii. 8).

The standing army which Saul had begun to maintain was greatly enlarged by David. An account of this is given in 1 Chron. xxvii.; from which it would seem that 24,000 men were constantly maintained on service, though there was a relieving of guard every month. Hence, twelve times this number, or 288,000, were under a permanent military organization, with a general for each division in his month. Besides this host, the register proceeds to recount twelve princes over the tribes of Israel, who may perhaps be compared to the lord-lieutenants of English counties. The enumeration of these great officers is remarkable, being as follows:—1, of the Reubenites; 2, of the Simeonites; 3, of the Levites; 4, of the Aaronites; 5, of Judah; 6, of Issachar; 7, of Zebulun; 8, of Naphtali; 9, of Ephraim; 10, of Manasseh; 11, of Manasseh beyond the Jordan; 12, of Benjamin; 13, of Dan. Here the names of Gad and Asher are omitted, without explanation. On the other hand, the Levites and Aaronites are recounted as though they were tribes coordinate to the rest, and Zadok is named as prince of the Aaronites. It is not to be supposed that the Levites or Aaronites were wholly forbidden from civil and military duties. It has been already remarked that Zadok (here chief of the Aaronites) was described, in the beginning of David's reign, as 'a mighty man of valour' (1 Chron. xii. 28), and the same appellation is given to the sons of Shemaiah, a Levite (xxvi. 6). Benaiah also, now captain of David's body-guard, was son of the late high-priest Jehoiada (xxvii. 5, and xii. 27).

The body-guard of David, to which allusion has just been made, was an important appendage to his state, and a formidable exhibition of the actual despotism under which, in fulfilment of the warning of Samuel, Israel had now fallen. [CHRETHITES and PELETHITES.]

The cabinet of David (if we may use a modern name) is thus given (1 Chron. xxvii. 32-34) with reference to a time which preceded Absalom's revolt:—1, Jonathan, David's uncle, a counsellor, wise man, and scribe; 2, Jehiel, son of Hachmoni, tutor (?) to the king's sons; 3, Ahithophel, the king's counsellor; 4, Hushai, the king's companion; 5, after Ahithophel, *Jehoiada, the son of Benaiah*; 6, Abiathar the priest. It is added, 'and the general of the king's army was Joab.' At this period Benaiah was in the early prime of his military prowess; and it is incredible that he can have had a son, Jehoiada, old enough to be the second counsellor of the king, next to the celebrated Ahithophel. If the text is here corrupt, the corruption is older than the time of the Sept. However, De Wette has introduced, *Benaiah the son of Jehoiada*. We cannot look on this as certain; for Benaiah may have been the name of the father as well as of the son of Jehoiada the high-priest. Yet as it was very rare with the Hebrews for names to recur in alternate generations, De Wette's reading is at least highly probable. If so, it is striking to observe that Benaiah, as captain of the life-guards, is reckoned next to Ahithophel in rank as a counsellor; while Joab, general of the army, scarcely seems to have been a member of the cabinet. Zadok was above named as prince of the Aaronites; but was not yet so closely connected with the administration as Abiathar.

Twelve royal bailiffs are recited as a part of David's establishment (1 Chron. xxvii. 25, 31), having the following departments under their charge: 1, The treasures of gold, silver, &c.; 2, the magazines; 3, the tillage (wheat, &c. ?); 4, the vineyards; 5, the wine-cellars; 6, the olive and sycamore trees; 7, the oil-cellars; 8, the herds in Sharon; 9, the herds in the valleys; 10, the camels; 11, the asses; 12, the flocks. The eminently prosperous state in which David left his kingdom to Solomon appears to prove that he was on the whole faithfully served, and that his own excellent intentions, patriotic spirit, and devout piety (measured, as it must be measured, by the standard of those ages), really made his reign beneficial to his subjects. If it reduced them under despotism, yet it freed them from a foreign yoke and from intestine anarchy; if it involved them in severe wars, if it failed of uniting them permanently as a single people, in neither of these points did it make their state worse than it found them. We must not exact of David either to reign like a constitutional monarch, to uphold civil liberty, or by any personal piety to extract from despotism its sting. Even his most reprobate offence has no small palliation in the far worse excesses of other Oriental sovereigns; and his great superiority to his successors justifies the high esteem in which his memory was held. Concerning the closing scenes of David's life no more need here be said: the celebrated enumeration of the people by Joab, will be noticed under the article POPULATION.—F. W. N.

DAY. The earliest measure of time on record is the day:—'The evening and the morning were the first day' (Gen. i. 5). Here the word 'day' denotes the civil or calendar day of twenty-four hours, including 'the evening,' or natural night, and 'the morning,' or natural day. It is remarkable that in this account 'the evening,' or natural night, precedes 'the morning,' or natural day. Hence the Hebrew compound בֵּרַךְ בַּיּוֹם , 'evening-morning,' which is used by Daniel (viii. 14) to denote a civil day. In fact, the Jewish civil day began, as it still does, not with the morning, but the evening—thus the Sabbath commences with the sunset of Friday, and ends with the sunset of Saturday. Indications of this primeval order exist among many nations, and even we have 'seven-night,' 'fortnight,' to signify seven days and fourteen days. Under this arrangement the night seems to have been regarded not as belonging to and terminating the preceding day, but as belonging to and ushering in the day that follows—*Nox ducere diem videtur* (Tacit. Germ. ii.).

The inconveniences resulting from a variable commencement of the civil day, earlier or later, according to the different seasons of the year, as well as the equally varying duration of the natural day and night, must have been very considerable, and are sensibly felt by Europeans when travelling in the East, where the ancient custom in this matter is still observed. These inconveniences must be less obvious to the people themselves, who know no better system; yet they were apparent to several ancient nations—the Egyptians (Plin. *Hist. Nat.* ii. 77), the Ausonians, and others—and induced them to reckon their civil day from midnight to midnight, as from a fixed invariable point; and this usage has been adopted by most of the modern

nations of Europe. We thus realize the advantage of having our divisions of the day, the hours, of equal duration, day and night, at all times of the year; whereas among the Orientals the hours, and all other divisions of the natural day and night, are of constantly varying duration, and the divisions of the day vary from those of the night, excepting at the equinoxes.

The natural day was at first divided into three parts, morning, noon, and evening, which are mentioned by David as hours or times of prayer (Ps. lv. 17).

The natural night was also originally divided into three parts, or watches (Ps. lxxiii. 6; xc. 4). The *first*, or *beginning of the watches*, is mentioned in Lam. ii. 19; the *middle watch*, in Judg. vii. 19; and the *morning watch*, in Exod. xiv. 24. Afterwards the strictness of military discipline among the Greeks and Romans introduced an additional night-watch. The *second* and *third watches of the night* are mentioned in Luke xii. 38, and the *fourth* in Matt. xiv. 25. The four are mentioned together by our Lord, in Mark xiii. 35, and described by the terms $\delta\psi\acute{\epsilon}$, 'the late watch;' $\mu\epsilon\sigma\omicron\nu\kappa\tau\iota\omicron\nu$, 'the midnight;' $\acute{\alpha}\lambda\epsilon\kappa\tau\omicron\rho\omicron\varphi\omega\nu\iota\alpha\varsigma$, 'the cock-crowing;' and $\pi\rho\omega\acute{\iota}$, 'the morning.' The precise beginning and ending of each of the four watches is thus determined:

1. $\delta\psi\acute{\epsilon}$, 'the late,' began at sunset and ended with the third hour of the night, including the evening dawn, or twilight. It was also called $\delta\psi\iota\alpha \acute{\alpha}\rho\alpha$, 'even-tide' (Mark xi. 11), or simply $\delta\psi\iota\alpha$ 'evening' (John xx. 19.)

2. $\mu\epsilon\sigma\omicron\nu\kappa\tau\iota\omicron\nu$, 'the midnight,' lasted from the third hour till midnight.

3. $\acute{\alpha}\lambda\epsilon\kappa\tau\omicron\rho\omicron\varphi\omega\nu\iota\alpha\varsigma$, 'the cock-crowing,' lasted from midnight till the third hour after, or to the ninth hour of the night. It included the two cock-crowings, with the second of which it ended.

4. $\pi\rho\omega\acute{\iota}$, 'early,' lasted from the ninth to the twelfth hour of the night, or sunrise, including the morning dawn, or twilight. It was also called $\pi\rho\omega\acute{\iota}\alpha$, 'morning,' or 'morning-tide,' $\acute{\alpha}\rho\alpha$ being understood (John xviii. 28).

The division of the day into twelve hours was common among the Jews after the captivity in Babylon. The word hour first occurs in the book of Daniel (iv. 19); and it is admitted by the Jewish writers that this division of the day was borrowed by them from the Babylonians. Our Lord appeals to this ancient, and then long-established, division, as a matter of public notoriety: 'Are there not twelve hours in the day?' (John xi. 9).

This, however, was the division of the natural day into twelve hours, which were therefore variable according to the seasons of the year, at all places except the equator; and equal, or of the mean length, only at the vernal and autumnal equinoxes; being longer in the summer half-year, and shorter in the winter. The inconvenience of this has already been intimated.

The *first hour* of the day began at sunrise; the *sixth hour* ended at mid-day, or noon; the *seventh hour* began at noon; and the *twelfth hour* ended at sunset.

The days of the week had no proper names among the Hebrews, but were distinguished only by their numeral order [WEEK].

DEACON. This word is derived from the Greek term $\Delta\acute{\iota}\alpha\kappa\omicron\nu\omicron\varsigma$, and in its more extended

sense is used, both in Scripture and in ecclesiastical writers, to designate *any person who ministers in God's service*. In 2 Cor. vi. 4, the Apostle says, 'But in all things approving ourselves as the ministers (*διδάκονοι*, deacons) of God.' Again, Eph. iii. 7, 'Whereof I was made a minister (*διδάκονος*, deacon); and in Col. i. 2, 3, he employs the same epithet to express the character of his office. In Rom. xv. 8, St. Paul calls our Lord *διδάκονον περιτομῆς*—i. e. deacon of the circumcision; and, in his Epistle to the Philippians, he addresses himself to the *bishops and deacons* (Phil. i. 1).

Chrysostom, in commenting upon these words of the Apostle, exclaims, 'What! has a city more bishops than one? By no means; but when the Apostle wrote, the terms deacon and bishop were used indifferently the one for the other.' 'Hence,' he adds, 'the Apostle Paul, writing to Timothy, who yet was a bishop, says, "Fulfil thy ministry (*διακονία*)." Theophylact, writing upon the same subject (p. 577), calls the bishops *presbyters*; not, however, that there were in one city many bishops, but because bishops were *indiscriminately* called deacons and presbyters.

But it is in its more confined sense, as it expresses the *third* order of the ministry of the primitive Church, that we are to examine the meaning of the word *Deacon*.

Some suppose that the office of deacon had an existence before the election of the seven persons of whom we read in Acts vi. The words *Νεώτεροι* and *Νεανίσκοι* are sometimes used to designate the function as well as the age of man, by the same rule of interpretation which diversifies the sense of the word *Πρεσβύτεροι*. As, therefore, by the title *Presbyter*, the head or ruler of a society is meant, without regard to his age; so, by the term young man, we are often to understand *Minister*, or servant, because such persons are usually in the flower of youth. Christ himself seems to attribute this sense to the word *Νεώτερος*, Luke xxii. 26: 'ὁ μείζων ἐν ὑμῖν, γενέσθω ὡς ὁ νεώτερος.' Our Lord explains the word *μείζων* by the word *ἡγούμενος*, which signifies a *Presbyter* or ruler. He also substitutes, a little after, *ὁ διακονῶν* in place of *νεώτερος*, which confirms our interpretation; so that *μείζων* and *νεώτερος* refer *not* to age, but to office. 1 Pet. v. 5 confirms this view very remarkably: 'Ὁμοίως νεώτεροι ὑποτάγητε πρεσβυτέροις—' Likewise, young men, be ye subject to the elder; or, ye *Deacons*, be subject to the *Presbyters*. Now the *νεώτεροι*, or young men (who, we are told in Acts v. 6, carried out and buried the dead bodies of Ananias and Sapphira), are supposed to have been the very persons against whose partial distribution of the Church's bounty the complaint was made to the Apostles. To avoid even the appearance of *partiality* in a matter of this kind, six of the seven newly-elected deacons were taken from amongst the complaining Grecians. This would seem to be sufficiently indicated by their names.

That the duties of the seven deacons were not of an exclusively secular character is clear from the fact that both Philip and Stephen preached, and that one of them also *baptized*. It is strange, therefore, that the 18th Canon of the Council of Constantinople, in 'Trullo,' should declare, referring to Acts vi., that the seven deacons had *no spiritual function assigned them*. Cæcumenius

(a celebrated Greek writer of the tenth century) gives his testimony to the same effect (*In Act. Ap. vi. p. 433*). But opposed to this opinion is that of some of the Fathers of the Christian Church. Ignatius, a martyr-disciple of St. John, and bishop of Antioch, A.D. 68, styles them at once 'ministers of the mysteries of Christ; adding, that they are not ministers of meats and drinks, but of the Church of God (*Ignat. Ep. ad Trall. n. 2*). Again, he says (*Ep. ad Trall. n. 3*), 'Study to do all things in Divine concord, under your bishop presiding in the place of God, and the presbyters in the place of the apostolic senate, and the deacons most dear to me, as those to whom is committed the ministry of Jesus Christ.'

Cyprian, bishop of Carthage, A.D. 250 (whilst referring their origin to Acts vi.), styles them ministers of episcopacy and of the Church (*Cypr. Ep. 65, al. 3, ad Rogat.*): at the same time he asserts that they were called *ad altaris ministerium*—to the ministry of the altar.

Tertullian, a celebrated Father of the second century, classes them with bishops and presbyters as guides and leaders to the laity. He asks (*Tertull. De Fuga, c. ii.*): 'Quum ipsi auctores, id est, ipsi Diaconi, Presbyteri, et Episcopi fugiunt, quomodo Laicus intelligere poterit?—Cum Duces fugiunt quis de gregario numero sustinebit?'

Though Jerome in one place speaks of them (*Ep. ad Evang. et Com. Ezek. c. 48*) as servants of tables and widows; yet, again, he ranks them amongst the guides of the people: still he distinguishes them from the priests of the second order, that is, from the presbyters, by the title of *Servites*. And so, frequently, in the Councils, the names *Sacerdos* and *Levita* are used as the distinguishing titles of presbyter and deacon. The fourth Council of Carthage expressly forbids the deacon to assume any one function peculiar to the priesthood, by declaring, 'Diaconus non ad sacerdotium, sed ad ministerium consecratus.' (See also 18th Can. Con. Nic.)

His ordination, moreover, differed from that of presbyter both in its form and in the powers which it conferred. For in the ordination of a presbyter, the presbyters who were present were required to join in the imposition of hands with the bishop; but the ordination of a deacon might be performed by the bishop alone, because, as the 4th Can. of the 4th Council of Carthage declares, he was ordained not to the priesthood, but to the inferior services of the Church. We now proceed to notice what these services specifically were.

1. The deacon's more ordinary duty was to assist the bishop and presbyter in the service of the sanctuary; especially was he charged with the care of the utensils and ornaments appertaining to the holy table (*Isidorus, Epistola ad Landefredum*).

2. In the administration of the Eucharist, that it was theirs to hand the consecrated elements to the people, is evident from Justin Martyr (*Apol. ii. p. 152*), and from Cyprian (*Serm. v. 'De Lapsis'*). Not, however, that the deacon had any authority or power to *consecrate* the elements; for the 15th Can. of the Council of Arles, A.D. 312, forbids this. And the 18th Can. of the Council of Nice orders the deacons not even to administer the Eucharist to priests, because of their inferiority.

3. Deacons had power to administer the sacrament of baptism (Tertull. *De Bapt.* c. 17; also Hieron. *Dial. contr. Lucif.* c. 4, p. 139). The Council of Eliberis, Can. 77, plainly acknowledges this right, although the author of the *Apost. Constitutions*, and Epiphanius also, would seem to deny it.

4. The office of the deacon was not to preach, so much as to instruct and catechise the catechumens. His part was, when the bishop or presbyter did not preach, to read a homily from one of the Fathers. St. Ambrose, Bishop of Milan, A. D. 380, says expressly, that deacons, in his time, did not preach, though he thinks that they were all originally Evangelists, as were Philip and Stephen.

5. It was the deacon's business to receive the offerings of the people; and having presented them to the bishop or presbyter, to give expression in a *loud voice* to the names of the offerers (see Cypr. *Ep.* 10, al. 16, p. 37 (Hieron. *Com. in Ezek.* xviii. p. 537).

6. Deacons were sometimes authorized, as the bishops' special delegates, to give to penitents the solemn imposition of hands, which was the sign of reconciliation (Cypr. *Ep.* 13, al. 18, *ad Eter.*).

7. Deacons had power to suspend the inferior clergy; this, however, was done only when the bishop and presbyter were absent, and the case urgent (*Constit. Apost.* viii. 28).

8. The ordinary duty of deacons, with regard to general Councils, was to act as scribes and disputants according as they were directed by their bishops. In some instances they voted as proxies for bishops who could not attend in person; but in no instance do we find them voting in a general Council by virtue of their office. But in provincial synods the deacons were sometimes allowed to give their voice, as well as the presbyters, in their own name.

9. The author of *Apostol. Constitut.* (ii. 57, p. 875) informs us that one of the subordinate duties of the deacon was to provide places in the church for persons as they entered—to rebuke any that might either whisper, talk, laugh, &c. during divine service. This was a duty which, however, usually devolved upon the sub-deacon.

10. But, besides the above, there were some other offices which the deacon was called upon to fill abroad. One of these was to take care of the necessitous, orphans, widows, martyrs in prison, and all the poor and sick who had any claim upon the public resources of the church. It was also his special duty to notice the spiritual, as well as the bodily, wants of the people; and wherever he detected evils which he could not by his own power and authority cure, it was for him to refer them for redress to the bishop.

In general the number of deacons varied with the wants of a particular church. Sozomen (vii. 19, p. 100) informs us that the church of Rome, after the apostolic model, never had more than seven deacons.

It was not till the close of the third century that deacons were forbidden to marry. The Council of Ancyra, A. D. 344, in its 10th Can., ordains that if a deacon declared at the time of his ordination that he would marry, he should not be deprived of his function if he did marry; but that if he married without having made such a declaration, 'he must fall into the rank of laicks!'

The *qualifications* required in deacons by the primitive church were the same that were required in bishops and presbyters; and the characteristics of a deacon, given by St. Paul in his Second Epistle to Timothy, were the rule by which a candidate was judged fit for such an office. The second Council of Carthage, 4th Can., forbids the ordination of a deacon before the age of twenty-five; and both the Civil and Canon Law, as may be seen in Justinian's *Novels*, 123, c. 14, fixed his age to the same period.

The Council of Laodicea, A. D. 381, forbids a deacon to sit in the presence of a presbyter, and the 11th Can. of the first Council of Carthage regulates the number of judges to sit upon a clergyman—three bishops upon a deacon, six upon a presbyter, and twelve upon a bishop. This would mark the rank of each of the parties.

The primitive church had its archdeacon, though when the office was first instituted is a matter of dispute with learned men. He was not in priest's orders; but was selected from the deacons by the bishop, and had considerable authority over the other deacons and inferior orders.—J. W. D.

DEACONESS. This word is derived from *Διακόνισσα*, or *ἡ Διακονος*. That the order of Deaconess existed in the Christian church, *even in Apostolic days*, is evident from Rom. xvi. 1: 'I commend unto you Phebe, our sister, which is a servant (*οὐσαν διάκονον*, a deaconess) of the church which is at Cenchrea.'

The *earliest* Fathers of the church, moreover, speak of the same order of persons. Ignatius, writing to the church at Antioch—of which he himself was bishop—says, 'Salute the *deaconesses* in Christ Jesus.' Some suppose that it is to such offices of the church that the younger Pliny refers when he thus expresses himself in his letter to the emperor Trajan: 'Qui magis necessarium credidi ex duabus ancillis quæ ministræ dicebantur, quid esset veri et per tormenta querere.'

Theodoret (*Eccles. Hist.* iii. 14, p. 653) calls Publia, who lived at the time of Julian, *ἡ Διακονος—deaconess*. Again, we find Sozomen (iv. 14, p. 59) speaking of a certain deaconess who had been excluded church fellowship because of having broken her vows. Theophylact informs us that some supposed that the *Πρεσβυτιδας* of Tit. ii. 3 meant the *deaconesses*. But however this may be, we do know that the eleventh Can. of the Council of Laodicea calls the deaconesses of the church by the very term *Πρεσβυτιδας*, intimating that none but *elderly* persons were admitted to this office.

Certain qualifications were necessary in those who were taken into this order.

1. It was necessary that she should be a *widow*. On this Tertullian (*Ad Uxorem*, i. 7, p. 275) thus expresses himself: 'The discipline of the church and apostolic usage (alluding to 1 Tim. v. 9) forbid that any widow be elected unless she have married but *one* husband.' Virgins, it is true, were sometimes admitted into the order of deaconesses; but this was the exception, and not the rule.

2. No widow, unless she had borne children, could become a *deaconess*. This rule arose out of a belief that no person but a mother can possess those sympathizing and tender feelings which ought to animate the deaconess in the discharge of her *peculiar* duties.

3. The early church was very strict in exacting the rule which prohibits the election of any to be deaconesses who had been twice married, though lawfully, and successively to two husbands, one after the other. Thus Tertullian (*Ad Uxorem*, iv. 7) says, 'The apostle requires them (deaconesses) to be *uniuira*—the wives of one man.' Others, however, give to these words of the apostle another sense. They suppose the apostle to exclude only those widows who, having divorced themselves from their former husbands, had married again (See Suicer's *Thesaurus*, tom. i. p. 866).

It is a disputed point with some learned men whether deaconesses were ordained by imposition of hands. However, the fifteenth Can. of the Council of Chalcedon expressly declares that deaconesses were so ordained, and this is fully confirmed by the author of the *Apost. Constitutions*, viii. 19. Still, deaconesses were not consecrated to any *priestly* function. Some heretics, indeed, allowed women to teach, exorcise, and to administer baptism; but all this he sharply rebukes as being contrary to the apostolic rule (Tertullian, *De Præscript.* 41).

5. One of the peculiar duties, then, of the deaconesses was at the baptism of *women*. The custom of the early church being to baptize all adult persons by immersion (see Suicer's *Thesaur.* tom. i. p. 634), it was necessary to have the assistance of this order of persons. Epiphanius speaks of this practice in his *Exp. Fid.* xxi.; also Justin. *Novel.* vi. p. 6.

6. Another duty the deaconesses had to perform was to instruct and prepare the catechumens for baptism.

7. In times of danger and persecution it was the duty of the deaconesses to visit the martyrs in prison, because they could more easily gain access to them, and with less suspicion and hazard than the deacons.

8. The deaconesses stood at the entrance of the church in order to direct the women as to the place each one should occupy during divine service. Hence Ignatius calls them *Φυρουροις των αγιων πυλωνων* (*Epist. ad Antiochenas*, p. 96).

How long this order continued in the Christian church is not quite certain (Suicer's *Thesaurus*, tom. i. p. 69). It was not however discontinued everywhere at once. In the Greek church, up to the time of Balsamon, *i. e.* to the close of the twelfth century, deaconesses were found to minister in Constantinople (See Balsam. *Resp. ad Interrog. Marci, Patriarchæ Alexandrini*; Suicer, *Thesaur.* tom. i. p. 869). In the Latin churches, as early as the middle of the fourth century, we find some Councils setting the order aside. But it was not till the tenth century that it was wholly abrogated (See Bona, *Rep. Liturg.* i. 25, 15).—J. W. D.

DEAD SEA. [SEA.]

DEATH. No logical definition of death has been generally agreed upon. This point was much contested in the seventeenth century by the Cartesian and other theologians and philosophers. Since death can be regarded in various points of view, the descriptions of it must necessarily vary. If we consider the state of a dead man, as it strikes the senses, death is the cessation of natural life. If we consider the cause of death, we may place it in that permanent and entire cessation of the feeling and motion of the body which

results from the destruction of the body. Among theologians, death is commonly said to consist in the separation of soul and body, implying that the soul still exists when the body perishes. Among the ecclesiastical fathers, Tertullian (*De Anima*, c. 27) gives this definition: *Mors—disjunctio corporis animæque; vita—conjunctio corporis animæque*. Cicero (*Tusc. Dis.* i.) defines death, *discensus animi a corpore*. The passage Heb. iv. 12, is sometimes cited on this subject, but has nothing to do with it. Death does not consist in this separation, but this separation is the consequence of death. As soon as the body loses feeling and motion, it is henceforth useless to the soul, which is therefore separated from it.

Scriptural representations, names, and modes of speech respecting death :—

(a). One of the most common in the Old Testament is, to *return to the dust*, or to the earth. Hence the phrase, *the dust of death*. It is founded on the description Gen. ii. 7, and iii. 19, and denotes the dissolution and destruction of the body. Hence the sentiment in Eccles. xii. 7,—'The dust shall return to the earth as it was, the spirit unto God, who gave it.'

(b). A withdrawing, exhalation, or removal of the breath of life (Ps. civ. 29). Hence the common terms *ἀφῆκε*, *παρέθηκε τὸ πνεῦμα*, *redidit animam*, *ἐξέπνευσε*, *expiravit*, &c.

(c). A removal from the body, a being absent from the body; a departure from it, &c. This description is founded on the comparison of the body with a tent or lodgment in which the soul dwells during this life. Death destroys this tent or house, and commands us to travel on (Job iv. 21; Isa. xxxviii. 12; Ps. llii. 7). Whence Paul says (2 Cor. v. 1) 'our earthly house of this tabernacle' will be destroyed; and Peter calls death a 'putting off of this tabernacle' (2 Peter i. 13, 14). Classical writers speak of the soul in the same manner, as *κατασκρῖνον ἐν τῷ σώματι*. They call the body *σκήνος*. So Hippocrates and Æschines. Compare 2 Cor. v. 8, 9—*ἐκδημήσαι ἐκ τοῦ σώματος*.

(d). Paul likewise uses the term *ἐκδυσθαι*, in reference to death (2 Cor. v. 3, 4); because the body is represented as the garment of the soul, as Plato calls it. The soul, therefore, as long as it is in the body, is clothed; and as soon as it is disembodied, is naked.

(e). The terms which denote *sleep* are applied frequently in the Bible, as everywhere else, to death (Ps. lxxvi. 5; Jer. li. 39; John xi. 13, sqq.). Nor is this language used exclusively for the death of the pious, as some pretend, though this is its prevailing use. Homer calls *sleep* and *death* twin-brothers (*Iliad*, xvi. 672). The terms also which signify to lie down, to rest (*e. g.* *κοιμηθῆναι*), also denote death.

(f). Death is frequently compared with and named from a *departure*, a *going away*. Hence the verbs *ευνδι*, *αβευνδι*, *discedendi*, signify to die (Job x. 21; Ps. xxxix. 4). The case is the same with *ὑπάγω* and *πορεύομαι* in the New Testament (Matt. xxvi. 24), and even among the classics. In this connection we may mention the terms *ἀναλθῆναι* and *ἀνάλυσθαι* (Phil. i. 23; 2 Tim. iv. 6) which do not mean *dissolution*, but *discensus* (cf. Luke xii. 36). Vid. Wetstein on Phil. i.

Death, when personified, is described as a *ruin*

and tyrant, having vast power and a great kingdom, over which he reigns. But the ancients also represented it under some figures which are not common among us. We represent it as a man with a scythe, or as a skeleton, &c.; but the Jews, before the exile, frequently represented death as a hunter, who lays snares for men (Ps. xviii. 5, 6; xci. 3). After the exile, they represented him as a man, or sometimes as an angel (the angel of Death), with a cup of poison, which he reaches to men. From this representation appears to have arisen the phrase, which occurs in the New Testament, to *taste death* (Matt. xvi. 28; Heb. ii. 9), which, however, in common speech, signifies merely to *die*, without reminding one of the origin of the phrase. The case is the same with the phrase to *see death* (Ps. lxxxix. 48; Luke ii. 26). See Knapp's *Christian Theology*, by Dr. Leonard Wood.

DEBIR (דְּבִיר; Sept. Δαβίρ), a city in the tribe of Judah, about thirty miles south-west from Jerusalem, and ten miles west of Hebron. It was also called Kirjath-sepher (Josh. xv. 15), and Kirjath-sannah (xv. 49). The name Debir means 'a word' or 'oracle,' and is applied to that most secret and separated part of the Temple, or of the most holy place, in which the ark of the covenant was placed, and in which responses were given from above the cherubim. From this, coupled with the fact that Kirjath-sepher means 'book-city,' it has been conjectured that Debir was some particularly sacred place or seat of learning among the Canaanites, and a repository of their records. 'It is not indeed probable,' as Professor Bush remarks, 'that writing and books, in our sense of the words, were very common among the Canaanites; but some method of recording events, and a sort of learning was, doubtless, cultivated in those regions.' Debir was taken by Joshua (xi. 38); but it being afterwards retaken by the Canaanites, Caleb, to whom it was assigned, gave his daughter Achsah in marriage to his nephew Othniel for his bravery in carrying it by storm (Josh. xv. 16). The town was afterwards given to the priests (xxi. 15). No trace of it is to be found at the present time.

There were two other places called Debir: one belonging to Gad, beyond Jordan (Josh. xiii. 26); the other to Benjamin, though originally in Judah.

DEBORAH (דְּבִרָה, *a dee*; Sept. Δεβώρα), a prophetess, wife of Lapidoth. She dwelt, probably, in a tent, under a well-known palm-tree between Ramah and Bethel, where she judged Israel (Judg. iv. 4, 5). This probably means that she was the organ of communication between God and his people, and probably, on account of the influence and authority of her character, was accounted in some sort as the head of the nation, to whom questions of doubt and difficulty were referred for decision. In her triumphal song she says—

'In the days of Shamgar, son of Anath,
In the days of Jael, the ways lay desert,
And high-way travellers went in winding by-
paths.

Leaders failed in Israel, they failed,
Until that I Deborah arose,
That I arose, a mother in Israel.'

From the further intimations which that song contains, and from other circumstances, the people would appear to have sunk into a state of

total discouragement under the oppression of the Canaanites; so that it was difficult to rouse them from their despondency and to induce them to make any exertion to burst the fetters of their bondage. From the gratitude which Deborah expresses towards the people for the effort which they finally made, we are warranted in drawing the conclusion that she had long endeavoured to instigate them to this step in vain. At length she summoned Barak, the son of Abinoam, from Kedesh, a city of Naphtali, on a mountain not far from Hazor, and made known to him the will of God that he should undertake an enterprise for the deliverance of his country. But such was his disheartened state of feeling, and at the same time such his confidence in the superior character and authority of Deborah, that he assented to go only on the condition that she would accompany him. To this she at length consented. They then repaired together to Kedesh, and collected there—in the immediate vicinity of Hazor, the capital of the dominant power—ten thousand men, with whom they marched southward, and encamped on Mount Tabor. Sisera, the general of Jabin, king of Hazor, who was at the head of the Canaanitish confederacy, immediately collected an army, pursued them, and encamped in face of them in the great plain of Esdraelon. Encouraged by Deborah, Barak boldly descended from Tabor into the plain with his ten thousand men to give battle to the far superior host of Sisera, which was rendered the more formidable to the Israelites by nine hundred chariots of iron. The Canaanites were beaten; and Barak pursued them northward to Harosheth. Sisera himself, being hotly pursued, alighted from his chariot and escaped on foot to the tent of Heber the Kenite, by whose wife he was slain. This great victory (dated about B.C. 1296), which seems to have been followed up, broke the power of the native princes, and secured to the Israelites a repose of forty years' duration. During part of this time Deborah probably continued to exercise her former authority: but nothing more of her history is known.

The song of triumph, which was composed in consequence of the great victory over Sisera, is said to have been 'sung by Deborah and Barak.' It is usually regarded as the composition of Deborah; and was probably indited by her to be sung on the return of Barak and his warriors from the pursuit. Of this peculiarly fine specimen of the earlier Hebrew poetry, there is an excellent translation by Dr. Robinson in the 1st vol. of the *American Biblical Repository*, from the introductory matter to which this notice of Deborah is chiefly taken.

2. DEBORAH. The nurse of Rebekah, whom she accompanied to the land of Canaan; she died near Bethel, and was buried under an oak, which for that reason was thenceforth called Allon-bachuth—'the oak of weeping' (Gen. xxxv. 8).

DECALOGUE (עֲשֵׂרֹת הַדְּבָרִים; Sept. οὗ δέκα λόγοι and τὰ δέκα βήματα; Vulg. *decem verba*, the ten words. Exod. xxxiv. 28; Deut. iv. 13; x. 4). This (Δεκαλογος) is the name most usually given by the Greek Fathers, to the law of the two tables, given by God 'to Moses on Mount Sinai. The decalogue was written on two stone slabs (Exod. xxxi. 18), which, having

been broken by Moses (xxxii. 19), were renewed by God (xxxiv. 1, &c.). They are said (Deut. ix. 10) to have been written by the finger of God, an expression which always implies an immediate act of the Deity. The decalogue is five times alluded to in the New Testament, there called *εντολαι*, *commandments*, but only the latter precepts are specifically cited, which refer to our duties to each other (Matt. xvii. 18, 19, &c.; Mark x. 19; Luke xviii. 20; Rom. xiii. 9; vii. 7, 8; Matt. v.; 1 Tim. i. 9, 10). Those which refer to God are supposed by some to be omitted from the circumstance of their containing precepts for ceremonial observances (Jeremy Taylor's *Life of Christ*, and *Ductor Dubitan.*; Rosenmüller's *Scholia in Exod.*) [LAW].

The circumstance of these precepts being called *the ten words* has doubtless led to the belief that the two tables contained ten distinct precepts, five in each table; while some have supposed that they were called by this name to denote their perfection, *ten* being considered the most perfect of numbers (Philo-Judæus *de decalogo*). This distinguished philosopher divides them into two pentads, the first pentad ending with Exod. xx. 12, 'Honour thy father and thy mother,' &c., or the *fifth* commandment of the Greek, Reformed, and Anglican churches; while the more general opinion among Christians is that the first table contained our duty to God, ending with the law to keep the sabbath holy, and the second, our duty to our neighbour. As they are not numerically divided in the Scriptures, so that we cannot positively say which is the first, which the second, &c., it may not prove uninteresting to the student in Biblical literature, if we here give a brief account of the different modes of dividing them which have prevailed among Jews and Christians. These may be classed as the Talmudical, the Origenian, and the two Masoretic divisions.

The case cannot be more clearly stated than in the words of St. Augustin: 'It is inquired how the ten commandments are to be divided? whether there are four which relate to God, ending with the precept concerning the sabbath,—and the other six, commencing with "Honour thy father and thy mother," appertaining to man,—or whether the former are *three* only, and the latter *seven*. Those who say that the first table contains *four*, separate the command "Thou shalt have no other Gods but me" (Exod. xx. 3; Deut. v. 7), so as to make another precept of "Thou shalt not make to thyself an idol" (Exod. xx. 4; Deut. v. 8); in which images are forbidden to be worshipped. But they wish "Thou shalt not covet thy neighbour's house" (Exod. xx. 17; Deut. v. 21), and "Thou shalt not covet thy neighbour's wife" (Exod. xx. 17; Deut. v. 21), and so on to the end, to be one. But those who say that there are *three* only in the first table, and *seven* in the second, make one commandment of the precept of the worship of one God, and nothing beside him (Exod. xx. 3; Deut. v. 7), but divide these last into two, so that one of them is "Thou shalt not covet thy neighbour's wife," and the other "Thou shalt not covet thy neighbour's house." There is no question among either about the correctness of the number ten, as for this there is the testimony of Scripture' (*Questions on Exodus*, qu. 71, *Works*, vol. iii., Paris, 1679, p. 443). We shall

hereafter give Augustin's own view of the subject, but here we shall commence with the division contained in the Talmud (*Makkoth*, xxiv. a), which is also that of the modern Jews.

According to this division the first commandment consists of the words 'I am the Lord thy God, who brought thee out of the land of Egypt, out of the house of bondage' (Exod. x. 2; Deut. v. 6); the second (Exod. iii. 4), 'Thou shalt have none other Gods beside me; thou shalt not make to thyself any graven image,' &c. to ver. 6; the third, 'Thou shalt not take God's name in vain,' &c.; the fourth, 'Remember to keep holy the sabbath day,' &c.; the fifth, 'Honour thy father and thy mother,' &c.; the sixth, 'Thou shalt not kill;' the seventh, 'Thou shalt not commit adultery;' the eighth, 'Thou shalt not steal;' the ninth, 'Thou shalt not bear false witness,' &c.; and the tenth, 'Thou shalt not covet,' &c. to the end. This division is also supported by the Targum of the Pseudo-Jonathan, a work of the sixth century, by Aben Ezra, in his *Commentary*, and by Maimonides (*Sepher Hamizvoth*). It has been also maintained by the learned Lutheran, Peter Martyr (*Loci Communes*, Basle, 1580, loc. 14, p. 684). That this was a very early mode of dividing the decalogue is further evident from a passage in Cyril of Jerusalem's treatise against Julian, from whom he quotes the following invective: 'That decalogue, the law of Moses, is a wonderful thing; thou shalt not steal; thou shalt not kill; thou shalt not bear false witness. But let each of the precepts which he asserts to have been given by God himself be written down in the identical words, "I am the Lord thy God, who brought thee out of the land of Egypt;" the second follows, "Thou shalt have no strange gods beside me; thou shalt not make to thyself an idol." He adds the reason, "for I, the Lord thy God, am a jealous God, visiting the sins of the fathers upon the children." "Thou shalt not take the name of the Lord thy God in vain. Remember the sabbath day. Honour thy father and thy mother. Thou shalt not commit adultery. Thou shalt not steal. Thou shalt not bear false witness. Thou shalt not covet thy neighbour's goods." What nation is there, by the gods, if you take away these two, "Thou shalt not adore other Gods," and "Remember the sabbath," which does not think all the others are to be kept, and which does not punish more or less severely those who violate them?

The next division is the *Origenian*, or that approved by Origen, and is that in use in the Greek and in all the Reformed Churches, except the Lutheran.

Although Origen was acquainted with the differing opinions which existed in his time in regard to this subject, it is evident from his own words that he knew nothing of that division by which the number *ten* is completed by making the prohibition against coveting either the house or the wife a distinct commandment. In his eighth *Homily on Genesis*, after citing the words, 'I am the Lord thy God, who brought thee out of the land of Egypt,' he adds, 'this is not a part of the commandment.' The first commandment is, 'Thou shalt have no other Gods but me,' and then follows, 'Thou shalt not make an idol.' These together are thought by some to make one commandment; but in this case the number *ten*

will not be complete—where then will be the truth of the decalogue? But if it be divided as we have done in the last sentence, the full number will be evident. The first commandment therefore is, 'Thou shalt have no other Gods but me,' and the second, 'Thou shalt not make to thyself an idol, nor a likeness,' &c. Origen proceeds to make a distinction between Gods, idols, and likenesses. Of Gods, he says, 'it is written, there are gods many and lords many' (1 Cor. viii. 5); but of idols, 'an idol is nothing;' an image, he says, of a quadruped, serpent, or bird, in metal, wood, or stone, set up to be worshipped, is not an *idol*, but a *likeness*. A picture made with the same view comes under the same denomination. But an idol is a representation of what does not exist; such as the figure of a man with two faces, or with the head of a dog, &c. The likeness must be of something existing in heaven, or in earth, or in the water. It is not easy to decide on the meaning of 'things in heaven,' unless it refers to the sun, moon, or stars. The design of Moses he conceives to have been to forbid Egyptian idolatry, such as that of Hecate, or other fancied demons.—*Opera*, vol. ii. p. 156, De la Rue's ed.

The Pseudo-Athanasius, or the author of the *Synopsis Scripturæ*, who is the oracle of the Greek church, divides the commandments in the same manner. 'This book [Exodus] contains these ten commandments, on two tables: first, I am the Lord thy God. Second, Thou shalt not make to thyself an idol, nor any likeness. . . . Ninth, Thou shalt not bear false witness against thy neighbour. Tenth, Thou shalt not covet thy neighbour's wife, nor any thing that is thy neighbour's.'—Athanasii *Opera*, fol. Paris, 1698.

Gregory Nazianzen, in one of his poems, inscribed 'The Decalogue of Moses,' gives the following division:

These ten laws Moses formerly engraven on tables

Of stone; but do thou engrave them on thy heart.

Thou shalt not know another God, since worship belongs to me.

Thou shalt not make a vain statue, a lifeless image.

Thou shalt not call on the great God in vain. Keep all sabbaths, the sublime and the shadowy.

Happy he who renders to his parents due honour. Flee the crime of murder, and of a foreign

Bed; evil-minded theft and witness

False, and the desire of another's, the seed of death.

Opera, ed. Caillaud, Paris, 1840.

Jerome took the same view with Origen. In his commentary on Ephesians vi. he thus writes: 'Honour thy father and thy mother,' &c. is the *fifth* commandment in the decalogue. How then are we to understand the Apostle's meaning in calling it the first, when the first commandment is 'Thou shalt have no Gods but me,' where some read thus, 'which is the first commandment with promise,' as if the *four* previous commandments had no promise annexed, &c. . . . 'But they do not seem to me to have observed with sufficient accuracy that in the *second* commandment there is also a promise: 'Thou shalt not make to thyself an idol, nor the likeness of any thing in heaven above, or in the earth beneath, or in the water under the earth; thou shalt not adore

them, nor sacrifice to them; for I the Lord thy God am a jealous God, visiting the sins . . . but shewing mercy unto thousands . . .' (observe these words of promise—shewing mercy unto thousands, &c.)—Hieronymi *Opera*, vol. iv. Paris, 1693.

The Pseudo-Ambrose also writes to the same effect in his *Commentary on Ephesians*: 'How is this the first commandment, when the first commandment says, Thou shalt have no other gods but me? Then, Thou shalt not make a likeness of anything in heaven above, or in the earth beneath, &c. The *third*, Thou shalt not take the name of the Lord thy God in vain; the *fourth*, Keep my sabbaths; the *fifth*, Honour thy father and thy mother. As the first four appertain to God, they are contained in the first table: the others, appertaining to men, are contained in the second, such as that of honouring parents, not committing murder, adultery, theft, false witness, or concupiscence. These six seem to be written in the second table, the first of which is called the first with promise' (Ambrosii *Opera*, vol. ii. Paris edition; Append. pp. 248, 249).

To these testimonies from the fathers may be added that of Clemens Alexandrinus (*Stromata*, vi. p. 809); but this writer is so confused and contradictory in reference to the subject, that some have supposed the text to have been corrupted. 'The first precept of the decalogue,' he observes, 'shows that one God only is to be worshipped, who brought his people out of Egypt . . . and that men ought to abstain from the idolatry of the creature. The second, that we ought not to transfer his name to creatures; the *third* signifies that the world was made by God, who has given us the seventh day to rest; the *fifth* follows, which commands us to honour our parents; then follows the precept about adultery, after this that concerning theft; but the tenth is concerning coveting.'

But the strongest evidence in favour of the Origenian division is that of the learned Jews Philo and Josephus, who speak of it as the received division of the Jewish Church. Philo, after mentioning the division into two pentads already referred to, proceeds: 'The first pentad is of a higher character than the second; it treats of the monarchy whereby the whole world is governed, of statues and images (*εἰδωλῶν καὶ ἀγάλματων*), and of all corrupt representations in general (*ἀφιδρωμάτων*); of not taking the name of God in vain; of the religious observance of the seventh day as a day of holy rest; of honouring both parents. So that one table begins with God the father and ruler of all things, and ends with parents who emulate him in perpetuating the human race. But the other pentad contains those commandments which forbid adultery, murder, theft, false-witness, concupiscence' (*De Decalogo*, lib. i.). The *first* precept, he afterwards observes, enjoins the belief and reverent worship of one supreme God, in opposition to those who worship the sun and moon, &c. And after condemning the arts of sculpture and painting, as taking off the mind from admiring the natural beauty of the universe, he adds: 'As I have said a good deal of the *second* commandment, I shall now proceed to the next, "Thou shalt not take the name of God in vain." . . . The fourth commandment respects the sabbath day, to be devoted to rest, the study of wisdom, and the contempla-

tion of nature, with a revision of our lives during the past week, in order to the correction of our transgressions: the fifth speaks of honouring parents. Here ends the first, or more divine pentad. The second pentad begins with the precept respecting adultery; its second precept is against murder; its third against stealing, the next against false-witness, the last against coveting' (lib. ii.). This division seems to have been followed by Irenæus: 'In quinque libris, &c., unaquæque tabula quam accipit a Deo præcepta habet quinque.' And Josephus is, if possible, still more clear than Philo. 'The first commandment teaches us that there is but one God, and that we ought to worship him only; the second commands us not to make the image of any living creature, to worship it; the third, that we must not swear by God in a false matter; the fourth, that we must keep the seventh day, by resting from all sorts of work; the fifth, that we must honour our parents; the sixth, that we must abstain from murder; the seventh, that we must not commit adultery; the eighth, that we must not be guilty of theft; the ninth, that we must not bear false-witness; the tenth, that we must not admit the desire of that which is another's' (*Antiq.*, iii. 5. 5, Whiston's translation).

This division, which appears to have been forgotten in the Western Church, was revived by Calvin in 1536, and is also received by that section of the Lutherans who followed Bucer, called the Tetrapolitans. It is adopted by Calmet (*Dictionary of the Bible*, French ed., art. *LOI*.) It is supported by Zonaras, Nicephorus, and Petrus Mogislaus among the Greeks, and is that followed in the present Russian Church, as well as by the Greeks in general (see the catechism published by order of Peter the Great, by Archbishop Resensky, London, 1753). It is at the same time maintained in this catechism that it is not forbidden to bow before the representations of the saints. This division, which appeared in the Bishops' Book in 1537, was adopted by the Anglican Church at the Reformation (1548), substituting *seventh* for sabbath-day in her formularies. The same division was published with approbation by Bonner in his *Homilies* in 1555.

We shall next proceed to describe the two Masoretic divisions. The first is that in Exodus. We call it the Masoretic division, inasmuch as the commandments in the greater number of manuscripts and printed editions are separated by a **D** or **D**, which mark the divisions between the smaller sections in the Hebrew. According to this arrangement, the two first commandments (according to the Origenian or Greek division), that is, the commandment concerning the worship of one God, and that concerning images, make but one; the second is, 'Thou shalt not take the name of the Lord thy God in vain,' and so on until we arrive at the two last, the former of which is, 'Thou shalt not covet thy neighbour's house,' and the last or tenth, 'Thou shalt not covet thy neighbour's wife, nor his servant,' &c., to the end. This was the division approved by Luther, and it has been ever since his time received by the Lutheran Church. The correctness of this division has been at all times maintained by the most learned Lutherans, not only from its agreement with the Hebrew Bibles, but from the internal structure of the commandments, especially from

the fact of the two first commandments (according to Origen's division) forming but one subject. If these form but one commandment, the necessity of dividing the precept, 'thou shalt not covet,' &c., into two is obvious. (For a learned defence of this division, see Pfeiffer's *Opera*, vol. i. loc. 96. p. 125.) Pfeiffer considers the accentuation also of the Hebrew as equally decisive in favour of this division, notwithstanding the opposite view is taken by many others, including the learned Buxtorf. This division is also followed in the Trent catechism, and may therefore be called the Roman Catholic division. The churches of this communion have not, however, been consistent in following uniformly the Tridentine division, having revived, as in this country, the second Masoretic division, to which we shall presently allude. In the Trent catechism the first commandment is, 'Ego sum Dominus Deus tuus, qui eduxi te de terra Ægypti, de domo servitutis; non habebis Deos alienos coram me. Non facies tibi sculptile, &c.' 'Ego sum Dominus Deus tuus, fortis, zelotes,' &c., to 'præcepta mea.' The two last commandments (according to the Roman division) are, however, in the same catechism, combined in one, thus: 'Non concupisces domum proximi tui; nec desiderabis uxorem ejus, non servum, non ancillam, non bovem, non asinum, nec omnia quæ illius sunt. In his duobus præceptis,' &c. It had appeared in the same form in England, in Marshall's and Bishop Hilsey's *Primers*, 1534, and 1539.

Those who follow this division have been accustomed to give the decalogue very generally in an abridged form: thus the first commandment in the Lutheran shorter catechism is simply, 'Thou shalt have no other gods but me;' the second, 'Thou shalt not take the name of thy God in vain;' the third, 'Thou shalt sanctify the sabbath-day' (*Feyertag*). A similar practice is followed by the Roman Catholics, although they, as well as the Lutherans, in their larger catechisms (as the Douay) give them at full length. This practice has given rise to the charge made against those denominations of leaving out the second commandment, whereas it would have been more correct to say that they had mutilated the first, or at least that the form in which they give it has the effect of concealing a most important part of it from such as had only access to their shorter catechisms.

The last division is the *second Masoretic*, or that of Deuteronomy, sometimes called the Augustinian. This division differs from the former simply in placing the precept 'Thou shalt not covet thy neighbour's wife' before 'Thou shalt not covet thy neighbour's house,' &c.; and for this transposition it has the authority of Deut. v. 21. The authority of the Masorites cannot, however, be of sufficient force to supersede the earlier traditions of Philo and Josephus.

This division was that approved by Augustin, who thus expresses himself on the subject,—'Following up what he had said (*supra*, p. 538), he observes, 'but to me it seems more congruous to divide them into three and seven, inasmuch as to those who diligently look into the matter, those which appertain to God seem to insinuate the Trinity. And, indeed, the command, 'Thou shalt have no other gods but me' is more perfectly explained when images are forbidden to be wor-

stopped. Besides, the sin of coveting another man's wife differs so much from coveting his house, that to the house was joined his field, his servant, his maid, his ox, his ass, his cattle, and all that is his. But it seems to divide the coveting of the house from the coveting of the wife, when each begins thus: 'thou shalt not covet thy neighbour's wife, thou shalt not covet thy neighbour's house,' to which it then begins to add the rest. For, when he had said, 'thou shalt not covet thy neighbour's wife, he did not add the rest to this, saying, nor his house, nor his field, nor his servant, &c., but these seem plainly to be united, which appear to be contained in one precept, and distinct from that wherein the wife is named. But when it is said, 'thou shalt have no other gods but me,' there appears a more diligent following up of this in what is subjoined. For to what pertains, 'thou shalt not make an idol, nor a likeness; thou shalt not adore nor serve them,' unless to that which had been said, 'thou shalt have none other gods but me.' The division of Augustin was followed by Bede and Peter Lombard.

The learned Sonntag has entirely followed Augustin's view of this subject, and has written a dissertation in vindication of this division in the *Theologische Studien und Kritiken*, Hamburg, 1836-7; to which there has been a reply in the same miscellany from Züllg, in vindication of what he terms the *Cateinistic division*, or that of Origen, which is followed by a rejoinder from Sonntag. Sonntag is so convinced of the necessity of that order of the words, according to which the precept against coveting the wife precedes (as in Deuteronomy) that against coveting the house, &c., that he puts down the order of the words in Exodus as an oversight. The order in the Septuagint version in Exodus agrees with that in Deuteronomy. The Greek church follows this order. Sonntag conceives that the Mosaic division of the decalogue was lost in the period between the exile and the birth of Christ.

W. W.

DECAPOLIS (*ἡ Δεκάπολις, αἱ δέκα πόλεις*). This appears to denote not, as is frequently stated, a particular province or district, but certain *Ten Cities*, including the adjacent villages (*τὰς κόμας αὐτῶν*, Joseph. *Vit.* § 65), which resembled each other in being inhabited mostly by Gentiles, and in their civic institutions and privileges. In Matt. iv. 25, it is said 'multitudes followed Jesus from Galilee, and from Decapolis, and from Jerusalem, and from Judea, and from beyond Jordan.' This must be considered as a popular mode of expression, just as, in describing a public meeting in this country, it might be said, 'numbers attended it from Kent and Sussex, and from the Cinque Ports.' We, therefore, cannot agree with Dr. Lightfoot in thinking it 'absurd to reckon the most famed cities of Galilee for cities of Decapolis, when, both in sacred and profane authors, Galilee is plainly distinguished from Decapolis' (*Chorographical Decad.* ch. vii. § 1; *Works*, x. p. 238). One at least of the Decapollitan towns (Scythopolis, formerly Bethshan) was in Galilee, and several, if not all the rest, were in the country beyond Jordan. Pliny gives the following list, but allows that a difference of opinion existed as to its correctness — *numero oppidorum, in quo ten omnes eadem observant, Nat. Hist.* v. 16,

18): 1. Damascus; 2. Philadelphia; 3. Raphana; 4. Scythopolis; 5. Gadara; 6. Hippos; 7. Dion; 8. Pella; 9. Galasa; 10. Canatha. Josephus speaks of Gadara and Hippos as Grecian cities (*Ἑλληνίδες εἰσὶ πόλεις, Antiq.* xvii. 11. § 4), and calls Scythopolis the greatest city of the Decapolis (*Bell. Jud.* iii. 9. § 7), from which it may be inferred that he excluded Damascus from the number. For Damascus and Raphana, Cellarius substitutes Cæsarea Philippi and Gergesa, and Ptolemy Capitolias (Winer's *Real-wörterbuch*, i. 308). The name Decapolis was in course of time applied to more than *ten* towns, a circumstance which may in part account for the discrepancies in the lists given by various writers. Stephen of Byzantium, for instance, enumerates *fourteen* Decapollitan cities; and thus in our own country, as far back as the reign of Henry III., the *Cinque Ports* included *seven* principal places, besides subordinate towns. The Decapollitan towns referred to in the Gospels were evidently situated not far from the sea of Galilee (Mark v. 20; vii. 31). The name Decapolis does not occur in the Apocrypha, and, according to Mamert, it is only found in writers of the first century; in later times there is scarcely an allusion to it (*Geographie der Griechen und Römer*, vi. 1, p. 244).—J. E. R.

DEDAN (דִּדָן; Sept. *Δαιδάν*). Two persons of this name are mentioned in Scripture; one the son of Cush (Gen. x. 7), and the other the second son of Jokshan, Abraham's son by Keturah (Gen. xxv. 3). Both were founders of tribes, afterwards repeatedly named in Scripture; and Gesenius, Winer, and others, are of opinion that these were not really different tribes, but the same tribe derived, according to different traditions, from different progenitors. It seems better, however, to adhere to the usual view, by which they are distinguished from each other.

Of the descendants of the Cushite Dedan, very little is known. It is supposed that they settled in southern Arabia, near the Persian Gulf; but the existence in this quarter of a place called Dadan or Dadena, is the chief ground for this conclusion.

The descendants of the Abrahamite Jokshan seem to have lived in the neighbourhood of Idumæa; for the prophet Jeremiah (xlix. 8) calls on them to consult their safety, because the calamity of the sons of Esau, *i. e.* the Idumæans, was at hand. The same prophet (xxv. 23) connects them with Thema and Buz, two other tribes of Arabia Petraea, or Arabia Deserta, as does Ezekiel (xxv. 13) with Theman, a district of Edom. It is not always clear when the name occurs which of the two Dedans is intended; but it is probably the Cushite tribe, which is described as addicted to commerce, or rather, perhaps, engaged in the carrying-trade. Its 'travelling companies,' or caravans, are mentioned by Isaiah (xxi. 13); in Ezekiel (xxvii. 20), the Dedanites are described as supplying the markets of Tyre with flowing riding-cloths: and elsewhere (xxxviii. 13) the same prophet names them along with the merchants of Tarshish.

DEDICATION, a religious ceremony, whereby anything is dedicated or consecrated to the service of God; and it appears to have originated in the desire to commence, with peculiar solemnity,

the practical use and application of whatever had been set apart to the divine service. Thus Moses dedicated the Tabernacle in the Wilderness (Exod. xl.; Num. vii.); Solomon his temple (1 Kings viii.); the returned exiles theirs (Ezra vi. 16, 17); Herod his (Joseph. *Antiq.* xv. 11. 6). The Maccabees having cleansed the temple from its pollutions under Antiochus Epiphanes, again dedicated the altar (1 Macc. iv. 52-9), and an annual festival was established in commemoration of the event. This feast was celebrated not only at Jerusalem, but everywhere throughout the country; in which respect it differed from the feasts of the Passover, Pentecost, and Tabernacles, which could only be observed at Jerusalem.

In John x. 22, 23, we are told that Jesus was at Jerusalem, walking in Solomon's porch at the time of 'the feast of the dedication, and it was winter.' This is usually supposed to have been the feast commemorating the dedication by Judas Maccabæus, which was celebrated in the month Cisleu, about the winter solstice (answering to the 15th of December). There seems no reason to disturb this conclusion; for the dedication of Solomon's temple was in the seventh month, or autumn; that of Zerubbabel's temple in the month Adar, in the spring; and, although that of Herod's temple was in the winter, we know not that it was celebrated by an annual feast, while the Maccabæan dedication was a festival much observed in the time of Christ (Joseph. *Antiq.* xii. 7, 7). In Josephus, this feast is called *φῶτα*, since, for eight days, lanterns and torches were lighted up in the houses in token of joy. Many commentators of reputation take *χειμῶν* to signify, like the Latin *hiems*, not merely winter, but inclement, rainy, wintry weather. In this latter sense it would supply a reason why Jesus was walking in the porch; but as the time of the year would equally account for the fact, and as, moreover, there is at Jerusalem no wintry weather except in winter, it is better to take the word in its usual sense, and to understand the clause 'it was winter' to have been inserted for the information of those who might not know at what season the Jewish feast was celebrated.

Not only were sacred places thus dedicated; but some kind of dedicatory solemnity was observed with respect to cities, walls, gates, and even private houses (Deut. xx. 5; Ps. xxx. title; Neh. xii. 27). We may trace the continuance of these usages in the custom of consecrating or dedicating churches and chapels; and in the ceremonies connected with the 'opening' of roads, markets, bridges, &c., and with the launching of ships.

DEEP. [ABYSS.]

DEFILEMENT. [POLLUTION.]

DEGREES, PSALMS OF. [PSALMS.]

DELILA, the woman whom Samson loved, and who betrayed him to his enemies (Judg. xvi.) [SAMSON].

DELUGE. The narrative of a flood, given in the book of Genesis (vii. and viii.), by which, according to the literal sense of the description, the whole world was overwhelmed and every terrestrial creature destroyed, with the exception of one human family and the representatives of each species of animal, supernaturally preserved in an ark, constructed by divine appointment for the purpose, need not here be followed in detail. The

account furnished by the sacred historian is circumstantially distinct; and the whole is expressly ascribed to divine agency: but, in several of the lesser particulars, secondary causes, as rain, 'the opening of the windows of Heaven' (vii. 11), and the 'breaking up of the fountains of the great deep,' are mentioned, and again the effect of wind in drying up the waters (viii. 1). It is chiefly to be remarked that the whole event is represented as both commencing and terminating in the most gradual and quiet manner, without anything at all resembling the catastrophes and convulsions often pictured in vulgar imagination as accompanying it. When the waters subsided, so little was the surface of the earth changed that the *vegetation* continued *uninjured*: the olive-trees remained from which the dove brought its token.

We allude particularly to these circumstances in the narrative as being those which bear most upon the probable *nature* and extent of the event, which it is our main object in the present article to examine, according to the tenor of what little evidence can be collected on the subject, whether from the terms of the narrative or from other sources of information which may be opened to us by the researches of science.

Much, indeed, might be said on the subject in other points of view; and especially in a more properly theological sense, it may be dwelt upon as a part of the great series of divine interpositions and dispensations which the sacred history discloses. But our present object, as well as limits, will restrict us from enlarging on these topics; or, again, upon the various ideas which have prevailed on the subject apart from Scripture on the one hand, or science on the other. Thus, we need merely allude to the fact that in almost all nations, from the remotest periods, there have prevailed certain mythological narratives and legendary tales of similar catastrophes. Such narratives have formed a part of the rude belief of the Egyptians, Chaldeans, Greeks, Scythians, and Celtic tribes. They have also been discovered among the Peruvians and Mexicans, and the South Sea Islanders. For details on these points we refer our readers to the work of Bryant (*Ancient Mythology*), and more especially to the treatise of the Rev. L. V. Harcourt on the Deluge, who appears to have collected everything of this kind bearing on the subject.

With reference to our present design the most material question is that of the existence of those traces which it might be supposed would be discovered of the action of such a deluge on the existing surface of the globe; and the consequent views which we must adopt according to the degree of accordance or discordance which such evidences may offer, as compared with the written narrative. Even in this point of view much speculation of a very vague and unsatisfactory nature has been occasionally indulged in; and, indeed, the most purely gratuitous speculations were, for a long time, the only attempts towards any inquiry into the subject; nor can we say that the spirit of following them is even yet extinct.

It will, however, be little to our purpose to enlarge upon the crude conceptions and over-hasty generalizations of the earlier cosmogonists and geologists, as, besides the visionary character attaching to the theories of the former, several of the most eminent of the latter class have, with the

ingenuousness of true philosophers, candidly acknowledged the errors into which they had once been led, at periods when the correct nature of inductive reasoning in geology was less attended to than it has been of late; when the science having settled into a more firm and compact structure, and a more rigid scrutiny having been applied to all its defective parts, its real conclusions have been fixed upon an enduring foundation, and visionary speculation from henceforth banished from its precincts.

The evidence which geology may disclose and which can in any degree bear on our present subject must, from the nature of the case, be confined to indications of superficial action attributable to the agency of water, subsequent to the latest period of the regular geological formations, and corresponding in character to a temporary inundation of a *quiet* and tranquil nature, of a depth sufficient to cover the highest mountains, and, lastly (as indeed this condition implies), extending over the whole globe; or, if these conditions should not be fulfilled, then, indications of at least something approaching to this, or with which the terms of the description may be fairly understood and interpreted to correspond.

Our object, then, will be to present, in as brief a summary as possible, what and how much of evidence of the kind here described geological research does really put before us; and then to offer some remarks on the reference it may bear to the terms in which the sacred narrative is conveyed.

Of those geological facts which seem to bear at all upon such an inquiry, the first, perhaps, which strikes us is the occurrence of what was formerly all included under the common name of *diluvium*, but which more modern research has separated into many distinct classes. The general term may, however, not inaptly describe superficial accumulations whether of soil, sand, gravel, or loose aggregations of larger blocks, which are found to prevail over large tracts of the earth's surface, and are manifestly superinduced over the deposits of different ages, with which they have no connection.

An examination of the contents of this accumulated detritus soon showed the diversified nature of the fragments of which it is composed in different localities. Investigations were made by comparing the transported fragments with the nearest rocks from which they could have been derived. Hence was inferred the *direction* of the current which transported them, and the degree of force necessary for such transport, according to their size and nature and the character of the intervening ground. Hence the conclusion was inevitable that many such currents in different directions and acting with different degrees of force must have occurred to produce the observed results. It was soon found from the like infallible indications that these different instances of diluvial action were of very *different ages*, and none of more than *local* extent, though some must have acted over considerable tracts of country. In some instances the most palpable evidence has been furnished in one such stratum crossing and overlying another.

In other instances (perhaps the greater number) there is equal evidence of the operation having gone on at the bottom of deep water, as it does

at present, by currents, eddies, tides, &c. Again, in some cases, masses of what had once formed a diluvium have themselves been cleared off by some new current, and heaped up, leaving the substratum bare. In a word, with reference to cases of this kind, the most recent researches simply point to a continuation of the same great series of long-sustained natural action in the deposition of detritus and the gradual elevation of coasts, covered with the ordinary accumulations of mud, sand, and shingle, which have been referred to as the analogous causes of the earlier formations.

Geologists have collected numerous instances in which such currents are shown to have acted on the surface of many parts of Europe, in different directions; and other results, such as the transportation of blocks over intervening high ridges, have been referred to the floating of ice; while other similar results have been traced up to the action of glaciers in many instances, whatever may be the probability of such action in others.

We will very briefly allude to another branch of the evidence. The extinct volcanoes in the south of France show no indications of having been active at any period of which we can obtain an idea from the surrounding state of things. In several instances rivers have cut their channels through the solid masses of lava of 100 feet in thickness; the time requisite for this is hardly calculable. Other portions of these mountains consist of light pumice and aggregations of cinders which have nevertheless remained wholly undisturbed. The arguments for the antiquity of Etna are of the same kind; the succession of eruptions which have contributed to form the flanks of the mountain by accumulations of lava must have been carried on through an almost immeasurable antiquity. The different numerous extinct craters on its sides present masses of loose scoriæ and ashes. Precisely the same description is found to apply to extinct volcanoes in Asia Minor and other regions. For authorities and details we refer our readers generally to Mr. Lyell's *Principles of Geology*, and the abstracts of Proceedings of the Geological Society, especially those relating to the researches of Messrs. Hamilton and Strickland, in Asia Minor; also to Sir H. de la Beche's *Geological Manual* (especially p. 172, 3rd edit.).

The general result, as bearing on our present subject, is obviously this: the traces of currents, and the like, which the surface of the earth does exhibit, and which *might* be ascribed to diluvial action of some kind, are certainly not the results of *one universal* simultaneous submergence, but of *many, distinct*, local, aqueous forces, for the most part continued in action for long periods, and of a kind precisely analogous to such agency as is now at work. While, further, many parts of the existing surface show no traces of such operations; and the phenomena of the volcanic districts prove distinctly that during the enormous periods which have elapsed since the craters were active, no deluge could possibly have passed over them without removing all those lighter portions of their exuvia which have evidently remained wholly untouched since they were ejected.

Upon the whole it is thus apparent, that we have no evidence whatever of any great aqueous revolution at any comparatively recent period.

having affected the earth's surface over any considerable tract: changes, doubtless, may have been produced on a small scale in isolated districts. The phenomena presented by caves containing bones, as at Kirkdale and other localities, are not of a kind forming any breach in the continuity of the analogies by which all the changes in the surface are more and more seen to have been carried on. But a recent simultaneous influx of water covering the globe, and ascending above the level of the mountains, must have left indisputable traces of its influence, which not only is *not* the case, but *against* which we have seen *positive* facts standing out. Apart from the testimonies of geology there are other sciences which must be interrogated on such a subject. These are, chiefly, terrestrial physics, to assign the possibility of a supply of water to stand all over the globe five miles in depth *above* the level of the ordinary sea;—natural history, to count the myriads of species of living creatures to be preserved and continued in the ark;—mechanics, to construct such a vessel; with some others not less necessary to the case. But we have no disposition to enter more minutely on such points: the reader will find them most clearly and candidly stated in Dr. Pye Smith's *Geology and Scripture*, &c. p. 130, 2nd edit.

Let us now glance at the nature and possible solutions of the difficulty thus presented. We believe only two main solutions have been attempted. One is that proposed by Dr. Pye Smith (ib. p. 294), who expressly contends that there is no real contradiction between these facts and the description in the Mosaic record, *when the latter is correctly interpreted*. This more correct interpretation then refers, in the first instance, to the proper import of the Scripture terms commonly taken to imply the *universality* of the deluge. These the author shows, by a large comparison of similar passages, are only to be understood as expressing *a great extent*; often, indeed, the very same phrase is applied to a very limited region or country, as in Gen. xli. 56; Dent. ii. 25; Acts ii. 5, &c. Thus, so far as these expressions are concerned, the description may apply to a local deluge.

Next, the destruction of the whole existing human race does not by any means imply this universality, since, by ingenious considerations as to the multiplication of mankind at the alleged era of the deluge, the author has shown that they probably had not extended beyond a comparatively limited district of the East.

A local destruction of animal life would also allow of such a reduction of the numbers to be included in the ark, as might obviate objections on that score; and here again the Oriental idiom may save the necessity of the *literal* supposition of every actual species being included.

Again, certain peculiar difficulties connected with the resting of the ark on Mount Ararat are combated by supposing the name incorrectly applied to the mountain now so designated, and really to belong to one of much lower elevation.

Lastly, this author suggests considerations tending to fix the region which may have been the scene of the actual inundation described by Moses, in about that part of Western Asia where there is a large district now considerably depressed below the level of the sea: this might have been sub-

merged by the joint action of rain, and an elevation of the bed of the Persian and Indian Seas. And, finally, he quotes the opinions of several approved divines in confirmation of such a view, especially as bearing upon all the essential religious instruction which the narrative is calculated to convey.

Other attempts have been made with more or less probability to assign particular localities as the scene of the Mosaic deluge, if understood to have been partial. Some diluvial beds posterior to the tertiary formations have been occasionally pointed out as offering some probability of such an origin. Thus, *e. g.* Mr. W. J. Hamilton, secretary to the Geological Society, in his *Tour in Asia Minor* (vol. ii. p. 386), found in the plains of Armenia, especially in some localities near Khorassan and on the banks of the Arpachai or Araxes, a remarkable thin bed of marl containing shells of tertiary (*qu. recent?*) species: these he attributes to a local deluge occurring (as the position of the bed indicates) after the cessation of the volcanic action which has taken place in that district. He expressly adds that he regards this deluge as probably coincident with the Mosaic; understanding the latter in a restricted or partial sense, and imagining it explained by physical causes which might have followed the volcanic action.

How far this or any such phenomenon is reconcilable with the terms of the Mosaic narrative, we leave our readers to decide for themselves; for our own part, we can see but little probability in such suppositions.

Again, with respect to any hypothesis of *local* action, we may observe that the Scripture narrative dwells emphatically on the destruction of the *whole existing human race*. Wherever, therefore, we look for the evidences of a *local* deluge, it must be shown to extend to all the then inhabited part of the world. This might, certainly, be of contracted extent: but the more contracted it might be, in proportion the more full *must* it have been, of *human remains*. Now it is quite notorious that no bed attributable to diluvial action has ever been found containing a single bone or tooth of the human species. We must therefore contend that *no evidence has yet been adduced* of any deposit which can be identified with the Noachian deluge.

The only other mode of viewing the subject is that which, accepting the letter of the Scriptural narrative, makes the deluge strictly universal; and allowing (as they *must* be allowed) all the difficulties, not to say contradictions, in a natural sense, involved in it, accounts for them all by *supernatural* agency. In fact, the terms of the narrative, strictly taken, may perhaps be understood throughout as representing the whole event, from beginning to end, as entirely of a miraculous nature. If so, it may be said, there is an end to all difficulties or question, since there are no limits to omnipotence; and one miracle is not greater than another. Thus, Mr. Lyell (*Principles of Geol.* iv. 219. 4th ed.), after ably recapitulating the main points of evidence, as far as physical causes are concerned, remarks, 'If we believe the flood to have been a temporary suspension of the ordinary laws of the natural world, requiring a miraculous intervention of the divine power, then it is evident that the credibility

of such an event cannot be enhanced by any series of inundations, however analogous, of which the geologist may imagine he has discovered the proofs. For my own part, I have always considered the flood, when its universality, in the strictest sense of the term, is insisted on, as a preternatural event far beyond the reach of philosophical inquiry, whether as to the causes employed to produce it, or the effects most likely to result from it.

In a word, if we suppose the flood to have been miraculously produced, and all the difficulties thus overcome, we must also suppose that it was not only miraculously terminated also, but every trace and mark of it supernaturally effaced and destroyed.

Now, considering the immense amount of supernatural agency thus rendered necessary, this hypothesis has appeared to some quite untenable. Dr. Pye Smith, in particular (whom no one will suspect of any leaning to scepticism), enlarges on the difficulty (p. 157, and note), and offers some excellent remarks on the general question of miracles (p. 84-89); and there can be no doubt that, however plausible may be the assertion that all miracles are alike, yet the idea of supernatural agency to so enormous an amount as in the present instance, is, to many minds at least, very staggering, if not wholly inadmissible. In fact, in stretching the argument to such an extent, it must be borne in mind, that we may be trenching upon difficulties in another quarter, and not sufficiently regarding the force of the evidence on which *any* miracles are supported [MIRACLE].

In any such discussion with regard to the deluge, we cannot avoid taking into account its bearing upon the early history of mankind, the propagation of the race, and the progress of arts and civilization, coupled with the comparatively recent date commonly assigned to this event, viz. about 2400 B.C. On such a subject we can only be guided by the testimony of universal history and experience as to the rapidity of the spread of population, and the probable causes which could lead to advance in civilization among some tribes, and the deterioration, or even total loss of it (as originally possessed by Noah) among others. If, then, we are to date from the Noachian deluge, it is evident that such considerations with regard to the antiquity of the human race must at least claim our serious attention, in connection with the Scripture narrative.

As to the *date* simply, the great discrepancy in the chronology of the patriarchs, between the existing Hebrew, the Samaritan, and the Septuagint versions, has, with many, tended to throw doubts upon all the computations alike, as more or less corrupted or interpolated.

Again, there are circumstances connected with the early history of several nations, which have appeared to some writers to demand a still greater extension of the time. The Jesuit missionaries in China were so strongly impressed with the proofs of high antiquity evinced in the records of that people, that they applied to the Pope for a dispensation to adopt the Septuagint chronology instead of that of the Vulgate; and even confessed that this would not be sufficiently consistent with the antiquity they felt obliged to assign to the Chinese history. The Jesuit Mailla enters

most into detail on the subject, especially as connected with their early inventions in the arts (see *Mélanges Asiatiques*, tom. 1.).

Other writers have dwelt upon the various remains indicating a spread of population and a degree of civilization at periods too early to be consistent with *any received* chronology among the Egyptians, Mexicans, Hindoos, and other nations; and the probability of many of those arts, of which they exhibit traces, having been originally derived from a still more ancient, widely spread, and highly civilized people in Central Asia. Some interesting remarks on this subject will be found in a paper 'On the History of Magnetical Discovery, by T. S. Davies, Esq. F.R.S.' inserted in the British Annual for 1827, p. 246. This able writer argues much from the unequal progress made in civilization and the arts of life under different conditions of national existence, and contends that, in the earlier stages, that progress must have been incalculably slow, and the chronology, consequently, must be almost indefinitely enlarged. Indeed, in a more general point of view, to such an extent is this the case, if we follow it out in imagination to the circumstances of the lowest state of savage life, that others have felt obliged to adopt the supposition of a direct divine interposition to communicate certain first elements of civilization, without which no race ever rises above the savage condition (see Archbp. Whately's *Political Economy*, lect. v. p. 133).

Upon the whole, the discerning inquirer will, on such a subject as the present, more especially, admit the reasonableness of an increasing attention to that important branch of criticism which teaches us to view the composition of the different portions of the sacred writings as of a kind specially adapted to the wants and ideas of the ages to which they respectively belong; and not to overstretch the literal interpretation of them to meet the conceptions of other ages and other stages of the intellectual and moral advancement of mankind; or, in the judicious language of the learned Senier—'Jam si argumentum atque ingenium librorum V. T. intueamur propius, facile patebit hoc, genti Israelitarum præcipue istos libros fuisse destinatos, et ad eorum tempora varia et varios status maxime respicere; minime autem librorum istorum cunctas partes hominibus omnium temporum idem actus æquale præstare beneficium' (*Instit. Brev.* § xxxii.).

In any point of view, it must be admitted that the subject involves difficulties of no inconsiderable amount; and if, after due consideration of the suggestions offered for their solution, we should still feel it necessary to retain a cautious suspense of judgment on the subject, it may be also borne in mind that such hesitation will not involve the dereliction of any material religious doctrine.

If we look to the actual tenor of the whole narrative as delivered by Moses (Gen. viii. and ix.), we shall observe that the manifest *immediate* purport of it is the same as that of the rest of the early portion of his history, viz. as forming part of the *introduction to the law*. Thus we find in the first instance, the narrative dwelling on the distinction of clean and unclean beasts (vii. 2); afterwards on the covenant with Noah; the promise of future enjoyment of the earth and its fruits; the prohibition of eating

blood; the punishment of murder (ix. 4, &c.); all constituting, in fact, some of the *rudiments* out of which the Mosaic law was framed, and which were thus brought before the Israelites as forming an anticipatory sanction for it.

If we look to any further applications of the narrative, we must, of course, be guided by the express representations of the sacred writers in regard to the tenor of such references as they may make to it. Now the only such applications are purely of a practical nature, in which certain points in the narrative are introduced by way of *adaptation* to the subject in hand, as belonging to a history familiarly known, and thus made to furnish topics of argument or admonition to those who had always acknowledged it. Regarded in a Christian light, the narrative is important solely in respect to the applications made of it in the New Testament, and these are only of the following kind: it is referred to as a warning of Christ's coming (Matt. xxiv. 38; Luke xvii. 27); as an assurance of judgment on sin (2 Pet. ii. 5); and of God's long-suffering; while the ark is made a type of baptism and Christian salvation (1 Pet. iii. 20); and lastly, Noah is set forth as an example of faith (Heb. xi. 7).

In these applications no reference is made to the physical nature of the event, nor even to its literal universality. They are all allusions, not to the event abstractedly, but only in the way of *argument with the parties addressed*, in support of other truths: an appeal to the Old Testament addressed to those who already believed in it—in the first of the instances cited, to the Jews—in the others to *Jewish* converts to Christianity (compare 1 Pet. i. 1 and 2 Pet. iii. 1).—B. P.

DEMAS (Δήμας), a Thessalonian Christian, who was for a time associated with St. Paul, but who afterwards abandoned him at Rome, either from being discouraged by the hardships and perils of the service, or in pursuit of temporal advantages (Col. iv. 14; Philem. xxiv.; 2 Tim. iv. 10). The usual unfavourable sense attached to the last text seems the just one.

DEMETRIUS (Δημήτριος), a man's name, denoting a votary of *Ceres*, and very common among the Greeks. The persons of this name mentioned in the history of the Maccabees, and in the New Testament, are—

1. DEMETRIUS SOTER, king of Syria. He was son of Seleucus IV., surnamed Philopator; but, being an hostage at Rome at the time of his father's death, his uncle, the notorious Antiochus Epiphanes, assumed the crown of Syria, and retained it eleven years. After him it was held two years by his son Antiochus Eupator, who was put to death in B.C. 162 by Demetrius, who then arrived in Syria and secured the royal heritage from which he had so long been excluded. He reigned twelve years, B.C. 162-150. The points in which his history connects him with the Jews are alone of interest in this work, and these points belong to the history of the Maccabees [see art. MACCABEES]. To his time belong the latter end of the government of Judas in Israel and the beginning of that of Jonathan. He acted oppressively and unjustly towards them; but, when a rival arose in the person of Alexander Balas, he bade so high for the support of Jonathan as to create a doubt of his sincerity; for which cause, as well as from resentment at the injuries he had

inflicted on them, the Jews espoused the cause of Balas, to whose success they in no slight degree contributed [ALEXANDER BALAS].

2. DEMETRIUS NIGATOR, or NICANOR, son of the preceding, but who was excluded from the throne till B.C. 146, by the success of Alexander Balas, and then recovered it chiefly by the assistance of his father-in-law Ptolemy Philometor. He at first treated the Jews well, but eventually gave them so much cause for dissatisfaction that they readily espoused the cause of Antiochus Theos, son of Alexander Balas. Demetrius underwent many vicissitudes, and passed several years (B.C. 141-135) in captivity among the Parthians, from which he eventually returned and recovered his throne, which he continued to occupy till B.C. 126, when he was defeated in battle by the pretender Alexander Zebina, and afterwards slain at Tyre, whither he had fled [MACCABEES].

3. DEMETRIUS, a silversmith at Ephesus, who, being alarmed at the progress of the Gospel under the preaching of Paul, assembled his fellow-craftsmen, and excited a tumult by haranguing them on the danger that threatened the worship of the great goddess Diana, and consequently their own craft as silversmiths. Their employment was to make 'silver shrines for Diana' (Acts xix. 24); and it is now generally agreed that these 'shrines' (ναοί) were silver models of the temple, or of its adytum or chapel, in which perhaps a little image of the goddess was placed. These, it seems, were purchased by foreigners, who either could not perform their devotions at the temple itself, or who, after having done so, carried them away as memorials or for purposes of worship. The continual resort of foreigners to Ephesus from all parts, on account of the singular veneration in which the image of the goddess was held [ARTEMIS], must have rendered this manufacture very profitable, and sufficiently explains the anxiety of Demetrius and his fellow-craftsmen.

4. DEMETRIUS, a Christian, mentioned with commendation in 3 John 12. From the connection of St. John with Ephesus at the time the Epistle was written, some have supposed that this Demetrius is the same as the preceding, and that he had been converted to Christianity. But this is a mere conjecture, rendered the more uncertain by the commonness of the name.

DEMON. The words δαίμων and δαιμόνιον are used as synonymous both by profane and sacred writers. The etymologies they respectively assign to them, all point to some supposed characteristic of those *intelligent beings* to whom the words are applied. For example, Plato, in his *Cratylus* (vol. i. p. 398, ed. Serran.), derives the word from δαίμων, 'knowing,' in allusion to the superior intelligence, and consequent efficiency, ascribed to demons; Eusebius (*Prep. Evang.* iv. 5), from δειμαλῶ, 'to be terrified;' others, as Proclus (*in Hesiod.*), from δαλα, 'to distribute,' because demons were supposed to assign the lots or destinies of mankind. The words in question are used by heathen writers with great latitude, being applied by them, 1. to every order of beings superior to man, including even the Highest. Aristotle applies δαιμόνιον to the Divinity, Providence (*Rhet.* 2. 23). 2. It is applied to any particular divinity; by Homer

to Venus (*Iliad*, iii.); and in *Il.* xvii. 98, 99, compared with 104, δαίμων and θεός are used as interchangeable words; 3. to the inferior divinities, as in the phrase θεοὶ καὶ δαίμονες; 4. to a class of beings between gods and men: minores diis et majores hominibus (*Liv.* viii. 20; *Adam, Rom. Antiq.* p. 287). Of these latter some were habitually benevolent, and others malignant. The word demon, by itself, occurs usually in a good sense in heathen writers; the evil are distinguished as δαίμονες κακοὶ or πονηροί. To the former class belong the tutelary genii of cities, and the guardian spirits of individuals, as the demon of Socrates. 5. By an easy metonymy it is used to denote fortune, chance, fate. In the Septuagint the word, though comparatively of rare occurrence, is used in a very diversified and indefinite manner: *Deut.* xxxii. 17, ἄνθρωπος, δαίμόνιον; *Ps.* xc. 6, δαίμονιον, where it seems to mean a pestilential blast (comp. *Isa.* xxviii. 2, Heb.); *Ps.* xcv. 5, δαίμόνιον, which Symmachus renders ἀνάρκτοι, and Aquila, ἐπίλαστοι; *Isa.* xii. 21, ἄνθρωπος, δαίμόνιον, Aquila, τριχίωνας; *Isa.* xxxiv. 14, δαίμόνιον; *Isa.* lxxv. 10, ἄνθρωπος, δαίμόνιον, which seems explained by τύχη in the latter part of the verse; *Vulg. fortuna*. In the book of Tobit (iii. 8), we meet with πονηρὸν δαίμόνιον. Since no distinct ideas of the ancient Jewish doctrines concerning demons can be obtained from the Septuagint, we next have recourse to the heathens, and from their writings, owing to the universal prevalence of belief in demons, ample information may be obtained. The following is offered as a summary of their opinions.

1. Demons, in the theology of the Gentiles, are middle beings, between gods and mortals. This is the judgment of Plato, which will be considered decisive—πάν τὸ δαίμόνιον μεταξύ ἐστὶ Θεοῦ τε καὶ θνητοῦ: 'Every demon is a middle being between God and mortal.' He thus explains what he means by a middle being—Θεὸς ἀνθρώπων οὐ μίγνυται, ἀλλὰ διὰ δαίμονιων πᾶσά ἐστιν ἡ ὁμιλία καὶ ἡ διάλεκτος θεοῖς πρὸς ἀνθρώπους: 'God is not approached immediately by man, but all the commerce and intercourse between gods and men are performed by the mediation of demons.' He enters into further particulars—Τὸ δαίμόνιον ἐστὶν ἐρημρέον καὶ διαπορθεύον θεοῖς τὰ παρ' ἀνθρώπων, καὶ ἀνθρώποις τὰ παρὰ θεῶν, τὸν μὲν τὰς δεήσεις καὶ θυσίας, τὸν δὲ τὰς ἐπιτάξεις σε καὶ ἀμοιβὰς τῶν θυσιῶν: 'Demons are reporters and carriers from men to the gods, and again from the gods to men, of the supplications and prayers of the one, and of the injunctions and rewards of devotion from the other' (*Plato, Sympos.* pp. 202, 203, tom. iii. ed. Serran.). 'And this,' says the learned Mede, 'was the *ocumenical* philosophy of the apostles' times, and of the times long before them.'

2. Demons were of two kinds; the one were the souls of good men, which upon their departure from the body were called heroes, were afterwards raised to the dignity of demons, and subsequently to that of gods (*Plutarch, De Defect. Orac.*). *Plato (Cratylus, p. 398, tom. i. edit. Serran.)*, says, 'the poets speak excellently who affirm that when good men die they attain great honour and dignity, and become demons.' It is also admitted that Jamblichus, Hierocles, and

Simplicius use the words angels and demons indiscriminately. *Philo (De Gigantibus)* says that souls, demons, and angels, are only different names that imply one and the same substance; and he affirms (*De Somn.*) that Moses calls those angels whom the philosophers call demons. It was also believed that the souls of bad men became evil demons (*Chalcid, in Platon. Tim.* cap. 135, p. 330). Accordingly δαίμόνιος often occurs in ancient authors as a term of reproach. The other kind of demons were of more noble origin than the human race, having never inhabited human bodies (*Plato, Tim.* pp. 41, 42, 69, 71, 75); *Apuleius, De Deo Socratis, p. 690*).

3. Those demons who had once been souls of men were the objects of immediate worship among the heathens (*Deut.* xxvi. 14; *Ps.* cvi. 28; *Isa.* viii. 19), and it is in contradistinction to these that Jehovah is so frequently called 'the living God' (*Deut.* v. 6, &c. &c.; *Farmer's Essay on the Demoniacs, passim*).

4. The heathens held that some demons were malignant by nature, and not merely so when provoked and offended. *Plutarch* says, 'it is a very ancient opinion that there are certain wicked and malignant demons, who envy good men, and endeavour to hinder them in the pursuit of virtue, lest they should be partakers of greater happiness than they enjoy' (*Plut. Dion.* p. 958, tom. i. edit. Paris, 1624). On this passage *Bishop Newton* remarks, 'This was the opinion of all the later philosophers, and *Plutarch* undeniably affirms it of the very ancient ones' (*Dissert. on the Proph.*, Lond. 1826, p. 476). *Pythagoras* held that certain demons sent diseases to men and cattle (*Diog. Laert. Vit. Pythag.* p. 514, ed. Amstel.). *Zaleucus*, in his preface to his *Laws (apud Stobæum, Serm. xlii.)*, supposes that an evil demon might be present with a witness to influence him to injustice.

In later times *Josephus* uses the word demon always in a bad sense, as do the writers of the New Testament, when using it as from themselves, and in their own sense of it (*De Bell. Jud.* vii. 6, § 3). 'Demons are no other than the spirits of the wicked, that enter into men and kill them, unless they can obtain some help against them.' For proof of the latter assertion we must refer the reader to the contents of the New Testament, and if necessary for a reconciliation of the apparent exceptions, to *Farmer's Essay*; and as the next stage of the inquiry will usher us into the arena of controversy, the opportunity is embraced of announcing that it is not our intention to exhibit ourselves as partizans of either side of any question which may be hereafter introduced, but simply to present an impartial view of the literature it may involve.

It is frequently supposed that the demons of the New Testament are fallen angels: on the contrary it is maintained by *Farmer*, that the word is never applied to the Devil and his angels, and that there is no sufficient reason for restricting the term to spirits of a higher order than mankind. They who uphold the former opinion urge that our Lord, when accused of casting out demons by Beelzebub, the prince of demons, replies, How can Satan cast out Satan (*Mark* iii. 23, &c.)? There is no doubt but that δ σατανᾶς and δ διάβολος are the same, and hence Beelzebub and δ διάβολος are evidently the same being.

Doddridge calls this a demonstration of the point, and consequently maintains, that 'Satan was considered as the prince of the demons who were cast out by Christ, and who are elsewhere represented as his angels (*Family Expositor*, i. 337, Lond. 1799). It is replied, that if this argument proves anything, it proves that the word Satan is equivalent to *δαμόνιον*, and that Satan is here only introduced as an illustration, as are the discords of kingdoms and families (Campbell's *Prelim. Dissert.* p. 190). It must be allowed that so important a conclusion should not be rested on a deduction from precarious principles. It is further urged, that it is but fair and natural to suppose that the writers of the New Testament use the word *dæmons* in the same sense in which it was understood by their contemporaries, which, as it appears from Josephus and other authorities, was, that of the spirits of the wicked; and that if these writers had meant anything else they would have given notice of so wide a deviation from popular usage. The writings of the Fathers show that they sometimes understood the *dæmons* to be fallen angels; at other times they use the word in the same sense as the ancient philosophers. Justin Martyr affirms (*Apol.* i. 2, p. 65) that 'those persons who are seized and thrown down by the souls of the deceased are such as all men agree in calling *dæmoniaks*, or mad.'—J. F. D.

DEMONIACS (*δαμονιζόμενοι*), demonized persons, in the New Testament, are those who were supposed to have a demon or demons occupying them, suspending the faculties of their minds, and governing the members of their bodies, so that what was said and done by the *dæmoniaks* was ascribed to the in-dwelling demon. Plato (*apud Clem. Aler. Strom.* i. 405, Oxon.) affirms that '*dæmoniaks* do not use their own dialect or tongue, but that of the demons who have entered into them.' Lucian says, 'the patient is silent; the demon returns the answer to the question asked.' Apollonius thus addresses a youth supposed to be possessed: 'I am treated contumeliously by the demon, and not by thee' (comp. *Matt.* viii. 28 and 31; *Mark* v. 2; ix. 12; *Luke* viii. 27, 32).

The correctness of the opinion respecting those who are called *δαμονιζόμενοι* in the New Testament which prevailed among the Jews and other nations in the time of our Lord and his Apostles, has been called in question. On the one hand it is urged that the details of the evangelical history afford decisive evidence of the truth and reality of demoniacal possessions in the sense already explained, at least during the commencement of Christianity; on the other hand it is contended that the accounts in question may all be understood as the phenomena of certain diseases, particularly hypochondria, insanity, and epilepsy; that the sacred writers used the popular language in reference to the subject, but that they themselves understood no more than that the persons were the subjects of ordinary diseases. Here issue is joined—and it is to the evidence in this case that our attention will now be directed.

Those who contend that the *dæmoniaks* were really possessed by an evil spirit, urge the following considerations:

1. The *dæmoniaks* express themselves in a way unusual for hypochondriacal, insane, or epileptic persons (*Matt.* viii. 29; *Mark* i. 24); they pos-

sessed supernatural strength (*Mark* v. 4); they adjure Jesus not to torment them; they answer the questions proposed to them in a rational manner; they are distinctly said to have 'come out of' men and to have 'entered into swine,' and that consequently the whole herd, amounting to about two thousand, ran violently down a precipice into the sea (*Matt.* viii. 32; *Mark* v. 13). The supposition which has been maintained by Lardner among others, that the swine were driven into the sea by the *dæmoniaks*, is irreconcilable with the language of the narrative, being also highly improbable in itself: madmen do not act in concert, and rarely pursue the same train of maniacal reasoning.

2. No mental diseases are predicated of the dumb (*Matt.* ix. 32), or of the blind and dumb (*Matt.* xii. 22). Do such diseases ever produce blindness?

3. It is admitted that the symptoms of the youth described *Matt.* xvii. 15; *Mark* ix. 17; *Luke* ix. 39, coincide precisely with those of epilepsy, but they are attributed to the agency of the demon in that very account.

4. The damsel at Philippi is said to have been possessed with a spirit of *divination*, which was the means of obtaining much gain to her masters, and to have understood the divine commission of Paul and his companions (*Acts* xvi. 17). Is this to be ascribed merely to an aberration of mind?

5. The *dæmoniaks* themselves confess that they were possessed with demons (*Mark* v. 9): the same is asserted of them by their relatives (*Matt.* xv. 22). The Apostles and Evangelists assert that persons possessed with demons were brought unto Jesus (*Matt.* iv. 24; *Mark* i. 32), or met him (*Luke* viii. 27). Jesus commands them not to make him known as the Messiah (*Mark* i. 34, margin); rebuked them (*Matt.* xvii. 18). The Evangelists declare that the demons departed from their victims at his command (*Matt.* xvii. 18; *Mark* ix. 25, 26; *Luke* iv. 35; xi. 14); and Jesus himself asserts it (*Luke* xiii. 32).

6. The writers of the New Testament make distinctions between the diseased and the *dæmoniaks* (*Mark* i. 32; *Luke* vi. 17, 18); and Jesus himself does so (*Matt.* x. 8, &c.).

7. The *dæmoniaks* knew Jesus to be the Son of God (*Matt.* viii. 29; *Mark* i. 24; v. 7), and the Christ (*Luke* iv. 41).

8. Jesus addresses the demons (*Matt.* viii. 32; *Mark* v. 18; ix. 25; *Luke* iv. 35): so does Paul (*Acts* xvi. 18). Jesus bids them be silent (*Mark* i. 25); to depart, and enter no more into the person (*Mark* ix. 25).

9. In *Luke* x. the seventy are related to have returned to Jesus, saying, 'Lord, even the demons are subject to us through thy name;' and Jesus replies, ver. 18, 'I beheld Satan, as lightning, fall from heaven.'

10. When Jesus was accused by the Pharisees of casting out demons by Beelzebub, the prince of the demons, he argued that there could be no discord among demoniacal beings (*Matt.* xii. 25, &c.).

11. Jesus makes certain gratuitous observations respecting demons (see *Matt.* xii. 43, 44); which seem like facts in their natural history. In regard to the demon cast out of the youth, which the disciples could not cast out, he says, 'this kind

(*t. e. of demons*) goeth not out but by prayer and fasting.' Can these words be understood otherwise than as revealing a real and particular fact respecting the nature of demons (Matt. xvii. 21)?

12. The woman which had a spirit of infirmity, and was bowed together (Luke xiii. 11), is, by our Lord himself, said to have been bound by Satan (v. 16). In the same way St. Peter speaks of all the persons who were healed by Jesus, as being 'oppressed of the devil' (Acts x. 38).

13. It is further pleaded, that it sinks the importance and dignity of our Saviour's miracles, to suppose that when he is said to have cast out devils, all that is meant is, that he healed diseases.

To these arguments the opponents of the theory of real demoniacal possessions reply, generally, that there can be no doubt that it was the *general belief* of the Jewish nation, with the exception of the Sadducees, and of most other nations, that the spirits of dead men, especially of those who had lived evil lives, and died by violent deaths, were permitted to enter the bodies of men, and to produce the effects ascribed to them in the *popular creed*; but the *fact* and real state of the case was, that those who were considered to be *possessed* were afflicted with some peculiar diseases of mind or body, which, their true *causes* not being generally understood, were, as is usual in such cases, ascribed to supernatural powers; and that Jesus and his apostles, wishing of course to be understood by their contemporaries, and owing to other reasons which can be pointed out, were under the *necessity* of expressing themselves in popular language, and of seeming to admit, or at least of not denying, its correctness. They further plead that the fact, admitted on all hands, that the demon so actuated the possessed, as that whatever *they* did, was not to be distinguished from *his* agency, reduces the question, so far as *phenomena* are concerned, to one simple inquiry, namely, whether these phenomena are such as can be accounted for without resorting to supernatural agency. They assert that the symptoms predicated of demoniacs correspond with the ordinary symptoms of disease, and especially of hypochondria, insanity, and epilepsy; that the sacred writers themselves give intimations, as plain as could be expected under their circumstances, that they employed popular language; and that consequently they are not to be considered as teaching doctrines or asserting facts when they use such language; and that the doctrine of the agency of departed spirits on the bodies of men is inconsistent with certain peculiar and express doctrines of Christ and his apostles.

With regard to the *symptoms* related of the demoniacs, it is urged that such persons as were called demoniacs in other countries, and who seem to have laboured under precisely the same symptoms, are recorded to have been cured by the use of *medicines*. Hellebore quoque purgatur *lymphaticus* error (Seren. Sammon. c. 27. v. 507), 'Insane delusion is remedied by hellebore.' Josephus and the Jewish physicians speak of medicines composed of stones, roots, and herbs, being useful to demoniacs (*Gittei*, f. 67). The cure of *diseases* by such methods is intelligible; but is it rational to believe that the spirits of dead men were dislodged from human bodies by medi-

cal prescriptions? Maimonides (in *Sabat*. ii. 5) says, 'all kinds of diseases which are called melancholy, they call an evil spirit' (comp. Matt. xi. 18; John vii. 20; x. 20).

1. With regard to the two demoniacs at Gadara (or *one*, according to Mark and Luke), it is concluded that they were madmen, who fancied that there were within them innumerable spirits of dead men. Accordingly they dwelt among the *tombs*, about which the souls of the dead were believed to hover, went naked, were un governable, cried aloud, attacked passengers, beat themselves, and had in their phrensy broken every chain by which they had been bound. Strength almost superhuman is a common attendant on insanity. The subject is illustrated by Wetstein, in extracts from Greek medical writers. P. Ægineta, Actuarius, Cælius Aurelianus, also tell that such persons fancied themselves to be gods, demons, wolves, dogs, &c.; hence the disorder was sometimes called *λυκανθρωπία*, or *κυνανθρωπία*. Their question, 'Art thou come to torment us?' refers to the cruel treatment of the insane in those times, and which they had no doubt shared, in the endeavours of men to 'tame' them. Both Mark and Luke the *physician* describe the demoniac as *σφραρονούντα*, in 'his *right mind*,' when healed, which implies previous *insanity* (see also Matt. xii. 22; xv. 28; xvii. 18; Luke vii. 21; viii. 2; ix. 42). It is true that these demoniacs address Jesus as the Son of God, but they might have heard in their lucid intervals that Jesus, whose fame was already diffused throughout Syria, was regarded by the people as the Messiah. They show their insanity, 'their *shaping fancies*,' by imagining they were demons without number, and by requesting permission to enter the swine. Would actual demons choose such an habitation? They speak and answer, indeed, in a rational manner, but agreeably to Locke's definition of madmen, 'they reason right on false principles, and, taking their fancies for realities, make right deductions from them. Thus you shall find a distracted man fancying himself a king, and with a right inference require suitable attendance. Others, who have thought themselves glass, take the needful care to preserve such brittle bodies' (*Essay on Human Understanding*, vol. i. ch. 11, § 12). It is true that Jesus commands the *unclean spirit* (so called because believed to be the spirit of a *dead man*), but he does this merely to excite the attention of the people, and to give them full opportunity to observe the miracle. It is not necessary to suppose that the *madmen* drove the swine, but merely that, *in keeping with all the circumstances*, the *insanity* of the demoniacs was transferred to them, as the leprosy of Naaman was transferred to Gehazi, for the purpose of illustrating the miraculous power of Christ; and though this was a *punitive* miracle, it might serve the good purpose of discouraging the expectation of temporal benefits from him. If the demoniac is represented as worshipping Jesus, it should be remembered that the insane often show great respect to particular persons.

2. The men who were dumb, and both blind and dumb, are not said to have been disordered in their intellects, any more than the blind man in John v. The disease in their organs was *popularly ascribed* to the influence of demons. It is observable that

in the parallel passage (Matt. ix. 32), the evangelist says the *man* was dumb.

3. The symptoms of epilepsy in the youth described Matt. xvii. 15, are too evident not to be acknowledged. If the opinion of relatives is to be pressed, it should be noticed that in this case the father says his 'son is lunatic.' It was most probably a case of combined epilepsy and lunacy, which has been common in all ages. Epilepsy was ascribed to the influence of the moon in those times. The literal interpretation of popular language would therefore require us to believe that he was 'moonstruck,' as well as a demoniac. A curious instance of the influence of popular modes of speech, even on those who are conscious of its incorrectness, is offered in the case of Hippocrates, who, though he wrote a book to prove that epilepsy is *not* a sacred malady, *i. e.* influenced by some divinity, is nevertheless in the habit of applying to it that very appellation. In the same way a learned physician still speaks of lunacy, St. Anthony's fire; and persons of education speak of the rising and setting of the sun, falling stars, as we all use phrases derived from the rites and religion of the Gentiles.

4. The damsel at Philippi is said by Luke to have been possessed with a *πνεῦμα Πύθωνος*, a spirit of *Apollo*. It was *her* fixed idea. The gift of divination is said by Cicero to have been ascribed to *Apollo* (*De Divinat.* i. 5). Insane persons, pretending to prophesy under the influence of *Apollo*, would be likely to gain money from the *credulous*. A belief among the common people that the ravings of insanity were sacred, was not confined to Egypt. The *larvati*, the *lymphatici*, the *ceriti* of the Romans signify possessed persons. The apostle, who taught that an 'idol is nothing in the world,' did not believe in the reality of her soothsaying. Many demoniacs are mentioned, the peculiar symptoms of whose diseases are not stated, as *Mary Magdalene* (Mark xvi. 9), out of whom Jesus cast seven demons, *i. e.* restored from an inveterate insanity (seven being the Jewish number of perfection), supposed to be caused by the united agency of seven spirits of the dead. Yet she is said to have been *healed* (Luke viii. 2).

5. If Jesus forbade the demoniacs to say he was the Christ, it was because the declaration of such persons on the subject would do more harm than good. If he rebuked them he also rebuked the wind (Matt. viii. 26), and the fever (Luke iv. 39). If it be said of them, they departed, so it is also said of the leprosy (Mark i. 42).

6. It may be questioned whether the writers of the New Testament make a distinction between the diseased and those possessed of demons, or whether they specify the demoniacs by themselves, as they specify the lunatics (Matt. iv. 24), merely as a distinct and *peculiar class of the sick*. It is, however, most important to observe that St. Peter includes 'all' who were healed by Jesus, under the phrase *καταδυναστευομένων ὑπὸ τοῦ διαβόλου*, many of whom were not described by the Evangelists as subjects of demoniacal possession, which is urged as a striking instance of the *usus loquendi*. Sometimes the specification of the demoniacs is omitted in the general recitals of miraculous cures (Matt. xi. 5), and this, too, on the important occasion of our Lord sending to John

the Baptist an account of the miraculous evidence attending his preaching (Matt. xi. 5). Does not this look as if they were considered as included under the sick?

7. It cannot be proved that *all* the demoniacs knew Jesus to be the Messiah.

8. It is admitted that Jesus addresses the demons, but then it may be said that his doing so has reference partly to the *persons themselves* in whom demons were supposed to be, and partly to the bystanders; for the same reason that he rebuked the winds in an audible voice, as also the fever. It is also remarkable that in the case of the demoniac (Mark v. 8), it is said—*καὶ ἐπηρώτα αὐτόν*, the man, *τί σοι ἔνομα*, not *αὐτόν*, the *δαμόνιον*. The same words occur in Luke viii. 30.

9. With regard to our Lord's reply to the seventy, it will not be urged that it was intended of a local fall of Satan from heaven, unless it may be supposed to allude to his primeval expulsion; but this sense is scarcely relevant to the occasion. If, then, the literal sense be necessarily departed from, a choice must be made out of the various figurative interpretations of which the words admit; and taking the word Satan here in its generic sense, of *whatever* is inimical or opposed to the Gospel, Jesus may be understood to say, I foresaw the glorious results of your mission in the triumphs which would attend it over the most formidable obstacles. Heaven is often used in the sense of political horizon (Isa. xiv. 12, 13; Matt. xxiv. 29). To be cast from heaven to hell is a phrase for total downfall (Luke x. 15; Rev. xii. 7-9). Cicero says to Mark Antony, You have hurled your colleagues down from heaven. Satan is here used tropically. Our Lord does not, therefore, assert the real operation of demons.

10. In the refutation of the charge that he cast out demons by Beelzebub, the prince of the Pharisees, he simply argues with the Pharisees upon their *own principles*, and 'judges them out of their own mouth,' without assuming the *truth* of those principles.

11. The facts he seems to assert respecting the wandering of demons through dry places (Matt. xii. 45), were already admitted in the popular creed of the Jews. They believed that demons wandered in desolate places (Baruch iv. 35). Upon these ideas he founds a parable or similitude, without involving an opinion of their accuracy, to describe 'the end of this generation.' The observations respecting prayer and fasting seem to have relation to that faith in God which he exhorts his apostles to obtain. Prayer and fasting would serve to enable them to perceive the divine suggestion which accompanied every miracle, and which the apostles had not *perceived* upon this occasion, though given them, because their animal nature had not been sufficiently subdued.

12. The application of the term Satan to the case of the woman who had a spirit of infirmity, is plainly an *argumentum ad hominem*. It is intended to heighten the antithesis between the *loosing* of an ox from his stall, and *loosing* the daughter of Abraham whom *Satan*, as they believed, had *bound* eighteen years.

13. The objection taken from the supposed consequence of explaining the casting out of demons to signify no more than the cure of dis-

eases, that it tends to lower the dignity of the Saviour's miracles, depends upon the reader's complexion of mind, our prior knowledge of the relative dignity of miracles, and some other things, perhaps, of which we are not competent judges.

It remains to be observed, that the theory of demoniacal possessions is opposed to the known and express doctrines of Christ and his Apostles. They teach us that the spirits of the dead enter a state corresponding to their character, no more to return to this world (Luke xvi. 22, &c.; xxiii. 43; 2 Cor. v. 1; Phil. i. 21). With regard to the fallen angels, the representations of their confinement are totally opposed to the notion of their wandering about the world and tormenting its inhabitants (2 Pet. ii. 4; Jude, ver. 6). If it be said that Jesus did not correct the popular opinion, still he nowhere denies that the phenomena in question arose from diseases only. He took no side; it was not his province. It was not necessary to attack the misconception in a formal manner; it would be supplanted whenever his doctrine respecting the state of the dead was embraced. To have done so would have engaged our Lord in prolix arguments with a people in whom the notion was so deeply rooted, and have led him away too much from the purposes of his ministry. 'It was one of the many things he had to say, but they could not then bear them.' It is finally urged that the anti-demoniacal theory does not detract from the divine authority of the Saviour, the reality of his miracles, or the integrity of the historians. *Sub judice lis est.* (Jahn's *Biblisches Archæologie*; Winer's *Biblisches Realwörterbuch*, art. 'Besessene'; Moses Stuart's *Sketches of Angelology in Bibliotheca Sacra*, London and New York, 1813).—J. F. D.

DENARIUS (*δηνάριον*), the principal silver coin of the Romans, which took its name from having been originally equal to ten ases. It was in later times (after B.C. 217) current also among the Jews, and is the coin which is called 'a penny' in the Auth. Vers. The denarii were first coined in B.C. 269, or four years after the first Punic war, and the more ancient specimens are much heavier than those of later date. Those coined in the early period of the commonwealth have the average weight of 60 grains, and those coined under the empire of 52.5 grains. With some allowance for alloy, the former would be worth 8.6245 pence, or 8½*d.*, and the latter, 7.5 pence, or 7½*d.* It has been supposed, how-

peror (Matt. xxii. 19; Mark xii. 16), but formerly it was impressed with the symbols of the republic.

DERBE (*Δέρβη*), a small town of Lycaonia, in Asia Minor, at the foot of the Taurian mountains, 60 miles south by east from Iconium, and 18 miles east of Lystra. It was the birth-place of Gaius, the friend and fellow-traveller of Paul (Acts xx. 4); and it was to this place that Paul and Barnabas fled when expelled from Iconium, A.D. 41 (Acts xiv. 6).

DESERTS. In the East, wide, extended plains are usually liable to drought, and consequently to barrenness. Hence the Hebrew language describes a plain, a desert, and an unfruitful waste, by the same word, עֲרָבָה *arabah*. The term which is in general rendered 'wilderness,' מִדְבָּר *midbar*, means, properly, a grazing tract, uncultivated and destitute of wood, but fit for pasture—a heath or steppe. The pastures of the wilderness are mentioned in Ps. lxxv. 13; Joel i. 19; Luke xv. 4; and may be very well explained by reference to the fact, that even the Desert of Arabia, which is utterly burnt up with excessive drought in summer, is in winter and spring covered with rich and tender herbage. Whence it is that the Arabian tribes retreat into their deserts on the approach of the autumnal rains, and when spring has ended and the droughts commence, return to the lands of rivers and mountains, in search of the pastures which the deserts no longer afford. The same word may therefore denote a region which is desert, and also one which, at stated seasons, contains rich and abundant pastures. But in fact the word translated in our Bibles by 'desert' or 'wilderness' often means no more than the common, uncultivated grounds in the neighbourhood of towns on which the inhabitants grazed their domestic cattle.

A great desert or wilderness is generally expressed by the word יְשִׁימוֹן *yeshimon*, from יָשַׁם *yasham*, 'to be waste' or 'desolate' (1 Sam. xxiii. 19, 24; Isa. xlvi. 19, 20). This word is especially applied to that desert of Stony Arabia in which the Israelites sojourned under Moses (Num. xxi. 20; xxiii. 28; Ps. lxxvii. 7, lxxviii. 40, &c.). This was the most terrible of the deserts with which the Israelites were acquainted, and the only real desert in their immediate neighbourhood. It is described under ARABIA; as is also that Eastern desert extending from the eastern border of the country beyond Judæa to the Euphrates. It is emphatically called 'the Desert,' without any proper name, in Exod. xxiii. 31; Deut. xi. 24.

The several deserts or wildernesses mentioned in Scripture are the following, which will be found under their respective names: the deserts of Edom, Etham, Judah, Kadesh, Maon, Paran, Shur, Sin, Sinai.

DEVIL. [DEMON; SATAN.]

DEUTERO-CANONICAL BOOKS, a term applied in modern times to denote those sacred books which, originally denominated *ecclesiastical* and *apocryphal*, were not in the Jewish or Hebrew Canon, but, as being contained in the old Greek versions, were publicly read in the early Christian Church [CANON, APOCRYPHA].

It is acknowledged by all that these books never had a place in the Jewish Canon. The Roman Catholic Professor Alber, of Pesth (who considers them as of equal authority with the received



246.

ever, that the reduction of weight did not take place till the time of Nero; and in that case the denarii mentioned in the Gospels must have been of the former weight and value, although 7½*d.* is the usual computation. A denarius was the day-wages of a labourer in Palestine (Matt. xx. 2, 9, 13), and the daily pay of a Roman soldier was less (Tacit. *Ann.* i. 17). In the time of Christ the denarius bore the image of the em-

books of the Hebrew Canon), observes:—‘The Deutero-canonical books are those which the Jews had not in their Canon, but are notwithstanding received by the Christian Church, concerning which, on this very account of their not having been in the Jewish Canon, there has existed some doubt even in the Church’ (*Institut. Hermeneut. vol. i. ch. viii. ix.*). Josephus, a contemporary of the apostles, after describing the Jewish Canon (*Contr. Ap. i. 8*), which he says consists of 22 books, remarks: ‘but from the reign of Artaxerxes to within our memory there have been several things committed to writing, which, however, have not acquired the same degree of credit and authority as the former books, inasmuch as the tradition and succession of the prophets were less certain.’ It has been shown by Hornemann (*Observat. ad illust. doct. de Canon. V. T. ex Philone*) that, although Philo was acquainted with the books in question, he has not cited any one of them, at least with the view of establishing any proposition.

Among the early Christian writers, Jerome, in his Prefaces, gives us the most complete information that we possess regarding the authority of these books in his time. After enumerating the 22 books of the Hebrew Canon, consisting of the Law, the Prophets, and the Hagiographa, he adds: ‘This prologue I write as a preface to the books to be translated by us from the Hebrew into Latin, that we may know that all the books which are not of this number are *apocryphal*; therefore Wisdom, which is commonly ascribed to Solomon as its author, and the book of Jesus the son of Sirach, Judith, Tobit, and the Shepherd, are not in the Canon.’ Again, in the preface to his translation of the books of Solomon from the Hebrew, he observes:—‘These three books (Proverbs, Ecclesiastes, and Canticles) only are Solomon’s. There is also the *Book of Jesus the son of Sirach*, and another pseud-epigraphical book, called the *Wisdom of Solomon*; the former of which I have seen in Hebrew, called not Ecclesiasticus, as among the Latins, but the Parables; with which likewise have been joined Ecclesiastes and the Song of Songs, that the collection might the better resemble the books of Solomon both in matter and design. The second is not to be found at all among the Hebrews, and the style plainly evinces its Greek original: some ancient writers say it is a work of Philo the Jew. As, therefore, the Church reads Judith and Tobit, and the books of Maccabees, but does not receive them among the Canonical Scriptures; so likewise it may read these two books for the edification of the people, but not as of authority for proving any doctrines of religion (*ad adificationem plebis, non ad auctoritatem ecclesiasticorum dogmatum confirmandam*).’ Of Baruch he says, that he does ‘not translate it, because it was not in Hebrew, nor received by the Jews.’ He never translated Wisdom, Ecclesiasticus, or either of the books of Maccabees, and observes, that ‘such books as are not of the twenty-four* letters are to be utterly rejected’ (*Pref. to Ezra*). In his *Preface to*

Judith he says, in like manner, ‘Among the Hebrews this book is read among the *hagiographa* (or, according to some manuscripts, *apocrypha*), whose authority is not judged sufficient to support disputed matters.’ He adds, at the same time, that ‘the Council of Nice is said to have included it in the catalogue of the holy Scriptures.’ We have, however, no authority for supposing that the Council of Nice ever formed such a catalogue. There is no account of the matter in any of its acts which have reached us. There is, indeed, a catalogue, as is observed by Mr. Jones, attributed by Pappus, in his *Synodicon*, to this Council, with this relation:—‘That the bishops there assembled were, by a very extraordinary miracle, convinced which were inspired and which were apocryphal books, after this manner:—Having put all the books that laid claim to inspiration under the communion-table (*ῥῆ θεία τραπέζῃ*) in a church, they prayed to God that those which were of divine inspiration might be found above, or upon, the table, and those which were apocryphal might be found under; and accordingly, as they prayed, it came to pass.’ This is universally acknowledged to be a fable, and Cardinal Bellarmine (*De Verbo Dei*) admits that there could have been no canon determined on by the Nicene Council, as in that case none would have ventured to have rejected it; but he supposes that Jerome may have found in some of its acts, now lost, some citation from the book of Judith. Bellarmine further admits that in Jerome’s time the ecclesiastical books, although read in the churches, were neither in the *Jewish nor Christian Canons*, inasmuch as no General Council had yet determined anything concerning them.

We have already noticed Jerome’s remarks respecting the additions to the book of Daniel [*DANIEL, Apocryphal Additions to*]. In reference to these it was that Jerome’s contemporary Rufinus, once his familiar friend, but now his bitter enemy, remarked in his second invective against him—‘Who, in that host of learned men, presumed to *compile* the divine instrument which the Apostles delivered to the churches, and the deposit of the Holy Spirit? Is it not a *compilation*, when certain parts are altered, and an error said to be corrected? for the whole history of Susanna, which afforded such an example of chastity to the Church of God, has been cut off. Is the authority of one man now to supersede the whole of the Seventy translators, who, shut up in separate cells, translated the whole Bible without differing in a single word? [Alluding to a fable now long exploded]. Peter governed the Roman Church for twenty-four years. It is not to be doubted that he gave the Church the Scriptures, and they were recited while he sat and taught. What! did Peter deceive the Church, and give false books, knowing that the true ones were acknowledged by the Jews? But he will perhaps say, Peter was an unlettered man. What, then, will he say of Paul? I will receive no truth which Peter and Paul did not teach. The following are your own words:—“After four hundred years the simple ears of the Latins are not to be offended with new doctrine;” but now you say—“Every one who believes that Susanna, married or unmarried, afforded no example of chastity, has erred.” It is not true. And—

*. The variations in the numerical divisions of these books, many of which are extremely fanciful, do not affect the identity of the canon itself.

"Every one who thought that the boy Daniel was filled with the Holy Spirit, and convicted the elders, has erred." It is not true. "The Church Universal throughout the world, consisting either of those who are in the body or those who are in the Lord, whether holy confessors or holy martyrs, who have sung the Hymn of the Children, have all erred, and sung falsely!" Therefore, after four hundred years, the truth of the law, bought at a price, proceeds from the Synagogue.

To this angry invective Jerome replied—"I only state what the Hebrews are accustomed to say against the history of Susanna, and the Song of the Children, and the fable of Bel and the Dragon, which are not found in the Hebrew volume. My accuser shows himself to be a silly sycophant. I did not give my own opinion, but what they are accustomed to say against us." For his own views on this subject, none of which he retracts, he refers Rufinus to his Preface.

It will be observed that these invectives of Rufinus have no reference to any other writings than the history of Susanna and the Song of the Three Children. In fact, Rufinus himself made the same distinction in regard to the books of Scripture that Jerome did. After enumerating the books of the Old and New Testament exactly according to the Jewish canon, saying, "These are the volumes which the Fathers have included in the canon, and out of which they would have us prove the doctrines of our faith," he adds—"however, it ought to be observed, that there are also other books which are not *canonical*, but have been called by our forefathers *ecclesiastical*; as the Wisdom of Solomon, and another called the Wisdom of the Son of Sirach, which among the Latins is called by the general name of *Ecclesiasticus*, by which title is denoted not the author of the book, but the quality of the writing. Of the same order is the book of Tobit, Judith, and the books of the Maccabees. In the New Testament is the book of the Shepherd of Hermas, which is called the 'Two Ways, or the Judgment of Peter;' all which they would have to be read in the churches, but not alleged by way of authority for proving articles of faith. Other Scriptures they call *apocryphal*, which they would not have to be read in churches" (*In Symb. Apost.*).

There have thus been three divisions made by the ancients, viz. the Canonical Scriptures, the Ecclesiastical, and the Apocryphal, or otherwise, the Canonical and the Apocryphal, of which latter there are two kinds, viz. those which, having nothing contrary to the faith, may be profitably read, although not authentic, and those which are injurious and contrary to the faith. It is, however, maintained by Professor Alber that, when Jerome and Rufinus said the Ecclesiastical books were read for edification, but not for confirming articles of faith, they only meant that they were not to be employed in controversies with the Jews, who did not acknowledge their authority. These Fathers, however, certainly put them into the same rank with the Shepherd of Hermas.

The earliest catalogue which we possess of the books of Scripture is that of Melito, Bishop of Sardis, preserved by Eusebius. From his statement, written in the year 170, it seems evident that there had been then no catalogue authorized by the Church or any public body. He enu-

merates the books of the Jewish Canon only, from which, however, he omits the book of Esther [ESTHER].

The first catalogue of the Holy Scriptures, drawn up by any public body in the Christian church, which has come down to us, is that of the Council of Laodicea, in Phrygia, supposed to be held about the year 365. In the two last canons of this Council, as we now have them, there is an enumeration of the books of Scripture nearly conformable, in the Old Testament, to the Jewish canon. The canons are in these words,—

"That private Psalms ought not to be said in the church, nor any books not canonical, but only the canonical books of the Old and New Testament. The books of the Old Testament, which ought to be read, are these—1. Genesis; 2. Exodus; 3. Leviticus; 4. Numbers; 5. Deuteronomy; 6. Joshua, son of Nun; 7. Judges, with Ruth; 8. Esther; 9. 1 and 2 Kingdoms; 10. 3 and 4 Kingdoms; 11. 1 and 2 Remains; 12. 1 and 2 Esdras; 13. the book of 150 Psalms; 14. Proverbs; 15. Ecclesiastes; 16. Canticles; 17. Job; 18. the Twelve Prophets; 19. Isaiah; 20. Jeremiah and *Baruch*, the Lamentations and the Epistles; 21. Ezekiel; 22. Daniel." We have already given the books of the New Testament as enumerated by this Council (see *ANTILOGOMENA*).

This catalogue is not, however, universally acknowledged to be genuine. "Possibly learned men," says Lardner, "according to the different notions of the party they have been engaged in, have been led to disregard the last canon; some because of its omitting the Apocryphal books of the Old Testament, and others because it has not the book of Revelation." Basnage, in his *History of the Church*, observes that "Protestants and Catholics have equally disparaged this synod." "It is said," remarks Lardner, "that the canons of this Council were received and adopted by some General Councils in after times; nevertheless perhaps it would be difficult to show that those General Councils received the last canon, and exactly approved the catalogue of said books therein contained, without any addition or diminution, as we now have it" (see Mansi's *Concilia*, ii. 574).

But, besides the Hebrew canon, the reader will have observed that there were certain other books publicly read in the primitive church, and treated with a high degree of respect, although not considered by the Hebrews, from whom they were derived (see the passage above cited from Josephus) as of equal authority with the former. These books seem to have been included in the copies of the Septuagint, which was generally made use of by the sacred writers of the New Testament. It does not appear whether the Apostles gave any cautions against the reading of these books; and it has been even supposed that they have referred to them. Others, however, have maintained that the principal passages to which they have referred (for it is not pretended that they have cited them) are from the canonical books. The following are the passages here alluded to:— (*See next page.*)

Some of the uncanonical books, however, had not been extant more than a hundred and thirty years at most at the Christian era, and could only have obtained a place in the Greek Scrip-

Rom. xi. 24	. . .	compared with Wisdom ix. 13	. . .	see Isaiah xl. 13
Heb. i. 13	. . .	"	vii. 26	. . .
" xi. 5	. . .	"	iv. 10	. . . see Gen. v. 24
Rom. xiii. 1	. . .	"	vi. 3	. . . see Prov. viii. 15, 16
" ii. 11	}	"	vi. 7	. . . see Deut. x. 17
Gal. ii. 6				
Eph. vi. 9				
Coloss. iii. 23				
1 Peter i. 24	}	"	Ecclus. xiv. 17	. . . see Isaiah xl. 6
James i. 10				
1 Cor. x. 10	. . .	"	Judith viii. 25	. . . (Lat.) Num. xiv. 15
James ii. 23	. . .	"	" v. 22	. . .
Luke x. 41	. . .	"	Tobit iv. 7	. . .
1 Thess. iv. 3	. . .	"	" iv. 17	. . .
Matt. vii. 12	. . .	"	" iv. 15	. . .
1 Cor. x. 20	. . .	"	Baruch iv. 7	. . .
John x. 22	. . .	"	1 Macc. iv. 59	. . .
Heb. xi. 35	. . .	"	2 Macc. vi. 7	. . . Ecclus. xiv. 15
Matt. ix. 13	. . .	"	Prayer of Manasses.	. . .
2 Cor. xiii. 6	. . .	"	3 Esdras iii. 12	. . .

tures a short time before this period; but the only copies of the Scriptures in existence for the first three hundred years after Christ, either among the Jews or Christians of Greece, Italy, or Africa, contained these books without any mark of distinction that we know of. The Hebrew Bible and language were quite unknown to them during this period, and the most learned were, probably, but ill-informed on the subject, at least before Jerome's translation of the Scriptures from the original Hebrew. The Latin versions before his time were all made from the Septuagint. We do not, indeed, find any catalogue of these writings before the Council of Hippo, but only individual notices of separate books. Thus Clement of Alexandria (*Stromata*, A.D. 211), cites the Wisdom of Solomon and Ecclesiasticus, and Origen refers to several of these books, treating them with a high degree of veneration. 'There is,' says Eusebius, 'an epistle of Africanus, addressed to Origen, in which he intimates his doubt on the history of Susannah in Daniel, as if it were a spurious and fictitious composition; to which Origen wrote a very full answer.' These epistles are both extant. Origen, at great length, vindicates these parts of the Greek version—for he acknowledges that they were not in the Hebrew—from the objections of Africanus, asserting that they were true and genuine, and made use of in Greek among all the churches of the Gentiles, and that we should not attend to the fraudulent comments of the Jews, but take that only for true in the holy Scriptures which the Seventy had translated, for that this only was confirmed by Apostolic authority. In the same letter he cites the book of Tobit, and in his second book *De Principiis*, he even speaks of the Shepherd of Hermas as divinely inspired. Origen, however, uses very different language in regard to the book of Enoch, the Testament of the Twelve Patriarchs, and the Assumption of Moses.

The local Council of Hippo, held in the year of Christ 393, at which the celebrated Augustine, afterwards Bishop of Hippo, was present, formed a catalogue of the sacred books of the Old and New Testament, in which the *ecclesiastical books* were all included. They are inserted in the following order in its 36th canon, viz. —

'That nothing be read in the church besides the Canonical Scriptures. Under the name

of Canonical Scriptures are reckoned Genesis, Exodus, Leviticus, Numbers, Deuteronomy, Joshua, Judges, Ruth, 4 books of Kings, Remains, Job, Psalms of David, 5 books of Solomon, 12 books of the Prophets, Isaiah, Jeremiah, Daniel, Ezekiel, Tobit, Judith, Hesther, Esdras, 2 books, Maccabees, 2 books.' [For the books of the New Testament see *supra*, ANTILEGOMENA.] 'But for the confirmation of this canon the churches beyond the seas are to be consulted.' The passions of the martyrs were also permitted to be read on their anniversaries.

The third Council of Carthage, generally believed to have been held in 397, at which Aurelius, bishop of Carthage, presided, and at which Augustine was present, consisting in all of forty-four bishops, adopted the same catalogue, which was confirmed at the fourth Council of Carthage, held in the year 419. The reference said to have been made from the *third* Council of Carthage, held in 397, to Pope Boniface [ANTILEGOMENA], is a manifest anachronism in the copies of the acts of this council (see L'Abbe's *Concilia*), as the pontificate of Boniface did not commence before 417. It has been, therefore, conjectured that this reference belongs to the fourth council.

As St. Augustine had great influence at these Councils, it must be of importance to ascertain his private sentiments on this subject. This eminent man, who was born in 354, consecrated bishop of Hippo (the present Bona) in 395, and died in 430, in the seventy-sixth year of his age, writes as follows in the year 397:— 'The entire Canon of Scripture is comprised in these books. There are 5 of Moses, viz. Genesis, Exodus, Leviticus, Numbers, Deuteronomy; 1 of Joshua, 1 of Judges, 1 small book called Ruth, which seems rather to belong to the beginning of the Kingdoms, the 4 books of the Kingdoms, and 2 of the Remains, not following one another, but parallel to each other. These are historical books which contain a succession of times in the order of events. There are others which do not observe the order of time, and are unconnected together, as Job, Tobit, Esther, and Judith, the 2 books of Maccabees, and the 2 books of Ezra, which last do more observe the order of a regular succession of events, after that contained in the Kingdoms and Remains. Next are the Prophets, among which is 1 book of the Psalms of David, and 3

of Solomon, viz. Proverbs, Canticles, and Ecclesiastes; for these 2 books, Wisdom and Ecclesiasticus, are called Solomon's for no other reason than because they have a resemblance to his writings: for it is a very general opinion that they were written by Jesus the son of Sirach, which books, however, since they are admitted into authority, are to be reckoned among prophetic books. The rest are the books of those who are properly called prophets, as the several books of the 12 Prophets, which being found together, and never separated, are reckoned 1 book. The names of which prophets are these: Hosea, Joel, Amos, Obadiah, Jonah, Micah, Nahum, Habakkuk, Zephaniah, Haggai, Zechariah, Malachi. After these the four Prophets of large volumes, Isaiah, Jeremiah, Daniel, Ezekiel. In these 44 books is comprised all the authority of the Old Testament' (*De Doctr. Christ.*). [For the New, see ANTILOGOMENA: they are the same with those now received.]

It has been, indeed, maintained that Augustine altered his opinion on the subject of the deuterocanonical books in his Retractions (see HENDERSON *On Inspiration*, p. 495); but the only passage in this work bearing on the subject, which we can discover, is that wherein he confesses his mistake in terming Ecclesiasticus a prophetic book.

Augustine has been also supposed to have testified to the inferior authority of these books, from his saying that one of them was read from the reader's place. 'The sentiment of the book of Wisdom is not to be rejected, which has deserved to be recited for such a long course of years from the step of the readers of the church of Christ, and to be heard with the veneration of divine authority from the bishop to the humblest of the laics, faithful, penitents, and catechumens' [MACCABEES].

What the result of the reference from Africa to the 'churches beyond the seas' may have been, we can only judge from the letter which is said to have been written on the subject by Innocent I., bishop of Rome, to St. Exupere, bishop of Toulouse, in the year 405. In this letter, which, although disputed, is most probably genuine, Innocent gives the same catalogue of the books of the Old and New Testaments as those of the councils of Hippo and Carthage, omitting only the book of Esther.

The next catalogue is that of the Roman Council, drawn up by Pope Gelasius and seventy bishops. The genuineness of the acts of this council has been questioned by Pearson, Cave, and the two Basnages, but vindicated by Pagi and Jeremiah Jones. The catalogue is identical with the preceding, except in the order of the books.

Some of the most important manuscripts of the Holy Scriptures which have descended to us were written soon after this period. The very ancient Alexandrian MS. now in the British Museum contains the following books in the order which we here give them, together with the annexed catalogue:—

'Genesis, Exodus, Leviticus, Numbers, Deuteronomy, Joshua, Judges, Ruth; 8 books.—Kingdoms, 4; Remains, 2; 6 books.—16 Prophets, viz., Hosea, 1; Amos, 2; Micah, 3; Joel, 4; Obadiah, 5; Jonah, 6; Nahum, 7; Amos, 8; Zechariah, 9; Haggai, 10; Zechariah, 11; Malachi,

12; Isaiah, 13; Jeremiah, 14; Ezekiel, 15; Daniel, 16; Esther; Tobit; Judith; Ezra, 2; Maccabees, 4; Psalter and Hymns; Job; Proverbs; Ecclesiastes; Canticles; Wisdom; Wisdom of Jesus Sirach; 4 Gospels; Acts, 1; 7 Catholic Epistles; 14 Epistles of Paul; Revelation; 2 Epistles of Clement; together * * * * books; Psalms of Solomon.' These books are equally incorporated in all the manuscripts of the Latin Vulgate (which was originally translated from the Septuagint). Those which Jerome did not translate from the Hebrew or Greek, as Wisdom and Ecclesiasticus, were adopted from the older Latin version.

Although the Canon of Scripture seemed now to be so far settled by the decrees of these Councils, all did not conceive themselves bound by them; and it is observed by Jahn (*Introd.*) that they were not otherwise to be understood than 'that the ecclesiastical books enumerated in this catalogue were to be held as useful for the edification of the people, but not to be applied to the confirmation of doctrines of faith.' Such appears at least to have been the sentiment of many eminent divines between this period and the sixteenth century.

Bishop Cosin, in his excellent *Scholastic History of the Canon*, furnishes to this effect a host of quotations from writers of the middle ages, including Ven. Bede, John of Damascus, Alcuin, Peter Mauritius, Hugh de St. Victor, Cardinal Hugo de St. Cher, the author of the ordinary *Gloss*, and Nicholas Lyraus. Of these some call the Deuterocanonical books 'excellent and useful, but not in the canon;' others speak of them as 'apocryphal, that is, doubtful Scriptures,' as not having been 'written in the time of the prophets, but in that of the priests, under Ptolemy,' &c., as not 'equalling the sublime dignity of the other books, yet deserving reception for their laudable instruction,' classing them with the writings of Jerome, Augustine, Ambrose, and Bede, and making a marked distinction not only between the Jewish and Christian Canons, but even between parts of the Deuterocanonical writings. Mr. Archibald Alexander also (*Canon of the Old and New Testament ascertained*) cites several of the same authorities: he has, however, in one instance, evidently mistaken Peter Lombard for Peter Comestor, the author of the *Scholastic History*. At the era of the Reformation, we find James Faber of Etaples and Cardinal Cajetan expressing themselves to the same effect, and the learned Sanctes Pagnini, in his translation of the Bible from the original languages, published at Lyons in 1528 (the first Bible that contained the division into verses with the present figures), dedicated to Pope Clement VII., distinguished the ecclesiastical books, which he says were not in the canon, by the term *Hagiographa*. For a description of this rare work, see *Christian Remembrancer*, vol. iv. p. 419, in a treatise 'On the division of verses in the Bible,' by the author of the present article.

We are now arrived at the period of the Reformation, when the question of the Canon of Scripture was warmly discussed. Long before this period (viz. in 1380), Wickliff had published his translation of the Bible, in which he substituted another prologue for Jerome's; wherein, after enumerating the 'twenty-five' books of the

Hebrew Canon, he adds—'Whatever book is in the Old Testament, besides these twenty-five, shall be set among the Apocrypha, that is, without authority of belief.' He also, in order to distinguish the Hebrew text from the Greek interpolations, inserted Jerome's notes, *rubricated*, into the body of the text.

Although Martin Luther commenced the publication of his translation of the Bible in 1523, yet, as it was published in parts, he had not yet made any distinction between the two classes of books, when Lonicus published his edition of the Greek Septuagint at Strasburg in 1526, in which he separated the Deutero-canonical, or Apocryphal, books, from those of the Jewish Canon; for which he was severely castigated by Morinus (see Masch's edition of Le Long's *Bibliotheca Biblica*, vol. ii. p. 268). Arias Montanus went still further, and rejected them altogether. In 1534 the complete edition of Luther's Bible appeared, wherein those books which Jerome had placed *inter apocrypha* were separated, and placed by themselves between the Old and New Testament, under the title 'Apocrypha; that is, Books which are not to be considered as equal to holy Scripture, and yet are useful and good to read.'

A few years after, the divines of the Council of Trent assembled; and among the earliest subjects of their deliberation was the Canon of Scripture. 'The Canon of Augustine,' says bishop Marsh, 'continued to be the Canon of the ruling party. But as there were not wanting persons, especially among the learned, who from time to time recommended the Canon of Jerome, it was necessary for the Council of Trent to decide between the contending parties' (*Comparative View*, p. 97). The Tridentine Fathers had consequently a nice and difficult question to determine.

On the 8th April, 1546, all who were present at the fourth session of the Council of Trent adopted the canon of Augustine, declaring, 'He is also to be anathema who does not receive these entire books, with all their parts, as they have been accustomed to be read in the Catholic Church, and are found in the ancient editions of the Latin Vulgate, as sacred and canonical, and who knowingly and wilfully despises the aforesaid traditions. . . .'

We are informed by Jahn (*Introduction*), that this decree did not affect the distinction which the learned had always made between the canonical and deutero-canonical books, in proof of which he refers to the various opinions which still prevail in his church on the subject, Bernard Lamy (*Apparatus Biblicus*, ii. 5) denying, and Du Pin (*Prolegomena*) asserting, that the books of the second Canon are of equal authority with those of the first. Those who desire further information will find it in the two accounts of the controversies which took place at the council on this subject; one from the pen of Cardinal Pallavicini, the other by Father Paul Sarpi, the two eminent historians of the Council. Professor Alber, to whom we have already referred, having denied that any such distinction as that maintained by his brother Professor, Jahn, can lawfully exist among Roman Catholic divines, insists that both canons possess one and the same authority. The words of Bernard Lamy, however, cited by Jahn are—'The books

of the second Canon, although united with the first, are not, however, of the same authority' (*Apparat. Bibl.* ii. 5, p. 333). Alber endeavours to explain this as meaning only that these books had not the same authority before the Canon of the Council of Trent, and cites a passage from Pallavicini to prove that the anathema was 'directed against those Catholics who adopted the views of Cardinal Cajetan' (vol. ii. p. 105). But, however this may be, among other opinions of Luther condemned by the Council was the following:—'That no books should be admitted into the Canon of the Old Testament but those received by the Jews; and that from the new should be excluded—the Epistle to the Hebrews, those of James, 2 Peter, 2 and 3 John, Jude and the Apocalypse.'

The whole of the books in debate, with the exception of 3rd and 4th Esdras, and the Prayer of Manasses, are considered as canonical by the Council of Trent. But it must be recollected, that the decision of the Council of Trent is one by no means peculiar to this council. The third Council of Carthage had considered the same books canonical. 'The Council of Trent,' says bishop Marsh, 'declared no other books to be sacred and canonical than such as had existed from the earliest ages of Christianity, not only in the Latin version of the Old Testament, but even in the ancient Greek version, which is known by the name of the Septuagint. . . . In the manuscripts of the Septuagint, there is the same intermixture of canonical and apocryphal books, as in the manuscripts of the Latin version' [although there are in different manuscripts variations in the particular arrangement of single books]. The Hebrew was inaccessible to the Latin translators in Europe and Africa during the three first centuries.'

The ecclesiastical books were generally written within a period which could not have extended to more than two centuries before the birth of Christ. In the choice of the places which were assigned them by the Greek Jews resident in Alexandria and other parts of Egypt, who probably added these books to the Septuagint version according as they became gradually approved of, they were directed 'partly by the subjects, partly by their relation to other writings, and partly by the periods in which the recorded transactions are supposed to have happened.' Their insertion shows how highly they were esteemed by the Greek Jews of Egypt; but whether even the Egyptian Jews ascribed to them canonical and divine authority, it would not be easy to prove (*Marsh's Comparative View*).

The following were the proceedings of the Anglican Church in reference to this subject:—

In Coverdale's English translation of the Bible, printed in 1535, the deutero-canonical books were divided from the others and printed separately, with the exception of the book of Baruch, which was not separated from the others in this version until the edition of 1550. They had however been separated in Matthew's Bible in 1537, prefaced with the words, 'the volume of the book called *Hagiographa*.' This Bible contained Olivetan's preface, in which these books were spoken of in somewhat disparaging terms. In Cranmer's Bible, published in 1539, the same words and preface were continued; but, in the edition of 1549, the word *Hagiographa* was

changed into *Apocrypha*, which passed through the succeeding editions into King James's Bible. Olivetan's preface was omitted in the Bishop's Bible in 1568, after the framing of the canon in the Thirty-nine Articles in 1562.

In the Geneva Bible, which was the popular English translation before the present authorized version, and which was published in 1559, these books are printed separately with a preface, in which, although not considered of themselves as sufficient to prove any point of Christian doctrine, they are yet treated with a high degree of veneration. In the parallel passages in the margin of this translation, references are made to the deuterocanonical books.

In the first edition of the Articles of the Church of England, 1552, no catalogue of the 'Holy Scripture' had yet appeared, but in the Articles of 1562, the canon of St. Jerome was finally adopted in the following order: 5 books of Moses, Joshua, Judges, Ruth, 1 and 2 Samuel; 1 and 2 Kings, 1 and 2 Chronicles, 1 and 2 Esdras, Esther, Job, Psalms, Proverbs, Ecclesiastes, Cantica, four Prophets the Greater, twelve Prophets the Less. In the 6th article it is declared that, 'In the name of the Holy Scripture we do understand those canonical books of the Old and New Testament, of whose authority was never any doubt in the Church,' and that 'the other books (as Jerome saith) the Church doth read for example of life and instruction of manners, but yet it doth not apply them to establish any doctrine.' The books which the article then enumerates are 1 and 2 [3 and 4] Esdras, Tobias, Judith, the rest of the book of Esther, Wisdom, Jesus the son of Sirach, Baruch the Prophet, the Song of the Children, the Story of Susanna, Bel and the Dragon, the Prayer of Manasses, and 1 and 2 Maccabees. It is not, however, altogether correct, in point of fact, in including in the number of books thus referred to by Jerome as read by the Church for edification the third and fourth books of Esdras. These books were equally rejected by the Church of Rome and by Luther, who did not translate them. The Church of England further declares, that 'all the books of the New Testament, as they are commonly received, we do receive and account them canonical.' The Church of England has herein followed the Councils of Hippo and Carthage. The phrase 'of whose authority was never any doubt in the Church,' refers therefore more strictly to the books of the Old Testament than the New, for we have already seen that doubts *did* exist respecting the ANTILOGOMENA of the New Testament. In the first book of Homilies, published in 1547, and the second in 1560, both confirmed by the Thirty-fifth Article of 1562, the deuterocanonical books are cited as 'Scripture,' and treated with the same reverence as the other books in the Bible; and in the preface to the book of Common Prayer, they are alluded to as being 'agreeable to' the Holy Scriptures.

The Helvetic Confession, dated 1st March, 1566, has the following expression respecting the apocryphal books:—'We do not deny that certain books of the Old Testament were named by the ancients apocryphal, by others ecclesiastical, as being read in the churches, but not adduced for authority in matters of belief: as Augustine, in the 18th book of the *City of God*, ch. 38, relates, that the names and books of cer-

tain prophets were adduced in the books of Kings, but adds that these were not in the Canon, and that those we have were sufficient for piety.' The Confession of the Dutch Churches (dated the same year) is more full. After recounting the canonical books, 'respecting which no controversy existed,' it adds, 'We make a distinction between those and such as are called Apocryphal, which may indeed be read in the Church, and proofs adduced from them, so far as they agree with the canonical books; but their authority and force are by no means such that any article of faith may be certainly declared from their testimony alone, still less that they can impugn or detract from the authority of the others.' They add, as their reason for receiving the canonical books, that 'it is not so much because the Church receives them, as that the Holy Spirit testifies to our consciences that they have come from God; and chiefly on this account, because they of themselves bear testimony to their own authority and sanctity, so that even the blind may see the fulfilment of all things predicted in them, as it were with the senses.'

The Westminster Confession proceeded on the same principle, but treated the books of the second Canon with less ceremony. After enumerating the canonical books (ascribing thirteen epistles only to Paul), they proceed to say, that 'the books called Apocrypha, not being of Divine confirmation, are no part of the Canon of Scripture; and therefore are of no authority in the Church of God; nor to be any otherwise approved, or made use of, than other human writings.' And again: 'The authority of Holy Scripture, for which it ought to be believed and obeyed, depended not on the testimony of any man or church, but wholly upon God, the author thereof, and therefore it is to be received, because it is the word of God. We may be moved and induced by the Church to a high and reverent esteem of the Holy Scriptures; and the heavenliness of the matter, the efficacy of the doctrine, the majesty of the style, &c. &c., are arguments whereby it doth abundantly evidence itself to be the word of God; yet, notwithstanding, our full persuasion and assurance of the infallible truth and Divine authority thereof is from the inward work of the Holy Spirit, being witness by and with the word in our hearts.'

Luther (on 1 Cor. iii. 9, 10) had declared that the *touchstone* by which certain Scriptures should be acknowledged as divine or not was the following:—'Do they preach Jesus Christ or not?' And, among the moderns, Dr. Twisten (*Vorlesungen über die Dogmatik*, 1829, vol. i. p. 421, sqq.) has maintained a somewhat similar principle (see Gausson's *Theopneustia*). The Confession of Augsburg, dated in 1531, contains no article whatever on the Canon of Scripture; nor do the Lutherans appear to have any other canon than Luther's Bible. For the sentiments of the GREEK CHURCH, see ESDRAS; ESTHER; MACCABEES.

We shall add a few words on the grounds and authorities adopted by different parties for deciding whether a work is canonical or not. Mr. Jeremiah Jones furnishes us with three different views on this subject. 'The first,' he says, 'is the opinion of the Papists, who have generally affirmed, in their controversies with the Protestants,

that the authority of the Scriptures depends upon, or is derived from, the power of their Church. By the authority of the Church, those authors plainly mean a power lodged in the Church of Rome, and her synods, of determination, what books are the word of God; than which nothing can be more absurd or contrary to common sense: for if so, it is possible, nay, it is easy for them, to make a book which is not Divine to be so.' And he maintains that 'it is possible, on this principle, that Æsop's fables, or the infidel books of Celsus, Julian, and Porphyry might become a part of the New Testament.' But the fact must not be lost sight of, that the Church has never pretended to exercise a power of this description. Bishop Marsh, referring to this subject, observes: 'That the Council of Trent assumed the privilege of raising to the rank of canonical authority what was generally acknowledged to have no such authority, is a charge which cannot be made without injustice: the power of declaring canonical a book, which has never laid claim to that title, is a power not exercised even by the Church of Rome. In this respect it acts like other churches: it sits in judgment on existing claims, and determines whether they are valid or not.' From certain expressions of divines, who have asserted that the Scriptures would have no authority whatever without the testimony of the Church, it has been supposed that they ascribed to the Church an arbitrary power over these Divine books: Bellarmine, therefore, has drawn a distinction between the objective and subjective authority of the Scriptures, their authority in themselves, and that which they have in respect to us. Thus, Augustine said that he would not believe the Gospel, but for the authority of the Church; adding, however, that the invitation of the Church was but the first step to his complete illumination by the Spirit of God (*Confessions*, ii. 8).

Another principle was that adopted by all the reformed communions (except the Anglican Church), viz. to use Mr. Jones's words, that '*there are inward or innate evidences in the Scriptures, which, applied by the illumination or testimony of the Holy Spirit, are the only true proofs of their being the Word of God*;' or, to use the words of the French reformed communion in its Confession, which harmonize with the methods adopted by the Scotch and Belgian communions, that upon the internal persuasion of the Spirit *they knew the Canonical from Ecclesiastical, i. e. Apocryphal, books*. This method Mr. Jones thinks to be of a very extraordinary nature. 'Can it be supposed,' he asks, 'that out of ten thousand books, private Christians, or even our most learned reformers, should by any internal evidence agree precisely on the number of twenty-seven, which are now esteemed canonical, induced thereto by some characters those books contain, of their being written by the inspiration of the Holy Ghost?' This he conceives to be folly and madness, and an assumption of 'immediate inspiration.' 'It first supposes the books are inspired, and then proves that they are so because they are so.' This is only an argument, says bishop Burnet, to him that feels it, if it be one at all. 'For my part,' said the celebrated Richard Baxter, 'I confess I could never boast of any such testimony or light of the Spirit, nor reason neither, which, without human testimony, would have made me believe

that the book of Canticles is canonical and written by Solomon, and the book of Wisdom apocryphal and written by Philo. Nor could I have known any historical books, such as Joshua, Judges, Ruth, Samuel, Kings, Chronicles, Ezra, Nehemiah, &c. to be written by divine inspiration, but by tradition,' &c. The third method is that approved of by Mr. Jones, viz. that tradition, or the testimony of the ancient Christians, preserved in their writings, is the best method of determining this subject. 'This,' adds Mr. Jones, 'is the method the first Christians constantly made use of to prove, against the heretics, the truth of the sacred books, viz. by appealing to that certain and undoubted tradition which assured them they were the writings of the persons whose names they bear. Thus we know that Ovid, Virgil, or Livy wrote the books under their names.' To this, we think, might have been added internal evidence and the application of critical skill. The chief objection which has been urged against this method is, that it leaves the canonicity of each book to the decision of every private individual, which is inconsistent with the idea of a canon. Certain it is that the ancient church, in deciding on the present Canon, exhibited a wonderful theological tact, as the books which it has handed down as canonical, and these alone, are generally the same which, after having undergone the strictest ordeal that the learning and acumen of modern times have been enabled to apply to them, are acknowledged by the best critics to be authentic. In fact the Church has adopted the same methods for this purpose which Mr. Jones has considered to be the only ones satisfactory to private individuals. Christians are thus in possession of the highest degree of satisfaction. Mr. Gausson (*Theopneustia*, p. 340), admits that the principle laid down by the reformed churches is untenable, and he substitutes for it 'for the Old Testament, the Testimony of the Jews; and for the New, the Testimony of the Catholic Church; by which he understands, the general consent, in regard to the former, of all Jews, Egyptians and Syrians, Asiatics and Europeans, ancient and modern, good and bad;' and by the testimony of the Catholic Church he understands, 'the universal consent of ancient and modern churches, Asiatic and European, good and bad: that is, not only the sections which have adhered to the Reformation, but the Greek section, the Armenian section, the Syrian section, the Roman section, and the Unitarian section.' And in pp. 342, 345, he ascribes entire infallibility to both Jewish and Christian churches, in respect to the Canon of Scripture. 'The Jews could not introduce a human book into the Old Testament, and neither the Council of Trent, nor even the most corrupt and idolatrous churches, could add a single Apocryphal book to the New. . . . It was not in their power not to transmit them intact and complete. In spite of themselves it was so ordered,' &c.

The question, however, in dispute is not so much with regard to the Jewish Canon, regarding which no controversy exists, as whether there is or is not sufficient testimony to the fact, how far our Saviour and his Apostles gave the stamp of their authority to any books not contained in this canon. We have no certain evidence as to the authority on which, or the time when, the Jewish Canon

was collected, or of the cause of its closing, and our best evidence in favour of the canonicity of the Hebrew Scriptures rests on the authority of Christ, as contained in the Scriptures of the New Testament.

We shall conclude with the following metrical catalogue from the pen of Cardinal Hugo:—

Quinque libros Moysi, Josue, Judicum, Samuelem,

Et Melachim, tres præcipuos bis sexque Prophetas

Hebræus reliquis censet præcellere libris.

Quinque vocat legem, reliquos vult esse Prophetas.

Post Agiographa, sunt Daniel, David, Esther, et Esdras;

Job, Paralipomenon, et tres libri Salomonis.

Lex vetus his libris perfectè tota tenetur.

Restant Apocrypha, Jesus, Sapientia, Pastor, Et Machabæorum libri, Judith atque Tobias.

See, in addition to the works already cited, Vicenzi's *Introductio in Scrip. Deutero-canon.* Rome, 1842, which we had not the advantage of seeing until this article had gone to press.—

W. W.

DEUTERONOMY (*Δευτερονόμιον*), the Greek name given by the Alexandrian Jews to the fifth book of Moses (a corresponding name, *כְּתוּבַת הַדְּבָרִים*, is, however, also found with the Rabbins), by which the general tenor of the book is very well characterized. It comprises that series of addresses which the Lawgiver delivered (orally and by writing, i. 5; xxviii. 58, etc.) to assembled Israel in the second month of the fortieth year of their wandering through the desert, when the second generation was about to cross the Jordan, and when the parting-hour of Moses had nearly arrived. The book of Deuteronomy contains an account of the sublime and dignified manner in which Moses terminated that work, the accomplishment of which was his peculiar mission. It forms a sacred legacy which he here bequeathed to his people; and very different from those laws which he had announced to them at Sinai. The tone of the *law* falls here considerably in the background, and the *subjectivity* (individuality) of the *Lawgiver*, and his peculiar relation to his people, stands out more prominently. A thoroughly sublime and prophetic spirit pervades all these speeches from beginning to end. The thoughts of the man of God are entirely taken up with the inward concerns of his people, their relations, future fate, and eventful vicissitudes. The Lawgiver here stands amidst Israel, warning and consoling, commanding and exhorting, surveying and proclaiming the future with marvellous discernment.

The speeches begin with the enumeration of the wonderful dealings of God with the chosen people in the early period of their existence. Moses clearly proves to them the punishment of unbelief, the obduracy of Israel, and the faithfulness of Jehovah with regard to his promises, which were now on the point of being accomplished. Fully aware of the tendencies of the people, and foreseeing their alienations, Moses conjures them most impressively to hold fast the commands of the Lord, and not to forget his revelations, lest curses should befall them instead of blessings (ch. i.-iv.). The Lawgiver then expatiates on the spirit of the law, and its reception into the hearts

of men, both in a positive and negative way. *Fear*, he says, is the primary effect of the law, as also its *aim*. As Israel had once listened to the announcement of the fundamental laws of the theocracy with a sacred *fear*, in like manner should man also receive, through the whole system of the law, a lively and awful impression of the holiness and majesty of God (ch. v.). But as the essence and sum of the law is *love* to Jehovah, the only and true God, man shall by the law be reminded of the Divine mercy, so variously manifested in deeds; and this reflection is calculated to rouse in man's heart *love* for God. This love is the only and true source from which proper respect and obedience to the law can proceed (ch. vi.).

There were, however, two tempting deviations, in following which the people were sure to be led astray. The law, in its strict rigour, was but too apt to tempt them to desert Jehovah, and to yield to idolatry (the very approval of which even in thought polluted the heart), by discontinuing to bear the heavy yoke of the law. Hence the most impressive warnings against Canaan's inhabitants and idols; and hence the declarations that Israel, in placing themselves on a par with the heathens, should have to endure an equal fate with them, and be repulsed from the presence of Jehovah (ch. vii. viii.).

The other, not less dangerous, deviation is that of self-justification—the proud fancy that all the favours Jehovah had shown to his people were merely in consequence of their own deservings. Therefore Jehovah tells them that it was not through their own worthiness and purity of heart that they inherited the land of the heathens. It was only through his free favour; for their sins bore too strong and constant testimony how little they ought to take credit to themselves for it (ch. ix.).

The history of the people, before and after the exile, shows these two deviations in their fullest bearings. Idolatry we find to have been the besetting sin *before* that period, and presumptuous pride of heart *after* it; a proof how intimately acquainted the Lawgiver was with the character and disposition of his people, and how necessary therefore those warnings had been.

Therefore, adds Moses, turn to that which Jehovah, in giving you the tables of the law, and establishing the Tabernacle and priesthood, has intimated as a significant symbol, 'to circumcise the foreskin of your heart,' and to cherish love in your inward soul. Think of Jehovah, the just and merciful, whose blessings and curses shall be set before your eyes as a lasting monument upon the mounts Ebal and Gerizim (ch. x., xi.).

The mention of that fact leads the Lawgiver to the domestic and practical life of the people when domesticated in their true home, the Land of Promise; which he further regulates by a fixed and solid rule, by new laws, which for this, their new design and purport, form a sort of complement to the laws already given. There, in the land of their forefathers, Jehovah will appoint *one* fixed place for his lasting sanctuary, when every other place dedicated to the worship of idols is to be destroyed. At that chosen spot alone are the sacrifices to be killed, while cattle in general, which are not destined for sacred purposes, but merely for food, may be slaughtered

at all places according to convenience—a regulation which still leaves in full force the previous laws concerning the eating of blood, and the share of Jehovah in slaughtered cattle. This sanctuary was to be considered as the central point for all sacred objects. The whole land was, by means of the sanctuary established in the midst of it, consecrated and dedicated to Jehovah. This consecration was incompatible with any defilement whatsoever. On that account the Canaanites must be exterminated, and all idolatrous abominations destroyed, since nothing ought to be added to or taken from the laws of God (ch. xii.). For the same reason (*i. e.* for the sake of the holiness of the land, diffused from the sacred centre), no false prophets or soothsayers are to be tolerated, as they may turn the minds of the people from *the* law, by establishing a different one, and therefore even a whole town given to the worship of idols must be demolished by force of arms (ch. xiii.). Neither, in like manner, must the heathen customs of mourning be imitated, or unclean beasts eaten; but the people must always remain true to the *previous* laws concerning food, &c., and show their real attachment to Jehovah and his religion by willingly paying the *tithe* as ordained by the law (ch. xiv.). To the same end likewise shall the regulations concerning the years of release and the festivals of Jehovah (to be solemnized in the place of the new-chosen Sanctuary) be most scrupulously observed (ch. xv., xvi.). Only *unblemished* sacrifices shall be offered, for all idol-worshippers must irrevocably be put to death by stoning. For the execution of due punishment, honest judges must govern the nation, while the highest tribunal shall exist in the place chosen for the Sanctuary, consisting of the priests and judges of the land. If a king be given by God to the people, he shall first of all accommodate himself to the laws of God, and not lead a heathen life. Next to the regal and judicial dignities, the ecclesiastical power shall exist in its full right; and again, next to it, the prophetic order (ch. xvii. xviii.). Of all these institutions, the duties of the judicial power are most clearly defined; for Jehovah does as little suffer that in his land the right of the innocent shall be turned aside, as that indulgence shall be shown to the evil-doer (ch. xix.). The exposition of the civil law is followed by that of the martial law, which has some bearing upon the then impending war with Canaan, as the most important war and representing that with the heathen nations in general (ch. xx.). These are again followed by a series of laws in reference to the preceding, and referring chiefly to hard cases in the judicial courts, by which Moses obviously designed to exhibit the whole of the civil life of his people in its strict application to the theocratic system of law and right. Therefore the form of prayer to be spoken at the offering up of the firstlings and tithe—the theocratic *confession of faith*—by which every Israelite acknowledges in person that he is what God has enjoined and called him to be, forms a beautiful conclusion of the whole legislation (ch. xxi.-xxvi.).

The blessings and curses of Jehovah, the two opposite extremes which were to be impressed upon the minds of the people at their entrance into Canaan, and which have hitherto been spoken of only in general terms, are now set forth in their

fullest detail, picturing in the most lively colour the delightful abundance of rich blessings on the one hand, and the awful visitations of Heaven's wrath on the other. The prophetic speeches visibly and gradually increase in energy and enthusiasm, until the perspective of the remotest future of the people of God lies open to the eye of the inspired Lawgiver in all its chequered details, when his words resolve themselves into a flight of poetical ecstasy, into the strains of a splendid triumphal song in which the tone of grief and lamentation is as heart-rending as the announcement of divine salvation therein is jubilant (ch. xxvii. xxviii.). The history of the law concludes with a supplement concerning him who was deemed worthy by the Lord to transmit his law to Israel (ch. xxxiv.).

Thus much regarding the contents and connection of the book of Deuteronomy.

The critics who have tried to show that the Pentateuch is composed of miscellaneous documents and by various authors, have more difficulty in applying their theory to this book than to any other of the series [PENTATEUCH]. Indeed the most sceptical critics admit that, with the exception of a few interpolations (comp. for instance, De Wette, *Introd.* § 154, sq.), the whole of this book was moulded, as it were, in one single cast.

The *date*, however, of the composition of Deuteronomy, as well as its *authenticity*, has given rise to a far greater variety of opinion, more especially among those who are opposed to the authorship of Moses. The older critics, such as De Wette, Gesenius, &c., considered Deuteronomy as the *latest* production of all the books of the Pentateuch; while the more recent critics, such as Von Bohlen, Vatke, George, &c., have come to just the contrary opinion, and declare it to be the *earliest* of the Mosaic writings. The whole of their disputes on this head turn chiefly on the prophetic character of Deuteronomy. Some find that this peculiar feature characterizes the book as contemporary with the later prophets, and that it contains reflections on the law, as on a thing long in existence: others, however, are of a quite contrary opinion, and discover in this *subjective* character, so predominant in Deuteronomy, the very proof of its prior and early composition; and they consider, moreover, that the prophetic enunciations contained in it were afterwards developed into *objective*, rigid, and matter-of-fact laws, such as we find them in Exodus and Numbers. For this reason, they add, is the legislative tone in Deuteronomy more simple than in the other books, embracing merely the incipient elements and suggestive notes of a complete code of law.

A very strong proof of the genuineness of the book lies in its relation to the later writings of the prophets. Of all the books of the Pentateuch, Deuteronomy has been made most use of by the prophets, simply because it is best calculated to serve as a model for prophetic declarations, as also because of the inward harmony that exists between the *prophecies* and the *laws* upon which they are based.

Deuteronomy exercised a most decisive and remarkable influence more especially on Jeremiah, owing not only to his priestly character, but also and chiefly to the peculiar circumstances of his

time, so admirably suited to illustrate the threats and warnings contained in that book, in the strongest light of sacred and immutable truth. Deuteronomy was a book altogether written for the times of Jeremiah, who could therefore do nothing better than resume the old text, and bring it home impressively to the people. The influence which the spirit of Deuteronomy thus exercised on that prophet, extended even to the adoption, on his part, of a considerable number of its expressions and phraseological terms. These linguistic coincidences have been most erroneously accounted for by some, by assuming the contemporary origin of both books, while others (Von Bohlen) have gone so far in their speculations as even to allot to Jeremiah a share in the composition, or rather interpolation, of Deuteronomy. Such views betray total ignorance of the peculiar and strictly defined character of Deuteronomy, so different in many respects, even as regards the style and language, from the book of Jeremiah, though it cannot be denied that no prophet ever adhered more closely to the prototypes of the earlier periods, or ever repeated more frequently the earlier enunciations, than did Jeremiah.

Among the arguments advanced against the authenticity of Deuteronomy, are:

1. The *contradictions* said to exist between this and the other books of Moses;

2. Certain *anachronisms* committed by the author.

These contradictions are more especially alleged to exist in the festival laws, where but arbitrary and unwarranted views are mostly entertained by such critics with regard to the nature and original meaning of the festivals, which they identify altogether with *natural* or *season* festivals, and without lending to them a more spiritual character and signification.

3. That the *Sinai* of the other books is always called *Horeb* in Deuteronomy.—They forget, however, that *Horeb* is the general name of the whole mountain, while *Sinai* is the special name of a particular part of it. This distinction is, indeed, most scrupulously observed everywhere in the Pentateuch.

4. That *Priests* and *Levites* are used as synonymous terms in Deuteronomy (on account of the expression הַכֹּהֲנִים הַלְוִיִּם); while, in the other books of the Pentateuch, they are used as terms distinct from each another.—By that expression, however, can only be meant the *Levitical* priests, *i. e.* the only legitimate priests; this meaning is borne out by Deuteronomy xviii. 3-8, where a clear distinction is made between *Priests* and *Levites*.

5. That in Deuteronomy i. 44, are mentioned the *Amorites* instead of the *Amalekites* as in Num. xiv. 45.—Here also they have forgotten to notice that, in the sequel of the very passage alluded to in Deuteronomy, both the *Amorites* and *Amalekites* are mentioned.

6. That the cause of the punishment of Moses is differently stated in Num. xxvii. 14, and Deuteronomy iii. 26.—To this objection we reply, that both the guilt and punishment of Moses are described in both books as originating with the people; comp. also Deut. xxxii. 51, etc.

Among the anachronisms in Deuteronomy are reckoned the allusions made in it to the Temple (xii. xvi. 1, sqq.), to the royal and prophetic

powers (xiii. xviii. xviii), to the different modes of idol-worship (iv. 19; xvii. 3), and to the exile (xxviii. sq.). In suggesting these critical points, however, they do not consider that all these subjects are most closely and intimately connected with the spirit and principles of the law itself, and that all these regulations and prophecies appear here in Deuteronomy, as necessary finishing-points to the Law, so indispensable for the better consolidation of the subsequent and later relations of the theocracy.

More *anachronisms* are said to be

1. The sixty dwelling-places of Jair mentioned Deut. iii. 14, sq. (comp. Judg. x. 3, sq.) We consider, however, that the men mentioned in the two passages are evidently different persons, though of the same name. Nor is it difficult to prove from other sources, that there really existed at the time of Moses a man by name Jair.

2. The notice (iii. 11) concerning king Og, which looks more like a note of a subsequent writer in corroboration of the story told in the chapter. But this hypothesis falls to the ground when we consider that Moses did not write for his contemporaries merely, but also for late posterity.

The book contains, moreover, not a small number of plain, though indirect traces, indicative of its Mosaic origin. We thus find in it:

1. Numerous notices concerning nations with whom the Israelites had then come in contact, but who, after the Mosaic period, entirely disappeared from the pages of history: such are the accounts of the residences of the kings of Bashan (i. 4).

2. The appellation of 'mountain of the Amorites,' used throughout the whole book (i. 7, 19, 20, 44), while even in the book Joshua, soon after the conquest of the land, the name is already exchanged for 'mountains of Judah' (Josh. xi. 16, 21).

3. The observation (ii. 10), that the *Emim* had formerly dwelt in the plain of Moab: they were a great people, equal to the *Anakim*. This observation quite accords with Genesis xiv. 5.

4. A detailed account (ii. 11) concerning the *Horim* and their relations to the *Edomites*.

5. An account of the *Zamuzzim* (ii. 20, 21), one of the earliest races of Canaan, though mentioned nowhere else.

6. A very circumstantial account of the *Rephaim* (iii. 3, sq.), with whose concerns the author seems to have been well acquainted.

The standing-point also of the author of Deuteronomy is altogether in the Mosaic time, and had it been assumed and fictitious, there must necessarily have been moments when the spurious author would have been off his guard, and un-mindful of the part he had to play. But no discrepancies of this kind can be traced; and this is in itself an evidence of the genuineness of the book.

A great number of other passages force us likewise to the conclusion, that the whole of Deuteronomy originated in the time of Moses. Such are the passages where

1. A comparison is drawn between Canaan and Egypt (xi. 10, sq.), with the latter of which the author seems thoroughly acquainted.

2. Detailed descriptions are given of the fertility and productions of Egypt (viii. 7, sq.).

3. Regulations are given relating to the con-

quest of Canaan (xii. 1, sq.; xx. 1, sq.), which cannot be understood otherwise than by assuming that they had been framed in the Mosaic time, since they could be of no use after that period.

Besides, whole pieces and chapters in Deuteronomy, such as xxxii., xxxiii., betray in form, language, and tenor, a very early period in Hebrew literature. Nor are the laws and regulations in Deuteronomy less decisive of the authenticity of the book. We are struck with the most remarkable phenomenon, that many laws from the previous books are here partly repeated and impressed with more energy, partly modified, and partly altogether abolished, according to the contingencies of the time, or as the new aspect of circumstances among the Jews rendered such steps necessary (comp. *e. g.* Deut. xv. 17 with Exod. xxi. 7; Deut. xii. with Lev. xvii.). Such pretensions to raise, or even to oppose his own private opinions to the authority of divine law, are found in no author of the subsequent periods, since the whole of the sacred literature of the later times is, on the contrary, rather the echo than otherwise of the Pentateuch, and is altogether founded on it. Add to this the fact, that the law itself forbids most impressively to add to, or take anything from it, a prohibition which is repeated even in Deuteronomy (comp. iv. 2; xiii. 1); and it is but too evident, that, if the opinion of the critics be correct, that this book contains nothing more than a gradual development of the law—it clashes too often with its own principles, and pronounces thus its own sentence of condemnation.

The part of Deuteronomy (xxxiv.) respecting the death of Moses requires a particular explanation. That the whole of this section is to be regarded as a piece altogether apart from what precedes it, or as a supplement from another writer, has already been maintained by the older theologians (comp. *e. g.* Carpov, *Introd. in libr. V. T.* i. p. 137); and this opinion is confirmed not only by the contents of the chapter, but also by the express declaration of the book itself on that event and its relations; for chapter xxxi. contains the conclusion of the work, where Moses describes himself as the author of the previous contents, as also of the Song (ch. xxxii.), and the blessings (ch. xxxiii.) belonging to it. All that follows is, consequently, not from Moses, the work being completed and concluded with chapter xxxiii. There is another circumstance which favours this opinion, namely, the close connection that exists between the last section of Deuteronomy and the beginning of Joshua (comp. Deut. xxxiv. 9 with Josh. i. 1, where also the term יְהוָה, in the latter passage, must not be overlooked) plainly shows that ch. xxxiv. of Deuteronomy is intended to serve as a *point of transition* to the book of Joshua, and that it was written by the same author as the latter.

The correct view of this chapter, therefore, is to consider it as a *real supplement*, but by no means as an *interpolation* (such as some critics erroneously suppose to exist in the Pentateuch in general). To apply to it the term interpolation would be as wrong as to give that appellation *e. g.* to the 8th book of Cæsar's work, '*De bello Gallico*,' simply because it was equally written by an unknown author, for the very purpose of serving as a *supplement* to the previous books.

On the literature of Deuteronomy, compare the article PENTATEUCH.—H. A. C. H.

DEW. The various passages of Scripture in which dew is mentioned, as well as the statements of travellers, might, unless carefully considered, convey the impression that in Palestine the dews fall copiously at night during the height of summer, and supply in some degree the lack of rain. But we find that those who mention dews travelled in spring and autumn, while those who travelled in summer make no mention of them. In fact, scarcely any dew does fall during the summer months—from the middle of May to the middle of August; but as it continues to fall for some time after the rains of spring have ceased, and begins to fall before the rains of autumn commence, we may from this gather the sense in which the Scriptural references to dew are to be understood. Without the dews continuing to fall after the rains have ceased, and commencing before the rains return, the season of actual drought, and the parched appearance of the country, would be of much longer duration than they really are. The partial refreshment thus afforded to the ground at the end of a summer without dews or rains, is of great value in Western Asia, and would alone explain all the Oriental references to the effects of dew. This explanation is of further interest as indicating the times of the year to which the Scriptural notices of dew refer; for as it does not, in any perceptible degree, fall in summer, and as few would think of mentioning it in the season of rain, we may take all such notices to refer to the months of April, May, part of August, and September.

DEXIOLABOS (δεξιολάβος). This is the Greek word rendered 'spearmen' in the Auth. Vers. of Acts xxiii. 23. As it does not occur in the classical writers, and only this once in the Scriptures, it is uncertain what kind of soldiers is denoted by it. It strictly signifies one who covers or guards the *right side* of any one. Hence it has been conjectured that, in the above passage, it denotes officers who performed the same functions in the camp as lictors did in the city—being appointed to apprehend malefactors, and to guard criminals when led to execution, and called δεξιολάβοι, from taking the right hand of the prisoner, who was bound to the left hand of the guard. This explanation is, however, deduced entirely from the etymology of the word, and is open to the objection arising from the improbability that such a number of military lictors would be on duty with the forces of the tribune, as that 200 of them at a time could be ready to depart with one prisoner. It seems preferable, therefore, to understand the word as denoting the guard of the tribune. Nor is this contrary to the etymology, since guarding the *right side* may be taken figuratively to mean guarding the whole person. Nor is it strange that these choice troops should be employed on this duty, since the service was important and delicate. The guarding of prisoners to be tried before Cæsar was often, at Rome, committed to the prætorians. Our version 'spearmen' seems to have been derived from the Vulgate, 'lancearii.'

DIADEM. [CROWN.]

DIAL. The invention of the sun-dial belongs most probably to the Babylonians. Herodotus affirms, that the Greeks derived from them, the pole (supposed to mean the dial-plate), the γνώμων,

and the division of day into twelve parts (ii. 109). Vitruvius also ascribes the most ancient form of the dial, called hemicycle, to Berosus of the Chaldaean (ix. 9), though he probably means no more than that he introduced it into Greece. Certainly those Greeks to whom Vitruvius ascribes inventions or improvements in dialling, can all be proved to have had communication, more or less remote, with the Chaldaeans. The first mention in Scripture of the 'hour,' is made by Daniel, at Babylon (ch. iii. 6). The Greeks used the dial before the Romans; and with regard to the Egyptians, 'there are no indications in the Sculptures to prove the epoch when the dial was first known in Egypt' (Wilkinson, *Anc. Egyptians*, vol. iii. p. 342). The circumstances connected with the dial of Ahaz (2 Kings xx. 11; Isa. xxxviii. 8), which is perhaps the earliest of which we have any clear mention, entirely concur with the derivation of gnomonics from the Babylonians. Ahaz had formed an alliance with Tiglath-pileser, king of Assyria (2 Kings xvi. 7, 9); he was a man of taste, and was ready to adopt foreign improvements, as appears from his admiration of the altar at Damascus, and his introduction of a copy of it into Jerusalem (2 Kings xvi. 10). 'The princes of Babylon sent unto him to inquire of the wonder that was done in the land' (2 Chron. xxxii. 31). Hence the dial also, which was called after his name, was probably an importation from Babylon. Different conjectures have been formed respecting the construction of this instrument. The difficulty is to understand what is meant by the מַעְלוֹת אַחָז, 'the degrees or steps of Ahaz.' They may mean lines or figures on a dial-plate, or on a pavement, or the steps to the palace of Ahaz, or some steps or staircase he had erected elsewhere (vid. Carpzov, *Apparat. Historic. Crit. Lips.* 1748, p. 352, &c.). The Sept. in Isaiah reads ἀναβαθμοὺς τοῦ οἴκου τοῦ πατρὸς σου, 'the steps or stairs of the house of thy father.' Josephus also says, 'steps or degrees in his house' (*Antiq.* x. 1, 91). The Chaldee renders the passage in Kings, אֶבֶן שַׁעֲרָה, 'hour-stone,' and gives the same meaning to 'the stairs' (2 Kings ix. 13), and renders Isa. xxxviii. 8 בַּצִּוְרֵת אֶבֶן שַׁעֲרָה, by 'the shadow of the stone of hours.' Symmachus most certainly understood a sun-dial: στήψω τὴν σκιὰν τῶν γραμμῶν ἢ κατέβη ἐν ἐρολογίῳ Ἀχαζ, 'I will cause to return the shadow of the degrees which (shadow) is gone down on the dial of Ahaz;' and so Jerome renders it Horologium. On the whole, the dial of Ahaz seems to have been a distinct contrivance, rather than any part of a house. It would also seem probable, from the circumstances, that it was of such a size, and so placed, that Hezekiah, now convalescent (Isa. xxxviii. 21, 22), but not perfectly recovered, could witness the miracle from his chamber or pavilion: 'Shall הַצֵּל, *the* or *this* shadow,' &c. May it not have been situate 'in the middle court' mentioned 2 Kings xx. 4? The cut given below (No. 247) presents a dial discovered in Hindostan, near Delhi, the ancient capital of the Mogul empire, whose construction would well suit the circumstances recorded of the dial of Ahaz. It seems to have answered the double purpose of an observatory and a dial—a rectangled hexangle, whose hypo-

thense is a staircase, apparently parallel to the axis of the earth, and bisects a zone or coping of a wall, which wall connects the two terminating towers right and left. The coping itself is of a

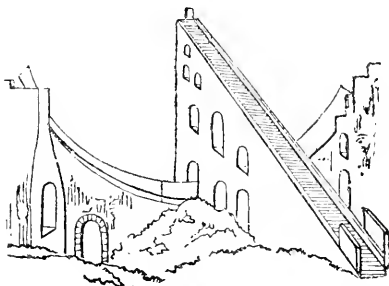

247.

circular form, and accurately graduated to mark, by the shadow of the gnomon above, the sun's progress before and after noon; for when the sun is in the zenith, he shines directly on the staircase, and the shadow falls beyond the coping. A flat surface on the top of the staircase, and a gnomon, fitted the building for the purpose of an observatory. According to the known laws of refraction, a cloud or body of air of different density from the common atmosphere, interposed between the gnomon and the coping of the dial-plate below, would, if the cloud were denser than the atmosphere, cause the shadow to recede from the perpendicular height of the staircase, and of course to re-ascend the steps on the coping, by which it had before noon gone down; and if the cloud were rarer, a contrary effect would take place. (See Bishop Stock's *Translation of Isaiah*, Bath, 1803, p. 109.) Such a building might also be called 'a house.' It agrees also with Adam Clarke's supposition, that 'the stairs' were really 'a dial,' and probably this very dial, on which, as being in the most public place, or rather on the platform on the top of which they set Jehu, while they proclaimed him king by sound of trumpet' (*Commentary* on 2 Kings ix. 13). Bishop Stock's speculation that the retrogression of the shadow might be effected by refraction, is supported by a natural phenomenon of the kind on record. On the 27th of March, 1703, P. Romauld, prior of the cloister of Metz, made the observation that, owing to such a refraction of the solar rays in the higher regions of the atmosphere, in connection with the appearance of a cloud, the shadow on his dial deviated an hour and a half (Rosenmüller). The phenomenon on the dial of Ahaz, however, was doubtless of a miraculous nature, even should such a medium of the miracle be admitted: nothing less than a divine communication could have enabled Isaiah to predict its occurrence at that time and place: besides, he gave the king his own choice whether the shadow should advance or retire ten degrees. There seems, however, to be no necessity for seeking any medium for this miracle, and certainly no necessity for supposing any actual interference with the revolution of the earth, or the position of the sun. In the more distinct and ample account of it in 2 Kings, it is simply said that the Lord, at the prayer of Isaiah, brought the shadow ten degrees backward. The words הַשֶּׁמֶשׁ תֵּשֵׁב

תעלה עשר מעלות in Isa. xxxviii. 8, 'and the sun went back ten degrees,' are wanting in three of Dr Kennicott's MSS., and originally in two of De Rossi's; and the words 'the shadow of the degrees which is gone down in the sun-dial of Ahaz' are more correctly rendered on the margin degrees 'by or with the sun,' i. e. by means of the progress of the sun. The first δ ἥλιος in this verse is omitted in MS. Pachom. of the Sept. Even if the mention of the sun be retained, as in Ecclus. xlviii. 23, it is only fair to understand the words in their popular sense, the solar rays, or such a recession of the shadow as would have been occasioned by an actual recession of the sun. Adopting the present state of the text, it is observable that what is called the sun in one part of the verse is called the shadow in the other. It is certainly as philosophical to speak of the sun returning, as it is of his setting and rising. Thus the miracle, from all the accounts of it, might consist only of the retrogression of the shadow ten degrees, by a simple act of Almighty power, without any medium, or, at most, by that of refracting those rays only which fell upon the dial. It is not said that any time was lost to the inhabitants of the world at large: it was not even observed by the astronomers of Babylon, for the deputation came to inquire concerning the wonder that was done in the *land*. It was temporary, local, and confined to the observation of Hezekiah and his court, being designed chiefly for the satisfaction of that monarch. It is remarkable that no instrument for keeping time is mentioned in the Scripture before the dial of Ahaz, B.C. 700; nor does it appear that the Jews generally, even after this period, divided their day into hours. The dial of Ahaz was probably an object only of curious recreation, or served at most to regulate the occupations of the palace.—J. F. D.

DIAMOND. [YAHALOM; SHAMIR.]

DIBON (דִּבּוֹן; Sept. Δαιβών), or DIMON (דִּמּוֹן, Isa. xv. 9), called also Dibon-Gad, from its having been rebuilt by the tribe of that name (Num. xxxii. 34), a city on the northern bank of the Arnon, at the point where the Israelites crossed that river on their journey to the Jordan, and where their first encampment was made after having passed it. In later times we find it, with other towns in this quarter, in the hands of the Moabites (Jer. xlviii. 22). The site has been recognised by Seetzen, Burckhardt, and Irby and Mangles, at a place which bears the name of Diban, in a low tract of the district called the Koura, about three miles north of the Arnon (Modjeb). The ruins are here extensive, but offer nothing of interest. There was another place called Dibon in the tribe of Judah (Neh. xi. 25), perhaps the same that is called Dimorah in Josh. xiii. 26.

DIDRACHMA (διδραχμον, a double drachma), a silver coin equal to two Attic drachmæ, and also to the Jewish half-shekel (Joseph. *Antiq.* iii. 8. 2). It was therefore equivalent to about 1s. 4d. of our money. By the law every Jew was required to pay half a shekel to the Temple (Exod. xxx. 13, sq.), and this amount is represented by the didrachma in Matt. xvii. 24, where it is used for the 'tribute-money' demanded of Christ. The Septuagint everywhere renders the 'shekel' of the Old Testament by *didrachma*, but as the Attic drachma was equal to only half a shekel, it seems

from this probable that the drachma of Alexandria was equal to two Attic drachmæ.

DIDYMUS (Δίδυμος, a twin), a surname of the Apostle Thomas, denoting that he was a twin, and if translated, he would be called 'Thomas the Twin' (John xi. 16). [THOMAS.]

DIKE (Δίκη), the heathen Goddess of Justice, described as the daughter of Zeus and Themis (Hesiod, *Op.* 266; *Theog.* 992). The punishment of murderers is particularly ascribed to her; and therefore, besides being the goddess of punishment in a general sense, she is often to be considered the same as Nemesis or Vengeance. The word occurs in Acts xxviii. 4, and is there rendered 'vengeance,' appellatively.

DIKLAH (דִּקְלָה; Sept. Δεκλά); a tribe descended from Joktan (Gen. x. 27). As the name in Aramaic and Arabic means a *palm-tree*, it has been judged necessary to seek the seat of the tribe in some territory rich in palm-trees. Bochart finds it in Southern Arabia, Michaelis in the region of the Tigris (from the analogy of the name Diglath); but where the ground of search is so uncertain, it is impossible to obtain any satisfactory result.

DINAH (דִּינָה; Sept. Δείνα), daughter of Jacob by Leah (Gen. xxx. 21), and therefore full sister of Simeon and Levi. While Jacob's camp was in the neighbourhood of Shechem, Dinah was seduced by Shechem, the son of Hamor, the Hivite chief or head-man of the town. Partly from dread of the consequences of his misconduct, and partly, it would seem, out of love for the damsel, he solicited a marriage with her, leaving the 'marriage price' (see MARRIAGE) to be fixed by her family. To this Dinah's brothers would only consent on the further condition that all the inhabitants of the place should be circumcised. Even this was yielded; and Simeon and Levi took a most barbarous advantage of the compliance by falling upon the town on the third day, when the people were disabled by the effects of the operation, and slew them all (Gen. xxxiv). For this act of truly Oriental vindictiveness no excuse can be offered, and Jacob himself repeatedly alludes to it with abhorrence and regret (Gen. xxxiv. 30; xlix. 5-7). To understand the act at all, however, it is necessary to remember, that any stain upon the honour of a sister, and especially of an only sister, is even at this day considered as an insupportable disgrace and inexpiable offence among all the nomade tribes of Western Asia. If the woman be single, her brothers more than her father, if she be married, her brothers more than her husband, are aggrieved, and are considered bound to avenge the wrong. Hence the active vengeance of Dinah's full brothers, and the comparative passiveness of her father in these transactions. Of Dinah's subsequent lot nothing is known.

DIONYSIUS THE AREOPAGITE, and PSEUDO-DIONYSIUS. The name of 'Dionysius the Areopagite' enlivens the scanty account of success which attended the visit of Paul to Athens (Acts xvii. 34). Nothing further is related of him in the New Testament; but ecclesiastical historians record some particulars concerning his career, both before and after his conversion. Suidas recounts that he was an Athenian by birth, and eminent for his literary attainments;

that he studied first at Athens and afterwards at Heliopolis in Egypt; and that, while in the latter city, he beheld that remarkable eclipse of the sun, as he terms it, which took place at the death of Christ, and exclaimed to his friend Apollonphanes, ἢ τὸ θεῖον πάσχει, ἢ τῷ πασχόντι συμπαράσχει, 'Either the Divinity suffers, or sympathises with some sufferer.' He further details, that after Dionysius returned to Athens, he was admitted into the Areopagus; and, having embraced Christianity about A.D. 50, was constituted Bishop of Athens by the Apostle Paul himself. Syncellus and Nicephorus both record the last particular. Aristides, an Athenian philosopher, asserts that he suffered martyrdom—a fact generally admitted by historians—but the precise period of his death, whether under Trajan or Adrian, or which is most likely, under Domitian, they do not determine. Whatever credit may be given to these traditions, the name of Dionysius is certainly interesting in a literary point of view, owing to an attempt made by some writer, in after times, to personate the Areopagite; and who contrived to pass his productions on the Christian world as of the apostolic age, and thereby greatly influenced the spirit both of the Eastern and Western Churches. Daillé places this Pseudo-Dionysius A.D. 420 (vid. *Dallæus de Scriptis Dionysii Areopagite*, Geneva, 1666); Pearson, in the latter times of Eusebius Cæsariensis (vid. *Vindic.* par. i. c. 10, in fine). Others have conjectured that these productions were written about A.D. 360, but not compiled till the fifth or nearly the sixth century. They consist of a book called *The Celestial Hierarchy*; another, *Of the Ecclesiastical Hierarchy*; *A Treatise on the Divine Names*; another, *Of Mystical Divinity*; and *Ten Epistles*: the first four addressed to the monk Caius, the fifth to Dositheus, the sixth to Sosipater, the seventh to Bishop Polycarp—in which the author says he observed the eclipse at Heliopolis; the eighth to the Monk Demophilus—in which the writer blames him for harshness to a priest and a layman, and relates, as if in contrast to his behaviour, that when a zealous pastor, named Carpus, grew weary in his endeavours to convert an obdurate sinner, Christ, in a vision, remonstrated with him, telling him that he was ready to die a second time for sinners; the ninth epistle is addressed to Bishop Titus, and the tenth to St. John. In the book *On the Celestial Hierarchy*, he delivers many subtleties respecting the angels. In the book on the *Ecclesiastical Hierarchy*, he explains the ceremonies of the mass, consecration of the holy chris, the ordination of a bishop, priest, and deacon, the manner of blessing a monk, and the burial of the dead. In the book *Of Mystical Divinity*, he mingles the notions of the Contemplatives with ideas and terms borrowed from the heathen philosophers. Indeed, so deeply imbued are these productions with philosophical opinions, that Suidas, who takes the author of them to be the genuine Areopagite, conjectures that the philosophers referred to had borrowed from him their notions, and vended them as their own. It is evident that had these writings been genuine, they would have been invaluable, on account of the attestations they would have afforded to the practices and customs of the Christian Church at its very commencement. Still there have been some persons who have contended that they are

the real works of the Areopagite. Among these are Claude David, a Maurist monk, in 1702; Bernard of Sept Fonds, under the name of Adrian, in 1708; and F. Honoratus, of St. Mary, a Carmelite friar, in 1720. The first uncontroverted occasion on which these supposititious writings are referred to, is in the conference between the Severians (a sect of Eutychians) and the Catholics, held in the emperor Justinian's palace, A.D. 532, in which they are quoted by the heretical party. Maximus, and other writers in the following ages, refer to them frequently. Different opinions have been held as to the real author of these productions. They were ascribed, at an early period, to Apollinaris, Bishop of Laodicea in the fourth century—an opinion to which the learned Cave inclines, though he thinks that Apollinaris, the son, may have been the author. He remarks that the peculiar acquirements and turn of mind of Apollinaris the father, as described both by Socrates and Sozomen, would have well qualified him to have written the *Areopagitica*. There have not been wanting instances in which supposititious works were fathered upon great names by disciples of the Apollinarian school (Leontius, *Lib. de Sect.* act. viii. p. 527).

The resemblance between the *Areopagitica* and the writings of Proclus and Plotinus is so obvious as to afford great probability that the Pseudo-Dionysius did not write much earlier than the fifth century (Cave's *Hist. Literar.* Coloniae, 1720, p. 142, 143; Lardner's works, vol. vii. p. 371, ed. 1788; Fabric. *Bib. Bibliog.*)—J. F. D.

DIOTREPHE (Διοτρεφής, *Jocund-nourished*), a person who seems to have been one of the false teachers condemned by St. John in his third epistle. He appears to have been a presbyter or deacon—probably the former. He refused to receive the letter sent by John, thereby declining to submit to his directions or acknowledge his authority (3 John ix).

DISCERNING OF SPIRITS. This is now usually understood to mean a high faculty, enjoyed by certain persons in the apostolic age, of diving into the heart and discerning the secret dispositions of men. It appears to have been one of the gifts peculiar to that age, and was especially necessary at a time when the standards of doctrine were not well established or generally understood, and when many deceivers were abroad (2 John ii. 7). This faculty seems to have been exercised chiefly upon those who came forward as teachers of others, and whose real designs it was important that the infant churches should know.

DISCIPLE (μαθητής), a scholar or follower of any teacher, in the general sense. It is hence applied in the gospels not only to the followers of Christ, but to those of John the Baptist (Matt. ix. 14, &c.), and of the Pharisees (Matt. xxii. 16). Although used of the followers of Christ generally, it is applied in a special manner to the twelve apostles (Matt. x. 1; xi. 1; xx. 17; Luke ix. 1). After the death of Christ the word took the wider sense of a believer, or Christian; *i. e.* a follower of Jesus Christ.

DISEASES OF THE JEWS. The most prevalent diseases of the East are cutaneous diseases, malignant fevers, dysentery, and ophthalmia. Of the first of these the most remarkable are leprosy and elephantiasis [ΛΕΠΡΟΣΥ]. To

the same class also belongs the singular disease called the mal d'Aleppo, which is confined to Aleppo, Bagdad, Aintab, and the villages on the Segour and Kowick. It consists in an eruption of one or more small red tubercles, which give no uneasiness at first, but, after a few weeks, become purulent, discharge a little moisture, and sometimes ulcerate. Its duration is from a few months to a year. It does not affect the general health at all, and is only dreaded on account of the scars it leaves. Foreigners who have visited Aleppo have sometimes been affected by it several years after their return to their own country. It is a remarkable fact that dogs and cats are likewise attacked by it (Russell's *Nat. Hist. of Aleppo*, ii. 299). The Egyptians are subject to an eruption of red spots and pimples, which cause a troublesome smarting. The eruption returns every year towards the end of June or beginning of July, and is on that account attributed to the rising of the Nile (Volney, i. 231). Malignant fevers are very frequent, and of this class is the great scourge of the East, the plague, which surpasses all others in virulence and contagiousness [PLAGUE]. The Egyptian ophthalmia is prevalent throughout Egypt and Syria, and is the cause of blindness being so frequent in those countries [BLINDNESS]. Of inflammatory diseases in general, Dr. Russell (*l. c.*) says that at Aleppo he has not found them more frequent, nor more rapid in their course, than in Great Britain. Epilepsy and diseases of the mind are commonly met with. Melancholy monomaniacs are regarded as sacred persons in Egypt, and are held in the highest veneration by all Mahometans (Prosper Alpinus, *De Med. Ægypt.* p. 58).

Diseases are not unfrequently alluded to in the Old Testament; but, as no description is given of them, except in one or two instances, it is for the most part impossible even to hazard a conjecture concerning their nature. The issue mentioned in Lev. xv. 5 cannot refer to gonorrhœa virulenta, as has been supposed by Michaelis and Hebenstreit (Winer, s. v. *Krankheiten*); for the person who exposed himself to infection in the various ways mentioned was only unclean until the evening, which is far too short a time to allow of its being ascertained whether he had escaped contagion or not. Either, then, the law of purification had no reference whatever to the contagiousness of the disease (which is hardly admissible), or the disease alluded to was really not contagious. Joram's disease is probably referable to chronic dysentery, which sometimes occasions an exudation of fibrine from the inner coats of the intestines. The fluid fibrine thus exuded coagulates into a continuous tubular membrane, of the same shape as the intestine itself, and as such is expelled. This form of the disease has been noticed by Dr. Good under the name of diarrhœa tubularis (*Study of Med.* i. 287). A precisely similar formation of false membranes, as they are termed, takes place in the windpipe in severe cases of croup.

Hezekiah suffered, according to our version, from a *boil*. The term here used, שׁוּבַן, means literally *inflammation*; but we have no means of identifying it with what we call boil. The same may be said of the plague of boils and blains [BLAINS], and of the names of diseases mentioned in the 28th chapter of Deuteronomy, such as pes-

tilence, consumption, fever, botch of Egypt, itch, scab. The case of Job, in which the term translated *boil* also occurs, demands a separate notice [JOB]. Nebuchadnezzar's disease was a species of melancholy monomania, called by authors zoantropia, or more commonly lycanthropia, because the transformation into a wolf was the most ordinary illusion. Esquirol considers it to have originated in the ancient custom of sacrificing animals. But, whatever effect this practice might have had at the time, the cases recorded are independent of any such influence; and it really does not seem necessary to trace this particular hallucination to a remote historical cause, when we remember that the imaginary transformations into inanimate objects, such as glass, butter, &c., which are of every-day occurrence, are equally irreconcilable with the natural instincts of the mind. The same author relates that a nobleman of the court of Louis XIV. was in the habit of frequently putting his head out of a window, in order to satisfy the urgent desire he had to bark. Calmet informs us that the nuns of a German convent were transformed into cats, and went mewing over the whole house at a fixed hour of the day (Esquirol, *Maladies Mentales*, i. 522). Antiochus and Herod died, like Sylla, from phthiriasis, a disease which was well known to the ancients. Plutarch, in his *Life of Sylla*, mentions several names of persons who had died from it, amongst whom are Pherecydes the philosopher, Alcman the poet, and Mutius the lawyer. M. Alibert was consulted by a celebrated French academician, who complained that his enemies even pursued him into the academy, and almost carried off his pen (*Dermatoses*, i. 585). Nothing is known respecting the immediate causes of this malady; but there is no doubt that it depends on the general state of the constitution, and must not be attributed to uncleanness. Alibert mentions the case of a person who, as soon as these animals had been destroyed, fell into a typhoid state, and shortly after died. The question of alleged demoniacal possession, so often mentioned in the New Testament, has been considered under another head [DEMONIACS], and need not be re-opened in this place.—W. A. N.

DISH. Various kinds of dishes are mentioned in Scripture; but it is impossible to form any other idea of their particular forms than may be suggested by those of ancient Egypt and of the modern East, which have much resemblance to each other. The sites of such ancient towns as were built of sun-dried bricks are usually covered with broken potsherds, some of them large enough to indicate the form of the entire vessel.

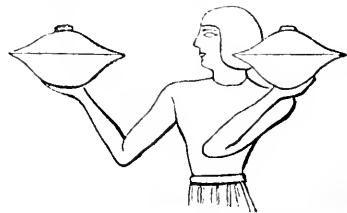

348.

These are remarkably similar to those in modern use, and are for the most part made of a rather

coarse earthenware, covered with a compact and strong glaze, with bright colours, mostly green, blue, or yellow. Dishes and other vessels of copper, coarsely but thickly tinned, are now much used in the East; but how far this may have been anciently the case we have not the means of knowing. The first cut (No. 218) represents a slave bringing dishes to table; the dishes have covers, and the manner in which they are carried on the reverted hand is the mode still



249.

used by Eastern servants. The specimens in the other cut (No. 219) are modern Oriental, and speak for themselves.

DISPERSION OF NATIONS. [NATIONS, DISPERSION OF.]

DIVINATION is a general term descriptive of the various illusory arts anciently practised for the discovery of things secret or future. The human mind has always shown a strong curiosity to ascertain the course of fortune, and the issue of present or contemplated schemes; and in those countries and ages where ignorance of physical laws has combined with superstition to debase it, it has sought to gratify this innate disposition to pry into futurity, by looking for presages in things between which and the object of its anxiety no connection existed but in the diviner's imagination. Scarcely a single department of nature but was appealed to, as furnishing, on certain conditions, good or bad omens of human destiny; and the aspect of things, which, perhaps by the most casual coincidence, marked some event or crisis in the life of one or two individuals, came to be regarded, by blind credulity, as the fixed and invariable precursor of a similar result in the affairs of mankind in general. By such childish and irrational notions was the conduct of the heathen guided in the most important, no less than in the most ordinary occurrences of life; and hence arose the profession of augurs, soothsayers, *et hoc genus omne* of impostors, who, ingrafting vulgar traditions on a small stock of natural knowledge, established their claims to the possession of an occult science, the importance and influence of which they dexterously increased by associating it with all that was pompous and imposing in the ceremonies of their religion.

This science, if that can be called science which was the product of ignorance and fraud united, was divided into various branches, each of which had its separate professors. In a general view, divination may be considered as either natural or artificial: the first being founded on the notion that the soul possesses, from its spiritual nature, some prescience of futurity, which it exemplifies particularly in dreams, and at the approach of death: the second, resting on a peculiar interpretation of the course of nature, as well as on such arbitrary observations and experiments as superstition introduced. The different systems

and methods that were anciently in vogue are almost incredible; as, for instance, Aëromancy, divining by the air; Arithmomancy, by means of numbers; Capnomancy, by the smoke of sacrifices; Chiromancy, by the lines on the palms of the hands; Hydromancy, by water; Pyromancy, by fire, &c. But without attempting an enumeration and explanation of all the arts of divination that were anciently practised, and which the reader, curious in such inquiries, will find detailed at length by Cicero (*De Divinatione*), and Cardan (*De Sapientiâ*), let us confine ourselves to the mention of those which occur in sacred history. 1. חכמים (Exod. vii. 11; Isa. xlv. 25; Jer. i. 35; Dan. ii. 12, &c.), 'wise men,' and חרטמים (derived by Parkhurst from חרט, pen, and חם, to accomplish), 'drawers of astrological figures;' both of these terms were applied generally to magicians, or men who were skilled in natural science. 2. ידעוני, 'wizzards' or wise men, and מכישפה, 'a witch,' from an Arabic verb signifying 'to reveal,' both practising divination by the same arts, *i. e.* pretending to reveal secrets, to discover things lost, find hidden treasure, and interpret dreams. 3. קוסם קוסמים *kosem kesamin*, one who foretold what was to happen by the flight of birds, or the use of lots [LOTS]. 4. מענני *meonen*, one who, though rendered by our translators 'an observer of times,' foretold political or physical changes by the motion of the clouds (from ענן, clouds), along with whom Isaiah conjoins חברי שמים, &c., who made the same predictions from eclipses, and the conjunction of the stars, (xlvii. 13). 5. מנחש, in our version, 'an enchanter,' was, coming as it does from נחש, a serpent, probably one who practised Ophiomancy, or the art of charming serpents, which was, and still is, a favourite trick of jugglery in the East. 6. חובר חבר, 'a charmer,' one who, as the original word implies, placed words and things in a certain arrangement, or muttered them, as a kind of spell. 7. שואל אוב, 'a consulter with familiar spirits,' rendered by the Septuagint *ἐγγαστριμύθος*, 'a ventriloquist,' was a wizzard who asked counsel of his familiar, and gave the responses received from him to others—the name אוב being applied in reference to the spirit or demon that animated the person, and inflated the belly, so that it protuberated like the side of a bottle. The אוב of the Hebrews was thus precisely the same as the Pytho of the Greeks, and was used not only to designate the performer, but the *πνεύμα Πύθωνος*, which possessed him (see Levit. xx. 27, ביום אוב in eis Pytho; 1 Sam. xxviii. 8, באוב per Pytho-nem; also Acts xvi. 16). 8. יורש המתים, 'a necromancer,' one who, by frequenting tombs, by inspecting corpses, or more frequently, by help of the אוב, like the witch of Endor, pretended to evoke the dead, and bring secrets from the invisible world (Gen. xli. 8; Exod. vii. 11; Lev. xix. 26; Deut. xviii. 10-12). 9. Belomancy, as it is called, a form of divination by means of arrows (Ezek. xxi. 21; see also 2 Kings xiii. 14-19), a notable example of which occurs in the history of Nebuchadnezzar, who, being undecided whether to march first against Jerusalem or Rabbah, allowed neither his policy nor resentment to decide the course of his expedition, but was determined wholly by the result of superstitious rites. The way of divining

by arrows was, having first made them bright 'in order the better to follow them with the eye,' to shoot them, and to prosecute the march according to the direction in which the greatest number of arrows fell; or, having 'mixed together' some arrows with the names of the devoted cities marked on them, to attack that first which was first drawn out; or to put in a bag three arrows, as is the practice of the Arabs (see *D'Herbelot's v. Acadab*), one of which is inscribed with the words 'Command me, Lord,' the second with 'Forbid me, Lord,' while the third is left blank; so that if the first is taken out, he was to go; if the second, he was to desist; if the third is drawn, no decision being given, the experiment is to be repeated. 10. Rhabdomanancy, or divination by rods (*Hos. iv. 12*). This has been confounded with the preceding, not only by Jerome, Grotius, and others, but even by the Septuagint, which renders the *רֹדֵי* of Ezekiel by *ῥάβδος*, 'a rod.' But the instruments of divination which Hosea alludes to are entirely different from those described by Ezekiel, *רֹדֵי*, arrows being used by the latter, whereas the former speaks of *מַקֵּל*, 'staff.' The form of divination by the staff was, after placing it upright, to let it fall, and decide by the direction in which it fell, or, according to others, by measuring the staff with the finger, saying at each span, 'I will go,' or 'I will not go,' and determining the course, according as it happened to be the one or the other at the last measurement. Both of these, as Jerome informs us, were frequently practised by the Assyrians and Babylonians. Herodotus (vi.) describes the Alani women as gathering and searching anxiously for very smooth and straight wands to be used in this superstitious manner. 11. Another way of divining was by 'images,' *תְּרַפִּים* (*Ezek. xxi. 21*), which are generally considered talismans, but which the Persian and other versions render astrological instruments or tables. 12. Another form of divination was, 'by looking into the liver' of a newly killed sacrifice, and by observing its state and colour according to certain rules, to draw a favourable or unfavourable omen. The last form which it is of consequence to notice as alluded to in Scripture was by 'the cup.' But in what manner it was practised; whether it was by observing the appearance of some magical ingredients that were infused into the vessel; or whether allusion is made to a famous cup which the immemorial tradition of the East says has been in the possession of some great personages, and represents the whole world; or, finally, whether the original word *נִוְחֵה*, 'divineth,' should be rendered by 'searching' or 'inquiring earnestly,' as many learned writers, anxious to save the character of Joseph from the imputation of sorcery (*Gen. xlv. 5*), have laboured to prove, it is absolutely impossible, and we shall not attempt, to determine.

Egypt, the cradle of arts and sciences, if she did not give it birth, seems to have encouraged the practice of divination at an early age, and whether any of its forms had become objects of popular superstition, or were resorted to for the purposes of gain in the days of Joseph, it is well known that at the time of the Hebrew Exodus there were magicians in that country whose knowledge of the arcana of nature, and whose dexterity

in the practice of their art enabled them, to a certain extent, to equal the miracles of Moses. By what extraordinary powers they achieved those feats, how they changed their rods into serpents, the river water into blood, and introduced frogs in unprecedented numbers, is an inquiry that has occasioned great perplexity to many men of learning and piety. Some have imagined that the only way of accounting for the phenomena is to ascribe them to jugglery and legerdemain; the serpents, the frogs, and the other materials requisite having been secretly provided and dexterously produced at the moment their performances were to be exhibited. But the difficulties attending this method of solution are so obvious and manifold, that every reflecting mind must allow it to be far more rational to suppose that these conjurers were aided by familiar spirits or infernal agents, with the Divine permission, in the performance of their wonderful feats. 'Earth, air, and ocean,' says a sensible writer, 'may contain many things of which our philosophy has never dreamt. If this consideration tend to humble the pride of learning, it may remind the Christian that secret things belong not to him, but to a higher power.'

It is reasonable to suppose that as Moses never had been in any other civilized country, all the allusions contained in his writings to the various forms of divination were those which were practised in Egypt; and, indeed, so strong a taste had his countrymen imbibed there for this species of superstition, that throughout the whole course of their history it seems to have infected the national character and habits. The diviners, who abounded both amongst the aborigines of Canaan and their Philistine neighbours (*Isa. ii. 6*), proved a great snare to the Israelites after their settlement in the promised land; and yet, notwithstanding the stern prohibitions of the law, no vigorous efforts were made to put an end to the crime by extirpating the practitioners of the unhallowed art, until the days of Saul, who himself, however, violated the statute on the night previous to his disastrous fall (*1 Sam. xxviii.*). But it was Chaldaea to which the distinction belongs of being the mother-country of diviners. Such a degree of power and influence had they attained in that country [*CHALDÆA*], that they formed the highest caste and enjoyed a place at court; nay, so indispensable were they in Chaldaean society that no step could be taken, not a relation could be formed, a house built, a journey undertaken, a campaign begun, until the diviners had ascertained the lucky day and promised a happy issue. A great influx of these impostors had, at various times, poured from Chaldaea and Arabia into the land of Israel to pursue their gainful occupation, more especially during the reign of the later kings (*Isa. viii. 19*), and we find Manasseh not only their liberal patron, but zealous to appear as one of their most expert accomplices (*2 Kings xxi. 6*; *2 Chron. xxxiii. 6*). The long captivities in Babylon spread more widely than ever among the Jews a devoted attachment to this superstition; for after their return to their own country, having entirely renounced idolatry, and, at the same time, no longer enjoying the gift of prophecy or access to the sacred oracles, they gradually abandoned themselves, as Lightfoot has satisfactorily shown, before the advent of Christ, to all the

prevailing forms of divination (*Comment. on Matt.*).

Against every species and degree of this superstition the sternest denunciations of the Mosaic law were directed (Exod. xxii. 18; Lev. xix. 26, 31; xx. 27; Deut. xviii. 10, 11), as fostering a love for unlawful knowledge and withdrawing the mind from God only wise; while, at the same time, repeated and distinct promises were given that in place of diviners and all who used enchantments God would send them prophets, messengers of truth, who would declare the divine will, reveal futurity, and afford them all the useful knowledge which was vainly sought for from those pretended oracles of wisdom. Much discussion, however, has been carried on by learned men to determine the question whether the ancient tribe of diviners merely pretended to the powers they exercised, or were actually assisted by demoniacal agency. The latter opinion is embraced by almost all the fathers of the primitive church, who appeal, in support of their views, to the plain language of Scripture; to the achievements of Jannes and Jambres in the days of Moses; to the divine law, which cannot be chargeable with the folly of prohibiting crimes which never existed; and to the strong presumption that pretensions to interpret dreams, to evoke the dead, &c., would never have met with credit during so many ages had there not been some known and authenticated instances of success. On the other hand, it has been, with great ability and erudition, maintained that the whole arts of divination were a system of imposture, and that Scripture itself frequently ridicules those who practised them as utterly helpless and incapable of accomplishing anything beyond the ordinary powers of nature (Isa. xlvii. 11-13; xlv. 25; Jer. xiv. 14; Jonah ii. 8; see Faber's *Origin of Pagan Idolatry*; Farmer's *Dissert. on Miracles*; Lightfoot's *Works*; Potter's *Antiq.* i. 354; Stolberg's *Hist. of Relig.* iii.; Selden, *De diis Syris*; Godwin's *Moses and Aaron*, p. 216; Rosenmüller's *Geog.* vii. 101, 102; Gesenius's *Comment. on Isaiah*, app. xi.; Glanville's *Sadducismus Triumphatus*; Richardson's *Dissertation on the Manners of Eastern Nations*).—R. J.

DIVORCE. [MARRIAGE.]

DODANIM (דודנים; Sept. *Ῥόδοι*), the descendants of the fourth son of Javan (Gen. x. 4). Bochart and other commentators on the ethnographical sketch in Gen. x. suppose that the first settlements of the Dodanim were in the south-west part of Asia Minor; where the country called by the Greeks Doris, with the neighbouring isle of Rhodes, are conceived to exhibit traces of this origin, the Hebrew letters ד (d) and נ (n) being, from their similarity, often transposed. In fact, some copies have the ד, and read Rodanim (as in the margin of the Auth. Vers.), and the Septuagint gives the same reading both in Gen. x. 4, and 1 Chron. i. 7, where it has *Ῥόδοι*. It is further supposed that settlers of this family may be traced in Thessaly and Epirus, where the name is traced in the city of Dodona and in the country of Doris. But there seems much of uncertainty in all these ingenious speculations.

DOEG (דוג; Sept. *Δωγέ*), an Edomite, and chief overseer of King Saul's flocks, which is an important trust in Oriental courts. At Nob

he was witness of the assistance which the high-priest Ahimelech seemed to afford to the fugitive David, by furnishing him with the sword of Goliath, and by supplying him with bread even from the sacred table (1 Sam. xxi. 7). Of this he failed not to inform the king, who, regardless of the explanation offered by Ahimelech, and finding that the chiefs censured him, and hesitated to lay their hands upon a person so sacred, commanded Doeg to slay him and his priests—a task which was executed with equal readiness and cruelty by the Edomite (1 Sam. xxii. 18, sqq.).

DOG (כלב *keleb*; Arabic, *kelb*) occurs in many places of Scripture (Exod. xxii. 31; 1 Sam. xvii. 43; xxiv. 14; 2 Sam. ix. 8; 2 Kings viii. 13; Ps. lix. 6, 14, 15; Prov. xxvi. 11, 17, &c.). An animal so well known, whose numerous varieties come under daily observation, requires no detailed description. There is, however, in Asia still extant one, perhaps more than one, species, that never have been the companions of man, and there are races of uncertain origin, that may have been formerly domesticated, but which are now feral, and as fierce as wolves; while, from the particular opinions of Oriental nations, there are others, exceedingly numerous, neither wild nor domesticated, but existing in all the cities and towns of the Levant, without owners; feeding on carrion and offals, and still having the true instinct of protecting property, guarding the inhabitants of the district or quarter where they are tolerated; and so far cherished, that water and some food are not unusually placed within their reach.

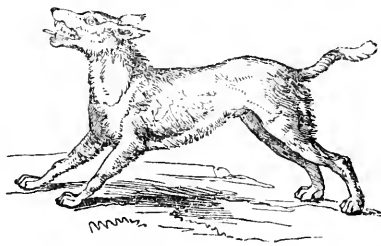

250.

The true wild species of Upper and Eastern Asia is a low, sharp-nosed, reddish-cur-dog, not unlike a fox, but with less tail. In Persia and Turkey there exists a larger dog resembling a wolf, exceedingly savage. Both are gregarious, hunt in packs, but are occasionally seen alone. They are readily distinguished from a wolf by their shorter unfurnished tails. In the time of the sojourning of Israel in Egypt, there were already in existence domestic dogs of the principal races now extant—the cur-dog or fox-dog, the hound, the greyhound, and even a kind of low-legged turnspit. All the above, both wild and reclaimed, there is every reason to believe, were known to the Hebrews, and, notwithstanding the presumed Mosaic prohibition, anterior habits, and, in some measure, the necessity of their condition, must have caused cattle-dogs to be retained as property (Deut. xxiii. 18); for we find one of that race, or a house-dog, actually attending on travellers (Tobit v. 16; xi. 4). It is to be presumed that practically the street-dogs alone were considered as absolutely unclean; though all, as

is the case among Mohammedans, were excluded from familiarity.

Beside the cattle-dog, the Egyptian hound, and one or two varieties of greyhound were most likely used for hunting—a pastime, however, which the Hebrews mostly pursued on foot.

The street-dog, without master, apparently derived from the rufous-cur, and in Egypt partaking of the mongrel greyhound, often more or less bare, with a mangy unctuous skin, frequently with several teeth wanting, was, as it now is, considered a defiling animal. It is to animals of this class, which no doubt followed the camp of Israel, and hung on its skirts, that allusion is more particularly made in Exod. xxii. 31; for the same custom exists at this day, and the race of street-dogs still retains their ancient habits. A portion of the Cairo packs annually become *hadgis*, and go and return with the caravan to Mecca, while others come from Damascus, acting in the same manner; and it is known that the pilgrims from the banks of the Indus are similarly attended to Kerbela: indeed, every caravan is so, more or less, by these poor animals. But with regard to the dogs that devoured Jezebel, and licked up Ahab's blood (1 Kings xxi. 23), they may have been of the wild races, a species of which is reported to have particularly infested the banks of the Kishon and the district of Jezreel.

The cities of the East are still greatly disturbed in the night by the howlings of street-dogs, who, it seems, were similarly noisy in ancient times, the fact being noticed in Ps. lix. 6, 14; and dumb or silent dogs are not unfrequently seen, such as Isaiah alludes to (lvi. 10).

In Egypt, anterior to the Christian era, domestic dogs were venerated; they continued to be cherished till the Arabian conquest, when they, like the unowned street-dogs, fell under the imprecation of Mohammed, who with reluctance, though with good policy, modified his denunciations and sentence of destruction in favour of hunting-dogs, and even permitted game killed by them to be eaten under certain conditions. For interesting details on the dogs of the East and their congeners, the wolf, Lyciscus, Thoa, and Jackal, reference may be made to Sir William Jardine's *Naturalist's Library*, vols. ix. and x., which contain the Canidæ. We figure a specimen of Feral, or wild dog, copied from a large Persian picture in the library of the Hon. East India Company. In this picture the Shah and his sons are seen killing game, and among the rest the dogs in question.—C. H. S.

DOKHAN, or **DOCHAN** (דוכן), occurs in Ezek. iv. 9, where the Prophet is directed to take unto him wheat, and barley, and beans, and lentiles, and millet (*dokhan*) and fitches, and to put them into one vessel, and to make bread thereof for himself. All the grains enumerated in this verse continue to form the chief articles of diet in the East in the present day, as they appear to have done in ancient times. Wheat, barley, and beans are well known in Europe. Lentiles are less so, except in the south, and fitches will be noticed under the head of **KUSMETH**. The Hebrew word *dokhan* is identical with the Arabic **دخن dukhan**, which is applied in the present day by

the Arabs to a small grain cultivated from the middle of Europe to the most southern part of India. This is the common millet, *Panicum miliaceum* of botanists, which is sometimes cultivated in England on account of the seeds being used for feeding birds and poultry. But the



251. [Millet—*Panicum miliaceum*.]

grain is usually imported into this country from the Mediterranean. In India it is cultivated in the cold weather, that is, in the same season with wheat and barley, and is an article of diet with the inhabitants. The culms are erect, from two to four feet high, the whole plant being very hairy; leaves large, with long sheaths, which involve most part of the culm; panicle, oblong, much branched, bending down with the weight of the grain; glumes cuspidate; corol, three-valved, adventitious valve emarginate; seed, oval and smooth, coloured longitudinally with five streaks. The name, *miliaceum*, is said to have been applied to this plant from its producing such a quantity of grain, as if one stalk bore a thousand seeds. Having mentioned the extreme points where this grain is cultivated, it is hardly necessary to state that it is produced in the intermediate countries. Tournefort says that in the Isle of Samos the inhabitants, in preparing their bread, knead together one half wheat and the other half barley and millet mixed together. It is also an article of diet both in Persia and India.

Forskål applies the name **دخن dukhan** to another corn-grass, which he first found in a garden at Rosetta, cultivated on account of its seed being given as food to birds. Afterwards he found it commonly cultivated in Arabia. It grows to a great size, being about five cubits in height, with seeds of the size of rice. To it he has given the name of *Holcus dochna*, but the plant is as yet unknown to botanists. There is, however, no doubt that the true *dukhan* of Arab

authors is the above described *panicum miliaceum*. This is so universally cultivated in the East as one of their smaller corn-grasses, that it is most likely to be the kind alluded to in the passage of Ezekiel.—J. F. R.

DOORS. [GATES.]

DOPHKAH, an encampment of the Israelites in the Wilderness [WANDERING, THE].

DOR (דֹר or דֹרָה; Sept. Δῶρα. Δῶρ), a town on the border of the Mediterranean, which Jerome places nine Roman miles north of Cæsarea. It was one of the royal towns of the Canaanites (Josh. xi. 2; xii. 23), and was included in the heritage of Manasseh (Josh. xvii. 11). The place, or rather the region to which it gave name, occurs again in 1 Kings iv. 11; and in the Maccabees (1 Macc. xv. 11) and Josephus (*Antiq.* xvi. 4, 4) appears under the name of Dora. A place still exists, at the distance indicated by Jerome, under the name of Tortura, which Buckingham describes as a small village with about forty or fifty houses and five hundred inhabitants. It has a small port, formed by a narrow range of rocky islets, at a short distance from the sandy beach.

DOTHAN (דוֹתָן and דוֹתָן; Sept. Δωθαίμη and Δωθαίμη) or **DOTHAIM**, the place where Joseph found his brethren, who had wandered thither with their flocks from Shechem, and where he was treacherously sold by them to the Ishmaelites (Gen. xxxvii. 17). It was here also that the Syrians were smitten with blindness at the word of Elisha (2 Kings vi. 13). Dothan is placed by Eusebius and Jerome twelve Roman miles north of Sebaste or Samaria, and it was obviously on the caravan track from Syria to Egypt. The well into which Joseph was cast by his brothers, and consequently the site of Dothan, has, however, been placed by tradition in a very distant quarter, namely, about three miles south-east from Safed, where there is a khan called Khan Jubh Yusuf, the Kian of Jacob's Pit, because the well connected with it has long passed among Christians and Moslems for the well in question. The Bethulia of Judith has long been identified with Safed, and as Dothan (Dothaim) is mentioned as being in the neighbourhood, it became necessary that Dothan should be found in this quarter. But it is clear, from the notices in Judith (iv. 5; vii. 1, 2), that Bethulia was south, and not north, of the plain of Esdraelion; and consequently we are at liberty to seek the site of Dothan also at some point more conformable to the intimation of Eusebius and to the probabilities of the story than that of the alleged Joseph's well.

DOVE (דוֹבָה *yoneh*; οἰνάς and περιστέρα in Greek). There are probably several species of doves or pigeons included in the Hebrew name *yoneh*. It may contain all those that inhabit Palestine, exclusive of the turtle-doves properly so called. Thus generalized, the dove is, figuratively, next to man, the most exalted of animals, symbolizing the Holy Spirit, the meekness, purity, and splendour of righteousness. Next, it is by some considered (though in an obscure passage) as an early national standard (Psa. lxxviii. 13), being likewise held in pagan Syria and Phœnicia to be an ensign and a divinity, resplendent with silver and gold; and so venerated as to be regarded as **holy**, and forbidden as an article of food. By the

Hebrew law, however, doves and turtle-doves were the only birds that could be offered in sacrifice, and they were usually selected for that purpose by the less wealthy (Gen. xv. 9; Lev. v. 7; xii. 6; Luke ii. 24); and to supply the demand for them, dealers in these birds sat about the precincts of the Temple (Matt. xxi. 12, &c.). The dove is the harbinger of reconciliation with God (Gen. viii. 8, 10, &c.), and, though somewhat questionable, the **חֲרִיבִיִּים** *chirivim*, 'dung of doves' (2 Kings vi. 25), seems to be indicated as food in the last degree of human suffering by famine. That this interpretation is not forced, appears from similar passages in Josephus (*De Bell. Jud.* v. 13, 7). See Winer, *Realwörterbuch*, s. v. *Taube*, where other instances are adduced, and among them the famine in England, during the reign of King Edward II. A.D. 1316, when 'pigeons' dung' is mentioned as being eaten by the poor. But we take this to be a mere figure of speech copied from Josephus [DOVES' DUNG].

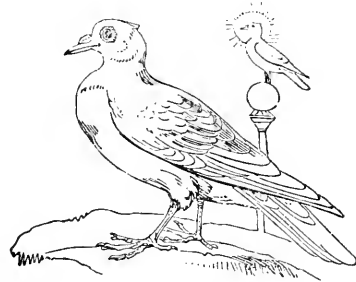

252.

With regard to the dove as a national ensign, it may be remarked that we have two figures where the symbol occurs: one from a Phœnician coin, where the dove stands on a globe instead of the usual pedestal of ancient signs, with wings closed, and a glory of sunbeams round the head; the other, from a defaced bas-relief observed in the Hauran, where the bird, with wings displayed, is seated also on a globe, and the sunbeams, spreading behind the whole, terminate in a circle of stars; probably representing Assyria, Syria, or perhaps Semiramis (compare several passages in Jeremiah). The brown wood-dove is said to be intended by the Hebrew name; but all the sacred birds, unless expressly mentioned, were pure white, or with some roseate feathers about the wing coverts, such as are still frequently bred from the carrier-pigeon of Scanderoon. It is this kind which Tibullus notices.

'Alba Palastino sancta Columba Syro.'

The carrier-birds are represented in Egyptian bas-reliefs, where priests are shown letting them fly on a message; and to them also may be referred the black-doves, which typified or gave their name to an order of Gentle priests, both in Egypt and, it would seem, in early Greece, who, under this character, were, in the mysteries, restorers of light. This may have had reference to the return of the dove which caused Noah to uncover the ark. All pigeons in their true wild plumage have iridescent colours about the neck, and often reflected flashes of the same colours on the shoulders, which are the source of the silver and gold feathers ascribed to them in poetical diction; and thence the epithet of purple bestowed upon them all, though

most applicable to the vinous and slaty-coloured species. The coasts and territory of Syria are noted for the great number of doves frequenting them, though they are not so abundant there as in the Coh-i-Suleiman chain near the Indus, which in Sanscrit is named *Arga varta*, or, as it is interpreted, the 'dove.' Syria possesses several species of pigeon: the *Columba Enas*, or stock-dove, *C. Palumbus*, or ring-dove, *C. Domestica*, *Livia*, the common pigeon in several varieties, such as the Barbary, Turkish or Persian carrier, crisp, and shaker. These are still watched in their flight in the same manner as anciently their number, gyrations, and other manœuvres were observed by soothsayers. The wild species, as well as the turtle-doves, migrate from Palestine to the south; but stock and ring-doves are not long absent.

We figure above (No. 252) the more rare species of white and pink carrier, and the Phœnician sacred ensign of the dove.—C. H. S.

DOVES' DUNG. This expression occurs in 2 Kings vi. 25, as a literal translation of *חריונים* *chirionim* or *charei-yonim*, which in the margin is written *דביונים* *dib-yonim*, both meaning the same thing; and it is curious that in the Arabic there are two words very similar to these, *خرة*

khureh, and *ذبييل*; *zabil*, which also signify the same thing, that is, the dung of animals. In the above compounds, *khir* and *dib* being prefixed to *yonim*, the plural form for *doves*, the literal meaning is as above translated. By many the expression is considered to signify literally the dung of pigeons, as in the passage of 2 Kings vi. 25: 'And there was a great famine in Samaria, and behold they besieged it, until an ass's head was sold for threescore pieces of silver, and the fourth part of a cab of *doves' dung* for four pieces of silver.' Different opinions, however, have been entertained respecting the meaning of the words which are the subject of this article, namely, whether they should be taken literally, or as a figurative name of some vegetable substance. The strongest point in favour of the former view is that all ancient Jewish writers have understood the term literally. Taking it, however, in this sense, various explanations have been given of the use to which the doves' dung was applied. Some of the rabbins were of opinion, that the doves' dung was used for fuel, and Josephus, that it was purchased for its salt. Mr. Harmer has suggested that it might have been a valuable article, as being of great use for quickening the growth of esculent plants, particularly melons; and he shows, what is well known, that the Persians live much on melons in the summer months, and use pigeons' dung in raising them. All travellers describe the number of pigeon-houses in Persia. Mr. Edwards, as cited by Dr. Harris, remarks that it is not likely they had much ground to cultivate in so populous a city for gardens; and is disposed therefore to understand it as meaning the offals or refuse of all sorts of grain, which was wont to be given to pigeons, &c. Dr. Harris, however, observes that the stress of the famine might have been so great as to have compelled the poor among the besieged in Samaria to devour either the intestines of the doves, after the more wealthy had eaten the bodies, or, as it might perhaps be rendered, the *crops*; and reference has

been made in the *Edinb. Christian Instructor* No. 122, to an abridged Chronicle of the History of England, in which it is said that in the famine which laid England waste in 1316 the poor ate *pigeons' dung*. But these explanations are not more satisfactory than the older ones.



253. [*Ornithogalum umbellatum*.]

Bochart, however, has shown (*Hierozoicon*, ii. 37) that the term 'pigeons' dung' was applied by the Arabs to different vegetable substances. He quotes Avicenna as applying the term *stercus columbarum* to two different plants or substances. One of these is described by Avicenna and other Arab authors, under the names *kuz-kundem* and *joug-kundem*, as a light substance like moss. Secondly, this name was given to the *ashnan* or *usnan*, which appears to be a fleshy-leaved plant, that, like the *salsolas*, *salicornias*, or *mesembryanthemums*, when burnt, yields alkali in its ashes. From this Bochart has been led to consider it as identical with another plant, which occurs under the name of *kali* both in the Hebrew and Arabic languages, and which was one of the pulses used in ancient times, as at the present day, as an article of diet [*KALI*]. With reference to this grain it has been observed that 'large quantities of it are parched and dried, and stored in magazines at Cairo and Damascus. It is much used during journeys, and particularly by the great pilgrim-caravan to Mecca; and if this conjecture be correct it may be supposed to have been among the provisions stored up in the besieged city, and sold at the extravagant price mentioned in the text' (*Pict. Bible*). The late Lady Callcott, in her *Scripture Herbal*, 1842, alludes the *ornithogalum umbellatum*, or common Star of Bethlehem, as the 'doves' dung' of Scripture, and assigns this, as well as 'birds' milk,' as two of its vernacular names, and infers that the *pigeons' dung* which has been mentioned above as being eaten in England in the famine of 1316 was the roots of this plant. It is a native of this country, and also of Taurus, Caucasus, and Northern Africa. Dioscorides states that its bulbs were sometimes cooked with bread, in the same way as the *melanthium*, and also that it was eaten both raw and roasted. The roots were also commonly eaten in Italy and other southern countries at an early period. Spængel (*in Dioscor.* ii. 471),

with reference to the above passage of Dioscorides on *ὄρνιθόγαλον*, says, 'Ebraice dicta fuit planta *דִּינִי יָדִי*, *stercus columbinum* (2 Reg. vi. 25), ob floris albidum cum herbaceo mixtum colorem, sicut in stercore plerarumque avium herbivorarum ea mixto observatur. Est enim *ornithogalum umbellatum*, quod per omnem orientem proveniens, bulbos habet edules, licet a pauperibus duntaxat petantur. Hæc Linnaei expositio biblici loci multi plus valet, quam septem et quod excedit *ἐξηγήσεις*, quas Bochartus enumerat.'

Having seen that the name of pigeons' dung has been, and probably still is, applied by the Arabs to different vegetable substances, we are not disposed to adopt the literal meaning of the term, as doves' dung, being devoid of nutriment, was not likely to have served as food, even during the famine, especially as we find that an ass's head was sold for sixty pieces of silver. Now if any asses remained for sale, or ass-loads of corn, as the expression has been interpreted, there is no reason for supposing, that other substances may not have remained stored up in secret for those who had money to buy. But it is not easy to say what vegetable substance, serving as an article of diet, is alluded to by the name of 'doves' dung.' If the besieged had communication with the exterior, or even if any of their body could have dug in the neighbourhood of the walls, for the kind of 'earth-nut' offered by the bulbs of the *ornithogalum*, or Star of Bethelam, which is said to be abundant in the neighbourhood of Samaria, there does not appear any good reason why it should not be the substance alluded to. But it does not appear so likely to have been stored up; and we have been unable to discover any reference in the Arab authors to such a plant, under the name of *stercus columbarum*. Pulse was as likely to have been stored up in ancient times as at the present day; and it may, therefore, as shown by Bochart, have been one of the substances to which the name was applied by the Arabs, and have been known to the Hebrews also by a similar name [KALI].—J. F. R.

DRACHMA (*δραχμή*), a coin of silver, the most common among the Greeks, and which after the Exile became also current among the Jews (2 Macc. iv. 19; x. 20; xii. 43; Luke xv. 8, 9). The earlier Attic drachmæ were of the average weight of 66·5 grains, and in a comparison with the shilling would be equal to 9½*d.* But the specimens of later times are of the average weight of only 61 grains, and some of less. In this state the drachma was counted equal to the denarius, which was at first worth 8½*d.*, and afterwards only 7½*d.* The value of the drachma of the New Testament may therefore have been about 8*d.* The woman's 'ten pieces of silver' (*drachmæ*) in Luke xv. 8, would hence be equal to 6*s.* 8*d.* of our money—that is, in nominal value, for the real value of money was far greater in the time of Christ than at present. That the drachma of Alexandria was equal to two of Greece is inferred from the fact that the Septuagint makes the Jewish shekel equivalent to two drachmæ [*ΔΙΔΡΑΧΜΑ*]; and in fact an Alexandrian drachma weighing 126 grains has been found.

DRAGON, in our version, is used for the Hebrew *תָּנִין* *than*, *תַּנִּינִי* *thanin*, and *תַּנִּינִים* *thanin*. It occurs principally in the plural form

(Job xxx. 29; Ps. xlv. 19, 20; Isa. xiii. 22; xxxiv. 13; xxxv. 7; Jer. ix. 11; xiv. 6; xlix. 33; and Micah i. 8). These texts, in general, present pictures of ruined cities and of desolation in the wilderness. Where *Thanin* are associated with birds of the desert, they clearly indicate serpents of various species, both small and large, as already noticed in the article ADDER. In Jer. xiv. 6, where wild asses snuffing up the wind are compared to dragons, the image will appear in its full strength, if we understand by dragons, great boas and python-serpents, such as are figured in the Præstine mosaics. They were common in ancient times, and are still far from rare in the tropics of both continents. Several of the species grow to an enormous size, and, during their periods of activity, are in the habit of raising a considerable portion of their length into a vertical position, like pillars, 10 or 12 feet high, in order to survey the vicinity above the surrounding bushes, while with open jaws they drink in a quantity of the current air. The same character exists in smaller serpents; but it is not obvious, unless when, threatening to strike, they stand on end nearly three-fourths of their length. Most, if not all, of these species are mute, or can utter only a hissing sound; and although the *mali-pambn*, the great rock-snake of Southern Asia, is said to wail in the night, we have never witnessed such a phenomenon, nor heard it asserted, that any other boa, python, or erpeton had a real voice; but they hiss, and, like crocodiles, may utter sounds somewhat akin to howling.

It is from these giant serpents which, at a remote period, were evidently still more colossal than that which is recorded to have opposed a Roman army, or the skeleton of another above 100 feet in length, found more recently in India, that those vague but universally-spread notions must have arisen in the earliest antiquity, and been perpetuated to our own time, which typified the deluge and all great destructive agents under the form of a dragon or monster serpent. We find them embodied by the ancients in the form of dragon temples (*Dracoutia*), consisting of huge stones set upright in rows, such as that of Colchis, no doubt, was. Such temples existed in Asia Minor, Epirus, Northern Africa, Gaul, and Britain, that at Abury, in Wiltshire, being several miles in length; and where their design can be traced out sufficiently in existing remains, the serpentine figure is ever observed to glide through or sustain a diagram of similar materials—a circumstance which appears best explained by considering them more or less astronomical, but fundamentally reposing upon traditions concerning the Ark, the preserver of animal life, in the act of struggling with the overwhelming element. These structures are ever connected with water, coming, as it were, out of the sea, or at least intersecting a stream or rivulet; thus retaining both the diluvian record and the truth of nature; for all boas and pythons enter the water at certain seasons, pass through rivers as if they were unconscious of the change of medium, swim with great velocity, or sojourn beneath the surface, some for a time, others habitually. Perhaps in conjunction with the existence of real colossal sea-serpents, but not wholly so, nations remote from the ocean, in common with

the rest, have in their cosmogonies their religious dogmas, their legends and records, both males volent and beneficial, giant-serpents—the Indian nations, their *kapila*, *cuvera*, *ananta*, *naga*, *sessa naga*; and the more western nations their *paystha*, *sozne*, *kater*, *vidhanger*, and finally, the great dragon, sometimes denoting the guide-preserver of the ark, the monster guardian of riches, the *via lactea* among the stars, or abstract powers in Eastern demonology; at other times similar types, but in the West more generally connected with the image of the deluge, and figured by the ancient Heli-Arkite temples of the Celtæ already noticed. But the serpent type is constantly mixed up with another of the lizard form; and as, in every quarter of the globe, the dragon of the deluge assailing the ark is transferred to the skies, and a celestial dragon, in Asia, generally denominated Satan שָׂטָן, is believed to attack the moon, the crescent ship, during an eclipse. Wings have been added to the monster of the skies. Comets have been called dragon-stars, and the assumed figure of one has been made a chief ensign of all the equestrian nations of Eastern and Northern Asia. Westward the dragon was the *azdehac* of Persia, a Roman ensign during the empire, and one common to all the Celtic and Gothic nations. So late as the 11th century, Harold, the last Anglo-Saxon king, perished at Hastings fighting between his two dragon standard-bearers; while our Norman sovereigns had a pennon with the dragon painted thereon, in all the great wars, in the crusades, and even down to Henry VIII. In Christian church ceremonies the dragon image, the *Σαυριον*, was carried about, and fire was sometimes placed in its mouth. It is necessary to bear in mind the general tenour of these remarks, when allusion is made in this sacred volume to the *Thanim*, and in the Revelations especially, where the dragon is mentioned; for they tend to explain in what manner the existing nations of Western Asia might have viewed the types in question at the beginning of the Christian era.

Reverting from these symbols to the physically existing species whence they may have been drawn, it seems that when mentioned in connection with rivers, לֵוִיָּתָן, *leviathan*, generally applies to the crocodile; when in connection with land, and particularly the desert, it appears to designate a *waran*, a species of monitor, probably the *waranel-hard* of the Arabs, monitor-arenarius, growing to near six feet in length; or another species of a green shining colour, not as yet completely described, but acquiring the length of 9 feet, while *thanim* is certainly used for serpents mostly of the larger kind. In the apocryphal history of Bel and the Dragon, where the last-mentioned was a living animal, by some taken for a crocodile, we think it more likely to have been a great snake, such as is still fed and venerated in Cutch, because these reptiles are safely handled when not excited; food may even be thrust into their throats, and the worship of them is not yet extinct in the eastern provinces of Persia. But all these animals are oviparous or ovoviviparous: when, therefore, the same term is used for those that draw the breast and suckle their young, which implies a species of mammalia, they can indicate only cetaceans, unless it were proved that seals

had at any time frequented the seas of Palestine or of Arabia. We refer this question to the articles *LEVATHAN* and *WHALE*.—C. H. S.

DREAMS. Of all the subjects upon which the mind of man has speculated, there is perhaps none which has more perplexed than that of dreaming.

Whatever may be the difficulties attending the subject, still we know that it has formed a channel through which Jehovah was pleased in former times to reveal His character and dispensations to His people.

In regard to the immediate cause of dreaming the opinions of the ancients were very various, and some of them striking; but they do not claim notice in the present work. We cannot, however, omit the opinion of Aristotle, who thought that every object of sense produces upon the human soul a certain impression, which remains for some time after the object that made it is removed; and which, being afterwards recognised by the perceptive faculty in sleep, gives rise to the varied images which present themselves.

Amongst English writers on this subject, none have written with more acuteness in support of his theory than Baxter. He supposes that our dreams are prompted by *separate spirits*—an opinion generally entertained by the heathen, and which opinion has given rise, in all ages and in all countries, to much superstition and imposture (Baxter's *Essay on the Phenomenon of Dreaming*, vol. ii. 3d edit. 1745).

Professor Dugald Stewart, in endeavouring to reduce the phenomenon of dreaming to *some established principles*, remarks, that in sleep those operations of the mind are suspended which depend on our *volition*. He then says that, if the suspension of our voluntary operations in sleep be admitted as a fact, there are only two suppositions which can be advanced concerning its cause;—the one is, that the power of volition is suspended; the other, that the will loses its influence over those faculties of the mind and those members of the body which, during our waking hours, are subjected to its authority. Now it may be shown that the former is not consistent with fact, whence the latter follows as a necessary consequence. Hence it is inferred that all our mental operations which are independent of our *will* may continue during sleep; and that the phenomenon of dreaming may, perhaps, be produced by these, diversified in their apparent effects in consequence of the suspension of our voluntary powers. Two obvious consequences follow:—1st. That when we are asleep the succession of our thoughts, in so far as it depends on the association, may be carried on by the operation of the same unknown causes by which it is produced while we are awake; and, 2nd. That the order of our thoughts in these two states of our minds must be very different, inasmuch as in the one it depends solely on the laws of association, and in the other, on these laws combined with our own voluntary exertions.

If, then, the succession of our thoughts during sleep is regulated by the same general laws of association to which it is subjected while we are awake, and if the circumstances which discriminate dreaming from our waking thoughts are such as must necessarily arise from the suspension of the *will*, this may account for the inaccu-

rate estimate we form of *time* when dreaming; the rapidity of thought is such that in the twinkling of an eye a crowd of ideas may pass before us, to which it would take a long discourse to give utterance; and transactions may be conceived which it would require *days* to realise. But in sleep the conceptions of the mind are mistaken for realities, and therefore our estimate of time will be found not according to our experience of the rapidity of thought, but according to our experience of the time requisite for realising what we conceive (Stewart's *Elements of the Philosophy of the Human Mind*, pp. 328-348).

There seems a strong analogy between dreaming and insanity. Dr. Abercrombie defines the difference between the two states to be, that in the latter the erroneous impression, being permanent, affects the conduct; whereas, in dreaming, no influence on the conduct is produced, because the vision is dissipated on awaking.

We believe that dreams are ordinarily the re-embodiment of thoughts which have before, in some shape or other, occupied our minds. They are broken fragments of our former conceptions revived, and heterogeneously brought together. If they break off from their connecting chain, and become loosely associated, they exhibit oftentimes absurd combinations, but the *elements still subsist*. If, for instance, any irritation, such as pain, fever, &c., should excite the *perceptive* organs while the reflective ones are under the influence of sleep, we have a consciousness of objects, colours, or sounds being presented to us, just as if the former organs were actually stimulated by having such impressions communicated to them by the external senses; whilst, in consequence of the repose of the reflecting power, we are unable to rectify the illusion, and conceive that the scenes passing before us, or the sounds that we hear, have a real existence. This want of mutual co-operation between the different faculties of the mind may account for the *disjointed* character of dreams. This position might be fully substantiated by an appeal to the evidence of fact. Dr. Beattie speaks of a man who could be made to dream anything by whispering in his ear. Dr. Gregory relates of himself that, having once had occasion to apply a bottle of hot water to his own feet when he retired to bed, he dreamed that he was ascending the side of Mount *Ætna*, and that he found the heat of the ground almost insufferable. Persons who have had a blister applied to their head have been known to dream of being scalped by a party of North American Indians. Sleeping in a smoky room, we may dream of a house or a city being in flames. The smell of a flower applied to the nostrils may call forth the idea of walking in a garden; and the sound of a flute may excite in us the most pleasurable associations.

Here, then, we discover one great source of that class of dreams of which Solomon speaks in *Eccles. v. 7*.

The only one of our mental powers which is not suspended while dreaming is fancy, or imagination. We often find *memory* and *judgment* alternately suspended and exercised. Sometimes we fancy ourselves contemporaneous with persons who have lived ages before: here memory is at work, but judgment is set aside. We dream of carrying on a very connected discourse with a

deceased friend, and are not conscious that he is no more: here judgment is awake, but memory suspended. These *irregularities*, or want of mutual co-operation in the different faculties of the mind may form, for aught we know, the plan by which God gives health and vigour to the whole soul.

How God revealed himself by dreams, and raised up persons to interpret them, the Scriptures abundantly testify. Under the three successive dispensations we find this channel of communication with man adopted. It was doubtless in this way that God appeared to the father of the faithful, ordering him to forsake country, kindred, and his father's house, and to go into the land that he would show him. To this divine command Abraham paid a ready obedience. It was by a similar prompt obedience to the admonition conveyed to him in a dream that Abimelech (*Gen. xx. 3*) himself and Abraham, too, were saved from the evil consequences of his meditated act.

When Jacob was, as it were, banished from his father's house, in order to avoid the effects of his brother's implacable rage, he came to a place called *Luz* (*Gen. xxviii. 19*), and, whilst there sleeping under the canopy of heaven, he had communication by dream, not only with angels, but with God also:—'He dreamed, and beheld a ladder set upon the earth, &c. This was an encouraging dream to Jacob, for it filled his soul with holy and awful thoughts of God. On awaking we do not find this patriarch dismissing the thought of the dream from his mind; but he exclaims, 'Surely the Lord was in this place, and I knew it not! and he was afraid, and said, How dreadful is this place! This is none other but the house of God, this is the gate of heaven!' He even set up a pillar to perpetuate its memory, and made a solemn vow that Jehovah should be his God. And, moreover, such was the deep impression which this dream made upon his mind, that God, who appeared many years afterwards to him when yet in Padan-aram, and bade him return to his fatherland, urges this as a motive:—'I am the God of Beth-el, where thou appointedst the pillar, and where thou vowedst a vow unto me.' We are informed in the sequel how God did fulfil to him all that he had then promised.

But, though this was the first, it was not the last time God appeared to Jacob in a dream. In *Gen. xxxi. 10*, Jacob informs his wives that it was God who saw how Laban oppressed him—who had directed him to take the speckled, &c. cattle for his wages, and had ordered him to return home. He obeyed; and when Laban, designing to do Jacob some harm (*Gen. xxxi. 24*), pursued, and after seven days overtook him, God, by a dream, prevented the meditated evil.

Joseph, whilst yet a child, had dreams *predictive* of his future advancement (*Gen. xxxvii. 6-11*). These dreams are *one*, and were repeated under different forms, in order, it would seem, to express the certainty of the thing they predicted. How they formed the first link in an extended chain of God's providential dealings the sacred record fully informs us. Jealous not only of the partiality of their father for Joseph, but also of that which God would evince by these dreams for him, his brethren hated him, and sold him to the Midianites. From their hands he was trans-

ferred to Potiphar, captain of Pharaoh's guard, and from him, under the cruel and unjust accusation of his vile wife, was cast into the king's prison—alas! in this position Satan might well tempt Joseph to doubt the kind providence of the God whom he served. But no—he felt assured that the Lord was with him, and that, in His own *time* and *manner*, he would vindicate his innocence, and give him his liberty. Nor was this confidence of Joseph disappointed; for, in the course of time, by being able to give an accurate interpretation of three *predictive* dreams, he was raised from the prison to a participation with King Pharaoh in the government of Egypt! It is true that a daring infidelity has tried to reduce the *first* of this series of dreams to a natural principle—the constitutional vanity of the dreamer's mind—and thus to set aside its divine character and tendency. But, granting for a moment that Joseph vainly read in the partial feelings of his father his own eventual elevation over his brethren, and that by reason of the impression which this flattering prospect made upon his mind he was led to dream as above noticed, still, this could not alter the predictive character of the dream: and in proof of this we appeal to the account of its actual fulfilment. It is quite clear from the inspired history that dreams were looked upon by the earliest nations of antiquity as premonitions from their idol gods of future events. One part of Jehovah's great plan in revealing, through this channel, His designs toward Egypt, Joseph individually, and his brethren generally, was to correct this notion. Hence it was that, on Joseph being brought into the presence of Pharaoh for the purpose of explaining his dreams, he at once says, '*it is not in me; God shall give Pharaoh an answer of peace.*' Such were some of the dreams by which God revealed himself under the patriarchal dispensation, and that the same divine mode of communicating with man was continued under that of Moses is evident from an express word of promise (Num. xii. 6), 'If there be a prophet among you I, the Lord, will make myself known unto him in a vision, and will speak to him in a *dream.*' That dreams were one of the ways whereby God was wont to signify his pleasure to men under this dispensation is evident from the complaint of Saul to the spirit of Samuel (whom the witch pretended to raise up), when he asked him, 'Why hast thou disquieted me to bring me up?' Saul answered, 'I am sore distressed; for the Philistines make war against me, and God is departed from me, and answers me no more; neither by prophets, nor by *dreams*: therefore I have called thee that thou mayest make known to me what I shall do.' And, in order to guard against imposition, Moses pronounced a penalty against dreams which were invented and wickedly made use of, for the promotion of idolatry (Deut. xiii. 1-5). Thus Zechariah (x. 2) complains: 'The idols have spoken vanity, and the diviners have spoken a lie, and have told *false dreams*; they comfort in vain.' And so Jeremiah (xxiii. 25), 'I have heard what the prophets said that prophesy lies in my name, saying, I have dreamed, I have dreamed,' &c. Yet this abuse did not alter God's plan in the right use of them; for in the 28th verse of the same chapter, it is said, 'the

prophet that hath a *dream*, and he that hath *no* word, let him speak my word faithfully. What is the chaff to the wheat? saith the Lord.'

When Gideon warred with the Amalekites, and was alarmed at their vast multitudes, he was encouraged to do God's will by overbearing one of them relate his dream, and another giving the interpretation (Judg. vii.). Again, it was in a dream that God was pleased to grant Solomon a promise of wisdom and understanding (1 Kings iii. 5, &c.). Here we may perceive what converse the Lord was pleased to hold with Solomon in a dream; and the sacred record informs us how punctually everything herein promised was fulfilled.

But, though God speaks frequently by dreams, yet man is often found actually closing his ears against such communications. Thus Job says (xxxiii. 14), 'God speaketh once, yea twice, yet man perceiveth it not. In a dream, in a vision of the night, when deep sleep falleth upon men, in slumbering upon the bed, then he openeth the ears of men and sealeth their instruction.'

Sometimes those dreams and visions are of a *pleasurable* and again of a *frightful* character:—'When I say my bed shall comfort me, my couch shall ease me; then thou scarest me with dreams and terrifiest me with visions' (Job vii. 14).

The knowledge of visions and dreams is reckoned amongst the principal gifts and graces sometimes bestowed by God upon them that fear him; so it is said of Daniel and his companion, that 'God gave them knowledge and skill in all learning and wisdom: and Daniel had understanding in all visions and dreams (Dan. i. 17). And the God who had imparted this spirit unto his servant Daniel soon, in the arrangement of his providence, gave occasion for its exercise. Nebuchadnezzar, king of Babylon, dreamed a dream, and his spirit was troubled because the thing had gone from him. Having, however, a deep impression that the dream was of potentous meaning, he called together his magicians, astrologers, and sorcerers, and commanded them to recall and explain it to him. These reputedly wise men of Babylon at once acknowledged that to meet the king's wishes belonged not to the capacity of a man. Disappointed and enraged at this confessed impotency, he ordered all the wise men of his kingdom to be put to death. Daniel being included in this order implored God to reveal to him the dream with its interpretation: his prayer was graciously answered (Dan. ii. 19). Whereupon he acquaints the king, that 'there is a God in Heaven who revealeth secrets, and maketh known to him what shall be in the latter days; and then proceeds to state the dream together with the interpretation thereof. Satisfied with what Daniel stated, Nebuchadnezzar said unto Daniel, 'Of a truth it is that your God is a God of gods, and a Lord of kings;' and the divine historian states that in consequence of this both the prophet, and Shadrach, Meshach, and Abednego were promoted to the highest offices of the state! In this dream a great variety of ends were attained in reference to *Babylon*, Israel, and indeed the world—all of which were worthy of God's miraculous interference.

That this method of God's revealing himself was not confined to the legal dispensation, but

was to be extended to the Christian is evident from Joel (ii. 28), 'And afterwards (saith the Lord) I will pour out my spirit upon all flesh; and your sons and your daughters shall prophesy; your young men shall see visions, and your old men shall dream dreams.' In Acts ii. 17 we find the Apostle Peter applying this to the illumination of the Holy Ghost. Accordingly, we read that when Joseph designed to put Mary away, because he perceived her to be with child, he was turned from his purpose by a dream, in which an angel made the truth of the matter known to him (Matt. i. 20). And in the following chapter it is stated, that God, in a dream, warned the wise men not to return to Herod. Moreover, in verses 13 and 19, Joseph is instructed to flee into and return from Egypt with the child Jesus.

Whether the dream of Pilate's wife was a divine intimation we cannot tell.

That divine dreams, which actually were imparted to God's servants, should be imitated in fictitious representation by ancient and modern writers, was consistent no less with the general objects of superstition and imposture than with those of literature. Hence divine dreams became the constant appendages of the heathen mythology, and accounts, real and fictitious, of communications in vision, were interwoven in every production. Information which was superior to the vulgar philosophy of the time, intimated its discoveries as suggestions imparted by *inspiration*. If a warning was to be conveyed, what so affecting as the admonition of a departed friend! Such machinery was particularly adapted to works of imagination, and the poems of antiquity, as well as those of modern times, were frequently decorated with its ornaments.

We inquire not *how* far God may have revealed himself to man beyond what Holy Scripture records. Some of the dreams, both of ancient and modern times, which lay claim to a divine character, are certainly striking, and may, for aught we know, have had, and may still have, a collateral bearing on the development of God's purposes.—J. W. D.

DRESS. The subject of the costume of the ancient Hebrews is involved in much obscurity and doubt. Sculptured monuments and coins afford us all needful information respecting the dress of the ancient Egyptians, Babylonians, Persians, Greeks, and Romans; and even the garb worn by the barbarous nations is perpetuated in the monuments of their antagonists and conquerors. But the ancient Hebrews have left no monuments, no figures of themselves; and the few figures which have been supposed to represent Jews in the monuments of Egypt and Persia are so uncertain, that their authority remains to be established before we can rely upon the information which they convey. There are, however, many allusions to dress in the Scriptures, and these form the only source of our positive information. They are often, indeed, obscure, and of uncertain interpretation; but they are invaluable in so far as they enable us to compare and verify the information derivable from other sources. These sources are:—

1. The costume of neighbouring ancient nations, as represented in their monuments.

2. The alleged costume of Jews as represented in the same monuments.

3. The present costumes (which are known to be ancient) of Syria and Arabia.

4. Tradition.

1. The range of inquiry into monumental costume is very limited. It is a common mistake to talk of 'Oriental costume,' as if it were a uniform thing, whereas, in fact, the costumes of the Asiatic nations differ far more from one another than do the costumes of the different nations of Europe. And that this was the case anciently, is shown by the monuments, wherein the costumes of Egyptians, Babylonians, Persians, Medes, Syrians, and Greeks, differ as much from one another as do the costumes of the modern Syrians, Egyptians, Arabs, Turks, and Persians. It is therefore useless to examine the monumental costume of any nation, remote from Palestine, for the purpose of ascertaining the costume of the ancient Hebrews. Syria, Arabia, and Egypt, are the only countries where monuments would be likely to afford any useful information: but Arabia has left no monumental figures, and Syria none of sufficiently ancient date; and it is left for Egypt to supply all the information likely to be of use. The extent and value of this information, for the particular purpose, we believe to be far less than is usually represented. That we are not disposed to undervalue the information derivable from the Egyptian monuments for the purpose of illustrating Biblical history and antiquities, the pages of the present work will sufficiently evince; and its editor may indeed claim to have been the first in this country to work this mine of materials for Biblical illustration. But the rage for this kind of illustration has been carried to such preposterous lengths, and is so likely in its further progress to confuse our notions of the real position which the Hebrews occupied, that it may not be an unwholesome caution to remind our readers that the Egyptians and the Hebrews were an exceedingly different people—as different in *every* respect as can well be conceived; and that the climates which they inhabited were so very different as to *necessitate* a greater difference of food and dress than might be pre-supposed of countries so near to each other. This consideration appears to us to render of little value the very ingenious illustrations of Jewish costume which have been deduced from this source. It is true that the Jewish nation was cradled in Egypt; and this circumstance may have had some influence on ceremonial dresses, and the ornaments of women; but we do not find that nations circumstanced as the Jews were readily adopt the costumes of other nations, especially when their residence in Egypt was always regarded by them as temporary, and when their raiment was of home manufacture—spun and woven by the women from the produce of their flocks (Exod. xxxv. 25). We find also that, immediately after leaving Egypt, the principal article of dress among the Hebrews was some ample woollen garment, fit to sleep in (Exod. xxii. 27), to which nothing similar is to be seen among the costumes of Egypt.

2. With respect to the supposed representation of Jews in ancient monuments, if any authentic examples could be found, even of a single figure, in the ancient costume, it would afford much sa-

tisfaction, as tending to elucidate many passages of Scripture which cannot at present be with certainty explained. The sculptures and paintings supposed to represent ancient Hebrews are contained in —

(a.) A painting at Beni Hassan, representing the arrival of some foreigners in Egypt, and supposed to figure the arrival of Joseph's brethren in that country. The accessories of the scene, the physiognomies of the persons, and the time to which the picture relates, are certainly in unison with that event: but other circumstances are against the notion. Sir J. G. Wilkinson speaks hesitatingly on the subject: and, until some greater certainty is obtained, we may admit the possible correctness of the conjecture. The annexed cut

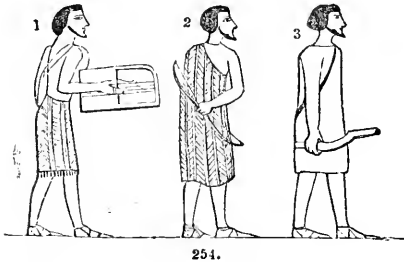

254.

shows the variety of costume which this scene displays. All the men wear sandals. Some of them are clad only in a short tunic or shirt, with close sleeves (fig. 3); others wear over this a kind of sleeveless plaid or mantle, thrown over the left shoulder, and passing under the right arm (fig. 2). It is of a striped and curiously figured pattern, and looks exceedingly like the fine grass woven cloth of the South Sea. Others have, instead of this, a fringed skirt of the same material (fig. 1). All the figures are bare-headed, and wear beards, which are circumstances favourable to the identification. The fringed skirt of fig. 1 is certainly a remarkable circumstance. Moses directed that the people should wear a fringe at the hem of their garments (Num. xv. 38); and the probability is that this command merely perpetuated a more ancient usage.

(b.) This fringe re-appears, much enlarged, in the other Egyptian sculpture in which Jews are supposed to be represented. These are in a tomb discovered by Belzoni, in the valley of Babel Melook, near Thebes. There are captives of different nations, and among them four figures, supposed to represent Jews. The scene is imagined to commemorate the triumphs of Pharaoh-

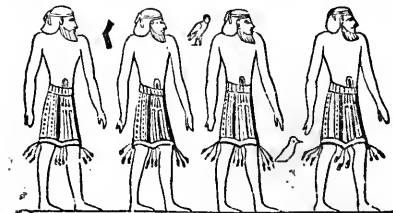

255.

Necho in that war in which the Jews were defeated at Megiddo, and their king Josiah slain

(2 Chron. xxxv. xxxvi.). It will be seen that the dress of these figures differs little, excepting in the length of the fringe, from that of the skinned figure in the earlier painting; and so far this is a corroborative circumstance in favour of both. The band round the head is the other principal difference. These figures are manifestly in what we would call undress, and the comparison being made with the similar undress figures in the earlier scene, the resemblance is greater than might be expected from the distance of time and difference of manners. The internal evidence is so far good; and if the external evidence were equally strong, there would not be much ground for hesitation.

(c.) On the face of a rock, at Beisitoon, on the Median border of the ancient Assyria, there is a remarkable sculpture representing a number of captives strung together by the neck, brought before the king and conqueror, who seems pronouncing sentence upon them. The venerable antiquity of this sculpture is unquestionable; and Sir R. K. Porter was led to fancy that the sculpture commemorates the subjugation and deportation of the ten tribes by Shalmanezzer, king of Assyria (2 Kings xvii. 6). The reasons which he assigns for this conclusion are of little weight, and not worth examination. But the single fact that the figures are arrayed in a costume similar to the ancient and present garb of the people of Syria and Lebanon, inclines us to think that the figures really do represent the costume of nations west of the Euphrates, including, probably, that of the Jews and their near neighbours. The dress here



256.

shown is a shirt or tunic confined around the waist by a strap or girdle; while others have a longer and larger robe, furnished with a spacious cape or hood, and, probably, worn over the other.

There is no reason to think that the dress of the Jews was in any important respect different from that of the other inhabitants of the same and immediately bordering countries. It would therefore be satisfactory, and would enable us to judge better of the figures which have been noticed, if we had representations of Canaanites, Phœnicians, Syrians, Moabites, &c., by the Egyptian artists, who were so exact in discriminating, even to caricature, the peculiarities of nations. At p. 226 there is a supposed figure of a Canaanite warrior from this source. The dress being military does not afford much room for comparison in the present instance; but we at once recognise in it most of the articles which formed the military dress of the Hebrews. The following figures (No. 257), however, convey more information, as they appear to represent inhabitants of Syria and Lebanon. The evidence for the last (fig. 2) is as conclusive as can be obtained, for not only is there the name Lemanon (*m* being constantly interchanged with *b*), but the persons thus attired are represented



257.

as inhabiting a mountainous country, and felling *fir*-trees to impede the chariots of the Egyptian invaders. The dresses are similar to each other, and this similarity strengthens the probability that the dress of the Jews was not very different; and it is also observable that it is similar to the full dress of some of the figures in the sculpture at Besitoon: the figures are bearded, and the cap, or head-dress, is bound round with a fillet. The figures are arrayed in a long gown reaching to the ankles, and confined around the waist by a girdle; and the shoulders are covered by a cape which appears to have been common to several nations of Asia. At first view it would seem that this dress is different from those already figured. But in all probability this more spacious robe is merely an outer garment, covering that inner dress which is shown in the figures that seem more scantily arrayed.

Such is the amount of the information to be derived from ancient monuments.



258.

That to be obtained from tradition is embodied—1. In the dresses of monks and pilgrims, which may be traced to an ancient date, and which are an intended imitation of the dresses supposed to have been worn by the first disciples and apostles of Christ. 2. The garb conventionally assigned by painters to Scriptural characters, which were equally intended to embody the dress of the apostolical period, and is corrected in some degree by the notions of Oriental costume which were collected during the Crusades.

To judge of the value of these costumes, we must compare them, first, with the scanty materials already produced, and then with the modern costumes of Syria and Arabia. The result of this examination will probably be that these traditional garbs are by no means bad remi-

niscences of Hebrew costume; and that the dresses which the painters have introduced into Scriptural subjects are far more near to correctness than it has latterly been the fashion to suppose. It is perhaps as nearly as possible a just medium between the ecclesiastical tradition and the practical observation. No dress more suitable to the dignity of the subjects could possibly be devised: and, sanctioned as it has been by long use, and rendered venerable by Scriptural associations, we should be reluctant to see it exchanged for the existing Oriental costumes, which the French artists have begun to prefer. But this



259.

is only with regard to pictorial associations and effects; for, in an inquiry into the costume *actually* worn by the Israelites, modern sources of illustration must be by no means overlooked. And to that source of illustration we now turn.

The value of the modern Oriental costumes for the purposes of Scriptural illustration arise from the fact that the dress, like the usages, of the people is understood to be the same, or nearly the same, which was used in very ancient times. Of the fact itself, nakedly taken, there is not the least room for doubt. But this must be understood with some limitations. The dress of the Turks is distinctive and peculiar to themselves, and has no connection with the aboriginal costumes of Western Asia. The dress of the Persians has also been changed almost within the memory of man, that of the ruling Tartar tribe having been almost invariably adopted; so that the present costume is altogether different from that which is figured by Sir Thomas Herbert, Chardin, Le Bruyn, Niebuhr, and other travellers of the seventeenth and eighteenth centuries. But with the exceptions of the foreign Turkish costume, and the modifications thereof, and with certain local exceptions, chiefly in mountainous regions, it may be said that there is one prevailing costume in all the countries of Asia between the Tigris and Mediterranean, and throughout Northern Africa, from the Nile to Morocco and the banks of the Senegal. This costume is substantially Arabian, and owes its extension to the wide conquests of the Arabians under the first caliphs; and it is through the Arabians—the least changed of ancient nations, and almost the only one which has remained as a nation from ancient times—that the antiquity of this costume may be proved. This is undoubtedly the most ancient costume of

Western Asia, and while one set of proofs would carry it up to Scriptural times, another set of strong probabilities and satisfactory analogies will take it back to the most remote periods of Scriptural history, and will suggest that the dress of the Jews themselves was very similar, without being strictly identical.

It would be a pleasant task to trace out these lines of proof and analogy. This cannot here be done; but it may be proper to remark—1. That the usages of the Arabians in Syria and Palestine are more in agreement with those of Scripture than those of any other inhabitants of those countries. 2. That their costume throws more light on the Scriptural intimations than any other now existing, while it agrees more than any other with the materials supplied by antiquity and by tradition. 3. That the dress which the Arabian garbs gradually superseded in Syria and Palestine was not the same as that of Scriptural times, excepting, perhaps, among the peasantry, whose dress appears to have then differed little from that of the Arabian conquerors. The Jews had for above five centuries ceased to be inhabitants of Palestine; and it is certain that during the intermediate period the dress of the upper classes—the military and the townspeople—had become assimilated to that of the Greeks of the Eastern empire. Arabia had meanwhile been subjected to no such influences, and the dress which it brought into Syria may be regarded as a restoration of the more ancient costume, rather than (as it was in many countries) the introduction of one previously unknown.

It is to be observed, however, that there are two very different sorts of dresses among the Arabians. One is that of the Bedouin tribes, and the other that of the inhabitants of towns. The distinction between these is seldom clearly understood, or correctly stated; but is of the utmost importance for the purpose of the present notice. Instead therefore of speaking of the Arabian costume as one thing, we must regard it as two things—the desert costume, and the town costume.

If, then, our views of Hebrew costume were based on the actual costume of the Arabians, we should be led to conclude that the desert costume represented that which was worn during the patriarchal period, and until the Israelites had been some time settled in Canaan; and the town costume that which was adopted from their neighbours when they became a settled people.

This is a subject which, more than any other, requires the aid of pictorial illustration to render the details intelligible. Having provided ourselves with these, our further observations will most advantageously take the form of explanations of them, and of comments upon them.

Under the notion that the desert costume belongs to the patriarchal period, the precedence is here given to it. Only the outer articles of dress are *distinctive*, those which are worn underneath being similar to other articles worn by the town and peasant classes, and which as such will be hereafter noticed.

The annexed cut (No. 260) represents, in fig. 2, a Bedouin, or desert Arab, in the dress usually worn in Asia; and fig. 1 represents a townsman in a cloak of the same kind, adopted from the Arabs, and worn very extensively as an outermost covering in all the countries from the Oxus



260.

(for even the Persians use it) to the Mediterranean. The distinctive head-dress of the Bedouin, and which has not been adopted by any other nation, or even by the Arabian townsmen, is a kerchief (*keffeh*) folded triangularly, and thrown over the head so as to fall down over the neck and shoulders, and bound to the head by a band of twisted wool or camel's hair. We forbear at the moment from inquiring whether this was or was not in use among the ancient Hebrews. The cloak is called an *abba*. It is made of wool and hair, and of various degrees of fineness. It is sometimes entirely black, or entirely white, but is more usually marked with broad stripes, the colours of which (never more than two, one of which is always white) are distinctive of the tribe by which it is worn. The cloak is altogether shapeless, being like a square sack, with an opening in front, and with slits at the sides to let out the arms. The Arab who wears it by day, sleeps in it by night, as does often the peasant by whom it has been adopted; and in all probability this was the garment similarly used by the ancient Hebrews, and which a benevolent law, delivered while Israel was still in the desert, forbade to be kept in pledge beyond the day, that the poor might not be without a covering at night (Exod. xxii. 27). This article of dress appears to have been little known to Biblical illustrators, although it is the principal and most common outermost garment in Western Asia. This singular neglect has arisen from their information being chiefly derived from Shaw and others, who describe the costume of the Arab tribes or Moors of Northern Africa, where the outer garment is more generally the *bourmoos* (No. 260, fig. 3), a woollen cloak, not unlike the *abba*, but furnished with a hood, and which is sometimes strangely confounded even by well informed persons with a totally different outer-garment worn in the same regions, usually called the *hyke*, but which is also, according to its materials, quality, or colour, distinguished by various other names; and writers have produced some confusion by not observing that these names refer to an article of raiment which under all these names is essentially the same. Regardless of these minute distinctions, this part of dress may be described as a large woollen blanket, either white or brown, and in summer a cotton sheet (usually blue or white, or both colours together). Putting one corner before

over the left shoulder, the wearer brings it behind, and then under the right arm, and so over the body, throwing it behind over the left shoulder, and leaving the right arm free for action. This very picturesque mode of wearing the *hyke* is shown in fig. 2 (No. 261). Another mode of wear-



261.

ing it is shown in fig. 3. It is sometimes thrown over the head as a protection from the sun or wind (fig. 1), and calls to mind the various passages of Scripture in which persons are described as covering their heads with their mantles (2 Sam. xv. 30; 1 Kings xix. 13; Esther vi. 12). This article of dress, originally borrowed from the nomades, is known in Arabia, and extends westward to the shores of the Atlantic, being most extensively used by all classes of the population. The seat of this dress, and of the *abba* respectively, is indicated by the direction of their importation into Egypt. The *hykes* are imported from the west (*i. e.* from North Africa), and the *abbas* from Syria. The close resemblance of the above group of real costume to those in which the traditional ecclesiastical and traditional artistic costumes are displayed, must be obvious to the most cursory observer. It may also be noticed that the *hyke* is not without some resemblance, as to the manner in which it was worn, to the outer garment of one of the figures in the Egyptian family, supposed to represent the arrival of Joseph's brethren in Egypt (No. 254, fig. 1).

We now turn to the costumes which are seen in the towns and villages of south-western Asia.

In the Scriptures *drawers* are only mentioned in the injunction that the high-priest should wear them (Exod. xxviii. 42), which seems to show that they were not generally in use; nor have we any evidence that they ever became common. Drawers descending to the middle of the thighs were worn by the ancient Egyptians, and workmen often laid aside all the rest of their dress when occupied in their labours. As far as this part of dress was used at all by the Hebrews, it was doubtless either like this, or similar to those which are now worn in Western Asia by all, except some among the poorer peasantry, and by many of the Bedouin Arabs. They are of linen or cotton, of ample breadth, tied around the body by a running string, or band, and always worn next the skin, not over the shirt as in Europe.

It will be asked, when the poor Israelite had

pawned his outer-garment 'wherein he slept,' what dress was left to him? The answer is probably supplied by the annexed engraving (No. 262), which represents slightly different garments of cotton, or woollen frocks or shirts, which often, in warm weather, form the sole dress of the Bedouin peasants, and the lower class of townspeople. To this the *abba* or *hyke* is the proper outer robe (as in fig. 1, No. 261), but is usually, in summer, dispensed with in the day-time, and in the ordinary pursuits and occupations of life. It is sometimes (as in No. 262, fig. 2) worn without, but more usually with, a *girille*; and it will be seen that the shorter specimens are not unlike the dress of one of the figures (fig. 3, No. 254) in the earliest of the Egyptian subjects which have been produced. The shirt worn by the superior classes is of the same shape, but of finer materials. This is shown in the figure below (No. 263), which represents a gentleman as just risen from bed. If we call this a shirt, the Hebrews doubtless had it—the sole dress (excepting the cloak) of the poor, and the inner robe of the rich. Such, probably, were the



262.

'sheets' (translated 'shirts' in some versions), of which Samson spoiled thirty Philistines to pay the forfeit of his riddle (Judg. xiv. 13, 19). It



263.

is shown from the Talmud, indeed, that the Hebrews of later days had a shirt called *חלוק* *chaluk*, which it would appear was often of wool (Lightfoot, *Hor. Heb.* on Luke ix. 3), and which is described as the ordinary inner-garment, the *outer*

being the cloak or mantle. This shows that the shirt or frock was, as in modern usage, the ordinary dress of the Jews, to which a mantle (abba, hyke, or bounnos) was the outer covering.

The Talmud enumerates eighteen several garments which formed the clothing of the Jews from head to foot (T. Hieros. *Sabb.* fol. 15; T. Bab. *Sabb.* fol. 120), mentioning, however, two sandals, two buskins, &c. This shows, at least, one thing, that they were not more sparingly clad than the modern Orientals. This being the case, we may be sure that although persons of the humbler classes were content with the shirt and the mantle, the wealthier people had other robes between these two, and forming a complete dress without the mantle, which with them was probably confined to out-of-door wear, or ceremonial use. It is of course impossible to discriminate these precisely; but in this matter we cannot be far wrong in trusting to the analogy of existing usages.

In all the annexed figures (No. 264) representing persons of the superior class, we observe the shirt



264.

covered by a striped (sometimes figured) gown or caftan, of mingled silk and cotton. It descends to the ankles, with long sleeves, extending a few inches beyond the fingers' ends, but divided from a point a little above the wrist, so that the hand is generally exposed, though it may be concealed by the sleeve when necessary; for it is customary to cover the hands in the presence of a person of high rank. It is very common, especially in winter, for persons to sleep without removing this gown, but only unloosing the girdle by which it is bound. It is not unusual within doors to see persons without any article of dress outside this; but it is considered decidedly as an undress, and no respectable person is beheld out of doors, or receives or pays visits, without an outer covering. Hence persons clad in this alone are said to be 'naked' in Scripture—that is, not in the usual complete dress; for there can be no manner of doubt that this, or something like this, is the כַּתְּמֹנֶת *catoneth* of the Scripture (Exod. xxviii. 40; Job xxx. 18; Isa. xxii. 21, &c.). A similar robe is worn by the women, as was also the case among the Israelites (2 Sam. xiii. 18, 19; Cant. v. 3). It is in the bosom of this robe that various articles are carried, and hence the Scriptural expression of giving things 'into the bosom.'

The girdle worn over this, around the waist, is usually a coloured shawl, or long piece of figured white muslin. The girdle of the poorer classes is of coarse stuff, and often of leather, with clasps. This leathern girdle is also much used by the Arabs, and by persons of condition when equipped for a journey. It is sometimes ornamented with workings in coloured worsted, or silk, or with metal studs, shells, beads, &c. Both kinds of girdles were certainly in use among the Hebrews (2 Kings i. 8; Matt. iii. 4; Mark i. 6; comp. Jer. xiii. 1). It is known to all readers of Scripture how often the 'girdle' and the act of 'girding the loins' is mentioned. It seems from 2 Sam. xx. 8 (comp. also the Syrian figure, No 257, fig. 1), that it was usual to wear a knife or poniard in the girdle. This custom is still general, and denotes not any deadly disposition, but the want of clasp knives. Men of literary vocations replace it by an inkhorn, as was also the case among the Israelites (Ezek. ix. 2).

Over the gown is worn either the short-sleeved *gibbeh* (fig. 3), which is a long coat of woollen cloth; or the long-sleeved *benish* (fig. 2), which is also of woollen cloth, and may be worn either over or instead of the other. The *benish* is, by reason of its long sleeves (with which the hands may be covered), the robe of ceremony, and is worn in the presence of superiors and persons of rank. Over one or both of these robes may be worn the abba, bounnos, or hyke, in any of the modes already indicated. Aged persons often wrap up the head and shoulders with the latter, in the manner shown in fig. 4.

This same hyke or wrapper is usually taken by persons going on a journey, for the purpose of being used in the same manner as a protection from the sun or wind. This is shown in the annexed cut, representing a group of persons equipped for travel. The robe is here more succinct and compact, and the firm manner in which the whole dress is girdled up about the loins calls to mind the passages of Scripture in which the action of 'girding up the loins' for a journey is mentioned.



265.

From this it is also seen that travellers usually

wear a sword, and the manner in which it is worn is correctly shown. It would also appear that the Jews had swords for such occasional uses (Matt. xxvi. 51; Luke xxii. 36).

The necessity of having the arm for any kind of exertion, must be evident from the manner in which it is encumbered in all the dresses we have produced. This action is often mentioned in Scripture, which alone proves that the arm was in ordinary circumstances similarly encumbered by the dress. For ordinary purposes a hasty tucking up of the sleeve of the right arm suffices; but for a continued action special contrivances are necessary. These are curious, as will be seen by the cut (No. 266). The full sleeves of the



266.

shirt are sometimes drawn up by means of cords, which pass round each shoulder, and cross behind, where they are tied in a knot. This custom is particularly affected by servants and workmen, who have constant occasion for having the arm; but others, whose occasions are more incidental, and who are, therefore, unprovided with the necessary cords, draw up the sleeves and tie them together behind between the shoulders (fig. 2).

For the dress of females we must refer to the article WOMEN. Certain parts of dress, also, admit of separate consideration, such as the head-dress [TURBAN], and the dress of the feet [SANDALS].

DRINK, STRONG. The Hebrew שָׂרָב seems to demand a more particular elucidation than it has yet received, inasmuch as it had in all probability a much wider signification than is now conveyed by the phrase 'strong drink.' Mr. Mill, in guarding against the common fallacies arising from the changes and corruptions continually going on in the meaning of terms, by which their signification is modified, narrowed, or enlarged, justly observes that 'we continually have cause to give up the opinions of our forefathers; but to tamper with their language, even to the extent of a word, is an operation of much greater responsibility, and implies, as an indispensable requisite, an accurate acquaintance with the history of the particular word, and of the opinions (or objects) which, in different stages of its progress, it served to express. To be qualified to define the name, we must know all that has ever been known of the properties of the class of objects which are, or originally were, denoted by it' (*Logic*, ii. 261). The mischiefs of an oppo-

site course of criticism have been too evident in biblical literature, but are now beginning to be remedied and corrected. 'Two or three authors,' observes the Abbé Renandot, 'who but copy from each other, suffice to give birth to a notion which spreads unexamined by those who follow them: this throws a mist over history, and gives an opportunity to confound truth with falsehood'—an observation not inapplicable to the word under discussion. The principle of interpretation laid down above we have endeavoured to keep steadily in view in treating of this and other kindred subjects; and with regard to the particular word before us, it has been our study to acquire an accurate acquaintance with its history, as well as with that of its derivatives, and as perfect a knowledge of the class of products which are, or originally were, denoted by it, as the lapse of time and the obscurity of the inquiry will permit. The sources open for the illustration of the subject appear to be:—the context of the passages in the Hebrew Scriptures where the noun occurs, which it does twenty-three times, twenty-one in conjunction with יַיִן, *wine*; the verbs and secondary nouns formed from the primordial noun, which express or imply the quality of the original object; the affinities of terms supplied by the kindred or derivative languages, Syro-Arabian or Indo-Germanic; and the evidence of travellers and naturalists respecting the nature of the class of objects denoted by the original שָׂרָב, or by words analogous to it. [In illustration of the philological changes subsequently noticed, we beg to refer to the principles laid down and developed in the articles ALPHABET and ARABIC LANGUAGE.] We shall class the various senses of the word under three heads, in the order in which we conceive them to have been developed.

1. שָׂרָב *shechar*, luscious, *saccharine* drink, or SWEET SYRUP, especially sugar or honey of dates, or of the palm-tree (דֵּבַשׁ *debash*); also, by accommodation, occasionally the sweet fruit itself. Herodotus, Varro, Dioscorides, Elian, Tertullian, A. Aphrodisæus, and others, speak of *saccharon*, sugar, as 'honey made by men.' By sugar or honey the Jews understood not only honey of bees, but also syrups made from the fruit or juice of the palm and other trees. Hence sugar is expressed by the Rabbins as דֵּבַשׁ קָיִם (Joseph. *De Bell. Jud.* v. 4; *Mishna*, Tr. *Nedarim*, vi. 8-10; *Talmud*, Tr. *Berachoth*, fol. 38 a; Tr. *Chulin*, 120 b; *Terumoth*, xi. 2; Maimonides, *Comment. in Tr. Biccuring*, i. *Mish.* 3; D'Oyly's *Calmet*, art. 'Honey'; Bochart, Celsius). Dr. T. M. Harris says that 'it is probable that they (the Jews) used it (שָׂרָב) to SWEETEN their wine, as we [*i. e.* the Americans] put honey into cider to encourage people to drink freely'—a singular observation, illustrating how far our conceptions of foreign customs are moulded by those which we witness at home. 'In Solomon's time, and afterwards,' continues Dr. Harris, 'the wine and sweet cordials seem generally to have been used separately' (*Nat. Hist. of Bible*). It seems more probable, however, that the palm syrup or honey denoted by שָׂרָב, was used both as a sweetener or article of food, and as a drink, like the Hebrew סֹבֵב *sobbe* and the Roman *sapa* (boiled wine), diluted with water, as with the modern grape and honey syrups or sherbets (Prov. ix. 2, 5). The

derivatives of *shechar*, expressive of its first signification, are numerous. Eastward and southward, following the Arabian channel and the Saracenic conquests, we meet with the most obvious forms of the Hebrew word still expressive of sugar. Thus we have the Arabic *سكر sakar*;

Persic and Bengálí, *shukkur* (whence our word for sugar-candy, *shukur-kund*, 'rock-sugar'); common Indian, *jaggree* or *zhuggery*; Moresque, *shkkour*; Spanish, *azucar*; and Portuguese, *asucar* (molasses being *mel-de-assucar*, 'honey of sugar,' abbreviated). The wave of population has also carried the original sense and form northwards, embodying the word in the Grecian and Teutonic languages. Hence Greek, *σάκχαρ*; Latin, *saccharum*; Italian, *zucchero*; German, *sacher* and *juderig*; Dutch, *suiker*; Russian, *sachar*; Danish, *sukker*; Swedish, *socker*; Welsh, *siogwr*; French, *sucre*; and our own common words *sukkar* (sweetmeat), *sugar*, and *saccharine*. 'Sukkarke' is also an old English word clearly traceable in sense and sound to the same origin, and is used by the writers of the middle ages in the sense of dainty, dessert, or sweetmeat.

This view of the objective noun is supported by the primary significations of the verbal noun *שָׂכַר shachar*, to *satisfy* or *satiate* (whence the sense of *reward*, *wages*, &c., attached to other forms of it. To satisfy or cloy is the well-known property of sweet and luscious preparations (as honey, Prov. xxv. 16, 27); whereas 'strong-drink,' in the modern sense of intoxicating, is proverbial for creating an appetite which is insatiable. The drinkers of it 'tarry long at the wine; they rise up early in the morning and continue until night, till wine inflames them; and when, after suffering its evils, they awake, their cry still is, 'I will seek it yet again' (Prov. xxiii. 30-35; Isa. v. 11, 22). It is easy to perceive how the innocent sense of *שָׂכַר*, as to eat or drink to satiety, gradually had the idea of *excess* superadded to it. The Greek *μεθωσ*, frequently used by the Septuagint translators as the representative of *שָׂכַר*, is a case in point. It first signified to drink to fullness—next, to excess—and, lastly, to intoxication. Thus the Latin *glutio*, 'to swallow,' became the parent of *glutton*, 'one who eats or drinks to excess.' So *drunk*, the past tense of the infinitive 'to drink,' in like manner, came to signify *inebriated*; and the verbal noun 'to fill' in North Britain gave rise to *fou*, meaning not merely full, but intoxicated. An old French word, now obsolete, *sacrè* or *saker*, 'a glutton,' appears to have been derived from the Hebrew word. The Arabic has derivatives corresponding to those of the Hebrew, viz. *شكر*

merces, *شكر*, *gratias egit*. The following testimonies, explanatory of the primitive sense and nature of *שָׂכַר*, may be selected from a multitude of travellers and authorities, ancient and modern.

'It is usual,' says Dr. Shaw (*Travels*, i. 262), 'with persons of better fashion, upon a marriage, at the birth or circumcision of a child, or upon any other feast or good day, to entertain their guests with the honey, or *dipse*, as they call it, of the palm-tree.' This serves to explain the sense of *רָבַשׁ* in Gen. xliiii. 11. From the fact that

Egypt produces an abundance of honey, we may be led to suppose that the *more valuable date honey* is here intended, which is rarely found in Egypt' (Dr. Sola, Lindenthal, and Raphall's note in *New Translation of the Scriptures*). Vegetable honey, or syrup of dates and of grapes (*rob-el-aneb*), is still largely imported into Egypt. 'The extensive importance of the date-tree,' observes Dr. E. Clarke (*Travels*, v. 409), is one of the most curious subjects to which a traveller can direct his attention. A considerable part of the inhabitants of Egypt, of Arabia, and of Persia, subsist almost entirely upon its fruit. They boast also of its medicinal virtues.' Pliny (*Hist. Nat.* xxiii. 4) says, 'The ancients gave the juice of them boiled, instead of hydromel, to the sick to recruit strength and to allay thirst, for which purpose they preferred those from Thebais.' The cordial properties of *שָׂכַר* are probably referred to in Prov. xxxi. 6. Another passage in the same traveller illustrates the value of *shechar* in the accommodated sense of 'sweet fruit,' when presented as tithe or offering. 'The dates hung from these trees in such large and tempting clusters, although not quite ripe, that we climbed to the tops of some of them, and bore away with us large branches with their fruit. In this manner dates are sometimes sent with the branches as presents to Constantinople. It suits the Turks, who are fond of *sweetmeats* of all kinds' (*Travels*, v. 408). This reminds one of the statement of Josephus (*Antiq.* xiii. 13. 5), that at the feast of Tabernacles the Jews carried *boughs of the palm-tree* and the citron-tree in their hands, and on one occasion pelted King Alexander Jannæus with citrons. 'By the word *debash*,' says Calmet, 'the rabbins and lexicographers understand not only the honey of bees, but also *honey of dates*, or the *fruits of the palm-tree*, or the *dates* themselves, from which honey is extracted; and when God enjoins the *first fruits* of the honey to be offered to him, the *first fruits of dates seem to be meant*; for generally the produce only of *fruits* was offered.' The Jewish rabbins render *רְבִישׁ* in 2 Chron. xxxi. 5, by *DATES* (vid. Bagster's *Comprehensive Bible*). The Arabs also still apply *دبس* both to the dates and the honey of dates. On the same principle of accommodation as the sacred writers occasionally employ *debash* as a solid, and even *וין*, *wine*, in the sense of *תְּרִישׁ*, *vintage-fruit* (Deut. xxviii. 39; Ps. civ. 14-15; Jer. xl. 10-12), it is probable that *שָׂכַר shechar* might also include the sense of 'sweet-fruit,' as in Deut. xiv. 26, where it and *וין* are placed amongst tithe-offerings as solids to be eaten. The learned Dr. Willet (1631) on Lev. x. 9, observes that 'this prohibition may also be extended to the eating of such things as may intoxicate the brain, as *dates* and the *fruits of the palm-tree* of Egypt; and sc D. Kimchi' (*Hexapla in Leviticum*). Some sorts of dates, if gathered too early and badly dried, do, as Pliny observes (*Hist. Nat.* xxiii. 4), cause headache and quasi intoxication. It may be remarked that Pliny (xiii. 4) speaks of a species of fine-flavoured dates as being called *dabula*.

Further illustrations of the nature of '*shechar*,' as *palm honey* or *debash*. Abu Zeid al Hasan, a traveller of the ninth century, writing of the Isle of Ceylon, says, 'Their drink is made of *palm honey* boiled, and prepared with the *tari*

ar juice which runs from the tree' (*Accounts of India and China*, by two Mohammedan Travellers, p. 81). Sir John Maundeveile, who went to the east A.D. 1322, says (*Voyage and Travaille*, p. 141) that 'Sarrazines, that be devout, drynken never no wyn; but sūme drynken it prevyly. For gif they dronken it openly, thei scholde ben reprieved. But thei drynken gode Beverage and swete and norisslyngc, that is made of Galanelle [calamus meli]; and that is that men maken sugar of, that is of righte gode savour; and it is gode for the Brest.' He further narrates (p. 189) that 'there ben other Trees that beren Hony, gode and swete; and other Trees that beren Venym; agens the whiche there is no Medicyne but on; for Triacle will not avaylle, se non other medicyne.' Huighen van Linschoten (1584), in his *Discours of Voyages*, ch. 56, says of the palm-trees of the Canarijs, that 'they farme or hire those trees for two causes, one for the coqnos or fruit to eat it, the other to press wine out of them, thereof to drink. When they desire to have no cocus or fruite thereof, they cut the blossomes of the cocus away, and bind a round pottle with a narrow mouth, by them called callao, fast unto the tree, and stop the same close round about with pot-earth, so that neyther wine nor aire can eyther enter in, or come forth, and in that sort the pot in short space is full of water, which they call *sura*, and is very pleasant to drink, like sweet whay, and somewhat better.' This *sura* is a form of the Arabic and Pestic *syra* or *sheer*, signifying sweet liquor, milk, congealed juice, &c. The word (joined to some particle, as Pestic *ob*, 'water or drink,' from the Sanscrit अलि *abhi*, 'before,' fig. *first, better*;

whence the Latin *ob*; or perhaps to उग्र *ud*, *ur*, fig. *noble, superior*) is traceable in the Arabic شربة *sherbit*, whence Persian *shera* and Turkish *sharrap*, applied in both tongues to *wine*; and hence, too, *sherbet*, 'pleasant liquor,' Italian *sorbetto*, and English *shrub, sirop, and syrup*. Linschoten continues:—'Of the aforesaid *sura* they likewise make *sugar*, which is called *JAGRA*; they seethe the water, and set it in the sun, whereof it becometh *sugar*. All along the coast of Malabar there are many thick reeds, specially on the coast of Choromandel, which reeds by the Indians are called *Mambu*, and by the Portin gales *Bambu*; these *Mambus* have a certain matter within them, which (as it were) the pith of it. The Indians call it *SACAR Mambu*, which is as much to say, as *sugar of Mambu [Bamboo]*, and is a very *medicivable thing*, much esteemed and much sought for by the Arabians, Persians, and Moors, that call it *Tabaxiir*'—i. e. *Tab-a'-shir*, 'the *x* suffering' the same corruption as in *Xeres*, whence *sherries* (wine). Major Sir G. T. Temple, Bart. (*Excursions in the Mediterranean, Algiers, and Tunis*, 1835), says that the best species of dates are either preserved in cases or pressed in jars. 'At the bottom of the jar is a cock, from which is drawn the juice in the form of a *thick luscious syrup*' (ii. 155). Thus the two primitive senses of *shechar* would be included in the command 'to offer the first of thy ripe fruits and of thy liquors'—literally *tears* or droppings (Exod. xxii. 29).

2. טַרְטַר, *Date* or *PALM WINE* in its fresh and unfermented state. Bishop Lowth translates Isa xxiv. 9 thus:—

'With songs they shall no more drink wine [i. e. of grapes, טַרְטַר];

The *palm wine* shall be *bitter* to them that drink it'—

and observes, note *in loc.*, that 'this is the proper meaning of the word טַרְטַר, *σικερα*. All enjoyment shall cease; the *sweetest wine* shall become *bitter* to their taste.'

Herodotus, in his account of Assyria, remarks that 'the palm is very common in this country,' and that 'it produces them bread, *wine*, and honey' (i. 193).

The Mohammedan traveller (A.D. 850) says that 'palm wine, if drunk fresh, is sweet like honey; but if kept, it turns to vinegar' (p. 9).

Maundeveile, who travelled above 500 years ago, says, 'Other trees there ben also, that beren *wyn* of noble sentement.' He then describes the *jaggree* or sugar palm, and adds, 'the *hony* and the *wyn* and the venym ben drawn out of other trees, in the same manere, and put in vessels for to kepe' (p. 189).

Mandelslo (1640), speaking of the village of Dame near Surat, records thus:—'*Terry or Palm Wine*. In this village we found some *terry*, which is a liquor drawn out of the palm-trees, and drank of it in cups made of the leaves of the same tree. To get out the juice, they go up to the top of the tree, where they make an incision in the bark, and fasten under it an earthen pot, which they leave there all night, in which time it is fill'd with a certain *sweet liquor* very pleasant to the taste. They get out some also in the day-time, but that [owing to the great heat] *corrupts immediately*, and is good only for vinegar, which is all the use they make of it' (*Ambassador's Travels*, p. 23).

Adam Fabroni, an Italian writer of celebrity, informs us that 'the palm-trees, which particularly abounded in the vicinity of Jericho and Engaddi, also served to make a *very sweet wine*, which is made all over the East, being called palm wine' by the Latins, and *syra* in India, from the Persian *shir*, which means luscious liquor or drink' (*On the Husbandry of the Ancient Jews*).

Captain Cook says of the palm, 'A kind of wine called *toddy* is procured from this tree; the juice, which is collected morning and evening, is the common drink of every individual.' He informs us also that the natives make a *syrup* from this wine, called *gula*, 'by boiling the liquor down till it is sufficiently inspissated.' This is evidently done as a means of preserving the wine *sweet* and preventing its corruption. Dr. Shaw thus describes the unfermented palm wine:—'This liquor, which has a more luscious sweetness than honey, is of the consistence of a thin syrup, but *quickly grows tart and ropy*, acquiring an intoxicating quality' (*Travels*, i. 262). Sir G. T. Temple says, 'We were daily supplied with the sap of the date-tree, which is a delicious and wholesome beverage when drunk quite fresh; but if allowed to remain for some hours, it acquires a sharp taste not unlike cider. It is called *leghma*, and, poetically, the tears of the date'—*leghma* being a corruption of *lachryma*. The Landers inform us that '*Palm*'

wine is the common and favourite drink of the natives' of Africa—that 'the juice is called wine,' and that 'it is either used in this state, or preserved till it acquires rather a BITTER flavour' (*Expedition to the Niger*, iii. 307-8). With these facts before us, the language employed by the prophet in the sublime chapter from which we quoted above, becomes beautifully apposite. His prediction is that 'the land shall be utterly spoiled,' that the light of joy shall be turned into the gloom of sorrow, even as the *sweet drink* which corrupts, grows *sour* and *bitter* to those who drink it. The passage clearly indicates the nature of the drink to have been *sweet* in what the Jews esteemed its most valuable condition, but *bitter* in its fermented state. Hence the drunkard is represented in ch. v. 20-22, as one who 'puts bitter for sweet, and sweet for bitter.' This palm wine, like the honey of dates and sugar, was much valued as a medicine and cordial. Dr. James (1747), in his *Pharmacopœia*, states that 'the liquor or wine of *suri* is said to be highly beneficial to phthical patients, &c.' (Art. 'Palma Indica').

3. SAKAR, in its third sense as a noun, denotes, both in the Hebrew and the Arabic, fermented or INTOXICATING PALM WINE. Various forms of the noun in process of time became applied to other kinds of intoxicating drink, whether made from fruit or from grain. After the destruction of Jerusalem and of the Jewish polity, almost complete confusion prevailed as to its proper signification. With the ancient Jews it was distinguished from wine; but since the Christian era it has been frequently considered both by Jewish and Christian writers as comprehending all intoxicating drink. Thus in Spanish *saçar* signifies to draw wine; and *zicara*, a cup or draught. While, however, some authors, imperfectly acquainted with its history and nature, were unduly enlarging its signification, others, from equal ignorance, were narrowing it. Thus Wycliffe, in the fourteenth century, in translating Luke i. 15, has, 'He schal not drinke wyn ne sydyr.' Phillips, in his *World of Words*, however, shows that formerly *cider* was applied to the fresh expressed juice of apples as well as to the fermented. Todd's *Johnson* gives the following derivatives:—'Cider; *sidre*, Italian; *sicera*, Latin; *σίκερα*, Greek. The word is supposed to be originally of Egypt, and denoting an inebriating liquor. This sense is now obsolete. In old French *cisere* is used for ale.' *Cervoise*, a drink made from herbs and grain, is the word employed by the pastors of Geneva in their translation of the Bible. The fermented rice wine of the Chinese is called *cha*, that of the Japanese *sacki*; the palm wine of the Celebes is named *sachoir*; and the beer of the Kalmucks *sehara*. Arrack has been commonly, but erroneously, derived from *sakar*, and some, including Dr. Paxton (*Illustrations of Scripture; Nat. Hist.* p. 51), have confounded the *arrack* with the palm wine, forgetting that the original wine existed long prior to the discovery of arrack distillation. The true palm wine also, the כַּמְרִי of the Bible, is exclusively the juice of the palm-tree or fruit, whereas *arrack* is applied to the spirit obtained from fermented rice and other things, and is, as Dr. Shaw remarks, 'the general name for all hot liquors extracted by the alembick' (*Travels*, i.

262). Such liquors furnish more powerful means of intoxication than the ancients possessed, and derive their name, we apprehend, from a poisonous species of the palm-tribe, the *areca*, or 'drunken date-tree,' the nuts of which are mixed with betel-leaf, datura, and other drugs, and made into a confection or preserve, which the Indians chew, or put into their drink to make it intoxicating (*Pomet On Drugs*).

The Arabic confirms our illustrations of the Hebrew, not only in possessing analogous nouns, but also verbs. Hence we have سَكِرَ, *intoxicated*, corresponding to the Hebrew *shachar*.

The palm wine of the East, as we have explained, is made intoxicating either by allowing it to corrupt and ferment, thereby losing the sweet luscious character for which the Orientals esteem it, and becoming rosy, tart, and bitter; or, in its fresh or boiled state, by an admixture of stimulating or stupefying ingredients, of which there is an abundance (vid. Olearius, Mandelslo, Linschoten, and others). Such a practice seems to have existed amongst the ancient Jews, and to have called down severe reprobation (comp. Prov. xxiii. 30; Isa. i. 22; v. 11, 22, and vid. Lowth *in loc.*).—F. R. L.

DROMEDARY. [CAMEL.]

DRUSILLA (Δροσίλλα), youngest daughter of Herod Agrippa I. She was much celebrated for her beauty, and was betrothed to Epiphanes, prince of Commagene; but was afterwards married to Azizas, king of Emesa, whom the procurator Felix induced her to abandon, in order to live with him. She is mentioned in Acts xxiv. 24 (comp. Joseph. *Antiq.* xix. 9. 1; xx. 7. 1, 2).

DUDAIM (דודים). This word, in its plural form, only occurs in two places of Scripture: first in Genesis xxx. 14-16; and secondly, in Canticles vii. 13. In the first passage it is mentioned several times: 'Reuben went out in the days of wheat harvest, and found *dudaim* (mandrakes) in the field, and brought them home to his mother Leah. Then Rachel said to Leah, give me of thy son's *dudaim*;' also in ver. 15, and in ver. 16, it is said, 'And Jacob came out of the field in the evening, and Leah went out to meet him, and said, Thou must come in unto me, for surely I have hired thee with my son's *dudaim*; and he lay with her that night.' In the second passage we learn that these *dudaim*, or the plants which yielded them, gave out a peculiar odour: 'The *dudaim* (mandrakes) give a smell, and at our gates are all manner of pleasant plants.' From the above passages it is evident that the *dudaim* were collected in the fields, that they were fit for gathering in the wheat harvest in Mesopotamia, where the first occurrence took place; that they were found in Palestine; that they or the plants which yielded them diffused an odour, which Michaelis paraphrases, 'Jam et somnifero odore, veneris mandragoras;' and that they were supposed to be possessed of aphrodisiac powers, or of assisting in producing conception.

From this it is manifest that there is little to guide us in determining what plant is alluded to at such early periods, especially as no similar name has been recognised in any of the cognate languages. Hence great diversity of opinion

have been entertained respecting the plant and produce intended by the name *dudaim*. These Dr. Harris has thus summed up: 'Interpreters have wasted much time and pains in endeavouring to ascertain what is intended by the Hebrew word *dudaim*. Some translate it by "violet," others

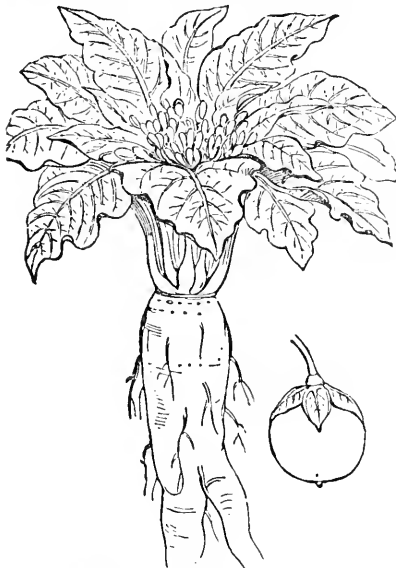

267. [*Atropa Mandragora*.]

"lilies," "jasmims," "truffles or mushrooms;" and some think that the word means "flowers," or "fine flowers." Bochart, Calmet, and Sir Thomas Browne suppose the *citron* intended; Celsius is persuaded that it is the fruit of the *loté-tree*; Hiller that *cherries* are spoken of; and Ludolf maintains that it is the fruit which the Syrians call "mauz" (that is the plantain), resembling in figure and taste the Indian fig; but the generality of interpreters and commentators understand *mandrakes*, a species of melon, by *dudaim*. Here, however, the author has confounded the melon '*cucumis dudaim*' with the mandrake or mandragora, adopted by the generality of authors. The grounds upon which the mandragora has been preferred are, first, 'The most ancient Greek translator interprets the Hebrew name in Gen. xxx. 14, by mandrake apples (*μηλα mandragorōn*); and in the Song of Solomon, by mandrakes, *οι mandragōrai*. Saad'as Onkelos and the Syriac version agree with the Greek translators.

The first of these puts *لَفَاحٌ laffach*; the two latter *יַבְרוּחִין yabruchin*; which names denote the same plant' (Rosenmüller, *Bib. Bot.* p. 130, and note). The earliest notice of *mandragōras* is by Hippocrates, and the next by Theophrastus (*Hist. Plant.* vi. 2). Both of these C. Sprengel (*Hist. Rei Herb.* i. 38, 82) supposes, intend *atropa mandragora*. Dioscorides notices three kinds: 1. the female, which is supposed to be the *mandragora autumnalis* of Berloton; 2. the male, *mandragora vernalis* of the same botanist (these two are, however, usually accounted varieties

of *atropa mandragora*); 3. a kind called *morion*. It has been inferred that this may be the same as the mandragora of Theophrastus, which, by some authors, has been supposed to be *atropa belladonna*. To all of these Dioscorides ascribes narcotic properties and says of the first, that it is also called *Circea*, because it appears to be a root which promotes venery. Pythagoras named the mandragora *anthropomorphon*, and Theophrastus, among other qualities, mentions its soporific powers, and also its tendency to excite to love. Its fruits were called apples of love, and Venus herself Mandragorites. But it is not easy to decide whether the above all refer to the same plant or plants.

Persian authors on *materia medica* give *mandragoras* as a synonyme for *یَبْرُوحٌ yebrookh*, or *yabrooz*, which is said to be the root of a plant of which the fruit is called *لَفَاحٌ loafah*. This, there is little doubt, must be the above *atropa mandragora*, as the Arabs usually refer only to the plants of Dioscorides, and, on this occasion, they quote him as well as Galen, and ascribe narcotic properties to both the root and the fruit. D'Herbelot, under the article 'Abrousanam,' details some of the superstitious opinions respecting this plant, which originated in the East, but which continued for a long time to be retained by authors in Europe.

By the Arabs it is said to be called *tufah-alsheitan*, or devil's apple. If we look to the works of more modern authors, we find a continuance of the same statements. Thus Marti, in his *Travels*, (vol. ii. p. 195), says that the Arabs called the mandrake plant (*yabrochak*), which is, no doubt, the same name as given above. 'At the village of St. John in the mountains, about 6 miles southwest from Jerusalem, this plant is found at present, as well as in Tuscany. It grows low, like lettuce, to which its leaves have a strong resemblance, except that they have a dark green colour. The flowers are purple, and the root is for the most part forked. The fruit, when ripe, in the beginning of May, is of the size and colour of a small apple, exceedingly ruddy, and of a most agreeable odour; our guide thought us fools for suspecting it to be unwholesome. He ate it freely himself, and it is generally valued by the inhabitants as exhilarating their spirits and a provocative to venery.' Maundell was informed by the chief priest of the Samaritans that it was still noted for its genial virtue. Hasselquist also seems inclined to consider it the *dudaim*, for, when at Nazareth, he says, 'what I found most remarkable in their villages was the great quantity of mandrakes that grew in a vale below it. The fruit was now (May 16) ripe. From the season in which this mandrake blossoms and ripens its fruit, one might form a conjecture that it is Rachel's *dudaim*. These were brought her in the wheat harvest, which in Galilee is in the month of May, about this time, and the mandrake was now in fruit.'

Considering therefore that the earliest translators have given *mandragora* and *Yabrookh* as the synonymous names for *dudaim*, and that the root and fruits of *atropa mandragora* have, from early times, been supposed to be possessed of the same properties which are ascribed to the *dudaim*,

there does not appear to us any other plant, which has been yet adduced, better entitled than it to stand for the dudaim. But there does not exist sufficient collateral proof to confirm the selection by the Greek translator of the mandragora as the *âda'm*, in preference to some other plants, which might be adduced, and to which similar properties have from ancient times been ascribed.—J. F. R.

DUKE. This word is from the Latin *dux*, 'a captain or leader,' from *duco*, 'to lead.' It thus corresponds with tolerable exactness to the Hebrew דָּוָד *alluph*, from דָּוָד *alaph*, to 'lead,' 'guide.' This word, *alluph*, is usually rendered by 'prince' or 'chief;' but by 'duke' in Gen. xxxvi. 15-30, where we find 'dukes of Edom.' The translator was doubtless seduced by the identity of signification into the somewhat improper, although not incorrect, use of a modern title.

DULCIMER. [Music.]

DUMAH (דְּמָה), a tribe and country of the Ishmaelites in Arabia (Gen. xxv. 14; Isa. xxi. 11). It is doubtless the same that is still called by the Arabs *Duma the Stony*, and the *Syrian Duma*, situated on the confines of the Arabian and Syrian deserts, with a fortress (Niebuhr, *Beschreibung*, p. 314).

DUMAH was also the name of a town in the tribe of Judah (Josh. xv. 52), which Eusebius and Jerome place seventeen R. miles from Eleutheropolis, in Daroma.

DUNG. Among the Israelites, as with the modern Orientals, dung was used both for manure and for fuel. In a district where wood is scarce, dung is so valuable for the latter purpose, that little of it is spared for the former.

The use of dung for manure is indicated in Isa. xxv. 10, from which we also learn that its bulk was increased by the addition of straw, which was of course, as with us, left to rot in the dunghill. Some of the regulations connected with this use of dung we learn from the Talmud. The heaping up of a dunghill in a public place exposed the owner to the repair of any damage it might occasion, and any one was at liberty to take it away (*Bava-kama*, i. 3. 3). Another regulation forbade the accumulation of the dunghill to be removed, in the seventh or sabbatic year, to the vicinity of any ground under culture (*Sabb.* iii. 1), which was equivalent to an interdiction of the use of manure in that year; and this must have occasioned some increase of labour in the year ensuing.

The use of dung for fuel is collected incidentally from the passage in which the prophet Ezekiel, being commanded, as a symbolical action, to bake his bread with human dung, excuses himself from the use of an unclean thing, and is permitted to employ cows' dung instead (*Ezek.* iv. 12-15). This shows that the dung of animals, at least of clean animals, was usual, and that no ideas of ceremonial uncleanness were attached to its employment for this purpose. The use of cow-dung for fuel is known to our own villagers, who, at least in the west of England, prefer it in baking their bread 'under the crock,' on account of the long-continued and equable heat which it maintains. It is there also not unusual in a summer evening to see aged people traversing the green lanes with

baskets to collect the cakes of cow-dung which have dried upon the road. This helps out the ordinary fire of wood, and makes it burn longer. In many thinly-wooded parts of south-western Asia the dung of cows, camels, horses, asses, whichever may happen to be the most common, is collected with great zeal and diligence from the streets and highways, chiefly by young girls. They also hover on the skirts of the encampments of travellers, and there are often amusing scrambles among them for the droppings of the cattle. The dung is mixed up with chopped straw, and made into cakes, which are stuck up by their own adhesiveness against the walls of the cottages, or are laid upon the declivity of a hill, until sufficiently dried. It is not unusual to see a whole village with its walls thus garnished, which has a singular and not very agreeable appearance to a European traveller. Towards the end of autumn, the result of the summer collection of fuel for winter is shown in large conical heaps or stacks of dried dung upon the top of every cottage. The usages of the Jews in this matter were probably similar in kind, although the extent to which they prevailed cannot now be estimated.

DURA (דְּרָא), the plain in which Nebuchadnezzar set up his golden image (Dan. iii. 1). Traces of the name have been idly sought in quarters too distant from Babylon to have been historically possible, as it is clear from the context that 'the plain of Dura' could be no other than that plain (or some part of it) in which Babylon itself was situated.

DUST. For storms of dust, &c., see STORM for throwing dust on the head, see MOURNING.

E.

EAGLE (נֶשֶׁר *nisr*; Arab. *nesr*; Chald. *nescher*; Coptic. *akhom*; Exod. xix. 4; Lev. xi. 13, &c.). The Eagle, in zoology, forms a family of several genera of birds of prey, mostly distinguished for their size, courage, powers of flight, and arms for attack. The bill is strong and bent into a plain pointed hook, without the notch in the inner curve which characterizes falcons; the nostrils are covered with a naked cere or skin, of a yellow or a blue colour; the eyes are lateral, sunken, or placed beneath an overhanging brow; the head and neck covered with abundance of longish, narrow-pointed feathers; the chest broad, and the legs and thighs exceedingly stout and sinewy. Eagles, properly so called, constitute the genus *Aquila*, and have the tarsi feathered down to the toes; they are clothed in general with brownish and rust-coloured feathers, and the tail is black, grey, or leop brown. Sea-eagles (genus *Haliaetus*) have the tarsi or legs half bare and covered with horny scales; not unusually the head, back, and tail more or less white. The larger species of both measure, from head to tip of tail, 3 feet 6 inches or more, and spread their wings above 7 feet 6 inches; but these are proportionably broad to their length: for it is the third quill feather which is the longest; as if the Creator intended to restrain within bounds their rapidity of flight, while by their breadth the power of continuing on the wing

is little or not at all impeded. The claws of the fore and hind toe are particularly strong and sharp; in the sea-eagles they form more than half a circle, and in length measure from $2\frac{1}{2}$ to $1\frac{3}{4}$ of an inch. Under the name of *nisr* the Scriptures include species of both the above, and in some cases, also, the larger vultures, or the genus *vultur proper* [VULTURE]. These majestic birds have their abode in Europe, on the shores of the Mediterranean, in Syria and Arabia, wherever there are vast woody mountains and lofty cliffs: they occupy each a single district, always by pairs, excepting on the coasts, where the sea-eagle and the osprey (*Pandion haliaetus*) may be found not remote from the region possessed by the rough-legged eagles—the first because it seeks to subsist on the industry of the second, and does not interfere with the prey of the third. It is in this last genus, most generally represented by the golden eagle (*aquila chrysaeta*) that the most powerful and largest birds are found. That species in its more juvenile plumage, known as the ring-tailed eagle, the Imperial eagle, or mogilnick (*aq. heliaca*), and the booted eagle (*aq. pin-nata*) is found in Syria; and at least one species of the sea-eagles (the *hal. ossifragus*, *albicilla*, or *halicoradus*) frequents the coasts, and is even of

eagle's eyrie, fixed in the most elevated cliffs. The swiftness of this bird, stooping among a flock of wild geese, with the rushing sound of a whirlwind, we have witnessed; and all know its towering flight, suspended on its broad wings among the clouds with little motion or effort. Thus the predictions, in which terrible nations coming from afar are assimilated to eagles, have a poetical and absolute truth, since there are species like the golden, which really inhabit the whole circumference of the earth, and the nations alluded to bore eagles' wings for standards, and for ornaments on their shields, helmets, and should-ers. In the northern half of Asia, and among all the Turkish races, this practice is not entirely abandoned at this day, and eagle ensigns were constantly the companions of the dragons. China, India, Bactria, Persia, Egypt, the successors of Alexander, the Etruscans, the Romans, the Celts, and the Arabs had eagle signs of carved work, of metal, or the skins of birds stuffed, and set up as if they were living. These, named אֵיט *ait*, אֵרֶס *ærës*, aquila, eryx, simurg, humma or humanion, karakoosh (the birds of victory of different nations and periods of antiquity), were always symbolical of rapid irresistible conquest. A black eagle was the ensign of Kalid, general of Mohammed, at the battle of Almadin, and the carved eagle still seen on the walls of the citadel of Cairo, set up by Karakoosh, the vizir of Salah-ed-deen, to commemorate his own name and administration, indicates a species not here enumerated. *Aq. heliaca*, here figured, is the species most common in Syria, and is distinguished from the others by a spot of white feathers on each shoulder.—C. H. S.



268. [Aquila heliaca.]

stronger wing than the others. These build usually in the cliffs of Phœnicia, while the others are more commonly domiciliated within the mountains. According to their strength and habits the former subsist on antelopes, hares, hyrax, bustard, stoik, tortoises, and serpents; and the latter usually on fish; both pursue the catta (*pteroeles*), partridge, and lizard. The osprey alone being migratory retires to Southern Arabia in winter. None, excepting the last-mentioned, are so exclusively averse to carrion as is commonly asserted: from choice or necessity they all, but in particular the sea-eagles, occasionally feed upon carcasses of horses, &c.; and it is well known in the East that they follow armies for that purpose. Hence the allusions in Job and Matt. xxiv. 28, though vultures may be included, are perfectly correct. So again are those which refer to the

EARING. This word, which occurs in the Authorized Version (Gen. xlv. 6), is very often supposed to mean 'collecting the ears of corn,' which would confound it with harvest, from which it is distinguished in this very passage. But the word is radically the same with *harrow*, and denotes *ploughing*; from the Anglo-Saxon *erian* 'to plough.' It is also traced in *arar* Spanish, *aeron* Dutch, *aeria* Swedish, *er* Icelandic, *oru* Slavonic, *orze* Polish, *araidh* Gaelic, *aredig* Welsh, *aro* Latin, *arôw* Greek, *charath* Arabic, and *charash* (חַרְשׁ) Hebrew, which is the original word in this place (*Critica Biblica*, iii. 210).

EARNEST. ἄρραβών is evidently the Hebrew אֶרְבָּוֹן in Greek characters. With a slight alteration in the letters, but with none whatever in the sense, it becomes the Latin *arrhabo*, contr. *arraha*; French *arves*; English *carles* and *earnest*. These three words occur in the Hebrew, Septuagint, and Vulgate, in Gen. xxxviii. 17, 18, and in ver. 20, with the exception that the Vulgate there changes it to *pignus*. The use of these words in this passage clearly illustrates their general import; which is, that of an earnest or pledge, given and received, to assure the fulfilment of an engagement. Hesychius explains ἄρραβών by πρόδομα, somewhat given beforehand. This idea attaches to all the particular applications of the word, as, anything given by way of warrant or security for the performance of a promise; part of a debt paid as an assurance of paying the remainder; part of the price of anything paid beforehand to confirm the bargain between buyer and seller; part of a servant's wages paid

at the time of hiring, for the purpose of ratifying the engagement on both sides. The idea that the earnest is either to be returned upon the fulfilment of the engagement, or to be considered as part of the stipulation, is also included. The word is used three times in the New Testament, but always in a figurative sense: in the first (2 Cor. i. 22), it is applied to the *gifts* of the Holy Spirit, which God bestowed upon the *apostles*, and by which he might be said to have hired them to be the servants of his son; and which were the earnest, assurance, and commencement of those far superior blessings which He would bestow on them in the life to come, as the wages of their *faithful* services:—in the two latter (2 Cor. v. 5; Eph. i. 13, 14), it is applied to the gifts bestowed on *Christians generally* upon whom, after baptism, the Apostles had laid their hands, and which were to them an *earnest* of obtaining an heavenly habitation and inheritance, upon the supposition of their fidelity. This use of the term finely illustrates the augmented powers and additional capacities promised in a future state. Jerome, in his comment on the second passage, exclaims, *Si arrhabo tantus, quanta erit possessio*: 'If the earnest was so great, how great must be the possession.' See Kypke, Macknight, and Middleton on these passages. Le Moyne, *Not. ad Var. Sacr.* pp. 460-80.—J. F. D.

EAR-RINGS. No custom is more ancient or universal than that of wearing ear-rings, from which it would appear to be a very natural idea to attach such an ornament to the pendulous lobe of the ear. There are two words in Hebrew denoting ear-rings, viz. אָגִיל *agil*, which is applied to any kind of ring, particularly to ear-rings (Num. xxxi. 50; Ezek. xvi. 12). The name implies *roundness*, and it is a fact that nearly all the ancient ear-rings exhibited in the sculptures of Egypt and Persopolis are of a circular shape. The other word is נֶזֶם *nezem*, and, as this word is also applied to a nose-jewel, we may suppose that it was a kind of ear-ring, different from the round 'agil,' and more similar to the nose-jewel. It most certainly denotes an ear-ring in Gen. xxxv. 4: but in Gen. xxiv. 47; Prov. xi. 22; Isa. iii. 21; it signifies a nose-jewel; and it is doubtful which of the two is intended in Judg. viii. 21, 25; Job xlii. 11. Ear-rings of certain kinds were anciently, and are still, in the East, instruments or appendages of idolatry and superstition, being regarded as talismans and amulets. Such probably were the ear-rings of Jacob's family, which he buried with the strange gods at Beth-el (Gen. xxxv. 4).

No conclusion can be formed as to the shape of the Hebrew ear-rings except from the signification of the words employed, and from the analogy of similar ornaments in ancient sculpture. Those worn by the Egyptian ladies were large, round, single hoops of gold, from one inch and a half to two inches and one-third in diameter, and frequently of still greater size, or made of six single rings soldered together. Such probably was the round 'agil' of the Hebrews. Among persons of high or royal rank the ornament was sometimes in the shape of an asp, whose body was of gold set with precious stones [AMULETS]. Silver ear-rings have also been found at Thebes, either plain hoops like the ear-rings of gold, or simple studs. The modern Oriental ear-rings are more usually

jewelled drops or pendants than circlets of gold. But the writer has seen a small round plate of silver or gold suspended from a small ring inserted into the ear. This circular plate (about the size of a halfpenny) is either marked with fanciful figures or set with small stones. It is the same kind of thing which, in that country (Mesopotamia), is worn as a nose-jewel, and in it we perhaps find the Hebrew ear-ring which is denoted by the same word that describes a nose-jewel.

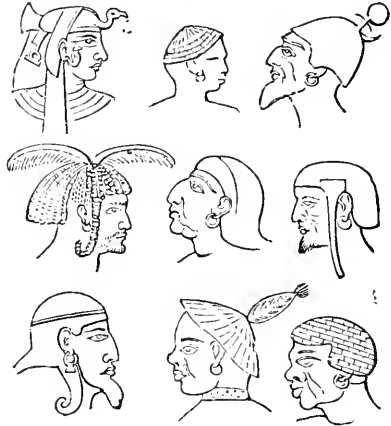

269.

The use of ear-rings appears to have been confined to the women among the Hebrews. That they were not worn by men is implied in Judg. xiv. 24, where gold ear-rings are mentioned as distinctive of the Ishmaelite tribes. The men of Egypt also abstained from the use of ear-rings; but how extensively they were worn by men in other nations is shown by the annexed group of heads of different foreigners, collected from the Egyptian monuments. By this also the usual forms of the most ancient ornaments of this description are sufficiently displayed.

EARTH. There are two words in Hebrew which are translated sometimes by *earth*, and sometimes by *land*. These are אֶרֶץ *eretz*, and אַדְמָה *adamah*, both of which are rendered by אֶרֶץ in the Septuagint, and this אֶרֶץ is rendered by 'earth,' 'land,' 'ground,' in the New Testament. The word *adamah*, however, is applied chiefly to the very *substance* of the earth, as soil, ground, clay, although sometimes denoting a region, land, or country; whereas *eretz* more generally denotes the *surface* of the earth, and is hence, in the earlier parts of the Bible, opposed to שָׁמַיִם *shamayim*, 'the heavens.'

Besides the ordinary senses of the word or words rendered 'earth' in our translation—namely, as denoting mould, the surface of the earth, and the terrestrial globe—there are others in Scripture which require to be discriminated. 1. 'The earth' denotes 'the inhabitants of the earth' (Gen. vi. 11; xi. 1). 2. *Heathen countries*, as distinguished from the land of Israel, especially during the theocracy; i. e. all the rest of the world excepting Israel (2 Kings xviii. 25; 2 Chron. xiii. 9, &c.). 3. In the New Testament especially, 'the earth' appears in our translation as applied to the *land*

of *Judaea*. As in many of these passages it might seem as if the habitable globe were intended, the use of so ambiguous a term as 'the earth' should have been avoided, and the original rendered by 'the land,' as in Lev. xxv. 23; Isa. x. 23, and elsewhere. This is the sense which the original bears in Matt. xxiii. 35; xxvii. 45; Mark xv. 33; Luke iv. 25; xxi. 23; Rom. ix. 28; James v. 17. For the cosmological uses of the term, see GEOGRAPHY.

EARTHENWARE. [POTTERY.]

EARTHQUAKE (עָרָד). The proximate cause of earthquakes, though by no means accurately defined, seems referable to the action of internal heat or fire. That the earth was once subject to the action of a vast internal power springing probably from the development of subterranean or central heat, the elevations and depressions, and the generally scarred and torn character of its exterior make sufficiently evident. A power similar in kind, but more restricted in degree, is still at work in the bowels of the earth, and occasionally breaks down all barriers and devastates certain parts of the world.

There is good reason for holding that earthquakes are closely connected with volcanic agency. Both probably spring from the same cause; and may be regarded as one mighty influence operating to somewhat dissimilar results. Volcanic agency, therefore, is an indication of earthquakes, and traces of the first may be taken as indications of the existence (either present or past, actual or possible) of the latter.

The manifestation of these awful phenomena is restricted in its range. Accordingly geologists have laid down certain volcanic regions or bands within which this manifestation takes place. Over these regions various traces of volcanic agency are found, such as either gaseous vapours or hot springs, or bituminous substances, and in some instances (occasionally) active volcanoes. Several sources of bitumen are found on the Tigris, in the Persian mountains, near the Kharoon, and at Bushire, as well as along the Euphrates. At Hit, especially, on the last-mentioned river, it exists on a very large scale, and, having been much used from the earliest times, seems inexhaustible. Abundant traces of it are also to be seen amid the ruins and over the entire vicinity of Hillah—the ancient Babylon. Syria and Palestine abound in volcanic appearances. Between the river Jordan and Damascus lies a volcanic tract. The entire country about the Dead Sea presents indubitable tokens of volcanic agency.

Accordingly these places come within one of the volcanic regions. The chief of these are—1. that which extends from the Caspian Sea to the Azores; 2. from the Aleutian Isles to the Moluccas; 3. that of the Andes; 4. the African; 5. the Icelandic. Syria and Palestine are embraced within the first band; and these countries have not infrequently been subject to earthquakes. The first visitation of the kind, recorded to have happened to Palestine, was in the reign of Ahab (b.c. 918-897), when Elijah (1 Kings xix. 11, 12) was directed to go forth and stand upon the mountain before Jehovah: 'and behold Jehovah passed by, and a great and strong wind rent the mountains, and brake in pieces the rocks before Jehovah; but Jehovah was not in the wind: and

after the wind an earthquake; but Jehovah was not in the earthquake: and after the earthquake a fire; but Jehovah was not in the fire: and after the fire a still small voice.' A terrible earthquake took place 'in the days of Uzziah, king of Judah' (b.c. 811-759), which Josephus (*Antiq.* ix. 10. 4) says, 'shook the ground, and a rent was made in the Temple, so that the rays of the sun shone through it, which, falling upon the king's face, struck him with the leprosy,' a punishment which the historian ascribes to the wrath of God consequent on Uzziah's usurpation of the priest's office. That this earthquake was of an awful character, may be learnt from the fact that Zechariah (xiv. 5) thus speaks respecting it—'Ye shall flee as ye fled from before the earthquake in the days of Uzziah, king of Judah:' and also that it appears from Amos (i. 1) that the event was so striking, and left such deep impressions on men's minds, that it became a sort of epoch from which to date and reckon; the prophet's words are, 'two years before the earthquake.'

That earthquakes were among the extraordinary phenomena of Palestine in ancient times is shown in their being an element in the poetical imagery of the Hebrews, and a source of religious admonition and devout emotion. In Psalm xviii. 7, we read, 'Then the earth shook and trembled; the foundations also of the hills moved and were shaken, because he was wroth' (comp. Hab. iii. 6; Nah. i. 5; Isa. v. 25). It was not an unnatural transition that any signal display of the will, sovereignty, or goodness of Providence, should be foretold in connection with, and accompanied as by other signs in the heavens above or on the earth below, so by earthquakes and their fearful concomitants (see Joel ii. 28; Matt. xxiv. 7, 29). The only earthquake mentioned in the New Testament is that which happened at the crucifixion of the Saviour of mankind (Matt. xxvii. 50-1; Luke xxiii. 44-5; Mark xv. 33). This darkness has been misunderstood, and then turned to the prejudice of Christianity [DARKNESS]. The obscuration was obviously an attendant on the earthquake. Earthquakes are not seldom attended by accompaniments which obscure the light of day during (as in this case from the sixth to the ninth hour, that is, from 12 o'clock at noon to 3 o'clock p.m.) several hours. If this is the fact, then the record is consistent with natural phenomena, and the darkness which sceptics have pleaded against speaks actually in favour of the credibility of the Gospel. Now it is well known to naturalists that such obscurations are by no means uncommon. It may be enough to give the following instances. A very remarkable volcanic eruption took place on the 19th of January, 1835, in the volcano of Coseguina, situated in the Bay of Fonseca (usually called the Coast of Conchagua), in Central America. The eruption was preceded by a rumbling noise, accompanied by a column of smoke which issued from the mountain, increasing until it assumed the form and appearance of a large dense cloud, which, when viewed at the distance of thirty miles, appeared like an immense plume of feathers, rising with considerable velocity, and expanding in every direction. In the course of the two following days several shocks of earthquakes were felt; the morning of the 22nd rose fine and clear, but a dense cloud of a pyramidal form was observed in the direction

of the volcano. This gradually ascended, and by 11 o'clock A.M. it had spread over the whole firmament, entirely obscuring the light of day, the darkness equalling in intensity that of the most clouded night: this darkness continued with little intermission for three days; during the whole time a fine black powder continued to fall. This darkness extended over half of Central America. The convulsion was such as to change the outline of the coast, turn the course of a river, and form two new islands. Precisely analogous phenomena were exhibited on occasions of earthquakes that took place at Cartago, in Central America, when there prevailed a dense black fog, which lasted for three days (*Recreations in Physical Geography*, p. 382).

In the case of the volcanic eruption which overwhelmed Herculaneum and Pompeii (A.D. 79), we learn from the younger Pliny that a dense column of vapour was first seen rising vertically from Vesuvius, and then spreading itself out laterally, so that its upper portion resembled the head, and its lower the trunk of a pine. This black cloud was pierced occasionally by flashes of fire as vivid as lightning, succeeded by darkness more profound than night, and ashes fell even at Misenum. These appearances agree perfectly with those witnessed in more recent eruptions, especially those of Monte Nuovo in 1538, and Vesuvius in 1822. Indeed earthquakes appear to exert a very marked influence on our atmosphere: among other effects Lyell (*Principles of Geology*, i. 400) enumerates sudden gusts of wind, interrupted by dead calms, evolution of electric matter, or of inflammable gas, from the soil, with sulphureous and mephitic vapours; a reddening of the sun's disk and a haziness in the air often continued for months (Joel ii. 30, 31).

Earthquakes, together with thunder, lightning, and other fearful phenomena of nature, form no small portion of the stock of materials which the interpreters of the German rationalistic school employ with no less liberality than confidence, in order to explain after their manner events recorded in the Scriptures, which have been commonly referred to the immediate agency of God. Hezel, Paulus, and other miracle-exploders would, but for this resource, find their 'occupation gone.' But, if there is reason for the statement that truth is sometimes stranger than fiction, it may with equal propriety be observed that their 'natural' causes are most unnatural, unlikely, and insufficient.

An earthquake devastated Judæa some years (31) before the birth of our Lord, at the time of the battle of Actium, which Josephus (*Antiq.* xv. 52) reports was such 'as had not happened at any other time, which brought great destruction upon the cattle in that country. About ten thousand men also perished by the fall of houses.' Jerome writes of an earthquake which, in the time of his childhood (about A.D. 315), destroyed Rabbath Moab (Jerome on *Isaiah*, xv.). The writers of the middle ages also speak of earthquakes in Palestine, stating that they were not only formidable, but frequent. In 1834 an earthquake shook Jerusalem, and injured the chapel of the nativity at Bethlehem. As late as the year 1836 (Jan. 1) Jerusalem and its vicinity were visited by severe shocks of earthquake, yet the city remains without serious injury from these subterranean causes.—

J. R. B.

EAST. This word, which is used by English writers in only two senses, viz. to denote either the quarter of the heavens where the sun rises, or the regions in the eastern part of the world, has frequently *three* senses in the Authorized Version of the Bible. Thus, it is sometimes used to represent the Hebrew מִזְרֵחַ, which properly means the *sun rising* (Ps. ciii. 12), 'as far as the east is from the west;' sometimes its derivative, מִמְּרָח, when applied to *land lying in a true easterly direction* (Josh. iv. 19); and *very frequently* it corresponds to קֶדֶם *kedem*, the name given by the ancient Hebrews to a certain region, without any regard to its relation to the eastern part of the heavens, comprehending not only Arabia Deserta and the lands of Moab and Ammon, which really lay to the east of Palestine, but also Armenia, Assyria, Mesopotamia, Babylonia, and Chaldea, which were situated rather to the north than the east of Judæa. Its geographical boundaries include Syria, the countries beyond the Tigris and Euphrates, the shores of the Indian ocean and of the Arabian gulf. The name given to this entire region by the Hebrews was אֶרֶץ קֶדֶם (*ἀνατολή*), or the land of Kedem or East; by the Babylonians it was called עֶרְבַּיִם, or 'Arabia.' Its miscellaneous population were called by the former בני קֶדֶם, sons of the east, or orientals, and by the latter, עֶרְבַּיִם, or the people of the west. The Jews themselves also apply to them the Babylonian name in some of their books written after the captivity (2 Chron. xxii. 1; Neh. ii. 9). The Arabs anciently denominated themselves, and do to this day, by either of these names. To this region belong מְלֹכֵי קֶדֶם, the kings of the east (Isa. xix. 11; Jer. xxv. 19-25, Heb.). The following passages may suffice as instances showing the arbitrary application of the term 'east' to this region. Balaam says that Balak, king of Moab, had brought him from the mountains of the east (Num. xxiii. 7), *i. e.* from Pethor on the Euphrates. Isaiah places Syria in the east (ix. 11) אֶרֶץ מִקְרָאם, 'the Syrians from the east' (Bishop Lowth). The distinction seems evident in Gen. xxix. 1, 'Jacob came unto the land of the children of the east.' It occurs again in Judg. vi. 3, 'Even the children of the east came against them;' Sept. *οἱ υἱοὶ ἀνατολῶν*; Vulg. *ceteri orientaliū nationum*. The preceding facts enable us to account for the prodigious numbers of persons sometimes assembled in war against the Israelites (Judg. vi. 5; vii. 12), 'and the children of the east were like grasshoppers for multitude,' and for the astonishing carnage recorded (Judg. viii. 10), 'there fell an hundred and twenty thousand men that drew the sword.' It seems that the inhabitants of this region were distinguished for their proficiency in the arts and sciences (comp. 1 Kings i. 4, 30), and were addicted in the time of Isaiah to superstition (Isa. xxvi.). The wise men, who came from the east to Jerusalem at the birth of the Saviour, no doubt belonged to this tract of country. 'saying we have seen his star in the east.' Campbell justly remarks that 'to see either star or meteor in the east,' means, in English, to see it in the east-quarter of the heavens, or looking eastward. But this cannot be the evangelist's meaning. The meaning manifestly is, that when the magians themselves were in the east, they saw the star

So far were they from seeing the star in the east, according to the English acceptation of the phrase, that they must have seen it in the west, as they were by its guidance brought out of the east country westwards to Jerusalem. Thus the plural of the same word, in the preceding verse, signifies 'the countries lying east from Judæa.' See also ver. 9, where *ἀνατολή* means the place where they first saw the star. Luther's translation reads *im morgenlande*. (Campbell's *Four Gospels translated from the Greek*, 1789, vol. ii. p. 353; Rosenmüller *On Job*, i. 3; Wesley's *Dis. Lib. Job*, 1735, p. 214; Winer, *Bibl. Realwörterbuch*, art. 'Morgenland'; Spanheim's *Hist. Jobe*, c. iv. § 6, p. 81; Gesenius, *Handwörterbuch*, &c.; Jahn, *Archäologie Bibl.*)—J. F. D.

EAST WIND. [WIND.]

EBAL and GERIZIM, two mountains of Samaria, forming the opposite sides of the valley which contained the ancient town of Shechem, the present Nablus. From this connection it is best to notice them together. The valley which these mountains enclose is about 200 or 300 paces wide, by above 3 miles in length; and Mount Ebal rises on the right hand and Gerizim on the left hand of the valley (which extends west-north-west) as a person approaches Shechem from Jerusalem. It was on Mount Ebal that God commanded to be reared up an altar, and a pillar inscribed with the law; and the tribes were to be assembled, half on Ebal and half on Gerizim, to hear the fearful maledictions pronounced by the Levites upon all who should violate the obligations of the sacred code, and the blessings promised to those who should observe them. The tribes which responded with simultaneous 'Amen's' to the curses, were to be stationed on Mount Ebal, and those who answered to the blessings, on Mount Gerizim. This grand ceremony—perhaps the most grand in the history of nations—could not have found a more fitting scene; and it was duly performed by Joshua as soon as he gained possession of the Promised Land (Deut. xxvii.; Josh. viii. 30-35). Dr. Robinson (*Bib. Researches*, iii. 96) says—'Mounts Gerizim and Ebal rise in steep, rocky precipices, immediately from the valley on each side, apparently some 800 feet in height. The sides of both these mountains as here seen (*i. e.* from Nablus) were, to our eyes, equally naked and sterile, although some travellers have chosen to describe Gerizim as fertile, and confine the sterility to Ebal. The only exception in favour of the former, as far as we could perceive, is a small ravine coming down opposite to the west end of the town, which indeed is full of fountains and trees; in other respects both mountains, as here seen, are desolate, except that a few olive-trees are scattered upon them. The side of the northern mountain, Ebal, along the foot, is full of ancient excavated sepulchres. The southern mountain is now called by the inhabitants Jebel-et-Tûr, though the name Gerizim is known, at least, to the Samaritans. The modern appellation of Ebal we did not learn.'

A still more recent American traveller, Dr. Olin, ascended to the top of Gerizim, which he states to be somewhat higher than that of Ebal. The ascent is by an ancient road excavated in the side of the mountain with much labour, and in the steeper parts of the ascent fashioned into a regular flight of broad stone steps. This was probably

the principal ascent to the ancient town and fortress, whose ruins cover the top of the mountain, and that pursued by the religious processions in their way from the valley of Shechem to the temple which the Samaritans built on this mountain in rivalry of the orthodox Temple at Jerusalem [SAMARITAN]. The top of Gerizim affords a commanding view of a considerable region, chiefly occupied with mountains of inferior elevation, but also embracing several fruitful valleys, especially those of Nablus and of Wady Sahl, through which lies the road to Jerusalem. A great number of villages are seen all along its north-eastern side, upon high and apparently precipitous spurs of the mountain which push out into the valley from (Wady Sahl) the main ridge. Dr. Olin declares that the region which he overlooked from the top of Gerizim had the appearance of being the most populous as well as the most fruitful which he had seen in Palestine. Cultivation is carried quite to the top of the mountains, which are adorned with plantations of fruit-trees, while every level spot and a vast number of small fields, supported by terraces, were sown in wheat. A considerable portion of the table-land on the summit of Gerizim itself exhibits marks of recent tillage. Mount Ebal, as viewed from Gerizim, spreads out, like the latter, into a table-land, but is apparently rocky and more broken, and less susceptible of cultivation. Dr. Olin saw, or imagined that he saw, the appearance of ruins upon Mount Ebal, nearly opposite Nablus, but was unable to satisfy himself by a nearer examination (*Travels in the East*, ii. pp. 310-317). If there appears any contradiction in the accounts of the two American writers, it may be removed by observing that Dr. Olin's visit was in the vernal month of April; Dr. Robinson's, in the parched month of June; that Dr. Olin speaks of the view from the top of Gerizim, looking not *into*, but *out of*, the valley of Nablus, over the opposite slope of the mountain, and the lower heights and the fine plain (Wady Sahl) below, and then turning to view that side of Ebal which is presented to the valley of Nablus; whereas the description of Dr. Robinson applies to both mountains as seen from that narrow valley. Many of the apparent discrepancies in the accounts of travellers might be removed, and the bearings of the subject enlarged, by attention to such differences in the points of view.

EBEN-BOHAN. [BOHAN.]

EBEN-EZEL (עֵבֶן הַזֵּזַיִם, *stone of departure*); an old stone of testimony, mentioned in 1 Sam. xx. 19. The circumstance which it commemorated is not known.

EBEN-EZER (עֵבֶן הַעֶזֶר, *stone of help*), the name given to a stone which Samuel set up between Mizpeh and Sheb, in witness of the divine assistance obtained against the Philistines (1 Sam. vii. 12).

EBER [HEBER.]

EBODA, one of the stations of the Israelites in the wilderness. [WANDERING, THE.]

EBONY. [HABENIM.]

ECBATANA. [ACHMETHA.]

ECCLESIASTES (קֹהֶלֶת *Koheleth*). 1. *The Hebrew Name of the Book*.—This book has obtained its Hebrew name from the designa-

tion of the principal person mentioned in it, who is thus self-styled in several passages. The feminine termination of the name has given rise to the opinion that Koheleth means a body or academy of sages, whose dicta are contained in this book; but this opinion is contradicted by the heading of the book itself, which thus commences:

Words of חלקה, the son of David, the king in Jerusalem. Hence it appears that Koheleth is intended for an epithet of Solomon. Compare also ch. i. 12, 'I. Koheleth, was king over Israel in Jerusalem.' With one exception, in ch. vii. 27, the word Koheleth is always construed as a masculine noun.

The various interpreters who consider Koheleth as expressive of a person, differ in their translation of it in different manners. Some follow the Septuagint, in which it is translated Ἐκκλησιαστής, *assembler*. Others interpret it by *COLLECTOR*; which implies, they state, that the author not merely intended to communicate his own wisdom, but that he had compiled the experience of former sages. The verb חלקה, however, does not mean to *compile*, but always to *assemble* or to *convene a meeting*. It hence appears that the Septuagint translation, *assembler, preacher, or teacher*, is correct. Still there remains to be explained the feminine form of the word. The only correct explanation of this is, that Solomon was called Koheleth because he was personified Wisdom, חכמה, and that Wisdom spoke through him. St. Augustine says, 'Sapientia per Salomonem cecinit.' So, also, among the moderns, Ewald, *Grammar*, p. 569; and *Die Pöetischen Bücher des Alten Bundes*, th. iv. p. 180. According to this interpretation, the construction of חלקה, both with the masculine and with the feminine, may be equally well explained. If with the masculine, the bearer of the name is considered; but if with the feminine, the חכמה, *wisdom*, which animates him, is kept chiefly in view.

According to the usual opinion, which has again lately been defended by Knobel, the feminine termination is to be explained by the fact that *abstracta* frequently occur *pro coneretis*; and that especially abstract names of offices are transferred as titles to the office-bearers. This explanation does not apply here, because Koheleth is not an *abstractum*, like *predicatio*, describing Solomon as a living preaching, but can only mean something like *concionatrix, predicatrix*.

The title of the book, however, indicates that the author did not write only for a literary public, but that he had in view the whole congregation of the Lord; and that his doctrine was not confined within the narrow bounds of a school, but belonged to the church in its whole extent. Compare Ps. xlix. 2-4.

II. *The Author of the Book.*—The circumstance that Solomon is introduced as the speaker in this book has induced most of the ancient interpreters to consider him as its author. This opinion was opposed by Grotius, who says, 'Ego tamen Salomonis esse non puto, sed scriptum serius sub illius regis tanquam penitentia ducti nomine.' In support of this assertion Grotius appeals to the peculiarities of the language.

The only argument in support of the opinion that Solomon was the author of the book appears

quite insufficient, from this single circumstance, that the author also of the book entitled the *Wisdom of Solomon*, which was written in Greek, introduces Solomon as speaking. Hence the question arises whether it is not merely in form that the author of *Ecclesiastes* does the same. He certainly seems to indicate this by introducing Solomon not by his proper name, but by the name Koheleth; which signifies that Solomon is not introduced in his individual capacity, but is here rather to be considered as the representative of Wisdom.

But the greatest obstacle in the way of considering Solomon to be the author, is the character of the language. Many opponents of the Solomonic authorship certainly went much too far in their assertions. The Grecisms which Zülke thought that he had found have now generally been given up. The Rabbinisms likewise could not stand the proof. The words, significations, and forms which seem to appertain to a later period of Hebrew literature, and the Chaldaisms, an abundance of which Knobel gathered, require,

as Herzfeld has shown, to be much sifted. (חלקה, *übersetzt und erläutert*, von Dr. L. Herzfeld, Braunschweig, 1838, p. 13, sq.) According to Herzfeld, there are in Koheleth not more than between eleven and fifteen 'young Hebrew' expressions and constructions, and between eight and ten Chaldaisms. Nevertheless, it is certain that the book does not belong to the productions of the first, but rather to the second period of the Hebrew language. This alone would not quite disprove the authorship of Solomon, if we could produce any weighty argument in its favour. We could suppose that Solomon, in a philosophical work, found the pure Hebrew language to be insufficient; and had, therefore, recourse to the Chaldaizing popular dialect, by which, at a later period, the book-language was entirely displaced. This supposition could not be rejected *a priori*, since almost every one of the Hebrew authors before the exile did the same, although in a less degree. There exist, however, no weighty positive reasons for supposing Solomon to be the author; and the striking difference between the language of Koheleth and the language of the Proverbs renders that explanation quite inadmissible. This difference would prove little if the two books belonged to two entirely different classes of literature; that is, if Koheleth bore the same relation to the Proverbs as the Song of Solomon does: but since Koheleth and the Proverbs belong essentially to the same class, the argument taken from the difference of style must be admitted to be perfectly conclusive.

Among the other arguments which have been produced against Solomon's authorship, the only one which seems to have some importance, is that the author now and then forgets his fiction; for instance, in ch. i. 12, where he says 'I was king over Israel in Jerusalem.' But such passages are by no means decisive. The arguments taken from the contents, which Knobel at p. 77, sq. has produced, are quite futile. For instance, that Solomon, who was constantly prosperous, could not have written in so melancholy a manner; and could not have complained about the prevalence of injustice without writing a satire against himself; that he would not have written so

unfavourably about women, to whom he was so partial, &c.

Supposing it now proved that Solomon is only introduced as the speaker, the question arises why the author adopted this form. The usual reply is, that Solomon among the Israelites had, as it were, the prerogative of wisdom; and hence the author was induced to put into Solomon's mouth that wisdom which he intended to proclaim, without the slightest intention of forging a supposititious volume. This reply contains some truth; but it does not exhaust the matter.

The chief object of the author was to communicate wisdom in general; but next to this, as appears from ch. i. 12, sq., he intended to inculcate the vanity of human pursuits. Now, from the mouth of no one could more aptly proceed the proclamation of the nothingness of all earthly things than from the mouth of Solomon, who had possessed them in all their fulness; at whose command were wisdom, riches, and pleasures in abundance; and who had therefore full opportunity to experience the nothingness of all that is earthly. What Rambach, in his *Annotiones Uberiores*, th. ii. p. 829, says, presupposing the authorship of Solomon, may with slight alteration be applied to the real author: 'Neque vero sine singulari Dei providentia, ille pre reliquis divinitus excitatus fuit, qui rerum hujus sæculi omnium vanitatem doceret, ut nimium apud omnes eo majores momenti esset testimonium ejus, cui tantus antea rerum variarum amor, ut nihil inexpectum reliquerit, tantus opum apparatus fuit, ut voluptates ac delicias omnis gustaturus nulla sumtuum inopia excluderetur.'

III. *Date of the Book.*—The history of the canon fixes the time after which the book cannot have been written. It cannot have been written after the times of Ezra and Nehemiah, under whom the canon was completed. The writers who asserted that Koheleth was written at the conclusion of the Persian and at the beginning of the Macedonian period, or who even make it as late as the time of the Maccabees, are unable to produce any argument capable of standing proof, and can scarcely render their assertions probable.

The style alone furnishes the date BEFORE which the book cannot have been written; that is, not before the time of Aramæan influence. But within these boundaries we are unable to produce any valid reasons for fixing the date more precisely. The language cannot be our guide, because, after the Aramæan dialect had commenced to penetrate into the Hebrew, the degree of its adoption depended henceforth upon the peculiar character of individual authors. The reasons deduced from the contents, by means of which Ewald, p. 179, sq., has endeavoured to prove that the author lived in the later period of the Persian government, the contemporary of Malachi and Nehemiah, are unimportant. A sense of the vanity of earthly things, complaints respecting the perversion of justice, oppression, and arbitrary government; admonitions to obey the magistrates; all this is, according to Ewald, indicative of the later period of the Persian government, which probably became at last oppressive and odious. But to all this there could be produced parallels from the ancient books of Holy Writ, because these are sentiments and facts as old and as lasting as the world. One circumstance alone seems to indicate

that Koheleth was not written during the latter period of the first, but rather during the time of the second temple, since idolatry does not occur amongst the deviations combated by the author. The whole book seems to presuppose that the people were externally devoted to the Lord. The admonitions of the author to a serene enjoyment of life, and against murmuring; exhortations to be contented with Divine Providence, and the attacks upon a selfish righteousness of works, may best be explained by supposing the author to have lived in a period like that of Malachi, in which there prevailed a Pharisaical righteousness of works, and melancholy murmurings because God would not recognise the alleged *rights* which they produced before him, and refused to acknowledge the *claims* they made upon him. Whoever will compare Koheleth and Malachi will find a striking similarity.

IV. *Plan.*—The author places the fundamental idea of the nothingness of all earthly things both at the beginning and at the end of his book, and during its course repeatedly returns to the same. This has induced many interpreters to suppose that the purpose of the author was to demonstrate this one idea; an opinion which, down to the most recent times, has been unfavourable to the true interpretation of the book, because every thing, however reluctant, has been forced into an imaginary connection. The following is the correct view. The object of the author is not to teach an especial tendency of wisdom, but wisdom in general. Consequently, it is not at all surprising if the connection suddenly ceases, and a new subject commences. The artificial process by which Ewald, for instance, frequently endeavours to establish a connection, is quite inadmissible. That the idea of the nothingness of earthly matters should strongly predominate may easily be explained, since according to our author it forms a very important part of wisdom. He never, however, intended to confine himself to this one idea, although he likes frequently to point it out in passing, even when he is considering a matter from another point of view. Herder, although he also too much supposes that the author intended to treat of a particular subject, has best explained the plan of Koheleth (*Werke zur Religion und Theologie*, th. xiii. p. 148, 1829): 'The plan of this book has been the subject of much investigation. It is best to consider this plan as free as possible, and to employ its separate parts for its support. The commencement and the conclusion show the unity of the whole. But since King Solomon would not write a *disputatio de vanitate rerum*, the greater part consists of isolated observations concerning the course of the world, and the experience of his life. These are connected with general sentences; and, finally, a very simple conclusion is deduced from the whole. It seems to me that a more artificial texture ought not to be sought for.'

Several interpreters have supposed that Koheleth consists of a dialogue between a considerate sage and a discontented sceptic. Others have thought that not two persons, but two voices, or two moods of the same person, are to be distinguished, whose conflict is at the conclusion terminated in the victory of the better part by faith. This opinion, however, originated from an imperfect understanding, which seemed to discover every where

irreconcilable contradictions. Whoever penetrates deeper will perceive that the author remains unchanged from the beginning to the end.

V. *Contents and Objects of the Book.*—Here we consider only the fundamental idea, omitting isolated sentences of wisdom, and rules for the conduct of life. Nobody can entertain any doubt concerning this fundamental idea. It is contained in the sentence: 'Vanity of vanities; all is vanity.' It is, however, very important that this should be rightly understood. The question is, What is that ALL which is vanity? The author does not mean ALL in general, but only ALL of a certain genus. He himself explains this, by defining this ALL in numerous passages; as, 'all that is under the sun'; that is, earthly things in their separation from the heavenly. To this leads also the enumeration of the ALL, in which occur only those things which belong to the earth—riches, sensual pleasure, honour, sphere of activity, human wisdom apart from God, self-righteousness. From many passages it appears that the author was far from comprehending the fear of God and active obedience to his laws among that ALL which was vanity. This appears most strikingly from the conclusion, which, as such, is of the highest importance, and furnishes the undoubted measure for the correctness of the whole interpretation. 'Let us hear the conclusion of the whole matter: Fear God, and keep his commandments: for this is the whole duty of man [*i. e.* in this consists all that is incumbent upon him; and his whole salvation depends upon it]. For God shall bring every work into judgment, with every secret thing, whether good, or whether evil.' (Compare ch. xii. 1: 'Remember now thy Creator in the days of thy youth'; ch. v. 5-7, 'Fear thou God'; ch. vii. 18, and many other passages.) A deep religious sense pervades the whole book. In reference to the prevailing idea, Ewald strikingly remarks, p. 182, 'There blows throughout this book a piercing chill against every earthly aim, and every vain endeavour; a contempt which changes into a bitter sneer against every thing which in the usual proceedings of men is one-sided and perverse; an indefatigable penetration in the discovery of all human vanities and fooleries. In no earlier writing has all cause of pride and vain imagination so decidedly and so comprehensively been taken from man; and no book is pervaded by such an outcry of noble indignation against all that is vain in this world.'

From the contents of the book results its object. The author had received the mission to treat professedly and in a concentrated manner the highly important sentence, 'Vanitas vanitatum, omniaque vanitas,' which pervades the whole of Holy Writ; but he is not content with the mere theoretical demonstration, so as to leave to another teacher its practical application, but places before us these practical results themselves: What is incumbent upon man, since every thing else is nought? What real good remains for us, after the appearance in every seeming good has been destroyed? The answer is, Man shall not gain by cunning and grasping; shall not consume himself in vain meditations, nor in a hurried activity; he shall not murmur about the loss of that which is naught; he shall not by means of a self-made righteousness constrain God to grant him salvation; but he shall instead fear God (ch. xii. 13; v. 6, 7), and be

mindful of his Creator (ch. xii. 1); he shall do good as much as he is able (ch. iii. 12); and in other passages. And all this, as it is constantly inculcated by the author, with a contented and grateful heart, freed from care and avarice; living for the present moment, joyfully taking from the hand of the Lord what he offers in a friendly manner. Man shall not be of a sorrowful countenance, but in quiet serenity enjoy the gifts of God. What would avail him all his cares and all his avarice? By them he cannot turn anything aside from him, or obtain any thing, since every thing happens as it shall happen. This aim of the book has been best developed by Ewald among the moderns; but it was already perfectly well understood by Luther, who, in his *Præfatio in Ecclesiasten*, says, 'Est status et consilium hujus libelli erudite nos, ut cum gratiarum actione utamur rebus præsentibus et creaturis Dei, quæ nobis benedictione Dei largitur dantur et donatæ sunt, sine sollicitudine futurorum, tantum ut tranquillum et quietum cor habeamus et animam gaudii plenum, contenti scilicet verbo et opera Dei.'

VI. *Misunderstandings of this Book.*—This book has always had many warm friends, even among those who have not been decided believers in revelation. Herder, for instance, p. 146, says, 'I do not know any book in the whole of the Old Testament that describes more fully, more convincingly, or more concisely, the whole sum of human life, with all its changes and vanities, in occupations, plans, speculations, and pleasures; and at the same time that which alone is real, lasting, progressive, and rewarding.'

On the other hand, this book has excited various doubts, and met with opposition. St. Jerome, in his commentary on ch. xii. v. 13, relates that, according to the statement of the Hebrews, they were disinclined to receive it into the canon: 'eo quod vanas assereret Dei creaturas et totum putaret esse pro nihilo, et cibum et potum et delicias transeuntes præferret omnibus;' but that the conclusion of the volume had saved its divine authority. Similar doubts occur in the Talmud and other Jewish writings. These doubts were not, however, allowed to prevail, but were suppressed in deference to the conclusion of Koheleth.

Within the Christian Church the divine inspiration of Koheleth, the Proverbs, and the Song of Solomon was denied by Theodoros of Mopsuestia. In recent times, the accusers of Koheleth have been Augusti, De Wette, and Knobel; but their accusations are based on mere misunderstandings. They are especially as follows:—1. The author is said to incline towards a moral epicurism. All his ethical admonitions and doctrines tend to promote the comforts and enjoyments of life. But let us consider above all what tendency and disposition it is to which the author addresses his admonition, serenely and contentedly to enjoy God's gifts. He addresses this admonition to that speculation which will not rest before it has penetrated the whole depth of the inscrutable councils of God; to that murmuring which bewails the badness of times and quarrels with God about the sufferings of our terrene existence; to that gloomy piety which wears itself in imaginary good works and external strictness, with a view to wrest salvation from God; to that avarice which gathers, not

knowing for whom; making the means of existence our highest aim; building upon an uncertain futurity which is in the hand of God alone. When the author addresses levity he speaks quite otherwise. For instance, in ch. vii. 2, 4, 'It is better to go to the house of mourning than to the house of feasting; for that is the end of all men; and the living will lay it to his heart. Sorrow is better than laughter; for by the sadness of the countenance the heart is made better. The heart of the wise man is in the house of mourning; but the heart of fools is in the house of mirth.' The nature of the joy recommended by the author is also misunderstood. Unrestrained merriment and giddy sensuality belong to those vanities which our author enumerates. He says to laughter, thou art mad, and to joy, what art thou doing? He says, ch. vii. 5, 6, 'It is better to hear the rebuke of the wise than for a man to hear the song of fools. For as the crackling of thorns under a pot, so is the laughter of a fool; this also is vanity.' That joy which he recommends is joy in God. It is not the opposite, but the fruit of the fear of God. How inseparable these are is shown in passages like ch. v. 6, vii. 18. iii. 12, 'I know that there is no good in them, but for a man to rejoice, and to do good in his life;' and in many similar passages, but especially ch. xi. 9, 10, and xii. 1, 'Remember now thy Creator in the days of thy youth,' &c. In reference to these passages Ewald says, p. 186, 'Finally, in order to remove every doubt, and to speak with perfect clearness, he directs us to the eternal judgment of God, concerning all the doings of man, and inculcates that man, in the midst of momentary enjoyment, should never forget the whole futurity, the account and the consequences of his doings, the Creator and the Judge.' Ewald adds, p. 227, in reference to the conclusion, 'In order to obviate every possible misunderstanding of this writing, there is, ver. 13, once more briefly indicated that its tendency is not, by the condemnation of murmuring, to recommend an unbridled life; but rather to teach, in harmony with the best old books, the fear of God, in which the whole man consists; or that true singleness of life, satisfying the whole man, and which comprehends every thing else that is truly human. It is very necessary to limit the principle of joy which this book recommends again and again in various ways and in the most impressive manner; and to refer this joy to a still higher truth, since it is so liable to be misunderstood. 2. It is objected that in his views concerning the government of the world the author was strongly inclined to fatalism, according to which everything in this world progresses with an eternally unchangeable step; and that he by this fatalism was (3.) misled into a moral scepticism, having attained on his dogmatical basis the conviction of the inability of man, notwithstanding all his efforts, to reach his aim. However, this so-called fatalism of our author is nothing else but what our Lord teaches, Matt. vi. 25: 'Take no thought,' &c. And as for the moral scepticism, our author certainly inculcates that man with all his endeavours can do nothing; but at the same time he recommends the fear of God, as the never-failing means of salvation. Man in himself can do nothing; but in God he can do all. It is quite clear from ch. vii. 16, 18, where both self-righteousness and

wisdom, when separated from God, are described as equally destructive, and opposite to them is placed the fear of God, as being their common antithesis, that our author, by pointing to the sovereignty of God, did not mean to undermine morality: 'He that feareth God comes out from them all.' If our author were given to moral scepticism, it would be impossible for him to teach retribution, which he inculcates in numerous passages, and which are not contradicted by others, in which he says that the retribution in individual circumstances is frequently obscure and enigmatical. Where is that advocate for retribution who is not compelled to confess this as well as our author? (4.) This book has given offence also, by ch. iii. 21, and similar passages, concerning immortality. But the assertion that there is expressed here some doubt concerning the immortality of the soul is based on a wrong grammatical perception. The ך cannot, according to its punctuation, be the interrogative, but must be the article; and our author elsewhere asserts positively his belief in the doctrine of immortality (ch. xii. 7). How it happens that he did not give to this doctrine a prevailing influence upon his mode of treating his subject has lately been investigated by Heyder, in his essay entitled *Ecclesiastæ de Immortalitate Animi Sententiæ*, Erlangen, 1838.—E. W. H.

ECCLESIASTICUS. [WISDOM OF SIRACH.]

ECDIPPA. [ACHIZIB.]

EDEN. [PARADISE.]

EDOM. [ESAU.]

EDOMITES. [IDUMÆA.]

EDREI (עֲדְרַי; Sept. Ἐδραῖν), one of the metropolitan towns (Ashtaroth being the other) of the kingdom of Bashan, beyond the Jordan. It was here that Og, the gigantic king of Bashan, was defeated by the Israelites, and lost his kingdom (Num. xxi. 33-35; Deut. i. 4; iii. 1-3). Edrei afterwards belonged to eastern Manasseh (Josh. xiii. 31). It is mentioned in the Onomasticon as 24-25 R. miles from Ashtaroth. It was the seat of a bishop in the early ages of Christianity, and a bishop of Adraa sat in the council of Seleucia (A.D. 381), and of Chalcedon (A.D. 451). Adraa was the name given to the place by the Greeks: by the Crusaders it was known as Adratum, and also as Civitas Bernardi de Stampis (Will. Tyr. p. 895). Abulfeda calls it Adsraat (*Tab. Syr.* 79). The place now bears the name of Draa, and has been visited in the present century by most of the travellers who have explored the country beyond the Jordan,—Seetzen, Burckhardt, Buckingham, Richter, G. Robinson, &c. It is situated in a deep valley, two hours south-east from Mezareib; and the ruins cover an extent of about two miles in circumference, the principal being an immense rectangular building, with a double covered colonnade all around, and a cistern in the middle. This seems to have been originally a Christian church, and afterwards a mosque. Near the town, in the hollow of the mountains, is a large reservoir cased with stone, near which are the ruins of a large building, with a cupola of light materials.

EGLON (עִגְלוֹן; Sept. Ἐγλώμ), a king of Moab, who, assisted by the Ammonites and Amalekites, subdued the Israelites beyond the Jordan, and the southern tribes on this side the

river, and made Jericho the seat, or one of the seats, of his government. This subjection to a power always present must have been more galling to the Israelites than any they had previously suffered. It lasted eighteen years, when (B.C. 1428) they were delivered, through the instrumentality of Ehud, who slew the Moabitish king (Judg. iii. 12-33).

EGOZ (גוז). This word occurs in the Song of Solomon, vi. 11, 'I went into the garden of nuts,' where probably 'walnuts' are intended. The Hebrew name is evidently the same as the

Persian گوز *gowz*, which has been converted by the Arabs into جوز *jowz*, by a process common in the case of many other words beginning with the interchangeable letters *gaf* and *jim*. In both languages these words, when they stand alone, signify the walnut, *gouz-bun* being the walnut-tree: when used in composition they may signify the nut of any other tree;—thus *jouz-i-bou* is the nutmeg, *jouz-i-hindi* is the Indian or cocoa-nut, &c. So the Greeks employed κάρνον, and the Romans *nux* to denote the walnut; which last remains in modern languages, as Ital. *noce*, Fr. *noix*, Span. *nuez*, and Ger. *nusz*. The walnut was, however, also called κάρνον βασιλικόν (Diosc. i. 179), royal nut, and also Περσικόν, or Persian, from having been so highly esteemed, and from having been introduced into Greece from Persia: the name *juglans* has been derived from Jovis glans. That the walnut was highly esteemed in the East we learn from Abulpharagius, who states that Al Mahadi, the third caliph of the Abassides, 'sub juglande sub qua sedere solebat, sepultus est.' That it is found in Syria has been recorded by several travellers. Thevenot found it in the neighbourhood of Mount Sinai, and Belon says of a village not far from Lebanon, that it was



370. [Walnut—*Juglans regia*.]

'bien ombragé d'ormeaux et de noyers.' That it was plauted at an early period is well known, and might be easily proved from a variety of sources.

The walnut, or *juglans regia* of botanists, belongs to the natural family of juglandææ, of which the species are found in North America and in Northern Asia. The walnut itself extends from Greece and Asia Minor over Lebanon and Persia, probably all along the Hindoo Khoush to the Himalayas, and is abundant in Cashmere (*Him. Bot.* p. 312). The walnut-tree is well known as a lofty, wide-spreading tree, affording a grateful shade, and of which the leaves have an agreeable odour when bruised. It seems formerly to have been thought unwholesome to sit under its shade, but this appears to be incorrect. The flowers begin to open in April, and the fruit is ripe in September and October. The tree is much esteemed for the excellence of its wood; and the kernel of the nut is valued not only as an article of diet, but for the oil which it yields. Being thus known to, and highly valued by, the Greeks in early times, it is more than probable that, if not indigenous in Syria, it was introduced there at a still earlier period, and that therefore it may be alluded to in the above passage, more especially as Solomon has said, 'I made me gardens and orchards, and planted trees in them of all kind of fruits' (Eccles. ii. 5).—J. F. R.

EGYPT (אֵצֶיץ, poetically אֵצֶיץ; in Ps. cv. 23, אֵצֶיץ חָמִי), the land of Ham, a son of Noah, from whom was derived the ancient native appellation of the country, Chemi. From Mizraim, the second son of Ham, comes the ordinary Biblical name, Mizraim, a word which properly denotes Lower Egypt, as being that part of the country with which the Israelites were nearest and best, if not (in the earlier periods of their history) solely, acquainted. This designation, however, is sometimes used for Egypt indiscriminately, and was by the later Arabs extended to the entire country. Josephus (*Antiq.* i. 6. 2) says that all those who inhabit the country call it Mestram, and the Egyptians, Mestramens. The word Chemi, according to Plutarch, signifies black, in allusion to the dark colour of the water of the Nile. The Greek and European name (*ἡ Αἴγυπτος*), Egypt, is of uncertain origin and signification (Champollion, *L'Egypte*, i. 77). In Homer, the Nile is called Egypt, Αἴγυπτος.

Egypt is the land of the Nile, the country through which that river flows from the island of Philæ, situated just above the Cataracts of Syene, in lat. 24° 1' 36", to Damierta, in 31° 35' N., where its principal stream pours itself into the Mediterranean Sea. On the east it is bounded by Palestine, Idumæa, Arabia Pætræa, and the Arabian Gulf. On the west, the moving sands of the wide Libyan desert obliterate the traces of all political or physical limits. Inhabited Egypt, however, is restricted to the valley of the Nile, which, having a breadth of from two to three miles, is enclosed on both sides by a range of hills: the chain on the eastern side disappears at Mocattam; that on the west extends to the sea. In lat. 30° 15', the Nile divides into two principal streams, which, in conjunction with a third that springs somewhat higher up, forms the Delta so called from its resemblance to the Greek letter Δ. These mountains are interesting, if for no other reason than that they served as the bed whence the materials were obtained out of which were constructed the wonderful buildings for

which Egypt is justly distinguished. The superficial extent of Egypt has been estimated at about 11,000 square miles. The soil, which is productive, consists almost exclusively of mud brought down and deposited by the river, whose waters are indispensable every year for the purposes of agriculture to such an extent that the limits of their flow are the limits of vegetation. The Delta owes its very existence to the deposits of the Nile, and but for the waters of this stream, carried over its surface by natural or artificial means, would soon be a desert: it was therefore with propriety, as, indeed, was the entire country, termed 'the gift of the Nile.' The agency of the stream is the more necessary because rain very seldom falls in Lower Egypt. The land, placed as it is on the confines of Africa and Asia, yet so adjacent and accessible to Europe, in itself a garden and a store-house, may well have held an important position in the ancient world, and can hardly fail, unless political influences are very adverse, to rise to a commanding attitude in modern times. As to the number of its inhabitants, nothing very definite is known. Its fertility would doubtless give birth to, and support, a teeming population. In very remote times as many as 8,000,000 of souls are said to have lived on its soil. In the days of Diolorus Siculus they were estimated at 3,000,000. Volney made the number 2,300,000. The present government estimate is 3,200,000, which seems to be somewhat beyond the fact (*Bowring's Report on Egypt and Candia*, p. 4).

Egypt naturally divides itself into two great sections at the apex of the Delta, the country lying south of that point being designated Upper Egypt, that north of it Lower Egypt. Upper Egypt itself was divided into the Thebais and the Heptanomis: the Thebais extended from Philæ to Hermopolis; Heptanomis, from Hermopolis to the point where the Delta begins to form itself. Under the Ptolemies, and probably at a very early period, the whole country was divided into thirty-six cantons or provinces (*Diod. Sic. i. 51*; *Strabo*, xvii. 1), which division was maintained till the invasion of the Saracens. It is now composed of 21 departments, which, according to the French system of geographical arrangement, are subdivided into arrondissements and cantons (*Bowring's Report*).

The Nile is never mentioned by name in our translation of the Old Testament; it is always called the river of Egypt, although the word Nile (נִלוֹ) occurs in the original (*Isa. xxvii. 12*; *Josh. xv. 4*; *2 Kings xxiv. 7*). In these places the river of Egypt, literally the Nile of the Egyptians, is spoken of as the boundary of Palestine. The desert appears to have been the natural boundary between Palestine and Egypt; but map-makers, agreeably with their idea of the passages just referred to, have inserted a stream in the desert, and called it Ægyptus. Yet there is no difficulty in understanding the claim of the Jewish writers to extend Palestine, say to the Pelusian mouth of the Nile, when it is remembered that Solomon had ports on the Red Sea.

Till within a few years the sources of the Nile and the termination of the Niger were hid in alike mysterious obscurity. The latter has been discovered, but the former, notwithstanding many

srenuous efforts and some pretence, remain to reward the enterprise of some more fortunate traveller. The various branches of the Nile have their rise in the high lands north of the equator. The three principal branches of the Nile are, 1. the Bahr el Abiad, or White River, to the west, which is now known to be the largest and longest; 2. the Bahr el Azrek, or Blue River, in the centre; 3. the Tacazzé, or Abara, which is the eastern branch. The Nile, from its confluence with the Tacazzé (17° 45' north lat.) down to its entrance into the Mediterranean (1200 geographical miles), receives no permanent streams; but in the rainy season it receives wadys, or torrents, from the mountains. The annual overflow of the river, on which the ancients wrote so obscurely, is known to arise from the periodical rains which fall within the tropics. The rich alluvial deposits which the Nile spreads over Nubia and Egypt are mainly derived through the Blue River; the White River, or longest stream, bringing nothing of the kind. Owing to the yearly deposit of alluvial matter, both the bed of the Nile and the land of Egypt are being gradually raised. The river proceeds in its current uniformly and quietly at the rate of two and a half or three miles an hour, always deep enough for navigation. Its water is usually blue, but it becomes of a deep brick-red during the period of its overflow. It is salubrious when drunk, meriting the encomiums which it has so abundantly received. On the river the land is wholly dependent. If the Nile does not rise a sufficient height, sterility and dearth, if not famine, ensue. An elevation of sixteen fathoms is essential to secure the prosperity of the country. Such, however, is the regularity of nature, and such the faithfulness of God, that for thousands of years, with but few and partial exceptions, these inundations have in essential particulars been the same. The waters of the stream are conveyed over the surface of the country by canals when natural channels fail. During the overflow the land is literally inundated, and has the appearance of a sea dotted with islands. Wherever the waters reach, abundance springs forth. The cultivator has scarcely more to do than to scatter the seed. No wonder that a river whose waters are so grateful, salubrious, and beneficial, should in days of ignorance have been regarded as an object of worship, and that it is still revered and beloved.

Well may Egypt have been visited as a granary by the needy in ancient times (*Gen. xii. 10*; *Exod. xvi. 3*; *Joseph. Antiq. xv. 9, 2*). Besides corn, the country produced onions, garlic, beans, pumpkins, cucumbers, melons, flax, cotton and wine. The acacia, sycamore, palm, and fig-tree adorned the land; but there was a want of timber. The Nile produced the useful papyrus, and abounded in fish. On its banks lurked the crocodile and hippopotamus. The Egyptian oxen were celebrated in the ancient world (*Aristot. Hist. Anim. viii. 28*). Horses abounded (*1 Kings x. 28*); hence the use of war-chariots in fight (*Isa. xxxi. 1*; *Diod. Sic. i. 45*), and the celebrity of Egyptian charioteers (*Jer. xlvi. 4*; *Ezek. xvii. 15*). The land was not destitute of mineral treasures. Gold mines were wrought in Upper Egypt (*Diod. Sic. iii. 12*).

The climate is very regular and exceedingly hot; the atmosphere clear and shining; a shade is

not easily found. Though rain falls even in the winter months very rarely, it is not altogether wanting, as was once believed. Thunder and lightning are still more unfrequent, and are so completely divested of their terrific qualities that the Egyptians never associate with them the idea of destructive force. Showers of hail descending from the hills of Syria are sometimes known to reach the confines of Egypt. The formation of ice is very uncommon. Dew is produced in great abundance. The wind blows from the north from May to September, when it veers round to the east, assumes a southerly direction, and fluctuates till the close of April. The southerly vernal winds, traversing the arid sands of Africa, are most changeable as well as most unhealthy. They form the simoom or samiel, and have proved fatal to caravans and even to armies (*View of Ancient and Modern Egypt*, Edin. Cab. Library). Mosquitos, locusts, frogs, together with the plague, the small pox, and leprosy, are the great evils of the country.

fully practised all the arts of life, and have left ever-during memorials of their proficiency and skill.

On this natural diversity of pursuits, as well as on a diversity of blood—for besides the master and ruling race of Ethiopians were others who were of nomade origin—was founded the institution of castes, which Egypt had in common with India, and which pervaded the entire life of the nation. These, according to Herodotus (xi. 161), were seven in number (comp. Diod. Sic. i. 73). The priestly caste was the most honoured and influential. It had in every large city a temple dedicated to the deity of the place, together with a high priest, who stood next to the king and restricted his power. The priesthood possessed the finest portions of the country. They were the judges, physicians, astrologers, architects,—in a word, they united in themselves all the highest culture and most distinguished offices of the land, while with them alone lay tradition, literature, and the sacred writings. This class exerted the most decided and extensive influence on the culture not only of their own country, but of the world; for during the brightest periods of Grecian history the love of knowledge carried into Egypt men who have done much to form the character of after ages, such as Solon, Pythagoras, Archytas, Thales, Herodotus, Plato, and others (comp. Gen. xli. 8; Exod. vii. 11; viii. 11; xiii. 7; Joseph. *Antiq.* ii. 9, 2).

The peculiarities of the ancient Egyptians of the lower castes seem to have survived best, and to be represented, at least in some particulars, by the Fellahs of the present day. These Fellahs discharge all the duties of tilling the country and gathering its rich abundance. They are a quiet, contented, submissive race, always living, through an unjust government, on the edge of starvation, yet always happy, with no thought for the morrow, no care for, no interest in, political changes. 'Of the Fellahs it may be said, as was said by Amrou of the ancient Egyptians: "they are bees always toiling, always toiling for others, not themselves." The love of the Fellah for his country and his Nile is an all-absorbing love. Remove him, and he perishes. He cannot live a year away from his village; his grave must be where his cradle was. But he is of all men most submissive: he will rather die than revolt; resignation is his primary virtue; impatience under any yoke is unknown to him; his life, his faith, his law is submission. "Allah Kerim!" is his hourly consolation, his perpetual benediction. He was made for peace, not for war; and, though his patriotism is intense, there is no mingling in it of the love of glory or the passion for conquest. His nationality is in his local affections, and they are most intense. Upon this race, the race of bright eyes and beautiful forms, it is impossible to look without deep interest: of all the gay, the gayest; of all the beings made for happiness, the most excitable. If days of peace and prosperity could be theirs, what songs, what music, what joys' (Bowring's *Report*, p. 7).

The only other tribe we have room to notice is that of the Copts, equally with the preceding, indigenous. They are Christians by hereditary transmission, and have suffered centuries of cruel persecutions and humiliations, though now they seem to be rising in importance, and promise to fill an important page in the future history of

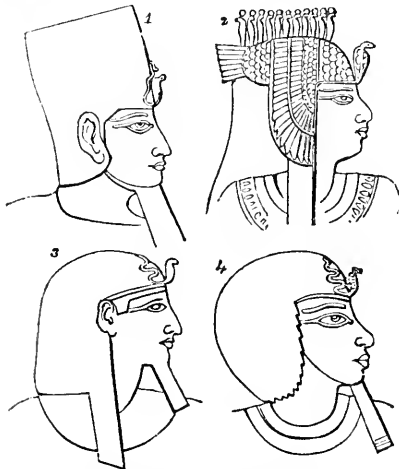

271. 1. Egypto-Ethiopian (the Tirkake of Scripture); 2, 4. Ethiopian; 3. Egyptian.

The most recent inquiries have shown that the extreme limit at Philæ was only of a political nature; for the natives of the country below it were of the same race as those who lived above that spot—a tribe which passed down into the fertile valley of the Nile from its original abode in the south. These Ethiopians and the Egyptians were not negroes, but a branch of the great Caucasian family. Their colour—at least the colour of the higher castes—was brown; their frame slender, but of great strength. Their speech, now found in the Coptic, is akin to the Shemitic tongues. The women were very fruitful (Strabo, xv. p. 695; Heeren, *Ideen*, xi. 2, 10).

The mode of life of the Egyptians was influenced by their locality: those who dwelt on high lands on the east, as well as those who dwelt on the marshy flat country in the Delta, were shepherds, as their land did not admit cultivation. The people who lived along the Nile became fishermen and sailors. The cultivated part of the natives who lived on the plains and over the surface of the country diligently and most success-

Egypt. In character they are amiable, pacific, and intelligent, having of course the faults and vices of dissimulation, falsehood, and meanness, which slavery never fails to engender. In office they are the scribes, the arithmeticians, the measurers, the clerks,—in a word, the learned men of the country. The language which they use in their religious services is the ancient Egyptian, or Coptic, which, however, is translated into Arabic for the benefit of the laity. The Copts have been under-estimated at 150,000 souls, divided into twelve episcopal districts, the bishops of which unite to elect a patriarch (Bowring's *Report*).

'The wisdom of Egypt' was a phrase which, at an early period, passed into a proverb, so high was the opinion entertained by antiquity of the knowledge and skill of the ancient Egyptians (1 Kings iv. 30; Herod. ii. 160; Joseph. *Antiq.* viii. 25; Acts vii. 22). Nor, as the sequel of this article will show, were there wanting substantial reasons for the current estimate. If, however, antiquity did not on this point exceed the bounds of moderation, very certain is it that men of later ages are chargeable with the utmost extravagance in the terms which they employed when speaking on the subject. It was long thought that the hieroglyphical inscriptions on the monumental remains of Egypt contained treasures of wisdom no less boundless than hidden; and, indeed, hieroglyphics were, in the opinion of some, invented by the priests of the land, if not expressly to conceal their knowledge from the profane vulgar, yet as a safe receptacle and convenient storehouse for their mysterious but invaluable doctrines. Great, consequently, was the expectation of the public when it was announced that a key had been discovered which opened the portal to these long-concealed treasures. The result has not been correspondent. Only partial success has rewarded the labour which has been expended on the attempt to decipher the hieroglyphics; and what little light has been thus obtained is neither very valuable in itself, nor of very high promise in regard to what may yet be kept under clouds and shadows. Men of profound learning, great acuteness of mind, and distinguished reputation have engaged and persevered in the inquiry: it is impossible to study without advantage the writings of such persons as Zoega, Akerblad, Young, Champollion, Spahn, Seyffarth, Kosegarten, Rühlé; and equally ungrateful would it be to affirm that no progress has been made in the undertaking; but, after all, the conclusions and positions which have been drawn and set forth are only in a few cases (comparatively) definite and unimpeachable (Heeren, *Ideen*, ii. 2, 4; Quatremère, *Recherches sur la langue et la littérature de l'Égypte*).

The little that was known in classical times on the subject of the hieroglyphics is found in a few passages of a few Greek writers (Herod. ii. 36; Diod. Sic. lxxxi. 3, 4; Clem. Alex. *Strom.* v.), the very import of which was, if at all, very imperfectly understood till recent investigations threw the light of fact upon their words. A brief exposition will put the reader into possession of the most important truths connected with the subject. We premise, however, that unanimity by no means prevails among the writers who have a right to be considered as authorities.

The knowledge of hieroglyphics which we at present possess owes its origin to the Rosetta

stone, which is now in the British Museum. This stone was found by the French among the ruins of Fort St. Julien, which is situated near the mouth of the Rosetta branch of the Nile, and was given up to the English in accordance with the terms of the treaty of Alexandria. It is sup-



272. The Rosetta Stone, with specimens of the characters 1, 1'. Sacred; 2, 2'. Enchorial; 3, 3'. Greek.

posed to have been sculptured about B.C. 195, and contains a decree in honour of Ptolemy V. (Epiphanes) written in three different characters. One of these is Greek, and a part of it has been explained to state that the decree was ordered to be written in Sacred, Enchorial, and Greek writing. Dr. Young was the first that attempted to decipher this inscription; in which he partially succeeded by counting the recurrence of the more marked characters in the hieroglyphics, and comparing them with those that occurred about the same number of times in the Greek. Champollion and Wilkinson have followed up Dr. Young's discoveries with great ingenuity, and we can now partially read inscriptions which before were wholly unintelligible to us. Among other obstacles, however, this remains in the way, viz., that the Rosetta stone was sculptured about 195 B.C. and in Lower Egypt; while the major part of the inscriptions were written during the twelve previous centuries, and are found in Upper Egypt. Hieroglyphics are written either from left to right or right to left; though sometimes the columns are so narrow that they may be almost said to be written from top to bottom. They are partly pictorial; thus 'ox,' 'goose,' 'temple,' are represented by pictures or pictorial symbols of an ox, &c. At other times they are phonetic, and written by an alphabet of about 140 letters, of which many are synonymous; some being adapted for writing, others for sculpture; some in use at

an earlier period, others at a later. The powers of these letters are determined by the names of the kings in which they are found; but as this cannot be done very exactly, they are generally arranged under about twelve of our primary letters. We cannot, however, distinguish accurately between the vowels, or *r* and *rn*, and other cognate letters. The names of sovereigns are always written within a ring or cartouche: those of any other person are distinguished by a sitting figure following them: besides these, there is nothing to mark the difference between a letter and a pictorial symbol. In some words the meaning is expressed twice; once by a phonetic combination; and again, by a pictorial symbol; in others the more important part is symbolical, and the grammatical termination is spelt. Sometimes also we find a species of abbreviation; thus the word *ox* would be expressed by the first letter of the Coptic word signifying *ox*.

It is manifest that the hieroglyphics which were either purely pictorial or symbolic would be inadequate to express every part of speech. Every language must, except at its very commencement, have some words which, taken alone, are void of meaning; and unless those who speak it are entirely separated from other nations, they must have occasion to express foreign names and terms in their own tongue, and write them in their own character, if they are sufficiently advanced in civilization to possess the art of writing. Now the Egyptians, at the period from which their existing monuments can be dated, were the most civilized nation on earth, and, though debarred from trading with foreigners before the time of Psammeticus, they were often at war with their southern and eastern neighbours. Their language then must have possessed such terms as could be expressed only by characters which stood for sounds, and this necessity may be supposed to have given rise to a third kind of hieroglyphics, called by M. Champollion phonetic. That a certain number were so employed is beyond a doubt, and the principle on which these figures were selected for that purpose has probably been ascertained; it was apparently this, that the names of things (*i. e.* the words) suggested by these hieroglyphics began by the sound or letter which they were taken to represent. Thus an eagle, which in Egyptian or Coptic is *abom*, expressed the letter *a*; a censer, in Egyptian *berbe*, the letter *b*, and so on. This principle being admitted, it follows that the number of figures used to represent one sound might be increased almost without limit, as any hieroglyphic might stand for the first letter of its name; but so copious an alphabet would have been, even to a native, a constant source of error. The characters, therefore, so employed were soon fixed; and, as far as has been hitherto ascertained, eighteen or nineteen was the largest number assigned to any one letter, while some have only one or two. By this variety the Egyptians were able to exercise a faculty held in high esteem among their eastern neighbours—that of conveying a double meaning by the same sign, and of expressing covert allusions not generally comprehensible. Thus the lion is put for the *l* in Ptolemy and Alexander, because they were powerful kings; the ram for the *b* in Anubis, because it was sacred to that god, &c.

But for the purpose of writing, strictly so called, there was a less ornamental and more rapid way of forming the characters, which is always found in the MSS., and which would be the natural consequence of using a pen or stylus. This is called by Strabo and Pliny hieratic writing, the hieroglyphics being, as the name imports, peculiar to sculpture. It is chiefly by means of the hieroglyphics that we are enabled to read the hieratic writing, the latter being, for the most part, an abbreviated way of writing the former. The Rosetta stone contained the inscription in yet another set of characters, the demotic or enchorial. It is to Dr. Young that we owe the greater part of our knowledge on this subject. He was greatly assisted by the discovery of two or three papyri written in this character with Greek translations, the earliest of which dates in the reign of Psammeticus about *b. c.* 650. An alphabet has been formed from Greek proper names; from which it appears that the few words which we can decipher are Coptic. In this writing the hieroglyphics have almost wholly disappeared, though some still appear scattered here and there.

The last statement worthy of attention which has come under the writer's notice in connection with hieroglyphics is that of Wathen (*Arts, Antiquit. and Chron. of Egypt*, p. 1, sqq.), who thinks he has discovered that the construction of the hieroglyphic 'names and standards' of the ancient monarchs bear a resemblance to the quartering of arms in modern heraldry. Hence

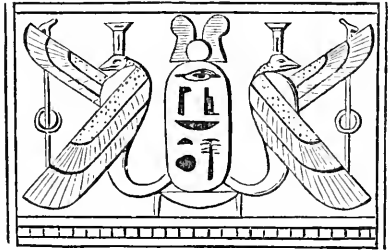

273.

from the names and standards of a king we may often learn his extraction, paternal and maternal, and, when not descended from the reigning family, what his claim was to the throne. This writer also holds that different physiognomies, each characteristic of a different royal family, are distinctly traceable in the portraits of the kings preserved on the walls of the ancient monuments. 'The Egyptian physiognomy, the Ethiopian, and the mixture of the two, may each be plainly recognised. Even the characteristic lineaments of the different families purely Egyptian are accurately given.' 'The facts,' he continues, 'deducible from these two sources confirm and illustrate each other. Together, they throw a new light on the whole period of monumental history, commencing within a few centuries of the flood; render plain and certain what was before doubtful and obscure in notices of ancient Egypt scattered in sacred and profane history, and furnish a clue to the mazes of the Manethonian dynasties.'

The difficulties that oppose the formation of a

satisfactory Egyptian chronology are great and numerous. The most distinguished writers differ egregiously in their statements. Newton places Shishak about the middle of the tenth century before our era; Usher fixes him at B.C. 1489. One chronologer determines the epoch of Menes, first king of Egypt, at about B.C. 2231; Champollion deduces from the same authorities that he lived 6000 years before Mohammed. Every Egyptian monarch had several names. The writings which we possess on Egyptian history are either fragments, or mutually conflicting, or of too late a date to be of great value. The copyists of Manetho give diverse reports of what they profess to quote from his work. Mythology is blended with history, theory with fact, and mere conjectures and plays of the fancy are reported with a gravity of manner which is surpassed only by the credulity to which they owe their birth and their currency.

Various efforts, however, have been made to remove difficulties, reconcile contradictions, and harmonize dissonances. The success has been far from distinguished. Sharpe, in his *Early History of Egypt*, has laboured for this purpose by contracting the ordinary chronological period, and by the hypothesis of several contemporaneous dynasties, ruling in Lower or in Upper Egypt. The earliest event which he seems to admit, as ascertained with exactness, is the capture of Jerusalem by Shishak, in the fifth year of king Rehoboam. B.C. 970. Wathen (*ut supra*), availing himself of the discoveries made by others and by himself, in decyphering the sculptured language of the ancient monuments, has, in his own opinion, gone far to clear away previously existing difficulties, to bring the fragmentary accounts of ancient writers into accordance, and to offer to the world a definite, consistent, and trustworthy Egyptian chronology. The author (p. 75) lays considerable stress on the fact that, in almost every instance, when Hebrew history is interwoven with Egyptian, the chronology which he has developed harmonizes with that of the sacred writers as determined by Archbishop Usher in the English Bible. 'Thus Usher's date for Peleg, in whose days the earth was divided (1 Chron. i. 19) is B.C. 2247; that of Menes, the first king of Egypt, is here fixed at B.C. 2222.' Other correspondencies are the Exodus, English Bible, 1491; Wathen, 1489; Shishak's capture of Jerusalem, 971; his accession, according to Wathen, 990; Pharaoh-Necho slew Josiah, 610; his accession, 618. On which it seems sufficient to remark that, even taking these and the one or two other statements made by the author on the point, to be as he has set them forth, they neither do nor can effect much for fixing with certainty historical events, so long as doubts are entertained whether Usher's chronology itself is correct, and so long as uncertainty prevails generally in relation to the strict chronological period of the Old Testament history [CHRONOLOGY].

What, however, we know to be definite, and believe to be accurate in its disclosures, and what we judge to be far more important in an historical relation, is to be found in the paintings and sculptures with which the Egyptians left the walls of their tombs and temples decorated in forms and colours which have not yet faded from the sight. It is true that these instances of real picture writ-

ing may do little for fixing the epoch of the accession of a king or the termination of a dynasty. Yet in this they are not entirely mute. Among

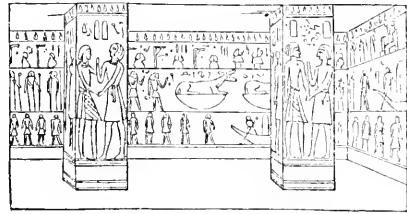

274. [Interior of Pictured Tomb.]

the innumerable mural sculptures in the temple at Karnak, Champollion discovered one in which a king, Sheshonk (Shishak), is presenting captives of various nations to his God as trophies of victory. One of these, distinguished by a long beard and Jewish physiognomy, bears the hieroglyphical title Yondah Malek, king of Judah. But for any practical purpose, the determination of a date, or the identification of an event, is of small comparative moment; and far too much importance has been attached to mere chronological details. To learn when an Egyptian or Chinese king ascended the throne, or departed this life, may gratify the antiquary or even reward much learned toil, but the world at large has an interest in history in the main, if not exclusively, so far as it discloses what men thought, felt, did; what they hoped, feared, and achieved in the days of old; thereby affording to posterity warnings, encouragement, light, and impulse. Now for these highly important purposes the most abundant materials are presented in Egypt, and may be found described in the works of Champollion, Wilkinson, and others. Let any one visit the Egyptian gallery in the British Museum, and he will be surprised and delighted to find Egypt almost resuscitated. The tombs have given up their dead. Buried treasures, over whose silence centuries had rolled before our era began, crowd on the sight and gratify the mind. And paintings, too, strike the eye, which may not indeed conform very exactly to the laws of perspective, but which lay open, and set before the spectator, the Egyptian, as he was in the days of his glory and pride. Indeed, from the paintings and sculptures which have been discovered and described, we are enabled to follow this most singular and deeply interesting people through all the classes of society, through all the operations of science and husbandry, into the transactions of public life, the details of house-keeping, the achievements of war, the amusements of hunting, fishing, feasting, and the solemn rites of a most august and imposing religious ceremonial.

Amid the various profane authors who have written more or less in detail on Egypt (see a list of them in Shaope's *Early History of Egypt*, London, 1836 p. 3), and after all the labour that has been bestowed on the attempt to decypher the hieroglyphics, the Bible remains our best and fullest authority for the early history of the country. This history, it is true, is not presented in a chronological series of events, nor supplied respecting any period with nice exactitude and minute details. The disclosures made by inscriptions on public buildings, of kings, wars, and

conquests, may, when verified as to age, and placed in their probable order by the aid of learning and criticism, reveal more as to the dynasties and individual sovereigns; but on such information, even when free from doubt, and most accurate, little real value can be set; while the Bible supplies, either by express statement or obvious implication, facts and principles which constitute genuine history, and go far to give the past all the value which it can possess for the men of these times. And what makes these disclosures the more valuable is not only that they wear the character of genuine and uncorrupted history—free from the false, deep, and unnatural colourings of mythology; but that they relate to the earliest forms of civilized life, and to ages over which profane historians have left the thickest darkness. Narrations and implications, such as the Bible affords in regard to the early history of Egypt, want no corroboration; they wear in their naturalness, simplicity, and correspondence with what would be expected in the ages to which they refer, evidence that they represent actual realities, which none can resist who have studied either human nature or human society. Still it may not be supererogatory to remark that the little which learning and industry have succeeded in extracting from the monumental inscriptions, and the very great deal which funereal and religious paintings have of late made known; and, indeed all, from whatever source gathered, that we know of the country and its institutions and usages, are in entire harmony with what the Scriptures directly or indirectly teach respecting Egypt. More than one effort has indeed been made to corroborate the truth of Scriptural history, by setting forth a certain correspondency alleged to exist between the results of modern discovery, and dates and events found in the sacred volume. Nor would we deny that the time may arrive when such a correspondency will appear to rest on the surest vouchers, as in one or two instances it may do even in the actual state of knowledge. But chronology must assume a more definite and certain form before, whatever may be learnt from the monuments of Egypt, any historical relationship between the Bible and other sources of knowledge touching Egypt can be accurately ascertained and satisfactorily established. Meanwhile, by these imperfect attempts, even suspicion may be engendered, and certainly there is a risk lest the mind should be drawn off from a sphere of evidence which is no less striking than it is full and satisfactory. It is, we had almost said, enough, it is certainly a very great point to have ascertained beyond doubt that the Egypt of the Bible is Egypt indeed, not a fiction, nor an imposture, nor a blunder—as writers of the Voltaire school would persuade the world—but a reality, so far as it goes, a picture copied from actual life.

We learn from the Old Testament that while the Jews, the earliest nation that has handed down to us the history of its rise and civilization, were yet a tribe of wandering shepherds, under Abraham, depending solely upon the unbought gifts of nature, who, when they had exhausted one district, instead of cultivating it, drove off their flocks in search of a new pasture-ground, after the manner of the American Indians; the Egyptians were acquainted with agriculture and

all those arts of civilization and government which indicate a social existence, extending backwards for at least several ages. This is confirmed in a striking manner by architectural remains that have survived the ravages of above thirty centuries; for while the Israelites, under the immediate successors of Joshua, were still warring with the Canaanites for the possession of the land of promise, or yet earlier, while they were yet slaves in Egypt, that most interesting land was distinguished for palaces, temples, porticos, obelisks, statues, and canals, which declare that they had been preceded by a long period of civilization, and which still remain the admiration of the world. The pyramids of Lower Egypt, requiring for their erection the least quantity of architectural knowledge, no elegance of design, no taste in detail, might possibly have been the work of men driven by task-masters to their daily labour; but that the palaces, tombs, and temples of Upper Egypt, which present to us the earliest known instances of architecture, sculpture, and painting; the colossal statues of Amenoph and Rameses, requiring considerable anatomical knowledge for the original design, and a mechanical

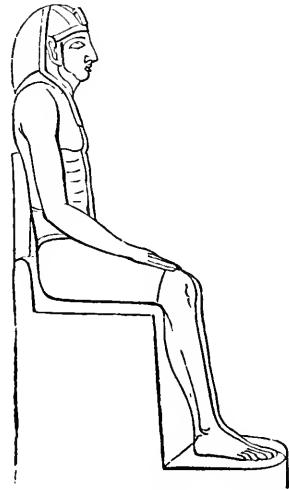

275.

skill in the execution, exceeding perhaps even that of the Greeks themselves; the vast works for irrigation; and the correct division of the calendar, implying great knowledge of mathematics—that these should have been the works of a people suffering under political disadvantages, and not far advanced in all the arts and refinements of social life, would contradict all that observation or history has made known. Some considerable degree therefore of political freedom, as well as a high cultivation, must at an early period have been enjoyed by the Egyptians.

In Gen. x. we find the colonization of Egypt traced up to the immediate children of Noah, for it is there stated that Mizraim was the second son of Ham, who was himself the second son of Noah. Immediately after these genealogical statements the sacred narrative (Gen. xii.) informs us that the patriarch Abraham, pressed by famine, went down (about b. c. 1920) into Egypt, where it appears he

found a monarch, a court, princes and servants, and where he found also those supplies of food which the well-known fertility of the country had led him to seek there; for it is expressly stated 'that the favour which his wife had won in the reigning Pharaoh's eyes procured him sheep and oxen, as well as he-asses, and men-servants, and maid-servants, and she-asses and camels. In Gen. xxi. 9, mention is made in the case of Ishmael, the son of Hagar the Egyptian, whose mother took him a wife out of the land of Egypt, of a mixed race between the Egyptians and the Chaldeans, a race which in after times became a great nation. From this mixture of races it has been supposed the Arabs (אֲרָבִים, 'mixed people') had their name (Sharpe's *Early Hist. of Egypt*, p. 11). In Gen. xxxix. begins the interesting story of Joseph's being carried down to Egypt, with all its important consequences for the great-grandchildren of Abraham. The productiveness of the country is the allurements, famine the impulse. Attendant circumstances show that Egypt was then famous also for its commercial pursuits; and the entire narrative gives the idea of a complex system of society (about B.C. 1720), and a well-constituted yet arbitrary form of government. As in eastern courts at later periods of history, elevation to high offices was marked and sudden. The slave Joseph is taken from prison and from impending death, and raised to the dignity of prime vizier, and is entrusted with making provision for an approaching dearth of food, which he had himself foretold, during which he effects in favour of the ruling sovereign one of the greatest revolutions of property which history has recorded. The high consideration in which the priestly caste was held is apparent. Joseph himself marries a daughter of the priest of On. Out of respect towards, as well as by the direct influence of, Joseph, the Hebrews were well treated. The Scriptural record, however, distinctly states (xli. 34) that before the descent of Israel and his sons 'every shepherd' was 'an abomination unto the Egyptians.' The Hebrews, whose 'trade had been about cattle,' must have been odious in the eyes of the Egyptians, yet are they expressly permitted to dwell 'in the best of the land' (xlvii. 6), which is identified with the land of Goshen, the place which the Israelites had prayed might be assigned to them, and which they obviously desired on account of the adaptation of its soil to their way of life as herdsmen. Having settled his father and family satisfactorily in the land, Joseph proceeded to supply the urgent wants of a hungry nation, and at the same time converted the tenure of all property from freehold into tenancy-at-will, with a rent charge of one-fifth of the produce, leaving their lands, however, in the hands of the priests; and thus he gave another evidence of the greatness of their power.

The richness of Goshen was favourable, and the Israelites 'grew and multiplied exceedingly,' so that the land was filled with them. But Joseph was now dead; time had passed on, and there rose up a new king (probably one of a new dynasty) which *knew* (Exod. i. 8) not Joseph, having no personal knowledge, and it may be no definite information of his services: who, becoming jealous of the increase of the Hebrews, set about persecuting them with the avowed intention of diminishing their numbers and crippling their

power. Severe task-masters are therefore set over them; heavy tasks are imposed; the Hebrews are compelled to build 'treasure cities, Pithom and Raamses.' It is found, however, that they only increase the more. In consequence, their burdens are doubled and their lives made bitter with hard bondage (Exod. i. 11), 'in mortar and in brick, and in all manner of service in the field.' Their first-born males, moreover, are doomed to destruction the moment they come into being. The deepest heart-burnings ensue; hatred arises between the oppressor and the oppressed; the Israelites seek revenge in private and by stealth (Exod. ii. 12). At last a higher power interferes, and the afflicted race is permitted to quit Egypt. At this time Egypt appears to have been a well-peopled and well-cultivated country, with numerous cities, under a despotic monarch, surrounded by officers of his court and a life-guard. There was a ceremonial at audience, a distinction of ranks, a state-prison, and a prime minister. Great buildings were carried on. There was set apart from the rest of the people an order of priests who probably filled offices in the civil government; the priest of Midian and the priest of On seem to have ruled over the cities so named. There was in the general class of priests an order—wise men, sorcerers, and magicians—who had charge of a certain secret knowledge: there were physicians or embalmers of the dead; the royal army contained chosen captains and horsemen and chariots. The attention which the people at large paid to agriculture, and the fixed notions of property which they in consequence had, made them hold the shepherd or nomade tribes in abhorrence, as freebooters only less dangerous than hunting tribes.

The ill feelings which the peculiar circumstances connected with the exode from Egypt had occasioned served to keep the Israelites and the Egyptians strangers, if not enemies, one to another during the lapse of centuries, till the days of David and Solomon, when (1 Kings iii., vii., ix., xi.) friendly relations again spring up between the two countries. Solomon marries the daughter of a Pharaoh, who burns the city of Gezer, and who in consequence must have been master of Lower Egypt. 'And Solomon had horses brought out of Egypt, and linen yarn: six hundred shekels of silver was the price of a chariot, and one hundred and fifty the price of a horse. Jeroboam, however, who 'had lifted up his hand against the king,' and become subsequently monarch of the revolted ten tribes, found refuge and protection in Egypt, which was then (about B.C. 975) governed by *Shishak*. From 2 Chron. xii. it appears that in the fifth year of Solomon's successor, Rehoboam, this same *Shishak* 'came against Jerusalem' with a very large army, consisting of chariots, horse and foot soldiers, besides auxiliary foreigners, and having captured the fortified cities which lay on his march, he entered and plundered the metropolis. The language which is employed in Joel (iii. 19) shows that, in the ninth century before Christ, Egypt had, in conjunction with Edom, displayed both its power and its cruelty towards the kingdom of Judah. The rise and oppressiveness of the Assyrian power soon, however, inclined the Egyptians and the Israelites, from a sense of common danger, to cultivate friendly relations with one another. In

2 Kings xvii. we find that in the twelfth year of Abaz king of Judah (b.c. 730) Hoshea king of Israel desisted from paying his usual tribute to the king of Assyria, and courted the alliance of So, king of Egypt, who must have been a very powerful monarch to have been thought able to give assistance in opposition to Assyria. Against this mere human resource the prophet Isaiah (xxx.) warmly protested, declaring its utter inefficiency, and striving to lead his countrymen to the practice of that righteousness and piety by neglecting which they had been forsaken of God. Upon this act of king Hoshea, however, the Assyrians overran Samaria and carried (2 Kings xvii. 6) Israel away into Assyria. In the reign of Zedekiah (b.c. 726) it appears (2 Kings xviii. 21) that the kingdom of Judah still 'trusted upon the staff of this bruised reed, even Egypt, on which if a man lean, it will go into his hand and pierce it: so is Pharaoh king of Egypt unto all that trust on him.' In the last year of the reign of Josiah (b.c. 609) Egypt seems to have attempted to increase its influence in Palestine, when Pharaoh-Nechoh (2 Kings xxiii. 29) 'went up against the king of Assyria to the river Euphrates,' and Josiah going against him was slain in battle. His successor, Jehoahaz, was dethroned after a brief reign of three months, and imprisoned at Riblah by the Egyptian monarch, who imposed on the country a heavy tribute. Pharaoh-Nechoh then made his elder brother Eliakim king, having changed his name to Jehoiakim. Jehoahaz afterwards died in Egypt. But the Egyptian influence over Judah soon ended; for in the fourth year of Jehoiakim (b.c. 604) Nebuchadnezzar king of Babylon marched against (Jer. xli., 2 Kings xxiv.) Judæa and its allies, defeated Pharaoh-Nechoh, and retook from the Egyptians Arabia Petraea and all that belonged to them between the Euphrates and the Nile. Zedekiah, the next king of Judah, rebelling against Nebuchadnezzar, made an alliance with Pharaoh-Hophra (Jer. xliv.); and when Nebuchadnezzar besieged Jerusalem, on the march of the Egyptian army, the Chaldees raised the siege (Jer. xxxvii. 5) and withdrew the army. But this was the last time that the Egyptian power was able to serve the Jews. The Assyrian party in the state, indeed, was in the minority, though assisted by the influence of Jeremiah and Ezekiel (Ezek. xxix., Jer. xxv.); yet it predominated; the Jews were carried captive to Babylon, and in less than a century afterwards Egypt was made a province of the same empire.

After the time of the exile the Egyptian Ptolemies were for a long while (from b.c. 301 to about 180) masters of Palestine, and during this period Egypt became as of old a place of refuge to the Jews, to whom many favours and privileges were conceded. This shelter seems not to have been for ages withdrawn (Matt. ii. 13). Yet it cannot be said that the Jews were held in esteem by the Egyptians (Philo, *c. Apion.* ii. p. 521). Indeed it was from an Egyptian, Manetho (b.c. 300), that the most defamatory misrepresentations of Jewish history were given to the world; and, in the days of Augustus, Charemon took special pains to make the Jewish people appear despicable (Joseph. *c. Apion.* i. 32; comp. Creuzer, *Com. Herod.* i. 270).

In the reign of Ptolemy Philometor, Onias,

whose father, the third high-priest of that name, had been murdered, fled into Egypt, and rose into high favour with the king and Cleopatra his queen. The high-priesthood of the temple of Jerusalem, which belonged of right to his family, having passed from it to the family of the Maccabees, by the nomination of Jonathan to this office (b.c. 153), Onias used his influence with the court to procure the establishment of a temple and ritual in Egypt which should detach the Jews who lived there from their connection with the temple at Jerusalem. The king complied with the request. To reconcile the Egyptian Jews to a second temple, Onias alleged Isa. xix. 18, 19. He chose for the purpose a ruined temple of Bubastis, at Leontopolis, in the Heliopolitan nome, one hundred and fifty stadia from Memphis, which place he converted into a sort of miniature Jerusalem (Joseph. *De Bell. Jud.* i. 1), erecting an altar in imitation of that in the temple, and constituting himself high-priest. The king granted a tract of land around the temple for the maintenance of the worship, and it remained in existence till destroyed by Vespasian (Joseph. *Antiq.* xiii. 3; xx. 9; *De Bell. Jud.* vii. 11). The district in which this temple stood appears to have been, after Alexandria, the chief seat of the Jews in Egypt, and which from the name of its founder was called 'Ὀνίου χώρα' (Joseph. *Antiq.* xiv. 8; Helon's *Pilgrim.* p. 328).

If, instead of taking the sacred volume for our guide, we consult profane authors, only a few general conclusions can be given with any degree of historical truth and well-grounded confidence. 'The earliest history,' says Winer, (*Bib. Realwörterb.* in loc.) 'of Egypt is altogether legendary till we come to the age of Sesostris. With this monarch, who was also named Rameses, begins the half-mythical half-historical period of great revolutions and august edifices (Heeren, *Ideen*), and lasts till the time of Psammetichus, about 700 years before Christ. Then, and not before, credible history begins. Originally several sacerdotal governments appear to have co-existed, among which that of Memphis was, though not the oldest, yet the most influential. Then Lower Egypt was invaded by certain nomade hordes from the east, who spread as far as Memphis, of which city they became masters, and founded a dynasty of shepherd kings (Hyksos). The states of Upper Egypt succeeded in driving these foreigners out of the land; that of Diospolis gained the ascendancy, whose king was the celebrated Sesostris—probably b.c. 1500-1400. In the eighth century before Christ the Ethiopians invaded Upper Egypt, and ruled there with mildness and wisdom, whilst two other dynasties, a Saitic and a Tanatic, flourished in Lower Egypt. A civil war converted Egypt into a state under twelve princes. Psammetichus, one of these twelve, supported by foreign mercenaries, succeeded in making himself sole monarch, and opened to strangers the hitherto closed country. The history now becomes clear. From 526 before our Lord Egypt became a Persian province, fell (b.c. 332) into the hands of Alexander the Great, and after his death (b.c. 323) the dynasty of the Ptolemies established itself, which (a. v. c. 723) came to a termination at the battle of Actium.'

The ascertained correspondencies in respect of monarchs found alike in sacred and profane his-

toiy are not numerous. The following monarchs have been identified (Sharpe's *Early Egypt*, p. 26), Shishak (2 Chron. xii.) with Sesostris (b.c. 983); Pharaoh-Nechoh (2 Kings xxiii.) with Necho II. (b.c. 616); and Pharaoh-Hophra (Jer. xlii.) with Apries (b.c. 591).

On few historical points have more various or conflicting opinions been held than respecting the Hyksos or shepherd kings. Who were they? When did they rule? When were they expelled? Were they the same as the Israelites? are questions which have received at the hands even of profoundly learned men very different answers. Nor in so debated a case should we here venture an opinion did we not feel that the view we take has an important bearing on the origin of some part of the religion of the Egyptians.

Manetho makes his fifteenth dynasty to consist of the Phœnician shepherd kings. 'In the reign of King Timeus,' he says, 'there came up from the east men of an ignoble race, who had the confidence to invade our country, and easily subdued it without a battle, burning the cities, demolishing the temples, slaying the men, and reducing the women and children to slavery.' They made Salatis, one of themselves, king: he reigned at Memphis, and made the upper and lower region tributary. Of his seventeenth dynasty also were forty-three shepherd kings, called Hyksos, who reigned, perhaps contemporaneously with the preceding, at Diospolis. In the eighteenth dynasty of Diospolis a rising took place, and the shepherd kings were expelled out of the other parts of Egypt into the district of Abaris, which they fortified. Amosis besieged and compelled them to capitulate; on which they left Egypt, in number 240,000, and 'marched through the desert towards Syria, and built the city of Jerusalem.' The last few words seem to render it probable that Manetho confounded the Hyksos with the Israelites, which is the less surprising since the Hyksos were, as he rightly calls them, Phœnicians, of the ancient, if not original, race which inhabited Phœnicia, or Palestine (taken in its widest sense), before the conquest of the country by the Hebrews. Chronological considerations seem to refer the time of the dominion of the Hyksos to the period of Abraham and Joseph (say from b.c. 2000 to 1600). When Joseph went into the land he found the name of shepherd odious—which agrees with the hypothesis that places the irruption of the shepherd kings anterior to his time; and possibly both the ease with which he rose to power, and the fact that Jacob turned towards Egypt for a supply of food when urged by want, may be readily accounted for, on the supposition that a kindred race held dominion in the land, which, though hated by the people, as being foreign in its origin and oppressive in its character, would not be indisposed to show favour to members of the great Shemitic family to which they themselves belonged. The irruption into Egypt, and the conquest of the country on the part of the Phœnician shepherds, seems to have been a consequence of the general pressure of population, from the north-east towards the south-west, which led the nomade Shemitic tribes first to overcome the original inhabitants of Palestine, and, continuing in the same line of advance, then to enter and subdue Egypt. The invasion of the Hyksos is indeed to be regarded as one result of the movement from

the Euphrates westward of the most powerful and (comparatively) most civilized people then found in Western Asia, who in their progress subdued or expelled in the countries through which they not improbably were urged by a pressure from other advancing tribes, nation and tribe one after another, driving them down toward the sea, and compelling those who dwelt along the shores of the Mediterranean, to seek shelter and safety in the islands of that sea and other distant parts. To conquerors and aggressors of the character of these shepherd hordes Egypt would offer special attractions. They continued sweeping onwards, and at last entered and conquered Egypt, establishing there a new dynasty, which was hateful, because foreign, and because of a lower degree of culture than the Egyptians themselves had reached. Nor would these shepherds be less odious because, coming from the east and immediately from the deserts of Arabia, they came from the quarter whence the mild and cultivated Egyptians had long been wont to suffer from the predatory incursions of the wild nomade tribes (*Die Phœnizier*, von Movers, Bonn, 1841; *Zur Geschichte der Israeliten*, von E. Bertheau, Göttingen, 1842), between whom and the agricultural natives of the country different pursuits, habits, and tastes would naturally engender animosities. This feeling of alienation exists at the present day. The Arab is still a depressed and despised being in Egypt. Bowring, in his valuable Report on the country, remarks, 'It is scarcely allowable even to send a message to a person in authority by an Arab servant.' (p. 7.)

The expulsion of the shepherds was strangely confounded by Josephus or Manetho with the Exodus of the Israelites. The shepherds were conquerors, rulers, and oppressors; the Israelites guests and slaves. The shepherds were expelled, the Israelites were delivered. Josephus (c. *Apion*. i.), however, gives from Manetho a narrative of an event which wears a much nearer likeness to the Exodus, in the case of a King Amenophis, who was ordered by the gods to cleanse Egypt of a multitude of lepers and other unclean persons; many of whom were drowned, and others sent in great numbers to work in the quarries which are on the east side of the Nile. After a time they were permitted to establish themselves in Avaris, which had been abandoned by the shepherds. They then elected a ruler, Osarsiph, whose name was afterwards changed to that of Moses. This chief 'made this law for them, that they should not worship the Egyptian gods, but should kill the animals held sacred by the Egyptians; nor were they to have intercourse with any but such as were members of their own body—in all respects aiming to oppose the customs and influence of the nations. These, sending for aid to the shepherds who had settled in Jerusalem, and having received troops to the number of 200,000 men, were met by Amenophis, the king, with a yet larger force, but not attacked. On a subsequent occasion, however, they were assailed by the Egyptians, beaten, and driven to the confines of Syria.' Lysimachus gives an account not dissimilar to this, adding, that under the leadership of Moses these mixed hordes settled in Judæa (Cory's *Ancient Fragments*). The account which Diodorus gives of the migration of the Israelites from Egypt to Palestine is

of a similar tenor. The deviations from the sacred narrative may be easily accounted for by Egyptian ignorance, vanity, and pride.

Wathen, following his own chronology, refers the great works existing in Egypt to three periods, separated by intervals of several centuries. 'The first includes the two great dynasties of Theban princes who governed Egypt during her "most high and palmy state," when Thebes sent forth her armies to distant conquests. In the second period is comprised the erection of the pyramids. The third includes the reigns of the Ptolemies and earlier Cæsars, under whom Egyptian architecture flourished in a second youth, and almost attained its original splendour.' On the chronology, however, of the fine arts in Egypt, as well as on so many other points, different, not to say opposite, opinions are held; for instance, the erection of the pyramids, which Wathen thus brings down into his second period, others refer back to the early dawn of its history. This is not the place to state, much less discuss, the diversities which present themselves to the student; our purpose will be answered by some general details as to the extent and character of the sublime creations of art in Egypt—of that wonderful country, the most wonderful monuments.

In regard to style, that remained essentially the same, in principles and character, from its first appearance ('in the seventeenth century before our era'—Wathen) to its final downfall, on the introduction of Christianity; though ornamental members were in later times modified, elaborated, and improved, and some entirely new added. Many of its peculiarities may have been borrowed from large architectural excavations. One of the most striking peculiarities of the style is the pyramidal character of the ascending lines. The type of the architecture was the primitive dwelling formed of reeds, which abounded on the banks of the Nile. In one of the orders of the Pharaonic

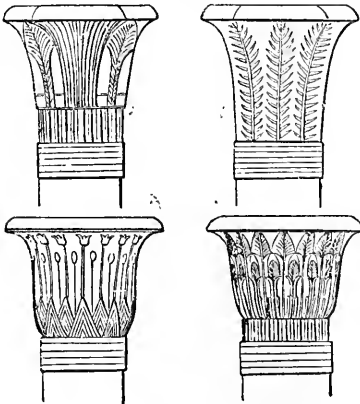

276.

columns, the original post of reeds may be said to have been translated into stone. If the constructions were of any great height, their stability, as being originally built of reeds, would, it is evident, require them to incline one to the other, sloping inwards, thus forming the pyramidal outline to which reference has been made. The plan of the Egyptian temple appears to have

originated in the practice of extending the structure by successive additions till the original form became the mere nucleus of the whole. First, a large pylon, consisting of two broad towering masses of masonry, with a doorway in the middle, was erected in advance to give greater dignity to the approach. This was united to the original building by lateral walls, fronted internally by colonnades; and thus the intermediate space was converted into a cloistered court, solemn and secluded, well agreeing with the dark and mysterious character of the national religion. A succeeding monarch would add a grand hall of columns in advance of, and attached to, this court; and a third, not less anxious to honour the gods and immortalize his name, erected a second quadrangle before the hall, terminating the whole range of buildings with a stupendous pylon which bore his inscriptions; and, if he were a warrior, offered a grand field for the sculptured display of his achievements.

The most brilliant periods of Egyptian art were the reigns of the second and third Rameses. Most of the obelisks and colossal statues were wrought before or during the reign of Rameses II., the Sesostris of the Greek writers. Under this enterprising monarch, the ancient Theban empire attained its highest pinnacle of prosperity and power. Rameses III. undertook distant military expeditions, roused the energies of the country, encouraged art, and erected the splendid temple of Medinet Abu. At a later age the sceptre of Egypt was swayed by powerful monarchs, who built on a grand scale; but the seat of the government was then in the Delta, and there remain only a few obelisks.

The valley of the Nile is all along at intervals strewn with wrecks of ancient monumental grandeur; at Thebes, however, they are found on both sides of the river in greatest profusion. Next to the pyramids, the most wonderful relic of Egyptian art is the great hall of the temple of Carnak, on the east bank of the Nile. Its superficial area is 314 feet by 164. The massive stone roof is supported by 134 columns ranged in sixteen rows, most of which are 9 feet in diameter, and nearly 43 feet high: those of the central avenue are not less than 11 feet 6 inches in diameter, and 72 feet high; the diameter of their capitals at their widest spread is 22 feet. The walls, columns, architraves, ceilings, every surface exposed to the eye, is overspread with intaglio sculptures—gods, heroes, and hieroglyphics, painted in once vivid colours. But the hall of columns was but a part of this wonderful fabric. Immense pylons, half-buried quadrangles and halls, granite obelisks, and tremendous piles of fallen masonry once formed a range of buildings upwards of 1200 feet in length. An avenue of colossal sphinxes led from the temple to Luxor, forming a vista which extended nearly a mile and a half, and was admirably adapted for the pageantry of religious processions. All these buildings formed parts of one magnificent whole; all were constructed of gigantic blocks, and most were covered with sculpture. 'Such was the imperial palace of the Pharaohs when Europe was yet in primeval barbarism, ages before Romulus took his omen on the Palatine hill.' Now the ruins are strewn in chaotic confusion over a sandy plain, broken into shapeless mounds.

Among the most remarkable works of the Egyptians must be ranked the vast sepulchres excavated in the seclusion of the Theban mountains to receive their dead monarchs. 'It was,' says Wathen, 'about an hour before sunset one evening that I set out to visit this Necropolis, intending to pass the night in one of the royal sepulchres. On approaching the gorge, the first thing that struck me was the quantity of bones, fragments of mummies, rolls of mummy cloth, and other relics of rifled (Egyptian) tombs that strewed the ground. Princes, priests, and warriors, after reposing thousands of years, are now dragged forth by poor peasants, and their bones lie scattered before the doors of their sepulchres. Candles were lighted: I passed the threshold, and looked round with silent wonder on the scene within. A large corridor or gallery ran

back hundreds of feet into the heart of the mountain, divided by lateral projections into lengthening vistas of apartments. The walls were elegantly adorned with columns of blue hieroglyphics on a white ground, 3000 years old, yet retaining almost the freshness of yesterday. In a large chamber at the end of the gallery was a massive sarcophagus. Here once lay the royal mummy, but it had long been open, and was empty. There are eight or nine of these large painted tombs in a group, besides others of less interest. They vary in length from 100 to upwards of 400 feet. In most, you find on entering a long descending corridor or gallery, running off in a straight line into the heart of the mountain. At its farther end the corridor expands into one or more large apartments, whose roofs are supported by massive piers of the living rock. The walls

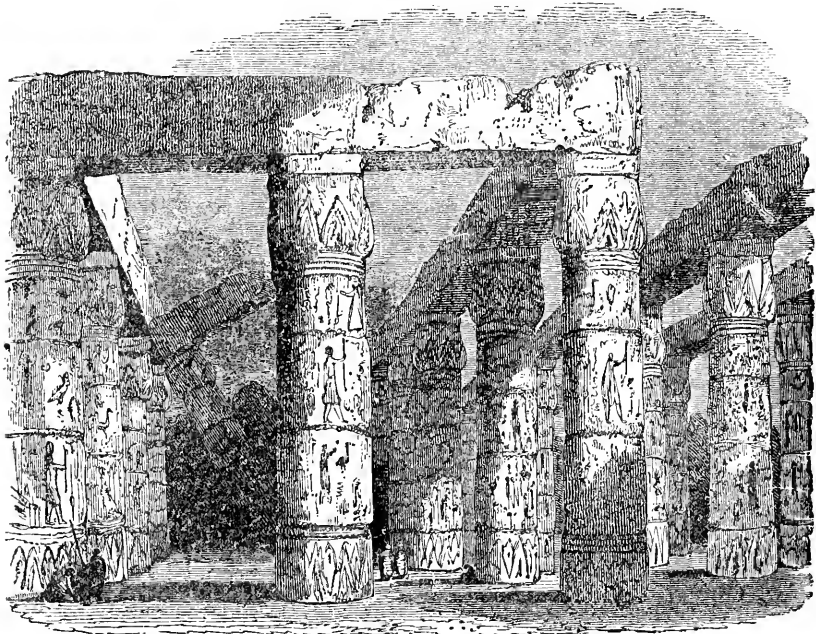

277. [Great Hall of the Temple of Carnak.]

and piers throughout are generally decorated with paintings still wonderfully retaining their freshness: the subjects are chiefly processions, religious rites, and allegoric and enigmatical devices.' The object seems to have been to enshrine the corpse deep within the earth in a mass of masonry, far from the stir of the living world. For these royal sepulchres of Thebes they first selected the loneliest ravine; for each tomb they carried a gallery deep into the hill, and then placed the corpse in the remotest part. But the tombs of the kings form only a part of this great city of the dead. The sides of the hills overlooking the plain and the ravines intersecting them, contain innumerable sepulchral excavations. One valley was appropriated to the queens, and in a remote corner the apes had a cemetery. The priests seized the best spots.

The purpose for which the pyramids were erected was once as little known as were most

other things connected with Egypt. It now appears satisfactorily ascertained that they were designed to be mausoleums; and what an idea does it give us of the grandeur of conception, the splendour in every respect of the monarchs to whom they owe their origin, that they should have devised and executed tombs so stupendous! 'On leaving the village of Gizeh, on the river bank opposite old Cairo (Memphis), the pyramids rise before you glittering white against the blue sky; but the flatness of the plain and the purity of the atmosphere effectually deceive the eye as to their distance and consequently their size: you almost appear at their base while several miles really intervene. As you advance gradually they unfold their gigantic dimensions; but you must have been some time on the spot, your eye must have repeatedly travelled along the great pyramid's 740 feet of base, and up its steep towering angles,

before you can fully understand its immensity, and the actual amount of labour involved in its erection' (Wathen). According to Pliny

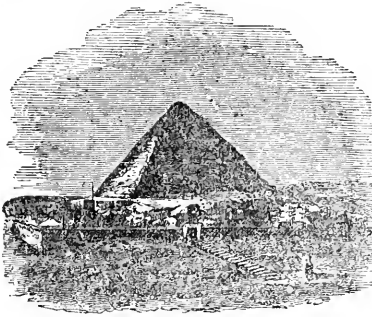

278. [Pyramid of Cheops.]

366,000 men were employed for 20 years in erecting the great pyramid, and Herodotus reports from an inscription which it bore, that the expense of providing the workmen with onions and other roots amounted to 1600 talents. Whole mosques have probably been built out of spoils from it alone. Yet the integrity of its form remains substantially unimpaired, and from a distance scarcely a trace of violence or decay can be seen. The existing masonry has been estimated at above six millions of tons, which was raised over an area of thirteen English acres and a half; and, supposing the cost of the structure to have been one shilling a cubic foot, including carriage, materials, and workmanship, the erection required an outlay of nearly five millions sterling. The original perpendicular height was 480 feet, exceeding that of St. Peter's by 43 feet, and that of St. Paul's by 110. The huge mass equalled a solid pile occupying the whole area of Lincoln's-inn-fields, and ascending to a point 100 feet higher than the top of St. Paul's.

If, as we have some reason to believe, and as the reader may see satisfactorily established in Movers and Bertheau (*ut supra*), a race of the Shemitic family, coming down from the upper (Aram) country into the lower (Canaan), in course of time subjugated Egypt and established their dominion, maintaining it for some five hundred years, such an historical event must have had a marked influence on the religion of the land. These invaders are described (Herod. ii. 128) as enemies to the religion of Egypt, who destroyed or closed the temples, broke in pieces the altars and images of the gods, and killed the sacred animals. Their influence on the Egyptian religion was, probably, not unlike that of the Persians on the Grecian, having for its aim and effect to discountenance and destroy a low and degrading system of idolatry; for the worship of the heavenly bodies, to which the Phœnician equally with the Persian invaders were given, was higher in its character and effects than the service of the ordinary gods of Greece, and still more so than the degrading homage paid by the Egyptians to the lowest animals. By this means the Shemitic religion exerted on the native Egyptian religion a decided and improving influence, which may be seen and traced in that element of the religion of Egypt which contains and presents the worship

of the heavenly bodies. The two systems, that of the Egyptians before it received inoculation from the East, and that of the Eastern invaders, agreed in this, that they were both the worship of the powers of nature; but they differed in this, and an important difference it was, that the Egyptians adored the brute creation, the Phœnicians, the host of heaven. Our limits forbid details on the subject, which, however, together with proofs and illustrations, may be found in the valuable works before mentioned. On the subject of Egyptian religion, besides the works already referred to, the following may be advantageously consulted. Paulty, *Real-Encyclopædie, Ägyptische Religion*; Prichard's *Egyptian Mythology*; Jablonski, *Pantheon Ägyptiacum*; *Beiträge zur Kenntniss der Lit. Kunst, Mythol. und Geschich. des alten Ägyptens*, von G. Seyffarth; *Untersuchung über den Mythos der beruh. Völker alter Welt*; Creuzer, *Symbolik*.

The relation in which the religion of Egypt stands to that of Moses is one of very considerable interest and importance, and one which has not yet received the kind and degree of attention which it merits. Michaelis (*Mosaisches Recht*), and others of the same school, have given valuable aid, but they wrote with, compared with what is now known, insufficient knowledge, if not with somewhat too much of a foregone conclusion. Other learned men, influenced by their philosophical notions, or prejudiced against the Hebrew religion, have made Moses a mere copyist of institutions and retailer of ideas which he found in Egypt. As a basis for such a view it was necessarily assumed that a purer system of religion was found in Egypt in the days of Moses than existed in any other part of the world. In particular, the Egyptian mysteries were set forth as the depositories of high and valuable religious doctrines. Scripture and history (the Acts of the Apostles; Josephus, Philo) were adduced to show that Moses had been instructed in this *prieestly lore*, and initiated into these mysteries; whence he was declared to have drawn his system of Monotheism, and even the characteristic name $\text{I}\Omega\text{}$, which he gave to the God whom he proclaimed, as alone worthy of the solemn title (Plessing, *Memnonium*, ii. 529; Schiller, *Die Sendung Moses*; Reinhold, *Die Hebräischen Mysterien*). These views, however, rest on no solid foundation whatever, if, indeed, they may not be to some extent considered as the illusory and almost posthumous offspring of the old and exploded notion which ascribed boundless knowledge to the ancient Egyptians. Nor can they for a moment be held in these days, after the light thrown on early Egypt by the monumental disclosures. The brief notion given above of the general characteristics of the earliest religion of the country, shows how utterly baseless such a theory is. In truth, the inhabitants of Palestine, so far back as we have been able to learn anything of them, seem to have possessed far better and purer religious opinions than those of the valley of the Nile, and in all probability did something to improve and elevate the religious system of the latter (Movers, *Phonizier*). The exposure of this sceptical hypothesis, which the Bible enables the scholar to supply, may be found in Vatke, *Die Religion des A. T. nach den Canon. Büchern entwickelt*, and Hengstenberg, *Die Authentie des Pentateuch*.

The subject of circumcision among the Egyptians has already been considered [CIRCUMCISION]. The pages of the present work afford ample evidences of the relation which Egypt bears to the Biblical History, and specimens of the light which the manners, customs, opinions, and buildings of the Egyptian people already throw, and of the fuller and clearer light which, as our knowledge advances, they are likely to throw, on the usages of the chosen people, and the pages of the sacred volume.

It may be proper to add that, since the above was written, we have read *Ancient Egypt, her Monuments, &c.* by George R. Gliddon; a work which gives a much more favourable account of the results of modern research into the Hieroglyphics than this article would seem to justify. The peculiarly advantageous position of the author of *Ancient Egypt*, as having lived above twenty years in the country, and being United States' consul for Cairo, makes his opinions on Egyptian antiquities worthy of great attention. Yet we cannot deny that his work has traces of being written in a partisan spirit. The reader, however, will be rewarded by perusing the production, since it presents (though not in the best style) a rapid sketch of the entire subject of Egyptian antiquities, written by a man intimately and in part personally acquainted with the points in question.

J. R. B.

EHUD (עֲהוּד; Sept. 'Αώδ), of the tribe of Benjamin, one of the 'Judges' of Israel, or rather of that part of Israel which he delivered from the dominion of the Moabites by the assassination of their king Eglon. These were the tribes beyond the Jordan, and the southern tribes on this side the river. Ehud obtained access to Eglon as the bearer of tribute from the subjugated tribes, and being left-handed, or rather ambidextrous, he was enabled to use with a sure and fatal aim a dagger concealed under a part of his dress, where it was unsuspected, because it would there have been useless to a person employing his right hand. The Israelites continued to enjoy for eighty years the independence obtained through this deed of Ehud (Judg. iii. 15-30).

EKRON (עֲקֵרוֹן; Sept. 'Ακκαρών), the chief of the five Philistine states (Josh. xiii. 3), and the northernmost of the five. In the general distribution of territory (unconquered as well as conquered) Ekron was assigned to Judah, as being upon its border (Josh. xiii. 3; xv. 11, 45); but was afterwards apparently given to Dan, although conquered by Judah (Josh. xv. 11, 45; xix. 43; Judg. i. 18; comp. Joseph. *Antiq.* v. 1, 22; v. 2, 4). In Scripture Ekron is chiefly remarkable from the ark having been sent home from thence, upon a new cart drawn by two milch kine (1 Sam. v. 10; vi. 1-8). In later days, it is named with the other cities of the Philistines in the denunciations of the prophets against that people (Jer. xxv. 29; Amos i. 8; Zeph. ii. 4; Zech. ix. 5). Eusebius and Jerome describe Ekron as a village of the Jews between Azotus and Jamnia towards the east, or eastward of a line drawn between these two places (*Onomast.* in 'Accaron'). The name of Ekron, or rather Accaron, occurs incidentally in the histories of the Crusades; and it has lately been recognised by Dr. Robinson (*Bib. Researches*, iii. 24) in that of

Akri, in a situation corresponding to all we know of Ekron. The radical letters of the Arabic name are the same as those of the Hebrew, and both the Christians and Moslems of the neighbourhood regard the site as that of the ancient Ekron. Akri is a small Moslem village, five miles south of Ramleh. It is built of unburnt bricks, and, as there are no apparent ruins, the ancient town was probably of the same materials. It is alleged, however, that cisterns and the stones of hand-mills are often found at Akri and in the adjacent fields.

ELAH (עֵלָה; Sept. 'Ηλά), son of Baasha king of Israel. After a reign of two years (b.c. 930-929) he was assassinated while drunk, and all his kinsfolk and friends cut off, by Zimri, 'the captain of half his chariots.' He was the last king of Baasha's line, and by this catastrophe the predictions of the prophet Jehu were accomplished (1 Kings xvi. 6-14).

ELAH, a valley in which the Israelites were encamped when David fought Goliath (1 Sam. xvii. 19). It doubtless received this name, which some spell Alah (which see), from the terebinth trees, or from some remarkable terebinth tree, growing in it. Ecclesiastical traditions identify it with the present valley of Beit Hamina, about eight miles north-west from Jerusalem. In this valley olive trees and carob trees now prevail, and terebinth trees are few; but the brook is still indicated whence the youthful champion selected the 'smooth stones' wherewith he smote the Philistine. The brook is dry in summer, but in winter it becomes a mighty torrent, which inundates the vale (*Pictorial Palestine*, p. 121). Dr. Robinson, however, disputes this ancient tradition, and finds that the conditions of the history require him to identify the valley of Elah with the Wady es-Sumt (acacia valley), which he crossed on the road from Jerusalem to Gaza, about eleven miles south-west from the former city. His reasons are given in *Biblical Researches*, iii. 350; and he remarks that the largest specimen of the terebinth tree which he saw in Palestine still stands in the vicinity.

ELAM (עֵלָם; Sept. 'Ελάμ), which is mentioned in Gen. x. 22, as a tribe descended from Shem, is, in ch. xiv. 1, introduced along with the kingdom of Shinar in Babylon, and in Isa. xxi. 2, and Jer. xxv. 25, is connected with Media. In Ezra iv. 9, the Elamites are described among the nations of the Persian empire; and in Dan. viii. 2; Susa is said to lie on the river Ulai (Eulæus or Choaspes) in the province of Elam. These accounts lead to the conclusion that Elam was the same land which was designated by the Greeks and Romans by the name of Elymais, and which formed a part of the ancient Susiana, the modern Khuisistan. This Susiana, which may thus be regarded as the Elam of Scripture, was bounded on the east by Persia Proper (ancient Persis, modern Fars), on the west by Babylonia (the Arabian Irak), on the north by Media, and on the south by the Persian Gulf. This country is not unfrequently regarded as a part of Persia Proper; but in the division of the provinces it was considered distinct from it, and constituted a peculiar satrapy, which was about half as large as Persia, and not quite as large as England. Elam was inhabited by various tribes of people. The Elymæi or Elamæi, together with the Kisi,

seem to have been the oldest inhabitants not only of Susiana Proper but also of Persia; whence the sacred writers, under the name of Elam, comprehended the country of the Persians in general. The Elamæi dwelt partly in the north and partly in the south of the country; and as they occupied the greater part of it, they were able to bring into the field a considerable body of troops, who were chiefly archers (Strabo, xv. 3, 10). It was in this capacity, indeed, as archers, that the other inhabiting tribes—the Uxii, the Kissi, the Cossæi—were chiefly celebrated; and hence the historical propriety of the Scriptural allusion to the quiver and the bow of the Elamites (Isa. xxii. 6; Jer. xlix. 31). Indeed, in the latter text the bow is distinctly mentioned as the chief instrument of Elamite power—‘I will break the bow of Elam, the chief of his might.’

It would seem that Elam was very early a separate state with its own kings; for in the time of Abraham we find that Chedorlaomer king of Elam extended his conquests west of the Euphrates as far as the Jordan and the Dead Sea (Gen. xiv.); but whether he acted for himself, or only as the viceroi or general of the Assyrians (as Josephus seems to intimate), must remain a matter of doubt. Ezekiel (xxvii. 24) mentions Elam among the mighty uncircumcised nations which had been the terror of the world; and about the same period (b.c. 590) Jeremiah threatened it with conquest and destruction by the Chaldeans (Jer. xlix. 30, 31, sqq.). This was accomplished probably by Nebuchadnezzar, who subjected Western Asia to his dominion; for we find his successor Belshazzar residing at Susa, the capital of Elam, a province then subject to that monarch (Dan viii. 1, 2; Rosenmüller’s *Biblical Geography*, &c.). With this the Scriptural notices of Elam end, unless we add that Elamites are found among those who were at Jerusalem at the feast of Pentecost (Acts ii. 9); which implies that Jews descended from the exiles were settled in that country. Here also they are mentioned next to the ‘Medians,’ with whom they are also coupled by the prophets (Isa. xxi. 2; Jer. xxv. 25); for which it does not appear necessary to seek any further reason than that, to the Jewish writers, Elam lay next beyond Media.

ELATH (עֲלָתַיִם), termed in the Sept. Αἰλάων; in Joseph. (*Antiq.* viii. 6, 4) Αἰλαθή; in Jerome, Ailah; by the Greeks and Romans, Ἐλάνα. It is now called Ailah. These several names are only variations of the original Hebrew word. It was a city of Idumæa, having a port on the eastern arm or gulf of the Red Sea, which thence received the name of Sinus Elaniticus (Gulf of Akaba). According to Eusebius, it was ten miles east from Petra. It lies at the extremity of the valley of Elghor, which runs at the bottom of two parallel ranges of hills, north and south, through Arabia Petræa, from the Dead Sea to the northern parts of the Elanitic Gulf.

The first time that it is mentioned in the Scriptures is in Deut. ii. 8, where, in speaking of the journey of the Israelites towards the Promised Land, these words occur—‘When we passed by from our brethren the children of Esau, which dwelt in Seir, through the way of the plain from Elath, and from Eziongeber.’ These two places were mentioned together again in 1 Kings ix. 26,

in such a manner as to show that Elath was more ancient than Eziongeber, and was of so much repute as to be used for indicating the locality of other places: the passage also fixes the spot where Elath itself was to be found: ‘and King Solomon made a navy of ships in Eziongeber, which is beside Elath, on the shore (Num. xxxiii. 35) of the Red Sea, in the land of Edom.’ The use which David made of the vicinity of Elath shows that the country was at that time in his possession. Accordingly, in 2 Sam. viii. 14, we learn that he had previously made himself master of Idumæa, and garrisoned its strong-holds with his own troops. Under his successor, Joram (2 Kings viii. 20), the Idumæans revolted from Judah, and elected a king over themselves. Joram thereupon assembled his forces, ‘and all the chariots with him,’ and, falling on the Idumæans by night, succeeded in defeating and scattering their army. The Hebrews, however, could not prevail, but ‘Edom revolted from under the hand of Judah unto this day;’ thus exemplifying the striking language employed (Gen. xxvii. 40) by Isaac—‘by thy sword shalt thou live, and shalt serve thy brother: and it shall come to pass, when thou shalt have the dominion, that thou shalt break his yoke from off thy neck.’ From 2 Kings xiv. 22, however, it appears that Uzziah recovered Elath, and, having so repaired and adorned the city as to be said to have built, that is rebuilt, it, he made it a part of his dominions. This connection was not of long continuance; for in ch. xvi. ver. 6 of the same book, we find the Syrian king Rezin interposing, who captured Elath, drove out the Jews, and annexed the place to his Syrian kingdom, and ‘the Syrians came to Elath, and dwelt there unto this day.’ At a later period it fell under the power of the Romans, and was for a time guarded by the tenth legion, forming part of Palestina Tertia (Jerome, *Onom.* s. v. *Ailah*; Strabo, xxi. 4, 4; Reland, p. 536). It subsequently became the residence of a Christian bishop. Bishops of Elath were at the council of Chalcedon (A.D. 451), and that of Constantinople, (A.D. 536). At the council of Chalcedon, Beryllus thus wrote his designation as bishop Ἀἰλᾶ τῆς Παλαιστίνης τριτῆς. In the days of its prosperity it was much distinguished for commerce, which continued to flourish under the auspices of Christianity. In the sixth century it is spoken of by Procopius as being inhabited by Jews subject to the Roman dominion (*De Bell. Pers.* i. 19). In A.D. 630, the Christian communities of Arabia Petræa found it expedient to submit to Mohammed, when John, the Christian governor of Ailah, became bound to pay an annual tribute of 300 gold-pieces (Abulfeda, *Ann.* i. 171). Henceforward, till the present century, Ailah lay in the darkness of Islamism. It is merely mentioned by the supposed Ibn Haukal, perhaps in the eleventh century; and, after the middle of the twelfth, Edrisi describes it as a small town frequented by the Arabs, who were now its masters, and forming an important point in the route between Cairo and Medina. In A.D. 1116, King Baldwin of Jerusalem took possession of it. Again was it wrested from the hands of the Christians by Saladin I., A.D. 1167, and never again fully recovered by them; although the reckless Rainald of Chatillon, in A.D. 1182, seized, and for a time held, the town. In Abul-

fedā's day, and before A.D. 1300, it was already deserted. He says, 'In our day it is a fortress, to which a governor is sent from Egypt. It had a small castle in the sea, but this is now abandoned, and the governor removed to the fortress on the shore.' Such as Ailah was in the days of Abulfeda, is Akaba now. Mounds of rubbish alone mark the site of the town, while a fortress, occupied by a governor and a small garrison under the Pasha of Egypt, serves to keep the neighbouring tribes of the desert in awe, and to minister to the wants and protection of the annual Egyptian Haj, or pilgrim caravan. This place has always been an important station upon the route of the Egyptian Haj. Such is the importance of this caravan of pilgrims from Cairo to Mecca, both in a religious and political point of view, that the rulers of Egypt from the earliest period have given it convoy and protection. For this purpose a line of fortresses similar to that of Akaba has been established at intervals along the route, with wells of water and supplies of provisions (Robinson's *Biblical Researches*, vol. i. p. 250).

The first Frank who visited this place in modern times, was Ruppell, in 1822. Laborde (*Journey through Arabia Petraea*, London, 1836) was well received by the garrison and inhabitants of the castle of Akaba, of which he has given a view (vol. i. p. 116). The fortress, he states, is built on a regular plan, and is in a pretty good condition, though within several good habitations have been suffered to fall to decay. It has only two guns fit for service.—J. R. B.

ELDAD and MEDAD (מֵדָד וְאֵדָד; Sept. Ἐδάδ καὶ Μωδάδ), two of the seventy elders appointed by Moses to assist him in the government of the people. Although not present with the others at the door of the tabernacle, they were equally filled with the divine spirit and began to 'prophesy' in the camp. Joshua, thinking this irregular, requested Moses to forbid them, and received an answer eminently characteristic of the great lawgiver:—'Enviest thou for my sake? Would to God that all the Lord's people were prophets, and that the Lord would put his spirit upon them' (Num. xi. 24-29).

ELDER (זֶנֶן; Sept. πρεσβύτερος), literally, one of the older men, and because, in ancient times, older persons would naturally be selected to hold public offices, out of regard to their presumed superiority in knowledge and experience, the term came to be used as the designation for the office itself, borne by an individual, of whatever age. Such is the origin of the words *γερονσία* (a council of elders), *senatus*, *alderman*, &c. But the term 'elder' appears to be also expressive of respect and reverence in general, as *signore*, *seigneur*, *señor*, &c. The word occurs in this sense in Gen. i. 7, 'Joseph went up to bury his father, and with him went up all the servants of Pharaoh, the elders of his house, and all the elders of the land of Egypt'; Sept. πρεσβύτεροι, *Vulg. senes*. These elders of Egypt were, probably, the various state-officers. The elders of Israel, of whom such frequent mention is made, may have been, in early times, the lineal descendants of the patriarchs (Exod. xii. 21). To the elders Moses was directed to open his commission (Exod. iii. 16), τῶν γεροντίων τῶν υἱῶν Ἰσραὴλ. Aq. reads τοῖς πρεσβύταις. They accom-

panied Moses in his first interview with Pharaoh, as the representatives of the Hebrew nation (ver. 18); through them Moses issued his communications and commands to the whole people (Exod. xix. 7; Deut. xxxi. 9); they were his immediate attendants in all the great transactions in the wilderness (Exod. xvii. 5); seventy of their number were selected to attend Moses, Aaron, Nadab, and Abihu, at the giving of the law (Exod. xxiv. 1), on which occasion they are called the *nobles*

(זֶנֶן) of the children of Israel, who did eat and drink before God, in ratification of the covenant, as representatives of the nation. In Num. xi. 16, 17, we meet with the appointment of seventy elders to bear the burden of the people along with Moses; these were selected by Moses out of the whole number of the elders, and are described as being, already, officers over the children of Israel. It is the opinion of Michaelis, that this council, chosen to assist Moses, should not be confounded with the Sanhedrim, which, he thinks, was not instituted till after the return from the Babylonish captivity [SANHEDRIM]. He observes that these seventy elders were not chosen to be *judges* of the people, who had already more than 60,000 judges. He also argues that the election of seventy additional *judges* would have done but little towards suppressing the rebellion which led Moses to adopt this proceeding; but that it seems more likely to have been his intention to form a supreme senate to take a share in the government, consisting of the most respectable persons, either for family or merit, which would materially support his power and influence among the people in general; would unite large and powerful families, and give an air of aristocracy to his government, which had hitherto been deemed too monarchical. He further infers that this council was not permanent, not being once alluded to from the death of Moses till the Babylonish captivity; that Moses did not fill up the vacancies occasioned by deaths, and that it ceased altogether in the wilderness. After the settlement in Canaan the elders seem to have been the administrators of the laws in all the cities (Deut. xix. 12; xxi. 3, 6, 19; xxii. 15, 25). The continuance of the office may be traced during the time of the judges (Judg. ii. 7); during that of Samuel (1 Sam. xvi. 4); under Saul (1 Sam. xxx. 26); and David (1 Chron. xxi. 16). The elders of Israel are mentioned during the captivity (Ezra x. 14), consisting either of those who had sustained that office in their own land, or were permitted by the Babylonians to exercise it still among their countrymen. We meet with them again at the restoration (Ezra v. 5), and by them the Temple was rebuilt (vi. 14). After the restoration and during the time of the Maccabees, the Sanhedrim, according to Michaelis, was instituted, being first mentioned under Hyrcanus II. (Joseph. *Antiq.* 9, 3); but elders are still referred to in 1 Macc. vii. 33. Among the members of the Sanhedrim were the πρεσβύτεροι. Thus we find ὁ ἀρχιερεὺς καὶ οἱ γραμματεῖς καὶ οἱ πρεσβύτεροι, also 'chief priests and elders,' 'elders and scribes,' and various other collocations. Like the scribes, they obtained their seat in the Sanhedrim by election, or nomination from the executive authority. The word elder, with many other Jewish terms, was introduced into the Christian

church. In the latter it is the title of inferior ministers, who were appointed overseers *among not over the flock*; Gr. ἐν ᾧ, Vulg. 'in quo' (Acts xx. 17, 28; Tit. i. 5, 7; 1 Pet. v. 1-5). The term is applied even to the apostles (2 John; 3 John). So also πρεσβυτέριον certainly includes even St. Paul himself (comp. 1 Tim. iv. 14 and 2 Tim. i. 6). Still the apostles are distinguished from the elders elsewhere (Acts xv. 6). The elder was constituted by an apostle or some one invested with apostolic authority (Acts xiv. 23; see also the epistles to Timothy and John). The elders preached, confuted gainsayers (Tit. i. 9), and visited the sick (James v. 14). The word elders is sometimes used in the sense of ancients, ancestors, predecessors, like the word ἀρχαῖοι (Matt. v. 21; Heb. xi. 2). It is used symbolically (Rev. iv. 4, &c.). The term πρεσβύτερος is plainly the origin of our word 'priest'; Saxon, *preoster* and *preste*, then *priest*; High and Low Dutch, *priester*; French, *prestre* and *pretre*; Ital., *prete*; Span., *presbytero* (Jahn, *Biblisches Archæol.*, § 244; Mede's *Works*, fol. p. 27; Gesenius, *Wörterbuch*, s. v.).—J. F. D.

ELEALEH (עֲלֵאֵלָה; Sept. Ἐλεάλη), a town of the Reubenites east of the Jordan (Num. xxxii. 3, 37); but which is named by the prophets as a city of the Moabites (Isa. xv. 4; xvi. 9; Jer. xlviii. 31). It is usually mentioned along with Heshbon; and accordingly travellers find in the neighbourhood of that city a ruined place, bearing the name of El Aal, which doubtless represents Elealeh. It stands upon the summit of a hill, and takes its name from its situation, Aal meaning 'high.' It commands the whole plain, and the view from it is very extensive. It is about a mile and a quarter north-east of Heshbon. Winer represents Burckhardt as saying that it was 6½ hours from Heshbon; and G. Robinson, copying Burckhardt, as if describing what he himself saw, makes the same mistake (*Travels*, ii. 193). But the 6½ hours of Burckhardt refer to the distance from his starting-point in the morning, which was Szalt. At 5½ hours he arrived at El Aal, and at 6½ hours at Heshbon, bearing south-west from El Aal (*Syria*, p. 365). This makes the distance between them only half an hour, corresponding with the other accounts.

ELEAZAR (אֵלְעָזָר, *God the Helper*; Sept. Ἐλεάζαρ). This was an exceedingly common name among the Hebrews, being borne by a considerable number of persons in Scripture (as well as in the Apocrypha and Josephus), of whom the principal are the following.

1. ELEAZAR, eldest son of Aaron (Exod. vi. 23, 25), who acted in his father's lifetime as chief of the tribe of Levi (Num. iii. 32), and at his death succeeded him in the high-priesthood (Num. xx. 35, sq.). His pontificate was contemporary with the military government of Joshua, whom he appears to have survived. A perfectly good understanding seems at all times to have subsisted between Eleazar and Joshua, as we constantly trace that co-operation and mutual support: which the circumstances of the time and of the nation rendered so necessary. Eleazar is supposed to have lived twenty-five years after the passage of the Jordan, and the book of Joshua concludes with a notice of his death and burial.

2. ELEAZAR, who was set apart to attend upon the ark while it remained under the roof of his father Abinadab (1 Sam. vii. 1).

3. ELEAZAR, one of the three most eminent of David's heroes, who 'fought till his hand was weary' in maintaining with David and the other two a daring stand against the Philistines after 'the men of Israel had gone away.' He was also one of the same three when they broke through the Philistine host, to gratify David's longing for a drink of water from the well of his native Bethlehem (2 Sam. xxiii. 9, 10, 13).

4. ELEAZAR, the fourth of the Maccabæan brothers, sons of the priest Mattathias (1 Macc. ii. 5). He was crushed to death by the fall of an elephant which he stabbed under the belly in the belief that it bore the king, Antiochus Eupator (1 Macc. vi. 43-46).

5. ELEAZAR, an aged and venerable scribe who, 'as became his age, and the excellency of his ancient years, and the honour of his grey head,' chose rather to submit to the most cruel torments than conform to the polluting enactments of Antiochus Epiphanes (2 Macc. vii. 18-31).

ELECTA or ECLICTA (Ἐκλεκτή). According to Grotius, Wetstein, and some other critics, this word is used as a proper name in the address of John's second epistle, 'Ὁ Πρεσβύτερος Ἐκλεκτῆς κυρία—' *The Presbyter to the Lady Electa*. This meaning is advocated by Bishop Middleton in his treatise on the *Doctrine of the Greek Article* (2nd ed. Cambridge, 1828, pp. 626-629). He adduces in support of it several epistolary inscriptions from Basil, in which the name precedes, and the rank or condition in life is subjoined, such as Εὐσταθίῳ ἱατρῷ—Λεοντίῳ σοφιστῇ—Βασπορίῳ ἐπισκόπῳ—Μαγνημιανῷ κλημῆτι: none of these, however, are purely honorary titles. To meet the objection that the sister of the person addressed is also called Electa in verse 13, he suggests that the words τῆς Ἐκλεκτῆς are a gloss, explanatory of σου. But this is mere conjecture, unsupported by a single manuscript; and such a gloss, if occasioned (as Bishop Middleton supposes) by the return to the singular number, would more naturally have been inserted after σε, in which position, however unnecessary, it would at least produce no ambiguity. Some writers, both ancient and modern, have adopted a mystical interpretation, though contrary to the *usus loquendi*, and to all apostolic usage, and supposed with Jerome that the term ἐκλεκτῆς referred to the church in general, or with Cassiodorus, to some particular congregation. The last named writer (h. a. d. 470. d. 562), in his *Complexiones in Epistolas*, &c. (Lond. 1722, p. 136), says, 'Johannes—electæ dominæ scribit ecclesiæ, filisque ejus, quas sacro fonte genuerat.' Clemens Alexandrinus, in a fragment of his *Adumbrationes*, attempts to combine the literal and the mystical meanings—'Scripta vero est ad quamdam Babyloniam Electam nomine, significat autem electionem ecclesiæ sanctæ. (*Opera*, ed. Klotz. iv. p. 66). The Authorized Version translates the words in question 'the elect lady,' an interpretation approved by Castalio, Beza, Mill, Wolf, Le Clerc, and Macknight. Most modern critics, however, Schleusner and Breitschneider in their *Lexicons*, Bourger (1763), Vater (1824), Goeschel (1832), and Tischendorf (1841), in their editions of the New Testament, Neander (*History of the Planting of the Christian*

Church, vol. ii. p. 71, Eng. transl.), De Wette (*Lehrbuch*, p. 339), and Lücke (*Commentary on the Epistles of St. John*, pp. 314-320, Eng. transl.), agree with the Syriac and Arabic Versions in making *Κυρία* a proper name, and render the words 'to the elect *Cyria*.' Lardner has given a copious account of critical opinions in his *History of the Apostles and Evangelists*, c. xx. *Works*, vi. 281-288.—J. E. R.

ELEMENTS (στοιχεῖα). The etymon both of the English and Greek word conveys their primary meaning: thus, elements, from *elementa*, the *alimenta* from which things are made, and *στοιχεῖα*, from *στέλω*, 'to go up by steps'—the first principles whence the subsequent parts of things (στοιχοῦσι) proceed in order. It seems to have been believed, from a very early period, that all bodies consist of certain first, specific ingredients (στοιχεῖα), into which they are all resolvable, although different opinions prevailed respecting the number and nature of these primary constituents of things. Hesychius explains *στοιχεῖα* by *πῦρ, ὕδωρ, γῆ, καὶ ἀήρ, ἀφ' ὧν τὰ σώματα*—fire, water, earth, and air, of which bodies are formed. This, which is the simplest, may be called the primary sense of the word. A secondary use of the word relates to the organized parts of which anything is framed, as the letters of the alphabet (Hesychius gives also *γράμματα*), these being the elements of words; also the elements, rudiments, or first principles of any art or science. The word occurs in its primary sense, Wis. vii. 17, *σύστασιν κόσμου καὶ ἐνέργειαν στοιχείων*, 'the constitution of the world and the operation of the elements;' also xix. 18. It is used in the same sense, 2 Pet. iii. 10, *στοιχεῖα δὲ καυσούμενα λυθίσονται*, and ver. 12, *τήκεται*, 'the elements burning will be dissolved and melted.' The Jews, in Peter's time, spoke of four elements (Joseph. *Antiq.* iii. 7. 7).

The word occurs in a secondary sense in Gal. iv. 3-9, *τὰ στοιχεῖα τοῦ κόσμου*, 'the elements or rudiments of the world,' which the Apostle calls *ἀσθενή καὶ πτωχὰ στοιχεῖα*, 'very weak and poor elements.' He introduces the word to preserve the unity of his comparison of the law to a *pedagogue* (iii. 24), and of persons under it, to children under tutors; and by the elements or rudiments of the world he evidently means that state of religious knowledge which had subsisted in the world, among Jews and Gentiles, before Christ; the weakness of which, among the Jews, may be seen in Heb. vii. 18, 19; x. 1, and among the Gentiles, in the epistle to the Romans, *passim*. 'The elements of the world' occurs again, Col. ii. 8-20, in the same sense, as appears from the various allusions both to the terms used in Grecian philosophy, and the dogmas of the Judaizers in the subsequent verses; the phrase being possibly suggested to the Apostle by his previous use of it to the Galatians. The word *στοιχεῖα* in Heb. v. 12 is restricted, by the addition *τῶν λογίων τοῦ Θεοῦ*, to the rudiments of Christianity (see Rosenmüller and Benson on the passages)—J. F. D.

ELEPHANT (ἔλεφας) occurs only in 1 Macc. vi. 34. Bochart imagined שְׁהַבְבִּים *shenhabbim* to be a contraction of שְׁהַבְבִּים שְׁנִי שְׁנִי *shen-kahabbim*, because *alikhaban* is one of the Arabic names of the elephant; and thence inferred that *shin* denoting *tooth*, the remaining part of the

word, *habbim* or *habbehim*, was in Hebrew, like *khaban* in Arabic, to be referred to elephant. However this may be, all the nations of the south and west of Asia have for many ages generally used the word *fil*, *feel*, *phael*, *phil*, פִּיל; for we find it in the Chaldee, Syriac, Persian, Arabic, and Turkish, extending to the east far beyond the Ganges, where, nevertheless, in the indigenous tongues *anei*, *waranam*, and *hatti* are existing names.

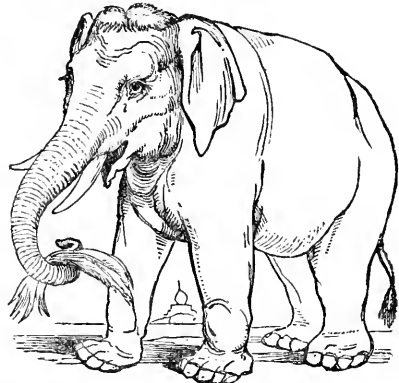

279. [Asiatic Elephant.]

The animals of this genus consist at present of two very distinct species, one a native of Southern Asia, once spread considerably to the westward of the Upper Indus, and the other occupying southern and middle Africa to the edge of the great Sahara. In a fossil state there are besides six more species clearly distinguished. The elephant is the largest of all terrestrial animals, sometimes reaching to above eleven feet of vertical height at the shoulders, and weighing from five to seven thousand pounds: he is of a black or slaty-ash colour, and almost destitute of hair. The head, which is proportionably large, is provided with two broad pendulous ears, particularly in those of the African species, which are occasionally six feet in length. This species has also two molar teeth on each side of the jaw, both above and below, and only three toe-nails on each of the hind-feet; whereas the Asiatic species is provided with only one tooth on each side above and below; and though both have tusks or defences, the last-mentioned has them confined solely to the males: they are never of more than seventy pounds weight, often much less, and in some breeds even totally wanting; while in the African both sexes are armed with tusks, and in the males they have been known seven feet in length, and weighing above 150 pounds each. The forehead of the African is low; that of the Asiatic high; in both the eyes are comparatively small, with a malevolent expression, and on the temples are pores which exude a viscous humour; the tail is long, hanging nearly to the heels, and distichous at the end. But the most remarkable organ of the elephant, that which equally enables the animal to reach the ground and to grasp branches of trees at a considerable height, is the proboscis or trunk; a cylindrical elastic instrument, in ordinary condition reaching nearly down to the ground, but contractile to two-thirds of its usual

length, and extensible to one-third beyond it; provided with nearly 4000 muscles crossing each other in such a manner that the proboscis is flexible in every direction, and so abundantly supplied with nerves as to render the organ one of the most delicate in nature. Within is the double canal of the nostrils, and at the terminal opening a finger-like process, with which the animal can take up very minute objects and grasp others, even to a writing pen, and mark paper with it. By means of the proboscis the elephant has a power of suction capable of raising nearly 200 pounds weight; and with this instrument he gathers food from trees and from the earth, draws up drink to squirt it down his throat, draws corks, unties small knots, and performs numberless other minute operations; and, if necessary, tears down branches of trees more than five inches in diameter with no less dexterity than strength. The gait of an elephant is an enormous stride, performed with his high and ponderous legs, and sufficiently rapid to require smart galloping on horseback to outstrip him.

Elephants are peaceable towards all inoffensive animals, sociable among themselves, and ready to help each other; gregarious in grassy plains; but more inclined to frequent densely-wooded mountain glens: at times not unwilling to visit the more arid wastes, but fond of rivers and pools, where they wallow in mud and water among reeds and under the shade of trees. They are most assuredly more sagacious than observers, who, from a few visits to menageries, compare them with dogs, are able to appreciate, for on this question we must take into account, on the one hand, the physical advantages of the proboscis added to the individual experience gained by an animal slow in growth, and of a longevity exceeding a century; but still placed in contact with man after a birth free in every sense, where his powers expand without human education; while on the other hand dogs are the offspring of an immense number of generations, all fashioned to the will of a master, and consequently with innate dispositions to acquire a certain education. In Griffith's *Cuvier* are found several anecdotes, some of them from the personal observations of the present writer; and referring to them, we shall add only a single one here, related by the late Captain Hobson, R.N., as observed by himself at Travancore, where several of these animals were employed in stacking teak timber balk. They had scarcely any human aid or direction, but each beam being successively noosed and slung, they dragged it to the stack, raised one end up, contrived to shove it forward, nicely watching when, being poised by its own weight, the lower end would rise, and then, placing their foreheads against the butt end, they pushed it even on the stack; the sling they unfastened and carried back to have it fitted again! In a wild state no other animal has the sagacity to break off a leafy branch, hold it as a fan, and use it as a brush to drive away flies.

The Asiatic species, carrying the head higher, has more dignity of appearance, and is believed to have more sagacity and courage than the African; which, however, is not inferior in weight or bulk, and has never been in the hands of such experienced managers as the Indian mohauts are, who have acquired such deep knowledge of the

character of these beasts that they make them submit to almost incredible operations; such, for example, as suffering patiently the extraction of a decayed part of a tooth, a kind of chisel and mallet being the instruments used for the purpose. This was witnessed by a medical officer, a near relative of the present writer. Elephants walk under water as long as the end of the proboscis can remain above the surface; but when in greater depth, they float with the head and back only about a foot beneath it. In this manner they swim across the broadest streams, and guide themselves by the sense of smelling till they reach footing to look about them and land. They are steady, assiduous workmen in many laborious tasks, often using discretion when they require some dexterity and attention in the performance. Good will is all man can trust to in directing them, for correction cannot be enforced beyond their patience; but flattery, good treatment, kind words, promises, and rewards, even to the wear of finery, have the desired effect. In history they appear most conspicuous as formidable elements of battle. From the remotest ages they were trained for war by the nations of India, and by their aid they no doubt acquired and long held possession of several regions of High Asia westward of the Indus. They are noticed in the ancient Mahabarata. According to Sauti the relative force of elephants in an akshaushini or great army corps was one to each chariot of war, three horsemen, and five foot-soldiers, or rather archers mounted on the animal's back within a defensible houdah—in the west denominated a castle. Thus one armed elephant, one chariot, and three horsemen formed a patti or squad of at most eleven men, and if there were other bodies of infantry in the army they are unnoticed. This enumeration is sufficient to show that in India, which furnished the elephants and the model of aiming them, there were only four or five archers with or without the mohaut or driver, and that, consequently, when the successors of Alexander introduced them in their wars in Syria, Greece, and even Italy, they could not be encumbered more than perhaps momentarily with one or two additional persons before a charge; for the weight carried by a war-elephant is less than that of one used for burthen, which seldom equals two thousand pounds. In order to ascend his back when suddenly required, the animal will hold out one of his hind legs horizontally, allowing a person to step upon it until he has grasped the crupper and crept up. In the West, where they were considered for a time of great importance, no doubt the squad or escort of each animal was more considerable than in the East, and may have amounted to thirty-two foot-soldiers; the number given, by some mistake, as if actually mounted, in 1 Macc. vi. 37.

Although red colours are offensive to many animals, it may be observed that the use of mulberry juice or grapes must have been intended as an excitement to their taste, for they are all fond of fruit. Wine, so as to cause an approach to intoxication, would render them ungovernable, and more dangerous than when in a state of fear. They do not require stimulants to urge them on in a modern battle, with all its flashes of fire, smoke, and explosion; and red colours usually employed for their trappings produce more of a satisfactory

feeling than rage. Judicious and long-continued training is the only good remedy against sudden surprises caused by objects not yet examined by their acutely-judging senses, or connected with former scenes of danger, which are alone apt to make them turn. It is likely that the disciplined steadiness of well-armed ranks frightened them by their novelty more than the shouts of Macedonian thousands, which must have been feeble in the ears of elephants accustomed to the roar of hundreds of thousands of Indians. It is probable that the Carthaginians made the experiment of training African elephants in imitation of Ptolemy Philadelphus: they are noticed in their army only in the first Punic war; and, from what appears of the mode of managing them, there is reason to believe, as already noticed, that they were never so thoroughly subdued as the Indian elephants.—C. H. S.

ELEUTHEROPOLIS (Ἐλευθερόπολις), a place not named in Scripture, but which was an episcopal city of such importance in the time of Eusebius and Jerome that they assumed it as the point whence to estimate the distances and positions of other cities in Southern Palestine. It continued to be a great city until the sixth century: but after that we lose sight of it, and all the attempts to recover the knowledge of a position of such topographical importance have proceeded upon critical conjectures and combinations. This process sufficed to show that it lay in the south-western plain of Judæa, between Hebron and Askelon, but not to determine the site with any precision. Professor Robinson, when in that quarter, made this long-lost and important site a subject of particular inquiry; but no traces of the name could be found, and Beit-Jibrin was referred to as the only place in the neighbourhood where any ruins of consequence existed. Of these ruins the Arabs spoke in the most extravagant terms, and the travellers were induced to turn their steps in that direction. On approaching Beit-Jibrin they were gratified to find themselves surrounded by several places whose distances from Eleutheropolis are specified by Eusebius and Jerome, and which might serve them as a clew in the search for Eleutheropolis itself.

Beit-Jibrin proved to be a village of moderate size, the capital of a district in the province of Gaza. In and around this village are ruins of different ages, more extensive and massy than any which had been seen in Palestine, excepting the substractions of the ancient temple at Jerusalem and the Haram at Hebron. These ruins consist principally of the remains of a fortress of immense strength, in the midst of an irregular rounded enclosure, encompassed by a very ancient and strong wall. This outer wall is built of large squared stones, uncemented. Along this wall on the inside, towards the west and north-west, is a row of ancient massive vaults with fine round arches, apparently of the same age as the wall itself, and both undoubtedly of Roman origin. In the midst of the area stands an irregular castle, the lower parts of which seem to be as ancient as the exterior wall, but it has obviously been built up again in modern times. An inscription over the gate shows that it was last repaired by the Turks A.H. 958 (A.D. 1551), nearly two years after the present walls of Jerusalem were built. Remains of ancient walls and dwellings extend

up the valley; and at the distance of twenty minutes from the present village are the ruins of an ancient church, bearing the name of Santa Hanneh (St. Anne). Only the eastern end is now standing, including the niche of the great altar and that of a side chapel, built of large hewn stones of strong and beautiful masonry.

Ruins thus worthy of the Roman name and indicative of a powerful city, seemed sufficient to warrant the conclusion that the site was that of the ancient Eleutheropolis; especially as it lay within the limits to which a careful estimate of the distances and positions in the *Onomasticon* had satisfied Dr. Robinson that the site must lie. Nevertheless, he had assured himself that this Beit-Jibrin could be no other than the Beto-gabra of Ptolemy and the Pentinger Tables, and the Beigeberin (an episcopal city) of the ecclesiastical *Notitiæ* of the subsequent centuries: and as he was not prepared to suppose that Eleutheropolis and Beto-gabra could be the same place, he proceeded to look elsewhere for the former city. Failing to discover the slightest trace of it within the quarter in which it must needs have lain, he again visited Beit-Jibrin, and then arrived at the conclusion that Beto-gabra and Eleutheropolis were indeed one and the same, the former represented by the present Beit-Jibrin, being the native name, kept in the background for a time by the Græco-Roman official title of Eleutheropolis, 'free city,' but reappearing as soon as the Romans, who used that name, had withdrawn. This explains satisfactorily the disappearance of the name of so important a place as Eleutheropolis, and affords ground for tracing its continued existence for ages under its native name.

In the twelfth century the Crusaders found on this spot an ancient site in ruins under the name of Beth-Gebrim; and here they reared again a fortress upon the ancient foundations. This place and fortress are often mentioned in the histories of the Crusades, usually under the corrupted name of Gibelin; and it was most erroneously confounded by the Christian writers with Beersheba. By the Arabian authors it is not unfrequently mentioned under the names of Beit-Jibrin and Beit-Jibril. Since the time of the Crusades the place does not appear to have been visited by any Christian traveller until Dr. Robinson explored the neighbourhood on his route from Jerusalem to Gaza.

Beto Gabra, Beth-Gelaim, and Beit-Jibrin appear to be different forms of the ancient Hebrew name. But the name itself does not occur in Scripture. Josephus indeed mentions a large village, *Βήτραβρις* (Betaris), in this region (*De Bell. Jud.* iv. 8, 1), which Rufinus reads *Βήγαβρις* (Begabris) in his copy; and Reland (p. 626) suggests that this may have been the same place, which is not unlikely.

This short analysis of the extended observations and discussions of Dr. Robinson (*Researches*, ii. 318, 359, 398, 401-420, 612-616) will put the reader in possession of the leading facts of this interesting question. The result seems to be that the identity of Beto-Gabris with Beit-Jibrin is satisfactorily established, and that the identity of Eleutheropolis with the same, although less certain, is rendered more than probable. Beit-Jibrin is twenty miles east of Askelon, and thirteen miles east-north-east from Hebron.

ELI (אֵלִי, *raised up*: Sept. Ἠλὶ), high-priest of the Jews when the ark was in Shiloh (1 Sam. i. 3, 9). He was the first high-priest of the line of Ithamar, Aaron's youngest son. This is deduced from 1 Chron. xxiv. 3, 6 (comp. Joseph. *Antiq.* v. 9, 1). It also appears from the omission of the names of Eli and his immediate successors in the enumeration of the high-priests of Eleazar's line in 1 Chron. vi. 4-6. What occasioned this remarkable transfer is not known—most probably the incapacity or minority of the then sole representative of the elder line; for it is very evident that it was no unauthorized usurpation on the part of Eli (1 Sam. ii. 27, 28). Eli also acted as regent or civil judge of Israel after the death of Samson. This function, indeed, seems to have been intended, by the theocratical constitution, to devolve upon the high-priest, by virtue of his office, in the absence of any person specially appointed by the Divine King, to deliver and govern Israel. He is said to have judged Israel forty years (1 Sam. iv. 18): the Septuagint makes it twenty; and chronologers are divided on the matter. But the probability seems to be that the forty years comprehend the whole period of his administration as high-priest and judge, including, in the first half, the twenty years in which Samson is said to have judged Israel (Judg. xvi. 31), when some of his civil functions in southern Palestine may have been in abeyance. As Eli died at the age of ninety-eight (1 Sam. iv. 15), the forty years must have commenced when he was fifty-eight years old.

Eli seems to have been a religious man; and the only fault recorded of him was an excessive easiness of temper, most unbefitting the high responsibilities of his official character. His sons, Hophni and Phinehas, whom he invested with authority, misconducted themselves so outrageously as to excite deep disgust among the people, and render the services of the tabernacle odious in their eyes. Of this misconduct Eli was aware, but contented himself with mild and ineffectual remonstrances, where his station required severe and vigorous action. For this neglect the judgment of God was at length denounced upon his house, through the young Samuel, who, under peculiar circumstances [ΣΑΜΥΕΛ], had been attached from childhood to his person (1 Sam. ii. 29; iii. 18). Some years passed without any apparent fulfilment of this denunciation—but it came at length in one terrible crash, by which the old man's heart was broken. The Philistines had gained the upper hand over Israel, and the ark of God was taken to the field, in the confidence of victory and safety from its presence. But in the battle which followed, the ark itself was taken by the Philistines, and the two sons of Eli, who were in attendance upon it, were slain. The high-priest, then blind with age, sat by the way-side at Shiloh, awaiting tidings from the war, 'for his heart trembled for the ark of God.' A man of Benjamin, with his clothes rent, and with earth upon his head, brought the fatal news; and Eli heard that Israel was defeated—that his sons were slain—that the ark of God was taken—at which last word he fell heavily from his seat, and died (1 Sam. iv.).

The ultimate doom upon Eli's house was accomplished when Solomon removed Abiathar (the

last high-priest of this line) from his office. ^{וַיִּשְׁבַּח} restored the line of Eleazar in the person of Zadok [אַבִּי־אֶתְיָזָק].

ELIAKIM. [JEOHIAKIM.]

ELIAS. [ELIJAH.]

ELIEZER. This is the same name as Eleazar—whence came the abbreviated Lazar or Lazarus of the New Testament. It is proper to note this here, because the parable which describes Lazarus in Abraham's bosom (Luke xvi. 23) has been supposed to contain a latent allusion to the name of Eliezer, whom, before the birth of Ishmael and Isaac, Abraham regarded as his heir. The passage of Scripture in which the name of Eliezer occurs is one of some difficulty. Abraham, being promised a son, says:—'I go childless, and the steward of my house is this Eliezer of Damascus. . . . Behold, to me thou hast given no seed: and, lo, one born in mine house is mine heir' (Gen. xv. 2, 3). Part of the difficulty is caused by the translation, and part by the prevalence of notions gathered from external sources, and not warranted by the original text. The common notion is that Eliezer was Abraham's house-born slave, adopted as his heir, and meanwhile his chief and confidential servant, and the same who was afterwards sent into Mesopotamia to seek a wife for Isaac. This last point we may dismiss with the remark, that there is not the least evidence that 'the elder servant of his house' (Gen. xxiv. 2), whom Abraham charged with this mission, was the same as Eliezer: and our attention may therefore be confined to the verses which have been quoted.

It is obvious that the third verse is not properly a sequel to the second, but a repetition of the statement contained in the second; and, being thus regarded as parallel passages, the two may be used to explain each other.

'Eliezer of Damascus,' or 'Damascene-Eliezer,' is the subject of both verses. The obvious meaning is, that Eliezer was born in Damascus: and how is this compatible with the notion of his being Abraham's house-born slave, seeing that Abraham's household never was at Damascus? It is true that there is a tradition, quoted by Josephus from Nicolaus of Damascus (*Antiq.* i. 7. 4), that Abraham 'reigned in Damascus'; but the tradition was probably founded on this very passage, and has no claim on our belief.

The expression, 'the steward of mine house,' in ver. 2, will explain the sense of 'one born in mine house is mine heir,' in ver. 3. The first phrase, literally translated, is 'the son of possession of my house,' *i. e.* one who shall possess my house, my property, after my death; and is therefore exactly the same as the phrase in the next verse, 'the son of my house' (paraphrased by 'one born in mine house') is mine heir.' This removes every objection to Eliezer's being of Damascus, and enables us to dispense with the tradition; for it is no longer necessary to suppose that Eliezer was a house-born slave, or a servant at all; and leaves it more probable that he was some near relative whom Abraham regarded as his heir-at-law. In this case Abraham obviously means to say, 'Behold, to me thou hast given no children, and not the son of my loins, but the son of my house (*i. e.* of my family—the son whom my house gives me—the heir-at-law) is mine heir.' It is by no means certain that 'this Eliezer' was

present in Abraham's camp at all: and we, of course, cannot know in what degree he stood related to Abraham, or under what circumstances he was born at, or belonged to, Damascus. It is possible that he lived there at the very time when Abraham thus spoke of him, and that he is hence called 'Eliezer of Damascus.'

This view, that Eliezer was actually Abraham's near relative and heir-at-law, removes another difficulty, which has always occasioned some embarrassment, and which arises from the fact, that while he speaks of Eliezer as his heir, his nephew Lot was in his neighbourhood, and had been, until lately, the companion of his wanderings. If Eliezer was Abraham's servant, it might well occasion surprise that he should speak of him and not of Lot as his heir: but this surprise ceases when we regard Eliezer as also a relative, and if so, a nearer relative than Lot, although not, like Lot, the companion of his journeys. Some have supposed that Lot and Eliezer were, in fact, the same person; and this would be an excellent explanation if the Scriptures afforded sufficient grounds for it.

2. ELIEZER. The second of the two sons born to Moses while an exile in the land of Midian (Exod. xviii. 4). Eliezer had a son called Rebadiah (1 Chron. viii. 17).

ELIHU (אֱלִיחֻ, *God Jehovah*; Sept. Ἐλιούς). One of Job's friends, described as 'the son of Barachel, a Buzite, of the kindred of Ram' (Job xxxii. 2). This is usually understood to imply that he was descended from Buz, the son of Abraham's brother Nabor, from whose family the city called Buz (Jer. xxv. 23) also took its name. The Chaldee paraphrase asserts Elihu to have been a relation of Abraham. Elihu's name does not appear among those of the friends who came in the first instance to condole with Job, nor is his presence indicated till the debate between the afflicted man and his three friends had been brought to a conclusion. Then, finding there was no answer to Job's last speech, he comes forward with considerable modesty, which he loses as he proceeds, to remark on the debate, and to deliver his own opinion on the points at issue. The character and scope of his orations are described elsewhere [JOB, BOOK OF]. It appears, from the manner in which Elihu introduces himself, that he was by much the youngest of the party; and it is evident that he had been present from the commencement of the discussion, to which he had paid very close attention. This would suggest that the debate between Job and his friends was carried on in the presence of a deeply-interested auditory, among which was this Elihu, who could not forbear from interfering when the controversy appeared to have reached an unsatisfactory conclusion.

ELIJAH (אֱלִיָּהוּ, *God-Jehovah*; Sept. Ἠλιού). This wonder-working prophet is introduced to our notice like another Melchizedek (Gen. x. 4, 18; Heb. vii. 3), without any mention of his father or mother, or of the beginning of his days—as if he had dropt out of that cloudy chariot, which, after his work was done on earth, conveyed him back to heaven. From this silence of Scripture as to his parentage and birth, much vain speculation has arisen. Some of the

Rabbins have supposed that he was *Phineas*, the grandson of Aaron; whilst others have thought that he was an *angel*, who, for the purpose of reforming wicked king Ahab and his ungodly subjects, assumed the form of a man. Some suppose that Elijah is called a Tishbite from Tishbein, a city beyond the Jordan. Others suppose that Tishbite means *converter* or *reformer*, deriving it from the Hebrew radical עָשָׂה. The very first sentence that the prophet utters is a direful denunciation against Ahab; and this he supports by a solemn oath, 'As the Lord God of Israel liveth, before whom I stand, there shall not be dew or rain these years (*i. e.* three and a half years, Luke iv. 25; James v. 17), but according to my word' (1 Kings xvii. 1). Before, however, he spoke thus, it would seem that he had been warning this most wicked king as to the fatal consequences which must result both to himself and his people, from the iniquitous course he was then pursuing; and this may account for the apparent abruptness with which he opens his commission.

We can imagine Ahab and Jezebel being greatly incensed against Elijah for having foretold and prayed that such calamities might befall them. For some time they might attribute the drought under which the nation suffered to natural causes, and not to the interposition of the prophet; and, therefore, however they might despise him as a vain enthusiast, they would not proceed immediately to punish him. When, however, they saw the denunciation of Elijah taking effect far more extensively than had been anticipated, they would naturally seek to wreak their vengeance upon him as the cause of their sufferings. But we do not find him taking one step for his own preservation, till the God whom he served said, 'Get thee hence, and turn thee eastward, and hide thyself by the brook Cherith, that is before Jordan; and it shall be that thou shalt drink of the brook; and I have commanded the ravens to feed thee there' (1 Kings xvii. 3, 4). Other and better means of protection from the impending danger might seem open to him; but, regardless of these, he hastened to obey the divine mandate, and 'went and dwelt by the brook Cherith that is before Jordan' (1 Kings xvii. 5) [ΣΗΡΑΙΘΗ].

Some commentators, availing themselves of the fact that עֲרָבִים *orebim*, which we translate *ravens*, means, in Ezek. xxvii. 27, *merchants*, have tried to explain away the miraculous character of God's preservation of his servant at Cherith. Others again have thought that the original signifies *Arabians*, as in 2 Chron. xxi. 16; Neh. iv. 7; where the like word is used; or possibly the inhabitants of the city Arabah, near Beth-shan (Josh. xv. 6, and xviii. 18, &c.). In the face of such opinions as these, we still believe that ravens and not men were the instruments which God, on this occasion, employed to carry needful food to his exiled and persecuted servant; and in this he would give us a manifest proof of His sovereignty over all creatures. But, it has been inquired, how could these birds obtain food of a proper kind, and of a sufficient quantity, to supply the daily wants of the prophet? The answer to this inquiry is very simple. We cannot tell. It is enough for us to know that God engaged to make a provision for him, and that He failed not to fulfil his engagement. We need not to speculate, as some have

done, as to whether this supply was taken from Ahab's or Jehoshaphat's table, or from that of one of the seven thousand of Israel who had not bowed the knee to Baal.

A fresh trial now awaits this servant of God (b.c. 909), and in the manner in which he bears it, we see the strength of his faith. For one year, as some suppose, God had miraculously provided for his bodily wants at Cherith; but the brook which, heretofore, had afforded him the needful refreshment there, became dried up. Encouraged by past experience of his heavenly Father's care of him, the prophet still waited patiently till He said, 'Aris' (1 Kings xvii. 9), get thee to Zarephath, which belongeth to Zidon, and dwell there: behold, I have commanded a widow woman there to sustain thee.' He then, at once, set out on the journey, and now arrived at Zarephath, he, in the arrangement of God's providence, met, as he entered its gate, the very woman who was deputed to give him immediate support. But his faith is again put to a sore test, for he found her engaged in a way which was well calculated to discourage all his hopes; she was gathering sticks for the purpose, as she assured him, of cooking the last meal, and now that the famine prevailed there, as it did in Israel, she saw nothing before her and her only son but starvation and death. How then could the prophet ask for, and how could she think of giving, a part of her last morsel? The same Divine Spirit inspired him to assure her that she and her child should be even miraculously provided for during the continuance of the famine; and also influenced her heart to receive, without doubting, the assurance! The kindness of this widow in baking the first cake for Elijah was well requited with a prophet's reward (Matt. x. 41, 42); she afforded one meal to him, and God afforded many to her (see 1 Kings xv. 16). But uninterrupted prosperity will not do for even God's most devoted servants. Possibly a feeling of self-righteousness might, through the deceitfulness of sin, have begun to enter their minds, seeing that, whilst millions around them were now suffering and dying from want, they were made the special objects of God's providential care. Accordingly, their heavenly Father saw fit to visit them with a temporary calamity—a calamity as severely felt in some respects by the one as it was by the other. 'And it came to pass that the son of the woman, the mistress of the house, fell sick; and his sickness was so sore that there was no life left in him' (1 Kings xvii. 17). Verse 18 contains the expostulation with the prophet of this bereaved widow; she rashly imputes the death to his person. She seems to have thought within herself, that, as God had shut up heaven from pouring down refreshing showers upon a guilty nation, in consequence of the prophet's prayer, so she was now suffering from a similar cause. Elijah retaliates not, but calmly takes the dead child out of the mother's bosom, and lays it on his own bed (verse 19), that there he may, in private, pray the more fervently for its restoration. Every epithet that the prophet poured forth on this occasion was big with meaning; his prayer was heard, and answered by the restoration of life to the child, and of gladness to the widow's heart.

Since now, however, the long-protracted famine, with all its attendant horrors, failed to detach Ahab and his guilty people from their abominable

idolatries, God mercifully gave them another opportunity of repenting and turning to Himself. For three years and six months (James v. 17) the destructive famine had spread its deadly influence over the whole nation of Israel. During this time the prophet was called upon passively to suffer God's will; now he must once again resume the more active duties of life; he must make one great public effort more to reclaim his country from apostasy and ruin. According to the word of the Lord he returned to Israel; Ahab was yet alive, and unreformed; Jezebel, his impious consort, was still mad upon her idols; in a word, the prophets of Baal were prophesying lies, the priests were bearing rule by their means, and the people loved to have it so. Such was the state of things in Israel when Elijah once again stood before Ahab. Wishing not to tempt God by going unnecessarily into danger, he first presented himself to good Obadiah (1 Kings xviii. 7). This principal servant of Ahab was also a true servant of God; and recognising the prophet he treated him with honour and respect. Elijah requested him to announce to Ahab that he had returned. Obadiah, apparently stung by the unkindness of this request, replied, 'What have I sinned, that thou shouldst thus expose me to Ahab's rage, who will certainly slay me for not apprehending thee, for whom he has so long and so anxiously sought in all lands and in confederate countries, that they should not harbour a traitor whom he looks upon as the author of the famine,' &c. Moreover, he would delicately intimate to Elijah how he had actually jeoparded his own life in securing that of one hundred of the Lord's prophets, and whom he had fed at his own expense. Satisfied with Elijah's reply to this touching appeal, wherein he removed all his fears about the Spirit's carrying himself away (as 2 Kings ii. 11-16; Ezek. iii. 4; Acts viii. 39), he resolves to be the prophet's messenger to Ahab. Intending to be revenged on him, or to inquire when rain might be expected, Ahab now came forth to meet Elijah. He at once charged him with troubling Israel, i.e. with being the main cause of all the calamities which he and the nation had suffered. But Elijah flung back the charge upon himself, assigning the real cause to be his own sin of idolatry. Regarding, however, his magisterial position, while he reproved his sin, he requests him to exercise his authority in summoning an assembly to Mount Carmel, that the controversy between them might be decided, whether the king or the prophet was Israel's troubler. Whatever were the secret motives which induced Ahab to comply with this proposal, God directed the result. Elijah offered to decide this controversy between God and Baal, not by Scripture—for an appeal to its authority would have fallen powerless upon their *infidel minds*—but by a miracle from Heaven. As fire was the element over which Baal was supposed to preside, the prophet proposes (wishing to give them every advantage), that, two bullocks being slain, and laid each upon a distinct altar, the one for Baal, the other for Jehovah, whichever should be consumed by fire must proclaim whose the people of Israel were, and whom it was their duty to serve. The people consent to this proposal, because, it may be, they were not altogether ignorant how God had formerly answered by fire (Gen. iv. 4; Lev. ix. 24.

Judg. vi. 21 ; xiii. 20 1 Chron. xxi. 26 ; 2 Chron. vii. 1). Elijah will have summoned not only all the elders of Israel, but also the four hundred priests of Baal belonging to Jezebel's court, and the four hundred and fifty who were dispersed over the kingdom. The former, however, did not attend ; being, perhaps, glad to shelter themselves under the plea that Jezebel would not allow them to do so. Confident of success, because doubtless God had revealed the whole matter to him, he enters the lists of contest with the four hundred and fifty priests of Baal. Having reconstructed an altar which had once belonged to God, with twelve stones—as if to declare that the twelve tribes of Israel should again be united in the service of Jehovah—and having laid thereon his bullock, and filled the trench by which it was surrounded with large quantities of water, lest any suspicion of deceit might occur to any mind, the prophet gives place to the Baalites—allows them to make trial first. In vain did these deceived and deceiving men call, from morning till evening, upon Baal—in vain did they now mingle their own blood with that of the sacrifice : no answer was given—no fire descended.

Elijah having rebuked their folly and wickedness with the sharpest irony, and it being at last evident to all that their efforts to obtain the wished-for fire were vain, now, at the time of the evening sacrifice, offered up his prayer. The Baalites' prayer was long, that of the prophet is short—charging God with the care of His covenant, of His truth, and of His glory—when, behold, 'the fire came down, licked up the water, and consumed not only the bullock, but the very stones of the altar also.' The effect of this on the mind of the people was what the prophet desired : acknowledging the awful presence of the Godhead, they exclaim, as with one voice, 'The Lord He is God ; the Lord He is God !' Seizing the opportunity whilst the people's hearts were warm with the fresh conviction of this miracle, he bade them take those juggling priests and kill them at Kishon, that their blood might help to fill that river which their idolatry had provoked God to empty by drought. All this Elijah might lawfully do at God's direction, and under the sanction of His law (Deut. xiii. 5 ; xviii. 20). Ahab having now publicly vindicated God's violated law by giving his royal sanction to the execution of Baal's priests, Elijah informed him that he may go up to his tent on Carmel to take refreshment, for God will send the desired rain. In the mean time he prayed earnestly (James v. 17, 18) for this blessing : God hears and answers : a little cloud arises out of the Mediterranean sea, in sight of which the prophet now was, diffuses itself gradually over the entire face of the heavens, and now empties its refreshing waters upon the whole land of Israel ! Here was another proof of the Divine mission of the prophet, from which, we should imagine, the whole nation must have profited ; but subsequent events would seem to prove that the impression produced by these dealings of God was of a very partial and temporary character. Impressed with the hope that the report of God's miraculous actings at Carmel might not only reach the ear, but also penetrate, and soften, the hard heart of Jezebel ; and anxious that the reformation of his country should spread in and about Jezreel also, Elijah, strengthened, as we are

told, from on high, now accompanies Ahab thither on foot. How ill-founded the prophet's expectation was, subsequent events too painfully proved. Jezebel, instead of receiving Elijah obviously as the messenger of God for good to her nation, now secretly conceives and openly declares her fixed purpose to put him to death. The man whose prayer had raised the dead, had shut and opened Heaven, he who had been so wonderfully preserved by God at Cherith and Zarephath, and who dared to tax Ahab to his face with being Israel's troubler, is now so terrified by the knowledge of this vile woman's design that he fled into the wilderness and there longed for death—thus affording a practical evidence of what St. James says of him, that he was a man of like passions with us. His now altered state of mind would seem to have arisen out of an exaggerated expectation of what God designed to effect through the miracles exhibited to, and the judgments poured upon, this guilty nation. He seems to have thought that, as complete success did not crown the last great effort he had made to reform Israel, there could not be the slightest use in labouring for this end any longer. Alas ! had he stood his ground at Jezreel, who can tell what effect this might have had even upon the mind of Jezebel, and, through her, upon the whole nation ! But no ; the great opportunity of usefulness is now lost, and he asks for death : still God will be gracious to him. He now, alone in the wilderness and at Mount Horeb, will at once touch his heart and correct his petulance by the ministration of His angel, and by a fearful exhibition of His Divine power. And having done this, revealing Himself in the gentle accents of a still voice, He announces to him that he must go and anoint Hazael king over Syria, Jehu king over Israel, and Elisha prophet in his own place, ere death can put a period to his labours. These persons shall revenge God's quarrels ; one shall begin, another shall prosecute, and the third shall perfect the vengeance on Israel. When God had comforted His prophet by telling him of these three instruments he had in store to vindicate his own insulted honour, then he convinced him of his mistake in saying 'I only am left alone,' &c., by the assurance that there were seven thousand in Israel who had not bowed the knee to Baal.

Leaving the cave of Horeb (b.c. 806), Elijah now proceeded to the field where he found Elisha in the act of ploughing, and, without uttering a word, he cast his prophet's mantle over him, which was a symbol of his being clothed with God's spirit. The divine impression produced upon the mind of Elisha by this act of Elijah made him willing to leave all things and follow him.

For about six years from this calling of Elisha we find no notice in the sacred history of Elijah, till God sent him once again to pronounce sore judgments upon Ahab and Jezebel for the murder of unoffending Naboth (1 Kings xxi. 17. &c.). How he and his associate in the prophetic office employed themselves during this time we are not told. We may conceive, however, that they were much engaged in prayer for their country, and in imparting knowledge in the schools of the prophets, which were at Jericho and Beth-el. We need not dwell upon the complicated character of Ahab's wickedness (1 Kings xxi.), in winking at the murderous means whereby Jezebel pro-

cured for him the inalienable property of Nahoth [AHAB; NABOTH]. When he seemed to be tripping in the possession of his ill-obtained gain, Elijah stood before him, and threatened him, in the name of the Lord (2 Kings ix. 21-26 inclusive), that God would retaliate blood for blood, and that not on himself only—'his seventy sons shall die, and (2 Kings x. 6) Jezebel shall become meat for dogs.' Fearing that these predictions would prove true, as those about the rain and fire had done, Ahab now assumed the manner of a penitent; and, though subsequent acts proved the insincerity of his repentance, yet God rewards his temporary abasement by a temporary arrest of judgment. We see, however, in after parts of this sacred history, how the judgments denounced against him, his abandoned consort, and children, took effect to the very letter.

Elijah again retires from the history till an act of blasphemy on the part of Abaziah, the son and successor of Ahab, causes God to call him forth. Abaziah met with an injury, and, fearing that it might be unto death, he, as if to prove himself worthy of being the son of idolatrous Ahab and Jezebel, sent to consult Baalzebub, the idol-god of Ekron; but the Angel of the Lord tells Elijah to go forth and meet the messengers of the king (2 Kings i. 3, 4), and assure them that he shall not recover. Suddenly re-appearing before their master, he said unto them, 'Why are ye now turned back? when they answered, 'there came a man up to meet us, and said unto us, Go, turn again unto the king that sent you, and say unto him, thus saith the Lord: is it not because there is no God in Israel that thou sendest to inquire of Baalzebub, the god of Ekron? Wherefore thou shalt not come down from that bed on which thou art gone up, but shalt surely die.' Conscience seems to have at once whispered to him that the man who dared to arrest his messengers with such a communication must be Elijah, the bold but unsuccessful reprover of his parents. Determined to chastise him for such an insult, he sent a captain and fifty armed men to bring him into his presence; but lo! at Elijah's word the fire descends from Heaven and consumes the whole band! Attributing this destruction of his men to some natural cause, he sent forth another company, on whom though the same judgment fell, this impious king is not satisfied till another and a similar effort is made to capture the prophet. The captain of the third band implored mercy at the hands of the prophet, and mercy was granted. Descending at once from Carmel, he accompanies him to Abaziah. Fearless of his wrath Elijah now repeats to the king himself what he had before said to his messengers, and agreeably thereto, the sacred narrative informs us that Abaziah died.

The above was the last more public effort which the prophet made to reform Israel. His warfare being now accomplished on earth, God, whom he had so long and so faithfully served, will translate him in a chariot of fire to Heaven. Conscious of this, he determines to spend his last moments in imparting divine instruction to, and pronouncing his last benediction upon, the students in the colleges of Beth-el and Jericho; accordingly, he made a circuit from Gilgal, near the Jordan, to Beth-el, and from thence to Jericho. Wishing

either to be alone at the moment of being caught up to Heaven; or, what is more probable, anxious to test the affection of Elisha (as Christ did that of Peter), he delicately intimates to him not to accompany him in this tour. But the faithful Elisha, to whom, as also to the schools of the prophets, God had revealed his purpose to remove Elijah, declares with an oath his fixed determination not to forsake his master now at the close of his earthly pilgrimage. Ere yet, however, the chariot of God descended for him, he asks what he should do for Elisha. The latter, feeling that, as the former's successor, he was, in a sense, his son, and, therefore, entitled to a double portion; or rather, conscious of the complicated and difficult duties which now awaited him, asks for a double portion of Elijah's spirit. Elijah, acknowledging the magnitude of the request, yet promises to grant it on the contingency of Elisha seeing him at the moment of his rapture. Possibly this contingency was placed before him in order to make him more on the watch, that the glorious departure of Elijah should not take place without his actually seeing it. Whilst standing on the other side of the Jordan, whose waters were miraculously parted for them to pass over on dry ground, and possibly engaged in discourse about anointing Hazael king over Syria, angels descended, as in a fiery chariot, and, in the sight of fifty of the sons of the prophets and Elisha, carried Elijah into Heaven. Elisha, at this wonderful sight, cries out, like a bereaved child, 'My Father, my Father, the chariot of Israel and the horsemen thereof;' as if he had said, Alas! the strength and saviour of Israel is now departed! But no; God designed that the mantle which fell from Elijah as he ascended should now remain with Elisha as a pledge that the office and spirit of the former had now fallen upon himself.—J. W. D.

ELIM, one of the stations of the Israelites in the route to Mount Sinai. [EXODUS.]

ELIMELECH (אֱלִמֶלֶךְ, *God the King*; Sept. Ἐλιμέλεχ). A native of Bethlehem, husband of Naomi, and father by her of two sons, Mahlon and Chilion. In a time of scarcity he withdrew with his family into the land of Moab, where he died (Ruth i. 1-3). [NAOMI, RUTH.]

1. ELIPHAZ (אֱלִיפָאז, *God the Strong*; Sept. Ἐλιφάσ). A son of Esau and Adah (Gen xxxvi. 10).

2. ELIPHAZ, one of the three friends who came to condole with Job in his affliction, and who took part in that remarkable discussion which occupies the book of Job. He was of Teman in Idumæa; and as Eliphaz the son of Esau had a son called Teman, from whom the place took its name, there is reason to conclude that this Eliphaz was a descendant of the former Eliphaz. Some, indeed, even go so far as to suppose that the Eliphaz of Job was no other than the son of Esau. This view is of course confined to those who refer the age of Job to the time of the patriarchs.

Eliphaz is the first of the friends to take up the debate, in reply to Job's passionate complaints. The scope of his argument and the character of his oratory are described under another head [JOB, BOOK OF]. He appears to have been the oldest of the speakers, from which circumstance,

or from natural disposition, his language is more mild and sedate than that of any of the other speakers. He begins his orations with delicacy, and conducts his part of the argument with considerable address. His share in the controversy occupies chapters iv. v. xv. xxii.

ELISABETH (Ελισάβετ), wife of Zacharias, and mother of John the Baptist (Luke i. 5). The name in this precise shape does not occur in the Old Testament, where the names of few females are given. But it is a Hebrew name, the same in fact as Elisheba, which see.

ELISHA (עִישָׂא, *God the Deliverer*; Sept. Ἐλισαίε). The manner, and the circumstances, in which Elisha was called to the prophetic office have been noticed in the article ELIJAH.

Anxious to enter at once upon the duties of his sacred office, Elisha determined to visit the schools of the prophets which were on the other side of the Jordan. Accordingly, returning to this river, and wishing that sensible evidence should be afforded, both to himself and others, of the spirit and power of his departed master resting upon him, he struck its waters with Elijah's mantle, when they parted asunder and opened a way for him to pass over on dry land. Witnessing this miraculous transaction, the fifty sons of the prophets, who had seen from the opposite side Elijah's ascension, and who were awaiting Elisha's return, now, with becoming reverence, acknowledged him their spiritual head.

These young prophets are not more full of reverence for Elisha than of zeal for Elijah: they saw the latter carried up in the air—they knew that this was not the first time of his miraculous removal. Imagining it therefore possible that the Spirit of God had cast him on some remote mountain or valley, they ask permission to go and seek him. Elisha, though fully aware that he was received up into glory, but yet fearful lest it should be conceived that he, from any unworthy motives, was not anxious to have him brought back, yielded to their request.

The divine authority by which Elisha became the successor of Elijah received further confirmation from the miracle whereby the bitter waters of Jericho were made sweet, and the place thereby rendered fit for the habitation of man (2 Kings ii. 19-22).

As the general visitor of the schools of the prophets, Elisha now passes on from Jericho to the college which was at Beth-el. Ere, however, he entered Beth-el, there met him from thence (2 Kings iii. 23, 24) little children, who no doubt instigated by their idolatrous parents, tauntingly told him to ascend into heaven, as did his master, Elijah! There was in their expressions an admixture of rudeness, infidelity, and impiety. But the inhabitants of Beth-el were to know, from bitter experience, that to dishonour God's prophets was to dishonour Himself; for Elisha was at the moment inspired to pronounce the judgment which at once took effect: God, who never wants for instruments to accomplish his purposes, caused two she-bears to emerge from a neighbouring wood, and destroy the young delinquents.

Jehoram, who reigned over Israel at this time, though not a *Baalite*, was yet addicted to the sin of Jeroboam: still he inherits the friendship of Jehoshaphat, the good King of Judæa, whose

counsel, possibly, under God, had detached him from the more gross idolatry of his father Ahab. Wishing to see the now (u.c. 895) revolted king of Moab reduced to his wonted allegiance to Israel, Jehoshaphat determined to go up to battle against him, together with Jehoram, and his own tributary the king of Edom. These combined armies met together on the plains of Edom. Confident in their own powers they press onward against the enemy; but, not meeting him, another of a more formidable character started up before them. In the midst of the arid plains of Arabia Petraea they could find no water. Jehoram deploras the calamity into which they had fallen, but Jehoshaphat inquired for a prophet. On this, one of his courtiers said to Jehoram, 'Here is Elisha, the son of Shaphat, who poured water on the hands of Elijah.' No sooner were they made acquainted with the fact that Elisha was at hand than the three kings waited upon him. Elisha, feeling that it was nought but superstitious fear, joined to the influence of Jehoshaphat, which led Jehoram thus to consult him, now indignantly and tauntingly advises him to go for succour to the gods of his father Ahab and of his mother Jezebel. The reprov'd monarch was then led to acknowledge the impotency of those gods in whom he had trusted, and the power of that God whom he had neglected. Still the man of God, seeing the hollowness of Jehoram's humiliation, continues: 'As the Lord liveth, before whom I stand, surely were it not that I regard the presence of Jehoshaphat, the king of Judah, I would not look toward thee.' Having thus addressed Jehoram, Elisha desired a minstrel to be brought before him; and now when his spirit is calmed by, perhaps, one of the songs of Zion, Jehovah approaches His prophet in the power of inspiration, as it is written, 'The hand of the Lord came upon him.' The minstrel ceases, and Elisha communicates the joyful intelligence that not only should water be miraculously supplied, but also that Moab should be overcome. 'Thus saith the Lord, Make this valley full of ditches; ye shall not see wind, neither shall ye see the rain; yet that valley shall be filled with water that ye may drink.' Accordingly the next morning they realized the truth of this prediction. But the same water which preserves their lives becomes the source of destruction to their enemies. The Moabites, who had received intelligence of the advance of the allied army, were now assembled upon their frontiers. When the sun was up, and its rosy light first fell upon the water, their van-guard, beholding it at a distance, supposed it to be blood. Thus the notion was rapidly spread from one end to another that the kings were surely slain, having fallen out amongst themselves. Hence there was a universal shout, 'Moab, to the spoil!' and they went forward confident of victory. But who can describe their consternation at beholding the Israelitish squadrons advancing to meet them sword in hand! At once they flee in the utmost panic and confusion; but in vain do they seek to defend themselves, God had decreed their punishment by, and subjugation to, Israel (2 Kings iii. 20, &c.).

The war having terminated in the signal overthrow of the revolters, Elisha, who had returned home, is again employed in ministering blessings. Another case arose to declare the peculiar cha-

rafter of his mission as messenger of mercy to man. The widow of a pious prophet presents herself before him (2 Kings iv), informs him that her husband having died in debt, his creditors were about to sell her two only sons, which, by an extension of the law (Exod. xxi. 7, and Lev. xxv. 39), and by virtue of another (Exod. xxii. 3), they had the power to do; and against this hard-hearted act she implores the prophet's assistance. God will not, *without a cause*, depart from the general laws of His administration: Elisha therefore inquires how far she herself had the power to avert the threatened calamity. She replies that the only thing of which she was possessed was one pot of oil. By multiplying this, as did his predecessor Elijah in the case of the widow of Zarephath, he enabled her at once to pay off her debts and thereby to preserve the liberty of her children (2 Kings iv. 1-7).

Having thus contemplated Elisha in the act of relieving the wants of a poor widow, we may with the more pleasure observe how, in the arrangement of God's providence, his own necessities were, in turn, supplied. In his visitations to the schools of the prophets it would seem that his journey lay through the city of Sionem, where lived a rich and godly woman. Wishing that he should take up, more than occasionally, his abode under her roof, she proposed to her husband to construct for him a chamber, where, far from the society of man, he might hold solitary and sweet communion with his God. The husband at once consented, and, the apartment being completed and fitted up in a way that showed their proper conception of his feeling, the prophet becomes its occupant. Grateful for such disinterested kindness, Elisha delicately inquired of her if he could prefer her interest before the king or the captain of his host; for he must have had considerable influence at court, from the part he had taken in the late war. But the good woman declined the prophet's offer, by declaring that she would rather 'dwell among her own people,' and in the condition of life to which she had been accustomed. Still, to crown her domestic happiness, she lacked one thing—she had no child, and now, by reason of the age of her husband, she could not expect such a blessing. In answer, however, to the prayer of the prophet, and contrary to all her own conclusions, God causes her to conceive and bring forth a son (B.C. 891). This new pledge of their affection grows up till he is able to visit his fond father in the harvest-field, when all the hopes they had built up in him were overthrown by his being suddenly laid prostrate in death.

The bereaved mother, with exquisite tenderness towards the feelings of the father, concealed the fact that the child was no more till she should see if it might please God, through Elisha, to restore him to life. She therefore hastens to Carmel, where she found the prophet, and informed him what had taken place. Conceiving probably that it was a case of mere suspended animation, or a swoon, the prophet sent Gehazi, his servant, to place his staff on the face of the child, in the hope that it might act as a stimulus to excite the animal motions. But the mother, conscious that he was actually departed, continued to entreat that he himself would come to the chamber of the dead. He did so, and found that the soul of the child had ~~is. 26~~ fled from the earthly tenement.

Natural means belong to man; those that are supernatural belong to God: we should do our part, and beg of God to do his. On this principle the prophet on this occasion acted. God blesses the means used, and answers the prayer presented by Elisha. The child is raised up and restored to the fond embrace of its grateful and rejoicing parents.

The next remarkable event in the history of Elisha was the miraculous healing of the incurable leprosy of the Syrian general Naaman, whereby the neighbouring nation had the opportunity of learning the beneficence of that God of Israel, whose judgments had often brought them very low. The particulars are given under another head [NAAMAN].

Soon after this transaction we find this man of God in Gilgal, miraculously neutralizing the poison which had, by mistake, been mixed with the food of the prophets, and also feeding one hundred of them with twenty small loaves which had been sent for his own consumption (2 Kings iv. 38, &c.). In his tender regard to the wants of others, and in the miracles he wrought, how like he was to the Saviour of the world!

Notwithstanding the general profligacy of Israel, the schools of the prophets increased, B.C. 891. This was, doubtless, owing to the influence of Elisha. Accompanied by their master, a party of these young prophets, or theological students, came to the Jordan, and whilst one of them was 'felling a beam (for the purpose of constructing there a house) the axe-head fell into the water.' This accident was the more distressing because the axe was borrowed property. Elisha, however, soon relieved him by causing it miraculously to rise to the surface of the river.

The sacred record again leads us to contemplate the prophet's usefulness, not only in such individual points of view, but also in reference to his country at large. Does the king of Syria devise well-concerted schemes for the destruction of Israel? God inspires Elisha to detect and lay them open to Jehoram. Benhadad, on hearing that it was he that thus caused his hostile movements to be frustrated, sent an armed band to Dothan in order to bring him bound to Damascus. The prophet's servant, on seeing the host of the enemy which invested Dothan, was much alarmed, but by the prayer of Elisha God reveals to him the mighty company of angels which were set for their defence. Regardless of consequences, the prophet went forth to meet the hostile band; and having again prayed, God so blinded them that they could not recognise the object of their search. The prophet then promised to lead them to where they might see him with the natural eye. Trusting to his guidance they followed on till they reached the centre of Samaria, when, the optical illusion being removed, Elisha stands in his recognised form before them! Who can tell their confusion and alarm at this moment? The king is for putting them all to death; but, through the interposition of him whom they had just before sought to destroy, they were honourably dismissed to their own country (B.C. 892). But a year had scarcely elapsed from this time when Benhadad, unmindful of Israel's kindness and forbearance, invests Samaria and reduces its inhabitants to such a state of starvation that an *ass's head*, a proscribed animal by the Levitical law, was sold

for fourscore pieces of silver, and the fourth part of a cab—a quart or three pints—of dove's dung for five pieces of silver [DOVE'S DUNGE]. But this was not all. Parents were found, if not murdering, actually eating their deceased children. These very calamities Moses had foretold should come upon them if they forsook God (Deut. xxviii. 53-57). Still the king of Israel plunges deeper and deeper into sin, for he orders Elisha to be put to death, conceiving that it was his prayer which brought these sufferings upon himself and nation. But God forewarns him of his danger, and inspires him to predict to the wicked king that by to-morrow 'a measure of fine flour should be sold for a shekel, and two measures of barley for a shekel, in the gate of Samaria.' This assurance was not more comfortable than incredible; but when the lord on whose hand the king leaned expressed his disbelief, he was awfully rebuked by the assurance that he should see but not enjoy the benefit. The next night God caused the Syrians to hear the noise of chariots and horses; and conceiving that Jehoram had hired against them the kings of the Hittites and the king of Egypt, they fled from before the walls of Samaria—leaving their tents filled with gold and provisions—in the utmost panic and confusion. In this way did God, according to the word of Elisha, miraculously deliver the inhabitants of Samaria from a deadly enemy without, and from sore famine within, its walls: another prediction moreover was accomplished; for the distressed lord was trampled to death by the famished people in rushing through the gate of the city to the forsaken tents of the Syrians (2 Kings vii.).

We are next led, in the order of the history, though *not in that of time*, to notice God's gracious care of the woman of Shunem. Having followed the advice of her kind friend Elisha, she resided in Philistia during the seven years' famine in Israel. On her return, however, she found that her paternal estate had been seized by others. She at once went to the king, who at the moment of her approach was talking with Gehazi as to Elisha having miraculously raised her son to life. This was a very providential coincidence in behalf of the Shunemite. The relation given by Gehazi was now corroborated by the woman herself. The king was duly affected, and gave immediate orders for the restoration of her land and all that it had yielded during her absence. We next find the prophet in Damascus, but are not told what led him thither (B.C. 885). Benhadad, the king, whose counsels he had so often frustrated, rejoiced to hear of his presence; and now, as if he had forgotten the attempt he once made upon his life, dispatches a noble messenger with a costly present, to consult him concerning his sickness and recovery. The prophet replied that he should then die, though his indisposition was not of a deadly character. Seeing moreover, in prophetic vision, that the man Hazael, who now stood before him, should be king in Benhadad's stead; and that, as such, he would commit unheard-of cruelties upon his country, the prophet was moved to tears. How these painful anticipations of Elisha were realized the subsequent history of this man proved. Some twenty-three years had now elapsed since Elijah had prophesied the destruction of Ahab's guilty

consort and family. But God's declared judgments are sure though delayed. Not only Ahab and Jezebel had been bloody and idolatrous, but Israel had become partakers in their crimes, and must share in the judgment. Elijah's complaint in the cave now received this late answer: 'Hazeael shall plague Israel: Jehu shall plague the house of Ahab and Jezebel.' How fearfully these declared purposes of God took effect we may read in 2 Kings ix. and x.

For a considerable time after Elisha had sent to anoint Jehu king over Israel we find no mention of him in the sacred record. We have reason to suppose that he was utterly neglected by Jehu, Jehonadab, and Joash, who reigned in succession. Neither the sanctity of his life nor the stupendous miracles he wrought had the effect of reforming the nation at large: much of the time of his latter years was, doubtless, spent in the schools of the prophets. At length, worn out by his public and private labours, and at the age of 90—during 60 of which he is supposed to have prophesied—he is called into eternity. Nor was the manner of his death inglorious; though he did not enter into rest as did Elijah (2 Kings xiii. 14, &c.). Amongst his weeping attendants was Joash, the king of Israel. He was probably stung with remorse for having so neglected to acknowledge his national worth; yet, though late, God does not suffer this public recognition of his aged and faithful servant to go unrequited. The spirit of prophecy again entering the dying Elisha, he informs Joash that he should prevail against the Syrians. Even after death God would put honour upon Elijah: a dead body having touched his bones came to life again! (2 Kings xiii. 21.)

Elisha was not less eminent than his predecessor Elijah. His miracles are various and stupendous, and, like those which were wrought by Christ, were on the whole of a merciful character. In this they were remarkably distinguished, in many instances, from the miracles of Elijah.—

J. W. D.

ELISHAH (עִישָׁה; Sept. Ἐλισᾶ), a son of Javan (Gen. x. 4), who seems to have given name to 'the isles of Elishah,' which are described as exporting fabrics of purple and scarlet to the markets of Tyre (Ezek. xxvii. 7). If the descendants of Javan peopled Greece, we may expect to find Elishah in some province of that country. The circumstance of the purple suits the Peloponnesus; for the fish affording the purple dye was caught at the mouth of the Eubotas, and the purple of Laconia was very celebrated. The name seems kindred to Elis, which, in a wider sense, was applied to the whole Peloponnesus; and some identify *Elishah* with *Hellas*. The uncertainty of all this speculation is most apparent: but it may be added that, if probable thus far, it is equally probable that the general name of 'the isles of Elishah' may also have been extended to the islands of the Ægean sea; a part of which may seem to have derived the name of Hellespont, sea of Hellas, from the same source.

ELISHEBA (עִישָׁבֶת, *covenant-God*; Sept. Ἐλισαβέθ), wife of Aaron, and hence the mother of the priestly family (Exod. vi. 23).

ELKANAH (עֵלְכָנָה, *God the Jealous*; Sept. Ἐλκανά). Several persons of this name are men-

tioned in Scripture, as a son of Korah (Exod. vi. 24; 1 Chron. vi. 23); the father of Samuel (1 Sam. i. 1. seq.; ii. 11-20; 1 Chron. vi. 27); a friend of King Ahab (2 Chron. xxviii. 7); one of David's heroes (1 Chron. xii. 6); Levites (1 Chron. vi. 23, 25, 26, 27; xv. 23).

ELKOSH. The prophet Nahum is called an Elkoshite (עֲלֻכֹשִׁי), that is, a native of some place called Elkosh (Nahum i. 1). There was a village of this name in Galilee in the time of Jerome; but the prophet was more probably born of Jewish exiles at Elkosh or Alkushi in Assyria, near Mosul. The Jews themselves believe that he was born and buried there; and Jewish pilgrims from all parts still visit his alleged tomb. On this Mr. Rich remarks, 'The Jews are generally to be trusted for local antiquities. Their pilgrimage to a spot is almost a sufficient test. The unbroken line of tradition which may have been handed down among them, and their pertinacious resistance of all innovation, especially in matters of religious belief, render their testimony very weighty in such matters' (*Residence in Koordistan*, p. 111). Alkosh is thirty-four miles north of Mosul (Nineveh), and is situated a little way up the side of a mountain, in the range to which it gives its name. It is entirely inhabited by Chaldee Christians, who have a convent higher up the mountains.

ELLASAR (עֲלָסָר; Sept. Ἐλλάσαρ), a territory in Asia, whose king, Arioch, was one of the four who invaded Canaan in the time of Abraham (Gen. xiv. 1). The association of this king with those of Elam and Shinar, indicates the region in which the kingdom should be sought; but nothing further is known of it, unless it be the same as Thelassar mentioned in 2 Kings xix. 12 [THELASSAR].

ELM. The Authorized Version has this word in Hosea iv. 13. But the original word there is מֵלֶךְ, which is differently translated in every other place [ALAH].

ELOHIM. [GOD.]

ELON (עֵלֹן; Sept. Αἰλώμ, Ἐλώμ), of the tribe of Zebulun, who judged Israel ten years. He was preceded by Ibzan of Bethlehem, and succeeded by Abdon of Ephraim. The whole period covered by their administration was twenty-five years (from B.C. 1190 to 1174); but it is probable that they were for a part of this time contemporary, each exercising authority over a few of the tribes. They appear to have overawed the enemies of Israel by their judicious administration; for no war is mentioned in their time (Judg. xii. 8-15).

ELUL (אֱלוּל; Neh. vi. 15; Sept. Ἐλουλά; the Macedonian Γορπαιός) is the name of that month which was the sixth of the ecclesiastical, and twelfth of the civil, year of the Jews, and which began with the new moon of our September. Several unsatisfactory attempts have been made to find a Syro-Arabian etymology for the word. The most recent derivation, that of Benfey, deduces it, through many commutations and mutilations, from an original Zend form *haurvatdt* (*Monatsnamen*, p. 126). According to the Megilat Taanith, the 17th day of this month was a public fast for the death of the spies who brought

back a bad report of the land (Num. xiv. 37).—J. N.

ELYMAS (Ἐλύμας), an appellative commonly derived from the Arabic *علم* *Aliman* (a wise man), which Luke interprets by *ὁ μάγος*: it is applied to a Jew named Bar-Jesus, mentioned in Acts xiii. 6-11 (*v. Neander's Hist. of first planting of the Christian Church*, i. p. 125, Eng. transl.). A very different but less probable derivation of the word is given by Dr. Lightfoot in his Hebrew and Talmudical Exercitations on the Acts (Works, viii. p. 461), and in his *Sermon on Elymas the Sorcerer* (Works, vii. p. 101). Chrysostom observes, in reference to the blindness inflicted by the Apostle on Bar-Jesus, that the limiting clause 'for a season,' shows that it was not intended so much for the punishment of the sorcerer as for the conversion of the deputy. *Εἰ γὰρ κολάζοντος ἦν, διαπαντός ἂν αὐτὸν εἴποισε τυφλόν, νῦν δὲ οὐ τοῦτο, ἀλλὰ πρὸς καιρὸν. ἵνα τὸν ἀνθρώπου κερδάηη.* Chrysost. in *Acta Apost. Homil.* xxviii.; *Opera*, tom. ix. p. 241.—J. E. R.

EMBALMIN. [BURIAL.]

EMERALD. [NOPHELIUM.]

EMERODS, a painful disease with which the Philistines were afflicted (1 Sam. v. 6) [TECHONIM].

EMIM (עֲמִי; Sept., Ὀμμίν), a numerous and gigantic race of people who, in the time of Abraham, occupied the country beyond the Jordan, afterwards possessed by the Moabites (Gen. xiv. 5; Deut. ii. 10).

EMMAUS (Ἐμμαοῦς), a village 60 stadia, or 7½ miles, from Jerusalem, noted for our Lord's interview with two disciples on the day of his resurrection (Luke xxiv. 13). The same place is mentioned by Josephus (*De Bell. Jud.* vii. 6, 6), and placed at the same distance from Jerusalem, in stating that Vespasian left 800 soldiers in Judæa, to whom he gave the village of Emmaus. The site is not now known; for Dr. Robinson has shown that El Kubeibeh, which is usually indicated, is too distant from Jerusalem; and that the position of Emmaus, and all correct tradition respecting it, were lost before the time of Eusebius and Jerome; since these writers make it identical with the city of Emmaus, or Nicopolis, which lies not far from 160 stadia from Jerusalem. He adds:—'There never was the slightest ground for connecting El-Kubeibeh in any way with Emmaus; nor is there any trace of its having been so connected before the fourteenth century' (*Bib. Researches*, iii. 65, 66). The other Emmaus, also called Nicopolis, just mentioned, is identified with Lusium, about midway between Jerusalem and Ramleh. There was another Emmaus, near Tiberias, on the lake of the same name, where the hot baths which gave name to it are still frequented, and have a temperature of 130 Fahrenheit. Here the name Emmaus is merely preserved in that of Hammam, which the Arabs give to hot-baths, whether natural or artificial. Neither of these places is named in Scripture.

EN, properly **AIN**, a word signifying 'fountain;' and hence entering into the composition of sundry local names, which are explained under **AIN**.

ENCAMPMENTS. Of the Jewish system of encampment the Mosaic books have left a de-

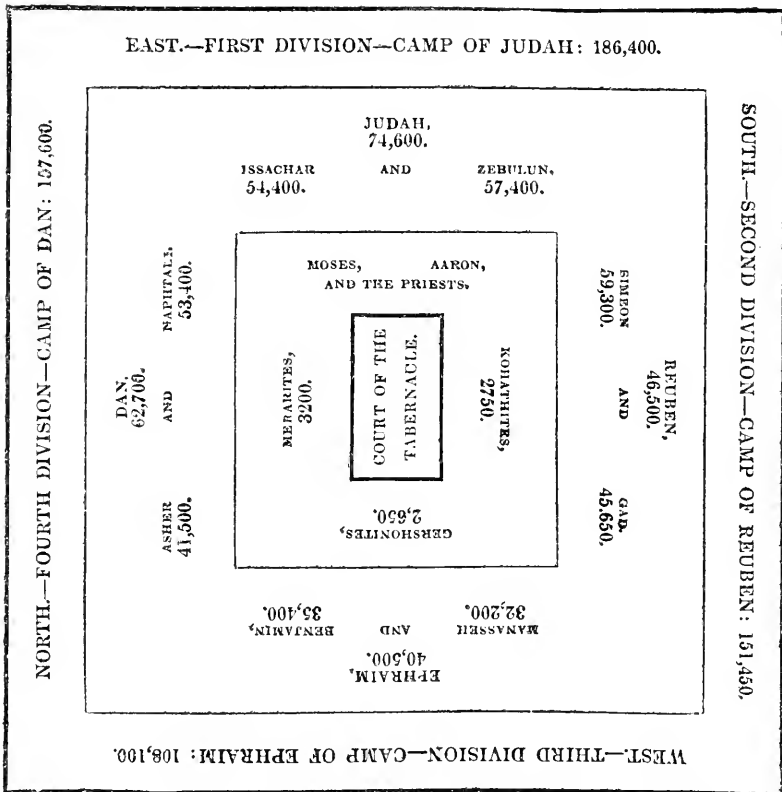

tailed description. From the period of the sojourn in the wilderness to the crossing of the Jordan the twelve tribes were formed into four great armies, encamping in as many fronts, or forming a square, with a great space in the rear, where the tabernacle of the Lord was placed, surrounded by the tribe of Levi and the bodies of carriers, &c., by the stalls of the cattle and the baggage: the four fronts faced the cardinal points while the march was eastward, but as Judah continued to lead the van, it follows that when the Jordan was to be crossed the direction became westward, and therefore the general arrangement, so far as the cardinal points were concerned, was reversed.* It does not appear that, during this time, Israel ever had lines of defence thrown up; but in after ages, when only single armies came into the field, it is probable that the castral disposition was not invariably quadrangular; and, from the many positions indicated on the crests of steep mountains, the fronts were clearly adapted to the ground and to the space which it was necessary to occupy. The rear of such positions, or the square camps in the plain, appear from the marginal reading of 1 Sam. xvii. 20, and xxvi. 5 to have been enclosed with a line of

carts or chariots, which, from the remotest period, was a practice among all the nomade nations of the north. The books of Moses are so explicit on the subject of encampment, and the march of the Israelites, that we deem a distinct plan of the numbers and position of the twelve tribes, of the various corps of Levites, &c., with the tents of Moses and Aaron ranged about the tabernacle, and other particulars, sufficient to give a very clear idea of the whole, and to supersede the necessity of further description.—C. H. S.

ENCHANTMENTS. [DIVINATION.]

ENDOR (עֵדוֹר, *house-fountain*; Sept. Ἐνδῶρ), a town of Galilee, assigned to Manasseh, although lying beyond the limits of that tribe (Josh. xvii. 11). It is mentioned in connection with the victory of Deborah and Barak (Ps. lxxxiii. 10); but is chiefly memorable as the abode of the sorceress whom Saul consulted on the eve of the battle in which he perished (1 Sam. xxviii. 7, sq.) The name is not found in the New Testament; but in the time of Eusebius and Jerome the place still existed as a large village, four miles south of Mount Tabor. At this distance, on the northern slope of the lower ridge of Hermon, a village with this name still exists.

EN-EGLAIM (עֵינַיִם עֵגְלָיִם, *calves' fountain*; Sept. Ἐναγαλλεῖμ), a town of Moab (Ezek. xlvii. 10), which Jerome places at the northern end of the Dead Sea, at the influx of the Jordan.

* If the leading tribes did not thus turn with the direction of the march, Judah and his two wings must have formed the rear in crossing the Jordan.

EN-GANNIM (עִנְיָן, *gardens' fountain*; Sept. 'Hv-Faviva). 1. A town of Judah (Josh. xv. 34), which Jerome places near Beth-el. 2. A Levitical city in Issachar (Josh. xix. 21; xxi. 29), probably the same as the Gimaen of Josephus (*Antiq.* xx. 6, 1), and which Biddulph (in *Purchas*, vol. ii. p. 135) identifies with the present Jenin, a town 15 miles south of Mount Tabor, and which he and others describe as still a place of gardens and abundant water. He adds that in his whole journey from Damascus to Jerusalem, he nowhere saw so much fruitful ground together, as in riding between this place and Mount Tabor. 3. Jerome mentions another place, called En-gannim, beyond the Jordan, near Geraza; and the name seems, indeed, to have been very common for places where water, and consequently gardens, abounded.

EN-GEDI (עֵינַן, *hids' fountain*; Sept. 'Evaşân) a city of Judah, which gave its name to a part of the desert to which David withdrew for fear of Saul (Josh. xv. 62; 1 Sam. xxiv. 1-4). Its more ancient Hebrew name was Hazezon-tamar; and by that name it is mentioned before the destruction of Salom, as being inhabited by the Amorites, and near the cities of the plain (Gen. xiv. 7). In 2 Chron. xx. 1, 2, bands of the Moabites and Ammonites are described as coming up against king Jehoshaphat, apparently round the south end of the Dead Sea, as far as En-gedi. And this, as we learn from Dr. Robinson, is the route taken by the Arabs in their marauding expeditions at the present day. According to Josephus, En-gedi lay upon the lake Asphaltites, and was celebrated for its beautiful palm trees and opobalsum (*Antiq.* ix. 1, 2); while its vineyards are also mentioned in Sol. Song, i. 14. In the time of Eusebius and Jerome, En-gedi was still a large village on the shore of the Dead Sea. En-gedi has always, until recently, been sought at the north end of the Dead Sea. But Setzen recognised the ancient name in the Ain-jidy of the Arabs, and lays it down in his map at a point of the western shore, nearly equidistant from both extremities of the lake. This spot was visited by Dr. Robinson, and he confirms the identification. The site lies among the mountains which here confine the lake, a considerable way down the descent to its shore. Here is the beautiful fountain of Ain-jidy, bursting forth at once in a fine stream upon a sort of narrow terrace or shelf of the mountain, above 400 feet above the level of the lake. The stream rushes down the steep descent of the mountain below; and its course is hidden by a luxuriant thicket of trees and shrubs belonging to a more southern clime. Near this fountain are the remains of several buildings, apparently ancient; although the main site of the town seems to have been farther below. The whole of the descent below appears to have been once terraced for tillage and gardens; and near the foot are the ruins of a town, exhibiting nothing of particular interest, and built mostly of unhewn stones. This we may conclude to have been the town which took its name from the fountain (*Robinson*, ii. 209-216).

THE WILDERNESS OF EN-GEDI is doubtless the immediately neighbouring part of the wild region, west of the Dead Sea, which must be traversed to reach its shores. It was here that David

and his men lived among the 'rocks of the wild goats,' and where the former cut off the skirts of Saul's robe in a cave (1 Sam. xxi. 1-4). 'On all sides,' says Dr. Robinson, 'the country is full of caverns, which might then serve as lurking-places for David and his men, as they do for outlaws at the present day.' He adds that as he came in sight of the ravine of the Ghâr, a mountain-goat started up and bounded along the face of the rocks on the opposite side.

ENGINES OF WAR were certainly known much earlier than the Greek writers appear to admit, since figures of them occur in Egyptian monuments, where two kinds of the testudo, or pent-house, used as shelters for the besiegers, are represented, and a colossal lance, worked by men who, under the cover of a testudo, drive the point between the stones of a city wall. The chief projectiles were the catapultæ for throwing darts, and the balista for throwing stones. Both these kinds of instruments were prepared by Uzziah for the defence of Jerusalem (2 Chron. xxvi. 15), and battering the wall is mentioned in the reign of King David (2 Sam. xx. 15); but the instrument itself for throwing it down may have been that above-mentioned, and not the battering-ram. The ram was, however, a simple machine, and capable of demolishing the strongest walls, provided access to the foot was practicable; for the mass of cast metal which formed the head could be fixed to a beam lengthened sufficiently to require between one and two hundred men to lift and impel it;* and when it was still heavier and hung in the lower floor of a movable tower, or *helipolis*, it became a most formidable engine of war—one used in all great

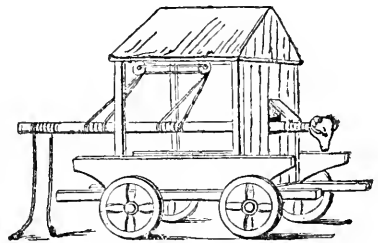

280. [Battering Ram.]

siege from the time of Demetrius, about B.C. 306, till long after the invention of gunpowder. Towers of this kind were largely used at the destruction of Jerusalem by the Romans. Of the balista and catapultæ it may be proper to add that they were of various powers. For battering walls there were some that threw stones of fifty, others of one hundred, and some of three hundred weight; in the field of battle they were of much inferior strength. Darts varied similarly from small beams to large arrows, and the range they had exceeded a quarter of a mile, or about 450 yards. All these engines were constructed upon the principle of the sling, the bow, or the spring, the last being an elastic bar, bent back by

* The Algerines, about two centuries ago, took the lower mast of one of their frigates and impelled it by firing 400 slaves to use their personal strength in the work.

a screw or a cable of sinews, with a trigger to set it free, and contrived either to impel darts by its

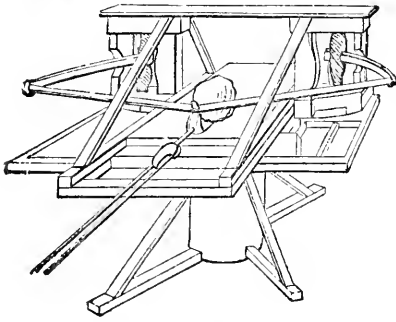

281. [Balista.]

stroke, or to throw stones from a kind of spoon formed towards the summit of the spring.—

C. H. S.

ENGRAVING. [SEALS, WRITING.]

ENOCH (עֲנוֹךְ; Sept. and New Test. Ἐνώχ).

Four persons bearing this name are mentioned in the Old Testament, the most distinguished of whom was the son of Jared and father of Methuselah. According to the Old Testament, *he walked with God*; and, after 365 years, *he was not, for God took him* (Gen. v. 24). The inspired writer of the Epistle to the Hebrews says, 'By faith Enoch was translated that he should not see death, and was not found, because God had translated him' (xi. 5). *Walking with God* implies the closest fellowship with Jehovah which it is possible for a human being to enjoy on earth. As a reward, therefore, of his extraordinary sanctity, he was transported into heaven without the experience of death. Elijah was in like manner translated; and thus was the doctrine of immortality palpably taught under the ancient dispensation. The traditions of the Jews have ascribed to Enoch many fabulous qualities. They have invested him with various attributes and excellencies for which the Bible furnishes no foundation. Accordingly, he is represented as the inventor of letters, arithmetic, and astronomy; as the *first author*, from whom several books emanated. Visions and prophecies were commonly ascribed to him, which he is said to have arranged in a book. This book was delivered to his son, and preserved by Noah in the ark. After the flood it was made known to the world, and handed down from one generation to another. Hence the Arabians call him **أدریس**

Edris, i. e. *the learned* (Koran, Sur. xix). See Juhasin, f. 131; Eusebius, *Præpar. Evang.* ix. 17, and *Hist. Eccles.* vii. 32; Barhebr. *Chron.* p. 5.—S. D.

ENOCH, BOOK OF. The interest that once attached to the apocryphal book of Enoch has now partly subsided. Yet a document quoted, as is generally believed, by an inspired apostle, can never be wholly devoid of importance or utility in sacred literature. We shall allude to the following particulars relating to it:—

1. The history of the book of Enoch.
2. The language in which it was written.
3. Its form and coherence.

4. Its author, and the time when it was written.

5. The place where it was written.

6. Did Jude really quote it?

7. Its use.

In several of the fathers mention is made of Enoch as the author, not only of a prophetic writing, but of various productions. The book of Enoch is alluded to by Justin Martyr, Irenæus, Clement of Alexandria, Tertullian, Origen, Augustine, Jerome, Hilary, and Eusebius. It is also quoted on various occasions in the *Testament of the Twelve Patriarchs*, a document which Nitzsch has shown to belong to the latter part of the first century or the beginning of the second. The passages in these ancient writings relating to our present purpose have been carefully collected by Fabricius in his *Codex Pseud-epigraphus* (vol. i. pp. 160-224); to which, and to the first *Excursus* of Hoffmann, we refer our readers. In the eighth century Georgius Syncellus, in a work entitled *Chronographia*, that reaches from Adam to Diocletian, made various extracts from 'the first book of Enoch.' In the ninth century Nicephorus, patriarch of Constantinople, at the conclusion of his *Chronographia Compendium*, in his list of canonical and uncanonical books, refers to the book of Enoch, and assigns 4500 *στίχοι* as the extent of it. After this time little or no mention appears to have been made of the production until Scaliger printed the fragments of Syncellus regarding it, which he inserted in his notes to the *Chronicus Canon* of Eusebius. In consequence of such extracts the book of Enoch excited much attention and awakened great curiosity. At the beginning of the seventeenth century an idea prevailed that it existed in an Ethiopic translation. A Capuchin monk from Egypt assured Peiresce that he had seen the book in Ethiopic, a circumstance which excited the adour of the scholar of Pisa so much, that he never rested until he obtained the tract. But when Job Ludolph went afterwards to Paris to the Royal Library, he found it to be a fabulous and silly production. In consequence of this disappointment the idea of recovering it in Ethiopic was abandoned. At length Bruce brought home three copies of the book of Enoch from Abyssinia. 'Amongst the articles,' he states, 'I consigned to the library at Paris, was a very beautiful and magnificent copy of the prophecies of Enoch in large quarto. Another is amongst the books of Scripture which I brought home, standing immediately before the book of Job, which is its proper place in the Abyssinian Canon; and a third copy I have presented to the Bodleian Library at Oxford by the hands of Dr. Douglas, bishop of Carlisle.' As soon as it was known in England that such a present had been made to the Royal Library at Paris, Dr. Woide, librarian of the British Museum, set out for France with letters from the secretary of state to the ambassador at that court, desiring him to assist the learned beaver in procuring access to the work. Dr. Woide accordingly transcribed it, and brought back with him the copy to England. The Parisian MS. was first publicly noticed by the eminent Orientalist De Sacy, who translated into Latin ch. i. ii. iii. iv.-xvi., also xxii. and xxxi. These he also published in the *Magasin Encyclopédique*, an vi. tom. i. p. 3^o2 et seq. Mr. Murray, editor of *Bruce's Travels*, gave some account of

the book from the traveller's own MS. The Bodleian MS. was translated into English by Dr. Laurence, then Professor of Hebrew in Oxford; and thus the public were favoured, for the first time, with the whole book in English, A.D. 1821. In 1833 a second, improved edition of the translation appeared; and, in 1838, the third edition, revised and enlarged. To the translation is prefixed a preliminary dissertation of 59 pages, giving some account of the book, its author, the time and place of its composition, &c. &c. It has also been translated into German by Dr. Hoffmann of Jena. According to Angelo Mai there is a MS. copy of the book of Enoch among the Ethiopic codices of the Vatican, which must have been brought into Europe earlier than Bruce's MSS. In 1834 Dr. Rüppell procured another MS. of Enoch from Abyssinia, from which Hoffmann made the second part of his German version.

There can be no doubt that the Ethiopic translation exhibits the identical book, which, as most believe, Jude quoted, and which is also mentioned or cited by many of the fathers. The fragment preserved by Syncellus (reprinted by Laurence and Hoffmann) is obviously the same as ch. vii., &c., the deviations being of little importance and probably accidental. It is manifest also, to any one who will compare the quotations made by the fathers with the Ethiopic version, that both point to the same original. The extracts in question could not have been interpolations, as they are essential to the connections in which they are found.

The book was never received into the series of canonical writings. The *Apostolical Constitutions* expressly style it *apocryphal* (vi. 16), while Origen (*contra Celsum*) affirms that it was not reckoned divine by the churches; although in another place he hints that some of his contemporaries were of a different opinion. In the *Synopsis of Scripture* published with the works of Athanasius, as well as in the writings of Jerome and Augustine, its non-canonicity is distinctly stated. The only ancient writer who reckoned it of divine authority was Tertullian, who undertakes to defend it against the objections by which it was then assailed (see his treatise *De Cultu Faminarum*). His arguments, however, are exceedingly puerile.

The Greek translation, in which it was known to the fathers, appears to be irrecoverably lost. There is no trace of it after the eighth century. The last remnant of it is preserved by Syncellus.

The leading object of the writer, who was manifestly imbued with deep piety, was to comfort and strengthen his contemporaries. He lived in times of distress and persecution, when the enemies of religion oppressed the righteous. The outward circumstances of the godly were such as to excite doubts of the divine equity in their minds, or at least to prevent it from having that hold on their faith which was necessary to sustain them in the hour of trial. In accordance with this, the writer exhibits the reward of the righteous and the punishment of the wicked. To give greater authority to his affirmations, he puts them into the mouth of Enoch. Thus they have all the weight belonging to the character of an eminent prophet and saint. Various digressions are not without their bearing on the author's main purpose. The narrative of the fallen angels and their punishment, as also of the

flood, exemplifies the retributive justice of Jehovah; while the Jewish history, continued down to the Maccabees, exhibits the final triumph of His people, notwithstanding all their vicissitudes. Doubtless the author lived amid fiery trial; and, looking abroad over the desolation, sought to cheer the sufferers by the consideration that they should be recompensed in another life. As for their wicked oppressors, they were to experience terrible judgments. The writer seems to delight in uttering dire anathemas against the wicked. It is plain that the book grew out of the time when the author lived, and the circumstances by which he was surrounded. It gives us a glimpse not only of the religious opinions, but also of the general features that characterized the period.

2. *The language in which it was written.*—Several circumstances render it apparent that the book before us was originally composed in the Hebrew or Chaldee language. This was long since perceived by Joseph Scaliger, although he had before him nothing more than the Greek fragment preserved by Syncellus. The book of Zohar, in which are various allusions to Enoch, seems to speak of it as an important Hebrew production which had been handed down from generation to generation. The Cabbalists, whose opinions are embodied in Zohar, thought that Enoch was really the author, a sentiment quite at variance with any other hypothesis than that of a Hebrew original. The names of the angels (ch. vii. viii. and ix.) also point to a Hebrew origin, and can be most easily derived from Hebrew roots. Thus Tamiel

(viii. 7) is compounded of תן and לן , the *upright of God*; Samyaza of שם and נין , the *name of the strong*. The same conclusion follows from the term Ophanias (ix. 13), which is evidently identical with the Hebrew פנין . It is remarkable also, that as Ophanin occurs in connection with the Cherubim, so the Hebrew term פנין is found in the same association (1 Kings vii. 30; Ezek. i. 15, 16, 19, 20, 21; and x. 2, 6, 9, 10, &c.; Murray's *Enoch Restitutas*, p. 33, sq.). Other particulars corroborate the same inference. Thus in ch. lxxvi. 1, it is written, 'The first wind is called the east, because it is the first.' The *first* and the *east* have an affinity in the Hebrew, which explains the phraseology, since קדם , as well as its derivatives, signifies both the *east* and the *first*. But neither in the Ethiopic nor in the Greek is there such affinity. In the same manner may the next sentence be explained. 'The second wind is called the south, because the Most High there descends.' What is said respecting the *western* wind, may be employed in confirmation of the same conclusion. It is highly probable, too, that the names of the conductors of the month (ch. lxxxi. 23) are pure Hebrew (Murray, p. 46; Hoffmann, p. 690). Other presumptive evidences in favour of a Hebrew original may be collected by the attentive reader.

The Ethiopic version was made from the Greek, not the Hebrew.

3. *Its form and coherence.*—In the MSS. the whole is divided into chapters and verses, although they vary in their specification of such compartments. There are 105 chapters of unequal length, and often injudiciously made; while there are 19 sections or larger divisions.

The want of coherence among its several parts

is obvious. Detached portions are put together without regard to their mutual connection. The work seems in fact to be made up of several pieces, which, having been separately composed, were afterwards thrown together without care. Various chapters occupy an unsuitable position in the MSS. Hence Laurence has been obliged in one case to rectify what he justly conceived to be erroneous by transferring to their proper place the verses badly located according to the Bodleian MS.

Laurence remarks, that 'the book may have been composed at different periods; perhaps it might be also added, that there may have been different tracts, as well as tracts composed by different authors.' This idea has been taken up by Murray, and expanded in a treatise of considerable research and great ingenuity. Proceeding upon the hypothesis that the book consists of various tracts on different subjects, he endeavours to disentangle them from one another, and to class them under their appropriate heads. In the prosecution of an extended inquiry he endeavours to show, that the different parts of the present work possess unequal authority, and belong to very different times. He has therefore selected what he conceives to be the ancient book quoted by Jude, and attributes its origin to Enoch himself. The later additions now incorporated with it belong to other writings, and have been mingled together. The ingenious author has been guided by the connection of one part with another, and the similarity or dissimilarity of subject. *The ancient book*, as it is denominated by him, to which he principally confines his attention, is said to consist of the following parts: chapters i. and ii.; xlv. 2-5; xlvii. 1-4; xlviii. 2; l. 5; lvi. 2-5; lx. 7; lxi. 18; lxviii. 34-41. The other parts he has selected and arranged under the heads of a *prophecy*, consisting of the xcii. chapter; *second book*, imitated from that which he has endeavoured to restore; *two books of the angels or watchers*; *two books concerning secret things*, called *visions of wisdom*; *the vision of Noah and history*; *vision of Noah*; and *the book of astronomy*. Such is the mode in which the whole document before us is separated and arranged. Yet there is much reason to doubt its correctness and success. If the looseness with which the parts frequently hang together, and the transition from one sort of writing to another, as from the historic to the prophetic, be reckoned a good ground for dismemberment, the book of Daniel presents similar features. It cannot indeed be denied that several chapters, such as xxxvii. sq., lxiv. sq., lxxi. sq., xcii. xciii. sq., cv, do not coincide with the preceding or subsequent portions, or with the manifest object of the writer. Some parts again are very unsuitable, and altogether foreign to their present position. Yet it appears to us much more probable, that a number of tracts embodying different traditions were put together about the same period, and by one person. Much may be done by transposition to restore a measure of unity, although a disunited character will still belong to the whole. Perhaps some parts have been lost, as may be inferred from allusions to Enoch in early writings. The various translations through which it has passed, and the transcribers by whom it has been copied, have doubtless contributed to its dislocation.

The mention of *books* of Enoch in the Testament of Judah, in the Testament of Benjamin, in Origen (*c. Cels.* and *Homil. in Num.*), and of the first book of Enoch in the fragment preserved by Syncellus, is quite consistent with the idea that the whole was then divided into different books. Tertullian leads us to believe that it was of the same extent in the Greek text then existing, as it is in the present Ethiopic. Our limits forbid further examination of this topic. We must refer such as are desirous of prosecuting it to Murray's elaborate treatise, and to Hoffmann's *second Excursus* where *Enoch Restitutus* is reviewed.

4. *Its author, and the time when it was written.*—The two questions respecting the age and authorship of the book of Enoch are so intimately connected that they must be treated together. The opinions entertained in relation to the one necessarily affect our ideas of the other. Accordingly, the same passages have been made to bear more or less directly on both. If the writer was a *Christian Jew*, as Lücke and Stuart are inclined to believe, it will then behove us to bring down the period of composition to the first century of the Christian era; but if he was a Jew, there is no need to bend passages into compliance with the former hypothesis. Rather will the advocates of a purely Jewish authorship be disposed to refer it back with Laurence to the reign of Herod, or still earlier, with Hoffmann. It will not be denied by any reader, that the ideas, imagery, and general complexion of the book, are essentially Jewish. There is so much imitation of Daniel—such an exhibition of Jewish conceptions mixed with superstition, and occasionally with cabalistic theology or oriental theosophy, that the hand of a Jew cannot be mistaken. But the question is, are there sufficient indications in the work itself to warrant the conclusion that the writer was acquainted with the New Testament; that he derived various passages from the Apocalypse in particular; and that, therefore, he was probably a *Jewish Christian*. There is no good ground for supposing that the passages relating to the Messiah were interpolated by Christians; for, as Hoffmann well remarks, they constitute *essential parts* of the whole, being intimately interwoven with the pieces to which they belong. There is therefore no alternative between the two hypotheses.

There are some data for determining the time when this production first appeared. If Jude quoted it, it must have existed in the first century; and as the writer imitates the language and imagery of Daniel, it must have been written after the composition of that inspired book. Here are two *termini*, within which we are to look. Chapters lxxxiv.—xc.; liv., lv., and xcii. contain chronological marks of a somewhat definite character. In the first of these passages is found an allegorical representation, exhibiting the principal events in Jewish history, from Adam down to seventy kings who ruled over the Israelites. These are divided into three classes. 1. Thirty-seven shepherds (ch. lxxxix. 1). 2. Twenty-three shepherds (ch. lxxxix. 7). 3. Twelve shepherds (ch. lxxxix. 25). The first class consists of the kings of Judah and Israel, twenty of the former, and seventeen of the latter. Dr. Laurence thinks that for thirty-seven we should read thirty-five, because

the sum of the shepherds is said to be seventy, not seventy-two; yet we may rather suppose with Lücke, Hoffmann, and Stuart, that seventy is a round, prophetic number. The writer did not confine himself to minute exactness. Believing therefore that thirty-seven is a correct exhibition of the writer's opinion, Zimri, Shallum, and Tibni are omitted, in consequence of their very short reign. The next twenty-three shepherds were foreigners, who ruled over the Israelites during and after the Babylonish captivity. Their names are, 1. Nebuchadnezzar. 2. Evil-merodach. 3. Neriglissar. 4. Belshazzar. 5. Darius the Mede. 6. Cyrus. 7. Cambyses. 8. Smerdis. 9. Darius Hystaspis. 10. Xerxes. 11. Artaxerxes Longimanus. 12. Xerxes II. 13. Sothianus. 14. Oechus (Darius Nothus). 15. Artaxerxes Mnemon. 16. Darius Oechus. 17. Arses. 18. Darius Codomanus. 19. Alexander the Great. 20. Antigonus. 21. Ptolemy Lagi. 22. Ptolemy Philadelphus. 23. Ptolemy Euergetes. The third class consists of twelve rulers, who, according to Laurence, were *native* princes. In reckoning them he begins with Mattathias father of Judas Maccabæus, and ends with Herod. Now Herod reigned thirty-four years; and, as the author stops with him, Laurence infers that the book was written during the reign of Herod. Laurence makes the twelve princes to be Mattathias, Judas Maccabæus, Jonathan, Simon, John Hyrcanus, Aristobulus, Alexander Jannæus, Alexandra his widow, Aristobulus, Hyrcanus, Antigonus, and Herod. But there is good ground for questioning this reckoning. It has been pertinently remarked by Stuart, that none of the Asmonæan family were properly kings until Simon. According to this view, the twelve princes are, Simon, John Hyrcanus, Aristobulus I., Alexander Jannæus, Alexandria his widow, Aristobulus II., Alexander, Hyrcanus, Antigonus, and Herod, Archelaus and Agrippa. Such is the computation of Professor Stuart, more probable, as it appears to us, than that of Laurence, but still liable to doubt and serious objection. Alexander was never king of Judæa. Besides, in the book of Enoch it is stated, in relation to the twelve, that they 'destroyed more than those who preceded them;' an assertion manifestly inconsistent with fact. The first three princes, at least, were just and mild in their administration, and several of their successors cannot be equitably characterized as tyrants who shed the blood of the people. Of Herod alone is the statement emphatically true. To this it has been replied, that the writer gives the *general character* of the whole. Yet the expression 'they destroyed more than those who preceded them,' is not the general character of the whole, but only of one in particular. Hence we are inclined to accede to the opinion of Hoffmann, who refers the twelve princes to *foreign*, not *native*, rulers. In that case we must look for these twelve princes in the period of the Jews' oppressors, under the dynasties that arose after the death of Alexander the Great. Their names, according to Hoffmann, are Ptolemy Philopator, Ptolemy Philadelphus, Seleucus III. Philopator, Antiochus IV., Epiphanes, Antiochus V., Eupator, Demetrius Soter son of Seleucus, Alexander Balas son of Antiochus, Demetrius Nicator, Ptolemy Philometor, Demetrius Nicator II., Antiochus Theos,

and Tryphon. If this view be correct, we are not bound to conclude from the passage that the book of Enoch, or the historic portion of it, was written during the reign of Herod the Great.

Another passage on which Laurence rests in determining the time when the book was written, is chapter liv. 9, 10, where 'the chiefs of the east among the Parthians and Medes' are represented as about to remove kings, as hurling them from their thrones, 'springing as lions from their dens, and like famished wolves into the midst of the flock. They shall go up and tread upon the land of their elect. The land of their elect shall be before them,' &c., &c. In the year B.C. 41 the Parthians invaded Syria and took possession of the country. In the year B.C. 40 they entered Jerusalem, drove Herod out of the country, and raised Antigonus, the last of the Asmonæan race, to the throne. Herod appears to be alluded to as one in whom was the spirit of perturbation; while the retreat of the Parthians when the Romans interfered on behalf of Herod, seems to be indicated in other language. This brings us down to the year B.C. 40, before which the book of Enoch could not have been written. Perhaps the book was written about B.C. 40.

In chap. lv. is another chronological datum. The prophet beholds 'another army of chariots, with men riding in them,' . . . coming from the east, the west, and the south. 'The sound of the noise of their chariots was heard from the extremities of the earth unto the extremities of heaven at the same time.' In the former chapter the Parthian army is represented as powerful and terrific, while here the Roman seems to be noticed. It is ambiguous whether the language should be referred to the interposition of the Romans on behalf of Herod, or regarded as an expansion of the idea that the Roman name was powerful on every side of Judæa, or assigned, with Lücke and Stuart, to the invasion of Judæa by the Romans under Vespasian and Titus. The language is poetical and glowing. There is, therefore, no necessity to refer it to the Jewish war. It is sufficiently appropriate in relation to the interposition of the Romans on behalf of Herod.

Chap. lxxxix. 29, &c. and chap. xcii. are also rested on by Lücke and Stuart in favour of the opinion that the author was a Jew instructed in Christianity. But their arguments are unsatisfactory, and the construction they put on the passages in question liable to uncertainty. Hoffmann, in his *Commentary*, shows that they are either untenable or exceedingly doubtful. We are inclined to explain them otherwise; so that, in our view, the observations built upon them by Lücke fall to the ground.

Professor Stuart lays considerable weight on the Christology of the book, as indicative of an acquaintance on the author's part with the New Testament, especially the Apocalypse. Yet the *Christological* portions do not possess sufficient *distinctness* to imply a knowledge of the New Testament. The name *Jesus* never occurs; though *Son of man*, so often given to the Messiah in the Gospels, is very frequent. Neither are the appellations *Lord*, *Lord Jesus*, *Jesus Christ*, or even *Christ* employed. Is there not something unaccountable here on the supposition that the writer was instructed in Christianity? After all the considerations that have been adduced by Lücke and

Stuart, and the many coincidences between sentiments advanced in our book and the New Testament, we cannot suppose that it was written in the first century by a Jewish Christian. It seems to us to have been composed a little before Christ's appearance by a Jew who had studied well the Book of Daniel. At the same time we freely confess that the Saviour is spoken of in terms expressive of his dignity, character, and acts, surpassing the descriptions which other Jewish books present.

5. *The place where it was written.*—The place where the author lived and wrote is determined by Launce from the seventy-first chapter, where the length of the days at various periods of the year is given. It must have been between the 45th and 49th degrees of north latitude, in the northern districts of the Caspian and Euxine seas. Perhaps, therefore, the author was one of the Jews who had been carried away by Shalmaneser and did not return from captivity. Yet an examination of chap. xiii. 8-10, points to the northern part of Palestine. Mr. Murray has also shown that one passage favours the idea that the writer of it lived in Abyssinia (p. 63-73). Hence he infers that the work of different authors, living in countries removed from one another, is combined in the book of Enoch. But De Saey has well remarked, that as the astronomical cal system of the author appears to be in part imaginary, so his geography may be probably visionary. Neither Egypt, nor Chaldea, nor Palestine, suits the astronomy contained in the book. It is true that there are allusions to the oriental theosophy and the opinions of Zoroaster which would appear to recommend a *Chaldean* origin, at least of the astronomical part; but the author's predilection for the images of *fire, radiance, light*, and other Oriental symbols, may be accounted for on some other supposition than that of his residence in Chaldea. In what way he became acquainted with the Zend-Avesta, or the sentiments embodied in that book, we are not able to tell, although it is pretty obvious that various portions of his book are tinged with the Oriental philosophy of Middle Asia.

6. *Did Jude really quote the book of Enoch?*—Some are most unwilling to believe that an inspired writer could cite an Apocryphal production. Such an opinion destroys, in their view, the character of the writing said to be inspired, and reduces it to the level of an ordinary composition. But this is preposterous. The Apostle Paul quotes several of the heathen poets; yet who ever supposed that by such references he sanctions the productions from which his citations are made, or renders them of greater value? All that can be reasonably inferred from such a fact is, that if the inspired writer cites a particular sentiment with approbation, it must be regarded as just and right, irrespective of the remainder of the book in which it is found. The Apostle's sanction extends no farther than the passage to which he alludes. Other portions of the original document may exhibit the most absurd and superstitious notions. It has always been the current opinion that Jude quoted the book of Enoch; and there is nothing to disprove it. It is true that there is some variation between the quotation and its original, but this is quite usual even with the New Testament writers imitating the Old Testament.

Others, as Cave, Simon, Witsius, &c., suppose

that Jude quoted a *traditional* prophecy or saying of Enoch, and we see no improbability in the assumption. Others, again, believe that the words apparently cited by Jude were suggested to him by the Holy Spirit. But surely this hypothesis is unnecessary. Until it can be shown that the book of Enoch did not exist in the time of Jude, or that his quoting it is unworthy of an Apostle, or that such knowledge was not handed down traditionally within the Apostle's reach, we abide by the opinion that Jude really quoted the book of Enoch. While there are probable grounds for believing that Jude might have become acquainted with the circumstance independently of inspiration, we ought not to have recourse to the hypothesis of *immediate suggestion*. On the whole, it is most likely that the book of Enoch existed before the time of Jude, and that the latter really quoted it in accordance with the current tradition. If so, the prophecy ascribed to Enoch was *truly* ascribed to him, because it is scarcely credible that Jude writing by inspiration would have sanctioned a false statement.

7. *Its use.*—Presuming that it was written by a Jew, the book before us is an important document in the history of Jewish opinions. It indicates an essential portion of the Jewish creed before the appearance of Christ; and assists us in comparing the theological views of the later with those of the earlier Jews. It also serves to establish the fact that some doctrines of great importance in the eyes of evangelical Christians ought not to be regarded as the growth of an age in which Christianity had been corrupted by the inventions of men. We would not appeal to it as possessing *authority*. The place of *authority* can be assigned to the Bible alone. No human composition, be it ever so valuable, is entitled to usurp dominion over the understandings of men. But apart from all ideas of *authority*, it may be fairly regarded as an index of the state of opinion at the time when it was written. Hence it subserves the confirmation of certain opinions, provided they can be shown to have a good foundation in the word of God. If it be conceded that certain doctrines are contained by express declaration or fair inference in the volume of inspiration, it is surely some attestation of their truth that they lie on the surface of this ancient book. Let us briefly allude to several representations which occur in its pages:—

1. *Respecting the nature of the Deity.*—There are distinct allusions to a plurality in the God-head. The doctrine of the Trinity seems to have been received by the writer and his contemporaries, as the following quotation will prove: 'He shall call to every power of the heavens, to all the holy above, and to the power of God. The Cherubim, the Seraphim, and the Ophanim, all the angels of power, and all the angels of the Lords, namely, of the Elect One and of the other Power, who was upon earth over the water on that day, shall raise their united voice; shall bless, glorify, praise, and exalt with the spirit of faith, with the spirit of wisdom and patience, with the spirit of patience, &c., &c.' (ix. 13, 14). Here the *Elect One* evidently refers to the Messiah, and the other Power who was upon earth over the water on that day' to the Holy Spirit.

In accordance with this passage Christ is represented as (a) *existing from eternity*. Thus:

'In that hour was this Son of man invoked before the Lord of Spirits, and his name in presence of the Ancient of days. Before the sun and the signs were created, before the stars of heaven were formed, his name was invoked in the presence of the Lord of Spirits. Therefore the Elect and the Concealed One existed in his presence, before the world was created, and for ever' (xlvi. 2, 3, 5). 'Then shall the kings, the princes, and all who possess the earth, glorify Him who has dominion over all things, Him who was concealed; for, from the beginning, the Son of man existed in secret, whom the Most High preserved in the presence of his power, and revealed to the elect. All the kings, the princes, the exalted, and those who rule over the earth, shall fall down on their faces before Him, and shall worship Him. They shall fix their hopes on this Son of man, shall pray to Him, and petition Him for mercy' (lx. 10, 12, 13).

(b) As the object of invocation and worship. The last quotation is corroborative of this statement; so also ch. xlvi. 3 and 4, 'Before the sun and the signs were created, before the stars of heaven were formed, his name was invoked in the presence of the Lord of Spirits. All who dwell on earth shall fall down and worship before Him; shall bless and glorify Him, and sing praises to the name of the Lord of Spirits.'

(c) As the supreme Judge of men and angels. 'O ye kings, O ye mighty, who inhabit the world, you shall behold My Elect One sitting upon the throne of My glory. And he shall judge Azaeel, all his associates, and all his hosts, in the name of the Lord of spirits' (liv. 5). 'Then the Lord of Spirits seated upon the throne of His glory the Elect One; who shall judge all the works of the holy in heaven above, and in a balance shall He weigh their actions. And when he shall lift up His countenance to judge their secret ways in the word of the name of the Lord of spirits' &c. &c. (lx. 10, 11). 'They blessed, glorified, and exalted, because the name of the Son of man was revealed to them. He sat upon the throne of His glory; and the principal part of the judgment was assigned to Him, the Son of man' (lxviii. 38, 39).

2. The doctrine of a future state of retribution is implied in many passages. Thus: 'You have committed blasphemy and iniquity; and are destined to the day of the effusion of blood, to the day of darkness, and to the day of the great judgment. This I declare, and point out to you, that He who created you will destroy you' (xciii. 8, 9). 'Who has permitted you to hate and to transgress? Judgment shall overtake you, ye sinners. Wo to you who recompense your neighbour with evil; for you shall be recompensed according to your works' (xciv. 2, 4; comp. also chapters xcv. xcvi. xcix. and ciii.).

3. The eternity of future punishment is also contained in the book of Enoch, as the following passages will show:—'Moreover, abundant is their suffering until the time of the great judgment, the castigation, and the torment of those who eternally execrate, whose souls are punished and bound there for ever. A receptacle of this sort has been formed for the souls of unrighteous men, and of sinners; of those who have committed crime, and associated with the impious whom they resemble. Their souls shall not be annihilated in the day of judgment, neither shall

they arise from this place' (xxii. 12, 14). 'Never shall they obtain mercy, saith the Lord of spirits' (xxxix. 2). 'The countenances likewise of the mighty shall He cast down, filling them with confusion. Darkness shall be their habitation, and worms shall be their bed; nor from that their bed shall they hope to be again raised, because they exalted not the name of the Lord of spirits' (xlvi. 4). 'But has it not been shown to them, that, when to the receptacle of the dead their souls shall be made to descend, their evil deeds shall become their greatest torment? Into darkness, into the snare, and into the flame which shall burn to the great judgment, shall their spirits enter; and the great judgment shall take effect for ever and for ever' (ciii. 5).

We waive all comment on these passages, because their import is so plain, and bears so directly on the propositions in support of which they have been adduced. Whatever value may be attached to the theological opinions expressed in the book of Enoch, it is apparent from the preceding extracts, that certain sentiments to which evangelical Christians assign a high importance, because, in their view, they are contained in Scripture, appear to have prevailed at the commencement of the Christian era. To the serious inquirer they can never be of trifling interest.

The Book of Enoch the Prophet, by Richard Laurence, LL.D., Archbishop of Cashel, third edition, Oxford, 1838, 8vo. *Das Buch Henoch in vollständiger Uebersetzung mit fortlaufendem Commentar, ausführlicher Einleitung und erläuternden Excursen*, von Andr. G. Hoffmann, Erste Abtheilung, Jena, 1833, 8vo. Zweite Abtheilung, Jena, 1838, 8vo. This is the fullest and best book on the subject. *Enoch Restitutus, or an attempt to separate from the books of Enoch the book quoted by St. Jude, &c.*, by the Rev. Ed. Murray, London, 1836, 8vo. *American Biblical Repository for 1840*, in which there are two excellent articles by Professor Stuart on the book of Enoch. *Versuch einer vollständigen Einleitung in die Offenbarung Johannis*, von Dr. F. Lücke, Bonn, 1832, 8vo. § 12, pp. 52-78. A. F. Gtörer's tract in the *Tübingen 'Zeitschrift für Theologie'*, entitled, 'Die Quellen zur Kenntniss des Zustandes der jüdischen Dogmen und der Volksbildung im Zeitalter Jesu Christi,' 4 Hefte. pp. 120, sq. for the year 1837. Silvestre de Sacy's *Notice du livre d'Enoch in Magasin Encyclopédique*, an vi. tom. i. p. 382. This dissertation contains a Latin version of several chapters, and was translated into German by F. T. Rink, Koenigsberg, 1801, 8vo. Fabricii *Codex Pseudepigraphus Veteris Testamenti*, vol. i. pp. 160-224. Bruce's *Travels*, vol. ii. 8vo. edition. *The Genuineness of the Book of Enoch Investigated*, by Rev. J. M. Butt, M.A., London, 1827, 8vo. (The older dissertations of Drusius, Hottinger, Pfeiffer, Van Dale, Buddeus, and Heber, are now of little value, because the entire work had not been brought from Abyssinia when they were written. They are founded upon the allusions of the Fathers to the production in question, and upon the fragment of Syncellus).—S. D.

ENON. [ÆNON.]

EN-ROGEL (עֵן רוּגֵל; Sept. Παγάλα). The name means *Foot-fountain*, and is construed by the Targum into 'Fuller's Fountain,' because

the fullers trod the clothes there with their feet. It was near Jerusalem, on the boundary-line between the tribes of Judah and Benjamin (Josh. xv. 7; xviii. 6; 2 Sam. xvii. 17; 1 Kings i. 9). It has been usually supposed the same as the Fountain of Siloam. But Dr. Robinson is more inclined to find it in what is called by Frank Christians the Well of Nehemiah, but by the native inhabitants the Well of Job (*Bir Eyâb*). There are only three sources, or rather receptacles of living water, now accessible at Jerusalem, and this is one of them. It is situated just below the junction of the Valley of Hinnom with that of Jehoshaphat. It is a very deep well, of an irregular quadrilateral form, walled up with large squared stones, terminating above in an arch on one side, and apparently of great antiquity. There is a small rude building over it, furnished with one or two large troughs or reservoirs of stone, which are kept partially filled for the convenience of the people. The well measures 125 feet in depth; 50 feet of which were, at the time of Dr. Robinson's visit (in the middle of April), nearly full of water. The water is sweet, but not very cold, and at the present day is drawn up by the hand. In the rainy season the well becomes quite full, and sometimes overflows at the mouth. Usually, however, the water runs off under the surface of the ground, and finds an outlet some forty yards below the well, whence it is said to flow for sixty or seventy days in winter; and the stream is sometimes large.

ENSIGNS. [STANDARDS.]

EPÆNETUS (*Ἐπαίνετος*), a Christian resident at Rome when Paul wrote his Epistle to the Church in that city, and one of the persons to whom he sent special salutations (Rom. xvi. 5). In the received text he is spoken of as being 'the first fruits of Achaia' (*ἀπαρχὴ τῆς Ἀχαΐας*); but 'the first fruits of Asia' (*τῆς Ἀσίας*) is the reading of the best MSS. (A B C D E F G 67) of the Coptic, Armenian, Æthiopic, Vulgate, the Latin Fathers, and Origen (*In Ep. ad Rom. Comment. lib. x, Opera, vii. p. 431; In Numer. Hom. xi., Opera, x. p. 109*). Vater says, 'nisi præferendum certe æquiperandum.' This reading is preferred by Grotius, Mill, Bengel, Whitby, Koppe, Rosenmüller, Rückert, Olshausen, and Tholuck; and admitted into the text by Griesbach, Knapp, Tittmann, Scholz, Lachmann, and Tischendorf; also by Bruder, in his edition of Schmidt's Concordance, Lips. 1842. Dr. Bloomfield, who also adopts it in his Greek Testament (2nd ed. 1836), remarks that 'the very nature of the term *ἀπαρχή* suggests the idea of one person only (see 1 Cor. xv. 20), and, as in 1 Cor. xvi. 15, *Stephanas* is called the *ἀπαρχὴ τῆς Ἀχαΐας*, Epænetus could have no claim to the name.' With respect to the former part of this statement, the learned writer has strangely overlooked such passages as James i. 18, 'that we should be a kind of first fruits' (*ἀπαρχὴν ἡμεῶν*), and Rev. xiv. 4, 'These were redeemed from among men, being the first fruits' (*ἀπαρχή*): and as to the latter part, not Stephanas alone, but his house, is said to be the first fruits, and to have addicted themselves (*ἑτάξαν ἑαυτούς*) to the ministry of the saints.' Macknight's remark in favour of the received reading, that if Epænetus was one of that house, he was a part of the first fruits of Achaia, seems somewhat forced.

J. E. R.

ΕΠΑΦΡΑΣ (*Ἐπαφρᾶς*), an eminent teacher in the church at Colossæ, denominated by Paul 'his dear fellow-servant,' and 'a faithful minister of Christ' (Coloss. i. 7; iv. 12). From Paul's Epistle to Philemon it appears that he suffered imprisonment with the apostle at Rome. It has been inferred from Coloss. i. 7, that he was the founder of the Colossian Church; and Dr. Neander supposes that the apostle terms him *ὑπὲρ ἡμῶν διάκονος τοῦ Χριστοῦ* (a servant of Christ in our stead), because he committed to him the office of proclaiming the Gospel in the three Phrygian cities Colossæ, Hierapolis, and Laodicea, which he could not visit himself (*Hist. of Planting, &c. i. pp. 200, 373. Eng. transl.*). This language, however, is by no means decisive: yet most probably Epaphras was one of the earliest and most zealous instructors of the Colossian Church. Lardner thinks that the expression respecting Epaphras in Coloss. iv. 12, *ὁ ἐξ ἡμῶν*, is quite inconsistent with the supposition of his being the founder of the Church, since the same phrase is applied to Onesimus, a recent convert (*Hist. of the Apostles and Evangelists, c. xiv.; Works, vi. 153*). But, in both cases, the words in question seem intended simply to identify these individuals as the fellow townsmen of the Colossians, and to distinguish them from others of the same name in Rome (c. Macknight on Coloss. iv. 2)—J. E. R.

ΕΠΑΦΡΟΔΙΤΗΣ (*Ἐπαφροδίτης*), a messenger (*ἀπόστολος*) of the church at Philippi to the Apostle Paul during his imprisonment at Rome, who was entrusted with their contributions for his support (Phil. ii. 25; iv. 18). Paul's high estimate of his character is shown by an accumulation of honourable epithets (*τὸν ἀδελφόν, καὶ συνεργόν, καὶ συστρατιώτην μου*), and by fervent expressions of gratitude for his recovery from a dangerous illness brought on in part by a generous disregard of his personal welfare in ministering to the Apostle (Phil. ii. 30). Epaphroditus, on his return to Philippi, was the bearer of the epistle which forms part of the canon. Grotius and some other critics conjecture that Epaphroditus was the same as the Epaphras mentioned in the Epistle to the Colossians. But though the latter name may be a contraction of the former, the fact that Epaphras was most probably in prison at the time sufficiently marks the distinction of the persons. The name Epaphroditus was by no means uncommon, as Wetstein has shown by various quotations from classical authors (*Nov. Test. Gr. tom. ii. p. 273*).—J. E. R.

ΕΠΑΗΛ, a dry measure of capacity, equivalent to the bath for liquids. It contained three pecks and three pints. [WEIGHTS AND MEASURES.]

EPHESIANS, EPISTLE TO THE. This Epistle expressly claims to be the production of the Apostle Paul (i. 1; iii. 1); and this claim the writer in the latter of these passages follows up by speaking of himself in language such as that apostle is accustomed to use in describing his own position as an ambassador of Christ (iii. 1, 3, 8, 9). The justice of this claim seems to have been universally admitted by the early Christians, and it is expressly sanctioned by several of the fathers of the second and third centuries (Irenæus, *Adv. Har. v. 2. 3*; Clemens Alexandr. *Protrept. ix. p. 69, ed. Potter; Strom. iv. 8, p. 592*; Origen, *Cont. Cels. iv. p. 211, ed. Spencer; Tertullian, Adv. Marc. v. 11, 17*; Cy-

prian, *Testim.* iii. 7, &c.). The Epistle is also cited as part of sacred Scripture by Polycarp (*Ep. ad Philipp.* c. 1; c. 12); and it is probably to it that Ignatius refers when, in writing to the Ephesians, he calls them Παύλου συμμάχους . . . ὅς ἐν πάσῃ ἐπιστολῇ μνημονεύει ἡμῶν ἐν Χριστῷ Ἰησοῦ (c. 12, Conf. Cotelerii, *Annot. in loc.*; Pearson, *Vind. Ignatian* Par. ii. p. 119; Lardner's *Works*, vol. ii. p. 70, 8vo.). DeWette has attempted, from internal evidence, to set aside this external proof of the Pauline origin of this Epistle; but his cavils have been so fully and satisfactorily answered by Schott (*Isag. in N. T.* p. 260, Guericke (*Beiträge zur hist. krit. Einleitung ins N. T.* s. 106), Hemsen (*Der Ap. Paulus*, s. 130), Rückert (*Der Br. Pauli an die Epheser*, u. s. v. s. 289), and others, that even De Wette himself has been constrained to admit, in the second edition of his *Einleitung*, that his objections are without force. The genuineness of this book, therefore, may be regarded as universally admitted by Biblical scholars.

It is much more difficult to determine to whom this Epistle was addressed. On this subject two hypotheses have been principally entertained, besides the common opinion which, following the [disputed] reading in ch. i. ver. 1, regards the party to whom it was sent as the church at Ephesus. Grotius, reviving the opinion of the ancient heretic Marcion, maintains that the party addressed in this Epistle was the church at Laodicea, and that we have in this the Epistle to that church which is commonly supposed to have been lost; whilst others contend that this was addressed to no church in particular, but was a sort of circular letter, intended for the use of several churches, of which Ephesus may have been the first or centre.

The view of Grotius, which has been followed by some scholars of eminent name, among whom are found Hammond, Mill, Venema, Wetstein, and Paley, rests chiefly on two grounds; viz., the testimony of Marcion, and the close resemblance between this Epistle and that to the Colossians, taken in connection with Coloss. iv. 16. With respect to the former of these grounds, it is alleged that, as Marcion was under no temptation to utter a wilful falsehood in regard to the destination of this Epistle, he probably had the authority of the church at Laodicea, and it may be the tradition of the churches generally of Asia Minor for the opinion which he expresses (Grotius, *Proleg. ad Ephes.*; Mill, *Proleg. ad N. T.* p. 9, Oxon, 1707). But, without charging Marcion with *designedly* uttering what was false, we may suppose that, like some critics of recent times, this view was suggested to him by the apostle's allusion, in Col. iv. 16, to an epistle addressed by him to the Laodiceans. Nor is there the least ground for supposing that Marcion spoke in this instance on the authority of the Asiatic churches; on the contrary, there is every reason to believe the opposite, for not only do Origen and Clement of Alexandria, who were fully acquainted with the views of the eastern churches on such matters, give no hint of any such tradition being entertained by them, but Tertullian, to whom we are indebted for our information respecting the opinion of Marcion,* expressly says that in that

opinion he opposed the tradition of the orthodox churches, and imposed upon the Epistle a false title, through conceit of his own superior diligence in exploring such matters ('Ecclesie quidem veritate epistolam istam ad Ephesios habemus emissam, non ad Laodiceos, sed Marcion ei titulum aliquid interpolare gestit, quasi et in isto diligentissimus explorator.—*Adv. Marc.* v. 17). It is plain that to a statement of such a nature no weight can be safely attached. With regard to the other argument by which this view is advocated, we cannot help expressing surprise that such men as Mill and Paley should have deemed it of so much importance as to rest upon it the chief weight of their opinion. To us it appears to possess no force whatever in support of the view which they espouse. Admitting the fact of a close resemblance between the Epistle to the Colossians and that before us, and the fact that Paul had, some time before sending the former Epistle, written one to the church at Laodicea, which he advises the Colossians to send for and read, how does it follow from all this that the Epistle to the Laodiceans and that now under notice were one and the same? To us it appears more probable that, seeing the two extant Epistles bear so close a resemblance to each other, had the one now bearing the inscription 'to the Ephesians' been really the one addressed to the Laodiceans, the apostle would not have deemed it of so much importance that the churches of Colossæ and Laodicea should interchange epistles. Such being the chief arguments in favour of this hypothesis (for those which, in addition, Wetstein alleges from a comparison of this Epistle with that to the church at Laodicea, in the Apocalypse, are not deserving of notice; see Michaelis, *Introd.* vol. iv. p. 137), we may venture to set it aside as without any adequate support. It may be observed also that it seems incompatible with what the apostle says, Col. iv. 15, where he enjoins the church at Colossæ to send his greetings to the brethren at Laodicea, &c. Now one sends greetings by another only when it is impossible to express them oneself. But if Paul wrote to Laodicea at the same time as to Colossæ, and sent both letters by the same bearer, Tychicus, there was manifestly no occasion whatever for his sending his salutations to the latter of these churches through the medium of the former; it was obviously as easy, and greatly more natural, to have sent his salutations to the church at Laodicea in the Epistle addressed to themselves. This seems to prove that the Epistle to the Laodiceans had been written some considerable time before that to the Colossians, and therefore could not have been the same with that now under notice.

The opinion that this epistle was a sort of circular letter was first broached by Archbishop Usher. His words are (*Annal. Vet. et Nov. Test.* p. 680, Bæmæ, 1686), 'Notandum, in antiquis nonnullis codicibus (ut ex Basilii lib. 2, adv. Eunomium, et Hieronymi in hunc Apostoli locum commentario apparet) generatim inscriptam fuisse hanc epistolam τοῖς ἀγίοις τοῖς ὄδοι, καὶ πιστοῖς ἐν Χρ. Ἰη. vel (ut in litærum

an Epistle to the Laodiceans in his *Apostolicon*, but, as he states that he had also the Epistle to the Ephesians, this cannot be regarded as corroborating the testimony of Tertullian.

* Epiphanius also speaks of Marcion as having

encyclicarum descriptione fieri solebat) *sanctis qui vult . . . et fidelibus in Christo Jesu; ac si* Ephesum primo, ut præcipuum Asiæ metropolim, missa ea fasset, transmittenda inde ad reliquas (insertis singularum nominibus) ejusdem provinciæ ecclesias. To this opinion the great majority of critics have given their suffrage; indeed, it may be regarded as the received opinion of Biblical scholars in the present day. This may make it apparently presumptuous in us to call it in question; and yet it seems to us so ill supported by positive evidence, and exposed to so many objections, that we cannot yield assent to it. In the first place it is to be observed that it is an hypothesis entirely of modern invention. No hint is furnished of any such notion having been entertained concerning the destination of this epistle by the early church. With the solitary exception of Marcion, so far as we know, all parties were unanimous in assigning Ephesus as the place to which this epistle was sent, and Marcion's view is as much opposed to the supposition of its being a circular letter as the other. As respects the external evidence, therefore, this hypothesis is purely destitute of support.—2. It is an hypothesis suggested for the purpose of accounting for certain alleged facts, some of which are, to say the least, doubtful, and others of which may be explained as well without it as with it. These facts are, 1. The alleged omission of the name of any place at the commencement of the epistle; 2. Marcion's assertion that this epistle was addressed to the Laodiceans, which, it is said, arose probably out of his having seen that copy of this circular epistle which had been sent to Laodicea; 3. The want of any precise allusions to personal relations subsisting between the apostle and those to whom this epistle was addressed; and 4. The expressions of unacquaintedness with those to whom he wrote, which occur in this epistle, *e. g.* iii. 1-4. How these facts may be reconciled with the supposition that this epistle was addressed to the Ephesians will fall to be considered afterwards; at present the question is, How do they favour the hypothesis that this was a circular letter? Now, supposing them to be unquestionable, and admitting that they are not irreconcilable with this hypothesis, it must yet appear to all that they go very little way towards affording primary evidence in its support. It is not one which grows naturally out of these facts, or is suggested by them; it is plainly of foreign birth, and suggested for them. But when it is remembered that the first of these alleged facts is (to say the least) very doubtful; that the second is made to serve this hypothesis only by means of another as doubtful as itself, and that, were its services admitted, it would prove too much, for it would go to show that, to the Laodiceans, the apostle not only sent a peculiar epistle, mentioned Col. iv. 16, but gave them a share also in this circular epistle written some time after their own; and that the third and fourth are both either partially or wholly questionable, it must be admitted that this hypothesis stands upon a basis which is little better than none. 3. Had the epistle been addressed to a particular circle of churches, some designation of these churches would have been given, by which it might have been known what churches they were to which this letter belonged.

When it is argued that this must be a circular letter, because there is no church specified to which it is addressed, it seems to be forgotten that the designation of a particular set of churches is as necessary for a circular epistle, as the designation of one church is for an epistle specially addressed to it. If we must leave out the words *ἐν Ἐφεσῶν* in ch. i. 1, what are we to put in their place? for if we take the passage as it stands without them, it will follow that the epistle was addressed to all Christians everywhere, which is more than the advocates of the hypothesis now under notice contend for. It will not much help them to say with Usher, that the name of the place was left blank to be filled up; for the question immediately arises, By whom was it to be filled up? If by the church at Ephesus, to whom the epistle was first sent, then it could not be a circular epistle, but was a special epistle to the church at Ephesus, which they were left to communicate to as many or as few other churches as they pleased; and this may be said, we suppose, of all Paul's Epistles; nor is it at all improbable that this is exactly what the Ephesians would have done of their own accord, without any blank being left to give them the hint. If we say with Michaelis that the blank was left to be filled up by the Apostle himself, who had a number of copies written, which he thus addressed to particular churches, the question occurs, How do we know in that case that there ever was a blank at all? If every copy of this epistle that was sent by the Apostle had the name of a place written in it before it left him, there was, of course, no blank in any of them. The reasoning here in fact is a mere *petitio principii*. If we ask, How is it known that this was a circular epistle? the answer is, Because the name of the place was left blank to be filled in by the Apostle. If, now, we ask, How is it known that the place was left blank? it is answered, Because this is a circular epistle, 'ut in literarum encyclicarum descriptione hoc fieri solebat!' Besides, it seems hardly consistent with the Apostle's perfect integrity of character to suppose that he would insert in the copy sent to each church the name of the place where that church was located, in such a way as to lead the members of that church to suppose that the epistle they received was specially addressed to them. As an apostolic letter was usually esteemed a treasure of no ordinary value by the church to which it was originally sent, we may easily suppose that it would occasion no small mortification to each of the churches round Ephesus, to find that what each had supposed to be a letter specially addressed to itself was in fact only a copy of what had been sent to many others. In fine, this suggestion of Michaelis renders it very difficult to account for the prevailing insertion of *ἐν Ἐφεσῶν* in the text, as well as the universal tradition of the church, that such was the destination of this epistle. The solution proposed by Michaelis himself, viz., that 'when the several parts of the Greek Testament were collected into a volume, the copy inserted in this collection must have been procured from Ephesus,' besides being mere unsupported supposition, proceeds on the assumption that the Canon of the New Testament was formed by authority, which is what cannot be proved [CANON]. Hug's opinion that 'the title *πρὸς Ἐφεσίους* was given

to it, either because Ephesus was the most eminent of the Asiatic cities, or was the first which received it,* might account, perhaps, for a *preponderance* of testimony in favour of this title, but is certainly inadequate to account for the *unanimity* of testimony by which it is supported. On these grounds the suggestion of Michaelis appears to be inadmissible, and our objection to Usher's hypothesis remains in full force. 4. In ch. vi. 21, 22, Paul mentions that he had sent to those for whom this epistle was destined, Tychicus, who should make known to them all things, that they might know his affairs, and that he might comfort their hearts. From this it appears that Tychicus was not only the bearer of this letter, but that he was personally to visit, converse with, and comfort those to whom it was addressed. On the supposition that this was a circular letter, the following questions are naturally raised by this statement of the Apostle: Was Tychicus to carry this letter from church to church? or had he a distinct copy for each church in the circle? If the former, it will follow that no church ever possessed this epistle, but that certain churches around Ephesus enjoyed the advantage of *reading* it or *hearing* it read, while the bearer of it stayed with them. If the latter, then it may be asked, Was Tychicus, as he carried round these copies to deliver them, bound to abide at each church, and to answer all the demands and inquiries which the Apostle's declarations in the passage quoted would prompt its members to make? To affirm of either of these suppositions that it is *impossible*, would be, perhaps, to go too far; but it must be felt by every one, that, under all the circumstances of the case, neither of them is very *probable*.

The objections just stated seem to us to justify the rejection of Usher's hypothesis respecting the destination of this Epistle: we now turn to the consideration of the common and, as we believe, the true view of this matter. Here it will be necessary to consider, in the first instance, the objections which have been offered to this view. These are borrowed from the Epistle itself, in which, it is said, we not only miss those allusions to personal relations and intercourse which we should expect in an epistle from Paul to a church with which he had been so closely connected as with that at Ephesus, but we meet with statements which seem to imply that the parties to whom this Epistle was written were, at the time, strangers to the Apostle. As respects the former of these objections, it must be admitted that the Epistle contains no direct allusions to previous intercourse between the writer and those whom he addresses; but this may be partly accounted for by the circumstance that several years had now elapsed since that intercourse took place; and probably, during the interval messages had been sent by the Apostle to the Ephesians which rendered it unnecessary to allude to his earlier personal intercourse with them, in this Epistle. It is worthy of remark, on the other hand, that the tone and style of the Epistle are such as of themselves to suggest the probability of previous intercourse between the parties; such warmth of feeling and so much of a free outpouring of thought not being customary in a letter addressed to strangers, however strong might be the writer's general interest in their welfare.

With regard to the passages in which it is alleged that Paul writes as if the parties he addresses were personally unknown to him, they are all susceptible of a very different construction. When the Apostle says (i. 15), 'Wherefore also, *I having heard of your faith,*' &c., he is not necessarily to be understood as intimating that this knowledge had then for the *first* time been obtained by him through the report of others; he rather means that, as some years had elapsed since he left them, he was rejoiced to hear that they were still stedfast in the faith. Again, when he says (iii. 2), 'If ye have heard of the dispensation of the grace of God which is given me to you-ward,' &c. and (iv. 21), 'If so be that ye have heard him,' &c., the force of the particle *εἴτε* is not *adversative*, but rather, according to its proper meaning (comp. Hermann. *ad Viger.* § 512; Kühner's *Gram. d. Gr. Sp.* § 704, th. ii. 1.), and the ordinary usage of the Apostle, *concessive*; it is thus equivalent to *since, forasmuch as*, and expresses rather the confidence of knowledge than the uncertainty of ignorance. To these passages, then, no weight whatever deserves to be attached as tending to show the erroneousness of the ordinary designation of this Epistle. In favour of this designation, on the other hand, are to be urged the reading *ἐν Ἐφέσῳ* (i. 1), and the unanimous testimony of Christian antiquity. This reading is that supplied by all the MSS.² and ancient versions. From a passage, however, in one of the writings of Basil (*Adv. Eunomium*, lib. ii.), it has been inferred that in his day some MSS. were extant in which these words were not found. In maintaining against Eunomius, that Jesus Christ may justly be styled *ὁ ἐν*, Basil argues that this is the more proper from the circumstance that the Apostle, writing to the Ephesians, calls Christians *ὄντας*, absolutely and peculiarly saying *τοῖς ἁγίοις τοῖς ὄδοι καὶ πιστοῖς ἐν Χρ. Ἰη.*, and adds 'for so those before us have handed down, and we have found it in old copies.' Now there can be no doubt that Basil here means to say that he had both traditional and documentary authority for reading *τοῖς ὄδοι* absolutely without the addition of *ἐν Ἐφέσῳ* after these words, else his whole argument against Eunomius, based on this quotation, must go for nothing. But in the first place, supposing that in these MSS. to which Basil refers, the words *ἐν Ἐφέσῳ* were not found at all in the address of the Epistle, of what weight, in a critical point of view, is this fact? Of the age, number, source, and general worth of these testimonies to which Basil appeals, we know nothing, and we must be jealous of taking a keen controversialist's authority for the value of what serves his purpose against his antagonist. As the case stands, we have on the one side the unanimous testimony of all the extant witnesses in favour of *ἐν Ἐφέσῳ*; we have against it only the assertion of a writer who, to support what he considers a good stroke at his adversary, assures us that he had heard a tradition that these words were to be omitted, and had seen some MSS. in which they were omitted, thereby at the same time implicitly assuring us that in his day the *received* reading was the same as in ours. In such a case it is surely

* Though in the Vatican Codex it appears only on the margin, Hug says it is inserted there by the first hand (*De Antiquitate Cod. Vat.* p. 26).

preposterous to attach any weight whatever to such a testimony. But, secondly, does Basil's statement necessarily deny the existence of the words ἐν Ἐφέσῳ in any part of this verse? Admitting that he did not read them after τοῖς ὄσσι, does it follow that he did not read them here at all? May not the passage have stood, in the authorities to which he appeals, thus—τοῖς ἐν Ἐφέσῳ τοῖς ἁγίοις τοῖς ὄσσι, κ. τ. λ.? the words having been transposed by some transcriber whose blunder Basil, with the blind zeal of a controversialist, hailed as proving his argument? This supposition has in its favour, 1. that Basil, in the passage quoted, formally states that Paul wrote thus in an *Epistle to the Ephesians*; 2. that this reading supports as well Basil's argument against Eunomius, as if ἐν Ἐφέσῳ had been entirely omitted; and 3. that unless we insert those or similar words somewhere in the passage, the inscription of this Epistle becomes so vague and indefinite as to be without meaning. Some confirmation of this suggestion may be drawn, perhaps, from the place in which Jerome alludes to the argument here urged by Basil from this passage. After stating the argument he adds, 'Alii vero simpliciter non ad eos qui sunt, sed qui Ephesi sancti et fideles sunt, scriptum arbitrantur,' where he arranges the words in the same order, substantially, in which we have supposed them to have stood in Basil's MSS. If this suggestion, however, be deemed ungrounded or improbable, we have still the fact that Basil's evidence is unsupported to fall back upon in support of the received reading. Stress has also been laid by Hug and others upon the passage from Tertullian, already quoted, in which he charges Marcion with having altered the title of this Epistle. Had the MSS., it is argued, in Tertullian's time contained ἐν Ἐφέσῳ, Marcion must have had to alter not only the title of the Epistle, but, to be consistent, the text also of the first verse; and with this Tertullian does not charge him, though 'not accustomed,' as Hug reminds us, 'to overlook anything in him.' But this, surely, is at best, very precarious reasoning. Tertullian may have not deemed it worth while to specify Marcion's alteration of the text just because it was rendered so obviously necessary by his alteration of the title, that in mentioning the latter (which was all his purpose required), he, by implication, also intimated the former.

From these considerations it appears that the received reading ἐν Ἐφέσῳ is impregnable. As a necessary consequence it follows that the title πρὸς Ἐφεσίων expresses the original and proper destination of this Epistle.

The Epistle is so much the utterance of a mind overflowing with thought and feeling that it does not present any precisely marked divisions under which its different parts may be ranked. After the usual apostolic salutation Paul breaks forth into an expression of thanksgiving to God and Christ for the scheme of redemption (i. 3-10), from which he passes to speak of the privileges actually enjoyed by himself and those to whom he was writing, through Christ (i. 11-23). He then reminds the Ephesians of their former condition when they were without Christ, and of the great change which, through divine grace, they had experienced (ii. 1-22). An allusion to himself as enjoying by divine revelation the know-

ledge of the mystery of Christ leads the Apostle to enlarge upon the dignity of his office and the blessed results that were destined to flow from the exercise of it to others (iii. 1-12). On this he grounds an exhortation to his brethren not to faint on account of his sufferings for the Gospel, and affectionately invokes on their behalf the divine blessing, concluding this, which may be called the more doctrinal part of his Epistle, with a doxology to God (iii. 13-21). What follows is chiefly hortatory, and is directed partly to the inculcation of general consistency, steadfastness in the faith, and propriety of deportment (iv. 1; v. 21), and partly to the enforcement of relative duties (v. 22; vi. 9). The Epistle concludes with an animated exhortation to fortitude, watchfulness and prayer, followed by a reference to Tychicus as the bearer of the Epistle, and by the usual apostolic benediction (vi. 10-24).

This Epistle was written during the earlier part of the Apostle's imprisonment at Rome, at the same time with that to the Colossians [COLLOSSIANS, EPISTLE TO THE].

Of commentaries specially on this Epistle, the following deserve particular notice: Seb. Schmid., *Paraphras. super Ep. ad Ephes.*, 4to., Stralsburg, 1684; Rückert, *Der Brief Pauli an die Ephes. erläutert und vertheidigt*, 8vo. Leipzig, 1834; Matthias, *Erklärung des Br. Pauli an d. Ephes.* 8vo. Greifswald, 1834; Harless, *Commentar. üb. d. Br. Pauli an d. Ephes.* 8vo. Erlangen, 1834.—

W. L. A.

EPHESUS (Ἐφεσος), an old and celebrated city, capital of Ionia, one of the twelve Ionian cities in Asia Minor in the Mythic times, and said to have been founded by the Amazons, was in later ages inhabited by the Carians and Leleges, and taken possession of by the Ionians, under Androclus, the son of Codrus. It lay on the river Cayster, not far from the coast of the Icarian sea, between Smyrna and Miletus. It was also one of the most considerable of the Greek cities in Asia Minor; but while, about the epoch of the introduction of Christianity, the other cities declined, Ephesus rose more and more. It owed its prosperity in part to the favour of its governors, for Lysimachus named the city Arsinoë, in honour of his second wife, and Attalus Philadelphus furnished it with splendid wharfs and docks; in part to the favourable position of the place, which naturally made it the emporium of Asia on this side the Taurus (Strabo, xiv. pp. 611, 663). Under the Romans Ephesus was the capital not only of Ionia, but of the entire province of Asia, and bore the honourable title τῆς πρώτης καὶ μεγίστης μητρόπολεως τῆς Ἀσίας, of the first and greatest metropolis of Asia. (Boeckh, *Corp. Inser. Gr.* 2968-2992). The Bishop of Ephesus in later times was the president of the Asiatic dioceses, with the rights and privileges of a patriarch (Evang. *Hist. Eccl.* iii. 6). In the days of Paul Jews were found settled in the city in no inconsiderable number (compare Joseph. *Antiq.* xiv. 10, 11), and from them the Apostle collected a Christian community (Acts xviii. 19; xix. 1; xx. 16), which, being fostered and extended by the hand of Paul himself, became the centre of Christianity in Asia Minor. On leaving the city the Apostle left Timothy there (1 Tim. i. 3): at a later period, according to a tradition which prevailed extensively in ancient times, we find the Apostle John

in Ephesus, where he employed himself most diligently for the spread of the gospel, and where he not only died, at a very old age, but was buried, with Mary the mother of the Lord. Some make John bishop of the Ephesian communities, while others ascribe that honour to Timothy. In the book of Revelations (ii. 1) a favourable testimony is borne to the Christian churches at Ephesus.

The classic celebrity of this city is chiefly owing to its famous temple, and the goddess in whose honour it was built, namely, 'Diana of the Ephesians.' This goddess has been already noticed, and a figure given of her famous image at Ephesus [ARTEMIS].

Around the image of the goddess was afterwards erected, according to Callimachus (*Hymn. in Dian.* 248), a large and splendid temple:

τῷ δ' αὖ τι θεώτερον ὄψεται ἡῶς

οὐδ' ἀφνειότερον ῥέα κεν Πυθῶνα παρέλθοι·

This temple was burnt down on the night in which Alexander was born, by an obscure person of the name of Eratostratus, who thus sought to transmit his name to posterity; and, as it seemed somewhat unaccountable that the goddess should permit a place which redounded so much to her honour to be thus recklessly destroyed, it was given out that Diana was so engaged with Olympias, in aiding to bring Alexander into the world, that she had no time nor thought for any other concern. At a subsequent period, Alexander made an offer to rebuild the temple, provided he was allowed to inscribe his name on the front, which the Ephesians refused. Aided, however, by the whole of Asia Minor, they succeeded in erecting a still more magnificent temple, which the ancients have lavishly praised and placed among the seven wonders of the world. It took two hundred and twenty years to complete. Pliny (*Hist. Nat.* xxxvi. 21), who has given a description of it, says it was 425 feet in length, 220 broad, and supported by 127 columns, each of which had been contributed by some prince, and were 60 feet high: 35 of them were richly carved. Chersiphon, the architect, presided over the undertaking, and, being ready to lay violent hands on himself, in consequence of his difficulties, was restrained by the command of the goddess, who appeared to him during the night, assuring him that she herself had accomplished that which had brought him to despair. The altar was the work of Praxiteles. The famous sculptor Scopas is said by Pliny to have chiselled one of the columns. Apelles, a native of the city, contributed a splendid picture of Alexander the Great. The rights of sanctuary, to the extent of a stadium in all directions round the temple, were also conceded, which in consequence of abuse the Emperor Tiberius abolished. The temple was built of cedar, cypress, white marble, and even gold, with which it glittered (Spanh. *Observat. in Hymn. in Dian.* 353). Costly and magnificent offerings of various kinds were made to the goddess, and treasured in the temple; such as paintings, statues, &c., the value of which almost exceeded computation. The fame of the temple, of the goddess, and of the city itself, was spread not only through Asia but the world, a celebrity which was enhanced and diffused the more readily because sacred games were practised there, which called competitors and spectators from every country. Among his other enormities Nero is said to have despoiled the temple of Diana of much of its treasure. It continued

to conciliate no small portion of respect, till it was finally burnt by the Goths in the reign of Gallienus.

At Ephesus Diana was worshipped under the name of Artemis. There was more than one divinity which went by the name of Artemis, as the Arcadian Artemis, the Taurian Artemis, as well as the Ephesian Artemis. It will be seen, from the figure already given, that this last differed materially from the Diana, sister of Apollo, whose attributes are the bow, the quiver, the girt-up robe, and the bound; whose person is a model of feminine strength, ease, and grace; and whose delights were in the pursuits of the chase.—

Along the shady hills and breezy peaks

Rejoicing in the chase, her golden bow

She bends, her deadly arrows sending forth.

The 'silver shrines' of the Ephesian Artemis, mentioned in Acts xix. 24, have been already noticed [DEMETRIUS, 3].

Among the distinguished natives of Ephesus in the ancient world, may be mentioned Apelles and Parrhasius, rivals in the art of painting, Heraclitus, the man-hating philosopher, Hipponax, a satirical poet, Artemidorus, who wrote a history and description of the earth. The claims of Ephesus, however, to the praise of originality in the prosecution of the liberal arts, are but inconsiderable; and it must be content with the dubious reputation of having excelled in the refinements of a voluptuous and artificial civilization. With culture of this kind a practical belief in, and a constant use of, those arts which pretend to lay open the secrets of nature and arm the hand of man with supernatural powers, have generally been found conjoined. Accordingly, the Ephesian multitude were addicted to sorcery; indeed, in the age of Jesus and his Apostles, adepts in the occult sciences were numerous: they travelled from country to country, and were found in great numbers in Asia, deceiving the credulous multitude and profiting by their expectations. They were sometimes Jews, who refined their skill and even their forms of proceeding to Solomon, who is still regarded in the East as head or prince of magicians (Joseph. *Antiq.* viii. 2. 5. Acts viii. 9; xiii. 6, 8). In Asia Minor Ephesus had a high reputation for magical arts (Ottob. *De Ephes. Libris combustis*).

The books mentioned, Acts xix. 19, were doubtless books of magic. How extensively they were in use may be learnt from the fact that 'the price of them' was 'fifty thousand pieces of silver.' Very celebrated were the Ephesian letters ('*Ἐφέσια γράμματα*'), which appear to have been a sort of magical formulæ written on paper or parchment, designed to be fixed as amulets on different parts of the body, such as the hands and the head (Plut. *Sym.* vii.; Lakemacher, *Obs. Philol.* ii. 126; Deyling, *Observ.* iii. 355). Erasmus (*Ad. Cent.* ii. 578) says that they were certain signs or marks which rendered their possessor victorious in everything. Eustathius (*ad Hom. Odyss.* τ. 694) states an opinion that Cræsus, when on his funeral pile, was very much benefited by the use of them; and that when a Milesian and an Ephesian were wrestling in the Olympic games, the former could gain no advantage, as the latter had Ephesian letters bound round his heel; but, these being discovered and removed, he lost his superiority and was thrown thirty times. These passages

show the feeling which prevailed respecting the books that were brought and burned, and serve to illustrate the remark made by the writer of the Acts, 'So mightily grew the word of the Lord and prevailed.'

The ruins of Ephesus lie two short days' journey from Smyrna, in proceeding from which towards the south-east the traveller passes the pretty village of Sedekuy; and two hours and a half onwards he comes to the ruined village of Danizzi, on a wide, solitary, uncultivated plain, beyond which several burial-grounds may be observed; near one of these, on an eminence, are the supposed ruins of Ephesus, consisting of shattered walls, in which some pillars, architraves, and fragments of marble have been built. The soil of the plain appears rich. It is covered with a rank, burnt-up vegetation, and is everywhere deserted and solitary, though bordered by

picturesque mountains. A few corn-fields are scattered along the site of the ancient city, which is marked by some large masses of shapeless ruins and stone walls. Towards the sea extends the ancient port, a pestilential marsh. Along the slope of the mountain and over the plain are scattered fragments of masonry and detached ruins, but nothing can now be fixed upon as the great temple of Diana. There are some broken columns and capitals of the Corinthian order of white marble: there are also ruins of a theatre, consisting of some circular seats and numerous arches, supposed to be the one in which Paul was preaching when interrupted by shouts of, 'Great is Diana of the Ephesians.' The ruins of this theatre present a wreck of immense grandeur, and the original must have been of the largest and most imposing dimensions. Its form alone can now be spoken of, for every seat is removed

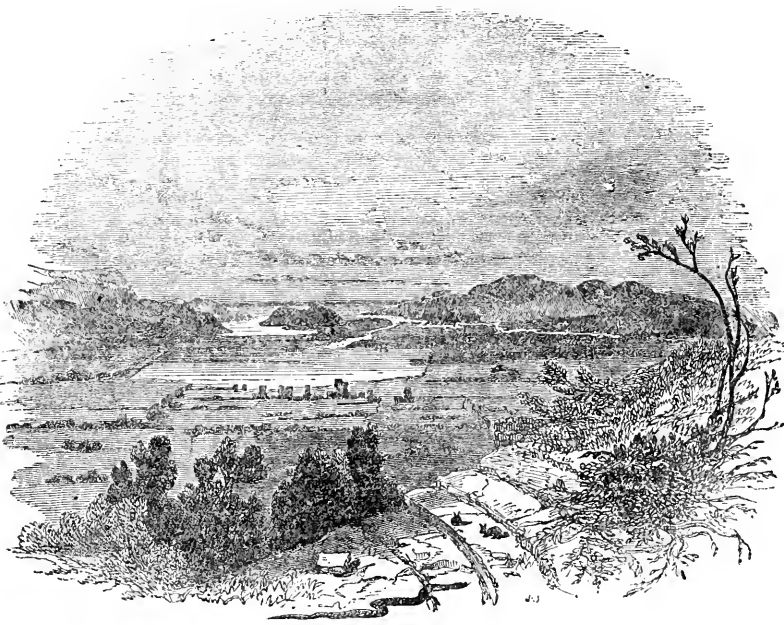

282. [Ephesus.]

and the proscenium is a hill of ruins. A splendid circus (Fellows' Reports, p. 275) or stadium remains tolerably entire, and there are numerous piles of buildings seen alike at Pergamus and Troy as well as here, by some called gymnasia, by others temples; by others again, with more propriety, palaces. They all came with the Roman conquest. No one but a Roman emperor could have conceived such structures. In Italy they have parallels in Adrian's villa near Tivoli, and perhaps in the pile upon the Palatine. Many other walls remain to show the extent of the buildings of the city, but no inscription or ornament is to be seen, cities having been built out of this quarry of worked marble. The ruins of the adjoining town, which arose about four hundred years ago, are entirely composed of materials from Ephesus. There are a few huts within these ruins (about a mile and a half from Ephesus), which

still retain the name of the parent city, *Asalook*—a Turkish word, which is associated with the same idea as Ephesus, meaning the City of the Moon (Fellows). A church dedicated to St. John is thought to have stood near, if not on the site of, the present mosque. Arundell (*Discoveries*, vol. ii. p. 253) conjectures that the gate, called the Gate of Persecution, and large masses of brick wain, which lie beyond it, are parts of this celebrated church, which was fortified during the great Council of Ephesus. The tomb of St. John was in or under his church, and the Greeks have a tradition of a sacred dust arising every year, on his festival, from the tomb, possessed of miraculous virtues: this dust they term manna. Not far from the tomb of St. John was that of Timothy. The tomb of Mary and the seven *παῖδια* (boys, as the *Synaxaria* calls the Seven Sleepers) are found in an adjoining hill. At the back of the mosque

on the hill, is the sunk ground-plan of a small church, still much venerated by the Greeks. The sites of two others are shown at Asalook. There is also a building, called the Prison of St. Paul, constructed of large stones without cement.

Though Ephesus presents few traces of human life, and little but scattered and mutilated remains of its ancient grandeur, yet the environs, diversified as they are with hill and dale, and not scantily supplied with wood and water, present many features of great beauty. Arundell (ii. 244) enumerates a great variety of trees, which he saw in the neighbourhood, among which may be specified groves of myrtle near Ephesus. He also found heath in abundance, of two varieties; and saw there the common fern, which he met with in no other part of Asia Minor.

Dr. Chandler (p. 150, 4to) gives a striking description of Ephesus, as he found it on his visit in 1764:—'Its population consisted of a few Greek peasants, living in extreme wretchedness, dependence, and insensibility, the representatives of an illustrious people, and inhabiting the wreck of their greatness—some the substructure of the glorious edifices which they raised; some beneath the vaults of the stadium, once the crowded scene of their diversions; and some in the abrupt precipice, in the sepulchres which received their ashes. Such are the present citizens of Ephesus, and such is the condition to which that renowned city has been reduced. It was a ruinous place when the Emperor Justinian filled Constantinople with its statues and raised the church of St. Sophia on its columns. Its streets are obscured and overgrown. A herd of goats was driven to it for shelter from the sun at noon, and a noisy flight of crows from the quarries seemed to insult its silence. We heard the partridge call in the area of the theatre and of the stadium. The pomp of its heathen worship is no longer remembered; and Christianity, which was then nursed by apostles, and fostered by general councils, barely lingers on, in an existence hardly visible.' However much the Church at Ephesus may (Rev. ii. 2), in its earliest days, have merited praise for its 'works, labour, and patience,' yet it appears soon to have 'left its first love,' and to have received in vain the admonition—'Remember, therefore, from whence thou art fallen, and repent and do the first works; or else I will come unto thee quickly, and will remove thy candlestick out of his place, except thou repent.' If any repentance was produced by this solemn warning, its effects were not durable, and the place has long since offered an evidence of the truth of prophecy, and the certainty of the divine threatenings, as well as a melancholy subject for thought to the contemplative Christian. Its fate is that of the once-flourishing seven churches of Asia: its fate is that of the entire country—a garden has become a desert. Busy centres of civilization, spots where the refinements and delights of the age were collected, are now a prey to silence, destruction, and death. Consecrated first of all to the purposes of idolatry, Ephesus next had Christian temples almost rivalling the pagan in splendour, wherein the image of the great Diana lay prostrate before the cross; and, after the lapse of some centuries, Jesus gives place to Mahomed, and the crescent glittered on the dome of the recently Christian church. A few more scores of years,

and Ephesus has neither temple, cross, crescent, nor city, but is 'a desolation, a dry land, and a wilderness.' Even the sea has retired from the scene of devastation, and a pestilential morass, covered with mud and rushes, has succeeded to the waters which brought up ships laden with merchandise from every part of the known world (Herod. i. 26, ii. 148; Liv. i. 45; Pausan. vii. 2, 4; Philo, *Byz. de 7 Orb. Mirac.* Gronov. *Thesaur.* viii.; Creuzer, *Symbol.* ii. 13; Hassl, *Erdbeschr.* ii. 132; for a plan of Ephesus, see Kiepert's Atlas, von Hellas; Arundell's *Visit to the Seven Churches of Asia*; Fellows' *Excursion in Asia Minor*, 1839; *Discoveries in Asia Minor*, by Rev. T. Arundell, 1834).—J. R. B.

EPHOD, an article of dress worn by the Hebrew priests. [PRIESTS.]

EPHRAIM (עֲפְרַיִם; Sept. 'Eppaîm), the younger son of Joseph, but who received precedence over the elder in and from the blessing of Jacob (Gen. xli. 52; xlviii. 1). That blessing was an adoptive act, whereby Ephraim and his brother Manasseh were counted as sons of Jacob in the place of their father; the object being to give to Joseph, through his sons, a double portion in the brilliant prospects of his house. Thus the descendants of Joseph formed two of the tribes of Israel, whereas every other of Jacob's sons counted but as one. There were thus, in fact, thirteen tribes of Israel; but the number twelve is usually preserved, either by excluding that of Levi (which had no territory), when Ephraim and Manasseh are separately named, or by counting these two together as the tribe of Joseph, when Levi is included in the account. The intentions of Jacob were fulfilled, and Ephraim and Manasseh were counted as tribes of Israel at the departure from Egypt, and as such shared in the territorial distribution of the Promised Land (Num. i. 33; Josh. xvii. 14; 1 Chron. vii. 20). The precise position of the immediate descendants of Joseph in Egypt might form an interesting subject for speculation. Being the sons of one in eminent place, and through their mother connected with high families in Egypt, their condition could not at once have been identified with that of the sojourners in Goshen; and perhaps they were not fully amalgamated with the rest of their countrymen until that king arose who knew not Joseph.

At the departure from Egypt, the population of the two tribes of Ephraim and Manasseh together amounted to 72,700 men capable of bearing arms, greatly exceeding that of any single tribe, except Judah, which had somewhat more. During the wandering, their number increased to 95,200, which placed the two tribes much higher than even Judah. At the Exode, Ephraim singly had 40,500, and Manasseh only 32,200; but a great change took place in their relative numbers during the wandering. Ephraim lost 8,600, and Manasseh gained 20,500; so that just before entering Canaan, Ephraim stood at 32,500, and Manasseh at 52,700. At the departure from Egypt, Ephraim, at 40,500, was above Manasseh and Benjamin in numbers; at the end of the wandering it was, at 32,500, above Simeon only, which tribe had suffered a still greater loss of numbers (comp. Num. i. and xxvi.).

One of the finest and most fruitful parts of

Palestine, occupying the very centre of the land, was assigned to this tribe. It extended from the borders of the Mediterranean on the west to the Jordan on the east: on the north it had the half-tribe of Manasseh, and on the south Benjamin and Dan (Josh. xvi. 5, sq.; xvii. 7, sq.). This fine country included most of what was afterwards called Samaria, as distinguished from Judæa on the one hand, and from Galilee on the other. The tabernacle and the ark were deposited within its limits, at Shiloh; and the possession of the sacerdotal establishment, which was a central object of attraction to all the other tribes, must, in no small degree, have enhanced its importance, and increased its wealth and population. The domineering and haughty spirit of the Ephraimites is more than once indicated (Josh. xvii. 14; Judg. viii. 1-3; xii. 1) before the establishment of the regal government; but the particular enmity of Ephraim against the other great tribe of Judah, and the rivalry between them, do not come out distinctly until the establishment of the monarchy. In the election of Saul from the least considerable tribe in Israel, there was nothing to excite the jealousy of Ephraim; and, after his heroic qualities had conciliated respect, it rendered the new king true allegiance and support. But when the great tribe of Judah produced a king in the person of David, the pride and jealousy of Ephraim were thoroughly awakened, and it was doubtless chiefly through their means that Abner was enabled to uphold for a time the house of Saul; for there are manifest indications that by this time Ephraim influenced the views and feelings of all the other tribes. They were at length driven by the force of circumstances to acknowledge David upon conditions; and were probably not without hope that, as the king of the nation at large, he would establish his capital in their central portion of the land. But when he not only established his court at Jerusalem, but proceeded to remove the ark thither, making his native Judah the seat both of the theocratical and civil government, the Ephraimites became thoroughly alienated, and longed to establish their own ascendancy. The building of the temple at Jerusalem, and other measures of Solomon, strengthened this desire; and although the minute organization and vigour of his government prevented any overt acts of rebellion, the train was then laid, which, upon his death, rent the ten tribes from the house of David, and gave to them a king, a capital, and a religion suitable to the separate views and interests of the tribe. Thenceforth the rivalry of Ephraim and Judah was merged in that between the two kingdoms; although still the predominance of Ephraim in the kingdom of Israel was so conspicuous as to occasion the whole realm to be called by its name, especially when that rivalry is mentioned.

2. **EPHRAIM** (Ἐφραΐμ), a city in the wilderness of Judæa, to which Jesus withdrew from the persecution which followed the miracle of raising Lazarus from the dead (John xi. 54). It is placed by Eusebius (*Onomast. s. v. Ἐφρών*) eight Roman miles north of Jerusalem. This indication would seem to make it the same with the Ephraim which is mentioned in 2 Chron. xiii. 19, along with Bethel and Jeshanah, as towns taken from Jeroboam by Abijah. And this again is

doubtless the same which Josephus also names along with Bethel as 'two small cities' (πολίχνια), which were taken and garrisoned by Vespasian while reducing the country around Jerusalem (*De Bell. Jud. iv. 9, 9*).

3. **EPHRAIM**, a mountain or group of mountains in central Palestine, in the tribe of the same name, on or towards the borders of Benjamin. (Josh. xvii. 15; xix. 50; xx. 7; Judg. vii. 24; xvii. 1; 1 Sam. ix. 4; 1 Kings iv. 8). From a comparison of these passages it may be collected that the name of 'Mount Ephraim' was applied to the whole of the ranges and groups of hills which occupy the central part of the southernmost border of this tribe, and which are prolonged southward into the tribe of Benjamin. In the time of Joshua these hills were densely covered with trees (Josh. xvii. 18), which is by no means the case at present. In Jer. l. 19, Mount Ephraim is mentioned in apposition with Bashan, on the other side of the Jordan, as a region of rich pastures, suggesting that the valleys among these mountains were well watered and covered with rich herbage, which is true at the present day.

4. **EPHRAIM, THE FOREST OF**, in which Absalom lost his life (2 Sam. xviii. 6-8), was in the country east of the Jordan, not far from Mahanaim. How it came to bear the name of a tribe on the other side the river is not known. Some think it was on account of the slaughter of the Ephraimites here in the time of Jephthah (Judg. xii. 4-6); but others suppose that it was because the Ephraimites were in the habit of bringing their flocks into this quarter for pasture; for the Jews allege that the Ephraimites received from Joshua, who was of their tribe, permission to feed their flocks in the woodlands within the territories of any of the tribes of Israel; and that as this forest lay near their territories on the other side the Jordan, they were wont to drive their flocks over to feed there (see Jarchi, Kimchi, Abarbanel, &c., on 2 Sam. xviii. 6).

EPHRATAH, otherwise **BETHLEHEM**, which see.

EPHRON, a Hittite residing in Hebron, who sold to Abraham the cave and field of Machpelah as a family sepulchre (Gen. xxiii. 6).

EPICURÉANS. [*PHILOSOPHY, GREEK.*]

EPISTLES. In directing our inquiry first of all towards the relation in which the Epistles stand to the other component parts of the New Testament, we find that both the Old and New Testament have been arranged by divine wisdom after one and the same plan. All the revelations of God to mankind rest upon history. Therefore in the Old, as well as in the New Testament, the history of the deeds of God stands **FIRST**, as being the basis of holy writ; thereupon follow the books which exhibit the doctrines and internal life of the men of God—in the Old Testament the Psalms, the writings of Solomon, &c., and in the New Testament the Epistles of the Apostles; finally, there follow in the Old Testament the writings of the prophets, whose vision extends into the times of the New Testament; and at the conclusion of the New Testament stands its only prophetic book, the Revelation of John.

In this also we must thankfully adore divine wisdom, that the Epistles, which lay down the doctrines of the Christian religion, originate, not

from one apostle alone, but from all the four principal apostles; so that one and the same divine truth is presented to our eyes in various forms as it were in various mirrors, by which its richness and manifold character are the better displayed.

The Epistles of the New Testament divide themselves into two parts—the PAULINE and the so-called CATHOLIC.

The PAULINE Epistles are thirteen in number; or fourteen, if we add to them the Epistle to the Hebrews. Up to our days their genuineness has almost unanimously been recognised in Germany, with the exception only of the pastoral epistles, and more especially the first letter to Timothy. Eichhorn and Bauer have attacked the genuineness of all the three pastoral epistles, and Schleiermacher that of the first epistle to Timothy. Indeed, the very peculiar character of the Pauline Epistles is so striking to any one who is not ignorant of the want of ease and originality conspicuous in the counterfeit writings of early times, as to leave not the least doubt of their genuineness. Depth of thought, fire of speech, firmness of character—these mainly features, joined withal to the indulgence of feelings of the most devoted love and affection, characterize these epistles. The amiable personal character of the apostle may be most beautifully traced in his Epistles to the Philippians and to Philemon.

All the Epistles, except the one to the Romans, were called forth by circumstances and particular occasions in the affairs of the communities to which they were addressed. Not all, however, were preserved; it is, at least, evident, from 1 Cor. v. 9, that a letter to the Corinthians has been lost; from Col. iv. 16, it has also been concluded—though probably erroneously, since there perhaps the letter to the Ephesians is referred to—that another letter to the community of Laodicea has likewise been lost. Press of business usually compelled Paul—what was, besides, not uncommon in those times—to use his companions as amanuenses. He mentions (Gal. vi. 11), as something peculiar, that he had written this letter with his own hand. This circumstance may greatly have favoured the temptation to forge letters in his name, because since the period of Alexandrine literature it was not unusual to indite spurious books, as is evident from Eusebius (*Hist. Eccles.* p. 23); and even Christian bishops made complaints about the falsification of their letters. Paul alludes to this (2 Thes. ii. 2), and therefore writes the greeting (2 Thes. iii. 17) with his own hand. Paul himself exhorted the communities mutually to impart to each other his letters to them, and read them aloud in their assemblies (Col. iv. 16). It is therefore probable that copies of these letters had been early made by the several communities, and deposited in the form of collections. So long therefore as the various communities transmitted the manuscripts to each other, no other letters, it is obvious, could come into the collections than those to whose genuineness the communities to whom they were originally addressed, bore witness. Even Peter (2 Pet. iii. 16) seems to have had before him a number of Paul's letters, as, about forty years later, a number of letters of Ignatius were transmitted by Polycarp to Smyrna, while the church of Philippi forwarded to him those directed to them (*Ep. Polic.* sub fin.; Euseb. *Hist. Eccles.* iii. 36).

This Pauline collection, in contra-distinction to the gospels, passed by the name of *δ' ἀπόστολος*.

The letters of Paul may be chronologically arranged into those written before his Roman imprisonment, and those written during and after it: thus beginning with his first letter to the Thessalonians, and concluding with his second to Timothy, embracing an interval of about ten years (A.D. 54-64). In our Bibles, however, the letters are arranged according to the pre-eminent parts and stations of the communities to whom they were addressed, and conclude with the epistles to the two bishops and a private letter to Philemon.

That the Epistles offered great difficulties was already felt in the earliest times (2 Peter iii. 16). In the Roman Church their true understanding was more particularly lost by the circumstances that it understood by THE LAW, only the *opus operatum* of the ceremonial law; consequently the Roman Church could not comprehend justification by faith, and taught instead justification by works; as soon, therefore, as the true understanding of the Pauline epistles dawned upon Luther, his breach with the Roman Church was decided.

Among the more ancient interpreters of the Pauline letters Chrysostom and Calvin deserve particular distinction; though the former, with all his zeal and psychological penetration, was still deficient in the true hermeneutic method.

THE CATHOLIC EPISTLES.—There is, in the first instance, a diversity of opinion respecting their name: some refer it to their WRITERS (letters from all the other apostles who had entered the stage of authorship along with Paul); some, again, to their CONTENTS (letters of no special but general Christian tenor); others, again, to the RECEIVERS (letters addressed to no community in particular). None of these views, however, is free from difficulties. The first and the second views—and more especially the first—cannot be brought to harmonize with the idiomatic expressions in the extant pages of the ancient writers; the second is, besides, contradicted by the fact that the letter of James is of a special tenor, while, on the contrary, that to the Romans is of such a general character as to deserve the name CATHOLIC in that sense. The third opinion is most decidedly justified by passages from the ancient writers (Euseb. *Hist. Eccles.* v. 18; Clem. Alex. *Strom.* iv. 15, ed. Potter, p. 606; Orig. *c. Cels.* i. 63). The Pauline Epistles had all their particular directions, while the letters of Peter, James, 1 John, and Jude were circular epistles. The Epistles 2 and 3 John were subsequently added, and included on account of their shortness, and to this collection was given the name CATHOLIC LETTERS, in contradistinction to the PAULINE, which were called *δ' ἀπόστολος*.—A. T.

EPISTLES OF THE APOSTOLICAL FATHERS. Under this head we shall briefly notice those remains of Christian antiquity which are ascribed to the writers usually styled the Apostolic Fathers, from the circumstance that they were converted to the Christian faith during the life-time, and probably by the instrumentality, of the Apostles. Of Barnabas and the epistle which bears his name we have already spoken at length [BARNABAS].

1. CLEMENT, or CLEMENS ROMANUS. It will probably be generally admitted that no produc-

tion of the early church approaches so near the apostolic writings, in the union of devout feeling with justness and sobriety of thought, as that denominated the 'First Epistle of Clement to the Corinthians' but addressed in the name of 'the Church sojourning at Rome (ἡ παροικοῦσα Ῥώμην) to the Church of God sojourning at Corinth.' Eusebius terms it, 'great and wonderful' (μεγάλη τε καὶ θαυμασία), and states that in his own and former times it was read in most churches. (*Hist. Eccles.* iii. 16; iii. 38; iv. 22, 23). Irenæus calls it *ικανωτάτην γραφήν*, 'a most powerful writing' (Euseb. *Hist. Eccles.* v. 6). It is frequently quoted by Clemens Alexandrinus (*Strom.* i. 7, § 38; *Όμηρα*, ed. Klotz, ii. p. 29) ὁ ἀπόστολος Κλήμης; *Strom.* iv. 17, § 107; ii. p. 335; *Strom.* v. 12, § 81; iii. v. 57; *Strom.* vi. 3, § 65; iii. p. 137. The only known manuscript of this Epistle is that appended to the celebrated Alexandrian Codex, which was presented to Charles I. by Cyrillus Lucaris, the patriarch of Constantinople. The same manuscript contains also a fragment of the so-called second Epistle. They were first published at Oxford, in 1633, by Patrick Young, the royal librarian. Sir Henry Wotton re-examined the manuscript, amended Young's copy in above eighty places, and published a very correct edition at Cambridge, in 1718. Certain portions of the first epistle have been thought to bear internal evidence of spuriousness. Bignonius, in a letter to Grotius, instances ch. xl., which relates to the presentation of offerings at set times, in which the word *λαϊκός* occurs; and the epithet *ancient* (ἀρχαίαν) applied to the Corinthian church in ch. xlvii. Mosheim asserts that some passages are evidently taken from Clement of Alexandria (Mosheim's *Commentaries*, transl. by Vidal, vol. i. p. 271). The main object of this Epistle was to allay the dissensions which had arisen in the Corinthian church, and especially to repress the unruly spirit shown by many against their teachers. It is worthy of notice that Clement uniformly speaks of the opposition of the Corinthians against their presbyters, never of their insubordination to their bishop: he inculcates submission to the presbyters, but never to the bishop. Thus in ch. xlvii., 'It is disgraceful, beloved, and unworthy of your training in Christ, to have it reported that the well-established and ancient Corinthian church has been excited by one or two individuals to revolt against the presbyters' (*its priests*, Abp. Wake's transl.). Ch. liv., 'Only let the flock of Christ be at peace with the presbyters that are set over it' (τῶν καθεσταμένων πρεσβυτέρων). Ch. lvii., 'Do ye who laid the foundation of the dissension submit to the presbyters' (*priests*, Abp. Wake's transl.). In two other passages the term *πρεσβυτέροι* appears to denote simply the elder members of the church, while the term *ἡγούμενοι* (Heb. xiii. 7, 17, 24) is used for their teachers or superintendents. Ch. i., 'Being subject to those that have the rule over you' (τοῖς ἡγουμένοις ὑμῶν), 'and giving due honour to the aged among you' (τοῖς παρ' ὑμῶν πρεσβυτέροις). Ch. xxi., 'Let us honour those that are set over us' (τοὺς προηγουμένους); 'let us respect the aged that are among us' (τοὺς πρεσβυτέρους); 'let us instruct the young,' &c. In ch. xlii. he speaks of bishops and deacons in a manner which shows that he considered the former as synonymous with presby-

ters: 'They (the Apostles) appointed their first-fruits to be bishops and deacons (*ministers*, Abp. Wake's transl.) of those who should believe. Nor was this any new thing, seeing that long before it was written concerning bishops and deacons. For thus the Scripture, in a certain place, saith, I will appoint their overseers (bishops, τοὺς ἐπισκόπους), and their ministers (deacons, τοὺς διακόνους) in faith.' It has indeed been supposed that the bishop of the Corinthian church was deceased, and that the disorders which Clement sought to repress broke out before his successor was appointed. But had this been the case, for which there is not the slightest evidence, it is almost incredible that no allusion should be made to it. The only legitimate inference appears to be, 'that the original constitution of the church of Corinth still subsisted in Clement's time; the government was still vested not in one man, but in many' (Dr. Arnold's *Sermons on the Christian Life*, Introduction, p. xlvii.).

In Clement's Epistle only one book of the New Testament is expressly named, Paul's first Epistle to the Corinthians; but though the Evangelists are not named, several sayings of Christ contained in our Gospels are repeated. There are also evident allusions to the Acts, all the Pauline Epistles (1 Thessalonians excepted), the Epistles of Peter and James, and the Epistle to the Hebrews. A tabular view of these passages is given by Dr. Lardner (*Credibility of the Gospel History*, pt. ii. ch. ii.; *Works*, vol. ii. pp. 35-53). Eusebius, speaking of Clement's Epistle, says, 'He has inserted in it many sentiments taken from the Epistle to the Hebrews, and sometimes makes use of the identical expressions, from which it is evident that that composition is not a recent one. . . . Paul having addressed the Hebrews in their native language, some say that the Evangelist Luke, and others that this very Clement, translated the document; an opinion which is supported by the fact, that the Epistle of Clement and that to the Hebrews are marked by the same peculiarities of style, and in both compositions the sentiments are not unlike.'—(*Hist. Eccles.* iii. 38, ed. Valesii, 1672, p. 110.)

As to the date of this epistle it has been fixed by Grabe, Galland, Wotton, and Hefele about the year 68; but Cotelerius, Tillemont, and Lardner think that it was written at the close of the Diocletian Persecution in 96 or 97. A passage in ch. xli., in which Clement speaks in the present tense respecting the sacrifices of the Mosaic law, has been supposed to favour the earlier date; but Josephus adopts the same phraseology in his *Antiquities*, which were not finished till twenty years after the destruction of Jerusalem.

The first writer that notices the second Epistle of Clement is Eusebius, who does not absolutely pronounce it spurious, but says that it was less known than the former, and not quoted by ancient writers (*Hist. Eccles.* iii. 38). Photius states decidedly that it was rejected as spurious. It is only a fragment, and its style is rather homiletic than epistolary. The Gospels are quoted several times in it, more expressly than in the first Epistle, and there is one passage from an apocryphal writing called the Gospel according to the Egyptians (Lardner's *Credibility*, &c., part ii. ch. 3; *Works*, ii. 55). In 1752, John James Wetstein published, at the end of his edictio of

the Greek Testament, two epistles in Syriac (accompanied by a Latin translation), attributed to Clement, which were discovered at the end of a manuscript of the Syriac New Testament. Immediately on their publication Dr. Lardner examined the evidence for their genuineness, and gave the result of his inquiries in a *Dissertation* (*Works*, vol. x. pp. 186-212), to which we refer the reader, only remarking that the whole strain of these compositions, and the allusions to prevailing practices, sufficiently indicate that they were written long after Clement's time.

The following works have also been attributed to Clement, but, as they are unquestionably supposititious, we shall merely give their titles. 1. *The Apostolic Constitutions*, in eight books. 2. *The Apostolic Canons*. 3. *The Recognitions of Clement*. 4. *The Clementina*. They are all printed in the *Patres Apostolici* of Cotelerius, vol. i. (Mosheim's *Commentaries*, translated by Vidal, vol. i. pp. 270-274).

2. IGNATIUS, according to Eusebius (*Hist. Eccles.* iii. 36) and Origen (*Hom. vi. in Luc. ; Opera*, ed. Lommatsch, v. 104), the second bishop, or, according to Jerome (*De Vir. Illustr.* xvi.), the third bishop of Antioch in Syria. Fifteen epistles bear his name. Three of these (one addressed to the Virgin Mary, the other two to St. John) are preserved only in a Latin version. The rest are extant in Greek and in an ancient Latin version, and are addressed to Mary of Cassabolis or Neapolis, to Hero, to the churches at Tarsus, Antioch, Philippi, Ephesus, Magnesia, Trallium, Rome, Philadelphia, Smyrna, and to Polycarp. The first eight are unanimously allowed to be spurious. Of the remaining seven (which were written on his journey from Antioch to Rome, where he suffered martyrdom by exposure to wild beasts), there are two recensions, one longer, the other shorter. It has been warmly controverted whether the longer epistles are interpolations of the shorter, or the shorter abridgments of the longer. Mr. Whiston contended earnestly in favour of the longer recension, including the Epistles to Tarsus, Antioch, and Hero, and attempted to prove that the smaller were only heretical extracts from them made in the fourth century. He published both recensions, with translations and various readings, in the first volume of his *Primitive Christianity Revived*, London, 1711, 5 vols. 8vo. The same opinion has lately been maintained by Dr. Charles Meier of the University of Giessen (*Studien und Kritiken*, 1836, p. 340), whose arguments have been met by Dr. Richard Rothe in an essay on the genuineness of the Ignatian Epistles appended to his work *Die Anfänge der Christlichen Kirche und ihrer Verfassung*, Wittenberg, 1837. Lardner and most modern critics adopt the shorter recension. Mosheim expresses himself very doubtfully, and, while he allows the seven epistles to have 'some what of a genuine cast,' confesses that he is unable to determine how much may be considered as authentic (*Commentaries*, translated by Vidal, vol. i. pp. 276, 277). Dr. Neander, while he allows many passages to bear the impress of antiquity, considers even the shorter recension to be grossly interpolated. The support which it was supposed might be drawn from these epistles in favour of episcopacy gave, on their publication, an exaggerated importance to

the question of their genuineness, and called forth the polemical skill of several distinguished theologians of the seventeenth century. In 1666 a work appeared by Dallæus (Jean Daillé), entitled, *De Scriptis quæ sub Dionysii Areopagite et Ignatii Antiocheni nominibus circumferuntur Libri duo*, in which he maintains that the Ignatian Epistles were forged at the close of the third, or at the beginning of the fourth century (c. xxxviii. p. 461). In reply to this and other writers, Bishop Pearson published his celebrated *Vindiciæ Ignatiane*, Cantab. 1672, which was reprinted by Cotelerius in his edition of the *Apostolic Fathers*, vol. ii. pp. 251-441. (Wake's *Genuine Epistles of the Apostolic Fathers*, London, 1737, pp. xl.-li. pp. 60-128; Campbell's *Lectures on Ecclesiastical History*, London, 1800, vol. i. pp. 139, 184-197; Dr. Arnold's *Sermons on the Christian Life*, 1841; *Introduction*, pp. xli.-xlix.; Lardner's *Credibility*, pt. ii. ch. 5; *Works*, vol. ii. pp. 73-94; Neander's *Allgemeine Geschichte*, i. Abth. ii. Band. 1140, 2nd edit. 1843).

3. POLYCARP'S *Epistle to the Philippians*. Irenæus, in a letter to Florinus the Valentinian, preserved in part by Eusebius (*Hist. Eccles.* v. 20), gives an interesting account of his early recollections of Polycarp, and refers to the epistles which he sent to the neighbouring churches. Only one, however, has been preserved; it was addressed to the Philippians, and in Jerome's time was publicly read in the assembly of Asia—'Scriptis ad Philippenses valde utilem epistolam quæ usque hodie in Asiæ conventu legitur' (*De Vir. Illustr.* c. 13). It is also mentioned by Eusebius (*Hist. Eccles.* iii. 36), who cites two passages from it (§ 8 and § 13) relating to Ignatius, and remarks that it contains several quotations from the first epistle of Peter (*Hist. Eccles.* iv. 14). It is divided into fourteen sections, of which the first nine and the thirteenth, preserved by Eusebius, are in the original Greek, and the rest only in an ancient Latin Version. This version of the whole epistle was first printed at Paris in 1498. Peter Halloix published the Epistle in Greek and Latin in 1633, from a copy sent by the Jesuit Simond to Turrianus. Fourteen years after, Archbishop Ussher obtained another copy, from which he prepared an edition in 1647. An excellent edition, edited by Sir Thomas Smith, appeared in 1709 (Hefele's *Patrum Apostolicorum Opera*, p. xviii.; Lardner's *Credibility*, pt. ii. ch. 6).

4. *The Shepherd of Hermas* [HERMAS].—
J. E. R.

EPISTLES, SPURIOUS [APOCRYPHA]. OF these many are lost, but there are several still extant: the principal are

- The Epistle of Paul to the Laodiceans.
- The Third Epistle of Paul to the Corinthians.
- The Epistle of Peter to James.
- The Epistles of Paul and Seneca.

There was an Epistle to the Laodiceans extant in the beginning of the second century, which was received by Marcion; but whether this is the same with the one now extant in the Latin language is more than doubtful. 'There are some,' says Jerome, 'who read the Epistle to the Laodiceans, but it is universally rejected.' The original Epistle was most probably a forgery founded on Coloss. iv. 16, 'And when this Epistle is read among you, cause

that it be read also in the church of the Laodiceans, and that *ye likewise read the Epistle from Laodicea.* The apparent ambiguity of these last words has induced some to understand St. Paul as speaking of an epistle written by him to the Laodiceans, which he advises the Colossians to procure from Laodicea, and read to their church. 'Some,' says Theodoret, 'imagine Paul to have written an Epistle to the Laodiceans, and accordingly produce a certain forged epistle; but the Apostle does not say, the Epistle to, but the Epistle from, the Laodiceans.' Bellarmine, among the Roman Catholics, and among the Protestants Le Clerc and others, suppose that the passage in Colossians refers to an epistle of St. Paul, now lost, and the Vulgate translation—*eam quæ Laodicensium est*—seems to favour this view. Grotius, however, conceives that the Epistle to the Ephesians is here meant, and he is followed by Hammond, Whitby, and Mill, and also by Archbishop Wake (*Epistles of the Apostolic Fathers*). Theophylact, who is followed by Dr. Lightfoot, conceives that the epistle alluded to is 1 Timothy. Others hold it to be 1 John, Philemon, &c. Mr. Jones conjectures that the epistle now passing as that to the Laodiceans (which seems entirely compiled out of the Epistle to the Philippians) was the composition of some idle monk not long before the Reformation; but this opinion is scarcely compatible with the fact mentioned by Mr. Jones himself, that when Sixtus of Sienna published his *Bibliotheca Sancta* (A.D. 1560), there was a very old manuscript of this epistle in the library of the Sorbonne. This epistle was first published by James Le Fevre of Staples in 1517. It was the opinion of Calvin, Louis Capell, and many others, that St. Paul wrote several epistles besides those now extant. One of the chief grounds of this opinion is the passage 1 Cor. v. 9. There is still extant, in the Armenian language, an epistle from the Corinthians to St. Paul, together with the Apostle's reply. This is considered by Mr. La Croze to be a forgery of the tenth or eleventh century, and he asserts that it was never cited by any one of the early Christian writers. In this, however, he is mistaken, for this epistle is expressly quoted as Paul's by St. Gregory the Illuminator in the third century, Theodore Chrethor in the seventh, and St. Nierses in the twelfth. Neither of them, however, is quoted by any ancient Greek or Latin writer (Henderson, *On Inspiration*, p. 497. The passages are cited at length in Father Paschal Aucher's *Armenian and English Grammar*, Venice, 1819).

The *Epistle of Peter to James* is a very ancient forgery. It was first published by Cotelerius, and is supposed to have been a preface to the *Preaching of Peter*, which was in great esteem among some of the early Christian writers, and is several times cited as a genuine work by Clement of Alexandria, Theodotus of Byzantium, and others. It was also made use of by the heretic Heraclion, in the second century. Origen observes of it, that it is not to be reckoned among the ecclesiastical books, and that it is neither the writing of Peter nor of any other inspired person. Mr. Jones conceives it to be a forgery of some of the Ebionites in the beginning of the second century.

The *Epistles of Paul and Seneca* consist of eight pretended Latin letters from the philosopher Seneca

to St. Paul, and six from the latter to Seneca. Their antiquity is undoubted. St. Jerome had such an idea of the value of these letters that he was induced to say, 'I should not have ranked Seneca in my catalogue of saints, but that I was determined to it by those Epistles of Paul to Seneca and Seneca to Paul, which are read by many. . . . He was slain by Nero, two years before Peter and Paul were honoured with martyrdom.' St. Augustine also observes (*Epistle to Macedonius*) that 'Seneca wrote certain epistles to St. Paul, which are now read.' The epistles are also referred to in the spurious 'Acts' of Linus, the first bishop of Rome after the Apostles. But these *Acts* are a manifest forgery, and were first alluded to by a monk of the eleventh century. The letters do not appear to have been mentioned by any other ancient writer; but it seems certain that those now extant are the same which were known to Jerome and Augustine. The genuineness of these letters has been maintained by some learned men, but by far the greater number reject them as spurious. Mr. Jones conceives them to be a forgery of the fourth century, founded on Philip. iv. 22. Indeed, there are few persons mentioned in the New Testament, as companions of the Apostle, who have not had some spurious piece or other fathered on them.

These are the principal of the ancient forged epistles. Among those now universally rejected are the well-known *Epistle of Lentulus* to the Roman Senate, giving a description of the person of Christ (*Orthodoxographia*, p. 2, Basil, 1555; Fabricii *Cod. Epig.*, 1719), and some pretended epistles of the Virgin Mary. One of these is said to be written in Hebrew, and addressed to the Christians of Messina in Sicily, of which a Latin translation has been published, and its genuineness gravely vindicated (*Veritas Vindicata*, 1692, fol.). It is dated from Jerusalem, in the 42nd year 'of our Son,' names of July, *Luna 17, Feria quinta*. The metropolitan church of our Lady of the Letter, at Messina, takes its name from the possession of this celebrated epistle, of which some have pretended that even the autograph still exists. An epistle of the Virgin to the Florentines has been also celebrated, and there is extant a pretended letter from the same to St. Ignatius, together with his reply.—W. W.

ERASTUS (*Ἐραστός*), a Corinthian, and one of Paul's disciples, whose salutations he sends from Corinth to the Church at Rome as those of 'the chamberlain of the city' (Rom. xvi. 23). The words so rendered (*οἰκονόμος τῆς πόλεως*; Vulg. *arcarius civitatis*) denote the city treasurer or steward, an officer of great dignity in ancient times (comp. Joseph. *Antiq.* vii. 8, 2). We find this Erastus with Paul at Ephesus, whence he was sent along with Timothy into Macedonia (Acts xix. 22). They were both with the apostle at Corinth when he wrote, as above, from that city to the Romans: at a subsequent period Erastus was still at Corinth (2 Tim. iv. 20), which would seem to have been the usual place of his abode.

ERECH (*Ἐρέχ*; Sept. *Ῥεράχ*), one of the cities which formed the beginning of Nimrod's kingdom in the plain of Shinar (Gen. x. 10). It is not said that he built these cities, but that he established his power over them; from which

we may conclude that they previously existed. An ancient tradition, which Jerome and others have followed, but which is against all probability, and has no foundation to rest upon, identifies Erech with Edessa. Bochart, however, rather seeks the name in the Araca or Aracha of the old geographers, which was on the Tigris, upon the borders of Babylonia and Susiana (Ptolemy, vi. 3; Ammian. Marcell. xxxiii. 6, 26). This was probably the same city which Herodotus (i. 185; vi. 119) calls Arderikka, *i. e.* Great Erech. Rosenmüller happily conjectures that Erech probably lay nearer to Babylon than Aracca; and this has been lately confirmed by Col. Taylor, the British resident at Bagdad, who is disposed to find the site of the ancient Erech in the great mounds of primitive ruins, indifferently called Irak, Irka, and Senkerah, by the nomadic Arabs; and sometimes El Asayah, 'the place of pebbles.' These mounds, which are now surrounded by the almost perpetual marshes and inundations of the lower Euphrates, lie some miles east of that stream, about midway between the site of Babylon and its junction with the Tigris. Some have thought that the name of Erech may be preserved in that of Irak (*Irak-Arabi*), which is given to the region enclosed by the two rivers, in the lower part of their course.

ERES or ÆRES (𐤀𐤓) occurs in numerous places of Scripture, but authors are not agreed on the exact meaning of the term: Celsius (*Hierobot.* i. 106, sq.), for instance, conceives that it is a general name for the pine tribe, to the exclusion of the cedar of Lebanon, which he considers to be indicated by the word BĒROSH. The majority of authors, however, are of opinion that the cedar of Lebanon (*Pinus Cedrus* or *Cedrus Libani* of Botanists) is alone intended. It is unfortunate that there should be discrepancy of opinion as to the identification of so remarkable a tree, as it necessarily produces a distrust in the conclusions which are arrived at respecting, what would appear to be, the less easily distinguished plants and trees mentioned in the Bible. The discrepancy of opinion has on this occasion, however, arisen from the doubt whether Eres, in the numerous passages of Scripture where it occurs, is always used in the same signification; that is, whether it is always intended to specify only one particular kind of the pine tribe, or whether it is not sometimes used generically. In the latter case others of the pine tribe appear to be intended along with the cedar of Lebanon, and not to its exclusion, as advocated by the learned Celsius. We are disposed to think that the different passages in which *Eres* occurs authorize our considering it a general term, applied to different species.

But before proceeding to compare these passages with one another, it will be desirable to ascertain its modern acceptation, as well as the meaning which it bears in Arabic works on *Materia Medica*. In these such terms are generally used in a more precise sense than in general works, the authors of which are usually unacquainted with the correct appellation of the products of nature.

In the first place, there is no doubt that the name *arz* or *ars* (آرز) is, at the present day, applied to the cedar of Lebanon, by the Arabs in the neighbourhood. Mr. Harmer, on Canticles v. 15, observes that the country people near the

mountain call the cedar *ars*, which is very nearly the original name. But the same name appears to be applied also to others of the pine tribe: thus 'at Aleppo the fir-tree is included under the name *ars*' (Niebuhr, as quoted by Rosenmüller, *Bibl. Bot.* p. 246). So we find the term *alerce*, that is *al-ars*, applied by the Arabs to a coniferous plant, a native of Mount Atlas, and of other uncultivated hills on the coast of Africa. The wood-work of the roof of the celebrated mosque, now the cathedral, of Cordova, which was built in the ninth century, has been proved to be formed of the wood of this tree (Loudon's *Arboret.* p. 2463). From *alerce* the English name *larch* is supposed to have been derived. If we consult Persian works on *Materia Medica* we find the name *aras* or *orus* given as a synonyme of *abhu*, which is a species of juniper: so, again, *ooruz* is described as *darukht sunobur bur*, that is, 'the pine-tree without fruit;' *sunobur* appearing as the general term for pine-trees, which are distinguished by the name of *sunobur sughar*, 'the lesser pine,' called also *tunoob*, and *sunobur kubar*, 'the larger pine;' of this are given, as synonyms, *nasöv* and *chilghozah*, which is the *Pinus Gerardiana* of Botanists. With the

Arabs, as quoted by Celsius, *l. c.* p. 107: 'آرز (*arz*) nomen generale est ad pini species designandas; and he further quotes Abu'l Fadli, as stating, 'Arz est arbor zanaubar (*pinus*) cujus, quoad omnes ejus species, mentionem facimus sub lit. Z. si Deus volet.—Loco conducto hoc modo pergit: Zanaubar (*pinus*) est arbor magna Gignitur in montibus, et regionibus frigidis Ejus tres sunt species, mas nempe, et femina major, atque minor.' It is not necessary for us on the present occasion to determine what are the species intended by the Arabian authors. They no doubt sometimes follow Dioscorides, and at other times insert names and descriptions which will apply only to the species indigenous in the mountains of Persia. Different species of pine, therefore, will be adduced as the kinds intended, in different countries. We may also remark, as stated by Celsius, that the translators of the sacred Scriptures into Arabic sometimes use the term *sunobar*, sometimes *arz*, as the representative of *eres*.

Rosenmüller states that 'the word *eres*, which occurs so frequently in the Old Testament, is, by the ancient translators, universally rendered cedar' (κέδρος). Therefore it has been inferred by him, as well as others, that the cedar of Lebanon must be intended: but the name does not appear to have been applied specially to this tree by the ancients. Thus the κέδρος of Dioscorides is supposed by Sprengel, in his edition of that author, to be a species of juniper, and Dr. Lindley, the editor of the last numbers of Sibthorpe's *Flora Græca*, agrees with him: 'κέδρος, juniperus oxycedrus, vel potius J. Phœnicea, secundum Sprengelium, cui assentio, κέδρος μικρά, juniperus communis.' J. oxycedrus is the brown-berried juniper, and J. Phœnicea is the Phœnician juniper or cedar, while J. Lycia, the Lycian juniper or cedar, is cedrus Phœnicea altera Plinii et Theophrasti. These have already been mentioned under the article BĒROSH.

Pliny, speaking of the plants of Syria, says, 'Juniperi similem habent Phœnices et cedrus minorem. Duo ejus genera, Lycia et Phœnicia,

differunt folio: nam quæ durum, acutum, spinosum habet, oxycedros vocatur, ramosa et nodis infesta: altera odore præstat. Fructum ferunt myrti magnitudine, dulcem sapore. Et majoris cedri duo genera: quæ floret, fructum non fert. Frugifera non floret: et in ea antecedentem fructum occupat novus. Semen ejus cupresso simile. Quidam cedrelatan vocant. Ex hac resina laudatissima' (*Hist. Nat. xiii. 11*). The conclusion of this passage, as translated by Holland, is, 'and the timber of it is everlasting: wherefore in old time they were wont to make the images of the gods of this wood, as it appeareth by the statue of Apollo Sossianus, made of cedar wood brought from Seleuc a.' Again (*xvi. 39*), 'as for cedars, the best simply be those that grow in Candia, Africke, and Syrie. This vertue hath the oile of cedar, that if any wood or timber be thoroughly anointed therewith it is subject neither to worm nor moth, nor yet to rottenesse.' The greater part of this account of the different kinds of cedar is adopted from Theophrastus (*iii. 12*); though, no doubt, the latter was also acquainted with a large cedar, as appears from *lib. v. c. 9*, where, speaking of Syria, he says, 'Illic enim cedri in montibus, cum longitudine, tum crassitudine præstantissimæ nascuntur.' Quintus Curtius also uses the term κέδρος in a general sense, when he says of the palace of Persepolis, 'multa cedro ædificata erat regia.'

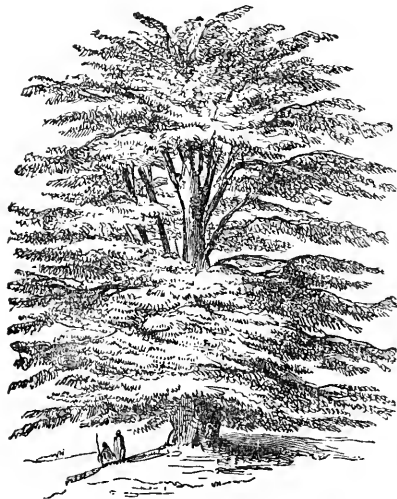

283. [Cedar of Lebanon.]

If we proceed to compare the several passages of Scripture in which the word Eres occurs, we shall equally find that one plant is not strictly applicable to them all. The earliest notice of the cedar is in *Lev. xiv. 4, 6*, where we are told that Moses commanded the leper that was to be cleansed to make an offering of two sparrows, cedar-wood, wool dyed in scarlet, and hyssop; and in *ver. 49, 51, 52*, the houses in which the lepers dwell are directed to be purified with the same materials. Again, in *Num. xix. 6*, Moses and Aaron are commanded to sacrifice a red heifer: 'And the priest shall take cedar-wood and hyssop and scarlet.' As remarked by Lady

Callcott (*Scrip. Herbal, p. 92*), 'The cedar was not a native of Egypt, nor could it have been procured in the desert without great difficulty; but the juniper is most plentiful there, and takes deep root in the crevices of the rocks of Mount Sinai.' That some, at least, of the cedars of the ancients were a species of juniper is evident from the passages we have quoted; the wood of most of them is more or less aromatic. The ancients, it may be remarked, threw the berries of the juniper on funeral piles, to protect the departing spirit from evil influences, and offered its wood in sacrifice to the infernal gods, because they believed its presence was acceptable to them. They also burned it in their dwelling-houses to keep away demons. It is curious that, in the remote parts of the Himalayan Mountains, another species of this genus is similarly employed, as the present writer has mentioned elsewhere (*Himalayan Botany, p. 350*): 'Here there is also another species, *Juniperus religiosa*, Royle, called *gogul* by the natives, and employed for burning as incense in their religious ceremonies.'

At a later period we have notices of the various uses to which the wood of the *eres* was applied, as *2 Sam. v. 11*; *vii. 2-7*; *1 Kings v. 6, 8, 10*; *vi. 9, 10, 15, 16, 18, 20*; *vii. 2, 3, 7, 11, 12*; *ix. 11*; *x. 27*; *1 Chron. xvii. 6*; *2 Chron. ii. 8*; *ix. 27*; *xxv. 18*. In these passages we are informed of the negotiations with Hiram, King of Tyre, for the supply of cedar-trees out of Lebanon, and of the uses to which the timber was applied in the construction of the Temple, and of the king's palace: he 'covered the house with beams and boards of cedar;' 'the walls of the house within were covered with boards of cedar;' there were 'cedar pillars,' and 'beams of cedar;' and the altar was of cedar. In all these passages the word *eres* is employed, for which the Arabic translation, according to Celsius (*loc. cit.*), gives *sumobar* as the synonyme. There is nothing distinctive stated respecting the character of the wood, from which we might draw any certain conclusion, further than that, from the selection made and the constant mention of the material used, it may be fairly inferred that it must have been considered as well fitted, or rather, of a superior quality, for the purpose of building the Temple and palace. From this, however, proceeds the difficulty in admitting that what we call the cedar of Lebanon was the only tree intended by the name *Eres*. For modern experience has ascertained that its wood is not of a superior quality. To determine this point, we must not refer to the statements of those who take their descriptions from writers who, indeed, describe cedar-wood, but do not prove that it was derived from the cedar of Lebanon. The term 'cedar' seems to have been as indefinite in ancient as in modern times. Now we find it applied to the wood of *Juniperus virginiana*, which is red or pencil cedar; and to that of *J. Bermudiana* or Bermuda cedar. *J. oxycedrus* yields the cedar of the north of Spain and south of France, but the term is also applied to many other woods, as to white cedar, that of *Melia Azedarach*; and Indian cedar, that of *Cedrela Toona*.

Mr. Loudon, in his *Arboretum* (*p. 2417*), describes it thus: 'The wood of the cedar is of a reddish white, light and spongy, easily worked, but very apt to shrink and warp, and by no means du-

table.' But when the tree is grown on mountains, the annual layers of wood are much narrower and the fibre much finer than when it is grown on plains; so much so that a piece of cedar-wood brought from Mount Lebanon by Dr. Parisel, in 1829, and which he had made into a small piece of furniture, presented a surface compact, agreeably veined, and variously shaded, and which, on the whole, may be considered handsome (*Hist. du Cedre*, p. 43). But Dr. Pococke, who brought away a piece of one of the large cedars which had been blown down by the wind, says that the wood does not differ in appearance from white deal, and that it does not appear to be harder. Varennes de Feuille considers it as the lightest of the resinous woods, and he adds that it contains very little resin; that its grain is coarse, and that he thinks the wood can neither be so strong nor so durable as it has the reputation of being. Mr. Loudon says (*loc. cit.*) that a table which Sir J. Banks had made out of the Hillingdon cedar was soft, without scent (except that of common deal), and possessed little variety of veining; and the same remarks will apply to a table which Mr. L. had made from a plank which is referred to as having been kindly presented to him by J. Gostling, Esq. of Whitton Park. Dr. Lindley (*Gardener's Chronicle*, vol. i. p. 699) calls it 'the worthless, though magnificent cedar of Mount Lebanon.' A correspondent, however, at p. 733, says, 'Mr. Wilcox of Warwick, a most ingenious and skilful carver (in his works little inferior to the celebrated Gibbons), has now in his rooms some specimens of furniture made of cedar of Lebanon, ornamented with carved work, in flowers, leaves, &c. &c., in the best taste, and in sharpness and colour so similar to box-wood that any common observer would mistake it to be such.' In reply to this Dr. Lindley adds, 'The fact last mentioned is the first that has come to our knowledge of the cedar of Lebanon having been found of important use.' He is of opinion that some of the cedar-trees sent by Hiram, king of Tyre, may have been obtained from Mount Atlas, and may have been the produce of the above *Alerce* or *Al Arz*—the *Callitris quadrivalvis*—which no doubt furnished the ancients with one of their most valued woods [ΤΥΡΙΝΕ]. This is hard, durable and fragrant, and commonly used in religious buildings in the East. Though we have seen both temples and palaces built entirely with one kind of cedar (that of the *Cedrus Deodara*), we think it more probable that, as the timber had to be brought from a distance, where all the kinds of cedar grew, the common pine-tree and the cedar of Lebanon would both furnish some of the timber required for the building of the Temple, together with juniper cedar. The name *arz*, as we have seen, is applied by the Arabs to all three; and they would give all the qualities of timber that could be required. We have shown that the κέδρος of the ancients was most probably the wood of a juniper. Celsius was of opinion that the *eres* indicated the *Pinus sylvestris* or Scotch pine, which yields the red and yellow deals of Norway, and which is likewise found on Mount Lebanon. This opinion seems to be confirmed by Ezekiel xxvii. 5, 'They have made all thy ship boards of fir-trees of Senir, they have taken cedar from Lebanon to make masts for thee.' For it is not probable that any other tree

than the common pine would be taken for masts, when this was procurable, since even in the present day 'Pallas assures us that the pine of Livonia and Lithuania differs not from the *Pinus sylvestris*; masts, he says, are not made of any peculiar species, as foreigners, and more especially the French, think; but they are all of the *Pinus sylvestris*' (London, *Arboret.* p. 2158).

Though Celsius appears to us to be quite right in concluding that *eres*, in some of the passages of Scripture, refers to the pine-tree, yet it seems equally clear that there are other passages to which this tree will not answer. It certainly appears improbable that a tree so remarkable for the magnificence of its appearance as the cedar of Lebanon should not have been noticed in the Sacred Scriptures; and this would be the case if we applied *eres* exclusively to the pine, and *berosh* to the cypress. If we consider some of the remaining passages of Scripture, we cannot fail to perceive that they forcibly apply to the cedar of Lebanon and to the cedar of Lebanon only. Thus, in Ps. xcii. 12, it is said, 'The righteous shall flourish like a palm-tree, and spread abroad like a cedar of Lebanon.' It has been well remarked 'that the flourishing head of the palm and the spreading abroad of the cedar are equally characteristic.' But the prophet Ezekiel (ch. xxxi.) is justly adduced as giving the most magnificent and, at the same time, the most graphic description of this celebrated tree (ver. 3): 'Behold, the Assyrian was a cedar in Lebanon with fair branches, and with a shadowy shroud, and of an high stature; and his top was among the thick boughs:' (ver. 5) 'Therefore his height was exalted above all the trees of the field, and his boughs were multiplied, and his branches became long because of the multitude of waters:' (ver. 6) 'All the fowls of heaven made their nests in his boughs, and under his branches did all the beasts of the field bring forth their young.' In this description, Mr. Gilpin has well observed, 'the principal characteristics of the cedar are marked: first, the multiplicity and length of its branches. Few trees divide so many fair branches from the main stem, or spread over so large a compass of ground. 'His boughs are multiplied,' as Ezekiel says, 'and his branches become long,' which David calls spreading abroad. His very boughs are equal to the stem of a fir or a chestnut. The second characteristic is what Ezekiel, with great beauty and aptness, calls his shadowy shroud. No tree in the forest is more remarkable than the cedar for its close-woven leafy canopy. Ezekiel's cedar is marked as a tree of full and perfect growth, from the circumstance of its top being among the thick boughs.' The other principal passages in which the cedar is mentioned are 1 Kings iv. 33; 2 Kings xix. 23; Job xl. 17; Ps. xxix. 5; lxxx. 10; xcii. 12; civ. 16; cxlviii. 9; Cant. i. 17; v. 15; viii. 9; Isa. ii. 13; ix. 8, 10; xiv. 8; xxxvii. 21; xli. 19; xlv. 14; Jer. xxii. 7, 14, 23; Ezek. xvii. 3, 22, 23; Amos ii. 9; Zeph. ii. 14; Zech. xi. 1, 2; and in the Apocrypha, 1 Esdras iv. 48; v. 55; Eccles. xxiv. 13; 1. 12; but it would occupy too much space to adduce further illustrations from them of what indeed is the usually admitted opinion.

It is, however, necessary before concluding to give some account of this celebrated tree, as noticed by travellers in the East, all of whom make

a pilgrimage to its native sites. The cedar of Lebanon is well known to be a widely-spreading tree, generally from 50 to 80 feet high, and when standing singly, often covering a space with its branches, the diameter of which is much greater than its height. The horizontal branches, when the tree is exposed on all sides, are very large in proportion to the trunk, being disposed in distinct layers or stages, and the distance to which they extend diminishes as they approach the top, where they form a pyramidal head, broad in proportion to its height. The branchlets are disposed in a flat fan-like manner on the branches. The leaves, produced in tufts, are straight, about one inch long, slender, nearly cylindrical, tapering to a point, and are on short footstalks. The male catkins are single, solitary, of a reddish hue, about two inches long, terminal and turning upwards. The female catkins are short, erect, roundish, and rather oval; they change after fecundation into oval oblong cones, which, when they approach maturity, become from 2½ inches to 5 inches long. Every part of the cone abounds with resin, which sometimes exudes from between the scales. Belon, who travelled in Syria about 1550, found the cedars about 28 in number, in a valley on the sides of the mountains. Rauwolf, who visited the cedars in 1574, 'could tell no more but 24, that stood round about in a circle; and two others, the branches whereof are quite decayed from age.' De la Roque, in 1688, found but 20. Maundrell, in 1696, found them reduced to 16, and Dr. Pococke, who visited Syria 1744 and 1745, discovered only 15. One of these, that had the soudest body, though not the largest, measured 24 feet in circumference, and another, with a sort of triple body, and of a triangular figure, measured 12 feet on each side. 'The wood,' he says, 'does not differ from white deal in appearance, nor does it seem to be harder. It has a fine smell, but is not so fragrant as the juniper of America, which is commonly called cedar, and it also falls short of it in beauty. I took a piece of the wood from a great tree that was blown down by the wind, and left there to rot: there are 15 large ones standing.' Mr. Buckingham, in 1825, says, 'Leaving Biskerry on our right, we ascended for an hour over light snow, until we came to the *Arz-el Libinien*, or the cedars of Lebanon.' M. Laure, who, in company with the Prince de Joinville, visited the cedars in 1836, calls them *El-Herzé*. M. Lamarine, in 1832, says, 'These trees diminish in every succeeding age. Travellers formerly counted 30 or 40; more recently, 17; more recently still, only 12. There are now but 7. These, however, from their size and general appearance, may be fairly presumed to have existed in biblical times. Around these ancient witnesses of ages long since past, there still remains a little grove of yellow cedars, appearing to me to form a group of from 400 to 500 trees or shrubs. Every year, in the month of June, the inhabitants of Beschierai, of Eden, of Kandbin, and the other neighbouring valleys and villages, climb up to these cedars, and celebrate mass at their feet. How many prayers have resounded under these branches, and what more beautiful canopy for worship can exist!'—J. F. R.

ESAR-HADDON. [ASSYRIA.]

ESAU (עֵשָׂו; Sept. Ἡσαῦ). The origin and meaning of the name are not quite free from am-

biguity. Simon, deriving the word from עֵשֶׂה, *textit*, renders it *pilis opertus* (covered with hair), and some such reason as this implies, seems involved in the passage Gen. xxv. 25. Cruden, however, explains the name as meaning *one who does* (qui facit), an actor or agent. His surname of Edom (red) was given him, it appears (Gen. xxv. 30) from the red pottage which he asked of Jacob. Esau was the eldest son of Isaac, Abraham's son (Gen. xxv. 19) by Rebekah, 'the daughter of Bethuel the Syrian of Padan-aram, the sister to Laban the Syrian.' The marriage remaining for some time (about 19 years; compare xxv. 20, 26) unproductive, Isaac entreated Jehovah, and she became pregnant. Led by peculiar feelings 'to inquire of Jehovah,' Rebekah was informed that she should give birth to twins, whose fate would be as diverse as their character, and, what in those days was stranger still, that the elder should serve the younger. On occasion of her delivery the child that was born first was 'red, all over like an hairy garment; and they called his name Esau.' Immediately afterwards Jacob was born.

In process of time the different natural endowments of the two boys began to display their effects in dissimilar aptitudes and pursuits. While Jacob was led by his less robust make and quiet disposition to fulfil the duties of a shepherd's life, and pass his days in and around his tent, Esau was impelled, by the arduous and lofty spirit which agitated his bosom, to seek in the toils, adventures, and perils of the chase, his occupation and sustenance: and, as is generally the case in natures like his, he gained high repute by his skill and daring.

A hunter's life is of necessity one of uncertainty as well as hardship; days pass in which the greatest vigilance and the most strenuous exertions may fail even to find, much less capture, game. The hunting tribes of North America often find themselves, after severe and long-continued labour and watching, unprovided with food, and necessitated to a length of abstinence which would be fatal to persons bred in towns or living by the ordinary pursuits of the field. Esau had on one occasion experienced such a disappointment, and, wearied with his unproductive efforts, exhausted for want of sustenance, and despairing of capturing any prey, he was fain to turn his steps to his father's house for succour in his extremity. On reaching home he found his brother enjoying a carefully prepared dish of pottage: attracted by the odour of which he besought Jacob to allow him to share in the meal. His brother saw the exigency in which Esau was, and determined not to let it pass unimproved. Accordingly he puts a price on the required food. Esau was the elder, and had in consequence immunities and privileges which were of high value. The surrender of these to himself Jacob makes the condition of his complying with Esau's petition. Urged by the cravings of hunger, alarmed even by the fear of instant death, Esau sold his birth-right to his younger brother, confirming the contract by the sanction of an oath. Jacob having thus got his price, supplied the famishing Esau with needful refreshments.

Arrived now at years of maturity Esau, when 40 years of age, married two wives, Judith and Bashemoth. Some unhappy feelings appear to

have previously existed in the family; for while Esau was a favourite with his father, in consequence, it appears, of the presents of venison which the youth gave him, Jacob was regarded with special affection by the mother. These partialities, and their natural consequences in unamiable feelings, were increased and exaggerated by Esau's marriage. Judith and Basemoth were Canaanites, and, on account of their origin, were unacceptable to Isaac and Rebekah. The latter was especially grieved. 'I am weary,' she said (Gen. xxvii. 46), 'of my life, because of the daughters of Heth.' Esau thus became alienated from the parental home. Even his father's preference of him may have been injuriously affected. The way was in some measure smoothed for the transference of the coveted birthright to the younger son.

The time for the fulfilment of the compact between the brothers at length arrived. Isaac is 'sick unto death.' His appetite, as well as his strength, having failed, is only to be gratified by provocatives. He desires some savoury venison, and gives the requisite instructions to Esau, who accordingly proceeds in quest of it. On this Rebekah begins to feel that the critical time has come. If the hated Hittites are not to enter with her less favoured son into possession of the family property, the sale of the birthright (the original idea of which she may have suggested to the 'plain man,' her son Jacob) must now in some way be confirmed and consummated. One essential particular remained—the father's blessing. If this should be given to Esau, all hope was gone; for this, like our modern wills, would hand the inheritance and the accompanying headship of the tribe to Esau and his wives.

Isaac, however, had lost his sight—indeed, all his senses were dull and feeble. It was therefore not very difficult to pass off Jacob upon him as Esau. Rebekah takes her measures, and, notwithstanding Jacob's fears, succeeds. Isaac, indeed, is not without suspicion, but a falsehood comes to aid Jacob in his otherwise discreditable personation of Esau. The blessing is pronounced, and thus the coveted property and ascendancy are secured. The affectionate endearments which pass between the deceiver and the abused old blind father stand in painful contrast with the base trickery by which mother and son had accomplished their end.

Esau, however, returns from the field, approaches his decrepid and sightless father, declaring who he is. 'And Isaac trembled very exceedingly, and said, Who? where is he that hath taken venison and brought it me, and I have eaten of all before thou earnest, and have blessed him?—yea, and he shall be blessed.' On this Esau becomes agitated, and entreats a blessing for himself—'Bless me, even me also, O my father.' Urging this entreaty again and again, even with tears, Isaac at length said unto him, 'Behold, thy dwelling shall be the fatness of the earth, and of the dew of heaven from above; and by thy sword shalt thou live, and shalt serve thy brother; and it shall come to pass when thou shalt have the dominion that thou shalt break his yoke from off thy neck' (Gen. xxvii.).

Thus, deprived for ever of his birthright, in virtue of the irrevocable blessing, Esau but too

naturally conceived and entertained a hatred of Jacob, and even formed a resolution to seize the opportunity for slaying him, which the days of mourning consequent on the approaching decease of their father would be likely to afford. Words to this effect, which Esau let drop, were repeated to his mother, who thereupon prevailed on her younger son to flee to his uncle Laban, who lived in Haran, there to remain until time, with its usual effect, might have mitigated Esau's wrath. Meanwhile Esau had grown powerful in Idumæa, and when, after many years, Jacob intended to return within the borders of the Jordan, he feared lest his elder brother might intercept him on his way, to take revenge for former injuries. He accordingly sent messengers to Esau in order, if possible, to disarm his wrath. Esau appears to have announced in reply, that he would proceed to meet his returning brother. When, therefore, Jacob was informed that Esau was on his way for this purpose with a band of four hundred men, he was greatly distressed, in fear of that hostility which his conscience told him he had done something to deserve. What then must have been his surprise when he saw Esau running with extended arms to greet and embrace him? and Esau 'fell on his neck, and kissed him, and they wept.' Jacob had prepared a present for Esau, hoping thus to conciliate his favour; but with the generous ardour which characterizes, and somewhat of the disinterestedness which adorns, natures like his, Esau at first courteously refused the gift—'I have enough, my brother, keep that thou hast unto thyself' (Gen. xxxiii.).

The whole of this rencontre serves to show that, if Jacob had acquired riches, Esau had gained power and influence as well as property; and the homage which is paid to him indirectly, and by implication, on the part of Jacob, and directly, and in the most marked and respectful manner, by the females and children of Jacob's family, leads to the supposition that he had made himself supreme in the surrounding country of Idumæa.

Esau from this time appears but very little in the sacred narrative. He was ready to accompany Jacob, or to send with him an escort, probably for protection, but Jacob's fears and suspicions induced him to decline these friendly offers; and they separated on the same day that they met, after an interview in which Jacob's bearing is rather that of an inferior to his lord than that of a brother, and Esau's has all the generosity which a high nature feels in forgiving an injury and aiming to do good to the injurer. The latter, we are merely told, 'returned on his way to Seir' (Gen. xxxiii. 16).

Jacob and Esau appear together again at the funeral rites which were paid to their deceased father; but the book of Genesis furnishes no particulars of what took place.

Esau is once more presented to us (Gen. xxxvi.) in a genealogical table, in which a long line of illustrious descendants is referred to 'Esau, the father of the Edomites' (Gen. xxxvi. 43).

If the historical outline now given is supported by the scriptural narrative, the character of Esau has not ordinarily received justice at the hands of theologians. The injurious impression against him may be traced back to a very ancient period. The Targum of Jonathan sanctioned and spread, if it did not originate, the misjudgment, by un-

warrantable additions to the account given in Genesis. The reason, it states, why Esau did not at once slay his brother was, lest, as happened in the case of Cain and Abel, another man-child might be born, and thus he should be still deprived of the inheritance; he, therefore, resolved to wait till the death of Isaac, when the murder of Jacob would leave him in safe and undisputed possession. Representations made in the Talmud are of a similar tendency (Winer's *Realwörterbuch*, in voc.). The fathers of the Church, particularly Augustine, regard Esau as the representative of the damned, while they admire Jacob as that of the elect.—J. R. B.

ESDRAËLON, PLAIN OF. [PALESTINE.]

ESDRAS, BOOKS OF, (APOCRYPHA); Gr. *Ἐσδρας*, Lat. *Esdras*. In several manuscripts of the Latin Vulgate, as well as in all the printed editions anterior to the decree of the Council of Trent, and in many since that period, there will be found four books following each other, entitled the 1st, 2nd, 3rd, and 4th books of Ezra. The two first are the canonical books of Ezra and Nehemiah, the 3rd and 4th form the subject of the present article. They are the same which are called 1st and 2nd Esdras in the English Authorized Version.

THE THIRD BOOK OF EZRA is found in all the manuscripts of the Seventy, where it is called the *first* book, and precedes the second or canonical Ezra, which, in this version, includes the book of Nehemiah. It contains 109 κεφαλαία. It is little more than a recapitulation of the history contained in the canonical Ezra, interspersed with some remarkable interpolations, the chief of which are chap. i., taken from 2 Chron. xxxv. xxxvi., part of the last chapter, from Nehem. viii., and the narration of the themes or sentences of Zorobabel and the two other young men of Darius's body-guard (3 Esd. iii. 4). The book is more properly a version than an original work. The style is acknowledged to be elegant, and not unlike that of Symmachus. This book was made use of by Josephus, who cites it largely in his *Antiquities*, but nothing further has been ascertained respecting the age either of the original or the translation. It is cited by Clemens Alexandrinus (*Stromata*, i.), the author of the *Imperfect Work on Math.* (Hom. i.), Athanasius (*Orat. iii. cont. Arianos*), and by Cyprian (*Epist. ad Pompeium*).

From the circumstance of Jerome's having declined to translate the third and fourth books of Ezra, they are (with the exception of the book of Job and the Psalms) the only portions either of the canonical or apocryphal writings of the Old Testament which have been preserved to us entire in the old Latin translation. We have already noticed the contempt in which Jerome held these books (see the extract from his letter to Vigilantius, *supra*, p. 177, APOCRYPHA, where Athanasius is a misprint for Jerome). In his preface to Ezra and Nehemiah, he observes, 'None should be troubled by the circumstance that only one book [of Ezra] has been published by us, nor should any take pleasure in the dreams of the third and fourth apocryphal books, for, in the Hebrew, Ezra and Nehemiah form but one volume, and what is not of the twenty-four elders is to be utterly rejected.' Augustine speaks of the third book with more

respect, although we have already seen [DEUTEROCANONICAL] that he did not include it in his catalogue. Ezra, he says (*De Civitate Dei*, lib. xviii. cap. 36) . . . 'who is rather to be considered a historian than a prophet, unless, indeed, he may be understood to have prophesied, when . . . he demonstrates that *truth is the strongest* (alluding to 3 Ezra, ch. iii. iv.), for, in the gospel, Christ is acknowledged to be the truth.'

This book does not, however, appear to have been included in the catalogue of any council, nor has any portion of it been read in the offices of the church. Having been rejected as apocryphal by the Council of Trent, it has been removed, together with the fourth book, in the Sixtine and Clementine editions of the Vulgate, to the end of the volume, with the observation that they are thus retained in order to 'preserve from being altogether lost books which had been sometimes cited by some of the holy fathers. The following is the order of the books of the Old Testament declared to be canonical by this council:—5 of Moses; Joshua; Judges; Ruth; 4 of Kings; 2 of Chronicles; 2 of Ezra (viz. Ezra and Nehemiah); Tobit; Judith; Esther; Job; Psalms; Proverbs; Ecclesiastes; Canticles; Wisdom; Ecclesiasticus; Isaiah; Jeremiah with Baruch; Ezekiel; Daniel; 12 minor Prophets, viz. Hosea, Joel, Amos, Abdias, Jonas, Micah, Nahum, Habacuc, Zephaniah, Haggai, Zecharias, Malachi, and 2 of Maccabees.

THE FOURTH BOOK OF EZRA is quite of a different character from the former, and it has been even doubted whether it more properly belongs to the Apocrypha of the Old or the New Testament, but the circumstance of the author's personating the celebrated scribe of that name has been supposed to have led to its obtaining a place in the former. It consists of a number of similitudes or visions, resembling in some passages the Apocalypse. The descriptions are acknowledged to be sometimes most spirited and striking, occasionally rising to great sublimity of thought, energy of conception, and elegance of expression (*Lee's Epistolary Discourse*; Laurence's *Æthiopic Version of Ezra*). This would probably be still more apparent had we the book in the original, for it seems highly probable that this, as well as the former book, is a translation from the Hebrew or Chaldee (Morini *Æcercit. Bibl.* lib. ii. p. 225; Fabricii *Cod. Pseud. V. T.* iii. 189). But neither this nor the Greek Version, which was known to Clemens Alexandrinus in the second century (*Stromata*, iii.), are any longer in existence, and the book was supposed to have been preserved only in the old Latin Ante-Hieronymian Version, until the middle of the seventeenth century, when an Arabic version was discovered in the Bodleian Library by Mr. Gregory, a translation of which, by Simon Ockley, the Arabic Professor at Cambridge, was published, in 1711, by Mr. William Whiston (*Primitive Christianity*, vol. iv.). Subsequently an Æthiopic version, which, although known to Ludolf, was concealed from the world, was published for the first time, accompanied by a Latin and English translation, by the late Archbishop Laurence, in 1820. It had been supposed indeed by some, that the work was extant in Hebrew, and Archbishop Laurence states, on the authority of Father Simon, that Leo Judah's translation, which ap-

peared in Robert Stephen's octavo Bible (1545 ?), was from a Hebrew manuscript, which, however, the Archbishop asserts, was itself unquestionably a translation into Hebrew from the printed Vulgate. The truth of the matter, however, we believe to be, that Leo Judah only translated the canonical books, while the apocryphal were done by Cholin, who merely put such Hebrew words in the margin as he conjectured to have been the originals; for the translator observes in the preface that he had 'never seen the book either in Greek or Hebrew.' It is remarked in some of Stephen's editions, that the *prophet* Ezra, who wrote this book, was probably a different person from the *scribe*. But, scornfully as Jerome looked upon this book, and that probably more on dogmatical than purely critical grounds, it was highly esteemed by others among the Fathers of the Christian church. The book is ascribed to the *prophet* Ezra by Clemens Alexandrinus (*Strom.* b. iii.), who looked upon it as canonical and divine, as did Irenæus, Tertullian, and Ambrose, who has made several quotations from this 'prophet,' as he also styles him (Sixtus Senensis, *Biblioth. Sanct.*), and among others, one which no longer exists in the Latin, but is found both in the Arabic and Æthiopic (Laurence's *Ezra*). In the church of Rome the mass for Whittuesday commences with a sentence from 4 Ezra, ch. ii. 36, 37 ('Receive,' &c., to 'kingdom'), and on the anniversary of the Martyrs, with another from the same chapter, ver. 45, 'Now are they crowned and receive palms.' Jahn observes that the 'catholics have made many martyrs on its authority' (*Heb. Commonwealth*, b. v.). Pico de Mirandula considered this book as divinely inspired, and Gaspar Zamora placed it in his Concordance between Nehemiah and Maccabees. An 'anonymous catholic,' cited by Jahn, maintains that the Pseudo-Ezra was considered as an inspired writer until the time of the Council of Trent; but this is scarcely consistent with the fact, that although all the printed editions of the Vulgate, before the time of the council, contain the four books of Ezra without any mark of doubt, very few *manuscripts* are known to possess the fourth. Among modern writers, Whiston (*Authentic Records*), and others, both before and since his time, have considered this book as an inspired composition, and as the genuine production of Ezra (See *Prophecy that hath lain hid above these 2000 years; Middle State of the Souls Departed; the Prophecies of the Second Book of Esdras*, by Sir John Floyer).

Author and Age of the Fourth Book of Ezra.—Jahn (*ut supra*) supposes the author to have been a Jew, educated in Chaldea, who borrowed his style from Daniel, and who, having become a Christian, still retained his reverence for Cabalistic traditions. He places him in the first or early in the second century (see also Vogel's *Commentatio de quarto lib. Esdræ*, Altorf, 1795). Archbishop Laurence, on the other hand (*ut supra*), conceives that the author was a Jew who never changed his creed, and endeavoured to destroy the two main arguments in favour of the work having emanated from a Christian: one of these is founded on the remarkable fact that the author speaks of Jesus by name (chap. vii. 28), the other on the circumstance of his being plainly conversant with the Christian Scriptures.

As to the former, Dr. Laurence appeals to the Æthiopic Version, where the text is (not *my Son Jesus*, but) '*my Messiah* shall be revealed, which is confirmed by the Arabic reading, *my Son Messiah*. The Archbishop considers these texts both in the Latin and Arabic to be interpolations or explanatory glosses. The argument derived from the author's acquaintance with the Christian Scriptures is principally founded on the two first chapters, which are wanting in both the Arabic and Æthiopic Versions, and in most manuscripts of the Latin are placed at the beginning of the third book of Ezra, or at the end of Nehemiah, where they form a distinct book. The two last chapters are equally wanting in these versions, and in most Latin manuscripts form a fifth book, or are otherwise clearly distinguished from the former part of the book. This fifth book is in some manuscripts divided into seven chapters, and the whole of the fourth into thirty-nine. The division into two chapters is erroneously ascribed by Dr. Frank Lee to Robert Stephen, for the same division is found in the Editio Princeps by Fust and Schoeffer, printed in 1462, where also the two last chapters, as well as the two first, are incorporated into the rest of the book, and have so continued in all subsequent editions. Dr. Laurence concludes from other internal grounds, that the book was written before the Christian era, after the death of Mark Anthony, and before the accession of Augustus, or between the 28th and 25th year before Christ. Upon this hypothesis he conceives, that besides that the doctrine of the immortality of the soul and a separate state of spiritual existence between death and judgment are distinctly described as the general and popular belief, the most important use of the book consists in the testimony which it bears to the Jewish idea of the Messiah, who is herein clearly and familiarly denominated by the appellation of the *Son of God*—as well as to the belief that previously to his appearance on earth he existed in heaven.

Dr. Lee (*ut supra*) is strongly of opinion that the author of this book was contemporary with the author of the book of Enoch, or rather that both these books were written by one and the same author. It does not appear that Josephus was aware of its existence.

Among the most remarkable passages in this book is that famous one (4 Ezra xiv.) which ascribes the recension of the entire Scriptures to Ezra. It is well known that the Rabbins have a tradition, preserved in the Talmud, that on the rebuilding of the Temple, Ezra assembled a college of 120 literati, known by the name of the Great Synagogue, for the purpose of collecting and arranging the Scriptures. Among the members are enumerated Daniel, Shadrach, Meshach, and Abednego, Haggai, Zechariah, Ezra, and Nehemiah, and Simon the Just. Ezra, who, they say, was the same with the prophet Malachi, they represent as the first, and Simon the Just, its latest surviving member, as the last president of the college. They further represent all these eminent men as living at the same period, under Darius Hystaspis, whom they suppose to be the same Darius who was subdued by Alexander, and also as that Artaxerxes who sent Ezra and Nehemiah to Jerusalem. Daniel is thus made to have

lived to the time of Alexander the Great, and Simon the Just they hold to be the same with Jadduah, the high-priest, who received Alexander in Jerusalem. To this synagogue the Rabbins ascribe the formation of the canon, to which they add that its members wrote Ezekiel, the twelve minor Prophets, Daniel and Esther, while Ezra wrote the book bearing his name, and the genealogies in Chronicles down to his time (*Bava Bathra*). Jahn (*Einkleitung*, 28) supposes that as there is no authority whatever for the existence of this synagogue, all that can be meant is, that the canon was settled by Ezra and the others named as members of the synagogue, and closed by Simon, who filled the office of high-priest for nine years till his death, B.C. 292 (Eusebius, *Chron.*). But, in addition to this, there was a current opinion among the early Christian writers to the effect that the law having been burned at the destruction of the Temple by Nebuchadnezzar, Ezra restored the whole from memory, or by divine inspiration. This notion of a revision or restoration of the Scriptures, founded on the statement of the Pseudo-Ezra, was looked upon as an undoubted fact by Irenæus (*Advers. Hæres.* iii. 25); Tertullian (*De Habit. Mulier.* cap. 1. p. 3, § 25); Clemens Alexandrinus (*Strom.* i. 329, 330, 342); Basil (*Epist. ad Chilon.* Paris, 1839, ii. pt. i. p. 184); Chrysostom (*Hom.* viii. in *Heb.*); Jerome (*Cont. Helvid.*); Augustine (*De Mirabilibus Scrip.* ii. 33); the author of the *Synopsis* (op. Athanas. ii. p. 124); Theodoret (*Præf. Com. in Cant.*); and Leontius of Byzantium (*De Sectis*, p. 428). It was revived by Spinoza (*Tract. Theol. polit.* ch. 3, § 9) and other modern sceptics, who sought to undermine the authority of the Scriptures by ascribing their composition to Ezra (in refutation of which opinion see the *Introductions* of Carpov, Eichhorn, Jahn, and De Wette), and who referred, in proof of their theory, to certain passages which seem to betray a later date than that usually ascribed to the composition of these books.

Dean Prideaux, who observes (*Connexion*, part i., b. v.) that 'it would shock the faith of the whole should it be held that it owed its present being to such a revival, it being obvious for sceptical persons to object that he who should be said thus to revise it, then forged the whole,' has formed out of these traditions a hypothesis, which, although resting on no historic basis, has met with a favourable reception from its supposed probability. He assumes that Ezra settled the canon up to his time, and was the probable author of Chronicles, Ezra, and Esther, which, together with the books of Nehemiah and Malachi, were added by Simon the Just, by whom the canon was closed in the commencement of the third century before Christ. As, however, mention is made in Nehemiah of Darius, who lived a century later than Ezra, and of Jadduah, who died two years after the death of Alexander the Great; and as the genealogy in Chronicles is brought down to about the year B.C. 300, which circumstances have induced some to ascribe the writing of these books to a period not more ancient than the era of Alexander, Prideaux looks upon these passages as late additions or interpolations, added by those who completed the canon; which is also the opinion of Jahn (*Introd.*), although he conceives the author not to have been

Ezra. Dean Prideaux, in fine, supposes that Ezra gave a new edition of the Scriptures, corrected the errors of transcribers, adding what appeared necessary for illustrating, correcting, or completing them, changing names, and supplying what was wanting. He further maintains that Ezra was the author of several interpolations in all the books which passed his examination, and Simon the Just in all the rest, which were added afterwards (see the authorities in Buxtorf's *Tiberius*, c. xi. p. 103). By this hypothesis, which is a modification of the ancient idea, he endeavours to meet the objection raised against these books, and to supply by ingenious conjectures a deficiency where Scripture and history are silent. The reader will find some animadversions on Prideaux's hypothesis by the author of the article *Théologie*, in the *Encyclopédie*, who maintains that the pretended Great Synagogue had no divine and infallible authority to decide upon and close the canon. Eichhorn thinks it possible that Simon the Just has been confounded in the Talmudical fable with Simon the Maccabee, as he supposes that all the books in the canon could not have been written so early as the time of Simon the Just, but that the canon may have been closed under Simon the Maccabee (B.C. 141-135). St. Jerome mistakes him for Simeon, the contemporary of our Saviour. [MACCABEES; WISDOM OF SIRACH; SYNAGOGUE.]

Although Esdras is included in the 6th article among the other books read for edification, &c. (DEUTERO-CANONICAL), it will be observed that no lessons are taken from it in the offices of the church of England. References are, however, made from it in the Authorized Version to parallel passages in the Old and New Testament. Grabe and others have conceived that this was the book cited as the 'Wisdom of God' (Luc. xi. 9, comp. with 4 Esdras i. 32).—W. W.

ESHBAAL. [ISHBOSHETH.]

1. ESHCOL (עֶשְׂכֹל; Sept. Ἐσχόλ), one of the Amoritish chiefs with whom Abraham was in alliance when his camp was near Hebron, and who joined with him in the pursuit of Chedorlaomer and his allies, for the rescue of Lot (Gen. xiv. 13, 24).

2. ESHCOL. The name of the valley in which the Hebrew spies obtained the fine cluster of grapes which they took back with them, borne 'on a staff between two,' as a specimen of the fruits of the Promised Land (Num. xiii. 24). The cluster was doubtless large; but the fact that it was carried in this manner, does not, as usually understood, imply that the bunch was as much as two men could carry, seeing that it was probably so carried to prevent its being bruised in the journey. The valley of Eshcol probably took its name from the distinguished Amorite already mentioned, and is hence to be sought in the neighbourhood of Hebron. Accordingly the valley through which lies the commencement of the road from Hebron to Jerusalem is indicated as that of Eshcol. This valley is now full of vineyards and olive-yards; the former chiefly in the valley itself, the latter up the sides of the enclosing hills. 'These vineyards are still very fine, and produce the finest and largest grapes in all the country.' (Robinson, i. 317).

ESHEL (אֶשֶׁל), also ESCHEL and AISHEL, occurs in three places of Scripture, in one of which, in our Authorized Version, it is rendered *grove*, and in the other two *tree*. Celsius (*Hierobot.* i. 535) maintains that אֶשֶׁל has always a general, and not a specific signification, and that it is properly translated *tree*. This, as stated by Rosenmüller, has been satisfactorily refuted by Michaelis in his *Supplem.* p. 134. If we compare the passages in which the word *eshel* occurs, we shall see that there is no necessity for considering it a generic term: the more so, as we find in the Arabic a name very similar to it, and applied to a tree of which the character and properties would point it out as likely to attract notice in the situations where *eshel* is mentioned. The first notice of this tree is in Gen. xxi. 33, 'And Abraham planted a *grove (eshel)* in Beersheba, and called there on the name of the Lord.' The second notice is in 1 Sam. xxii. 6: 'Now Saul abode in Gibeah under a *tree (eshel)* in Ramah, having his spear in his hand, and all his servants were standing about him.' Under such a tree also he and his sons were buried, for it is said (1 Sam. xxxi. 13), 'And they took their bones, and buried them under a *tree (eshel)* at Jabesh, and fasted seven days.' In the parallel passage of 1 Chron. x. 12, the word *alah* is employed. This signifies a 'terebinth tree,' but is translated 'oak' in the Authorized Version: 'They arose, all the valiant men, and took away the body of Saul, and the bodies of his sons, and brought them to Jabesh, and burned their bones under the oak in Jabesh, and fasted seven days.'



384. [Tamarisk. *Tamarix orientalis*.]

Celsius has quoted several authorities in support of his opinion that *eshel* is used in a generic sense, as R. David Kimchi, who remarks, '*Eschel* est nomen generale omni arbori;' and with reference to the passage in Genesis, 'Et plantavit Eschel, h. m. interpretatur: et plantavit plantationem.' So Rosenmüller, though considering the term to be specific, says, 'We have the testimony of Rabbi Jonah or Abulwalid, in his *Hebrevo-Arabice Lexicon*, that the Arabic term *athle*

is not unfrequently used for any large tree, as was the word *eshel* by the later Hebrews.' The word *athle* which is cited, is no doubt the Arabic

أثل *asul* or *athul*. The letter ث is the fourth letter of the Arabic alphabet: its legitimate power appears to be that of *th* in the English word *thing*; but in the mouth of a Turk, Syrian, Egyptian, Persian, and a native of Hindoostan, it is either pronounced like an *s* lisped, or not to be distinguished from that character. In a few instances it is pronounced like *t* (Richardson, *Persian and Arabic Dictionary*). In that work اثل *asl* is

translated 'a tamarisk shrub;' اثلات *asalat*, 'large prickly tamarisks.' In *Illustr. Himal. Bot.* p. 214, we have said 'The Arabic name *asul* or *atul* is applied to *furax* (an arboreal species of tamarisk) in India, as to *T. orientalis* in Arabia and Egypt.' So in the *Ufaz Udweih*, translated by Mr. Gladwin, we have at No. 36, اثل *ussel*, the tamarisk bush, with 'jhaou as the Hindee; and گز *guz* as the Persian synonyme.

The tamarisk and its products were highly valued by the Arabs for their medicinal properties, and are described in several places under different names in Avicenna; the plant being noticed under *toorfa*, and the galls, which are often found on it, under *jouz-al-toorfa*, but which are also called *chezmezech* or *kuzmezech*. They adopt much of the description of Dioscorides, though the translation of Serapion no doubt errs in making *athel* the ἀκακάλις of the Greeks. But Serapion himself, from Isaac eben Amram, says, 'Athel est species tamarisci.'

If we refer to travellers in eastern countries, we shall find that most of them mention the *athul*. Thus Prosper Alpinus (*De Plantis Egypti*, c. ix. *De Tamarisco atle vocata*) gives a figure which sufficiently shows that it must grow to the size of a large tree: 'Alterum vero tamarisci domesticum genus in Ægypto spectatur—quod ad magnæ olivæ magnitudinem crescit;' and says that he had heard of its attaining, in another place, to the size of a large oak; that its wood was employed for making a variety of vessels, and its charcoal used throughout Egypt and Arabia; and that different parts of it were employed in medicines. So Forskal, who calls the species *Tamariscus orientalis*, gives, *atl* as its Arabic name, and identifies it with אֶשֶׁל, says, 'Gallæ Tamaricis in officinis usurpantur loco fructus.' Belon (in his *Observ.* ii. 28), says, 'Tamarices in Ægypto humidis et siccoribus locis indifferenter nascuntur; illarum enim silvulæ perinde in aridioribus locis reperuntur atque in humidis littoribus. Eæ autem excrementia quam Gallam nominavimus adeo onustæ sunt, ut parum absit quin rami præ pondere rumpantur.' In Arabia Burckhardt found the tree called *asul* in the neighbourhood of Medina, and observes that the Arabs cultivated it on account of the hardness of its wood. If we endeavour to trace a species of tamarisk in Syria, we shall find some difficulty from the want of precision in the information supplied by travellers on subjects of Natural History. But a French naturalist, M. Bové, who travelled from Cairo to Mount Sinai, and from

thence into Syria, has given ample proofs of the existence of species of tamarisk in these regions. Thus near Sinai, he says, 'Le lendemain, je m'avanzai dans la vallée el Cheick, presque entièrement couverte de *tamarix mannifera*.' In proceeding from Suez to Gaza, in an extensive plain of barren sand, he again finds a tamarisk; and further on, 'De là nous arrivâmes à quelques dunes de sable, on je remarquai de très gros Tamarix.' On the borders of Palestine, and the day before reaching Gaza, he says, 'Vers midi, nous nous arrêtâmes dans la vallée Lésare, bordée de dunes de sable mouvant, et remplie de Tamarisc qui ont trois à quatre mètres de circonférence, et de douze à quinze mètres de hauteur:' that is, in the very country in which Beersheba is supposed to have been situated, we have tamarisk trees, now called *asul*, where the *eshel* is described as having been planted.

It is very remarkable that the only tree which is found growing among the ruins of Babylon is a tamarisk. Thus, on the north side of the Kasr, where Ker Porter thought he saw traces of the hanging gardens, there stands upon an artificial eminence a tree to which the Arabs give the name of *athela*. It is a species of tree altogether foreign to the country. Two of the attendants of Ker Porter, who were natives of Bender Bushire, assured him that there are trees of that kind in their country, which attain a very great age, and are called *gaz*. 'The one in question is in appearance like the weeping-willow, but the trunk is hollow through age, and partly shattered. The Arabs venerate it as sacred, in consequence of the Calif Ali having reposed under its shade after the battle of Hillah' (Rosemüller, *Bibl. Geog.* ii. p. 20, from Ker Porter; comp. Ainsworth's *Researches*, p. 125). It may be observed that the present writer has already quoted the two names here given as applied to the tamarisk, in a Persian work on *Materia Medica*, published in India.

From the characteristics of the tamarisk-tree of the East, it certainly appears as likely as any to have been planted in Beersheba by Abraham, because it is one of the few trees which will flourish and grow to a great size even in the arid desert. It has also a name in Arabic, *asul*, very similar to the Hebrew *eshel*. Besides the advantage of affording shade in a hot country, it is also esteemed on account of the excellence of its wood, which is converted into charcoal. It is no less valuable on account of the galls with which its branches are often loaded, and which are nearly as astringent as oak-galls. It is also one of those trees which were esteemed by the ancients, being the *μυρική* of Theophrastus, Dioscorides, &c. 'Hanc enim vaticinaturi manu gestabant, ut Apollo in Lesbo, inde *Myriceus* dictus, &c.' To this they were probably led, as in some other instances, by finding that it was esteemed in those eastern countries, from which much of their information and opinions were, in the first instance, derived. The only difficulty is to ascertain the exact species found in the several situations we have indicated—a difficulty which arises from their similarity to one another, rendering it almost impossible to distinguish them in the state of dried specimens. Ehrenberg, who has most recently investigated the species, gives a *tamarix tetragyna* as a species of Syria,

and *T. orientalis* of Forskal as the species found in Arabia, Persia, and India, and *T. arborea* as a variety of *T. gallia* found near Cairo. But as they are all so similar, any of the arboreous species or varieties which flourish in the most barren situations, would have the name *asul* applied to it, and this name would appear to an Arab of those regions the most appropriate translation for *eshel*, in the passage where Abraham is described as planting a tree, and calling on the name of the Lord, the everlasting God.—J. F. R.

ESSENES (Ἐσσηνοί), one of the three great Jewish sects, of which the other two were the Pharisees and the Sadducees. The derivation of the name Essenes is by no means certain. Philo (*Quod omnis probus liber*, § 12) deduces it from ἅγιος, 'holy.' Some have found its origin in the Chaldee word NDN, 'to heal'; supporting their opinion by reference to the fact that the Essenes were a class of men who professed to heal both mind and body. De Wette gives the preference to the Syriac

ⲙⲟⲩⲁ, signifying 'pious.'

These sects sprung up in the decline of the Jewish state, after the Babylonish captivity, influenced in their rise and spread not less by ascetic philosophy than by the national degradation and the decay of morality. In all states religion comes first, for it is spontaneous, the natural answer of the heart to God. Philosophy is an after-thought, an act and an achievement of the reasoning faculty, which, if it has sometimes purified, has also sophisticated religion.

While the Pharisees gave their countenance to sustain the past, with all its transmitted influences, indiscriminately, and the Sadducees adhered rigidly to the ancient Mosaic institutions, to the rejection of what was traditionary and adventitious, the Essenes attempted to form a third way, which, without neglecting the past, should bring new and powerful appliances to bear on the actual ills of society; seeking not merely to reform and repair, but rather to heal and revive. For this purpose they gave themselves up to a contemplative mode of life, as well as to those labours by which only thought and practice can be united in harmony, and the good which God designed be wrought out for man. Making small account of the outward observances of the Pharisee, and standing religiously aloof from the scepticism and narrow worldly spirit of his opponent the Sadducee, the Essenes aimed at something practical—sought to originate an influence which should stem the advance of corruption, and pour a sanatory and life-giving power into the veins of society. For this purpose they founded a brotherhood, devised institutions, and became the earliest example, if not the actual parent, of all the teeming brood of hermits, monks, friars, and nuns, which have since been seen. They were a moral and religious order, while the Pharisees partook more of the character of a party (in the modern and political sense of the word), and the Sadducees exhibited not a few of the features of a sect.

The Essenes were ascetics. The ordinary pleasures of life they avoided as something morally bad, and held self-control and freedom from the slavery of the passions to be virtue. Marriage they despised. Selecting among the children of others those whom they considered the most pro-

missing, they endeavoured to form them according to their own model. In this conduct they appear to have been influenced not so much by any absolute disapproval of wedded life and its natural fruits, as by fears and cautions, which the immoral character of their age may in some degree have justified. Riches, too, they held in contempt. Whatever they had they were ready to share with others. Superfluity was unknown in a community where all things were held in common. As soon as a new-comer was received among them, he put his property, whatever it was, into the common stock; or, if he had little or nothing, his wants were thence gratuitously supplied. Neither riches nor poverty, therefore, were known in their body. None had less, none more than enough.

Stewards were appointed by them, whose business it was to take due care of what in each case was entrusted to them, not for their own individual advantage, but for the common good.

Dwelling as they did in various cities, they would from time to time have to enter places where, as individuals, they were unknown; but, true to their principle of a community of goods, the brethren in any strange city received and entertained them the same as if they had come to their own property. Scarcely any occasion was there, in consequence, for making provision when they travelled; and they appear to have taken nothing with them except weapons of defence, which they judged the insecurity of the country rendered necessary. In order that travellers might by no possibility suffer want or experience disappointment, there was in every city one of the brethren, who was specially charged to provide them with food, clothing, and other necessities. These duties of hospitality, however, could not have been so onerous then as they would under similar circumstances be now, if what Josephus states is to be taken literally, that the Essenes did not change their shoes or garments till they were worn out and tattered. Buying and selling, as might be expected, were unknown among them: give and take was their simple plan, which appears to have been observed no less between the members of different communities than between those of the same.

The account which Josephus has given of their pious exercises, and of their daily engagements, is no less striking than it is in strict agreement with their ascetic character in general. Rising before the sun, they abstained from all ordinary conversation, and put up their ancestral prayers, not forgetting to beg for a renewal of the light of day. Then, under the supervision of curators or foremen, they proceeded to exercise each one the art in which he was skilled, labouring diligently till eleven o'clock in the forenoon. Then assembling together, and being covered with white veils, they bathed in cold water; after which, entering their refectory with certain religious solemnities, they quietly seated themselves, when there being set before each of them a loaf of bread and a single plate of one sort of food, and a priest having invoked the divine blessing, they proceeded to take refreshment. When the repast was over the same priest made an offering of thanks to the Great Benefactor of the world, and the brethren all returned to their several employments. These being terminated in the evening, another meal with similar observances was partaken by all in common.

These set regulations, and their moderation in eating, produced a regularity and order which appeared something mysterious to the uninitiated; a feeling which was enhanced by the law which, forbidding any one to speak unless in his turn, kept their abodes free from confusion, and sustained a tranquillity which was eminently conducive to the exercise of the head and the heart.

Their entire manner of life, indeed, was subject to the strictest rule. Only in their ministrations of charity were they left free to the spontaneous movements and impulses of their breasts. Lest, however, a species of nepotism should misguide their hand in dispensing mercy, and thus misapply and waste the common resources, they were prohibited from giving succour to any of their kindred who might be in need, unless under the supervision of their overseers.

Next to God, Moses was the object of their reverent homage. To blaspheme the name of Moses was a capital offence. As might be expected, their observance of the Sabbath was more strict than ordinary. Their food they cooked the day before. On the Sabbath they would not remove a vessel from its place, even for the most pressing wants of nature.

If, indeed, all may be believed which Josephus relates touching their opinions, a pious and self-denying life on their part was any thing but unnatural. According to him, they regarded the body as frail and corruptible, but the soul as living for ever. Asceticism was the necessary result of their conviction that souls came out of the most subtle air, from the loftiest empyræum, and are lodged in bodies as in prisons, from which when once set free, they rejoice and soar away to their native regions. After death punishment awaits the bad, blessedness the good; each in their own place. The fear of the one and the hope of the other exerted, they believed, a most salutary influence on the actions of men while yet in this state of being. 'These,' adds Josephus, 'are the divine doctrines of the Essenes about the soul, which lay an unavoidable bait for such as have once had a taste of their philosophy.'

They even made pretensions to the gift of prophecy, drawing their light from reading the sacred books, especially from the study of the prophetic writings, and from the careful and diligent use of purifications. Dean Aldrich enumerates three successful efforts of this kind, as narrated by Josephus (note to Whiston's *Transl. Jew. War.* ii. 12), who himself asserts 'it is but seldom that they miss in their predictions.' It would have been surprising if, aided by their scholars, no less than by 'the chapter of accidents,' they had not sometimes proved true prophets, especially if they were accustomed to do as did one of them, who, thinking he had failed in prophesying the death of one Antigonus, thus complained to a numerous band of pupils, who were not likely to be deaf to their teacher's wishes:—'O strange! it is good for me to die now, since truth is dead before me, and somewhat that I have foretold hath proved false; for this Antigonus is this day alive, who ought to have died this day; and the place where he ought to be slain was Strato's tower, which is at the distance of six hundred furlongs from where we are.' News, however, in time arrived, which relieved the master's dejection, and esta-

lished the prophet's—shall we say veracity, or influence? Antigonus was dead (Joseph. *De Bell. Jud.* i. 3. 5).

Their pursuits, trades, and professions were such as conduce to human good. They tilled the ground; they made useful articles; they bred and pastured cattle: but in the fabrication of arms they took no part. Even peaceful pursuits which ministered to vice they carefully avoided. It must not be concealed, however, that some of their notions bordered on extravagance, and that some of their practices betrayed a fastidiousness which amounts to the ridiculous.

In morals they seem to have attained no ordinary excellence. Over anger they kept a guard like just stewards. All the passions they knew how to restrain. They were eminent for fidelity, and ministers of peace. Their word was more to be trusted than some men's oaths. Swearing indeed they studiously avoided, alleging, with no small reason, that the man is already condemned who cannot be believed without an oath.

The great aim of their inquiries, whether they searched the books of the ancients or studied the virtues of plants, was to gather such lessons of wisdom as might render them able to administer, like skilful physicians, to the maladies both of the mind and the body.

Persons who are convicted of heinous crimes are expelled from their society. Of those thus excommunicated, some perish miserably; others are received back only when they have undergone the severest punishment which want and wretchedness can inflict; for, being still under the vows and regulations of their order, they are prohibited from all food but such as the niggard products of spontaneous vegetation may supply.

Admission into their communities was not easy. A novitiate of twelve months was imposed, in order that it might be ascertained how far the candidate was able to endure the rigours of the system. At the expiration of the year those who are approved are habited in white, and receive a girdle and a sort of small hatchet, being made 'partakers of the waters of purification,' that is, probably, baptised. A further probation of two years must be undergone. If the novice is then found worthy he is admitted into the society. Certain vows,* however, are first to be taken—a

* If the long passage in Josephus respecting the Essenes is now as it was when it left the historian's hand, there seems on the face of it a marked contradiction in what he says about oath-taking—making them in one instance eschew oaths altogether, and in another take oaths of the most solemn nature and widest application. The rendering which we have given in the text, 'vow,' seems justified by the nature of the communities which they formed—a sort of monastic life; and by usages which, at least at a later date, we know to have been connected with such institutions. The rendering, however, is not unaccompanied with difficulties.

Stüdtlin (*Sittenlehre Jesu*, i. 460), referring to the fact that it was only the novices from whom this vow or oath was exacted, supposes that it was truly an oath which they took (Josephus terms it 'fearful oaths,' ὑρκους ὑμνοῖσι φρικώδεις); and that this was the last oath they swore—sworn as candidates, not as Essenes, for that those who

proceeding which seems scarcely compatible with what the same authority tells us regarding the aversion of the Essenes to oaths. These vows or oaths bind the neophyte to exercise piety towards God and justice towards men; to hate the bad and assist the good; to harm no one, either of his own accord or by the command of others; to be faithful to all men, especially to such as are in authority; to love truth and reprove the liar; to keep his hands clean from theft, and his soul pure from unlawful gain; to conceal nothing from the brotherhood, and reveal to others none of their secrets, not even should life thereby be put in peril; to transmit the Essene doctrines unchanged to others; to preserve their books and the names of their officers (ἀγγέλων, angels) in strict secrecy.

When the time of their preparatory trial is come to an end, the newly-admitted brethren are distributed among four classes. Still a distinction is observed. If all are now Essenes, some are younger than others; and the distinction of age is so rigidly observed that, if a senior do but touch a junior brother, the first must undergo a purification by water, as much as if he had been in contact with a foreigner.

All events, the destiny of man not less than other things, the Essenes referred to the ordinations of the Divine will, without, nevertheless, attempting to deny human freedom. It is not with philosophical precision that they spoke on the subject, but with a view to pious edification they taught that everything depended on a certain Fate, which was lord of all, without which nothing happens to man.

They did not offer oblations in the Temple at Jerusalem, though they sometimes sent presents thither. A pure heart they held to be the best offering. Religious ablations they considered acts of holiness.

They had no slaves; all were free, serving one another. They repudiated lordship as unjust, as destructive of natural equality, as irreligious, as opposed to the laws of nature. Nature they held to be the common mother and instructress of all; and with them all men were brethren, not in name, but in reality.

Thus, while they were careful to preserve a practical subordination in their communities, without which social existence is an impossibility, those who were highest amongst them held office merely for the common good, and in themselves were neither richer nor better clad than others, nor had they any political power.

They did not admit logic among their studies, since, in their opinion, it does nothing for the furtherance of virtue. Metaphysics they avoided, as relating to subjects which are too high for man; yet they made an exception in favour of those branches which refer to the existence of God and the creation of the world. Morality—the morality which they by their own process learnt from Moses—was the chief object of their studious care.

Pliny (*Hist. Nat.* v. 17) seems to have been much struck with the Essenes. 'They dwell,' he

were really Essenes swore not at all. There seems, however, no little inconsistency in requiring of the scholar that which the master condemned and shunned.

says, 'along the Dead Sea, avoiding such proximity to its waters as would be hurtful. They are a solitary people, and more wonderful than any other, as they are without females, emancipated from sexual intercourse, having no money, dwellers amid palm-groves. Their community is daily renewed by new comers—persons who are weary of life, and who flee to their retreats from its stormy waves. Thus a people among whom a birth is never known remains (incredible as it may appear) unimpaired through successive ages: so prolific to them is the weariness of life which is felt by others.'

Philo (*Quod omnis probus liber*, § 12) agrees with Pliny in representing them as fleeing from the ordinary dwellings of men, and living together in villages or establishments specially erected by and for themselves.

The same writer speaks, in terms similar to those employed by Josephus, of their religious views and spirit. They did not sacrifice animals. They were very observant of institutions and practices received from their fathers, which, especially on the seventh day, they taught to their disciples, who appear to have been very numerous (*Joseph. De Bell. Jud.* i. 3. 5). The seventh was with them a sacred day, on which they abstained from all kind of labour, frequented the sacred places, called synagogues, where the young sat arranged in classes according to age under the eye of their elders. Here one took and read, and another expounded, the sacred books. A system of allegorical interpretation prevailed. Among their instructions the virtues of holiness, justice, and economy held a prominent place; nor did they omit the duties which men owe to the state. Their teachings were accompanied by definitions and rules, and were enforced by a regard to the love of virtue, the love of man, and the love of God. Of their love of God they gave very many proofs; among which Philo reckons their lifelong chastity, their abstaining from oaths, their abhorrence of lying, their referring to God all the good and none of the evil found in the world. Their love of virtue they proved by their contempt of wealth, honour, and pleasure, their self-government, their patience, fortitude, the fewness of their wants, their simple manner of life, their modesty, their respect for the law; while in their benevolence, their practical equality, their doing good to all irrespectively, and their community of goods, they gave distinguished exemplifications of their love of man. Every Essene was for every other a brother, and nothing more. Their humanity was specially manifested towards the sick and the aged. The first were attended in the most careful and loving manner. Never was old age more honoured, or in a more felicitous condition, than among the Essenes. Every one strove to render to the old services of all kinds, and they found themselves as if in the midst of numerous tender-hearted children. Among all the bitter, open and secret persecutors and foes of the Jewish people, no one (so says Philo) had convicted, or even impeached, an Essene of any crime. The virtue of these men cannot be denied; all writers show them respect as free-born men, who were a law to themselves, distinguishing with special praise their brotherhood and their community of goods. Even royalty has expressed its admiration of their institutions, and

held it an honour to show towards them marks of its high esteem.

Some minor observations and regulations may be mentioned. The Essenes had a peculiar liking for white garments, not improbably because an emblem of that purity of life to the practice of which they were devoted.

The will of the majority was law. 'Accordingly,' says Josephus, 'if ten of them be sitting together, no one of them will speak while the other nine are against it. They also avoid spitting in the midst of them, or on the right side.'

In their criminal procedures they were no less just than accurate. No sentence could be passed unless at least a hundred voices concurred; but the resolves of that number were unalterable.

Their manner of life was eminently conducive to health and longevity. Many of them lived above a hundred years.

Pain they disregarded; the miseries of life they held of small account; and they even preferred death to living always.

The calm and unmoved firmness with which they endured at the hands of the Romans, during 'the Jewish war,' the cruellest tortures, and death itself, rather than be faithless to their convictions or forswear their order, serves to show that the ascetic spirit and the martyr-spirit have no little in common, and exhibits within the limits of Palestine the very same results, from the very same discipline, as Sparta was proud to call her own.

With their ascetic notions it was natural they should disregard the body, and the usual care which, especially among the ancients, was taken of it. Accordingly they considered oil a defilement, and if any one was anointed contrary to his will the body was carefully cleansed.

Josephus, in continuation of his account, makes report of another kind of Essenes, who do not appear to have essentially differed from those whom we have already described. The chief point of diversity was in regard to marriage. This second kind entertained less unfavourable opinions of female virtue and honour than did the first, and, holding that marriage was a divine ordinance for the propagation of the human species, they did not think themselves justified in condemning or avoiding it. At the same time, with a suspicion which was akin to the avoidance of their brother Essenes, they used the best precautions in their power, and specially gave those females whom they thought of marrying a trial for three years, at the expiration of which they actually married them, provided they were satisfied. Marriage, however, they considered merely as a duty, and accordingly did not neglect the same ascetic principles which characterize the whole of the Essene life.

In the account which has now been given we have followed in the main the authority of Josephus and Philo. The latter speaks of a species of Essenes under the name of Therapeutæ, whom we shall describe when we come to that word, when we shall subjoin some general reflections on the subject, contenting ourselves at present with remarking that, generally excellent as were the institutions and practices of the Essenes in their peculiar circumstances, yet a good deal of the warm colouring of the picture, if not some of its objects, may have been borrowed from the ima-

gination of the artists by whom it was originally drawn. Besides Josephus and Philo the reader may consult Ständlin, *Sittenlehre Jesu*, Götting, 1799; De Wette, *Sittenlehre*, Berlin, 1833; De Wette, *Archäologie*, Leipzig, 1830.—J. R. B.

ESTHER (אֶסְתֵּר; Sept. Ἐσθήρ), a damsel of the tribe of Benjamin, born during the Exile, and whose family did not avail itself of the permission to return to Palestine, under the edict of Cyrus. Her parents being dead, Esther was brought up by her uncle Mordecai. The reigning king of Persia, Ahasuerus, having divorced his queen, Vasthi, on account of the becoming spirit with which she refused to submit to the indignity which a compliance with his drunken commands involved, search was made throughout the empire for the most beautiful maiden to be her successor. Those whom the officers of the harem deemed the most beautiful were removed thither, the eventual choice among them remaining with the king himself. That choice fell on Esther, who found favour in the eyes of Ahasuerus, and was advanced to a station, enviable only by comparison with that of the less favoured inmates of the royal harem. Her Jewish origin was at the time unknown; and hence, when she avowed it to the king, she seemed to be included in the doom of extirpation which a royal edict had pronounced against all the Jews in the empire. This circumstance enabled her to turn the royal indignation upon Haman, the chief minister of the king, whose resentment against Mordecai had led him to obtain from the king this monstrous edict. The laws of the empire would not allow the king to recall a decree once uttered; but the Jews were authorized to stand on their defence; and this, with the known change in the intentions of the court, averted the worst consequences of the decree. The Jews established a yearly feast in memory of this deliverance, which is observed among them to this day [PURIM]. Such is the substance of the history of Esther, as related in the book which bears her name. The details as given in that book afford a most curious picture of the usages of the ancient Persian court; and the accuracy of which is vouched not only by the historical authority of the book itself, but by its agreement with the intimations afforded by the ancient writers, as well as by the fact that the same usages are in substance preserved in the Persian court at the present day.

The objections which have been advanced against the book of Esther on the ground of the follies, wickedness, and cruelties narrated in it, have been ably refuted by Jahn and other critics, who have shown that these things are not recorded with approbation, but simply as facts of history, illustrative of the operations of the providence of God, with a view to effect the deliverance of his people (Henderson, *On Inspiration*, p. 48). With reference to the somewhat sanguinary character of Esther and Mordecai, Jahn remarks that no difficulty arises from thence, seeing that they are not represented as saints, but as deliverers of their nation.

It should be observed that Esther is the name which the damsel received upon her introduction into the royal harem, her Hebrew name having been HADASSAH (הַדַּסָּה, *myrtle*, Esth. ii. 7). Esther is most probably a Persian word. Gesenius cites from that diffuse Targum on this book which

is known as the second Targum on Esther, the following words: 'She was called Esther from the name of the star Venus, which in Greek is *Aster*.' Gesenius then points to the Persian word *Satārah*, star, as that of which Esther is the Syro-Arabian modification; and brings it, as to signification, into connection with the planet Venus, as a star of good fortune, and with the name of the Syrian goddess Ashtōreth, according to the etymology of the word, already referred to in that article.

The difficulties of the history of the book of Esther, especially as regards the identity of the king, have been examined under AHASUERUS, and are also noticed in the following article.

ESTHER, BOOK OF. one of the eleven books styled *Ketubim* [HAGIOGRAPHIA], and of the five *Megilloth* [CANTICLES]. It is called by the Jews *Megillah Esther*, and sometimes simply *Megillah*, as it forms by itself a distinct roll. In the Christian Church it has been also called *Ahasuerus*, which name it bears in some copies and printed editions of the Vulgate. In the Hebrew it is placed with the other *Megilloth*, after the Pentateuch, between the books of Joshua and Ecclesiastes, and sometimes among the *Hagiographa*, between Ecclesiastes and Daniel. In the Vulgate, Tobit and Judith are placed between Nehemiah and Esther. Luther placed it immediately after Nehemiah, so as to make it the last among the historical books, although the book of Nehemiah was supposed to refer to a later history. His design in this arrangement was to prevent the books of Nehemiah and Ezra from being disunited. It has continued to retain this position in the Reformed versions.

The Jews hold this book in veneration next to the books of Moses (see Carpov's and Eichhorn's *Introductions*), and there appears to be no authentic foundation for the statement of Richard Baxter (*Saints' Rest*, part iv.), that the book of Esther was treated so ignominiously by the Jews that they were in the habit of throwing it on the ground before reading it.

Subject of Esther.—As the subject of this book has been treated of under the article AHASUERUS, it will be sufficient to refer to that head; only we may here observe that the book of Esther has this peculiarity among the historical books, that although the author, a Persian Jew, records a remarkable preservation from destruction of that portion of his countrymen which remained in Persia after the exile, he does not refer their deliverance to the act of God, whose name is not even once mentioned. This has been explained by supposing that the author wished to avoid giving offence to the Persians, or that the whole was taken from the Persian annals, which are appealed to, ch. x. 2. (See Pareau's *Principles of Interpretation*, and Hottinger's *Thes. Phil.* p. 488.)

The historical and other difficulties of this book have been the subject of much controversy and embarrassment. Not the least of these has been the solution of the question—What king of Persia is meant by Ahasuerus? For there has been no Persian monarch from Astyages, who died B.C. 603, and his son Cyaxares, to Darius Ochus, who died B.C. 358, or his son, who died twenty years later, who has not been maintained to be the husband of Esther. Those who have

most suffrages are Darius Hystaspis, Xerxes, and Artaxerxes Longimanus; for which last monarch we have the authority of Josephus and of the Septuagint Version, wherein he is called by the name of Artaxerxes [ΑΧΑΣΕΡΞΕΣ]. Jahn (*Introduction*) falls in with the view of Scaliger, who supposes that Amestris, the cruel and vindictive wife of Xerxes, is no other than Esther, as both the name and the character of Amestris favour the supposition that she is the Esther of the Bible. But she is said by Herodotus to have been the daughter of Otanes, a Persian, and to have been married to Xerxes before his Grecian expedition. Bellarmine, who adopts the view of Josephus, is not affected by the circumstance that, in this case, Mordecai's age must have exceeded 165 years, as he himself had known 'a hale old man of 105, who was likely to live still many years.'

The difficulties and apparent improbabilities in the narrative have had the effect of inducing some of the learned to consider the book of Esther a fiction, of which opinion is De Wette (*Lehrbuch*), who conceives that this book betokens the utter destruction of Hebrew historical writing, and that its only historical basis is the feast of Purim; which, however, he allows to have been 'occasioned by an event similar to that related in Esther.' Eichhorn, who is admitted by De Wette to have solved most of the individual objections against the credibility of the narrative, maintains that the circumstance alone of a national festival having been founded in commemoration of the events described in the book of Esther, and which had been already of long standing in the time of Judas Maccabæus (2 Macc. xv. 36), is a sufficient voucher for the correctness of the principal event in the history, and that it would be absurd to suppose that a national festival was founded on a mere fable. Pareau, who agrees with Eichhorn in supposing Xerxes to be the husband of Esther, and conceives that the principal difficulties are removed by this supposition, describes the author as accurate to minuteness, and equal to any history, as having acquired his skill among the more cultivated Persians. De Wette, also, while he describes the book as 'breathing the spirit of revenge and haughtiness,' observes that it is simple in its style, free from declamation, and thus advantageously distinguished from the similar stories in the apocrypha (*Introduction*, Parker's translation, Boston, 1843).

Author and Age of Esther.—This is a question involved in much difficulty. Of the author nothing is known, nor have we any data on which to form a reasonable conjecture. Augustine (*De Civitate Dei*) ascribes the book to Ezra. Eusebius (*Chronic.* xlvi. d. 4), who observes that the facts of the history are posterior to the time of Ezra, ascribes it to some later but unknown author. Clemens Alexandrinus (*Stromata*, lib. i. p. 329) assigns it, and the book of Maccabees, to Mordecai. The pseudo-Philo (*Chronographia*) and Rabbi Azarias maintain that it was written at the desire of Mordecai by Jehoiaikim, son of Joshua, who was high-priest in the 12th year of the reign of Artaxerxes. The subscription to the Alexandrian version states that the epistle regarding the feast of Purim was brought by Dositheus into Egypt, under Ptolemy and Cleopatra (b.c. cir. 160); but it is well known that these subscriptions are of little authority. The

authors of the Talmud say that it was written by the members of the Great Synagogue, who also wrote Ezekiel and the twelve Prophets. But the whole account of the Great Synagogue, said to have been instituted by Ezra, and concluded by Simon the Just, who is said to have closed the canon, and whose death took place b.c. 292, is by most looked upon as a rabbinical romance [ESDRAS]. De Wette (*loc. cit.*) assigns it to the age of the Ptolemies and Seleucidae, whose era commenced b.c. 312, while Jahn maintains that it must have been written soon after the facts which it records, and before the destruction of the Persian monarchy (b.c. 330), to whose annals it appeals.

Canonicity of Esther.—Some doubts have been thrown on the canonical authority of this book from the fact that it is never referred to in the New Testament, that it is not cited by Philo, and that it is omitted in several of the ancient catalogues, some of which expressly exclude it from the canon. As to the New Testament, there are several other books whose canonicity is unquestioned which are never once referred to therein, viz. the books of Ruth, Ezra, Nehemiah, Canticles, Lamentations, and Ezekiel; and the same may be said of Philo, who, although he mentions or refers to all the other books of the Jewish Canon, makes no reference to Ruth, Chronicles, Nehemiah, Esther, Lamentations, Daniel, Ecclesiastes, and Canticles. Carpzov (*Introduction*) maintains that it is referred to in Matt. i. 11. Its omission by Melito (A.D. 170) [DEUTERO-CANONICAL] has been accounted for by supposing that he included it, as well as the book of Nehemiah, under the name of Ezra, and there are, in fact, some manuscripts of the Vulgate extant, in which Esther is called the sixth book of Ezra (Whiston's *Josephus*, b. xi. ch. 6, note.) The other ancient writers who are said to have omitted or excluded Esther from the canon are Amphilochius, Leontius, Nicephorus, Junilius, Gregory Nazianzen, and Athanasius. The first of these (*Iamblicus*), after giving the names of the other books of the Hebrew canon, observes, 'to these some add Esther.' Junilius, A.D. 560 (*De Partibus Div. Leg.*), who divides the books of Scripture into books of perfect, of middle, and of no authority, omits the book of Esther from those of perfect authority; Nicephorus reckons among the *antilegomena* of the Old Testament, three books of Maccabees, Wisdom, Jesus Sirach, the Psalms, the Hymns of Solomon, *Esther*, Judith, Susannah, and Tobit.

There are two works attributed to Athanasius, in both of which the book of Esther is excluded from the canon, the *Festal Epistle*, and the *Synopsis Scripturæ*. The genuineness of the former of these is generally but not universally acknowledged, and as to the *Synopsis Scripturæ*, although it has been by many, including the learned Montfaucon, considered to be a genuine work of St. Athanasius, it is now generally given up as pseud-epigraphal, and is supposed to be about a century posterior to the time of Athanasius, although Whiston conceived its author to have been contemporary with Origen. It is, however, held in great veneration in the Greek Church, and holds the same place in the authorized Bibles of that communion which Jerome's prefaces do in the Latin Vulgate. The canon of the Greek Church

seems to be chiefly founded on the authority of this *Synopsis*, although it does not name the three books of Maccabees, the Psalms, nor the twelve prophets: which are all nevertheless contained in the authorized Greek Bibles. The canon of the Greeks is in effect the same with the Septuagint version, with the addition of the fourth book of Esdras, which they have translated from the Latin [ESDRAS]. There is indeed no distinction made in the modern Greek Bibles between canonical and apocryphal books; but that such distinction actually exists among them is evident from their authorized books of theology. Thus in the *Dogmatic Theology*, published by authority of the Theological Academy of Moscow in 1839, after giving the catalogue of the books of Holy Scripture,—thirteen historical, five pragmatial, and 15 prophetic,—it is added, ‘All these books are called *canonical*, from the word *κανών*, because they contain the immutable rule of faith and practice. The *apocryphal* books are so called from the word *ἀποκρυφτα*, inasmuch as their origin is lost in uncertainty. These books were written after the prophetic age, during the last four centuries before Jesus Christ, after the completion of the canon; and on this account, as they formed no part of the collection of sacred writings, they were neither preserved in the Temple, nor read in the synagogues, but in the course of time they were added to the other books as worthy of respect from the nature of their subject and the rich store of edification which they contained. They are as follows:—Tobit; Judith; certain passages of the book of Esther, which are not distinguished in the Greek manuscripts nor in the Slavonic Bibles; Wisdom; Jesus Sirach; the prophet Barnab; the Epistle of Jeremiah, added to Lamentations; the Prayer of Manasses; the Song of the Three Children (Dan. iii.); Susanna (xiii.); Bel and the Dragon (xiv.); 2 [3] Esdras; 3 [4] Esdras; 1st, 2nd, and 3rd Maccabees.’ The reader will observe that, notwithstanding the authority of the *Synopsis*, the book of Esther is here reckoned among the canonical books.

It has been questioned whether Josephus considered the book of Esther as written before or after the close of the canon. Du Pin maintains that, as Josephus asserts [see DEUTERO-CANONICAL] that the sacred books were all written between the time of Moses and the reign (*ἀρχῆς*) of Artaxerxes, and (*Antiq.* xi.) places the history of Esther in that reign, he consequently includes it among those books which he says were of inferior authority, as written under and since the reign of that prince (*Complete Hist. of the Canon*, p. 6). Eichhorn, on the other hand, favours the opinion that Josephus meant to include the reign of that prince within the prophetic period; and concludes that this historian considered the book of Esther as the latest of the canonical writings. All other ancient writers and catalogues include Esther among the books of the Jewish canon. Jerome expressly names it as the ninth book of the *Hagiographia* (*Prologus Galeatus*). It has, however, been classed by Sixtus of Sienna, Bellarmine, and others of the Roman church, in the second order of sacred books, or as *deutero-canonical*; that is, according to these writers, among those prophetic and apostolical books whose authority has not been always equally certain, in opposition to those of the first class,

respecting whose authority there has never been any dispute among catholics’ (Sixtus Senensis, *Bibl. Sanct.*; Bellarmine, *De Verbo Dei*, ch. iv.). These writers define the *third* class to consist of such books as, although sometimes received by the learned as divine and canonical, were not approved by the public judgment of the whole church. In the second order the same writers place not only the deuterocanonical books of the Old Testament, including that of Esther, but also the Antilegomena of the New, including the last chapter of St. Mark’s Gospel, the narrative of Christ’s bloody sweat, and his consolation by the angel in St. Luke (xxii. 43, 44), and the history of the adulteress (John viii.). Eichhorn considers as conclusive of Esther’s having formed part of the Jewish canon, the fact of its having been translated by the Seventy, under the reign of Ptolemy Philometor, about the middle of the second century before Christ, before the time usually assigned to the translation of the prophets. For this date we have the authority of the subscription to the Septuagint Version.

Luther has been accused of attacking the canonicity of Esther, and the following passages have been adduced from his writings, and his *Table Talk*, in proof of this assertion:—‘The book of Esther I toss into the Elbe.’ ‘I am so an enemy to the book of Esther, that I would it did not exist; for it Judaizes too much, and hath in it a great deal of heathenish naughtiness’ (see *Edinburgh Review*, No. cxi. p. 228). And in his work, *De Serv. Arbit.*, addressed to Erasmus, after saying, ‘in regard to *Ecclesiasticus*, although I might justly refuse it, yet I receive it, in order not to lose time in involving myself in a dispute concerning the books received into the canon of the Hebrews,’ he adds, ‘which canon you do not a little reproach, when you compare the Proverbs and the Love-Song (as you sneeringly call it) with the two books of Esdras, and Judith, Susanna, the Dragon, and the book of Esther; but though they have this last in their canon, it is in my judgment more worthy than all of being excluded from the canon (*quamvis hunc habeant in canone, dignior omnibus, me judic, qui extra canonem habeatur*).’ Sebastian Smith, however, vindicates Luther by observing that he only speaks of Esther comparatively with the books of Solomon; and Carpov thinks that Luther refers to the book of Esther as it is extant in the Septuagint, with its spurious additions. (See also Müller, *Defens. Lutheri*, p. 631.) However this may be, it is certain that Sixtus of Sienna, one of the most learned Roman Catholic theologians, maintained the same views regarding the effect of these additions [ESTHER, APOCRYPHAL ADDITIONS TO], saying that, in the time of Gregory and the other ancient fathers who doubted of the canonicity of Esther, ‘its authority was rendered suspected by the apocryphal additions which had been rashly inserted into this book; so that although written in Hebrew, and received by the Hebrews, its reception in the Christian church was very late: and it was rejected as spurious by Athanasius,’ that is, by the author of the *Festal Epistle*, and of the *Synopsis*. In the former it is said that ‘there are other books not in the canon, which our fathers commanded to be read for instruction in piety by catechumens,

as Wisdom, Sirach, *Esther*, Judith, Tobit, the Doctrine of the Apostles, and the Shepherd; and it is stated in the *Synopsis*, that there are some controverted books, as Wisdom—some apocryphal, as Enoch; and of *Esther* it is observed, that 'some of the ancients have said that it was received by the Hebrews.' We have not dwelt on the circumstance of the book of *Esther*'s being included in the 59th canon of the Council of Laodicea, as there exist strong suspicions that this canon was interpolated into the acts of that council in the twelfth century. Vicenzi (*Introd. in Script. Deuterocan.*, p. 195) supposes that it may have been inserted from the catalogue in the 85th of the pretended apostolical canons, with which, however, it is far from being identical. It is observed by Du Pin (*On the Canon*) that the genuineness of these canons was first called in question by Erasmus. But whatever doubts may have existed among some of the Christian fathers as to the authenticity of *Esther*, it does not appear that it was ever doubted by the Jews, or by the Christian Church in its collective capacity.—W. W.

ESTHER (APOCRYPHAL ADDITIONS TO). In the version of the Seventy the book of *Esther*, besides other variations, is enriched with several detached fragments which are not found in the Hebrew. These were also contained in the old Latin, which was translated from the Greek, and were retained in his own version by Jerome, who removed them to the end of the book, in which position they are still found in all manuscripts and printed editions of the Vulgate, forming the seven last chapters according to Cardinal Hugo's division. Luther proceeded still further, and removed them to a separate place among the *Apocrypha*. They are as follows:—

1. The Greek version commences with what forms the 11th chapter in the Vulgate, 'In the fourth year of the reign of Ptolemy and Cleopatra,' describing Mordecai's dream of the two dragons, and the conspiracy of the two eunuchs (Vulg. xii.).

2. The king's letter for the destruction of the Jews (Vulg. xiii.) follows in the Greek the 13th verse of chap. iii. to ver. 14.

3. The Prayer of *Esther* (Vulg. xiv.). Sept. iv. commencing after the 17th verse in the Vulgate.

4. A detailed and embellished description of *Esther*'s visit to the king (Vulg. xv.). Sept. v. to ver. 3.

5. The king's letter in favour of the Jews (Vulg. xvi.). Sept. viii. after 13th verse.

6. The whole concludes in the Sept. with Mordecai's recollection of his dream of the great and little fountain and the two dragons (Vulg. i.), after which is the subscription, purporting that the letter concerning the feast of Purim was brought into Egypt by Dositheus, and translated by Lysimachus in the fourth year of the reign of Ptolemy and Cleopatra (n. c. 165).

Jerome (*Preface to Esther*) compares these additions to the themes of schoolboys. Sixtus of Sienna (*Bib. Sanct.* 1560) observes that these are the work of some unknown Greek author (Jahn adds 'of more than one'), and that the same are found word for word in the 11th chap. of the *Antiquities* of Josephus. The Chaldee version of them (from the Greek), as well as the Samaritan and Arabic, are still extant. Sixtus of Sienna rejects them as apocryphal, notwithstanding the decree of the council of Trent, wherein it was de-

clared that, 'He is to be anathema who does not receive these entire books, *with all their parts*, as they have been accustomed to be read in the Catholic church, and are found in the ancient editions of the Latin Vulgate, as sacred and canonical, and who knowingly and wilfully despises the aforesaid traditions. . . . All may, therefore, understand, after the clearing up of this foundation of the Confession of Faith, in what order and method the Synod is to proceed, and what evidences and guarantees it furnishes in the confirmation of doctrines and the reformation of manners in the church.' 'Sixtus maintains that this decree includes only the genuine parts of books, but not the additions and interpolations of unknown writers, which are rejected from the canon not only by Hugo, de Lyra, and others, but utterly repelled by Jerome and exploded by Origen in his letter to Africanus.' Origen, however, only asserts that they were wanting in the Hebrew, from which he supposes they had been lost (an opinion also held by Whiston), and Bellarmine maintains, in opposition to Sixtus, that the phrase *all their parts* in the decree of the council of Trent can only refer to the portions which were hereby declared to be canonical. This is also maintained by Du Pin (*Canon of Scripture*), but denied by Jahn (*Introduction*), who further observes that they contradict the canonical *Esther*. It would appear to be the sentiment of these divines (who denominate the deuterocanonical portions by the title of the Church-Canon) that these books were not obligatory on Christians for the first fifteen centuries, or before the fourth session of the council of Trent. Bellarmine further observes that these additions to *Esther* are not only contained in the editions of the Vulgate, but that a portion of them is read in the offices of the church; viz., part of the 13th chap. on the Thursday after the second Sunday in Lent, in the mass against the Pagans, and *Esther*'s prayer (ch. xiv.) on the third Sunday after Trinity. De Wette conceives, from the religious tone of these additions, that they are of Hellenistic and Alexandrian origin. [ESDRAS.]—W. W.

ETAM (עֵתָם; Sept. Αἰράμ), a town in the tribe of Judah, which was decorated by Solomon with gardens and streams of water, and fortified by Rehoboam along with Bethlehem and Tekoa (1 Chron. iv. 3, 32; 2 Chron. xi. 6; Joseph. *Antiq.* viii. 7 3). From this place, according to the Rabbins, water was carried by an aqueduct to Jerusalem. Josephus places it at fifty stadia (in some copies sixty) from Jerusalem (southward); and alleges that Solomon was in the habit of taking a morning drive to this favoured spot in his chariot. Dr. Robinson (*Researches*, i. 168) inclines to find Etam at a place about a mile and a half south of Bethlehem, where there is a ruined village called Urtas, at the bottom of a pleasant valley of the same name. Here there are traces of ancient ruins, and also a fountain, sending forth a copious supply of fine water, which forms a beautiful purling rill along the bottom of the valley. It is usually supposed that 'the rock Etam,' to which Samson withdrew (Judg. xv. 8, 11), was near the town of the same name. Urtas seems too far inland for this; there is, however, a little to the east, the Frank mountain, which (this consideration apart) would have furnished

just such a retreat as the hero seems to have found.

ETHAM, the third station of the Israelites when they quitted Egypt [Exodus].

1. ETHAN (עֲתָנָן; Sept. Αἰθάμ), one of four persons ('Ethan the Ezrahite, and Heman, and Chalcol, and Darda, the sons of Mahol') who were so renowned for their sagacity that it is mentioned to the honour of Solomon that his wisdom excelled theirs. In 1 Kings iv. 31, Ethan is distinguished as 'the Ezrahite,' from the others, who are called 'sons of Mahol'—unless, indeed, this word *Mahol* be taken not as a proper name, but appellatively, for 'sons of music, dancing, &c.,' in which case it would apply to Ethan as well as to the others. This interpretation is strengthened by our finding the other names associated with that of Ethan in 1 Chron. ii. 6, as 'sons of Zerah,' i. e. of Ezra, the same as Ezrahites. The evidence of identity afforded by this collocation of names is too strong to be resisted; and we must therefore conclude that Ethan and the others, the tradition of whose wisdom had descended to the time of Solomon, are the same who, in 1 Chron. ii. 6, appear as sons of Zerah, who was himself the son of the patriarch Judah. With this agrees the Jewish chronology, which counts them as prophets during the sojourn in Egypt (*Seder Olam Rabba*, p. 52), although the Jews have also a tradition confounding Ethan with Abraham, Heman with Moses, and Chalcol with Joseph. (Jerome, *Comment. on 2 Kings* iv. 31.)

2. ETHAN, a Levite, the son of Kishi, and one of the masters of the Temple music (1 Chron. vi. 41; xv. 17), to whom the 89th Psalm is ascribed, and whom some interpreters suppose to be the Ethan of 1 Kings iv. 31, to whose wisdom that of Solomon is compared.

ETHANIM. [TISHRI.]

ETHIOPIA (Αἰθιοπία, Judith i. 10) is the name by which the English and most other versions render the Hebrew *CUSH*. As used among the Greeks and Romans, the word was employed in all the latitude of its etymological meaning, to denote any of the countries where the people are of a sable, sun-burnt complexion—Αἰθίοψ (Acts viii. 27), Αἰθίοπισσα (Num. xii. 1), Αἰθίοπες (2 Chron. xiv. 12), from αἰθρομαι, to burn, and ὤψ, the face. But we have shown in the article *CUSH* (to which we refer the reader) that its use in the language of Scripture is much more restricted, and that while it may sometimes include part of Southern Arabia, it for the most part exclusively designates the 'Ethiopia of Africa,' which is the subject of the present article. 'Of the four sons of Ham,' says Josephus (*Antiq.* i. 6, 2), 'time has not at all hurt the name of Chus; for the Ethiopians over whom he reigned are even at this day, both by themselves and by all men in Asia, called *Chusites*.' The Peschiro Syriac Version of Acts viii. 27 styles both Queen Candace and her treasurer *Cushæans*.

By Ethiopia, or African Chus, in the widest acceptance of the name, the Hebrews understood the whole of the region lying south of Egypt above Syene,* the modern Assouan (Ezek. xxix.

10; xxx. 6; comp. Strabo, xviii. p. 817; Pliny, *Hist. Nat.* v. 9; vi. 35; Joseph. *De Bell. Jud.* iv. 10, 5). Its limits on the west and south were undefined; but they probably regarded it as extending eastward as far as the Red Sea, if not as including some of the islands in that sea, such as the famous Topaz Isle (Job xxviii. 19; Pliny, *Hist. Nat.* vi. 29; xxxvii. 8; Strabo, xvi. 4, 6; Diod. Sic. iii. 39). It thus corresponded, though only in a vague and general sense, to the countries known to us as Nubia and Abyssinia, so famous for the Nile and other great rivers. Hence the allusions in Scripture (Isa. xviii. 1; Zeph. iii. 11) to the far distant 'rivers of Ethiopia,' a country which is also spoken of (Isa. xviii. 2) in our version as the land 'which the rivers have spoiled,' there being a supposed reference to the ravages committed by inundations (Bruce's *Travels*, iii. p. 158, and Taylor's *Cabnet*, iii. pp. 593-4); but recent translators prefer to render נַיִב by 'divide,' q. d. 'a land intersected by streams.' Isaiah likewise takes

notice of the נַיִב נַיִב, or vessels of papyrus, which the Ethiopians employed upon the waters, a fact which is confirmed by Heliodorus in his *Ethiopia* (x. p. 460), and also by Bruce, who states that the only kind of boat in Abyssinia is that called *Tancoa*, which is made of reeds, 'a piece of the Acacia tree being put in the bottom to serve as a keel, to which the plants are joined, being first sewed together, then gathered up at stem and stern, and the ends of the plants tied fast there.' It is to the swiftness of these papyrus vessels that Job (ix. 26) compares the rapid speed of his days.

But that part of the vast region of Cush which seems chiefly intended in these and most other passages of Scripture is the tract of country in Upper Nubia, which became famous in antiquity as the *kingdom of Ethiopia*, or the state of Meroë. The Ethiopian nations generally ranked low in the scale of civilization; 'nevertheless (to use the language of Heeren), there did exist a better cultivated, and, to a certain degree, a civilized Ethiopian people; who dwell in cities; who erected temples and other edifices; who, though without letters, had hieroglyphics; who had government and laws; and the fame of whose progress in knowledge and the social arts spread in the earliest ages over a considerable part of the earth.' Meroë Proper lay between the river Astaboras (now the Atbara or Tacazzé) on the east, and the Nile on the west. Though not completely enclosed with rivers, it was called an island, because, as Pliny observes, the various streams which flowed around it were all considered as branches of the Nile; so that to it the above description of a 'country of rivers' was peculiarly appropriate. Its surface exceeded that of Sicily more than a half, and it corresponded pretty nearly to the present province of Atbara, between 13° and 18° N. lat. In modern times it formed a great part of the kingdom of Senaar, and the southern portion belongs to Abyssinia. Upon the island of Meroë lay a city of the same name, the metropolis of the kingdom, the site of which has been discovered near a place called Assur, about

* Jablonsky and Champollion both seek the derivation of Syene in the Coptic; but the former thinks it denotes 'boundary,' the latter 'key,'

i. e. of Egypt. It was always considered the natural frontier towards Ethiopia.

twenty miles N. of the town of Shendy, under 17° N. lat. The splendid ruins of temples, pyramids, and other edifices found here and throughout the district have been described by Caillaud, Gau, Rüppell, Belzoni, Waddington, Hoskins, and other travellers, and attest the high degree of civilization and art among the ancient Ethiopians.

Josephus, in his account of the expedition of Moses when commander of the Egyptian army against the Ethiopians, says that the latter 'at length retired to Saba, a royal city of Ethiopia which Cambyses afterwards called Meroë, after the name of his own sister' (*Antiq.* ii. 10. 2). The same origin of the name is given both by Strabo and Diodorus Siculus, but see Mannert's *Geog. of the Greeks and Romans*, x. 199. There is still a place called *Merawé* considerably north of the island and near Mount Berkal, where Heeren thinks there may have been a settlement of the parent state called by the same name. The opinion of Josephus that Meroë was identical with Seba accords well with the statement in Gen. x. 7, that Seba was the eldest son of Cush, and as his name is written with a *samech* (שׁבא), he is not to be confounded with either of the Shebas (שׁבט), who are mentioned as descendants of *Shem* (Gen. x. 28; xxv. 3). Now this country of African Seba is classed with the Arabian Sheba as a rich but far-distant land (Ps. lxxii. 10). In Isa. xliii. 3 God says to Israel, 'I have given Egypt for thy ransom; Cush and Seba in thy stead;' and in Isa. xlv. 14, 'The wealth of Egypt and the merchandise of Cush and of the Sebaïm men of stature shall pass over to thee and shall be thine.' Charles Taylor, the ingenious but fanciful editor of *Calmet*, had the singular notion that שׁבא מֵרָה is meant men of *short* measure, or dwarf; and hence he identifies the Ethiopians with the Pygmies of antiquity (*Fragments to Calmet*, cccxxi). But the Hebrew phrase plainly denotes 'tallness of stature' (comp. 1 Chron. xi. 23), and the Ethiopians are described by Herodotus as *ἄνδρες μέγιστοι* (iii. 114), *μέγιστοι ἀνθρώπων* (iii. 20); and Sulinus affirms that they were twelve feet in height (*Polyhist.* cap. xxx). In common with the other Cushite tribes of Africa the skin was black, to which there is an obvious allusion in Jer. xiii. 23: 'Can the Cushite change his skin?' Bruce finds Seba in Azab, a sea-port on the east coast of Africa near the entrance to the Red Sea, and in this he is followed by Heeren, while others think of a place called Subah about lat. 15° N., where are some of the most remarkable ruins of Nubian grandeur; but both opinions are merely conjectural.

Among other tribes of Africa said to have been in alliance with Egypt, the prophet Ezekiel (xxx. 5) mentions along with Ethiopia the name of *Chub*, which Michaelis connects with *Kobé*, a trading town described by Ptolemy as on the west coast of the Red Sea. But in the Arabic translation made from the Septuagint, instead of *Chub* we find 'the people of Nubia.' The Hebrew letters כ and ח might easily be confounded by a transcriber, and in the MS. 409 of De Rossi it is not כוב *Chub*, but נוב *Nub*, which is probably the true reading. There are still two districts adjoining Meroë on the south-west, called *Cuba* and *Nuba*, which are said to abound in gold. The *Sukkiim*, who, along with the Cushites and *Lubim* or *Libyans*, formed part of the host of

Shishak (2 Chron. xii. 3), are in the Sept. designated Troglodytes, *i. e.* cave-dwellers, and were, no doubt, the people known to the Greeks by the same name as inhabiting the mountain-caverns on the west coast of the Red Sea (Diod. Sic. iii. 32; Strabo, xvii. p. 785). They were noted for swiftness of foot and expertness in the use of the sling, and hence were employed, as Heliodorus informs us (*Ethiopia*, viii. 16), as light troops. Pliny makes mention of a town of *Suche* in that region (*Hist. Nat.* vi. 29. 34), and there is still on the same coast a place called Suakim, described by Burckhardt in his *Travels in Nubia*. If, however, the term *Sukkiim* be of Hebrew derivation, it would specially denote those who lived in booths, *i. e.* tabernacles made of the *boughs of trees*; and it deserves remark that the Shangallas who inhabit that country, still dwell during the good season in arbours fitted up for tents, repairing in winter to their rocky caves.

In the age of Herodotus, the countries known to us as Nubia and Sennaar were occupied by two different races, one of whom he includes under the general appellation of Ethiopians, the other an immigratory Arabian race leading, for the most part, a nomadic life. This distinction has continued down to the present day. Among the aboriginal inhabitants the first place is due to the Nubians, who are well-formed, strong, and muscular, and with nothing whatever of the negro physiognomy. They go armed with spear, sword, and a shield of the skin of the hippopotamus. South of Dongola is the country of the Schegyias, whose warriors are horsemen, also armed with a double-pointed spear, a sword, and a large shield (comp. Jer. xli. 9, the 'Cushites who handle the shield'). They were completely independent till subdued by Mehemet Ali, pacha of Egypt. It is in their country that the pyramidal monuments which adorned the ancient Meroë are first met with, and even its name has been preserved in that of their chief place, Merawé, though the original Meroë must be sought farther south. Next comes the territory of the Bebers, strictly so called, who, though speaking Arabic, evidently belong to the Nubian race. Above these regions beyond the Tacazzé and along the Nile the great mass of the inhabitants, though sometimes with a mixture of other blood, may be regarded as of Arab origin. But between the valley of the Nile and the Red Sea there is still, as of old, a variety of scattered aboriginal tribes, among whom the Arabic is much less common: they are, doubtless, partly the descendants of the above-mentioned Sukkiim, or Troglodytes, and of the Ichthyophagi, or fish-eaters. Some of them spread themselves over the plains of the Astaboras, or Tacazzé, being compelled to remove their encampments, sometimes by the inundations of the river, at other times by the attacks of the dreaded *zimb*, or gadfly, described by Bruce, and which he supposes to be the fly which is in the utmost part of the rivers of Egypt' (Isa. vii. 18). Another remarkable Ethiopic race in ancient times was the *Macrobians*, so called from their supposed longevity. They were represented by the ambassadors of Cambyses as a very tall race, who elected the highest in stature as king: gold was so abundant that they bound their prisoners with golden fetters—circumstances which again remind us of Isaiah's description of Ethiopia and Seba in ch. xlv. 14.

With regard to the ancient civilization of Ethiopia Proper, or the kingdom of Meroë, it was closely connected with the religion of the country, which was the worship of Ammon and his kindred deities, and the 'Oracles of Ammon' were its main support. The government was in the hands of a race or caste of priests, who chose from among themselves a king; and this form continued down to the reign in Egypt of the second Ptolemy, when Ergamenes, at that time king, massacred the priests in their sanctuary, and became absolute monarch.

Of the history of Ethiopia, previous to that last revolution, only scanty information has been preserved, but it is enough to evince its high antiquity and its early aggrandizement. In the Persian period it was certainly an independent and important state, which Cambyses in vain endeavoured to subdue. But its most flourishing era was between the years B.C. 800 and 700, when arose three potent kings, Sabaco, Seveclus, and Tirhako, or Tirhakah, who extended their conquests over a great part of Egypt. Seveclus is supposed to have been the So or Sua king of Egypt, to whom an embassy was sent by Hoshia, king of Israel (2 Kings xvii. 4), whose reign ended B.C. 722. He was thus the contemporary of Salmanassar, king of Assyria, as was Tirhakah of the next Assyrian monarch, Sennacherib, who (about the year B.C. 714) was deterred from the invasion of Egypt merely by the rumour that Tirhakah was advancing against him (2 Kings xix. 9). There seems no reason to doubt that the remarkable prophecy in the 18th chapter of Isaiah was addressed to Tirhakah and his people, to announce to them the sudden overthrow of the Assyrian host before Jerusalem: 'Ho! thou land with rustling wings [i. e. *armies* in the clangour of battle, as in chap. viii. 8] beyond the streams of Cush [for the country lay south of its great rivers], which sendest thy messengers on the [Red] sea, and in vessels of papyrus on the waters [of the Nile]. Up! ye swift messengers, to the nation robust and valiant, the nation formidable from the first and hitherto, the nation powerful and all-crushing, whose country is intersected with streams, &c. This description of the Ethiopian nation is repeated at verse 7 almost *verbatim*, and it is intimated that, struck at the mighty deeds of the God of Judah, this distant people should send gifts to his dwelling-place at Zion. They were, no doubt, among the 'many' who are described in 2 Chr. xxxii. 23, as having 'brought gifts unto Jehovah at Jerusalem, and presents to king Hezekiah, so that he was magnified in the sight of all the nations.' But it is remarked by Gesenius (*Comm. on Isaiah*, in loc.) that the expectation of the entire conversion of the Ethiopians is frequently expressed by the Hebrew prophets (Isa. xlv. 14; Zeph. iii. 10; Ps. lxxviii. 32; lxxxvii. 4); and he adds, 'Those who take pleasure in tracing the fulfilment of such predictions in subsequent history may find it in Acts viii. 27 (the conversion both to Judaism and Christianity of the treasurer of Queen Candace), and still more in the circumstance that Abyssinia is to this day the only great Christian state in the eastern world.' Wilkinson informs us that the figure and name of Tirhakah, and the expedition he undertook against Sennacherib, are recorded on the walls of a Theban Temple. 'It is probable,' says he, 'that

in the early part of his reign Sethos divided the kingdom with him, and ruled in Lower Egypt, while the Ethiopian monarch possessed the dominion of the upper country; and this would account for the absence of the name of Sethos on the monuments of Thebes. Whether Tirhakah and Sabaco's claims to the throne of Egypt were derived from any right acquired by intermarriage with the royal family of that country, and whether the dominion was at first confined to the Thebaid, it is difficult to determine; but the respect paid by their successors to the monuments they erected argues the probability of their having succeeded to the throne by right rather than by usurpation or the force of arms' (*Ancient Egyptians*, vol. i. p. 140; comp. Rosellini, mon. ii. tab. 8). Of the military renown of Tirhakah, Megasthenes speaks in Strabo (xv. 1. 6), where he mentions *Τεράκωνα ὄνυ Αἰθίοπα* along with Sesostris and Nebuchadnezzar, as one who had penetrated into Europe, and advanced as far as the pillars of Hercules—the usual limit of great conquerors. According to Julius Africanus, Tirhakah reigned eighteen years; according to Eusebius twenty: the former calls him *Τεράκος*, the latter *Ταρακός*. 'Contemporary with him,' says Gesenius, 'there existed two dynasties in Sais and Tanis, and, without doubt, his had its seat in Thebais. In the last years of his reign falls the Dodekarchy, at the end of which the Ethiopians withdrew into their original kingdom (Herod. ii. 139). From this connection we may derive a satisfactory explanation of the fact, that Isaiah often mentions Egypt and Ethiopia in so close political relation (see especially chap. xx. 3-6). The same fact is noticeable in the latter prophets, and proves the continuance of a friendly understanding (Ezek. xxx. 4, sq.; Jer. xlvi. 9; Nahum iii. 9; Dan. xi. 43). In fine, Ethiopia is employed chiefly as the name of the national and royal family that were now in the ascendancy.'

If we go back about two centuries, to the reign of Asa, king of Judah (B.C. 950), we read of Zerah, or rather Zerach, an Ethiopian going out against him with a host of a thousand thousand men and three hundred chariots (2 Chron. xiv. 9). It is doubtful whether this was an Ethiopian monarch or commander, or only a mere Cushite adventurer; but that his army was mainly of African and not Arabian original is evident from the fact of its having included Libyans as well as Cushites (2 Chron. xvi. 8), and from the mention of war-chariots, which never were in use in Arabia. Farther back than this the records of history are silent. Pliny, indeed (*Hist. Nat.* vi. 35), after observing that Ethiopia was ruined by its wars with Egypt, which it sometimes subdued and sometimes served, adds, that 'it was powerful and illustrious even as far back as the Trojan war, when Memnon reigned.' Existing monuments confirm that high antiquity which tradition assigns to the state of Meroë. The name of Rameses, or Sesostris, has been found on many of the ruins of Nubia, and he is well known in history as its conqueror (Herod. ii. 110). That the Pharaohs indeed should have carried their conquests into Ethiopia, ought not to seem strange to us in those days the same scene has been acted; for scarcely was Mehemet Ali firmly possessed of Egypt than he sent his son to subdue Ethiopia, and he not only penetrated to Meroë, but much farther south.

The era of Rameses cannot be placed later than 1500 years B.C. But the name of Pharaoh Thutmosis, the expeller of the Hyksos, has been found by Champollion on the Nubian Temple of Amada, and the sculptures found there show a degree of civilization that can only be ascribed to a nation which had long existed. We thus approach the age of Moses, at which Jewish tradition, as reported by Josephus, assigns the conquest of Meroë to Moses himself, as general of the army of Egypt; and the traditions of the Egyptian priesthood also agree in this, that the Ethiopians laid the foundation of the most ancient states of Egypt.

The state of Meroë appears to have resembled the larger states in the interior of Africa at the present day, comprising a number of different races or tribes united together by no strong political bond, but by a common form of worship, which placed the rule in the hands of the priesthood, the dominant caste of the country. There is every reason to conclude that the separate colonies of the priest-caste spread from Meroë into Egypt; and the primeval monuments in Ethiopia strongly confirm the native traditions reported by Diodorus Siculus, that the worship of Ammon and Osiris originated in Meroë, and thus render highly probable the opinion that commerce and civilization, science and art, descended into Egypt from Nubia and the upper regions of the Nile. One great cause of the early prosperity and grandeur of Ethiopia was the carrying-trade, of which it was the centre, between India and Arabia on the one hand, and the interior of Africa, and especially Egypt, on the other. This has been well illustrated by Heeren in his work *On the Ancient Nations of Africa*, vol. i. p. 289 sqq. 'In proportion,' says he, 'as we ascend into the primeval ages, the closer seems the connection between Egypt and Ethiopia. The Hebrew poets seldom mention the former without the latter; the inhabitants of both are drawn as commercial nations. When Isaiah celebrates the victories of Cyrus, their submission is spoken of as his most magnificent reward (Isa. xlv. 14). When Jeremiah extols the great victory of Nebuchadnezzar over Pharaoh-nechoh, near Carchemish, the Ethiopians are allied to the Egyptians (Jer. xlvi. 9). When Ezekiel threatens the downfall of Egypt, he unites it with the distant Ethiopia (Ezek. xxx. 4). Every page, indeed, of Egyptian history exhibits proofs of the close intimacy in which they stood. The primitive states of Egypt derived their origin from these remote regions. Thebes and Meroë founded in common a colony in Libya; Ethiopian conquerors more than once invaded Egypt; Egyptian kings in return forced their way into Ethiopia; t. e. same worship, the same manners and customs, the same mode of writing, are found in both countries; and, under Psammetichus, the noble and numerous party of malecontents retired into Ethiopia. Egypt, also, as far as history reaches back, abounded in all the commodities of the southern regions. Whence did she obtain the spices and drugs with which she embalmed her dead? whence the incense that burned on her altars? whence that immense quantity of cotton in which her inhabitants were clad, and which her own soil so sparingly produced? Whence came into Egypt that early rumour of the Ethiopian gold countries, which Cambyzes set out to discover, and lost half his army in the attempt?

Whence that profusion of ivory and ebony which the ancient artists of Greece and Palestine embellished? Whence that general and early spread of the name of Ethiopia, which glimmers in the traditional history of so many nations, and which is celebrated as well by the Jewish poets as by the earliest Grecian bards? Whence but from the international commerce of which Ethiopia was the seat and centre? Its principal route is still pointed out by a chain of ruins, extending from the shores of the Indian sea to the Mediterranean. Adule, Azab, and Axum, are links of this chain between Arabia Felix and Meroë; Thebes and Ammonium between Meroë, Egypt, and Carthage.'

Queen Candace, who is mentioned in Acts viii. 27, was doubtless the reigning sovereign of Meroë [CANDACE], where it is likely a form of Judaism was at that period professed by a portion of the inhabitants, as seems to have been the case in the adjacent region of Abyssinia. The prophets (*e. g.* Isa. xi. 11) sometimes allude to the Jews who were scattered throughout Cush. Ebed-melech, the benevolent eunuch of King Zedekiah, who showed such kindness to the prophet Jeremiah, was an Ethiopian (Jer. xxxviii. 7; comp. Acts viii. 27). Josephus calls the queen of Sheba, who visited Solomon, a queen of Egypt and Ethiopia, and with this agrees the tradition of the Abyssinians, who claim her as a native queen, give her the name of Maqueda, and maintain that she had a son by Solomon, called Menilek, who bore the title of David I. Yet Sheba was undoubtedly in Arabia Felix, though it is possible that, in remote antiquity, the sovereignty of its monarchs extended across the Red Sea to the coast of Ethiopia.—N. M.

ETHIOPIC LANGUAGE. As it is maintained by competent judges that the Amharic and the Tigré are really dialects of the ancient Ethiopic or Geez,* it may be expected, from the recent progress of comparative grammar, that future scholars will apply them to elucidate the structure of the other Syro-Arabian languages. At present, however, as even the Amharic is not yet able to boast of adequate and accessible means for its study, and as neither possesses any ancient version of any part of the Bible, the Geez is the only one which claims a particular notice here.

The ancient Ethiopic or Geez, which is the only one of the three dialects which either has been, or is now, generally used in written documents of a sacred or civil kind, is to be classed as an ancient branch of the Arabic. This affinity is evident from the entire grammatical structure of the language: it is confirmed by the relation of its written character to that of the Himjarite alphabet; and either supports, or is supported by, the assumption that Habesh was actually peopled by a colony from southern Arabia. The grammatical structure of the Geez shows a largely predominant identity with that of Arabic; but it

* Adelung and Vater, in the *Mithridates*, appear to be the chief authorities for doubting the intimate affinity of the Geez and Amharic. In this particular, and throughout the subject, we have followed Gesenius, in his two articles on the Ethiopic and Amharic languages in Ersch and Gruber's *Allgemeine Encyclopädie*.

also possesses some traits which are in closer accordance with the other Syro-Arabian idioms, and some which are peculiar to itself alone. The main features of its structure are as follow:—The verb possesses the first ten conjugations of the Arabic verb, with the exception of the eighth and ninth; besides these it has two other conjugations which are unknown to the Arabic. The formation of nouns resembles most that of Hebrew; but nouns often have superfluous end-vowels, which are modified in particular cases, and are analogous to the Arabic nunation. As for the flexion of nouns, the masculine and feminine plurals are either formed by affixed syllables (*dn, dt*) on the principle common to the whole Syro-Arabian family; or by changes within the compass of the radical letters, after the manner of the so-called *broken* plurals of the Arabic grammar. The state construct, and that relation of the noun which is equivalent to our objective case, are denoted by changes in the final vowels. There is no form for the dual number either in the verb or the noun. With regard to the vocabulary of the language, one-third of the roots are to be found in the same state in Arabic. By making allowance for commutations and transpositions, many other roots may be identified with their Arabic correspondents: some of its roots, however, do not exist in our present Arabic, but are to be found in Aramaic and Hebrew. Besides this it has native roots peculiar to itself: it has adopted several Greek words, but shows no traces of the influence of Coptic.

The alphabet possesses twenty-six consonants, arranged in a peculiar order, twenty-four of which may be regarded as equivalents to the same number of letters in the Arabic alphabet (the ones excepted being *ث, ذ, ظ, and غ*).

The remaining two are letters adopted to express the Greek Π and Ψ. The vowel-sounds, which are seven, are not expressed by separable signs, as in the Hebrew and Arabic punctuation, but are denoted by modifications in the original form of the consonants, after the manner of the *Dēvanāgari* alphabet. The mode of writing is from left to right. As for the written characters, Gesenius has traced the relation between some of them and their equivalents in the Phœnician alphabet. There is, however, the most striking resemblance between the Geez letters generally and those in the Himjarite inscriptions; a circumstance which accords well with the supposed connection of Southern Arabia and Habesh. Moreover, Lepsius, in an interesting essay, *Ueber die Anordnung und Verwandtschaft der Semitischen, Indischen, Aethiopischen, &c. Alphabets* (in his *Zwei Sprachvergleichende Abhandlungen*, Berlin, 1836, 8vo. pp. 74-80), has adduced some striking arguments to prove that the *Dēvanāgari* alphabet must have had some influence on the development of the Geez.

The literature of the Geez language is very scanty indeed, and that little is almost exclusively of a Biblical or ecclesiastical character. It possesses nothing, not even an imitation of the national poetry, nor of the lexicographical and grammatical works, of the Arabs. Some few historical works in the shape of chronicles, and a few medical treatises, constitute the main body of their profane literature. The Geez has ceased, ever since the beginning of the fourteenth century,

to be the vernacular language of any part of the country, having been supplanted at the court of the sovereign by the Amharic. It still continues, however, to be the language used in religious rites, in domestic affairs of state, and in private correspondence.—J. N.

ETHIOPIC VERSION. The libraries of Europe contain some, although very rarely complete, manuscript copies of a translation of the Bible into the Geez dialect. This version of the Old Testament was made from the Greek of the Septuagint, according to the Alexandrian recension, as is evinced, among other things, by the arrangement of the Biblical books, and by the admission of the Apocrypha without distinction. It is divided into four parts: *The Law*, or the Octateuch, containing the Pentateuch and the books of Joshua, Judges, and Ruth; *The Kings*, in thirteen books, consisting of two books of Samuel, two of Kings, two of Chronicles, two of Ezra (Ezra and Nehemiah), Tobit, Judith, Esther, Job, the Psalms; *Solomon*, in five books, consisting of Proverbs, Ecclesiastes, Canticles, Wisdom, and Sirach; *Propheets*, in eighteen books, consisting of Isaiah, Jeremiah's prophecy and Lamentations, Baruch, Ezekiel, Daniel, and the twelve minor prophets: lastly, they have also two books of the Maccabees. Besides this, they possess an apocryphal book of Enoch, which they place next to that of Job. The critical uses of this version are almost exclusively confined to the evidence it gives as to the text of the Septuagint. The version of the New Testament was made direct from the Greek original. It follows the verbal arrangement of the Greek very closely, and has mistakes which are only to be explained by the confusion of words which resemble each other in that language. It is difficult to determine what recension it follows; but it frequently agrees with the Peshito and the Itala. It is impossible to ascertain the date of the execution of either of these translations; but they may both be ascribed with much probability to the beginning of the fourth century. Only small portions of the former have been printed. The whole New Testament has, however, appeared. The Gospels were edited anew from MSS. by T. P. Platt, M.A., in 1826, in 4to.—J. N.

ETHUN (ἠθύν) occurs in Prov. vii. 16, in connection with Egypt, and as a product of that country. It is translated *fine linen* in the Authorized Version. 'I have decked my bed with coverings of tapestry, with carved works, with *fine linen (ethun)* of Egypt.' As Egypt was from very early times celebrated for its cultivation of flax and manufacture of linen, there can be little doubt that *ethun* is correctly rendered, though some have thought that it may signify rope or string of Egypt, 'funis Ægyptius,' 'funis salignus v. intubaceus;' but Celsius (*Hierobot.* ii. p. 89) observes, 'Ethun non funem, sed limum et linteum esse, clamat græca vox ἠθύνη vel ἠθύνον, quam ab ethun esse deducendam.' So Mr. Yates, in his *Textrinum Antiquorum*, p. 265, says of ἠθύνη, that 'it was in all probability an Egyptian word, adopted by the Greeks to denote the commodity to which the Egyptians themselves applied it.' For ἠθύν, put into Greek letters, and with Greek terminations, becomes ἠθύνη and ἠθύνον. Hesychius states, no doubt correctly, 'that ἠθύνη was applied by the

Greeks to any fine and thin cloth, though not of linen.' Mr. Yates further adduces from ancient Scholia that ὀθόνας were made both of flax and of wool; and also that the silks of India are called ὀθόνας σπηκαί by the author of the *Periplus of the Erythraean Sea*. We have also shown from the same work, in the article COTTON, p. 473, that the name ὀθόνας was applied to cloths exported from Cutch, Ougein, and Baroach, and which must have been made of cotton. Mr. Yates moreover observes, that though ὀθόνη, like σινδών, originally denoted linen, yet we find them both applied to cotton cloth. As the manufacture of linen extended itself into other countries, and as the exports of India became added to those of Egypt, all varieties, either of linen or cotton cloth, wherever woven, came to be designated by the originally Egyptian names ὀθόνη and Σινδών.

In the New Testament the word ὀθόνας occurs in John xix. 40.—Then took they the body of Jesus and wound it in *linen clothes* (ὀθονίους); in the parallel passage, Matt. xxvii. 59, the term used is σινδών, as also in Mark xv. 46, and in Luke xxiii. 53. We meet with it again in John xx. 5, 'and he stooping down saw the *linen clothes* lying.' It is generally used in the plural to denote 'linen bandages.' ὀθόνη occurs in Acts x. 11, 'and (Peter) saw heaven opened, and a certain vessel descending unto him, as it had been a great *sheet* knit at the four corners, and let down to the earth,' and also in xi. 5, where this passage is repeated.

From the preceding observations it is evident that ὀθόνας may signify cloth made either of linen or cotton, but most probably the former, as it was more common than cotton in Syria and Egypt [v. COTTON and LINEN].—J. F. R.

ETZ-ABOTH (עֵץ אֲבוֹת) occurs in Lev. xxiii. 10, and Neh. viii. 15, and in both passages is mentioned along with *etz-shemen*. These words occur also in Ezek. xx. 28, where, as well as in the other passages, they are translated *thick trees*: 'For when I had brought them into the land, &c., then they saw every high hill and all the *thick trees* (*etz-aboth*), and they offered their sacrifices.' The word *etz* or *otz*, used in several places in Scripture to designate a tree, is said to be derived from the verb *otze*, 'to fix' 'to make steady.' The word *aboth*, according to Celsius (*Hierobot.* i. p. 322), is by the Rabbins, as well as in the Chaldee and Syriac versions, understood to mean the *myrtle*. But Celsius himself follows the Septuagint, the Vulgate, and several other authorities, in considering the *etz-aboth* to signify a *shady tree*, 'foliis et frondibus densa.'

The shade of trees must always have been highly esteemed in eastern, or rather in warm climates. The planting of trees was early practised, as we have seen in the case of the *eshel* planted by Abraham at Beersheba, when he called on the name of the Lord. We know also that among the nations of antiquity the planting of groves, and their consecration to their gods, were antecedent to the building of temples and altars, and were of almost universal adoption; and that groves were the scenes of their idolatrous worship and licentious rites. Hence probably the Jews were prohibited from planting trees around or near the altar of God. Shade and solitude seem

always to have been considered as giving an air of mystery and devotion to religious services. Seneca, as quoted by Dr. Carpenter, says, 'If you find a grove thick set with ancient oaks that have shot up to a vast height, the tallness of the wood, the retirement of the place, and the pleasantness of the shade, immediately make you think it to be the residence of some god.' The prophet Hosea also gives the following description: 'They sacrifice upon the tops of the mountains, and burn incense upon the hills, under oaks and poplars and elms, because the shadow thereof is good' (Hos. iv. 18). Hence, in the above passages, it is more than probable that *etz-aboth* has a general, and not a specific, signification. There is no proof of the myrtle being intended; in fact, it is not likely to have been found in any part of the wilderness, and no better material can be required for the construction of booths than the boughs of thick or shady trees.—J. F. R.

ETZ-HADAR (עֵץ הָדָר) occurs only once in Scripture, in Lev. xxiii. 40, where the Israelites are directed, in remembrance of their dwelling in tents or booths when they were brought out of the land of Egypt, to leave their homes and dwell in booths for a season every year. 'And ye shall take you on the first day the *boughs of goodly trees* (*peri etz-hadar*), branches of palm-trees, and the boughs of thick trees (*etz-aboth*), and willows of the brook; and ye shall rejoice before the Lord your God seven days.' *Etz-aboth* has been noticed in the preceding article; *etz-hadar* has been variously translated. The words in the original, *peri etz-hadar*, the Septuagint renders *κάρπον ξύλου εραΐων*, and the Vulgate, *fructus arboris pulcherrimæ*, the 'fructus ligni honoris' of Ursini. These translations are followed in many versions, as enumerated by Celsius (*Hierobot.* i. p. 252); but, as this author also shows, Onkelos and others consider the phrase to signify 'fructus arboris citrei': so R. Aben Ezra, in Hebrew, but as translated by Celsius, 'Fructus arboris speciosæ est citrus. Nam certe nullus fructus arboreus speciosior est illo.' The term *etragh* or *atruj* is that translated *citrus*. This interpretation has been adopted by the Jews, and is that given by Josephus. The orange and lemon have sometimes been adduced as the *citrus* of the above passages, but both were unknown in those early times so far north as Palestine; while the citron seems to have been early introduced from Media, and was known to the Greeks and Romans, as we shall show under the article ΤΑΦΥΡΑΗ. Some again are of opinion that the olive is intended by the word *hadar*, as the olive is mentioned instead of this tree by Nehemiah (viii. 15), in reference apparently to the above passage. Instead of fruit, however, some, as Tremellius and Dr. Geddes, conceive that *peri* signifies young growing shoots or boughs, as indeed it is interpreted in our authorized version. There can be no objection to the citron being considered the *hadar*, as is done by the Jews; since we learn from Josephus that they had them in their hands in *festo Scenopogiorum*, when they threw them at King Alexander Jannæus; and they still continue to use citrons at the Feast of Tabernacles. But this does not prove that the citron was common in Palestine, or rather in the desert, at the time of Moses. The law-giver, if he specified

any, would no doubt direct the Israelites to take such fruits or branches as were procurable in the desert; but it is probable, as maintained by the majority of commentators, that the term is general, rather than specific, and therefore that the fruit or branches of any goodly tree might be thus employed. Ursini has observed, 'Nam si species aliqua defecisset, nec omnibus æque ad manum fuisset, imposita fuisset necessitas Scenopægia celebraturis, vel omittendi gestationem horum ramusculorum, vel prævaricandi contra legis præscriptum. Cogita, si omnibus *citree* frondes fructibus suis onustæ, aut *oleagineæ*, aut *myrtæ* gestandæ fuissent, quanta circa Hierosolymas hortorum quotannis fuisset calamitas; quanta frondium talium raritas et caritas' (*Arboret. Bibl. p. 577*).—J. F. R.

ETZ-SHEMEN (עֵץ שֶׁמֶן) occurs three times in Scripture, and is differently translated in all the three passages in the Authorized Version. At the institution of the Feast of Tabernacles (Lev. xxxiii. 33-34), we have seen [ETZ-HADAR] that the Israelites were directed to make booths of the boughs of palm-trees, of willows of the brook, of goodly trees (*etz-hadar*), and of thick trees (*etz-aboth*). At the rebuilding of the temple, Nehemiah (viii. 15) directs the Israelites to 'go forth unto the mount and fetch *olive* and *pine branches* (*etz-shemen*), and *myrtle*-branches, and *palm*-branches, and branches of thick trees (*etz-aboth*), to make booths, as it is written.' Thus we see that two names are the same in both passages, viz. the *palm* and *etz-aboth*; while *etz-hadar* and *willows* of the brook are mentioned in the first, and *myrtle* branches, *olive* branches, and *etz-shemen* in the second.

This term occurs also in Isa. xli. 19: 'I will plant in the wilderness the cedar, the shittah-tree, and the myrtle, and the *etz-shemen* [here translated 'oil-tree']; I will set in the desert the fir-tree, and the pine, and the box-tree together.' The third mention of *etz-shemen* is in 1 Kings vi. 23, where its wood is described as being employed: 'And within the oracle he made two cherubim of *etz-shemen* [translated *olive-tree*], each two cubits high.' If we collate the several passages in which *etz-shemen* occurs, we shall find reason to conclude that it is not the olive-tree, as it is translated in 1 Kings vi. 23, since in Neh. viii. 15, the olive-tree (*sait*) is distinguished from *etz shemen*, which is there rendered *pine-tree*; and that it is as little likely to be the pine-tree, since in Isa. xli. 19, *etz-shemen*, translated *oil-tree*, is mentioned as distinct from both the fir and the pine.

Though the above names, occurring in the same sentences with *etz-shemen*, enable us to say that it is not likely to have been any of them, it is not more easy to say what tree is intended. Several have been adduced in addition to those mentioned above, as the different kinds of pine, including the cedar of Lebanon, the cypress, the citrus, the balsam-tree; but there is no proof in favour of any of these. Ursini and Celsius are both of opinion that the term is used generically, and therefore that no particular kind of tree is intended. This may appear to be the case in the earlier passages; but in those of Isa. xli. 19, and of 1 Kings vi. 23, a specific tree seems to be pointed out; but we have no means of determining the particular tree, though there are several

in Palestine which are not noticed in our version of the Scriptures, and though it is probable that some even of the modern Arabic names may bear some similarity to the Hebrew. The Arabic *shamanat*, signifying fragrant things, and the Persian *shamanah*, signifying anything odoriferous, a fragrant smell, seem to be connected with it. But Hebrew scholars consider *shemen* as having some reference to oiliness or fatness. Thus Celsius (*Hierob. i. 310*) quotes R. D. Kimchi as commenting on 1 Kings vi. 23, as follows: 'Intellege per עֵץ שֶׁמֶן speciem aliquam pini, ex qua manat pinguedo, unde faciunt picem; nam inde dicitur עֵץ שֶׁמֶן arbor pinguedinis.' The objection to *etz-shemen* being one of the pine tribe, is that it is mentioned as apparently distinct from both the pine and fir in the passage of Isaiah, while in that of Kings a tree is required having wood fit for making the cherubim. As no tree has yet been pointed out having a name similar either in meaning or sound to the Hebrew, and with wood of a good quality, it is better to consider *etz-shemen* as one of those not yet ascertained, than to add one more to the other unsatisfactory guesses.—J. F. R.

EVANGELISTS (Εὐαγγελιστῆς). This term is applied in the New Testament to a certain class of Christian teachers who were not fixed to any particular spot, but travelled either independently, or under the direction of one or other of the Apostles, for the purpose of propagating the Gospel. Philip, one of the seven deacons, is termed the *Evangelist* (Acts xxi. 8). St. Paul exhorts Timothy 'to do the work of an *Evangelist*' (2 Tim. iv. 5); and though this name is not given to Titus, the injunctions addressed to him, and the services he rendered, are so similar as to render the propriety of applying it to him unquestionable. In the Epistle to the Ephesians (iv. 11) the *Εὐαγγελιστῆς* (*Evangelists*) are expressly distinguished from the ποιμένας καὶ διδασκάλους (*pastors and teachers*). The chief points of difference appear to be that the former were itinerant, the latter stationary; the former were employed in introducing the Gospel where it was before unknown; the business of the latter was to confirm and instruct the converts stately and permanently. Such is the representation given by Eusebius (*Hist. Eccles. iii. 37*). Referring to the state of the church in the time of Trajan, he says, 'Many of the disciples of that time, whose souls the Divine word had inspired with an ardent love of philosophy, first fulfilled our Saviour's precept by distributing their substance among the poor. Then travelling abroad they performed the work of Evangelists (ἔργον ἐπετέλουν Εὐαγγελιστῶν), being ambitious to preach Christ, and deliver the Scripture of the Divine Gospels. Having laid the foundations of the faith in foreign nations, they appointed other *pastors* (ποιμένας τε καθίσταντες ἑτέροις), to whom they entrusted the cultivation of the parts they had recently occupied, while they proceeded to other countries and nations.' He elsewhere speaks of Pantænus and others as *Evangelists of the Word* (Εὐαγγελιστῆς τοῦ λόγου) (*Hist. Eccles. v. 10*). In the same writer the term *Evangelist* is also applied, as at present, to the authors of the canonical gospels (*Hist. Eccles. iii. 39*). (Campbell's *Lectures on Ecclesiastical History*, vol. i. pp. 148-150; Neander's *History of the Planting of the Christian Church*, Eng. transl. vol. i. p. 173).—J. E. R.

EVE, the name of the first woman. Her history is contained in that of ADAM, which see.

EVENING. [DAY.]

EVIL-MERODACH (עֵוִל מֶרֶדַּח; Sept. *Εὐλαμαροδάκ, Οὐλαμαδάχαρ*), son and successor of Nebuchadnezzar, king of Babylon, who, on his accession to the throne (B.C. 562), released the captive king of Judah, Jehoiachin, from prison, treated him with kindness and distinction, and set his throne above the thrones of the other conquered kings who were detained at Babylon (2 Kings xxv. 27; Jer. lii. 31-34) [CHALDEANS]. A Jewish tradition (noticed by Jerome on Isa. xiv. 29) ascribes this kindness to a personal friendship which Evil-merodach had contracted with the Jewish king, when he was himself consigned to prison by Nebuchadnezzar, who, on recovering from his seven years' monomania, took offence at some part of the conduct of his son, by whom the government had in the meantime been administered. This story was probably invented to account for the fact. Evil-merodach is doubtless the same as the Ilvarodam of Ptolemy's *Canon*. The duration of his reign is made out variously by chronologers, some extending it to twenty-four years, others reducing it to two or three. Hales, who adopts the last number, identifies him with the king of Babylon who formed a powerful confederacy against the Medes, which was broken up, and the king slain by Cyrus, then acting for his uncle Cyaxares. But this rests on the authority of Xenophon's *Cyropædia*, the historical value of which he estimates far too highly [CYRUS].

The latter half of the name Evil-Merodach is that of a Babylonian god [MERODACH]. Two modes of explaining the former part of it have been attempted. Since *evil*, as a Hebrew word, means 'foolish,' Simonis proposes to consider it the derivative of עֵוִל, in the Arabic signification of 'to be first,' affording the sense of 'prince of Merodach.' This rests on the assumption that the Babylonian language was of Syro-Arabian origin. Gesenius, on the other hand, who does not admit that origin, believes that some Indo-Germanic word, of similar sound, but reputable sense, is concealed under *evil*, and that the Hebrews made some slight perversion in its form to produce a word of contemptuous signification in Hebrew, just as is assumed in the case of Beelzebub.

EUNICE (Εὐνίκη), the mother of Timothy, a Jewess, although married to a Greek and bearing a Greek name, which signifies *good victory*, and is that of one of the Nereides, daughters of Oceanus. She was a believer in Christ, and even her mother Lois lived in the faith of the expected Messiah, if she did not live to know that he had come in the person of Jesus of Nazareth (2 Tim. i. 5; Acts xvi. 1).

EUNUCH (εὐνοῦχος). This word, which we have adopted from the Greek, has, in its literal sense, the harmless meaning of 'bed-keeper,' i. e. one who has the charge of beds and bed-chambers; but as only persons deprived of their virility have, from the most ancient times, been employed in Oriental harems, and as such persons are employed almost exclusively in this kind of service, the word 'bed-keeper' became synonymous with 'castratus.' In fact there are few eastern languages in which the condition of those persons is more directly expressed than by the name of

some post or station in which they are usually found. The admission to the recesses of the harem, which is in fact the domestic establishment of the prince, gives the eunuchs such peculiar advantages of access to the royal ear and person, as often enables them to exercise an important influence, and to rise to stations of great trust and power in Eastern courts. Hence it would seem that, in Egypt, for instance, the word which indicated an eunuch was applied to any court officer, whether a castratus or not. The word which describes Joseph's master as 'an officer of Pharaoh' (Gen. xxxvii. 6; xxxix. 1) is סָרִיס *saris*, which is used in Hebrew to denote an eunuch; and in these places is rendered נָרַב, 'prince,' in the Targum, and εὐνοῦχος, 'eunuch,' in the Septuagint.

Authority would be superfluous in proof of a matter of such common knowledge as the employment of eunuchs, and especially of black eunuchs in the courts and harems of the ancient and modern East. A noble law, which, however, evinces the prevalence of the custom prior to Moses, made castration illegal among the Jews (Lev. xxii. 24; Deut. xxiii. 1). But the Hebrew princes did not choose to understand this law as interdicting the use of those who had been made eunuchs by others; for that they had them, and that they were sometimes, if not generally, blacks, and that the chief of them was regarded as holding an important and influential post, appears from 1 Kings xxii. 9; 2 Kings viii. 6; ix. 32, 33; xx. 8; xxiii. 11; Jer. xxxviii. 7; xxxix. 16; xli. 16. Samuel was aware that eunuchs would not fail to be employed in a regal court; for he thus forewarns the people, 'He (the king) will take the tenth of your seed and of your vineyard, and give to his eunuchs [A. V. 'officers'] and to his servants' (1 Sam. viii. 15).

Under these circumstances, the eunuchs were probably obtained from a great distance, and at an expense which must have limited their employment to the royal establishment; and this is very much the case even at present.

In Matt. xix. 12, the term 'eunuch' is applied figuratively to persons naturally impotent. In the same verse mention is also made of persons 'who have made themselves eunuchs for the kingdom of heaven's sake;' which is a manifestly hyperbolic description of such as lived in voluntary abstinence (comp. Matt. v. 29, 30); although painful examples have occurred (as in the case of Origen) of a disposition to interpret the phrase too literally, and thus to act upon the following injunction, or permission, 'Let him who is capable of doing this, do it'—ὁ δὲ δυνάμενος χωρεῖν χωρεῖτο.

EUODIAS (Εὐοδίας), a female member of the church at Philippi, who seems to have been at variance with another female member named Syntyche. Paul describes them as women who had 'laboured much with him in the gospel,' and implores them to be of one mind (Philip. iv. 2, 3).

EUPHRATES (Εὐφράτης), termed in Deut. i. 7, 'the great river,' where it is mentioned as the eastern boundary of the land which (ver. 8) God gave to the descendants of Abraham. In Gen. ii. 14, the Euphrates (פַּרְתִּי) is stated to be the fourth of the rivers which flowed from a common stream in the garden of Eden. Divines and geographers have taken much trouble in order to

learn the position of Eden from the geographical particulars given in the Bible, without remembering that probably nothing more than a popular description was intended. It is true that two of the rivers mentioned in the passage, namely, the Tigris and the Euphrates, have their sources in the same high lands; but scientific geography neither sanctions nor explains the Scriptural account, if Eden is to be sought in the mountainous range in different and distant parts of which they rise.

In consequence of its magnitude and importance, the Euphrates was designated and known as 'the river,' being by far the most considerable stream in Western Asia. Thus in Exod. xxiii. 31, we read, 'from the desert unto the river' (comp. Isa. viii. 7).

It has two sources and two arms—a western and an eastern—which rise in the mountains of Armenia. Of these streams the western is the shorter, and is called Kara Sou, or Melas; the eastern is itself made up of several streams, the longest of which bears the name of Murad, or Phrat. The two arms unite about three days' journey from Erzerum, near which rise two of the tributaries that concur in forming the Phrat. Thus uniting, they give rise to the Euphrates strictly so called, which, flowing to the south, divides Armenia from Cappadocia; but, being driven westward by the Anti-Taurus and Taurus mountains, it works its circuitous way through narrow passes and over cataracts, until, breaking through a defile formed by the eastern extremity of Mons Amanus (Alma Dagh), and the north-western extremity of Mons Taurus, it reaches the plain country not far from Samosata (Schemisat), then winds south and south-east, passing the north of Syria, and the north-east of Arabia Deserta, and at length, after many windings, unites with the Tigris, and thus united finds its termination in the Persian Gulf. (Herod. i. 180; Strabo, ii. p. 521; Ptolem. v. 13; Plin. *Hist. Nat.* v. 20; Q. Curt. i. 13; *Orbis Terrarum*, C. Kaercher Auct.; Map to Report from the Select Committee on Steam Navigation to India.) In conjunction with the Tigris, it forms the rich alluvial lands of Mesopotamia, over which it flows or is carried by canals, and thus diffuses abroad fertility and beauty. At Bagdad and Hillah (Babylon), the Euphrates and Tigris approach comparatively near to each other, but separate again, forming a kind of ample basin, till they finally become one at Koorma. Under the Casars the Euphrates was the eastern boundary of the Roman empire, as under David it was the natural limit of the Hebrew monarchy.

Although occasionally, much more, the breadth of the Euphrates varies between 200 and 400 yards; but for a distance of 60 miles through the Lemlun marshes the main stream narrows to about 80 yards. The general depth of the Upper Euphrates exceeds 8 feet. In point of current it is for the most part a sluggish stream; for, except in the height of the flooded season, when it approaches 5 miles an hour, it varies from $2\frac{1}{2}$ to $3\frac{1}{2}$, with a much larger portion of its course under 3 than above. Its general description for some distance below Erzingan is that of a river of the first order, struggling through high hills, or rather low mountains, making an exceedingly tortuous course, as it forces its way over a pebbly or rocky bed, from one natural

barrier to another. As it winds round its numerous barriers, it carries occasionally towards each of the cardinal points a considerable body of water; and is shallow enough in some places for loaded camels to pass in autumn, the water rising to their bellies, or about $4\frac{1}{2}$ feet. The upper portion of the river is enclosed between two parallel ranges of hills, covered for the most part with high brushwood and timber of moderate size, having a succession of long narrow islands, on several of which are moderate-sized towns; the borders of this ancient stream being still well inhabited, not only by Bedouins, but by permanent residents. The following towns may be named: Samsat, Haoroum, Romkala, Bir, Giaber, Deir, Rava, Ama, Hadisa, El Oos, Jibba, Hit, Hillah, Lemlun, Korna, and Bussora. The scenery above Hit, in itself very picturesque, is greatly heightened by the frequent recurrence of ancient irrigating aqueducts, beautiful specimens of art, which are attributed by the Arabs to the Persians when fire-worshippers: they literally cover both banks, and prove that the borders of the Euphrates were once thickly inhabited by a highly civilized people. They are of stone. Ten miles below Hit is the last of these. The country now becomes flatter, with few hills; the river winds less; and the banks are covered with Arab villages of mats or tents, with beautiful mares, cattle, and numerous flocks of goats and sheep. From Hit to Babylon the black tent or the Bedouin is almost the only kind of habitation to be seen. This distance is cultivated only in part; the rest is desert, with the date-tree showing in occasional clusters. In descending, the irrigating cuts and canals become more frequent. Babylon is encircled by two streams, one above, the other below the principal ruin; beyond which they unite and produce abundance. For about thirty miles below Hillah both banks have numerous mud villages, imbedded in date-trees: to these succeed huts formed of bundles of reeds. The country lower down towards Lemlun is level and little elevated above the river; irrigation is therefore easy: in consequence, both banks are covered with productive cultivation, and fringed with a double and nearly continuous belt of luxuriant date-trees, extending down to the Persian Gulf. At one mile and a half above the town of Dewania is the first considerable deviation from this hitherto majestic river; another takes place 22 miles lower; and nine miles farther—at Lemlun—it again separates into two branches, forming a delta not unlike that of Damietta, and when the river is swollen, inundating the country for a space of about 60 miles in width with a shallow sheet of water, forming the Lemlun marshes, nearly the whole of which is covered with rice and other grain the moment the river recedes (in June). Here mud villages are swept away by the water every year.

Below Lemlun the Tigris sends a branch to the Euphrates, which is thus increased in its volume; and turning to the east, receives the chief branch of the Tigris, thence running in one united stream, under the name of the Shat al Arab, as far as the sea (the Persian Gulf). In this last reach the river has a depth of from 3 to 5 fathoms, varies in breadth from 500 to 900 yards, and presents banks covered with villages and cultivation, having an appearance at once imposing and majestic. The length of the navigable part of

the river, reckoning from Bir to Bussora, is 143 miles; the length of the entire stream, 1400 miles. It is very abundant in fish. The water is somewhat turbid; but, when purified, is pleasant and salubrious. The Arabians set a high value on it, and name it *Morad Sou*; that is, Water of desire, or longing.

The river begins to rise in March, and continues rising till the latter end of May. The consequent increase of its volume and rapidity is attributable to the early rains, which, falling in the Armenian mountains, swell its mountain tributaries; and also in the main to the melting of the winter snows in these lofty regions. About the middle of November the Euphrates has reached its lowest ebb, and ceasing to decrease, becomes tranquil and sluggish.

The Euphrates is, on many accounts, an object of more than ordinary interest. 'The great river' is linked with the earliest times and some of the most signal events in the history of the world. Appearing among the few notices we have of the first condition of the earth and of human kind, it continues, through the whole range of Scripture history down to the present hour, an object of curiosity, interest, wonder, hope, or triumph.

In ancient as well as in modern times the Euphrates was used for navigation. Herodotus states that boats—either coracles or rafts, floated by inflated skins—brought the produce of Armenia down to Babylon. The trade thus carried on was considerable.

The Emperor Trajan constructed a fleet in the mountains of Nisibis, and floated it down the Euphrates. The Emperor Julian also came down the river from the same mountains, with a fleet of not fewer than 1100 vessels.

A great deal of navigation is still carried on from Bagdad to Hillah, the ancient Babylon; but the disturbed state of the country prevents any above the latter place. In the time of Queen Elizabeth merchants from England went by this river, which was then the high road to India.

The prophets made use of the Euphrates as a figurative description of the Assyrian power, as the Nile with them represented the power of Egypt; thus in Isa. viii. 7, 'The Lord bringeth up upon them the waters of the river, strong and many, even the king of Assyria' (Jer. ii. 18). Wahl's *Asien*, p. 700; Ritter's *Erdk.* ii. 120; *Traité Élément. Géographique*, Bruxelles, 1832, vol. ii.; Mannert's *Geogr.* ii. 142; Reichard's *Kl. Geogr. Schrif.* p. 210; *Parliam. Rep. of Steam Navigation to India*, 1834.—J. R. B.

EUROCLYDON. [WINDS.]

EUTYCHUS (Εὐτυχός), a young man of Troas, who sat in the open window of the third floor while St. Paul was preaching late in the night, and who, being overcome by sleep, fell out into the court below. He was 'taken up dead' (ἤρθη νεκρός); but the Apostle, going down, extended himself upon the body and embraced it, like the prophets of old (1 Kings xvii. 21; 2 Kings iv. 34); and when he felt the signs of returning life, restored him to his friends, with the assurance that 'his life was in him.' Before Paul departed in the morning the youth was brought to him alive and well. It is disputed whether Eutyclus was really dead, or only in a swoon; and hence, whether a miracle was performed or not. It is admitted that the circumstances, and the words

of Paul himself, sanction the notion that the young man was not actually dead; but, on the other hand, it is contended that the words of the narrator, 'taken up dead,' are too plain to justify us in receiving them in the modified sense of 'taken up for dead,' which that interpretation requires (Acts xx. 5-12).

EXECRATION. The Greek word so rendered, *κατάρα*, occurs in Num. xxiii. 8; xxiv. 9; Josh. vi. 26; 1 Sam. xvii. 43. It is used also in profane authors to denote the imprecations which it was customary among ancient nations to pronounce upon their enemies for the purpose of calling down the divine wrath, branding them with infamy, and exciting against them the passions of the multitude. By this means they also devoted their enemies to the ruin they considered them to deserve. These imprecations were chiefly pronounced by priests, enchanters, or prophets [BALAAM]. The Athenians made use of them against Philip of Macedon. They convened an assembly, in which it was decreed that all statues, inscriptions, or festivals among them, in any way relating to him or his ancestors, should be destroyed, and every other possible reminiscence of him profaned; and that the priests, as often as they prayed for the success of the Athenian affairs, should pray for the ruin of Philip. It was also customary, both among the Greeks and Romans, after having destroyed cities in war, the revival of whose strength they dreaded, to pronounce execrations upon those who should rebuild them. Strabo observes that Agamemnon pronounced execrations on those who should rebuild *Troy*, as *Cresus* did against those who should rebuild *Sidena*; and this mode of execrating cities Strabo calls an ancient custom (κατὰ παλαιὸν ἔθος, xiii. p. 898, edit. 1707). The Romans published a decree full of execrations against those who should rebuild Carthage (Zonaras, *Annal.*). An incident somewhat analogous is related (Josh. vi. 26) after the taking of Jericho. From the words 'and Joshua adjured them at that time,' it is likely that he acted under a divine intimation that Jericho should continue in ruins, as a monument of the divine displeasure and a warning to posterity. The words 'cursed be the man (the individual) before the Lord that riseth up and buildeth this city Jericho,' although transformed into an execration by the word supplied by the translators, amount to no more than a prediction that 'he shall lay the foundation thereof in his first-born, and in his youngest son shall he set up the gates of it,' that is, he shall meet with so many impediments to his undertaking that he shall *out-live* all his children, *dying in the course of nature* before he shall complete it. Execrations were also pronounced upon cities and their inhabitants before undertaking a siege (Macrobius has preserved two of the ancient forms used in reference to the destruction of Carthage, *Saturnal.* iii. 9), and before engaging with enemies in war. Tacitus relates that the priestesses of ancient Britain devoted their Roman invaders to destruction, with imprecations, ceremonies, and attitudes, which for a time overwhelmed the soldiers with terror (*Annal.* xiv. 29). The execrations in the 83rd Psalm, probably written on the occasion of the confederacy against Jehoshaphat, and other instances of a like nature, partake of the execrations of the heathens in

nothing but form, being the inspired predictions or denunciations of divine vengeance against the avowed enemies of the God of Israel, notwithstanding the proofs they had witnessed of his supremacy; and the object of these imprecations, as in many other instances, is charitable, namely, their conversion to the true religion (ver. 18; see also Ps. lix. 12).—J. F. D.

EXILE. [CAPTIVITY.]

EXODUS. The intention of Jehovah to deliver the Israelites from Egyptian bondage was made known to Moses from the burning bush at Mount Horeb, while he kept the flock of Jethro, his father-in-law. Under the divine direction Moses, in conjunction with Aaron, assembled the elders of the nation, and acquainted them with the gracious design of Heaven. After this they had an interview with Pharaoh, and requested permission for the people to go, in order to hold a feast unto God in the wilderness. The result was, not only refusal, but the doubling of all the burdens which the Israelites had previously had to bear. Moses hereupon, suffering reproach from his people, consults Jehovah, who assures him that he would compel Pharaoh 'to drive them out of his land.' 'I will rid you out of their bondage, and I will redeem you with a stretched-out arm and with great judgments' (Exod. iii.-vi. 6). Then ensue a series of miracles, commonly called the plagues of Egypt (Exod. vi.-xii.) [PLAGUE]. At last, overcome by the calamities sent upon him, Pharaoh yielded all that was demanded, saying, 'Rise up, and get you forth from among my people, both ye and the children of Israel; and go serve the Lord as ye have said; also take your flocks and your herds, and be gone.' Thus driven out, the Israelites, to the number of about 600,000 adults, besides children, left the land, attended by a mixed multitude, with their flocks and herds, even very much cattle (Exod. xii. 31, 37). Being 'thrust out' of the country, they had not time to prepare for themselves suitable provisions, and therefore they baked unleavened cakes of the dough which they brought forth out of Egypt.

On the night of the self-same day which terminated a period of 430 years, during which they had been in Egypt, were they led forth from Rameses, or Goshen [GOSHEN]. They are not said to have crossed the river Nile, whence we may infer that Goshen lay on the eastern side of the river. Their first station was at Succoth (Exod. xii. 37). The nearest way into the Land of Promise was through the land of the Philistines. This route would have required them to keep on in a north-east direction. It pleased their divine conductor, however, not to take this path, lest, being opposed by the Philistines, the Israelites should turn back at the sight of war into Egypt. If, then, Philistia was to be avoided, the course would lie nearly direct east, or south-east. Pursuing this route, 'the armies' come to Eiham, their next station, 'in the edge of the wilderness' (Exod. xiii. 17, sq.). Here they encamped. Dispatch, however, was desirable. They journey day and night, not without divine guidance, for 'the Lord went before them by day in a pillar of a cloud, to lead them the way; and by night in a pillar of fire, to give them light; to go by day and night.' This special guidance could not well have been meant merely to show

the way through the desert; for it can hardly be supposed that in so great a multitude no persons knew the road over a country lying near to that in which they and their ancestors had dwelt, and which did not extend more than some forty miles across. The divine guides were doubtless intended to conduct the Israelites in that way and to that spot where the hand of God would be most signally displayed in their rescue and in the destruction of Pharaoh. 'I will be honoured upon Pharaoh and upon all his host, that the Egyptians may know that I am the Lord.' For this purpose Moses is directed of God to 'speak unto the children of Israel that they turn and encamp before Pi-hahiroth, between Migdol and the sea, over against Baal-zephon; before it shall ye encamp by the sea: and they did so' (Exod. xiv. 2-4). We have already seen reason to think that the direction of the Israelites was to the east or south-east; this turning must have been in the latter direction, else they would have been carried down towards the land of the Philistines, which they were to avoid. Let the word 'turn' be marked; it is a strong term, and seems to imply that the line of the march was bent considerably towards the south, or the interior of the land. The children of Israel then are now encamped before Pi-hahiroth, between Migdol and the sea, also 'by the sea.' Their position was such that they were 'entangled in the land, the wilderness hath shut them in.'

A new scene is now laid open. News is carried to Pharaoh which leads him to see that the reason assigned (namely, a sacrifice in the wilderness) is but a pretext; that the Israelites had really fled from his yoke; and also that, through some (to him) unaccountable error, they had gone towards the south-east, had reached the sea, and were hemmed in on all sides. He summons his troops and sets out in pursuit—all the horses and chariots of Pharaoh, and his horsemen and his army; and he 'overtook them encamping by the sea, beside Pi-hahiroth, before Baal-zephon' (Exod. xiv. 9). The Israelites see their pursuing enemy approach, and are alarmed. Moses assures them of divine aid. A promise was given as of God that the Israelites should go on dry ground through the midst of the sea; and that the Egyptians, attempting the same path, should be destroyed: 'and I will get me honour upon Pharaoh and all his host, upon his chariots and his horsemen' (ver. 17). Here a very extraordinary event takes place: 'The angel of God, which went before the camp of Israel, removed and went behind them; and the pillar of the cloud went from before their face and stood behind them; and it came between the camp of the Egyptians and the camp of Israel; and it was a cloud and darkness to them, but it gave light by night to these; so that the one came not near the other all the night' (ver. 19, 20). Then comes the division of the waters, which we give in the words of the sacred historian: 'And Moses stretched out his hand over the sea, and the Lord caused the sea to go back by a strong east wind all that night, and made the sea dry land, and the waters were divided. And the children of Israel went into the midst of the sea upon the dry ground; and the waters were a wall unto them on their right hand and on their left. And the Egyptians pursued and went in after them to the midst of the sea, even all Pharaoh's

horses, his chariots, and his horsemen.' Delays are now occasioned to the Egyptians; their chariot-wheels are supernaturally taken off, so that 'in the morning-watch they drive them heavily.' The Egyptians are troubled; they urge each other to fly from the face of Israel. 'Then Moses stretched forth his hand over the sea, and the sea returned to his strength when the morning appeared; and the Egyptians fled against it; and the Lord overthrew the Egyptians in the midst of the sea. And the waters returned and covered the chariots and the horsemen and all the host of Pharaoh that came into the sea after them; there remained not as much as one of them. But the children of Israel walked upon dry land in the midst of the sea, and the waters were a wall unto them on their right hand and on their left. And Israel saw the Egyptians dead upon the seashore; and the people feared the Lord, and believed the Lord and his servant Moses' (ver. 28-31). From the song of triumph which Moses sang upon this occasion we learn some other particulars, as that 'the depths covered Pharaoh's host, they sank to the bottom as a stone'; language which, whatever deduction may be made for its poetic character, implies that the miracle took place in deep water. 'Thou sentest forth thy wrath which consumed them as stubble, and with the blast of thy nostrils the waters were gathered together, the floods stood upright as an heap, and the depths were congealed in the heart of the sea; thou didst blow with thy wind, the sea covered them; they sank as lead in the mighty waters'—all which would be not poetry, but bombast, had not the wind been as miraculous as any other part of the event, and had not the sea been large and deep (Exod. xv.; comp. Ps. cvi. 9, sq.).

Such is the bearing and import of the sacred narrative. If any intelligent reader, knowing nothing of the theories of learned men, were to peruse the account given in Exodus with a map before him, he would, we doubt not, be led to conclude that the route of the Israelites lay towards the south-east, up the Red Sea, and that the spot where they crossed was at a place encircled by mountains on the side of the desert, and fronted by deep and impassable waters: he would equally conclude that the writer in Exodus intended to represent the rescue as from first to last the work of God. Had the Israelites been at a place which was fordable under any natural influences, Pharaoh's undertaking was absurd. He knew that they were entangled,—mountains behind and on either hand, while the deep sea was before them. Therefore he felt sure of his prey, and set out in pursuit. Nothing but the divine interposition foiled and punished him, at the same time redeeming the Israelites. And this view, which the unlearned but intelligent reader would be led to take, involves, in fact, all that is important in the case. But a dislike of the miraculous has had an influence, and erudition has tried to fix the precise spot: whence have arisen views and theories which are more or less discordant with the Scripture, or are concerned with comparative trifles. So far as aversion to miracle has had an influence in the hypotheses which have been given, all we shall remark is, that in a case which is so evidently represented as the sphere of miracle, there is but one alternative,—they who do not admit the miracle must reject the narrative; and far

better would it be to do so frankly than to construct hypotheses which are for the most part, if not altogether, purely arbitrary. A narrative obviously miraculous (in the intention of the writer) can be explained satisfactorily on no rationalistic principles: this is not to expound but to 'wrest' the Scriptures; a position which, in our opinion, has been fully established, in relation to the Gospels, against the whole of the rationalistic school of interpretation.

The account now given must, as being derived immediately from the Scripture, be in the main correct. If the authority is denied, this can be done effectually by no other means than by disproving in general the authority of the books whence it is derived; and it may with truth be affirmed, that no view opposed to that given can possess greater claims on our credit, while any mere sceptical opinion must rest on its own intrinsic probability, contested, so far as it opposes the Scripture, by scriptural authority.

When, however, we descend from generals to particulars, and attempt to ascertain precise localities and determine details, diversity of opinion may easily arise, and varying degrees of probability only are likely to attend the investigation. For instance, the immediate spot which Moses proposed to reach, was, we know, on the Red Sea; but the precise line which he took depended of course on the place whence he set out. With difference of opinion as to the spot where the Hebrews had their rendezvous, there cannot be agreement as to the route they followed.

The position of Goshen, where the Israelites were settled, we shall endeavour to fix in another article. It is enough here to say, that it was on the eastern side of the Nile, probably in the province of Esh-Shurkiyeh. Rameses was the place of rendezvous. The direct route thence to the Red Sea was along the valley of the ancient canal. By this way the distance was about thirty-five miles. From the vicinity of Cairo, however, there runs a range of hills eastward to the Red Sea, the western extremity of which, not far from Cairo, is named Jebel-Mokattem; the eastern extremity is termed Jebel-Attaka, which, with its promontory Ras Attaka, runs into the Red Sea. Between the two extremes, somewhere about the middle of the range, is an opening which affords a road for caravans. Two routes offered themselves here. Supposing that the actual starting point lay nearer Cairo, the Israelites might strike in from the north of the range of hills, at the opening just mentioned, and pursue the ordinary caravan road which leads from Cairo to Suez; or they might go southward from Mokattem, through the Wady el Tih, that is, the Valley of Wandering, through which also a road, though less used, runs to Suez. According to Niebuhr they took the first, according to ancient tradition, Father Sicard (*Ueber der Weg der Israeliten*, Paulus, *Samml.* v. 211, sq.), and others, they took the last. Sicard found traces of the Israelites in the valley. He held Rameses to be the starting point, and Rameses he placed about six miles from ancient Cairo, where Bezatin is now found. Here is a capacious sandy plain, on which Sicard thinks the Israelites assembled on the morning when they began their journey. In this vicinity a plain is still found, which the Arabs call the Jews' Cemetery, and where, from an indefinite period, the Jews have

buried their dead. In the Mokatem chain is a hill, a part of which is called Mejanat Musa, 'Moses' Station.' On another hill in the vicinity, ruins are found, which the Arabs name Meravad Musa, 'Moses' Delight.' Thus several things seem to carry the mind back to the time of the Hebrew legislator. Through the valley which leads from Bezatin (the Valley of Wandering) to the Red Sea, Sicard travelled in three days. He reckons the length to be twenty-six hours, which, if we give two miles to each hour (Robinson), would make the distance fifty-two miles. This length is also assigned by Girard (*Descrip. Topograp. de la Vallée de l'Egarement*). The valley running pretty much in a plain surface would afford a convenient passage to the mixed bands of Israelites. About eighteen miles from Bezatin you meet with Gendelyh, a plain with a fountain. The name signifies a military station, and in this Sicard finds the Succoth (tents) of Exodus, the first station of Moses. The haste with which they left (were driven out) would enable them to reach this place at nightfall of their first day's march. Sicard finds their second station, Etham, in the plain Kamliyeh, eighteen miles from Gendelyh and sixteen from the sea. From this plain is a pass, four miles in length, so narrow that not more than twenty men can go abreast. To avoid this, which would have caused dangerous delay, the order was given to turn (Exod. xiv. 2). Etham is said (Exod. xiii. 20) to be on the edge of the wilderness. Jablonski says the word means terminus maris, the termination or boundary of the sea. Now, in the plain where Sicard fixes Etham (not to be confounded with the Eastern Etham, through which afterwards the Israelites travelled three days, Num. xxxiii. 8), is the spot where the waters divide which run to the Nile and to the Gulf of Suez, and Etham is therefore truly *terminus maris*. Here the Israelites received command to turn and encamp (Exod. xiv. 2) before Pi-hahiroth, between Migdol and the sea, over against Baal-zephon. Pi-hahiroth (the mouth of the hiding-places) Sicard identifies with Thunak (small caves), which is the name still given to three or four salt springs of the plain Baideah, on the south side of mount Attaka, which last Sicard identifies with Baal-zephon, and which is the northern boundary of the plain Baideah, while Kuaibeh (Migdol) is its southern limit. The pass which leads to Suez, between Attaka and the sea, is very narrow, and could be easily stopped by the Egyptians. In this plain of Baideah, Pharaoh had the Israelites hemmed in on all sides. This then, according to all appearance, is the spot where the passage through the sea was effected. Such is the judgment of Sicard and of Raumer (*Der Zug der Israeliten*, Leipzig, 1837; for a description of the Valley of Wandering see also Ritter, *Erdkunde*, i. 588). It cannot be denied that this route satisfies all the conditions of the case. Equally does the spot correspond with the miraculous narrative furnished by holy writ. A different route is laid down by Niebuhr (*Arab.* p. 407). Other writers, who, like him, endeavour to explain the facts without the aid of miracle, imitate his example.

It is no small corroboration of the view now given from Sicard and Raumer, that in substance it has the support of Josephus, of whose account we shall, from its importance, give an abridg-

ment. The Hebrews, he says (*Antiq.* ii. 15), took their journey by Latopolis, where Babylon was built afterwards when Cambyzes laid Egypt waste. As they went in haste, on the third day they came to a place called Baal-zephon, on the Red Sea. Moses led them this way in order that the Egyptians might be punished should they venture in pursuit, and also because the Hebrews had a quarrel with the Philistines. When the Egyptians had overtaken the Hebrews they prepared to fight them, and by their multitude drove them into a narrow place; for the number that went in pursuit was 600 chariots, 50,000 horsemen, and 200,000 infantry, all armed. They also seized the passages, shutting the Hebrews up between inaccessible precipices and the sea; for there was on each side a ridge of mountains that terminated at the sea, which were impassable, and obstructed their flight. Moses, however, prayed to God, and smote the sea with his rod, when the waters parted, and gave the Israelites free passage. The Egyptians at first supposed them distracted; but when they saw the Israelites proceed in safety, they followed. As soon as the entire Egyptian army was in the channel, the sea closed, and the pursuers perished amid torrents of rain and the most terrific thunder and lightning.

The opposition to the scriptural account has been of two kinds. Some writers (Wolfenb. *Fragm.* p. 64, sq.) have at once declared the whole fabulous; a course which appears to have been taken as early as the time of Josephus (*Antiq.* ii. 16. 5). Others have striven to explain the facts by the aid of mere natural causes; for which see Winer, *Handwörterbuch*, in Meer Rother. A third mode of explanation is pursued by those who do not deny miracles as such, and yet, with no small inconsistency, seek to reduce this particular miracle to the smallest dimensions. Writers who see in the deliverance of the Hebrews the hand of God and the fulfilment of the divine purposes, follow the account in Scripture implicitly, placing the passage at Ras Attaka, at the termination of the Valley of Wandering; others, who go on rationalistic principles, find the sea here too wide and too deep for their purpose, and endeavour to fix the passage a little to the south or the north of Suez.

The most recent advocate of the passage at or near Suez is the learned Dr. Robinson (*Biblical Researches in Palestine*), from whom we hesitate to differ, and should hesitate still more, did not his remarks bear obvious traces of being, however the author may be ignorant of the fact, influenced, if not dictated, by some foregone conclusion and certain rationalistic habits of mind. While, however, we pay every proper tribute of respect to Dr. Robinson's learning and diligence, we must prefer the authority of Scripture and the obvious facts of the case to all other considerations. The route taken by Moses was, according to Robinson, from Rameses to the head of the Arabian Gulf, through Succoth, to Etham. The last place he fixes on the edge of the desert, on the eastern side of the line of the gulf. Instead of passing down the eastern side, at the top of which they were, the Israelites thence marched down the western side of the arm of the gulf, stopping in the vicinity of Suez, where the passage was effected.

This view represents Moses as having actually conducted his people first out of all danger, and then led them at once into it, by placing the gulf between them and safety. Such a proceeding ill became a prudent leader having to do with a self-willed and stiff-necked band. But the chief objection to this representation of the route is, that it does not answer to what Scripture requires; for in Exod. xiii. 18, we are told that 'God led the people about through the wilderness of the Red Sea.' How, according to Robinson, did he 'lead them about,' especially 'through the wilderness of the Red Sea,' which they must merely have touched upon?

The passage Robinson thinks took place 'across shoals adjacent to Suez on the south and south-west,' 'where the broad shoals are still left bare at the ebb, and the channel is sometimes forded,' 'a distance of three or four miles from shore to shore;' or 'it might have been effected through the arm of the gulf above Suez.' A simple reference to the language of Scripture previously cited confutes this supposition; for where, in or near this place, are the deep waters of which Moses speaks? Besides, is it for a moment to be supposed that Pharaoh was not well acquainted with the tides of a sea which lay so near his capital? and would he have been so infatuated as to remain quietly in his position (for the Scripture shows that the two armies were some time in sight of each other) until the Israelites had availed themselves of the ebb, and then, when the flood came, quietly go into the sea and be destroyed? In order to help out his hypothesis, conscious, apparently, that the body of water here was insufficient, Dr. Robinson advances a supposition (but for suppositions his view would look as groundless as it really is), namely, that with the flood-tide the wind was changed. But a perusal of his scriptural reference (Exod. xv. 8-10) shows that this alleged change is without evidence—a pure supposition: the language in the 8th verse has respect to the wind which divided the sea; and the language in the 10th verse in no way implies any change of direction whatever; the same wind, in the hand of God, could both divide and close the sea.

The great question, however, is *the cause* or instrument employed in securing the Israelites a passage on dry ground, and overwhelming the Egyptians. On this point we complain of a want of explicitness in Dr. Robinson. He does not deny a miracle, but blends together the miraculous and the natural, so as to confuse his own and his reader's mind. 'It (the miracle) was wrought by natural means supernaturally applied.' A north-east wind was brought of God to act on the water as the sea was ebbing, which gave a dry passage to the Israelites. We are therefore 'to look only for the natural effects arising from the operation of such a cause.' The sole causes then in the case were a north-east wind, the ebb-tide, the flood, and a change of wind to aid the action of the flood. Of these causes, the last, the change of wind, is, as we have seen, a gratuitous assumption. From 'north-east wind' we must strike out 'north,' as being another gratuitous assumption—it is 'a strong east wind' of which Moses speaks. An east wind, however, would by no means effect the purposes useful for Dr. Robinson's hypothesis. Of his remaining causes, the

ebb and flood tide, enough has already been said; and, so far as an east wind, acting *naturally*, would have an effect, it would drive the waters upon the shallows, which Dr. Robinson wants dry. But we much question whether his assumed 'north-east wind' would cause what he requires. It would, he alleges, 'have the effect to drive out the waters from the small arm of the sea which runs up by Suez, and also from the end of the gulf itself, leaving the shallower portions dry, while the more northern part of the arm, which was anciently broader and deeper than at present, would still remain covered with water. Thus the waters would be divided, and be a wall to the Israelites on the right hand and on the left.' We desire the reader to consult the map appended to Dr. Robinson's first volume. While considering the hypothesis in question, he must remember that the action of ebb and flood tide rests on no better ground than an assumption; the Scripture says nothing thereof. Now a wind setting in at the head of the gulf would commence its influence of course at the end of the arm which runs up to the east of Suez, and would, so far as it acted, bear down the waters from the top towards the very place which the hypothesis requires to be dry, namely, the head of the gulf, thus covering the shallows. But if, to avoid this difficulty, Dr. Robinson fixes the passage in the arm itself, then how could a wind, acting on the waters in the arm, 'divide' them? Drive them out, scatter them to some extent, it might, but surely not divide them. Nor does Dr. Robinson secure by his other supposition, namely, the passage over the shallows, such a division as the Scripture requires. Supposing the effect which he contemplates to be produced, then there would be on the north side of the shallows so much of the sea as the wind had left in the arm, and so much of the sea as lingered under its driving impulse on the south side of the shallows. With this in his mind let the reader peruse the scriptural account, 'the waters were a wall to them on the right hand and on the left.' By Dr. Robinson's account there was no wall at all, but such a state of the sea and land as would render the choice of the language employed by Moses most inappropriate. In truth, however, the east wind of which Moses speaks was precisely the influence to bring about the effect which he alleges to have taken place. Acting on the sea at a right angle it would literally divide the waters, causing the mid-way to be dry, and a wall to stand on either side. Such obviously is the view which Moses intended to give. In endeavouring to define and estimate the action of this east wind, however, it must be borne in mind that the Scripture represents the entire affair as miraculous. It was from first to last 'the hand of the Lord,'—the east wind and its action, as much as the collapse of the sea. The east wind, indeed, is also termed 'the blast of thy nostrils;' and so 'thou didst blow with thy wind, the sea covered them.'

The miraculous character of the transaction, as affirmed in Scripture, takes all point from the question of time, which Dr. Robinson says is fatal to the alternative hypothesis, namely, that the Israelites crossed from Wady Tawarik; since there is no occasion, in order to sustain the narrative of Moses, to calculate whether the interval

between the ebb and the flow of the tide afforded sufficient time for the Israelites to cross the bed of the sea, a distance of twelve geographical miles. The passage did not depend on ebb or flow. It was not a question of mere time. The right hand of the Lord was at work.

It appears then very clear, by comparing Dr. Robinson with Moses and with facts, that his 'extraordinary ebb, brought about by natural means,' could not have produced such a state of things as he supposes, still less such a state of things as the miracle requires. The only resource is to deny the miracle, and disown the entire account. If this bold course is declined, then the passage at Suez or across the arm must be given up in favour of one lying far more to the south.

These strictures on Dr. Robinson's hypothesis are in no way prompted by any previous leaning to a preference in favour of the passage at Ras Attaka, for they were penned exclusively under the influence of the scriptural narrative. And if authority is needed as against one who has been on the spot, what has already been given from Sicard might be deemed sufficient, especially when it so obviously agrees with the tenor of the accounts found in Exodus and in Josephus. But other witnesses are not wanting. Mr. Blumhardt, in his missionary visit to Abyssinia, passed through Suez (Oct. 1836, see *Church Missionary Record*, No. 1, Jan. 1838), and furnishes some remarks on the subject. 'The Red Sea at Suez is exceedingly narrow, and in my opinion it cannot be that the Israelites here experienced the power and love of God in their passage through the Red Sea. The breadth of the sea is at present scarcely a quarter of an hour by Suez. Now if this be the part which they crossed, how is it possible that all the army of Pharaoh, with his chariots, could have been drowned? I am rather inclined to believe that the Israelites experienced that wonderful deliverance about thirty miles lower down. This opinion is also strengthened by most of the Eastern churches, and the Arabs, who believe that the Israelites reached the opposite shore at a place called Gebel Pharaon, which on that account has received this name. If we accept this opinion, it agrees very well with the Scripture.' Still more important is the evidence of Dr. Olin (*Travels in the East*, New York, 1843). Many of his remarks we have anticipated in our observations on Robinson. Dr. Olin, however, agrees with Robinson in fixing Etham 'on the border of the wilderness which stretches along the eastern shore of the arm of the sea which runs up above Suez.' At this point he says the Hebrews were commanded to turn. They turned directly southward and marched to an exposed position, hemmed in completely by the sea, the desert, and Mount Attaka. A false confidence was thus excited in Pharaoh, and the deliverance was made the more signal and the more impressive alike to the Israelites and to Egypt. Admitting the possibility that the sea at Suez may have been wider and deeper than it is now, Olin remarks, 'it must still have been very difficult, if not impossible, for the army of Israel, encumbered with infants and aged people, as well as with flocks, to pass over (near Suez) in the face of their enemies' (i. 346). Besides, the peculiarities of the place must have had a ten-

dency to disguise the character and impair the effect of the miracle. The passage made at the intervention of Moses was kept open all night. The Egyptians followed the Hebrews to the *midst of the sea*, when the sea engulfed them. 'The entire night seems to have been consumed in the passage. It is hardly credible that so much time should have been consumed in crossing near Suez, to accomplish which one or two hours would have been sufficient.' 'Nor is it conceivable that the large army of the Egyptians should have been at once within the banks of so narrow a channel. The more advanced troops would have reached the opposite shore before the rear had entered the sea; and yet we know that all Pharaoh's chariots and horsemen followed to the *midst of the sea*, and, together with all the host that came in after them, were covered with the returning waves' (i. 348). Preferring the position at Ras Attaka, Olin states that the gulf is here ten or twelve miles wide. 'The valley expands into a considerable plain, bounded by lofty precipitous mountains on the right and left, and by the sea in front, and is sufficiently ample to accommodate the vast number of human beings who composed the two armies.' 'An east wind would act almost directly across the gulf. It would be unable to co-operate with an ebb tide in removing the waters—no objection certainly if we admit the exercise of God's miraculous agency;' but a very great impediment in the way of any rationalistic hypothesis. 'The channel is wide enough to allow of the movements described by Moses, and the time, which embraced an entire night, was sufficient for the convenient march of a large army over such a distance.' 'The opinion which fixes the point of transit in the valley or wady south of Mount Attaka derives confirmation from the names still attached to the principal objects in this locality. Upon this point I acknowledge my obligations to the Rev. Mr. Leider, of Cairo, who has spent more than ten years in Egypt, is familiar with the Arabic language, and has devoted much attention to this vexed question. He recently spent several days in this neighbourhood in making investigations and inquiries in reference to the passage of the Israelites. Jebel Attaka, according to Mr. Leider, who only confirms the statements of former travellers, means in the language of the Arabs "the Mount of Deliverance." Baideah or Bedeah, the name of this part of the valley, means "the Miraculous," while Wady el Tih means "the Valley of Wanderings." Pihahiroth, where Moses was commanded to encamp, is rendered by scholars "the mouth of Hahiroth," which answers well to the deep gorge south of Attaka, but not at all to the broad plain about Suez' (i. 350).

Other parts of the line of march pursued by the Israelites will be found treated of under the heads MANNA, SINAI, WANDERING.—J. R. B.

EXODUS (Gr. Ἐξοδος, in the Hebrew canon מִצְרַיִם וְאֶרֶץ מִצְרַיִם), the second book of Moses, so called from the principal event recorded in it, namely, the departure of the Israelites from Egypt. With this book begins the proper history of that people, continuing it until their arrival at Sinai, and the erection of the sanctuary there. It transports us in the first instance to Egypt, and the quarter in

which the Israelites were domiciled in that country. We do not find in the Pentateuch a real history of the people of Israel during this period. Such a history, in the more strict acceptation of the term, has no place in an historical sketch of the kingdom of God, where the mere description of the situation and condition of the people is all that is requisite. From that description we learn satisfactorily how the people of the Lord were negatively prepared for the great object which God had decreed with regard to them. This is the important theme of the history of the Pentateuch during the whole long period of four hundred years. Exodus is very circumstantial in its account of the life of Moses, which, instead of partaking of the character of usual biography, manifests in all its details a decided aim of evincing how, by the miraculous dispensation of the Lord, Moses had been even from his earliest years prepared and reared to become the chosen instrument of God. In this book is developed, with particular clearness, the summons of Moses to his sacred office, which concludes the first important section of his life (Exod. i.-vi.). No human choice and no self-will, but an immediate call from Jehovah alone, could decide in so important an affair. Jehovah reveals himself to him by his covenant-name (יהוה), and vouchsafes him the power to work miracles such as no man before him had ever wrought. It was not the natural disposition and bent of his mind that induced Moses to accept the office, but solely his submission to the express will of God, his OBEEDIENCE alone, that influenced him, the LAWGIVER, to undertake the mission. The external relation of Moses to his people is also clearly defined (comp. *ex. gr.* Exod. vi. 14, sq.). This furnishes the firm basis on which is founded his own as well as Aaron's personal authority, and the respect for his permanent regulations. A new section (vii.-xv.) then gives a very detailed account of the manner in which the Lord glorified himself in Israel, and released the people from the land of bondage. This forms a turning-point in the narrative—with it begins the real history of the people of God. Every day affords here an eternal demonstration of divine grace, justice, and majesty. The relation of the theocracy to heathenism, the representative of which is Egypt, is here illustrated by facts. The history contained in Exodus may very fairly be described as the history of the triumph of Israel, or rather of Israel's God, over the heathen power, which appears here in its innermost spirit of revolt against God. The world is conquered progressively and with increased force; and the passover manifests on the one hand the annihilation of worldly power, while on the other hand it is the celebration of the birth-day of the people of God. This section of the history then concludes with a triumphal song, celebrating the victory of Israel. In ch. xvi.-xviii. we find the introduction to the second principal part of this book, in which is sketched the manifestation of God in the midst of Israel, as well as the promulgation of the law itself, in its original and fundamental features. This preparatory section thus furnishes us with additional proof of the special care of God for his people; how he provided their food and water, and how he protected them from the assaults of their foes. In ch. xv. 22, sq., not all, but only the remarkable resting-places are mentioned, where

Jehovah took special care of his people. In the account (xviii.) of the civil regulations framed by the advice of Jethro, a strong line of demarcation is drawn between the changeable institutions of man and the divine legislation which began then to be established, and which thenceforth claims by far the greatest part of the work. At the commencement of the legislation is a brief summary of the laws, with the decalogue at their head (xix.-xxiii.). The decalogue is the true fundamental law, bearing within itself the germ of the entire legislation. The other legal definitions are only further developments of the decalogue. These definitions manifest the power and extent of the law itself, showing what an abundance of new regulations result from the simple and few words of the decalogue. Upon this basis the covenant is concluded with the Israelites, in which God reveals himself in agreement with the understanding and the exigencies of the people. Not until this covenant was completed did it become possible for the Israelites to enter into a communion with God, confirmed and consecrated by laws and offerings, and thereby to receive further revelations from him (ch. xxiv.). Whatsoever after this, in the twenty-fifth and in the following chapters, is communicated to the people, concerns the dwelling of God in the midst of Israel. By this dwelling of God among Israel it is intended to show, that the communion is permanent on the part of God, and that on the part of the people it is possible to persevere in communion with God. Consequently there follows the description of the sanctuary, the character of which is symbolical. The sacred symbols are, however, not so much expressed in formal declarations, as contained in the whole tenor of the descriptions. The symbolics begin with the central point, the holy of holies, which unites in itself the impeaching law and the redeeming symbol of divine mercy, and thus sets forth the reconciliation of God with the people. This is followed by the description of the sanctuary, representing those blessings which through the holy of holies were communicated to the subjects of the theocracy, and serving as a perpetual monument of Israel's exalted destiny, pointing at the same time to the means of attaining it. Last comes the description of the fore-court, symbolising the participation of the people in those blessings, and their sanctified approach to the Lord. The description then proceeds from the sanctuary to the persons officiating in it, the priests, characterized both by their various costumes (xxviii.), and the manner of their inauguration (xxix.). Then follows, as a matter of course, the description of the service in that sanctuary and by those priests, but merely in its fundamental features, confining itself simply to the burnt and incense offerings, indicating by the former the preparatory inferior service, and by the latter the complete and higher office of the sacerdotal function. But, by contributing to the means of establishing public worship, the whole nation shares in it; and therefore the description of the officiating persons very properly concludes with the people (xxx.). As a suitable sequel to the former follows the description of the use and nature of the implements requisite for the service of the priests, such as the brass laver for sacred ablutions, the preparation of the perfume and anointing oil (xxx. 17-38). These regulations being made, men endowed with the Spirit of God

were also to be appointed for making the sacred tabernacle and all its furniture (xxx. 1-2). The description of the sanctuary, priesthood, and mode of worship, is next followed by that of the sacred times and periods (xxxi. 12, sq.). Of the sacred times there is here only appointed the Sabbath, in which the other regulations are contained as in their germ. God having delivered to Moses the tables of the law, the construction and arrangement of the tabernacle might thus at once have been begun, had its further progress not been interrupted by an act of idolatry on the part of the people, and their punishment for that offence, which form the subject of the narrative in ch. xxxii.-xxxiv. Contrary and in opposition to all that had been done by Jehovah for and in the presence of Israel, the subjective formidable apostasy of the latter manifests itself in a most melancholy manner, as an ominously significant prophetic fact, which is incessantly repeated in the history of subsequent generations. The narrative of it is therefore closely connected with the foregoing accounts—Jehovah's mercy and gracious faithfulness on the one hand, and Israel's barefaced ingratitude on the other, being intimately connected. This connection forms the leading idea of the whole history of the theocracy. It is not till after the narrative of this momentous event that the account of the construction and completion of the tabernacle can proceed (xxxv.-xl.), which account becomes more circumstantial in proportion as the subject itself is of greater importance. Above all, it is faithfully shown that all was done according to the commands of Jehovah.

In the descriptive history of Exodus a fixed plan, in conformity with the principles above stated, is consistently and visibly carried through the whole of the book, thus giving us the surest guarantee for the unity of both the book and its author. In vain have several modern critics attempted to discover here also sundry sources and manifold original documents, or even fragments, but loosely connected with each other (comp. *ex. gr.* De Wette, *Introd. to the Old Testament*, § 151). Such an assumption proves in this case in particular to be nothing more than a last resource of argument against the Mosaic composition of the book. De Wette has of late been induced, in favour of this hypothesis, to declare that in some portions of Exodus the source is uncertain, and that there took place a mixture of both sources, the Mosaic and the non-Mosaic (comp. *PENTATEUCH*). Nor are other modern critics more successful in their attempts to show in this book traces of a post-Mosaic origin. Among the passages quoted in support of that assertion is xxiii. 9, the law contained in which seems to imply a later state of the people during their settled abode in Palestine. Regulations about strangers were, however, of importance during their abode in the desert, especially since a number of Egyptians had joined the Israelites, and stood to them in the relation of strangers. Chap. xvi. 36, also, is quoted in favour of the above opinion, because the *omer* is designated therein as the tenth part of an *ephah*, implying that changes had in later times been made in the Hebrew measures. But they forget that the Hebrew word מֶדֶה does not at all indicate a definite measure, but merely a vessel, the size of which it was therefore neces-

sary to specify by giving its exact measurement. In vi. 26, 27, also, they think they recognise the hand of a later author, who refers to Moses and Aaron, and describes their character. The least attention, however, to the preceding genealogy, and the descriptive style of the Pentateuch in general, must soon convince them that even a contemporary writer might have spoken in the way which Moses does in these passages.

For neological criticism it was of the utmost importance to stamp this book as a later production, the miracles contained in its first part but too manifestly clashing with the principles in which that criticism takes its starting-point. Its votaries therefore have endeavoured to show that those miracles were but mythological fictions which had been gradually developed in process of time, so that the very composition of the book itself must necessarily have been of a later date. Neither do we wonder at such attempts and efforts, since the very essence and central point of the accounts of the miracles given in that book are altogether at variance with the principles of rationalism and its criticism, which can by no means admit the rise and formation of a people under such miraculous circumstances, such peculiar belief, and, in a religious point of view, such an independent existence, at the side of all the other nations of antiquity. Indeed, the spiritual substance of the whole, the divine idea which pervades and combines all its details, is in itself such a miracle, such a peculiar and wondrous phenomenon, as to lend natural support and undeniable confirmation to the isolated and physical wonders themselves; so that it is impossible to deny the latter without creating a second and new wonder, an unnatural course in the Jewish history. Nor is that part of the book which contains the miracles deficient in numerous historical proofs in verification of them. As the events of this history are laid in Egypt and Arabia, we have ample opportunity of testing the accuracy of the Mosaic accounts, and surely we find nowhere the least transgression against Egyptian institutions and customs; on the contrary, it is most evident that the author had a thorough knowledge of the Egyptian institutions and the spirit that pervaded them. Exodus contains a mass of incidents and detailed descriptions which have gained new force from the modern discoveries and researches in the field of Egyptian antiquities (comp. Hengstenberg, *Die Buches Mosis und Aegypten*, Berlin, 1841). The description of the passage of the Israelites through the desert also evinces such a thorough familiarity with the localities as to excite the utmost respect of scrupulous and scientific travellers of our own time for the authenticity of the Pentateuch (comp. *ex. gr.* Raumer, *Der Zug der Israeliten aus Aegypten nach Canaan*, Leipz. 1837). Nor is the passover-festival, its rise and nature, less confirmatory of the incidents connected with it, if we have not recourse to the desperate expedient—as rationalistic criticism really does—of ascribing to that festival a quite different signification originally, namely, a purely physical one, an opinion which brings its advocates in conflict with the whole of the Israelitish history. The arrangements of the tabernacle, described in the second part of Exodus, likewise throw a favourable light on the historical authenticity of the preceding events; and the

least tenable of all the objections against it are, that the architectural arrangements of the tabernacle were too artificial, and the materials and richness too costly and precious for the condition and position of the Jews at that early period, &c. But the critics seem to have overlooked the fact that the Israelites of that period were a people who had come out from Egypt, a people possessing wealth, Egyptian culture and arts, which we admire even now, in the works which have descended to us from ancient Egypt; so that it cannot seem strange to see the Hebrews in possession of the materials or artistical knowledge requisite for the construction of the tabernacle. Moreover, the establishment of a TENT as a sanctuary for the Hebrews can only be explained from their abode in the desert, being in perfect unison with their then roving and nomadic life; and it is therefore a decided mistake in those critics who give to the sacred tent a later date than the Mosaic; while other critics (such as De Wette, Von Bohlen, Vatke) proceed much more consistently with their views, by considering the narrative of the construction of a sacred tabernacle to be a mere fiction in Exodus, introduced for the purpose of ascribing to the temple of Solomon a higher antiquity and authority. However, independently of the circumstance that the temple necessarily presupposes the existence of a far older analogous sanctuary, the whole process of such a forced hypothesis is but calculated to strike out a portion from the Jewish history on purely arbitrary grounds. The extremely simple and sober style and views throughout the whole narrative afford a sure guarantee for its authenticity and originality. Not a vestige of a poetical hand can be discovered in Exod. xviii.; not even the most sceptical critics can deny that we tread here on purely historical ground. The same may fairly be maintained of ch. xx.-xxiii. How is it then possible that one and the same book should contain so strange a mixture of truth and fiction as its opponents assert to be found in it? The most striking proofs against such an assumption are, in particular, the accounts, such as in Exod. xxxii. sq., where the most vehement complaints are made against the Israelites, where the high-priest of the covenant-people participates most shamefully in the idolatry of his people. All these incidents are described in plain and clear terms, without the least vestige of later embellishments and false extolling of former ages. The Pentateuch, some critics assert, is written for the interest and in favour of the hierarchy; but can there be more anti-hierarchical details than are found in that book? The whole representation indicates the strictest impartiality and truth. On the literature of Exodus, see PENTATEUCH.—

H. A. C. H.

EXORCISM AND EXORCIST (ἔξορκιστής, Acts xix. 13). The belief in demoniacal possessions, which may be traced in almost every nation, has always been attended by the professed ability, on the part of some individuals, to release the unhappy victims from their calamity. In Greece men of no less distinction than both Epicurus (Diog. Laer. x. 4) and Æschines, were sons of women who lived by this art; and both were bitterly reproached, the one by the Stoics, and the other by his great rival orator Demosthenes (*De Cor.*), for having assisted their parents in these

practices. The allusions to the practice of exorcism among the Jews, contained both in their own authors and in the New Testament, are too well known to render quotations necessary. In some instances this power was considered as a divine gift; in others it was thought to be acquired by investigations into the nature of demons and the qualities of natural productions, as herbs, stones, &c., and of drugs compounded of them; by the use of certain forms of adjurations, invocations, ceremonies, and other observances. Indeed the various forms of exorcism, alluded to in authors of all nations, are innumerable, varying from the bloody human sacrifice down to the fumes of brimstone, &c. &c. The power of expelling demons Josephus places among the endowments of Solomon, and relates that he left behind him the manner of using exorcisms by which they drive away demons (for the pretended fragments of these books see Fabric. *Cod. Pseud. Vet. Test.* p. 1054). He declares that he had seen a man, named Eleazar, releasing people that were demoniacal, in the presence of Vespasian, his sons, captains, and the whole multitude of his soldiers. He describes the manner of cure thus: 'He put a ring that had a root of one of those sorts mentioned by Solomon to the nostrils of the demoniac; after which he drew out the demon through his nostrils, and when the man fell down he adjured him to return no more, making still mention of Solomon and reciting the incantations he composed.' He further adds, that when Eleazar would persuade and demonstrate to the spectators that he had such a power, he set a cup or basin full of water a little way off, and commanded the demon as he went out of the man to overturn it, and thereby to let the spectators know he had left the man (*Antiq.* viii. 2. § 5). He also describes the mode of obtaining the root Baaras, which, he says, 'if it be only brought to sick persons, it quickly drives away the demons,' under circumstances which, for their strangeness, may vie with any prescription in the whole science of exorcism (*De Bell. Jud.* vii. 6. § 3). Among all the references to exorcism, as practised by the Jews, in the New Testament (Matt. xii. 27; Mark ix. 38; Luke ix. 49, 50), we find only one instance which affords any clue to the means employed (Acts xix. 13); from which passage it appears that certain professed exorcists took upon them to call over a demoniac the name of the Lord Jesus, saying, 'We adjure you by Jesus whom Paul preacheth.' Their proceeding seems to have been in conformity with the well-known opinions of the Jews in those days, that miracles might be wrought by invoking the names of the Deity, or angels, or patriarchs, &c., as we learn from Justin Martyr, Irenæus, Origen, &c., and Lucian (*Frag.* p. 141). The epithet applied to these exorcists (περιερχομένων, Vulg. *de circumventibus Judeis*) indicates that they were travelling mountebanks, who, beside skill in medicine, pretended to the knowledge of magic. It is evident that the opinion we form of exorcism will be materially affected by our views of demoniacal possessions [DEMON]. The neutral course we have pursued in regard to both these subjects will be completed upon observing, that the office of the exorcist is not mentioned by Paul in his enumeration of the miraculous gifts (1 Cor. xii. 9), though it was a power which he possessed himself, and which the Saviour had promised

(Mark vi. 17; Matt. x. 8). Mosheim says that the particular order of exorcists did not exist till the close of the third century, and he ascribes its introduction to the prevalent fancies of the Gnostics (*Cen.* iii. 11, c. 4). Fairness also induces us to notice Jahn's remark upon the *silence* of St. John himself, in his Gospel, on the subject of possessions, although he introduces the *Jews* as speaking in the customary way respecting demons and demoniacal possessions, and although he often speaks of the sick who were healed by the Saviour; coupled with the fact that John wrote his Gospel in Asia Minor, where *medical science* was very flourishing and where it was generally known that the diseases attributed to demons were merely natural diseases (Jahn, *Archæol.*, large German ed. pt. i. vol. ii. 232. pp. 477-480; see also Lomeirus, *De Vet. Gent. Lustra.*; Bekker, *Le Monde enchanté*; Whitby's note on Matt. xii. 27).—J. F. D.

EXPIATION. [ATONEMENT; SACRIFICE.]

EXPIATION, DAY OF. [ATONEMENT, DAY OF.]

EYE (עַיַן). In most languages this important organ is used by figurative application, as the symbol of a large number of objects and ideas. In the East such applications of the word 'eye' have always been uncommonly numerous; and they were so among the Hebrews. It may be serviceable to distinguish the following uses of the word, few of which are common in this country, unless so far as they have become so through the translation of the Bible.

1. *A fountain.* This use of the word has already been indicated [AİN]. It probably originated from the eye being regarded as the fountain of tears.

2. *Colour,* as in the phrase 'and the eye (colour) of the woman was as the eye (colour) of bdellium' (Num. xi. 7). This originated perhaps in the eye being the part of the body which exhibits different colours in different persons.

3. *The surface,* as 'the surface (eye) of the land' (Exod. x. 5, 15; Num. xxii. 5, 11); the last is the passage which affords most sanction to the notion that עַיַן *ain* means in some places 'face.' This is the sense which our own and other versions give to 'eye to eye' (Num. xiv. 14, &c.), translated 'face to face.' The phrases are indeed equivalent in meaning; but we are not thence to conclude that the Hebrews meant 'face' when they said 'eye,' but that they chose the opposition of the eyes, instead of that of the faces, to express the general meaning. Hence, therefore, we may object to the extension of the signification in such passages as 1 Sam. xvi. 12, where 'beautiful eyes' פְּהַ עֵינַיִם is rendered 'fair countenance.'

4. It is also alleged that 'between (or about) the eyes' means the forehead, in Exod. xiii. 9, 16, and the forepart of the head, in Deut. vi. 8; but the passages are sufficiently intelligible if understood to denote what they literally express; and with reference to the last it may be remarked that there is hair about the eyes as well as on the head, the removal of which might as well be interdicted as an act of lamentation.

5. In Cant. iv. 9, 'eye' seems to be used poetically for 'look,' as is usual in most languages;

'Thou hast stolen my heart with one of thy looks' (eyes).

6. In Prov. xxiii. 31, the term 'eye' is applied to the beads or bubbles of wine, when poured out, but our version preserves the sense of 'colour.'

To these some other phrases, requiring notice and explanation, may be added:

'Before the eyes' of any one, meaning in his presence; or, as we should say, 'before his face' (Gen. xxiii. 11, 18; Exod. iv. 30).

'In the eyes' of any one, means what appears to be so or so in his individual judgment or opinion; and is equivalent to 'seeming' or 'appearing' (Gen. xix. 8; xxix. 20; 2 Sam. x. iii).

'To set the eyes' upon any one, is usually to regard him with favour (Gen. xlv. 21; Job xxiv. 23; Jer. xxxix. 12); but it occurs in a bad sense, as of looking with anger, in Amos ix. 8. But anger is more usually expressed by the contrary action of turning the eyes away.

As many of the passions, such as envy, pride, pity, desire, are expressed by the eye; so, in the Scriptural style, they are often ascribed to that organ. Hence such phrases as 'evil eye' (Matt. xx. 15); 'bountiful eye' (Prov. xxii. 9); 'haughty eyes' (Prov. vi. 17); 'wanton eyes' (Isa. iii. 16); 'eyes full of adultery' (2 Pet. ii. 14); 'the lust of the eyes' (1 John ii. 16). This last phrase is applied by some to lasciviousness, by others to covetousness; but it is best to take the expression in the most extensive sense, as denoting a craving for the gay vanities of this life (Comp. Ezek. xxiv. 25). In the same chapter of Ezekiel (ver. 16), 'the desire of thy eyes' is put not for the prophet's wife directly, as often understood, but for whatever is one's greatest solace and delight; which in this case was the prophet's wife—but which in another case might have been something else.

In Zech. iv. 10, the angels of the Lord are called 'his eyes,' as being the executioners of his judgments, and watching and attending for his glory. From some such association of ideas, the favourite ministers of state in the Persian monarchy were called 'the king's eyes.' So, in Num. x. 31, 'to be instead of eyes' is equivalent to being a prince, to rule and guide the people. This occurs also in the Greek poets, as in Pindar (*Olymp.* ii. 10), where 'the eye of Sicilia' is given as a title to one of the chief men in Sicily, showing his power. In like manner, in the same poet, 'the eye of the army' stands for a good commander (*Olymp.* vi. 16).

The expression in Psalm cxxiii. 2, 'As the eyes of servants look unto the hands of their masters,' has suggested a number of curious illustrations from Oriental history and customs, tending to show that masters, especially when in the presence of others, are in the habit of communicating to their servants orders and intimations by certain motions of their hands, which, although scarcely noticeable by other persons present, are clearly understood and promptly acted upon by the attendants. This custom keeps them with their attention bent upon the hand of their master, watching its slightest motions.

The celebrated passage 'Why beholdest thou the mote that is in thy brother's eye, and considerest not the beam that is in thine own eye' (Matt. vii. 3), has occasioned much waste of ex

planation. It seems much better to understand it as a hyperbolic proverbial expression, than to contend that as *δωκός* cannot literally mean 'a beam,' it must here signify something else, a disease, a thorn, &c. (see Doddridge and Campbell, *in loc.*). As a proverbial phrase, parallels have been produced abundantly from the Rabbins, from the fathers, and from the classics.

Respecting blinding the eyes as a punishment, or political disqualification, see PUNISHMENT.

'PAINTING THE EYES,' or rather the eyelids, is more than once alluded to in Scripture, although this scarcely appears in the Authorized Version, as our translators, unaware of the custom, usually render 'eye' by 'face,' although 'eye' is still preserved in the margin. So Jezebel 'painted her eyes,' literally, 'put her eyes in paint,' before she showed herself publicly (2 Kings ix. 30). This action is forcibly expressed by Jeremiah (iv. 30), 'though thou retest thine eyes with painting.' Ezekiel (xxiii. 40) also represents this as a part of high dress—'For whom thou didst wash thyself, *paintedst thy eyes*, and deckedst thyself with ornaments.' The custom is also, very possibly, alluded to in Prov. vi. 25—'Lust not after her beauty in thine heart, neither let her take thee *with her eyelids*.' It certainly is the general impression in Western Asia that this embellishment adds much to the languishing expression and seducement of the eyes, although Europeans find some difficulty in appreciating the beauty which the Orientals find in this adornment.



285.

The following description of the process is from Mr. Lane's excellent work on the *Modern Egyptians* (i. 41-43): 'The eyes, with very few exceptions, are black, large, and of a long almond form, with long and beautiful lashes and an exquisitely soft, bewitching expression: eyes more beautiful can hardly be conceived: their charming effect is much heightened by the concealment of the other features (however pleasing the latter may be), and is rendered still more striking by a practice universal among the females of the higher and middle classes, and very common among those of the lower orders, which is that of blackening the edge of the eyelids, both above and below the eyes, with a black powder called *kohl*. This is a collyrium, commonly composed of the smoke-black which is produced by burning a kind of *libam*—an aromatic resin—a species of frankincense, used, I am told, in preference to the better kind of frankincense, as being cheaper, and equally good for the purpose. Kohl is also prepared of the smoke-black produced from burning the shells of almonds. These two kinds,

though believed to be beneficial to the eyes, are used merely for ornament; but there are several kinds used for their real or supposed medical properties; particularly the powder of several kinds of lead ore; to which are often added sarcocolla, long pepper, sugar-candy, fine dust of a Venetian sequin, and sometimes powdered pearls. Antimony, it is said, was formerly used for painting the edges of the eyelids. The kohl is applied with a small probe, of wood, ivory, or silver, tapering towards the end, but blunt: this is moistened, sometimes with rose-water, then dipped in the powder, and drawn along the edges of the eyelids: it is called *mir'ced*; and the glass vessel in which the kohl is kept, *mook' hhol'ah*. The custom of thus ornamenting the eyes prevailed among both sexes in Egypt in very ancient times: this is shown by the sculptures and paintings in the temples and tombs of this country; and kohl-vessels, with the probes, and even with the remains of the black powder, have often been found in the ancient tombs. I have two in my possession. But, in many cases, the ancient mode of ornamenting with the kohl was a little different from the modern. I have, however, seen this ancient mode practised in the present day in the neighbourhood of Cairo; though I only remember to have noticed it in two instances. The same custom existed among the Greek ladies, and among the Jewish women in early times.'

Sir J. G. Wilkinson alludes to this passage in Mr. Lane's book, and admits that the lengthened form of the ancient Egyptian eye, represented in the paintings, was probably produced by this means. 'Such (he adds) is the effect described by Juvenal (*Sat.* ii. 93), Pliny (*Ep.* vi. 2), and other writers who notice the custom among the Romans. At Rome it was considered disgraceful for men to adopt it, as at present in the East, except medicinally,* but if we may judge from the similarity of the eyes of men and women in the paintings at Thebes, it appears to have been used by both sexes among the ancient Egyptians. Many of the kohl-bottles have been found in the tombs, together with the bodkin used for applying the moistened powder. They are of various materials, usually of stone, wood or pottery; sometimes composed of two, sometimes of three or four separate cells, apparently containing each a mixture, differing slightly in its quality and hue from the other three. Many were simple round tubes, vases, or small boxes; some were ornamented with the figure of an ape or monster, supposed to assist in holding the bottle between his arms, while the lady dipped into it the pin with which she painted her eyes; and others were in imitation of a column made of stone, or rich porcelain of the choicest manufacture' (*Ancient Egyptians*, iii. 382).

EZEKIEL (עֶזְקִיֵּאל = עֶזְקָא, [*whom*] *God will strengthen*, Gesen. *Theol.*, or עֶזְקָא, *God will prevail*, Rosenm. *Schol.*; Sept. Ἰεζεκιήλ), one of the greater prophets, whose writings, both in the Hebrew and Alexandrian canons, are placed next to those of Jeremiah. He was the son of Busi the priest (ch. i. 3), and, according to tradition, was a native of Sarera (ἐκ γῆς

* This is not altogether correct. In Persia, it is as common among the men as the women.—J. K.

Σαφρά, Carpoz, *Introd.*, pt. iii. p. 200). Of his early history we have no authentic information. We first find him in the country of Mesopotamia, 'by the river Chebar' (ch. i. 1), now *Khabur*, a stream of considerable length flowing into the Euphrates near Circesium, *Kirkesia* (Rosenmüller's *Bibl. Geog. of Central Asia in Bibl. Cabinet*, vol. ii. p. 180). On this river Nebuchadnezzar founded a Jewish colony from the captives whom he brought from Jerusalem when he besieged it in the eighth year of king Jehoiachin (2 Kings xxv. 14). This colony (or at least a part of it) was settled at a place called Tel-Abib, which has been thought by some to answer to the Thallaba of D'Anville (Rosenm., *Bibl. Geog.*, vol. ii. p. 188); and it seems to have been here that the prophet fixed his residence. Josephus (*Antiq.* x. 6. § 3) states, that he was a youth (*παῖς ἔν*) when carried away captive; but, as Hävernick (*Commentar über Ezechiel*, Erlangen, 1813, p. viii.) justly remarks, the matured character of a priest which appears in his writings, and his intimate acquaintance with the temple service, render such a supposition highly improbable. He received his commission as a prophet in the fifth year of his captivity (B.C. 594). Many critics suppose (from ch. i. 1) that this event took place in the 30th year of his age. Thus Carpoz (p. 201) understands the expression. There is, however, little reason to think that this is the epoch intended. The more probable opinion seems to be that the reckoning is from the commencement of the reign of Nabopolassar, the father of Nebuchadnezzar (Scaliger, *De Emendatione Temporum*, Lug. Bat. 1598, p. 374; Rosenm. *Schol. in Ezech.*; Eichhorn, *Eindeitung in d. A. T.*, vol. iii. p. 188, 3rd edit.; Winer, *Bibl. Realwörterbuch*, art. 'Ezech.'). Others (as Ussher, Hävernick, pp. 12, 13) take the era to be that of the finding the book of the law in the 18th year of Josiah, which is nearly synchronous with the former. The question is not of much importance in a chronological point of view, since the date is sufficiently fixed by the reference he makes to the year of the captivity. Ezekiel is remarkably silent respecting his personal history; the only event which he records (and that merely in its connection with his prophetic office) is the death of his wife in the ninth year of the captivity (ch. xxiv. 18). He continued to exercise the prophetic office during a period of at least twenty-two years, that is, to the 27th year of the captivity (ch. xxix. 17); and it appears probable that he remained with the captives by the river Chebar during the whole of his life. That he exercised a very commanding influence over the people is manifest from the numerous intimations we have of the elders coming to inquire of him what message God had sent through him (ch. viii. 1; xiv. 1; xx. 1; xxxiii. 31, 32, &c.). Carpoz (pp. 203, 4) relates several traditions respecting his death and sepulchre, principally from the treatise *De Vitis Prophet.*, falsely attributed to Epiphanius. It is there said that he was killed at Babylon by the chief of the people (*ὁ ἡγούμενος τοῦ λαοῦ*) on account of his having reproved him for idolatry; that he was buried in the field of Maur (*ἐν ἀγρῷ Μαοῦρ*) in the tomb of Shem and Arphaxad, and that his sepulchre was still in existence. Such traditions are obviously of very little value.

Ezekiel was contemporary with Jeremiah and

Daniel. The former had sustained the prophetic office during a period of thirty-four years before Ezekiel's first predictions, and continued to prophesy for six or seven years after. It appears probable that the call of Ezekiel to the prophetic office was connected with the communication of Jeremiah's predictions to Babylon (Jer. li. 59), which took place the year preceding the first revelation to Ezekiel (Hävernick, p. ix.). The greater part of Daniel's predictions are of a later date than those of Ezekiel; but it appears that his piety and wisdom had become proverbial even in the early part of Ezekiel's ministry (ch. xiv. 14, 16; xxviii. 3).

Most critics have remarked the vigour and surpassing energy which are manifest in the character of Ezekiel. The whole of his writings show how admirably he was fitted, as well by natural disposition as by spiritual endowment, to oppose the 'rebellious house,' the 'people of stubborn front and hard heart,' to whom he was sent. The figurative representations which abound throughout his writings, whether drawn out into lengthened allegory, or expressing matters of fact by means of symbols, or clothing truths in the garb of enigma, all testify by their definiteness the vigour of his conceptions. Things seen in vision are described with all the minuteness of detail and sharpness of outline which belong to real existences. But this characteristic is shown most remarkably in the entire subordination of his whole life to the great work to which he was called. We never meet with him as an ordinary man; he always acts and thinks and feels as a prophet. This energy of mind developed in the one direction of the prophetic office is strikingly displayed in the account he gives of the death of his wife (ch. xxiv. 15-18). It is the only memorable event of his personal history which he records, and it is mentioned merely in reference to his soul-absorbing work. There is something inexpressibly touching as characteristic in this brief narrative—the 'desire of his eyes' taken away with a stroke—the command not to mourn—and the simple statement, 'so I spake unto the people in the morning, and at even my wife died; and I did in the morning as I was commanded.' That he possessed the common sympathies and affections of humanity is manifest from the beautiful touch of tenderness with which the narrative is introduced. We may even judge that a mind so earnest as his would be more than usually alive to the feelings of affection when once they had obtained a place in his heart. He then, who could thus completely subordinate the strongest interests of his individual life to the great work of his prophetic office, may well command our admiration, and be looked upon as (to use Hävernick's expression) 'a truly gigantic phenomenon.' It is interesting to contrast Ezekiel in this respect with his contemporary Jeremiah, whose personal history is continually presented to us in the course of his writings; and the contrast serves to show that the peculiarity we are noticing in Ezekiel belongs to his individual character, and was not necessarily connected with the gift of prophecy.

That Ezekiel was a poet of no mean order is acknowledged by almost all critics. Lowth (*De sacra Poësi Hebræorum*, ed. J. D. Michaelis, Götting, 1770, p. 431) sums up his account of him: 'In cæteris a plerisque vatibus fortasse

superatus; sed in eo genere ad quod unice videtur a natura comparatus, nimirum vi, impetu, pondere, granditate, nemo ex omni scriptorum numero eum unquam æquavit.' Michaelis and Dathe are the only critics of any eminence (as far as we know) who think slightly of his poetical genius. The former (to whom Dathe assents) remarks, 'Mibi in Ezekiele non sublimitas laudanda, nedum Isaiana, videtur, ut potius in exornandis amplificandisque imaginibus plus artis et luxuriei eum habere dixerim, quam cum impetu et sublimitate pœmatis consistere potest. Perpetuus aliqua ex parte imitator est, et tamen novus ac suus, non grandis, sed ingeniosus' (*Ib.* p. 127). The question is altogether one of taste, and has, we imagine, been decided by common consent against Michaelis. He remarks more truly that Ezekiel lived at a period when the Hebrew language was declining in purity, when the *silver* age was succeeding to the *golden* one. It is, indeed, to the matter rather than the language of Ezekiel that we are to look for evidence of poetic genius. His style is often simply didactic, and he abounds in peculiarities of expression, Aramaisms, and grammatical anomalies, which, while they give individuality to his writings, plainly evince the decline of the language in which he wrote. An extended account of such peculiarities is given by Eichhorn (*Einleitung in das A. T.* vol. iii. p. 196) and Gesenius (*Geschichte der Heb. Sprache u. Schrift*, p. 35).

The genuineness of the writings of Ezekiel has been the subject of very little dispute. According to Jewish tradition doubts were entertained as to the canonicity of the book on the ground of its containing some apparent contradictions to the law, as well as because of the obscurity of many of its visions. These, however, were removed, it is said, by Rabbi Hananias, who wrote a commentary on the book, in which all these difficulties were satisfactorily solved (*Mischna*, ed. Surenhusius, *Præf. ad Part.* iv. מִסְכַּת עֲרִיית; Carpzov, *Introd.* pt. iii. p. 215); but still, on account of their obscurity, the visions at the beginning and close of the book were forbidden to be read by those who were under thirty years of age (Carpzov, p. 212). Some continental critics of the last century have impugned the canonicity of the last nine chapters, and have attributed them to some Samaritan or Hebrew who had returned in later times to the land of Judæa (Oeder, *Freye Untersuchung über einige Bücher des A. T.*, Hal. Sax. 1771; Vogel, *Beleuchtung des Jüdisch. und Christl. Bibelkanons*, pt. i. p. 105, quoted by Rosemüller, *Schol. in Ez.* ad c. xl.). These objections have been fully answered by Eichhorn (*Einleitung*, vol. iii. p. 203), Jahn (*Introd. in Lib. Sac. V. F.*, v. 356), and others. Jahn has also taken notice of and answered some objections raised by an anonymous writer in the *Monthly Magazine*, 1798, to the canonicity of c. xxv.-xxxii., xxxv., xxxvi., xxxviii., xxxix. A translation of Jahn's arguments will be found in Horne's *Introd.* vol. iv. p. 222. These and similar objections have so little weight or probability that we shall content ourselves with quoting the general remark of Gesenius in reference to the whole of Ezekiel's writings: 'This book belongs to that not very numerous class which, from beginning to end,

maintains by means of favourite expressions and peculiar phrases such a oneness of tone as by that circumstance alone to prevent any suspicion that separate portions of it are not genuine' (*Geschichte der Heb. Spr.* p. 35). The canonicity of the book of Ezekiel in general is satisfactorily established by Jewish and Christian authorities. There is, indeed, no explicit reference to it, or quotation from it, in the New Testament. Eichhorn (*Einleit.* p. 218) mentions the following passages as having apparently a reference to this book: Rom. ii. 24; comp. Ezek. xxxvi. 21: Rom. x. 5; Gal. iii. 12; comp. Ezek. xx. 11: 2 Pet. iii. 4; comp. Ezek. xii. 22; but none of these are quotations. The closing visions of Ezekiel are clearly referred to, though not quoted, in the last chapters of the Apocalypse. The prophet Ezekiel is distinctly referred to by the son of Sirach, Ἰεζεκιήλ ὃς εἶδεν ὄρασις δόξης, ἣν ἠόραξεν αὐτῷ ἐπὶ ἄρματος χειρουβίμ (Ecclus. xlix. 8), and by Josephus (*Antiq.* x. 5. § 1; 6. § 3; 7. § 2; 8. § 2). The book of Ezekiel is also mentioned as forming part of the canon in the catalogues of Melito (Eusebius, *Hist. Eccles.* iv. 26), Origen (apud Euseb. *l. c.* vi. 25), Jerome (*Prologus Galeatus*), and the Talmud (Eichhorn, vol. iii. p. 218; vol. i. pp. 126-137). One of the passages of Josephus to which we have referred has occasioned much controversy and many conjectures, because he seems to affirm that Ezekiel had written two books of prophecies. Having spoken of Jeremiah and his predictions of the Babylonian captivity, Josephus adds, οὐ μόνον δὲ οὗτος προεθέσπισε ταῦτα τοῖς ὕχλοις, ἀλλὰ καὶ ὁ προφήτης Ἰεζεκιήλος ὃς πρῶτος περὶ τούτων δύο βιβλία γράφας κατέλιπεν (*Antiq.* x. 5. § 1). According to the ordinary and, indeed, as it would seem, necessary interpretation of this passage, Ezekiel was the first who wrote two books respecting the Babylonian captivity. The question, then, arises, Has one of his books been lost, or are the two now joined into one? The former supposition has been maintained by some in order to account for certain professed quotations from the prophet Ezekiel of passages which are not found in his writings at present. Thus Clemens Romanus (1 *Ep. ad Cor.* c. 8) refers to such a passage, which is given more at length by Clemens Alexand. (*Pædagog.* i. 10). Thus, again, Tertullian (*De carne Christi*, c. 23, p. 394, ed. Semler) says 'Legimus apud Ezechielem de vacca illa quæ peperit et non peperit.' Other instances may be seen in Fabricius (*Codex Pseud-epigraphus V. T.* ed. 2da. p. 1118), and quoted from him by Carpzov (*Introd.* pt. iii. p. 208). Both these critics, however, agree that the most probable explanation of such references is that they were derived from Jewish tradition. The latter hypothesis, that our present book was originally two, the second containing the last nine chapters, has received the support of very many critics (see Le Moynes, *Varia Sacra*, t. ii. p. 332; Carpzov, *Introd.* p. 208). This view, however, is not without serious difficulties. There is no evidence that the book, as at present existing, was ever considered two; and the testimony of Josephus himself, that only twenty-two books were received as sacred (*Contr. Apion.* i. 8), appears quite opposed to such a supposition, since in whatever way the division of the Old Testament into twenty-two books is made there cannot be two

out of the number left for Ezekiel. Eichhorn (*Einkleitung*, vol. iii. p. 146) maintains that it is Jeremiah of whom Josephus speaks, a position to which we should at once assent if we could with him consider the words *ὁς πρῶτος* as equivalent to *ὁ δὲ πρῶτος*. If this is what Josephus meant, we must suppose some corruption of his text.

The central point of Ezekiel's predictions is the destruction of Jerusalem. Previously to this catastrophe his chief object is to call to repentance those who were living in careless security; to warn them against indulging in blind confidence, that by the help of the Egyptians (Ezek. xvii. 15-17; comp. Jer. xxxvii. 7) the Babylonian yoke would be shaken off; and to assure them that the destruction of their city and temple was inevitable and fast approaching. After this event his principal care is to console the captives by promises of future deliverance and return to their own land, and to encourage them by assurances of future blessings. His predictions against foreign nations stand between these two great divisions, and were for the most part uttered during the interval of suspense between the divine intimation that Nebuchadnezzar was besieging Jerusalem (ch. xxiv. 2), and the arrival of the news that he had taken it (ch. xxxiii. 21). The predictions are evidently arranged on a plan corresponding with these the chief subjects of them, and the time of their utterance is so frequently noted that there is little difficulty in ascertaining their chronological order. This order is followed throughout, except in the middle portion relating to foreign nations, where it is in some instances departed from to secure greater unity of subject (*e. g.* ch. xxix. 17). The want of exact chronological order in this portion of the book, has led to various hypotheses respecting the manner in which the collection of the separate predictions was originally made. Jahn (*Introd.* p. 356) supposes that the predictions against foreign nations were placed in their present position by some transcriber in the order in which they happened to come into his hands, and that he through forgetfulness omitted chaps. xxxv., xxxviii., and xxxix. Eichhorn (*Einkleit.* vol. iii. p. 193) thinks it probable that the predictions were written on several greater or smaller rolls, which were put together in their present form without sufficient regard to chronological accuracy. Bertholdt (*Einkleit.* v. iv. p. 1487, quoted by Hävernick) supposes that the collector of the whole book found two smaller collections already in existence (ch. xxv.-xxxii. and xxxiii. 21.-xxxix.), and that he arranged the other predictions chronologically. All such hypotheses belong, as Hävernick remarks, to a former age of criticism.

The arrangement, by whomsoever made, is very evidently designed, and it seems on many accounts most probable that it was made by Ezekiel himself. This is maintained by Hävernick on the following grounds: 1. The arrangement proceeds throughout on a plan corresponding with the subjects of the predictions. In those against foreign nations chronological is united with material order, whilst in those which relate to Israel the order of time is strictly followed. 2. The predictions stand in such connection with each other that every part has reference to what has preceded it. 3. Historical notices are occasionally appended to the predictions, which would scarcely be done by a transcriber: *e. g.* the notice respecting

himself in chaps. xi., xxiv., xxv., and the close of chap. xix., which Hävernick translates 'This is a lamentation and was for a lamentation.' The whole book is divided by Hävernick into nine sections, as follows:—

1. Ezekiel's call to the prophetic office (ch. i.-iii. 15).

2. Series of symbolical representations and particular predictions foretelling the approaching destruction of Judah and Jerusalem (ch. iii. 16-7ii.).

3. Series of visions presented to the prophet a year and two months later than the former, in which he is shown the temple polluted by the worship of Adonis—the consequent judgment on the inhabitants of Jerusalem and on the priests,—and closing with promises of happier times and a purer worship (ch. viii.-xi.).

4. A series of reproofs and warnings directed especially against the particular errors and prejudices then prevalent amongst his contemporaries (ch. xii.-xix.).

5. Another series of warnings delivered about a year later, announcing the coming judgments to be yet nearer (ch. xx.-xxiii.).

6. Predictions uttered two years and five months later, when Jerusalem was besieged, announcing to the captives that very day as the commencement of the siege (comp. 2 Kings xxv. 1), and assuring them of its complete overthrow (ch. xxiv.).

7. Predictions against foreign nations (ch. xxv.-xxxii.).

8. After the destruction of Jerusalem a prophetic representation of the triumph of Israel and of the kingdom of God on earth (ch. xxxiii.-xxxix.).

9. Symbolic representation of Messianic times, and of the establishment and prosperity of the kingdom of God (ch. xl.-xlviii.).

The latter part of the book has always been regarded as very obscure. It will be seen by the brief notices of the contents of the sections which we have given above, that Hävernick considers the whole to relate to Messianic times. The predictions respecting Gog (ch. xxxviii., xxxix.) have been referred by some to Antiochus Epiphanes; by others to Cambyses, to the Chaldeans, the Scythians, the Turks, &c. Mr. Granville Penn has interpreted them of Napoleon and the French (*The Prophecy of Ezekiel concerning Gog, &c.*, 1815). The description of the temple (ch. xl.-xliii.) has been thought by many to contain an account of what Solomon's temple was; by others, of what the second temple should be. The difficulties of all these hypotheses seem to be insuperable. We have only space to say that we fully accord with the view of Hävernick, and are glad to take this opportunity of recommending his *Commentary* to the notice of English scholars. We do this the more readily because we believe his book (published only this year, 1843) is very little known at present in England. To him we are greatly indebted for the materials of the present article, and only regret that we could not obtain his work soon enough to make a more extended use of it.—F. W. G.

EZIONGEBER (עֲזִיּוֹן גְּבֵר; Sept. Γαζίωρ Γάβερ; and Vulg. *Asiongeber*), a very ancient city lying not far from Elath, on the eastern arm

of the Red Sea. It is first mentioned in Num. xxxiii. 35, as one of the stations where the Hebrews halted in their journeyings through the desert (Deut. ii. 8). From its harbour it was that Solomon (1 Kings ix. 26) sent the fleet which he had there built to the land of Ophir, whence they fetched four hundred and twenty talents of gold. Here, also, Jehoshaphat (1 Kings xxii. 47; 2 Chron. xx. 35) built a fleet 'to go to Ophir,' but because he had joined himself with Alaziah, 'king of Israel, who did wickedly,' 'the ships were broken that they were not able to go to Tarshish.' Josephus (*Antiq.* viii. 6. 4) says that Eziongeber was also called Berenice, and that it lay not far from Ailath. It is probably the same with the once populous city Assyan (Burckhardt, ii. 831). Robinson (*Biblical Researches*, i. 250) says, 'no trace of Eziongeber seems now to remain, unless it be in the name of a small wady with brackish water, el-Ghudyan opening into el-Arabah from the western mountain, some distance north of Akabah. However different the names el-Ghudyan and Ezion may be in appearance, yet the letters in Arabic and Hebrew all correspond' [ELATH].—J. R. B.

EZRA. We shall bring the statements of this article under the following heads:—

I. NAME.

II. PARENTAGE.

III. DOINGS. 1. Historical; 2. Doubtful.

IV. WRITINGS. 1. Canonical; 2. Apocryphal.

I. Name.—עֶזְרָא *Ezra* means *help*; Sept. Ἐσθρας. The form of the name is Chaldaic or Aramaic; and it is equivalent in meaning to the Hebrew name עֲזָרָה, from the root עָזַר; Arab.

عِزْر, *he surrounded, protected, helped.*

II. Parentage.—The celebrated Ezra was a Jewish scribe (סֹפֵר) and priest (כֹּהֵן), who, about the year B.C. 458, led the second expedition of Jews back from the Babylonian exile into Palestine. This Ezra ought to be distinguished from the Ezra who went up as one of the chiefs of the priests and Levites under Zerubbabel (Neh. xii. 1, 12, 33).

Ezra was a lineal descendant from Phinehas, the son of Aaron. He is stated in Scripture to be the son of Seraiah, the son of Azariah; which Seraiah was slain at Riblah by order of Nebuchadnezzar, having been brought thither a captive by Nebuzaradan. But, as 130 years elapsed between the death of Seraiah and the departure of Ezra from Babylon, and we read that a grandson of Seraiah was the high priest who accompanied Zerubbabel on the first return to Jerusalem, seventy years before Ezra returned thither, we may suppose that by the term *son* here, as in some other places, the relationship of grandson, or of a still more remote direct descendant, is intended. In addition to the information given in the books of Ezra and Nehemiah, that Ezra was a 'scribe,' a 'ready scribe of the law of Moses,' 'a scribe of the words of the Commandments of the Lord and of his statutes to Israel,' 'a scribe of the law of the God of Heaven,' and 'a priest,' we are told by Josephus that he was high-priest of the Jews who were left in Babylon; that he was particularly conversant with the laws of Moses, and was held in universal esteem on account of his righteousness and virtue.

III. Doings of Ezra.—The rebuilding of the temple of Jerusalem, which had been decreed by Cyrus in the year B.C. 536, was, after much powerful and vexatious opposition, completed in the reign and by the permission of Darius Hystaspis, in the year B.C. 515.

In the year B.C. 457 Ezra was sent by Artaxerxes Longimanus and his counsellors to inquire concerning Judah and Jerusalem, according to the law of his God which was in his hand; and to carry the silver and gold which the king and his counsellors freely offered unto the God of Israel. Permission was also granted to him to take with him all the silver and the gold which he could find in all the province of Babylon, together with the free-will offerings which the people and priests offered for the house of God at Jerusalem. Of this treasure he was directed to employ as much as was requisite in the purchase of offerings according to the law of Moses, and the surplus he was to lay out according to his discretion for the maintenance of the externals of religion. Ezra was also charged to convey vessels for the house of God in Jerusalem; and, lest these gifts should be insufficient, he was empowered to take from the king's treasure-house as much as should be wanted to supply everything needful for the house of the Lord. At the same time that this commission was given to Ezra, Artaxerxes Longimanus issued a decree to the keepers of the king's treasure beyond the river, to assist Ezra in everything in which he needed help, and to supply him liberally with money, corn, wine, oil, and salt. It was further enacted that it should not be lawful to impose tribute upon any priest, Levite, or other person concerned in ministrations in the house of God. Ezra was commissioned to appoint 'according to the wisdom of God which was in his hand,' magistrates and judges to judge all the people beyond the river, that knew the laws of his God; and was enjoined to teach them to those who knew them not. The reason of the interest for the worship of God at this time evinced by Artaxerxes, appears to have been a fear of the divine displeasure, for we read in the conclusion of the decree to the treasurers beyond the river, 'Whatsoever is commanded by the God of Heaven, let it be diligently done for the house of the God of Heaven; FOR WHY SHOULD THERE BE WRATH AGAINST THE REALM OF THE KING AND HIS SONS?' We are also told (Ezra, vii. 6) that the king granted Ezra all his request; and Josephus informs us that Ezra, being desirous of going to Jerusalem, requested the king to grant him commendatory letters to the governor of Syria. We may therefore suppose that the dread which Artaxerxes entertained of the divine judgments was the consequence of the exposition to him by Ezra of the history of the Jewish people. Some writers suppose that this favour shown to the Jews was consequent upon the marriage of Esther with Ahasuerus; but this could not be, even if we should grant, what is unlikely, that the Artaxerxes of the book of Ezra and the Ahasuerus of the book of Esther were the same person, because Ezra set out for Jerusalem in the *first* month in the seventh year of the reign of Artaxerxes, and Esther was not taken into the King's house until the *tenth* month in the seventh year of the reign of Ahasuerus, and did not declare her connection with the Jewish people, and obtain favour:

for them until after the plot of Haman, in the twelfth year of Ahasuerus.

Ezra assembled the Jews who accompanied him on the banks of the river Abava, where they halted three days in tents. Here Ezra proclaimed a fast, as an act of humiliation before God and a season of prayer for divine direction and safe conduct; for, on setting out, he 'was ashamed to require a band of soldiers and horsemen to help them against the enemy by the way,' because he had asserted to the king that the hand of his God is upon all them that seek him for good. Ezra next committed the care of the treasures which he carried with him to twelve of the chief priests, assisted by ten of their brethren, appointing these to take charge of the treasures by the way, and deliver them safely in the house of the Lord at Jerusalem. On the twelfth day from their first setting out Ezra and his companions left the river Ahava, and arrived safely at Jerusalem in the fifth month, having been delivered from the hand of the enemy and of such as lay in wait by the way. Three days after their arrival the treasures were weighed and delivered into the custody of some Levites. The returning exiles offered burnt-offerings to the Lord. They delivered also the king's commissions to the viceroys and governors, and gave needful help to the people and the ministers of the Temple. When Ezra had discharged the various trusts committed to him, the princes of the Jews came to him and complained that the Jewish people generally who had returned from the captivity, and also the priests and Levites, but especially the rulers and princes, had not kept themselves separate from the people of the land, but had done according to the abominations of the remnant of the nations whom their forefathers had driven out, and married their daughters, and allowed their children to intermarry with them. On hearing this Ezra was deeply afflicted; and, according to the Jewish custom, he rent his mantle and tore the hair of his head and beard. There gathered round him all those who still feared God, and dreaded his wrath for the transgression of those whom he had brought back from captivity. Having waited till the time of the evening sacrifice, Ezra rose up, and, having again rent his hair and his garments, made public prayer and confession of sin. The assembled people wept bitterly, and Shechaniah, one of the sons of Elam, came forward to propose a general covenant to put away the foreign wives and their children. Ezra then arose and administered an oath to the people that they would do accordingly. Proclamation was also made that all those who had returned from captivity should within three days gather themselves together unto Jerusalem, under pain of excommunication and forfeiture of their goods. The people assembled at the time appointed, trembling on account of their sin and of the heavy rain that fell. Ezra addressed them, declaring to them their sin, and exhorting them to amend their lives by dissolving their illegal connections. The people acknowledged the justice of his rebukes, and promised obedience. They then requested that, as the rain fell heavily, and the number of transgressors was great, he would appoint times at which they might severally come to be examined respecting this matter, accompanied by the judges and elders of every city. A commission was therefore formed, con-

sisting of Ezra and some others, to investigate the extent of the evil. This investigation occupied three months.

In Neh. viii. we read that, on the occasion of the celebration of the feast of the seventh month, subsequently to Nehemiah's numbering the people, Ezra was requested to bring the book of the law of Moses; and that he read therein standing upon a pulpit of wood, which raised him above all the people.

Josephus relates the affecting scene which occurred on the reading of the law by Ezra. The account given by Josephus agrees with that of Nehemiah in all leading particulars, except that Josephus places the date and occasion twelve years afterwards.

Josephus tells us that Ezra died soon after this celebration of the Feast of Tabernacles, and was buried at Jerusalem with great magnificence. According to some Jewish chroniclers he died in the year in which Alexander came to Jerusalem, on the tenth day of the month Tebeth (that is, the lunation in December), in the same year in which took place the death of the prophets Haggai, Zechariah, and Malachi, and in which prophecy became extinct. According to other traditions Ezra returned to Babylon and died there at the age of 120 years.

The Talmudic statement is that he died at Zamzumi, a town on the Tigris, while on his road from Jerusalem to Susa, whither he was going to converse with Artaxerxes about the affairs of the Jews. A tomb said to be his is shown on the Tigris, about twenty miles above its junction with

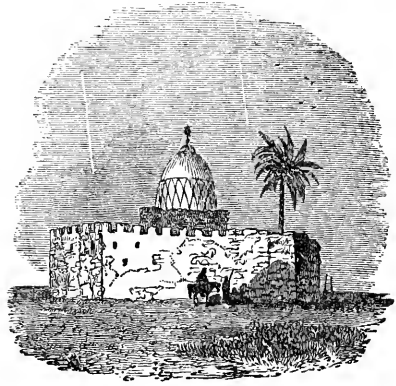

286. [Tomb of Ezra.]

the Euphrates. An interesting description and wood-cut of this tomb are subjoined to the notes on the book of Ezra in the 'Pictorial Bible.'

Some traditions assert that Ezra was, about A.M. 3113, the president of the *כנסת הגדולה*, *Synagoga Magna*, and the father of all Mishnic doctors. In piety and meekness he was like unto Moses (*Iuchasin*, p. 13. See *Zemach David*). When he went from Babylon to Jerusalem, he took with him all persons whose descent was either illegitimate or unknown; so that the Jews left in Babylon should be *נקי כסולת*, *pure like flour* (*Kiddushin*, c. 4, 1, *Gem.*). Ezra is said to have introduced the present square Hebrew character, and, in conjunction with some other elders, to

have made the masora, the punctuation, and accentuation of the whole Bible (Abarbanel, *Præfat. ad Nachalath Avoth*; Elias, *Præf. 3 Masor.*).

Ezra is also said to have vigorously resisted the sect of the Sadducees, which sprang up in his days; and therefore to have put the words מן העולם ער עולם, *à sæculo in sæculum*, at the head of all prayers, as a symbol by which the orthodox could be distinguished (*Bab. Berachoth*, fol. 54).

Since the people, during the Babylonian captivity or exile, had become accustomed to the Aramaic language, and scarcely understood Hebrew, Ezra established the office of turgoman, דרגומן, *dragoman*, or interpreter, who stood near the public reader in the synagogue, and translated every verse after it was read (*Megillah*, fol. 74).

Ezra ordained that the year of jubilee should be reckoned from the seventh year after the rebuilding of the temple (Maimon. *Hal. Jobel*. cap. 10).

Ezra is considered to be the author of the canon, and worthy to have been the lawgiver, if Moses had not preceded him (*Bab. Sanhed. c. ii. f. 21*; compare the article CANON). He is even said to have re-written the whole of the Old Testament from memory, the copies of which had perished by neglect. But we must abstain from recounting all the traditional amplifications of the doings of Ezra, since, if all were to be received, it would be difficult to say what he did not do, so strong has been the inclination to connect important facts with the person of Ezra (compare 2 Esdras, xiv.; Irenæus, *Adv. Hæres.* iii. 25; Clem. Alex. *Strom.* i. p. 142; Augustin. *De Mirabil. Script.* ii. 23; Hieron. *ad Habrid.* p. 212; Vall. Buxtorf, *Tiberias*, p. 88, sqq.; Bertholdt, *Einleit.* i. 69, sqq.; De Wette, *Einleit.* p. 17, sq.; Sauer, *Diss. canonem Vet. Test.* etc. Altorf, 1792, 4to.; *Sanhedrin*, fol. xxi. 1; Rau, *De Synag. Magna*, pp. 31, 89; Hartmann, *Verbindung des Alten und Neuen Testamentes*, pp. 114, sqq. Arabian fables about Ezra are mentioned in Hottinger's *Thes. Philol.* p. 113, and in Herbelot, *Bibl. Orientale*, p. 697, etc.).

IV. *Writings.*—We now turn to the writings of Ezra. The canonical writings of Ezra are, besides the book which bears his name, most likely the two books of the Chronicles. 'Esræ libros Paralipomenon lucubrasse Ebræorum omnium est fama consentiens' (Huetius, *Dem. Evang.* iv. 14, p. 341). But as the reasons for ascribing the books of Chronicles to the authorship of Ezra have already been investigated in the article CHRONICLES, we confine ourselves here to the book of Ezra. Some authors have ascribed the books of Nehemiah and Esther likewise to Ezra, although they differ in style. [ESTHER; NEHEMIAH.]

Contents.—The book of Ezra contains ἀπομνημονεύματα, *memorabilia*, or records of events occurring about the termination of the Babylonian exile. It comprises accounts of the favours bestowed upon the Jews by Persian kings; of the rebuilding of the temple; of the mission of Ezra to Jerusalem, and his regulations and reforms. Such records forming the subject of the book of Ezra, we must not be surprised that its parts are not so intimately connected with each other as we might have expected if the author had set forth his intention to furnish a complete history of his times.

The events narrated in the book of Ezra are spread over a period of about 79 years, under the reigns of

	Years.	Months.
Cyrus	7	0
Cambyzes	7	5
Magus, or Pseudo-Smerdis	0	7
Darius Hystaspis	36	0
Xerxes	21	0
Artaxerxes (in the eighth year of whose reign the records of Ezra cease)	8	0
	80	0

The beginning of the book of Ezra agrees verbatim with the conclusion of the second book of Chronicles, and terminates abruptly with the statement of the divorces effected by his authority, by which the marriages of Israelites with foreign women were dissolved.

Since the book of Ezra has no marked conclusion, it was, even in early times, considered to form part of the book of Nehemiah, the contents of which are of a similar description. As, however, the book of Ezra is a collection of detached ἀπομνημονεύματα, or records of remarkable events occurring at the conclusion of the exile and in the times immediately following it, attempting no display of the art of book-making, the mere want of an artificial conclusion cannot be considered a sufficient reason for regarding it as the first portion of Nehemiah. It is, however, likely that the similarity of the contents of the books of Ezra and Nehemiah was the cause of their being placed together in the Hebrew Bible.

The arrangement of the facts in the book of Ezra is chronological. The book may be divided into two portions. The first consists of chapters i.-vi., and contains the history of the returning exiles and of their rebuilding of the temple, and comprises the period from the first year of Cyrus, B.C. 536, to the sixth year of Darius Hystaspis, B.C. 515. In the first six chapters the use of the third person predominates in the narrative, except in passages where, by συνέδοχῃ, occurs הוֹרַנוּ, *Heb. הוֹרַנוּ*, we said, or where the narrative contains abstracts from documents to which Ezra had access. In these abstracts the Aramaic or Chaldee language of the original documents has been preserved from ch. iv. 8, to vi. 18, and vii. 12-26. These portions exist in Kennicott's *Cod.* 240, in a collateral Hebrew translation, reprinted in Kennicott's edition of the Hebrew Bible, and separately in *Chaldaicorum Danielis et Esræ capitulum interpretatio Hebraica. Primus ex codice antiquo illam* ed. B. Kennicott. *In usus eruditorem sorsim excudi curavit, et commentationem de indole et usu hujus translationis præmisit* Ludovicus Schulze, Halæ, 1782, 8vo.

An argument has been raised against the opinion that Ezra was the author of the whole book that bears his name, from the use of the first person plural in the 4th verse of the 5th chapter, which would seem to imply that the narrator was present on the occasion described; but, setting aside other replies to this argument, it appears that the word *we* refers to Tatnai and his companions, and not at all to the Jews.

The second portion contains the personal history of the migration of Ezra to Palestine,

in the seventh year of Artaxerxes. This latter portion, embracing chapters vii.-x., is an autobiography of Ezra during about twelve or thirteen months, in the seventh and eighth years of the reign of Artaxerxes Longimanus. Ezra speaks from ch. vii. 27, to ch. ix. 15, in the first person. 'There is an essential difference between public events which a man recollects, though only as in a dream, to have heard of at the time when they occurred, and those which preceded his birth. The former we think of with reference to ourselves; the latter are foreign to us. The epoch and duration of the former we measure by our own life; the latter belong to a period for which our imagination has no scale. Life and definiteness are imparted to all that we hear or read with respect to the events of our own life' (Niebuhr, *On the Distinction between Annals and History*). These remarks, which Niebuhr made in reference to Tacitus, are, in a great measure, applicable also to Ezra, and account for several of those differences between the various parts of his book, which have so much startled some modern biblical scholars, that they have presumptuously undertaken to show the precise seams or sutures by means of which various fragments of different authors were brought together. In this attempt they have been especially guided by the change of the third to the first person, for which change we account by the above remarks of Niebuhr.

Instances of similar change of person are so frequent in ancient authors, that rhetoricians have introduced it among the rhetorical figures, under the name of *enallage personarum*. The prophetic writings of the Old Testament furnish examples of such ἐνάλλαγη. For instance, Ezek. i. 1-3; Zech. i. 1; vi. 1; vii. 1, 4, 8; Jer. xx. 1, sq. compared with v. 7, sq. xxi. 1; xxviii. 1-5; xxxii. 1-8; Hos. i. 2-3; iii. 1. So also in Habakkuk, Daniel, &c. The frequency of this ἐνάλλαγη, especially in the prophetic parts of the Old Testament, arises from either the more objective or more subjective tendency of the style, which of course varies in harmony with the contents of the chapter. We may observe this ἐνάλλαγη even in our own writings, from which we are certainly taught by modern scholastic usage to eradicate it, although it would, if preserved, frequently give greater freshness to our communications. We have made these remarks in order to show the perfect utility of the chief argument adduced by modern writers against the original unity of the book of Ezra; some of whom, on account of the *enallage personarum*, assert that ch. vii. 1-26 was written by an author different from that of the portion immediately following, up to ch. ix. 15; and that, again, the subsequent portion to the end of the book was indited by a still different writer. We pass over other still more futile arguments against the authenticity of the book, and express our opinion that even Hävernick does not rightly set forth the truth of the matter when, in his *Einklütung*, he says that this ἐνάλλαγη arose from Ezra's imitation of the prophetic usage, and when he approvingly quotes Schirmer's *Observationes exegeticæ et criticæ in librum Esdræ*, vol. ii. p. 8 (Vratislaviae, 1830): 'initio autem narrationis rerum a se gestarum Esdra certe consulto tertia usus est persona, rationem dicendi stilumque prophetarum elaticæ videlicet imitaturus. Uni-

verse non alienum videtur, sed facillime potius animum subit, Esdræ quodammodo prophetarum imitatore qualem seipsum ostendit, agnoscere.' There was certainly as little IMITATION of the prophets in the *enallage personarum* of Ezra, as there is IMITATION of the prophets if we change from the first to the third person in our own communications. 'Ἐνάλλαγη never arises from imitation, but only from the more subjective or more objective turn of our mind, and from that vivacity of style which renders it incumbent upon the reader rather than upon the writer to supply that ἰσχυρῶν', which, as in Jonah ii. 3, forms the transition from the use of the *third* to the adoption of the *first* person.

We have spoken thus far of the canonical book of Ezra; there are, however, four books that have received this name, viz. the book noticed above, the only one which was received into the Hebrew canon under that name, the book of Nehemiah, and the two apocryphal books of Esdras, concerning which see ESDRAS.—C. H. F. B.

EZRACH (עֲרַח). This word occurs only once in Scripture, namely, in Ps. xxxvii. 35: 'I have seen the wicked in great power, spreading himself like a green bay-tree' (*ezrach*). Commentators and translators have differed respecting the meaning of this word, some supposing it to indicate a specific tree, as the laurel; and others, supported by the Septuagint and Vulgate, the cedar of Lebanon. It is by some considered to mean an evergreen tree, and by others, a green tree that grows in its native soil, or that has not suffered by transplanting, as such a tree spreads itself luxuriously. Others, again, as the unknown author of the sixth Greek edition, who is quoted by Celsius (i. p. 194), consider the word as referring to the 'indigenous man': 'Vidi impium et impudentem, in ferocia sua gloriantem, et dicentem: sum instar indigenæ, ambulanti in justitia;' and this opinion is adopted by Celsius himself.

Celsius states that recent interpreters have adopted the laurel or bay-tree for no other reason than because—

— viret semper laurus, nec fronde caduca
Carpitur.

Sir Thomas Browne, indeed, says, 'as the sense of the text is sufficiently answered by this, we are unwilling to exclude that noble plant from the honour of having its name in Scripture.' Isidore de Barrière, on the contrary, concludes that the laurel is not mentioned in Scripture because 'non debuit cœlestis scriptura contaminari mentione illius arboris, quam in tanto pretio habent gentiles, ad fabulas et fictions poeticas adhibent,' &c. This, Celsius justly observes, is a very insufficient reason, as the abuse of a thing should not prevent its proper use; and if such a principle had been acted on, we should not have found in Scripture mention of any trees or plants employed by the Gentiles in their superstitious ceremonies. He might have added, as examples, the vine, the olive, and the cedar, which, for such a reason, might have all been excluded.

The cause why the laurel is not more frequently mentioned in Scripture, is, probably, because it was never very common in Palestine; as otherwise, from its pleasing appearance, grateful shade, and the agreeable odour of its leaves, it could hardly have failed to attract attention,

Though Celsius and others have remarked that, if *ezrach* does indeed signify a tree, it must be some one distinct from the laurel, and one 'quæ in Judæa frequens fuerit, et altitudine, frondumque umbra, atque amœnitate præcellerit cæteris,'



287. [Bay-tree. *Laurus nobilis*.]

yet no evidence is adduced by any of the above authors in behalf of the bay-tree, as that intended in the passage referred to. It appears to us that the Hebrew word must have been derived from the Arabic عشق *ashruk*, which is described in Arabic works on *Materia Medica* as a tree having leaves like the *ghar*, that is, the bay-tree or *laurus nobilis* of botanists. If *ezrach*, therefore, was originally the same word as *ashruk*, then it would indicate some tree resembling the bay-tree, rather than the bay-tree itself; but, until that can be discovered, the latter is, upon the whole, well suited to stand as its representative.

The laurel or bay-tree, *laurus nobilis* of botanists, is well known to the Asiatics by its Arabic name of غار *ghar*, under which it is mentioned by Serapion and Avicenna, who quote chiefly Dioscorides and Galen, thus indicating that they had not much original information of their own respecting a tree which is probably not indigenous in the countries in which they wrote. The leaves and berries of the laurel, as well as the bark and the root, were employed in medicine: the berries continue, even in the present day, to be exported to India, where we found them in the bazaars, under the name of *hub-al-ghar* (*Illust. Him. Bot.* p. 326), being still esteemed as a stimulant medicinal, though not possessed of any properties superior to those of the laurels of more southern latitudes. The Arabs give *zafnee* and *zaknee* as the Greek names of the *ghar*-tree. These are corruptions, no doubt, of δάφνη, the name by which the bay-tree was known to the Greeks. It does not appear to occur in Palestine, as travellers, such as Rauwolf and Belon, do not mention it. Hasselquist expressly states that he had not met with it in Judæa or Galilee, but had rested himself

very comfortably under its shade near the mountains beyond White Cape, on the road from Acre to Sidon. In the neighbourhood of Antioch bay-trees were formerly very abundant, especially at the village and grove of Daphne, famous for the temple of Apollo and its licentious rites. Though the cypress-grove and the consecrated bay-trees have disappeared from the immediate vicinity of Antioch, Dr. Pococke states that they are in great abundance at some little distance. Capts. Irby and Mangles describe the beauty of the scenery on the banks of the Orontes as surpassing anything they expected to see in Syria, and the luxuriant variety of the foliage as prodigious. The laurel, laurestinus, bay-tree, fig-tree, wild vine, plane-tree, English sycamore, arbutus, both common and *Andrachne*, dwarf oak, &c. were scattered in all directions. Capt. M. Kinneir describes a delightful spot, called Babyle, about seven miles from Antioch, which he was disposed to consider the ancient Daphne. A number of fountains boil up from amongst the rocks, and flow in different channels through a meadow, shaded with luxuriant bay-trees, walnut-trees, and groves of myrtle. The bay-tree is well known to be common in the south of Europe, as in Spain, Italy, Greece, and the Levant. It is usually from 20 to 30 feet in height, often having a bushy appearance, from throwing up so many suckers; but in England it has attained a height of 60 feet, which is not unusual in warmer climates. It is unnecessary to allude further to the celebrity which it attained among the ancients—a celebrity which has not yet passed away, the laurel-wreath being still the symbolical crown as well of warriors as of poets. Its ever green grateful appearance, its thick shade, and the agreeable spicy odour of its leaves, point it out as that which was most likely in the eye of the Psalmist.—J. F. R.

F.

FABLE. [PARABLE.]

FACE, in Scripture, is often used to denote presence in the general sense, and, when applied to the Almighty, denotes such a complete manifestation of the divine presence, by sound or sight, as was equivalent, in the vividness of the impression, to the seeing of a fellow-creature 'face to face.' The 'face of God' therefore denotes in Scripture any thing or manner by which God is wont to manifest himself to man. Thus, when it is said that Adam and Eve hid themselves from 'the face of Jehovah,' we understand that they hid themselves from his presence, however manifested; for פנים *penim*, not only signifies presence, as well as (literally) face, but is the very word for presence, however manifested. There is no other word to denote presence in the Hebrew language. Whenever 'presence' occurs in our translation, the word in the original is the same which is rendered 'face' in other places. This is very proper; and the respective terms 'face' and 'presence' are usually applied in the Authorized Version with much propriety and discretion; the latter term being employed wherever the effect of the word 'face' might have seemed harsh or unseemly.

It was a very ancient and common opinion that our mortal frame could not survive the more sensible manifestations of the divine pre-

sence, or 'see God face to face and live' (Gen. xxxii. 30). Hence, in this passage, the gratitude and astonishment of Jacob, that he still lived after God had manifested himself to him more sensibly than by dreams and visions. This impression was confirmed to Moses, who was told, 'Thou canst not see my face: no man can see my face and live' (Exod. xxxiii. 20); which clearly signifies that no one can in this present state of being endure the view of that glory which belongs to Him. The ancient heathen entertained the same notion, which is remarkably expressed in the celebrated mythological story of Semele, who, having prevailed on the reluctant Jove to appear to her in his heavenly splendour, was struck dead by the lightnings of his presence (1 Cor. xiii. 12; 1 John iii. 2; Rev. xxiii. 4).

It is to be borne in mind that God is usually represented to us in Scripture under a human form; and it is indeed difficult for even more spiritualized minds than those of the Hebrews to conceive of Him apart from the form and attributes of the highest nature actually known to us. The Scripture sanctions this concession to the weakness of our intellect, and hence arise the anthropomorphous phrases which speak of the face, the eyes, the arm of God. The appearances of the angels in the Old Testament times were generally in the human form (Judg. xiii. 6, &c.); and from this cause alone it would have been natural, in the imagination, to transfer the form of the messengers to Him by whom they were sent [ANTHROPOMORPHISM].

FAIR HAVENS (*Καλὸι Λιμένες*), a harbour or roadstead of Crete, the unsafeness of which to winter in occasioned that attempt to make for Phenice, on the other side of the island, which led to the eventual loss of the vessel in which Paul sailed for Rome (Acts xxvii. 8). As the name of Kalos Limenas is still preserved, there is no difficulty in fixing the situation to a small bay a little to the north-east of Cape Leon, the present Cape Mafala.

FALLOW DEER. [AII.]

FAMINE (*עָרָב*). Considering the early period in the history of the world to which the Biblical records, especially the oldest of them, refer; and considering also how small a proportion to the world at large, or even to the inhabited part of it, the population bore in the primitive ages, we should not antecedently expect to find frequent mention of famines. Yet does it appear, from the testimony of these records, that mankind suffered greatly from dearth of food in the earliest periods of which we have any account; and the Scriptural history in this, as in other particulars, will be found interesting and valuable to the economist and philosopher, as well as to the divine. In truth famine appears to depend, not on the extent of cultivable or of cultivated land, nor on the proportion which such land bears to the actual population—though, doubtless, both these elements enter into the influences which determine the question of abundance or scarcity—but rather on human forethought and thrift so applied, as, in the actual circumstances, whatever they are, to make a suitable provision in all cases against such contingencies as may occasion dearth. In the almost entire absence of this forethought, barbarous and half-civilized nations have been found, scanty though the population

may be in relation to the tracts of land over which they roam, to be most frequently on the verge of destitution, and not seldom to suffer the greatest privations from dearth and famine. Vain is the almost unlimited opportunity which Nature spreads around them for the supply of their animal necessities, since they want either the intelligence and skill which are necessary to turn these opportunities to account, or the moral qualities which would spare something from actual abundance in order to provide against coming wants.

Since the Bible gives its unquestionable evidence to show that dearth was by no means an unfrequent or an inconsiderable evil in the early ages, it supplies a very cogent proof, in answer to those who maintain either that the world is worse or no better than it was in ancient times, that, at least in those moral qualities on which man's physical well-being depends, mankind have made unquestionable advances. Indeed if any large portion of the earth now suffer from famine, the cause may be looked for not so much in the want of forethought and savingness as in the operation of passions and prejudices arising from misconceived self-interest, which prevent the free interchange of the bounties of divine Providence,—passions and prejudices which characterize not mankind at large, but only certain small portions of society, and which, in consequence, how powerful soever they may for a time be, have not the vitality of vices of character that belong to a semi-barbarous age, and must, in a day like the present, soon disappear before the generous and dissolving ardour of enlightened Christian love.

The first mention of a famine which occurs in Scripture is in Gen. xii. 10, where we read that so early as the days of the patriarch Abraham 'there was a famine in the land,' which is described as so grievous, as to compel the father of the faithful to quit Canaan. The country to which he resorted was, as we might expect, the land of Egypt, the early and lasting fertility of which is a well-known historical fact. In Gen. xxvi. 1, this famine is designated as 'the first,' that is, the first known, or of which there was any record. The same passage informs us of another famine, which afflicted 'the land' in the days of Isaac, who seems to have contemplated a descent into Egypt; but who, being instructed of God, removed to a part of Arabia Petrea (Gen. xxvi. 17) named Gerar, a city of the Philistines, whose monarch's name was Abimelech.

Even Egypt, however, was not exempt from the desolations of famine (Gen. xli. 30). The ordinary cause of dearth in Egypt is connected with the annual overflow of the Nile. If the rise of the waters is in any year below a certain standard, the country affords scanty supplies of food, and may for the greater part remain a desert. But more than local causes must have been in operation in the case before us; for we are told that 'the famine was sore in all lands,' that 'the famine was over all the face of the earth.' By the foresight and wisdom of Joseph, however, provision against the evil had been made in Egypt, while other countries were left to suffer the unmitigated consequences of their neglect. The provision made by Joseph must have been of a most abundant nature, since the period during which the dearth lasted was no less than seven years, and the people of other parts sought and

received supplies in Egypt—'all countries came into Egypt to buy corn.' Among other lands, Canaan suffered from the famine; which was the immediate occasion of Jacob's sending his sons down into Egypt, of the discovery which they made of their lost brother, and of the settlement in that land of the descendants of Abraham: an event of the highest consequence in the sequel, and serving to illustrate the benignity and wisdom of divine Providence in the evils with which, under its influence, the world is afflicted.

This famine was made by Joseph the occasion of one of the greatest social revolutions which history records. The details may be found in the book of Genesis; and it is enough to say here that, as the special administrator of the affairs of the country, Joseph got into his hands all the property of the kingdom, including the land (excepting that which belonged to the priests), and gave the same back to the people as tenants at will, on condition of their paying to the king 'the fifth,' probably, of the annual produce.

From these statements it appears that three successive generations were in these early days visited by famine. The Scriptural narrative (the details of which may be easily ascertained by the help of a Concordance) shows that in after ages famines were, in ancient times, more frequent than they are now; and this justifies the use which is made of so terrible a scourge by the sacred writers, and especially the prophets and our Lord himself, in the highly figurative language which they employ in their righteous endeavours to turn wicked men and wicked nations from the evil of their ways (Ezek. vi. 11; Matt. xxiv. 7). In Amos viii. 11, sq., a heavier woe than even the want of bread is appropriately spoken of under the appellation of a famine: 'Behold, the days come, saith the Lord God, that I will send a famine in the land; not a famine of bread nor a thirst for water, but of hearing the word of the Lord: and they shall wander from sea to sea, and from the north even to the east, they shall run to and fro to seek the word of the Lord, and shall not find it: in that day shall the fair virgins and the young men faint for thirst.' The ensuing verse shows that idolatry was the moving cause of this heavy punishment.—J. R. B.

FASTS (צוֹם; Anglo-Saxon *feetan*, jejunare, found in our present English *break-fast*) properly denote an entire or partial abstinence from food. In the early ages of the world, when the spontaneous productions of nature and the spoils of the chase formed man's chief aliment, fasting from time to time was compulsory, in consequence of the uncertainty of obtaining food when wanted. It would be easy for superstitious ignorance to interpret this compulsion into an expression of the divine will, and so to sanction the observance of fasting as a religious duty. The transition would be the easier at a time and in countries when the office of physician was united in the same person with that of priest; for in hot climates occasional abstinence is not without its advantages on the health; and an abstinence which the state of the body required, but which the appetite shunned or refused, the authority of the priest and the sanctions of religion would exact at once with ease and certainty. In the earlier stages of civilization no idea is more prevalent and operative than that the Deity is pro-

pitiated by voluntary sufferings on the part of his creatures. Hence ensued all kinds of bodily mortifications, and even the sacrifice of life itself. Nay, 'the fruit of the body'—the dear pledges of mutual affection, the best earthly gift from the Heavenly Father—children, were sacrificed in expiation of 'the sin of the soul.' Human enjoyments were held to be displeasing in the sight of God. The notion that the gods were jealous of man's happiness runs through the entire texture of Greek and Roman mythology; and the development of this falsehood, as presented in Greek tragedy, has given birth to some of the finest productions of the human mind. But what more pleasurable than food to man, especially to the semi-barbarian? The denial of such a pleasure must then be well-pleasing to the Divinity; the rather because on occasions of family bereavement, of national disaster, or any great calamity, the appetite is naturally affected under the influence of grief, and is made to loathe the food which in its ordinary condition it finds most grateful. A connection between sorrow and fasting would thus be established which would carry with it a sort of divine sanction in being natural and inevitable in its origin. Accordingly, abstinence which seemed imposed by Providence, if not in expiation of guilt, yet as an accompaniment of sorrow, easily became regarded as a religious duty, when voluntarily prolonged or assumed, and grew to be considered as an efficacious means for appeasing the divine wrath and restoring prosperity and peace.

No wonder that under influences so strong as these the observance of religious fasts established itself in the world at a very early period, and is found to have prevailed in most of the nations of antiquity.

In such a religion as Moses was commissioned by the creator of the world to offer to the chosen people, it was not likely that an observance which, such as fasts, seems to have had its origin in false and heathen conceptions, should hold a very prominent position, or be invested with much importance. There is but one fast enjoined by the great Hebrew lawgiver. And this injunction we are disposed to place among those things which Moses allowed rather than originated, bore with rather than approved, in consideration of the force of established custom, and from a wise fear of defeating his own good ends by attempting too much. The manner in which this observance is spoken of in Scripture (Lev. xvi. 29; xxiii. 27) seems to imply that it was no new institution that the lawgiver was establishing, but merely an old and well-known practice, to which he gave a modified sanction. Had it been otherwise, had the law been a new one, details would have been both needed and given, as is customary with Moses in his injunctions. Instead of that the children of Israel are required in general terms to 'afflict their souls.' But this language is not only vague, it is figurative, and could have no definite meaning unless to persons with whom afflicting the soul was in general use. This fact is established by the consideration that the words convey no definite ideas to the English reader unless when explained in the light of Hebrew antiquity. There seems, however, no reason to doubt that 'to afflict the soul' (נָפְשׁוֹ) in the Septuagint, ταπεινῶν τῆν ψυχῆν bore with it the

meaning of fasting. To a mere English reader the phrase seems to comprise all kinds of voluntary mortifications, but 'soul' in Hebrew not seldom denotes the 'appetite' (Prov. xxvii. 7). Accordingly the words regard immediately abstinence from food, and most probably (so far as they go) nothing more.

The sole fast required by Moses was on the great day of annual atonement. This observance seems always to have retained some prominence as 'the fast' (Acts xxvii. 9). But what the observance of the enjoined duty involved we are nowhere expressly informed, and can approximate to a knowledge of precise details only so far as later practices among the Jews may be considered as affording a faithful picture of this divinely sanctioned ordinance. In these remarks the opinion is implied that 'the fast,' whatever importance it may have subsequently acquired, was originally only an incident, not to say an accident, in the great solemnity of the annual atonement. Other general fasts, however, were in course of ages introduced, which were celebrated at fixed times every successive year. In the reign of Zedekiah Nebuchadnezzar besieged and captured Jerusalem, which calamity led to the establishment of a fast on the seventeenth day of the fourth month (Thammuz, July), (Jer. lii. 6, 7; Zech. viii. 19). In the last passage other fasts are enumerated, namely, 'the fast of the fifth, and the fast of the seventh, and the fast of the tenth.' That of the fifth month (Ab, August) was held on the ninth day, in mournful commemoration of the burning of the city by 'Nebuzar-adan, a servant of the king of Babylon,' who 'burnt the house of the Lord, and the king's house, and all the houses of Jerusalem, and every great man's house' (2 Kings xxv. 8, sq.; Jer. lii. 12; Zech. vii. 3-5; viii. 19). The fast of the seventh month (Tishri, October) was established to bewail the murder of Gedaliah at Mizpah (Jer. xli. 1, sq.; 2 Kings xxv. 25). That of the tenth month (Tebeth, January) was held on the tenth day to commemorate the commencement of the siege of Jerusalem on the part of Nebuchadnezzar (2 Kings xxv. 1; Zech. viii. 19; see also Hieron. *ad Zech. c. viii.*, and *Hieros. Taanith*, 68; Reland, p. 471).

On particular and signal occasions extraordinary fasts were appointed. Thus when Naboth was condemned for blasphemy because he would not give up the inheritance of his fathers to Ahab, Jezebel, as a part of her plan for gratifying the evil desires of her royal husband, ordered a fast to be proclaimed (1 Kings xxi. 9; comp. Jer. xxxvi. 9; 2 Chron. xx. 3). So in Judges xx. 26, the children of Israel 'came unto the house of God and wept, and sat there before the Lord and fasted until even, and offered burnt-offerings and peace-offerings before the Lord,' when they had suffered a calamitous defeat at the hands of the Benjamites. Other instances of fasting on occasion of loss in battle may be found in 1 Sam. xxxi. 11-13; Baruch i. 5. In Joel i. ii. a fast is enjoined with a view to turn away the wrath of God as displayed in the terrible consequences of the invasion of the land of Judæa by an army of devastating locusts (Credner's *Joel*). The notion also prevailed that a special fast might have the effect of averting the divine displeasure and securing the divine co-

operation in any great undertaking (Jonah iii. 5; 1 Sam. vii. 5, 6, 8, 10, 12; 1 Macc. iii. 47; 2 Macc. xiii. 12; Judith iv. 11; vi. 19). Local fasts were at a later period sometimes held in order to avert calamity or procure a favour from heaven; and the Sanhedrim ordered general fasts when the nation was threatened with any great evil, such as drought or famine (Joseph. *Vit.* § 56; *Taanith*, i. 5), as was usual with the Romans in their supplications (Liv. iii. 7; x. 23; Smith's *Dict. of Greek and Roman Antiq.*).

There were also private fasts, though the Mosaic law did not require them. They were held in connection with individual or family incidents, and agreed in aim and tendency with fasts of a general and public nature. Examples may be found in 1 Sam. i. 7; xx. 34; 1 Kings xxi. 9; Ez. x. 6; Neh. i. 4. After the exile private fasts became very frequent (Lightfoot, p. 318), awaiting the call of no special occasion, but entering as a regular part of the current religious worship (Suet. *Aug.* 76; Tacit. *Hist. v.* 4. 3). In Judith viii. 6, we read that Judith fasted all the days of her widowhood, 'save the eves of the sabbaths, and the sabbaths, and the eves of the new moons, and the new moons, and the feasts and the solemn days of the house of Israel.' And in Tobit xii. prayer is declared to be good with fasting; see also Luke ii. 37; Matt. ix. 14. The parable of the Pharisee and Publican (Luke xviii. 9; comp. Matt. ix. 14) shows how much the Pharisees were given to voluntary and private fasts—'I fast twice a week.' The first was on the fifth day of the week, on which Moses ascended to the top of Mount Sinai; the second was on the second day, on which he came down (*Taanith*, ii. 9; *Hieros. Megillah*, 75. 1). The Essenes and the Therapeutæ also were much given to such observances (Philo, *Vit. Contempl.* p. 613; Euseb. *Præp. Evan.* ix. 3). Fasts were considered as a useful exercise in preparing the mind for special religious impressions. Thus Dan. x. 2, sq., 'In those days I Daniel was mourning three full weeks. I ate no pleasant bread, neither came flesh nor wine in my mouth. Then I lifted up my eyes and looked, and beheld a certain man, &c. (see also Acts xiii. 3; xiv. 23). From Matt. xvii. 21, 'Howbeit this kind (of demons) goeth not out but by prayer and fasting,' it would appear that the practice under consideration was considered in the days of Christ to act in certain special cases as an exorcism. Fasting was accompanied by the ordinary signs of grief among the Israelites, as may be seen in 1 Macc. iii. 47, 'Then they fasted that day and put on sackcloth, and cast ashes upon their heads and rent their clothes.' The fast ordinarily lasted from evening to evening, but was not observed on the sabbath or on festival days (Joseph. *Antiq.* iii. 10. 3; Judith viii. 6; *Mischn. Taanith*, ii. 10). The abstinence was either partial or total. In the case of the latter food was entirely foregone, but this ordinarily took place only in fasts of short duration; and abstinence from food in eastern climes is more easy and less detrimental (if not in some cases positively useful) than keeping from food would be with us in these cold, damp, northern regions (Esther iv. 16). In the case of partial abstinence the time was longer, the denial in degree less. When Daniel (x. 2) was 'mourning full three weeks,' he ate no 'plea-

sant bread, neither came *flesh* nor *wine* in my mouth.' There does not appear to have been any fixed and recognised periods during which these fasts endured. From one day to forty days fasts were observed. The latter period appears to have been regarded with feelings of peculiar sanctity, owing doubtless to certain events in Jewish history. Thus Moses 'was with the Lord on Mount Sinai forty days and forty nights, he did neither eat bread nor drink water' (Exod. xxxiv. 28). So Elijah (1 Kings xix. 8) 'arose and did eat and drink, and went in the strength of that meat forty days and forty nights unto Horeb the mount of God.' The same was the number of days that our Lord fasted in the desert in connection with his temptation (Matt. iv. 1-11; Mark i. 12, 13; Luke iv. 1-13). In the latter case the abstinence appears to have been entire, for Luke expressly declares he ate nothing—*καὶ οὐκ ἔφαγεν οὐδέν*. It does not appear to be a necessary inference from the other passages that Moses and Elijah wholly abstained from food during the said forty days. In Dan. i. 10-16, a passage is found which shows that abstaining from meat and wine did not imply total abstinence, for Daniel and his friends had 'pulse to eat and water to drink' (Wetstein, p. 270; De Wette, *Kritik der Mos. Ges.* p. 245).

We have already seen how qualified the sanction was which Moses gave to the observance of fasting as a religious duty. In the same spirit which actuated him, the prophets bore testimony against the lamentable abuses to which the practice was turned in the lapse of time and with the increase of social corruption (Isa. lviii. 4, sq.; Jer. xiv. 12; Zech. vii. 5). Continuing the same species of influence and perfecting that spirituality in religion which Moses began, our Lord rebuked the Pharisees sternly for their outward and hypocritical pretences in the fasts which they observed (Matt. vi. 16, sq.), and actually abstained from appointing any fast whatever as a part of his own religion. In Matt. ix. 14, the question of the reason of this avoidance is expressly put—'Why do we (the disciples of John) and the Pharisees fast oft, but thy disciples fast not?' The answer involves an entire disapproval of fasting in the Christian Church—'Can the children of the bride-chamber fast?' It is true that a period is alluded to when these children 'shall fast'; but the general scope of the passage, taken in connection with the fact that Christ's disciples fasted not, and with the other fact, that while John (Matt. xi. 18, 19) 'came neither eating nor drinking,' the son of man 'came eating and drinking,' clearly shows that our Lord, as he signified his disapproval of religious fasting, so by the assertion that a time would come when, being deprived of the (personal presence of the) bridegroom, his disciples would fast, meant to intimate the approach of a period of general mourning, and employed the term 'fast' derivatively to signify rather sorrow of mind than any corporeal self-denial (Neander, *Leben Jesu*, pp. 231, 305). From the passages in question this at least is clear, that Jesus ascribed to fasts no essential worth, nor required any such observance from his followers. Whether and how far he *allowed* fasting as a means of religious improvement, is a question which our space does not permit us to discuss. That the early Christians observed the

ordinary fasts which the public practice of the day sanctioned, is clear from more than one passage in the New Testament Scriptures (Acts xiii. 2; xiv. 23; 2 Cor. vi. 5); but in this they probably did nothing more than yield obedience, as in general they thought themselves bound to do, to the law of their fathers so long as the Mosaic institutions remained entire. And though the great body of the Christian Church held themselves free from all ritual and ceremonial observances when God in his providence had brought Judaism to a termination in the rasure of the holy city and the closing of the temple, yet the practice of fasting thus originated might have easily and unobservedly been transmitted from year to year and from age to age, and that rather because so large a portion of the disciples being Jews (to say nothing of the influence of the Ebionites in the primitive church), thousands must have been accustomed to fasting from the earliest days of their existence, either in their own practice or the practice of their fathers, relatives, and associates.

Those who wish to prosecute the study of this religious observance among other nations, may consult Meiner, *Gesch. der Relig.* ii. 139; Lakenmacher, *Antiq. Græc. Sacr.* p. 626; Wachsmuth, *Hellen. Alterthum.* ii. 237; Böttiger, *Kunstmythol.* i. 132.—J. R. B.

FAT. In Lev. iii. there are minute details of the parts of victims which were to be specially appropriated to the altar. Among these all the internal fat is minutely specified, particularly the fat of the kidneys; and of external parts the tail of the sheep, which, in the common species of Western Asia, is a mass of fat (iii. 4, 9, 10, 15); and the whole concludes with 'All the fat is the Lord's; ye shall eat neither fat nor blood' (iii. 17). The reason assigned, namely, that the fat was consecrated to the altar, could only apply with respect to that of animals used in sacrifice, which were also usually employed for food. Accordingly, in Lev. vii. 2, we read, 'Ye shall eat no manner of fat of ox, or of sheep, or of goat,' which would seem to imply that the fat of *other* animals might be eaten; although it would appear that the Jews interpret the prohibition absolutely, as may be inferred from the fact that they rarely eat any other flesh than that of the animals thus indicated. One point seems to have been very generally overlooked, which is, that not fat absolutely but particular fat parts only are interdicted. They might eat the fat involved in the muscular tissue—in short, fat meat; and we know that animals were actually fattened for food (1 Kings iv. 23; Jer. xvi. 21; Luke xv. 23). This was, however, not a usual practice; and even at this day in the East, domestic cattle seldom undergo any preparatory feeding or fattening before being killed. Hence there is little fat in the carcase, except that belonging to the parts specified in the prohibition, which is all more or less of the nature of suet.

Various reasons have been assigned for this somewhat remarkable restriction. The secondary cause, that the fat was consecrated to the altar and therefore was to be abstained from, is not all, for it is usually considered that it was thus consecrated to give a religious sanction to a prohibition expedient on other grounds. The remark of Maimonides (*Mora Nevochim*), that men are generally fond of it, affords no satisfactory reason, unless it

were a principle of the law to forbid to men the things which they liked. The alleged fact of this general partiality might also be disputed: but the remark has point when the special reference to the fat rump of the Syrian sheep is considered, for that is highly prized. It affords a delicate marrowy fat, and is much used in pillaus and other messes which require to be lubricated by animal juices. The reason assigned by Michaelis, that the prohibition was designed to encourage the substitution of olive-oil for animal fat, and hence to promote agriculture among the Hebrews, and turn them from the habits of nomade life, is ingenious, but somewhat far-fetched. The truth probably is, that this suet or suet-like fat is not particularly wholesome or digestible in warm climates, if anywhere, and is particularly unsuitable for persons subject to cutaneous diseases, as the Israelites appear to have been at the time of their leaving Egypt.

'*Fatness*,' in Scripture, expresses plumpness or exuberance, whether in men, animals, or vegetables; and is hence often applied metaphorically to any kind of abundance, as to large possessions, or to excessive fertility in the earth.

FATHER. This word, besides its obvious and primary sense, bears, in Scripture, a number of other applications, most of which have, through the use of the Bible, become more or less common in all Christian countries.

1. The term *Father* is very often applied to God himself (Gen. xlv. 19, 20; Exod. i. 22; Deut. xxxii. 6; 2 Sam. vii. 44; Ps. lxxxix. 27, 28; Isa. lxiii. 16; lxiv. 8). Professor Lee states that it is only applied to God as having adopted the chosen people as his children; and he denies, with some harshness, that it is applied to him in the general sense as the Creator, and thence the *Father*, of all mankind (*Lex. s. v.* 28). Nevertheless, he admits that man's creation is occasionally mentioned in connection with this use of the word; and this, coupled with the clearer intimations of the New Testament, leaves little room to question that it is the intention of the sacred record to set God before us as the *Father* of all men, in the general sense of creator and preserver of all men, but more especially of believers, whether Jews or Christians. Indeed the analogy of language would point to this, seeing that in the Old Testament, and in all the Syro-Arabian dialects, the originator of anything is constantly called its father. To the same effect is also a passage in Josephus's paraphrase of the law (Deut. xxi. 18-21), respecting rebellious sons, *καὶ αὐτοὺς* (Θεὸς) *πατὴρ τοῦ παντὸς ἀνθρώπων γένους*, 'because he (God) is himself the father of the whole human race' (*Antiq.* iv. 8. 24).

Without doubt, however, God is in a more especial and intimate manner, even as by covenant, the *Father* of the Jews (Jer. xxxi. 9; Isa. lxiii. 63. 16; lxiv. 8; John viii. 41; v. 45; 2 Cor. vi. 18); and also of Christians, or rather of all pious and believing persons, who are called 'sons of God' (John i. 12; Rom. viii. 16, etc.). Thus Jesus, in speaking to his disciples, calls God their *Father* (Matt. vi. 4, 8, 15, 18; x. 20, 29; xiii. 43, etc.). The Apostles, also, for themselves and other Christians, call him '*Father*' (Rom. i. 7; 1 Cor. i. 3; 2 Cor. i. 2; Gal. i. 4; and many other places).

2. *Father* is applied to any ancestor near or remote, or to ancestors ('fathers') in general. The progenitor, or founder, or *patriarch* of a tribe

or nation, was also pre-eminently its father, as Abraham of the Jews. Examples of this abound. See, for instance, Deut. i. 11; 1 Kings viii. 12; Matt. iii. 9; xxiii. 30; Mark xi. 10; Luke i. 32, 73; vi. 23, 26; John vii. 22, &c.

3. *Father* is also applied as a title of respect to any head, chief, ruler, or elder, and especially to kings, prophets, and priests (Judg. xvii. 10; xviii. 19; 1 Sam. x. 12; 2 Kings ii. 12; v. 13; vi. 21; xiii. 14; Prov. iv. 1; Matt. xxiii. 9; Acts vii. 2; xxii. 1; 1 Cor. iv. 15, etc.).

4. The author, source, or beginner of anything is also called the *Father* of the same, or of those who follow him. Thus Jabal is called 'the father of those who dwell in tents, and have cattle;' and Jubal, 'the father of all such as handle the harp and the organ' (Gen. iv. 21, 22; comp. Job xxxviii. 28; John viii. 44; Rom. iv. 12). This use of the word is exceedingly common in the East to this day, especially as applied in the formation of proper names, in which, also, the most curious Hebrew examples of this usage occur [AB].

The authority of a father was very great in patriarchal times; and although the power of life and death was virtually taken from the parent by the law of Moses, which required him to bring his cause of complaint to the public tribunals (Deut. xxi. 18-21), all the more real powers of the paternal character were not only left unimpaired, but were made in a great degree the basis of the judicial polity which that law established. The children and even the grandchildren continued under the roof of the father and grandfather; they laboured on his account, and were the most submissive of his servants. The property of the soil, the power of judgment, the civil rights, belonged to him only, and his sons were merely his instruments and assistants. If a family be compared to a body, then the father was the head, and the sons the members, moving at his will and in his service. There were exceptions, doubtless; but this was the rule, and, with some modifications, it is still the rule throughout the East.

Filial duty and obedience were, indeed, in the eyes of the Jewish legislator, of such high importance that great care was taken that the paternal authority should not be weakened by the withdrawal of a power so liable to fatal and barbarous abuse as that of capital punishment. Any outrage against a parent—a blow, a curse, or incorrigible profligacy—was made a capital crime (Exod. xxi. 13, 17; Lev. xx. 9). If the offence was public it was taken up by the witnesses as a crime against Jehovah, and the culprit was brought before the magistrates, whether the parent consented or not; and if the offence was hidden within the paternal walls, it devolved on the parents to denounce him and to require his punishment.

It is a beautiful circumstance in the law of Moses that this filial respect is exacted for the mother as well as for the father. The threats and promises of the legislator distinguish not the one from the other; and the fifth commandment associates the father and mother in a precisely equal claim to honour from their children. The development of this interesting feature of the Mosaic law belongs, however, to another head [WOMEN]. See Cellerier, *Esprit de la Législation Mosaique*, ii. 69, 122-129.

FEASTS. This word comes to us immediately

from the French *fête*, which is an abbreviated form of the Latin *festum*—'Festus dies,' holyday or holiday. In the Greek we find *ἑορτή*, the original of *festum*; *ἑορτή* itself is from the noun *ἑορτία* (Latin *Vesta*), a hearth; so that the root-idea of the word is to be found in what we should term the pleasures of the table, the exercise of hospitality. But in all ages eating, drinking, and hospitality, have been connected with religious observances; while the meeting of friends, the enjoyments of the palate, and the exercise of the devotional affections, would conspire to make a festive holiday. In process of time some one of these elements would, in particular cases, be dropped. Thus the French word *fête* now scarcely comprises the idea of eating and drinking, and certainly involves very little of a religious nature, while with us *feast* denotes, at least in ordinary usage, scarcely any thing else than the pleasures which accompany the entertainments of hospitality. At an earlier period of our language, however, it retained much more of its original import, and is frequently used to indicate that which is now mostly conveyed by the word *festival*. In the common translation of the Scriptures it is repeatedly used in this manner; and accordingly we read in theological works of 'the *feast* of Passover,' 'the *feast* of Pentecost,' 'the *feast* of Lots,' &c. But as the word *feast* is now generally, if not exclusively, applied, in ordinary usage, to hospitable entertainments, we think we consult precision and perspicuity by speaking under the present head solely of such events, leaving the religious institutions of the Jews, sometimes so denominated, to be treated of under the now more appropriate term *Festival*.

To what an early date the practices of hospitality are referable may be seen in Gen. xix. 3, where we find Lot inviting the two angels—'Turn in, I pray you, into your servant's house and tarry all night, and wash your feet; and he pressed upon them greatly, and they entered into his house; and he made them a feast:' which was obviously of a religious nature, since it is added, 'and did bake *unleavened* bread, and they did eat' (Judg. vi. 19; and Winer, *Handwörterbuch*, s. v. Sauer-teig). It was usual not only thus to receive persons with choice viands, but also to dismiss them in a similar manner; accordingly Laban, when he had overtaken the fleeing Jacob, complains (Gen. xxxi. 27), 'Wherefore didst thou steal away from me and didst not tell me, that I might have sent thee away with mirth, and with songs, and with tabret, and with harp?' See also 2 Sam. iii. 20; 2 Kings vi. 23; Job viii. 20; 1 Macc. xvi. 15. This practice explains the reason why the prodigal, on his return, was welcomed by a feast (Luke xv. 23). Occasions of domestic joy were hailed with feasting; thus, in Gen. xxi. 8, Abraham 'made a great feast the same day that Isaac was weaned.' Birth-days were thus celebrated (Gen. xl. 20), 'Pharaoh, on his birth-day, made a feast unto all his servants' (Job i. 4; Matt. xiv. 6; comp. Herod. i. 133). Marriage-feasts were also common. Samson (Judg. xiv. 10) on such an occasion 'made a feast,' and it is added, 'for so used the young men to do.' So Laban, when he gave his daughter Leah to Jacob (Gen. xxix. 22), 'gathered together all the men of the place, and made a feast.' These festive occasions seem originally to have answered the important

purpose of serving as evidence and attestation of the events which they celebrated, on which account relatives and neighbours were invited to be present (Ruth iv. 10; John ii. 1). Those processes in rural occupations by which the Divine bounties are gathered into the hands of man, have in all ages been made seasons of festivity; accordingly, in 2 Sam. xiii. 23, Absalom invites all the king's sons, and even David himself, to a sheep-shearing feast, on which occasion the guests became 'merry with wine' (1 Sam. xxv. 2, sq.). The vintage was also celebrated with festive eating and drinking (Judg. ix. 27). Feasting at funerals existed among the Jews (2 Sam. iii. 33). In Jer. xvi. 7, among other funeral customs mention is made of 'the cup of consolation, to drink for their father or their mother,' which brings to mind the indulgence in spirituous liquors to which our ancestors were given, at interments, and which has not yet entirely disappeared in Lancashire, nor, probably, in Ireland (Carleton's *Irish Peasantry; England in the Nineteenth Century*, vol. ii.). To what an extent expense was sometimes carried on these occasions, may be learned from Josephus (*De Bell. Jud.* iv. 1. 1), who, having remarked that Archelaus 'mourned for his father seven days, and had given a very expensive funeral feast to the multitude,' states, 'which custom is the occasion of poverty to many of the Jews,' adding, 'because they are forced to feast the multitude, for if any one omits it he is not esteemed a holy person.'

As among heathen nations, so also among the Hebrews, feasting made a part of the observances which took place on occasion of animal sacrifices. In Deut. xii. 6, 7, after the Israelites are enjoined to bring to the place chosen of God, their burnt offerings, tithes, heave-offerings, vows, freewill offerings, and the firstlings of their herds and flocks they are told 'there shall ye eat before the Lord your God, and ye shall rejoice in all ye put your hand unto, ye and your households, wherein the Lord thy God hath blessed thee' (1 Sam. ix. 19; xvi. 3, 5; 2 Sam. vi. 19). These sacrificial meals were enjoyed in connection with peace-offerings, whether eucharistic or votive. The kidneys, and all the inward fat, and the tail of the lamb, were burnt in the daily sacrifice; the breast and right shoulder fell to the priest; and the rest was to be eaten by the offerer and his friends, on the same day if the offering were eucharistic, on that and the next day if it were votive (Lev. iii. 1-17; vii. 11-21; 29-36; xix. 5-8; xxii. 29, 30). To the feast at the second tithe of the produce of the land, which was to be made every year and eaten at the annual festivals before Jehovah, not only friends but strangers, widows, orphans, and Levites, were to be invited as well as the slaves. If the tabernacles were so distant as to make it inconvenient to carry thither the tithe, it was to be turned into money, which was to be spent at the place at which the festivals were held in providing feasts (Deut. xiv. 22-27; xii. 14; Tobit i. 6). Charitable entertainments were also provided, at the end of three years, from the tithe of the increase. The Levite, the stranger, the fatherless and the widow were to be present (Deut. xii. 17-19; xiv. 28, 29; xxvi. 12-15). At the feast of Pentecost the command is very express (Deut. xvi. 11), 'Thou shalt rejoice before the Lord thy God, thou, and thy son, and thy daughter, and thy man-servant, and thy maid-servant, and the Levite that is within thy

gates, and the stranger, and the fatherless, and the widow, that are among you.' Accordingly Tobit (ii. 1, 2) affirms, 'Now when I was come home again, in the feast of Pentecost, when I saw abundance of meat, I said to my son, go and bring what poor man soever thou shalt find out of our brethren, who is mindful of the Lord.' The Israelites were forbidden to partake of food offered in sacrifice to idols (Exod. xxxiv. 15), lest they should be thereby enticed into idolatry or appear to give a sanction to idolatrous observances (1 Cor. x. 28) [AGAPE].—J. R. B.

FELIX (Φῆλιξ), a Roman procurator of Judæa, before whom Paul so 'reasoned of righteousness, temperance, and judgment to come,' that the judge trembled, saying, 'Go thy way for this time; when I have a convenient season I will call for thee' (Acts xxiv. 25). The context states that Felix had expected a bribe from Paul; and, in order to procure this bribe, he appears to have had several interviews with the Apostle. The depravity which such an expectation implies is in agreement with the idea which the historical fragments preserved respecting Felix would lead the student to form of the man.

The year in which Felix entered on his office cannot be strictly determined. From the words of Josephus (*Antiq.* xx. 7. 1), it appears that his appointment took place before the twelfth year of the Emperor Claudius. Eusebius fixes the time of his actually undertaking his duties in the eleventh year of that monarch.

Felix was a remarkable instance of the elevation to distinguished station of persons born and bred in the lowest condition. Originally a slave, he rose to little less than kingly power. For some unknown, but probably not very creditable services, he was manumitted by Claudius Cæsar (Sueton. *Claud.* 28; Tacit. *Hist.* v. 9); on which account he is said to have taken the prænomen of Claudius. In Tacitus, however (*loc. cit.*), he is surnamed Antonius, probably because he was also a freedman of Antonia, the emperor's mother. He was a brother of Pallas, who had also been set free by Antonia, and had great influence with Claudius; speaking of whom, in conjunction with another freedman, namely, Narcissus, the imperial private secretary, Suetonius (*Claud.* 28) says that the emperor was eager in heaping upon them the highest honours that a subject could enjoy, and suffered them to carry on a system of plunder and gain to such an extent, that, on complaining of the poverty of his exchequer, some one had the boldness to remark that he would abound in wealth if he were taken into partnership by his two favourite freedmen.

The character which the ancients have left of Felix is of a very dark complexion. Suetonius speaks of the military honours which the emperor loaded him with, and specifies his appointment as governor of the province of Judæa (*Claud.* 28); adding an innuendo, which loses nothing by its brevity, namely, that he was the husband of three queens or royal ladies (trium reginarum maritum). Tacitus, in his *History* (v. 9), declares that, during his governorship in Judæa, he indulged in all kinds of cruelty and lust, exercising regal power with the disposition of a slave; and, in his *Annals* (xii. 54), he represents Felix as considering himself licensed to commit any crime, relying on the influence which he possessed at court. The country

was ready for rebellion, and the unsuitable remedies which Felix applied served only to inflame the passions and to incite to crime. The contempt which he and Cumanus (who, according to Tacitus, governed Galilee while Felix ruled Samaria; but see Joseph. *Antiq.* xx. 7. 1) excited in the minds of the people, encouraged them to give free scope to the passions which arose from the old enmity between the Jews and Samaritans, while the two wily and base procurators were enriched by booty as if it had been spoils of war. This so far was a pleasant game to these men, but in the prosecution of it Roman soldiers lost their life, and, but for the intervention of Quadratus, governor of Syria, a rebellion would have been inevitable. A court martial was held to inquire into the causes of this disaffection, when Felix, one of the accused, was seen by the injured Jews among the judges, and even seated on the judgment-seat, placed there by the president, Quadratus, expressly to outface and deter the accusers and witnesses. Josephus (*Antiq.* xx. 8. 5) reports that under Felix the affairs of the country grew worse and worse. The land was filled with robbers and impostors who deluded the multitude. Felix used his power to repress these disorders to little purpose, since his own example gave no sanction to justice. Thus, having got one Dineas, leader of a band of assassins, into his hands, by a promise of impunity, he sent him to Rome to receive his punishment. Having a grudge against Jonathan, the high-priest, who had expostulated with him on his misuse, he made use of Doras, an intimate friend of Jonathan, in order to get him assassinated by a gang of villains, who joined the crowds that were going up to the temple worship,—a crime which led subsequently to countless evils, by the encouragement which it gave to the Sicarii, or leagued assassins of the day, to whose excesses Josephus ascribes, under Providence, the overthrow of the Jewish state. Among other crimes, some of these villains misled the people under the promise of performing miracles, and were punished by Felix. An Egyptian impostor, who escaped himself, was the occasion of the loss of life to four hundred followers, and of the loss of liberty to two hundred more, thus severely dealt with by Felix (Joseph. *Antiq.* xx. 8. 6; *De Bell. Jud.* ii. 13. 5; comp. Acts xxi. 38). A serious misunderstanding having arisen between the Jewish and the Syrian inhabitants of Cæsarea, Felix employed his troops, and slew and plundered till prevailed on to desist. His cruelty in this affair brought on him, after he was superseded by Festus, an accusation at Rome, which, however, he was enabled to render nugatory by the influence which his brother Pallas had, and exercised to the utmost, with the emperor Nero. Josephus, in his *Life* (§ iii.), reports that 'at the time when Felix was procurator of Judæa there were certain priests of my acquaintance, and very excellent persons they were, whom, on a small and trifling occasion, he had put into bonds and sent to Rome to plead their cause before Cæsar.'

While in his office, being inflamed by a passion for the beautiful Drusilla, a daughter of King Herod Agrippa, who was married to Azizus, king of Emesa, he employed one Simon, a magician, to use his arts in order to persuade her to forsake her husband and marry him, promising that if she would comply with his suit he would make

her a happy woman. Drusilla, partly impelled by a desire to avoid the envy of her sister, Berenice, was prevailed on to transgress the laws of her forefathers, and consented to a union with Felix. In this marriage a son was born, who was named Agrippa: both mother and son perished in an eruption of Mount Vesuvius, which took place in the days of Titus Caesar (Joseph. *Antiq.* xx. 7. 2). With this adulteress was Felix seated when Paul reasoned before the judge, as already stated (Acts xxiv. 24). Another Drusilla is mentioned by Tacitus as being the wife (the *first* wife) of Felix. This woman was niece of Cleopatra and Antony. By this marriage Felix was connected with Claudius. Of his third wife nothing is known.

Paul, being apprehended in Jerusalem, was sent by a letter from Claudius Lysias to Felix at Cæsarea, where he was at first confined in Herod's judgment-hall till his accusers came. They arrived. Tertullus appeared as their spokesman, and had the audacity, in order to conciliate the good will of Felix, to express gratitude on the part of the Jews, 'seeing that by thee we enjoy great quietness, and that very worthy deeds are done unto this nation by thy providence' (Acts xxiii. xxiv.). Paul pleaded his cause in a worthy speech; and Felix, consigning the Apostle to the custody of a centurion, ordered that he should have such liberty as the circumstances admitted, with permission that his acquaintance might see him and minister to his wants. This imprisonment the Apostle suffered for a period of two years, being left bound when Felix gave place to Festus, as that unjust judge 'was willing,' not to do what was right, but 'to show the Jews a pleasure' (C. W. F. Walch, *Diss. de Felice Jud. procur. Jen.* 1747).—J. R. B.

FERRET. [LIZARD.]

FESTIVALS (פִּסְטִימוֹת). The Hebrew festivals were occasions of public religious observances, recurring at certain set and somewhat distant intervals. In general they may be divided into two kinds:—1. Those of divine institution; 2. Those of human origin. Those which owe their existence to the authority of God are, the seventh day of the week, or the Sabbath; the Passover; Pentecost; the Feast of Trumpets; the Day of Atonement; the Feast of Tabernacles; the New Moon. Festivals which arose under purely human influences are, the Feast of Lots, or Purim; the Death of Holofernes; the Dedication; the Sacred Fire; the Death of Nicanor.

Reserving details for separate articles on such of these as shall seem to require and justify a distinct treatment, we confine ourselves here to a general outline, with some remarks on the origin and tendency of the chief festivals.

We have inserted the Sabbath for the sake of completeness, and, with the same view, we proceed to set down a few brief particulars respecting the daily service, so that we may at once present a general outline of the temple worship.

At the daily service two lambs of the first year were to be offered at the door of the tabernacle; one in the morning, the other in the evening, a continual burnt-offering. With each lamb was to be offered one-tenth of an ephah of flour, mingled with one-fourth of a hin of fresh oil, for a meat-offering, and one-fourth of a hin of wine for a drink-offering. Frankincense was to be placed on

the meat-offering, a handful of which, with the frankincense, was to be burnt, and the remainder was to be eaten by the priest in the holy place, without leaven. The priests were to offer daily the tenth of an ephah of fine flour, half in the morning and half in the evening, for themselves. The high-priest was to dress the lamps in the tabernacle every morning, and light them every evening; and at the same time burn incense on the altar of incense. The people provided oil for the lamps which were to burn from evening to morning; the ashes were removed by a priest, dressed in his linen garment and his linen drawers, and then carried by him out of the camp, in his common dress. Great stress was laid on the regular observance of these requirements (Num. xxviii. 1-8; Exod. xxix. 38-42; Lev. vi. 8-23; Exod. xxx. 7-9; xxvii. 20; Lev. xxiv. 1-4; Num. viii. 2).

Labour was to last not longer than six days. The seventh was a Sabbath, a day of rest, of holy convocation, on which no one, not even strangers or cattle, was allowed to do any servile work. The offender was liable to stoning.

On the Sabbath two lambs of the first year, without blemish, were to be offered for a burnt-offering, morning and evening, with two-tenths of an ephah of flour, mingled with oil, for a meat-offering, and one-half of a hin of wine for a drink-offering, thus doubling the offering for ordinary days. Twelve cakes of fine flour were to be placed every Sabbath upon the table in the tabernacle, in two piles, and pure frankincense laid on the uppermost of each pile. These were to be furnished by the people; two were offered to Jehovah, the rest were eaten by the priests in the holy place (Exod. xxxi. 12; Lev. xxiii. 1; xxvi. 2; Exod. xix. 3-30; xx. 8-11; xxiii. 12; Deut. v. 12-15; Lev. xxiii. 3; xxiv. 5-9; Num. xv. 35; xxviii. 9).

At the *New Moon* festival, in the beginning of the month, in addition to the daily sacrifice, two heifers, one ram, and seven lambs of the first year, were to be offered as burnt-offerings, with three-tenths of an ephah of flour, mingled with oil, for each heifer; two-tenths of an ephah of flour, mingled with oil, for the ram; and one-tenth of an ephah of flour, mingled with oil, for every lamb; and a drink-offering of half of a hin of wine for a heifer, one-third of a hin for the ram, and one-fourth of a hin for every lamb. One kid of the goats was also to be offered as a sin-offering.

The first day of the *seventh month* was to be a Sabbath, a holy convocation, accompanied by the *blowing of trumpets*. In addition to the daily and monthly sacrifices, one ram and seven lambs were to be offered as burnt-offerings, with their respective meat-offerings, as at the usual New Moon festival (Num. xxviii. 11-15; xxix. 1-6; Lev. xxiii. 23-25).

Three times in the year—at the Feast of Unleavened Bread, in the month Abib; at the Feast of Harvest, or of Weeks; and at the Feast of Ingathering, or of Tabernacles—all the males were to appear before Jehovah, at the place which he should choose. None were to come empty-handed, but every one was to give according as Jehovah had blessed him; and there before Jehovah was every one to rejoice with his family, the Levite, the stranger, the fatherless, and the widow (Exod. xxxiii. 14-17; xxiv. 22-24; Deut. xvi. 16, 17).

The first of these three great festivals, that of Unleavened Bread, called also the Passover, was kept in the month Abib, in commemoration of the rescue of the Israelites by Jehovah out of Egypt, which took place in that month. The ceremonies that were connected with it will be detailed under the head *PASSOVER*. Every one who was ritually clean, and not on a journey, and yet omitted to keep the Passover, was to be cut off from the people. Any one who was disabled for the observance, either by uncleanness or being on a journey, was to keep the Passover on the fourteenth day of the next month. In order to make the season more remarkable, it was ordained that henceforward the month in which it took place should be reckoned the first of the national religious year (Exod. xii. 2). From this time, accordingly, the year began in the month Abib, or Nisan (March—April), while the civil year continued to be reckoned from Tishri (September—October) (Exod. xiii. 3, 14, 27; 43-49; Lev. xxiii. 5; Num. xxviii. 16; Deut. xvi. 1-7). The Passover lasted one week, including two Sabbaths (De Wette, *Archäol.* p. 214). The first day and the last were holy, that is, devoted to the observances in the public temple, and to rest from all labour (Exod. xii. 16; Lev. xxiii. 6; Num. xxviii. 18; Deut. xvi. 8).

On the day after the Sabbath, on the Feast of Passover, a sheaf of the first fruits of the barley harvest was to be brought to the priest to be waved before Jehovah, accompanied by a burnt-offering. Till this sheaf was presented, neither bread nor parched corn, nor full ripe ears of the harvest, could be eaten (Exod. xii. 15-20; xiii. 6-10; Lev. xiii. 6-8; Deut. xvi. 2-8; Num. xxviii. 17-25).

The Feast of Pentecost or of Weeks was kept to Jehovah at the end of seven weeks from the day of the Festival of Unleavened Bread, on which the sheaf was presented. On the morrow after the seventh complete week, or on the fiftieth day, two wave loaves were presented as first fruits of the wheat-harvest, together with a burnt-offering, a sin-offering, and a peace-offering, &c. The day was a holy convocation, in which no servile work was done. The festival lasted but one day. It is said to have been designed to commemorate the giving of the law on Mount Sinai (Brown's *Antiquities of the Jews*, vol. i. p. 494; Deut. xvi. 9-11; Lev. xiii. 15-21; Num. xxviii. 26-31; xv. 17-21).

The Feast of In-gathering or of Tabernacles began on the fifteenth day of the seventh month, and continued eight days, the first and last being Sabbaths. During the feast all native Israelites dwelt in booths made of the shoots of beautiful trees, palm-branches, boughs of thick-leaved trees, and of the willows of the brook, when they rejoiced with their families, with the Levite, the stranger, the fatherless, and the widow, before Jehovah. Various offerings were made. At the end of every seven years, in the year of release, at the Feast of Tabernacles, the law was required to be read by the priests in the hearing of all the Israelites (Deut. xvi. 13-15; xxxi. 10-13; Lev. xxiii. 39-43; 33-36; Num. xxix. 12-38, 40).

The Feast of Tabernacles was appointed partly to be an occasion of annual thanksgiving after the in-gathering of the harvest (Exod. xxxiv. 22; Lev. xxiii. 39; Deut. xvi. 13), and partly to remind the Israelites that their fathers had lived

in tents in the wilderness (Lev. xxiii. 40-43). This feast took place in the end of the year, September or October.

The tenth day of the seventh month was the Day of Atonement—a day of abstinence, a day of holy convocation, in which all were to afflict themselves. Special offerings were made [*ATONEMENT*] (Lev. xxiii. 26-32; xvi. 1, 31; Num. xxix. 7-11; Exod. xxx. 10).

Brown, in his *Antiquities* (vol. i. p. 520), remarks that the time of the year in which the three great festivals were observed was during the dry season of Judæa. The latter rains fell before the Passover, the former rains after the Feast of Tabernacles; so that the country was in the best state for travelling at the time of these festivals.

On these solemn occasions food came partly from hospitality (a splendid instance of which may be found in 2 Chron. xxxv. 7-9), partly from the feasts which accompanied the sacrifices in the temple, and partly also from provision expressly made by the travellers themselves. It appears that the pilgrims to Mecca carry with them every kind of food that they need, except flesh, which they procure in the city itself. Lodging, too, was afforded by friends, or found in tents erected for the purpose in and around Jerusalem (*Helon's Pilgrimage*; Brown's *Antiquities*).

The three great festivals have corresponding events (but of far greater importance) in the new dispensation. The Feast of Tabernacles was the time when our Saviour was born; he was crucified at the Passover; while at Pentecost the effusion of the Holy Spirit took place.

Brown (*Antiquities*, vol. i. p. 522) has spoken of the defenceless state in which the country lay when all the males were gathered together at Jerusalem. What was to prevent an enemy from devastating the land, and slaying women and children? He refers the protection of the country to the express interposition of God, citing 'the promise,' as found in Exod. xxxiv. 23, 24. He adds, 'During the whole period between Moses and Christ we never read of an enemy invading the land at the time of the three festivals. The first instance on record was thirty-three years after they had withdrawn from themselves the divine protection by imbruing their hands in the Saviour's blood, when Cestius, the Roman general, slew fifty of the people of Lydda, while all the rest were gone up to the Feast of Tabernacles, A.D. 66 (Joseph. *De Bell. Jud.* ii. 19).

The objection, however, which this writer thus meets is founded on the assumption that the law was strictly, uniformly, and lastingly obeyed. But the requirement that all males should appear three times a year before Jehovah is not without some practical difficulty. During the sojourn in the wilderness its observance would not only be easy, but highly useful in preventing the dispersion of individuals or numbers from the main body—an influence the more needful because many persons would, doubtless, stray from time to time in search of pasture. In subsequent and more settled times it must have been a serious inconvenience for all the males of the nation to leave their families unprotected and their business neglected for so many days every year as would be necessary in going to and from Jerusalem. It is true that the seasons of the festivals were well fixed and distributed for the convenience of an

agricultural people—the Passover taking place just before barley-harvest; Pentecost immediately after the same; and Tabernacles after the wheat-harvest; while in winter, when travelling was very difficult, there was no festival. Yet to have to visit Jerusalem thrice in seven months was a serious thing, especially in later times, when Israelites were scattered far abroad. Even if the expense was, as Winer thinks (*Handwörterbuch*), a small consideration, yet the interruption to domestic life and the pursuits of business must have been very great; nor would it be an exaggeration to say that the observance was an impossibility to the Jews, for instance, who were in Babylon, Egypt, Italy, Macedonia, Asia Minor, &c. How far the law was rigorously enforced or strictly obeyed at any time after the settlement in Palestine, it would not be easy to say. Palfrey (*Lectures on the Jewish Scrip.* vol. i. p. 199) supposes that ‘a man might well be said to have virtually executed this duty who appeared before the Lord (not in person, but) with his offerings, sent by the hand of a friend, as a suitor is said in our common speech to appear in a court of justice, when he is represented there by his attorney;’ a conjecture which, to our mind, savours too much of modern ideas and usages. That some relaxation took place, at least in ‘the latter days,’ appears from John vii. 8, in which more or less of what is voluntary is obviously connected in the mind and practice of our Lord with ‘the feast,’ though, it must be allowed that the passage is an evidence of the general observance, not to say the universal obligation, in his days, of at least the Feast of Tabernacles.

If, however, there was in practice some abatement from the strict requirements of the law, yet obviously time enough was saved from labour by the strong hand of religion, to secure to the labourer a degree of most desirable and enviable rest. Not, indeed, that all the days set apart were emancipated from labour. At the Feast of Tabernacles, for instance, labour is interdicted only on the first and the last day. So on other occasions business and pleasure were pursued in connection with religious observances. But if all males appeared before Jehovah, even only once a year, they must, in going and returning, as well as in being present at the festival, have spent no small portion of time in abstinence from their ordinary pursuits, and could not have failed to derive singular advantages alike to their bodies and their minds.

The rest and recreation would be the more pleasant, salutary, and beneficial, because of the joyous nature of the religious services in which they were, for the greater part, engaged. These solemn festivals were not only commemorations of great national events, but they were occasions for the reunion of friends, for the enjoyment of hospitality, and for the interchange of kindness. The feasts which accompanied the sacrifices opened the heart of the entire family to joy, and gave a welcome which bore a religious sanction, even to the stranger, the fatherless, and the widow (Michaelis, *Mos. Recht*, art. 199).

How much, too, would these gatherings tend to foster and sustain a spirit of nationality! By intercourse the feelings of tribe and clan would be worn away; men from different parts became acquainted with and attached to each other; par-

tial interests were found to be more imaginary than real; while the predominant idea of a common faith and a common rallying-place at Jerusalem, could not fail to fuse into one strong and overpowering emotion of national and brotherly love, all the higher, nay, even the lower feelings, of each Hebrew heart.

‘If,’ says Michaelis (*Mos. Recht*, art. 198, Smith’s Transl.), ‘any of the tribes happened to be jealous of each other or involved in civil war, their meeting together in one place for the purposes of religion and sociality, had a tendency to prevent their being totally alienated; and even though this had happened, it gave them an opportunity of re-uniting.’ He adds that ‘the separation of the ten tribes from the tribes of Judah under Rehoboam and Jeroboam could never have been permanent, had not the latter abrogated one part of the law of Moses relative to festivals. In order to perpetuate the separation, he prohibited the annual pilgrimages to Jerusalem, and appointed two places for divine service within his own territories’ (1 Kings xii. 27-30). ‘He also,’ adds Michaelis, ‘transferred the celebration of the feast of Tabernacles, and probably the other two festivals likewise, to a different season from that appointed by Moses’ (1 Kings xii. 33).

Another effect of these festivals Michaelis has found in the furtherance of internal commerce. They would give rise to something resembling our modern fairs. Among the Mahometans similar festivals have had this effect.

In Article 199, the same learned writer treats of the important influence which the festivals had on the Calendar, and the correction of its errors.

These festivals, in their origin, had an obvious connection with agriculture. Passover saw the harvest upon the soil; at Pentecost it was ripe; and Tabernacles was the festival of gratitude for the fruitage and vintage (Michaelis, art. 197). The first was a natural pause after the labours of the field were completed; the second, after the first-fruits were gathered; and the third, a time of rejoicing in the feeling that the Divine bounty had crowned the year with its goodness. Spring, summer, and autumn, which have moved all nations of men with peculiar and characteristic emotions, had each its natural language and symbols in the great Israelitish festivals, a regard to which may well be supposed to have had an influence in the mind of the legislator, as well as in the consuetudinary practices of the people. How far a merely natural influence prevailed in these observances, how far Moses found consuetudinary usages, which, in establishing these festivals, he adopted with such modifications and sanctions as he judged best, and had at his command, it is at this period impossible to determine, and no great aid, probably, can be derived in the case from the practices of other nations; but the reader who wishes to investigate the subject in this view may consult a recent work entitled *De Feriarum Hebræarum origine ac ratione*, auctore H. Ewald; Göttinge, 1841; and Creuzer, *Symbol.* ii. 597.

The Feast of Purim or of Lots originated in the gratitude of the Jews in escaping the plot of Haman, designed for their destruction. It took its name from the lots which were cast before Haman by the astrologers, who knew his hatred against Mordecai and his wish to destroy his

family and nation (Esther iii. 7; ix. 2, 5). The feast was suggested by Esther and Mordecai, and was celebrated on the 13th, 14th and 15th days of the twelfth month (Adar). The 13th was a fast, being the day on which the Jews were to have been destroyed; and the 14th and 15th were a feast held in commemoration of their deliverance. The fast is called the Fast of Esther, and the feast still holds the name of Purim. Prideaux (*Connex.*; Brown, *Antiq.* i. 575) styles it the Bacchanalia of the Jews.

The slaughter of Holofernes by the hand of Judith, the consequent defeat of the Assyrians, and the liberation of the Jews, were commemorated by the institution of a festival (Judith xiv. xv).

The Feast of Dedication was appointed by Judas Maccabæus, on occasion of the purification of the temple, and reconstruction of the altar, after they had been polluted by Antiochus Epiphanes. The hatred of this monarch towards the Jews had been manifested in various ways: he forbade their children to be circumcised, restrained them in the exercise of their religion, killed many who disobeyed his mandates, burnt the books of the law, set up idolatry, carried off the altar of incense, the shewbread-table, and the golden candlestick, with the other vessels and treasures of the temple; and went to such extremes as to sacrifice a sow upon the altar of burnt-offerings, build a heathen altar on the top of that sacred pile, and with broth of swine's flesh to sprinkle the courts and the temple (1 Macc. i.; 2 Macc. v.; Prideaux, *sub* a.c. 167-8, 170).

The new dedication took place on the 25th day of the ninth month, called Chisleu, in the year before Christ 170. This would be in December. The day was chosen as being that on which Antiochus, three years before, had polluted the altar by heathen sacrifices.

The joy of the Israelites must have been great on the occasion, and well may they have prolonged the observance of it for eight days. A general illumination formed a part of the festival, whence it obtained the name of the Feast of Lights.

In John x. 22 this festival is alluded to when our Lord is said to have been present at the Feast of Dedication. The historian marks the time by stating 'it was winter.'

The festival 'of the Fire' was instituted by Nehemiah to commemorate the miraculous rekindling of the altar-fire. The circumstances are narrated in 2 Macc. i. 18.

The defeat by Judas Maccabæus of the Greeks when the Jews 'smote off Nicanor's head and his right hand which he stretched out so proudly,' caused the people to 'rejoice greatly, and they kept that day a day of great gladness; moreover, they ordained to keep yearly this day, being the thirteenth day of Adar'—February or March (1 Macc. vii. 47).

Some other minor fasts and festivals may be found noticed in Brown's *Antiquities*, i. 586; and in Simon's *Dictionnaire de la Bible*, art. 'Fêtes.'—J. R. B.

FESTUS. Porcius Festus was the successor of Felix as the Roman governor of Judæa, to the duties of which office he was appointed by the emperor Nero (Joseph. *Antiq.* xx. 8. 9; *De Bell. Jud.* ii. 1. 1) in the first year of his reign (Winer, *Handwörterbuch*, in voc.). One of his first official acts was hearing the case of the apostle Paul,

who had been left in prison by his predecessor. He was at least not a thoroughly corrupt judge; for when the Jewish hierarchy begged him to send for Paul to Jerusalem, and thus afford an opportunity for his being assassinated on the road, he gave a refusal, promising to investigate the facts at Cæsarea, where Paul was in custody, alleging to them, 'it is not the manner of the Romans to deliver any man to die before that he which is accused have the accusers face to face, and have licence to answer for himself concerning the crime laid against him' (Acts xxv. 16). On reaching Cæsarea he sent for Paul, heard what he had to say, and, finding that the matters which 'his accusers had against him' were 'questions of their own superstition, and of one Jesus which was dead, whom Paul affirmed to be alive,' he asked the apostle whether he was willing to go to Jerusalem, and there be tried, since Festus did not feel himself skilled in such an affair. Paul, doubtless because he was unwilling to put himself into the hands of his implacable enemies, requested 'to be reserved unto the hearing of Augustus,' and was in consequence kept in custody till Festus had an opportunity to send him to Cæsar. Agrippa, however, with his wife Bernice, having come to salute Festus on his new appointment, expressed a desire to see and 'hear the man.' Accordingly Paul was brought before Festus, Agrippa, and Bernice, made a famous speech, and was declared innocent. But having appealed to Cæsar, he was sent to Rome.

Festus, on coming into Judæa, found the country infested with robbers, who plundered the villages and set them on fire; the Siarii also were numerous. Many of both classes were captured, and put to death by Festus. He also sent forces, both of horse and foot, to fall upon those that had been seduced by a certain impostor, who promised them deliverance and freedom from the miseries they were under if they would but follow him as far as the wilderness. These troops destroyed both the impostor and his dupes.

King Agrippa had built himself a splendid dining-room, which was so placed that, as he reclined at his meals, he commanded a view of what was done in the Temple. The priests, being displeased, erected a wall so as to exclude the monarch's eye. On which Festus took part with Agrippa against the priests, and ordered the wall to be pulled down. The priests appealed to Nero, who suffered the wall to remain, being influenced by his wife Poppæa, 'who was a religious woman' (Joseph. *Antiq.* xx. 8. 11). Festus died shortly afterwards. The manner in which Josephus speaks is favourable to his character as a governor (*De Bell. Jud.* iv. 14. 1)—

J R. B.

FIGS. [FRUITS.]

FIG-TREE. [TEENAH.]

FIGURES. [TYPES.]

FIRE. [BEROSH.]

FIRE. Besides the ordinary senses of the word 'fire,' which need no explanation, there are other uses of it in Scripture which require to be discriminated. The destructive energies of this element and the torment which it inflicts, rendered it a fit symbol of—1. Whatever does damage and consumes (Prov. xvi. 27; Isa. ix. 18);—2. Of severe trials, vexations, and misfor-

tunes (Zech. xii. 9; 1 Cor. iii. 13, 15; 1 Pet. i. 7);—3. Of the punishments beyond the grave (Matt. v. 22; Mark ix. 44; Rev. xiv. 10; xxi. 8) [HELL].

'Fire from heaven,' 'fire of the Lord,' usually denotes lightning in the Old Testament; but, when connected with sacrifices, the 'fire of the Lord' is often to be understood as the fire of the altar, and sometimes the holocaust itself (Exod. xxix. 18; Lev. i. 9; ii. 3; iii. 5, 9; Num. xxviii. 6; 1 Sam. ii. 28; Isa. xx. 16; Mal. i. 10).

The uses of fire among the Hebrews were various:—

1. The domestic use, for cooking, roasting, and baking [BREAD; FOOD].

2. In winter they warmed themselves and their apartments by 'a fire of coals' (Jer. xxxvi. 22, 23; Luke xxii. 30). In the rooms it would seem that a brazier with charcoal was usually employed, as is still the case in western Asia, although the ovens and fire-places used in baking bread might have been, and doubtless were, as now, often employed to keep rooms properly warm [BREAD; COAL].

3. The religious use of fire was for consuming the victims on the altar of burnt-offerings, and in burning the incense on the golden altar: hence the remarkable phrase in Isa. xxxi. 9—'the Lord, whose fire is in Zion, and his furnace in Jerusalem.'

4. In time of war torches were often carried by the soldiers; which explains the use of torches in the attack of Gideon upon the camp of the Midianites (Judg. vii. 6). This military use of torches was very general among ancient nations, and is alluded to by many of their writers (Statius, *Theb.* iv. 5. 7; Stobæus, *Serm.* p. 194; Michaelis, in *Symbol. Liter. Bremens.* iii. 254).

5. Burning criminals alive does not appear to have been known to the Hebrews; but as an additional disgrace the bodies were in particular cases burnt after death had been inflicted (Josh. vii. 25; compare verse 15); and it is in this sense that the allusions to burning as a punishment are to be understood, except when the reference is to a foreign usage, as in Dan. iii. 22, 24, sq.

6. In time of war towns were often destroyed by fire. This, as a war usage, belongs to all times and nations; but among the Hebrews there were some particular notions connected with it, as an act of strong abhorrence, or of devotion to abiding desolation. The principal instances historically commemorated are the destruction by fire of Jericho (Josh. vi. 24); Ai (Josh. viii. 19); Hazor (Josh. xi. 11); Laish (Judg. xviii. 27); the towns of the Benjamites (Judg. xx. 48); Ziklag, by the Amalekites (1 Sam. xxx. 1); Jazer, by Pharaoh (1 Kings ix. 16); and the temple and palaces of Jerusalem by Nebuchadnezzar (2 Kings xxv. 9). Even the war-chariots of the Canaanites were burnt by the Israelites, probably on the principle of precluding the possibility of recovery, by the enemy, of instruments of strength for which they had themselves no use. The frequency with which towns were fired in ancient warfare is shown by the very numerous threats by the prophets that the towns of Israel should be burned by their foreign enemies. Some great towns, not of Israel, are particularly named; and it would be an interesting task to trace, as far as the materials exist, the fulfilment of these pro-

phesies in those more marked examples. Among the places thus threatened we find Damascus (Isa. xliii. 12, 13), Gaza, Tyre, Teman (Amos i. 7, 10, 11). The temples and idols of a conquered town or people were very often burned by the victors, and this was enjoined as a duty to the Israelites (Deut. vii. 5, 25; xii. 13; xiii. 6; Isa. liii. 12, 13).

There were some special regulations respecting the use of fire among the Israelites. The most remarkable of these was the prohibition to light a fire on the Sabbath (Exod. xxxiii. 3). As the primary design of this law appears to have been to prevent the proper privileges of the Sabbath-day from being lost to any one through the care and time required in cooking victuals (Exod. xvi. 23), it is doubted whether the use of fire for warmth on the Sabbath-day was included in this interdiction. In practice, it would appear that the fire was never lighted or kept up for cooking on the Sabbath-day, and that consequently there were no fires in the houses during the Sabbaths of the greater part of the year; but it may be collected that, in winter, fires for warming apartments were kept up from the previous day. Michaelis is very much mistaken with respect to the climate of Palestine, in supposing that the inhabitants could, without much discomfort, dispense with fires for warmth during winter (*Mosaisches Recht*, iv. 195). The modern Jews, although there is no cooking in their houses, have fires on the Sabbath-day, which are attended to by a Christian servant; or a charwoman is hired to attend to the fires of several houses, which she visits repeatedly during the day.

Another law required the damage done by a conflagration in the fields to be made good by the party through whose inattention it had been kindled (Exod. xxii. 6). This was a most useful and necessary law in a country where the warmth and drought of summer soon render the herbage and underwood highly combustible, so that a fire once kindled often spreads most extensively, and produces disastrous consequences (Judg. ix. 15; xv. 5). This law was calculated to teach caution in the use of fire to the herdsmen in the fields, who were the parties most concerned. And it is to be remembered that the herdsmen were generally substantial persons, and had their assistant shepherds, for whose imprudence they were made responsible. Still no inference is to be drawn from this law with regard to fires breaking out in towns, the circumstances being so very different.

In the sacerdotal services no fire but that of the altar of burnt-offerings could lawfully be used. That fire was originally kindled supernaturally, and was ever after kept up. From it the fire used in the censers for burning incense was always taken; and for neglecting this and using common fire, Nadab and Abihu were struck dead by 'fire from heaven' (Lev. x. 8, sq.; Num. iii. 4, 26, 61).

Respecting 'passing through the fire,' see MOLOCH; and for the 'pillar of fire,' see EXODUS.

FIRMAMENT is the translation given in the Authorized Version and the Vulgate for the Hebrew רקיע *rakeeah* (Gen. i. 6), which is more fully defined by רקיע השמים (Gen. i. 14, 15, 17), that which is distended, expanded—the expanse of heaven, *i. e.* the visible arch or vault of heaven resting on the earth.

With some old astronomers the *firmament* is the orb of the fixed stars, or the highest of all the heavens. But in Scripture, and in common language, it is used for the middle regions, the space or expanse appearing like an arch immediately above us in the heavens. Many of the ancients, and of the moderns also, account the firmament a fluid substance; but those who gave it the name of 'firmament' must have regarded it as solid, and so we would infer from Gen. i. 6, where it forms the division between water and water.

Plato, in his *Timæus*, makes mention of the visible heaven under the notion of *τάρσις* (from *τείνω*, to extend), not unlike the Hebrew derivation.

The Hebrews seem to have considered the *firmament* as transparent, like a crystal or sapphire (Ezek. i. 22; Dan. xii. 3; Exod. xxiv. 10; Rev. iv. 6), thus making it different from the brazen or iron heaven of Homer.

In the Ptolemaic astronomy, the *firmament* is called the eighth heaven or sphere, with respect to the seven spheres of the planets, which it surrounds. It is supposed to have two motions, a diurnal motion imparted to it by the *primum mobile*, from east to west, about the poles of the ecliptic, and another opposite motion from west to east; which last is completed, according to Tycho, in 25,412 years; according to Ptolemy, in 36,000; and according to Copernicus, in 25,800; in which time the fixed stars return to the same points in which they were at the beginning. This period is called the *Platonic*, or *Great Year* [ASTRONOMY].—E. M.

FIRST-BORN. The privileges of the first-born son, among the Hebrews, are indicated under **BIRTHRIGHT**.

FIRST-FRUITS. There are various regulations in the law of Moses respecting first-fruits, which would be of much interest to us could we, in every case, discern the precise object in view. No doubt the leading object, as far as regards the offering of the first-fruits to God, was, that all the after-fruits and after-gatherings might be consecrated in and through them; and it was not less the dictate of a natural impulse that the first-fruits should be offered to God in testimony of thankfulness for his bounties. Hence we find some analogous custom among most nations in which material offerings were used. There are, however, some particulars in the Mosaic regulations which these considerations do not adequately explain.

1. **FIRST-FRUITS OF FRUIT-TREES.** It was directed that the first-fruits of every tree whose fruit was used for food, should, for the first three years of bearing, be counted 'uncircumcised,' and regarded as unclean (Lev. xix. 23, 24). It was unlawful to sell them, to eat them, or to make any benefit of them. It was only in the fourth year of bearing that they were accounted 'holy,' and the fruit of that year was made an offering of first-fruits, and was either given to the priests (Num. xviii. 12, 13), or, as the Jews themselves understand, was eaten by the owners of it 'before the Lord, at Jerusalem,' as was the case with second tithe. After the fourth year all fruits of trees were available for use by the owner. As the general principle of the law was, that only that which was perfect should be used in offerings, it is an obvious inference that the

fruits of trees were considered imperfect until the fourth year; and if so, the law may have had the ulterior object of excluding from use crude, immature, and therefore unwholesome fruits. 'Michaelis (iii. 267-8), indeed, finds a benefit to the trees themselves in this regulation: 'The economical object of the law is very striking. Every gardener will teach us not to let fruit-tree bear in their earliest years, but to pluck off the blossoms; and for this reason, that they will thus thrive the better, and bear more abundantly afterwards, since, if we may not taste the fruit the first three years, we shall be the more disposed to pinch off the blossoms, and the son will learn to do this of his father. The very expression "to regard them as uncircumcised," suggests the propriety of pinching them off; I do not say cutting them off, because it is generally the hand and not a knife that is employed in the operation.'

2. **FIRST-FRUITS OF THE YEARLY INCREASE.** Of these there were two kinds—1. *The first-fruits in the sheaf* (Lev. xxiii. 10). 2. *The first-fruits in the two wave-loaves* (Lev. xxiii. 17). These two bounded the harvest, that in the sheaf being offered at the beginning of the harvest, upon the 15th of the month Nisan; the other at the end of the harvest, on the Feast of Pentecost. These two are both called תְּנוּפֹת *tenuphoth*, 'shake or wave-offerings.' 3. *The first of the dough*, being the twenty-fourth part thereof, which was given to the priests (Num. xv. 20); and this kind of offering was not neglected even after the return from Babylon (Neh. x. 37). 4. *The first-fruits of the threshing-floor.* These two last are called תְּרוּמוֹת *terumoth*, or 'heave-offerings'; the one, the 'heave-offering of the threshing-floor,' the other 'the heave-offering of the dough.' The words *tenuphoth* and *terumoth* both signify 'shake-offering,' 'heave-offering,' or 'wave-offering;' but with the difference that the *terumoth* was offered by a waving of elevation, moving the oblation upward and downward, to signify, as we are told, that Jehovah was the God both of the heaven and earth; but the *tenuphoth* was offered by waving of agitation, to and fro, from the right hand to the left, from east to west, from north to south; which is alleged to have been in the way of an acknowledgment that Jehovah was the Lord of the whole world (See Godwyn's *Moses and Aaron*, vi. 2. pp. 214, 215; also, Lewis's *Origines*, i. 143-146).

The oblation of the first-fruits of the threshing-floor was distinguished by the Jewish writers into two sorts. The first of these was the first-fruits of seven things only, namely, wheat, barley, grapes, figs, pomegranates, olives, and dates. These the Talmudists distinguish by the name of *Bikkurim*, which signifies 'the choicest part,' or, what was first ripe. The treatise or section bearing that title in the Talmud contains all the regulations by which practical effect was given, or sought to be given, to the law. It is there stated that the owner was at liberty to bring in what quantity he pleased as first-fruits; but in gathering, he always bound about with rushes the portions he designed for the priests, and said, 'Let this be for the first-fruits.' The second sort consisted of corn, wine, oil, and whatever other produce was fit for the support of human life. Under this class of first-fruits was included the first of the fleece, by which the priests were provided with clothes, as by the other offerings with food. The hair of goats, which are

shorn in the East, was included under this denomination.

The first-fruits were brought up to Jerusalem with great pomp and ceremony. All the people of a given district assembled on an appointed day in one of the towns, and lodged in the streets. On the following morning the chief of the party gave the signal for departure in the words, 'Arise, let us go to Zion, to the house of the Lord our God!' An ox, destined for a thank-offering, went before them, with gilded horns, and an olive crown upon his head; and a pipe was also played before them as they marched on, laden with the finest products of their land. When they drew nigh to Jerusalem they 'crowned their first-fruits,' that is, they adorned the baskets with flowers, and arranged their offerings so as to make the most advantageous and imposing display on entering the city. On coming nearer, the chief men, high officers, and treasurer of the temple, came forth to meet them and receive them with honour; and as they went by, all the workmen of the city stood up and saluted them, saying, 'O, our brethren, inhabitants of the city N—, ye are welcome.' The pipe still played till the party came to the mount of the temple; every one then, however high or noble, took his own basket upon his shoulder, and went forward till he came to the court of the temple. The Levites then sang, 'I will extol thee, O Lord, because thou hast exalted me, and hast not made mine enemies to rejoice over me.' The offerer, having the basket still upon his shoulder, then began to recite the passage, 'I profess this day,' &c. (Deut. xxvi. 3-10); and when he came to the part, 'A Syrian ready to perish was my father,' he took down the basket from his shoulder and paused, while the priest waved the offering before the altar; the rest of the passage was then recited; after which the offerer placed the basket of offerings before the altar, worshipped God, and went out. It was usual with those who were liberally disposed to hang turtle-doves or pigeons about their baskets, and these formed part of the offering. As each offering was left in the basket, that receptacle formed, in fact, a beneficial, though not a ceremonial part of the offering, and the Talmudists tell us of princes who, for that reason, presented their offerings in baskets of gold. The first-fruits became the property of the course of priests which was in actual service. The party who brought them was obliged to spend the night following his offering in Jerusalem, but was at liberty to return home the ensuing morning.

It is obvious that this and some other of the apparently onerous obligations of the law, cannot be properly appreciated or understood when regarded in the 'dry light' of abstract duties or exactions. They were surrounded by engaging and picturesque associations, calculated to make their observance a matter of pride and pleasure to all the parties concerned.

FISH (37 *dag*; Gr. *ἰχθύς*, Gen. ix. 2; Num. xi. 22; Jonah ii. 1, 10; Matt. vii. 10; xiv. 17; xv. 34; Luke v. 6; John xxi. 6, 8, 11). Fishes, strictly so called, that is, oviparous, vertebrated, cold-blooded animals, breathing water by means of gills or branchiæ, and generally provided with fins, are not unfrequently mentioned in the Bible, but never specifically. In the Mosaic law (Lev. xi. 9-12), the species proper for food are distinguished by having scales and fins, while those

without scales are held to be unclean, and therefore rejected. The law may have given rise to some casuistry, as many fishes have scales, which, though imperceptible when first caught, are very apparent after the skin is in the least dried. The species which were known to the Hebrews, or at least to those who dwelt on the coast, may have been very numerous, because the usual current of the Mediterranean sets in, with a great depth of water, at the Straits of Gibraltar, and passes eastward on the African side until the shoals of the Delta of the Nile begin to turn it towards the north: it continues in that direction along the Syrian shores, and falls into a broken course only when turning westward on the Cyprian and Cretan coasts. Every spring, with the sun's return towards the north, innumerable troops of littoral species, having passed the winter in the offings of Western Africa, return northward for spawning, or are impelled in that direction by other unknown laws. A small part only ascends along the Atlantic coast of Spain and Portugal towards the British Channel, while the main bodies pass chiefly into the Mediterranean, follow the general current, and do not break into more scattered families until they have swept round the shores of Palestine. The Pelagian, or truly deep sea fishes, in common with the indigenous species, remain the whole year, or come about midsummer, and follow an uncertain course more in the centre and towards the deepest waters. Off Nice alone Risso (*Ichthyol. de Nice*) found and described 315 species; and there is every reason to believe that the coasts of Tyre and Sidon would produce at least as great a number. The name of the latter place, indeed, is derived from the Phœnician word fish, and it is the oldest fishing-establishment for commercial purposes known in history. Industry and security alone are wanting to make the same locality again a flourishing place in this respect. The Hebrews had a more imperfect acquaintance with the species found in the Red Sea, whither, to a certain extent, the majority of fishes found in the Indian Ocean resort. Beside these, in Egypt they had anciently eaten those of the Nile; subsequently those of the lake of Tiberias and of the rivers falling into the Jordan; and they may have been acquainted with species of other lakes, of the Orontes, and even of the Euphrates. The supply, however, of this article of food, which the Jewish people appear to have consumed largely, came chiefly from the Mediterranean; and we have the authority of Neh. xiii. 16, for the fact, that Phœnicians of Tyre actually resided in Jerusalem as dealers in fish; which must have led to an exchange of that commodity for corn and cattle. Those which might be eaten, because they had scales and fins, were among the most nutritious and common, probably such as still abound on the coast; being genera of *Percidæ*, *Scienidæ*, and other families. It is difficult to select the most interesting of these, and to point them out with other names than are absolutely scientific, because many are unknown on our coasts, and others have names indeed, but nearly all repetitions of such as occur in England, without being of the same species. The best catalogue hitherto attempted is in Kitzo's *Palestine*, vol. i.; to which numerous additions might be made, but that it appears preferable to give here only a general outline, with some exceptions as to the most

important species. Taking the Cuvierian system for our guide, we have of the *Percidæ*, or perch tribes, both in the seas and rivers of Palestine and Egypt, several species of perch (*Perca*) properly so called; *Lates calcarifer*, or perch of the Nile, once held sacred at Latopolis; Basse (*Labrax*), of which the *L. Lupus* ascends the fresh water of rivers, and anciently brought an incredible price at Rome, if caught in the Tiber above a certain bridge, and weighed somewhat heavy. It frequents the whole circle of the Mediterranean and Black Sea. *Sillago sihama* of the Red Sea, known by the Oriental Frankish name of *leche*, transferred from the Mediterranean side, where it is bestowed upon two species of the cod-fish family, because all these species are of exquisite flavour; though it may be doubted whether these, like many others having very small scales, were considered admissible in the Hebrew market. A proportion of the eight or ten species of Merrow (*Serranus*) and Barbeis (*Anthias*) may have been held similarly objectionable. The *Sphyræna*, or barracuta of the Mediterranean; surmulletts (*Mullus*), several species of gurnard (*Trigla*), and of flying gurnard (*Dactylopterus*), frequent the seas of Palestine. But Scienoid and Sparoid genera offer the greatest number of species, and are particularly abundant in all parts of the Mediterranean, coming in troops at certain seasons. They are edible, and mostly resplendent with large scales. *Sciæna umbra* (*Aquila?*), or great sea-bream, sometimes near seven feet long; *Corvina sciæna nigra*, *Umbrina cirrhosa*, &c. The Sparoids of the Levant contain several species of *Sargus* (sheep-heads), *Chrysophris* (gilthead), *Pagrus*, or rosy Sparus; *Pagellus*, among which the celebrated *Pag. Mormyrus* runs up the Nile; *Dentex mahsena* and *D. harak* of the Red Sea; several species of Boops and *Gerres*, or rock-fish; *Gerres oyena*, &c.

Next we have the great tribe of *Scomberidæ*, or mackerels, with numerous genera, and still more abundant species, frequenting the Mediterranean in prodigious numbers, and mostly excellent for the table; but, being often without perceptible scales, they may have been of questionable use to the Hebrews. All the species resort to the deep seas, and foremost of them is the genus *Thynnus*, our tunny, a name that may be derived from the Hebrew or Phœnician $\tau\eta$ than [WHALE]. It is abundant at certain seasons in the offing of every part of the Mediterranean, but is most successfully pursued in the western part and about Sicily, and is frequently seen on the coasts of Candia and Cyprus. The three or four species which enter or remain in the seas of the Levant, commonly called Bonnetos and Albicores, are all observed to delight in moving against the current. Of this family, but less frequent, is the great sword-fish (*Xiphias*), oftenest seen to the eastward of Sicily. The genus *Scomber* (mackerel, properly so called) offers two or three, and of the Sead (*Caranx*) at least six species. Both are very numerous in their seasons. Among them *Caranx pectaurista* (skipjack) is often seen dancing on the calm surface of deep water, and even in shore about Tyre and Sidon; but *Seriola speciosa* belongs to the Red Sea. Omitting species of the *Axwis*, *Sarda*, *Cibium*, and *Naucrates*, or pilot-fish, found in every sea, we may name *Vomer Alexandrinus*, Gimel-el-Bahr, or camel-

fish of the Arabs; *Stromateus fiatula*, most common on the Barbary and Syrian shores; the genus *Coryphæna* (dolphin of seamen), whereof *Cor. Hippurus* is often noticed chasing the flying-fish (*Exocætus*) off Cyprus; and there are several other subgenera belonging to this family in every part of the Levantine seas.

Passing without notice a great number of less important genera, we come to the Mugiloid family (*Mugilidæ*). The sea-mulletts (*Mugil*, properly so called) afford at least five species, and among these the real *Mugil Cephalus* is one found all round the coast of Africa, from the Red Sea to Alexandria, and is valuable in every part of the Mediterranean. There are besides several others in both seas. Many species of other families exist on the coast of Palestine, but are of no general importance, excepting, perhaps, one of the genus *Lophius*, or sea-devil (fishing-frog, or angler), reaching in the Mediterranean to five feet in length; and another species in the Red and Eastern seas, little less: both are hideous monsters in appearance, with the mouth of sufficient width to swallow their own bulk. They have tentacula or filiform appendages on the head; and in hot seas they crawl over rocks and in the sands partially above water. It seems that one of this genus, the Kapa Moramola of Malabar, is typical of Vishnou in his avatar of Matsya, when he is fabled, under the form of a fish, to have drawn the ark of Noah by the filaments on his head to the mountain of Nambudana, the Ararat of Hindu legends. The idol is still worshipped by the name of Juggernat, or Somnauth, in the likeness of a Lophius, almost obliterated in the carving so that it resembles a human fist, having a wide mouth at the knuckles, with a nose and eyes on the back. Such was the image which Malmoud, sultan of Ghizni, shattered in 1025, and found to be a receptacle of riches. That of Poor-Bunda bears the same shape; and the figure at the black pagoda of Juggernauth still retains some traits of the primitive legend, though deformed by others still more absurd; but they serve to trace one of the many pagan reminiscences of the patriarch Noah, and form another version of the Philistine Dagon.

Among other families of fishes not yet adverted to, the labroid (*Labridæ*, Wrasse of Pennant) abounds in genera and species; as also the *Scarus* (parrot-fish), whereof two species at least frequent the seas of Alexandria, Crete, and Cyprus. *Scarus viridis* and *Scarus Cretensis*, one of which, no doubt, was the green specimen which Dr. Clarke did not recognise at Jaffa when shown him by an Arab; the Cretan species was once considered of sufficient importance among Roman epicures to cause an officer of high rank to be sent with a squadron of vessels for the sole purpose of obtaining and conveying a certain number of living fish to stock the Tyrrhenian sea. Genera of carps (*Cyprinidæ*) are particularly abundant in the fresh waters of Asia. It was from thence Europe and England obtained them. Among these the orfe is still deemed sacred at Orfal (Ur of Scripture?), where numbers are kept in the piscina of the mosque dedicated to Abraham. Of pikes (*Esocidæ*) are found chiefly marine genera, such as gar-fish (*Belone*), mackerel-jack (*Seomber Esox*), and Balahoo (*Hemiramphus*), to which may be added flying fish (*Exocætus*), all frequenting the Syrian coast. After these may be ranged the

genus *Mormyrus*, whereof the species, amounting to six or seven, are almost exclusively tenants of the Nile and the lake of Tiberias, and held among the most palatable fish which the fresh waters produce. One species, *Mormyrus Oxyrinchus*, was worshipped by the idolatrous Egyptians.

Cat or Sheat-fish (*Siluridae*), with from two to eight barbels at the month, are a family of numerous genera, all of which, excepting the *Loricariæ*, are destitute of a scaly covering, and are consequently unclean to the Hebrews; and some species are said to be poisonous or electrical. Several of them were held by the ancient Gentile nations, and by some of the modern, in high estimation, such as the black fish (*Sinait-el-Aswad*) of Aleppo, probably *Silurus Clarias Gronovii*, the *shilbe* of the Nile, and several others. Of salmon (Salmonidæ) *Myletes dentex*, or *Hasselquisti*, belongs to the best edible fishes of the Nile; and *Clupeidæ* (herrings), beside a species of shad (*Alosa*), offer several delicate sardines (*Eugraulis*), abundant on the coast of Africa; and the fierce bechir (*Polypterus*) of the Nile is praised for the table. Next follow the eel or gadoid species (*Gadidæ*), already partially noticed, being, besides several others, such as *Merluccius Lepidion*, present about Tyre. *Pleuronectes*, or flat-fish, found off the Egyptian coasts, and eel-shaped genera, bred abundantly in the lakes of the Delta. Finally, there are the cartilaginous orders, where we find the file-fish (genus *Balistes*), having a species (*B. Vetula*) in the waters of the Nile; and true chondropterygians, containing the sharks, numerous in genera and species, both in the Mediterranean and Red Sea. We notice only *Carcharius Lania*, the white or raging shark, often found of enormous size off Alexandria, and always attended by several pilot-fish (*Naucrates*), and the saw-fish (*Pristis Antiquorum*), most dreaded by the pearl-fishers in the Persian Gulf, and which has been seen in the Red Sea pursuing its prey even into the surf, with such force and velocity that, on one occasion, half of a fish cut asunder by the saw flew on shore at the feet of an officer while employed in the surveying service. On rays we shall only add that most of the genera are represented by species in either sea, and in particular the sting rays (*Trigon*), and electric rays (*Torpeda*), with which we close our general review of the class, although many interesting remarks might be subjoined, all tending to clear up existing misconceptions respecting fishes in general—such as that cetaceans, or the whale tribe, belong to them; and the misapplication of the term when tortoises and oysters are denominated fish; for the error is general, and the Arabs even include lizards in the appellation.

Though the Egyptian priesthood abstained from their use, all the other castes dwelling in the valley of the Nile chiefly subsisted on the fish of the river, while they capriciously abhorred those of the sea. There was a caste of fishermen; and allusion to the artificial reservoirs and fish-ponds of Egypt occurs in the Prophets (Isa. xix. 8-10).

But the Hebrews could draw only a small supply from the lake of Tiberias and the affluents of the Jordan. On the coast the great sea-fisheries were in the slack waters, within the dominion of the Phœnicians, who must have sent the supply into the interior in a cured or salted state; although the fact involves the question how far in that condition,

coming out of Pagan hands, consumption by a Hebrew was strictly lawful: perhaps it may be presumed that national wants had sufficient influence to modify the law. The art of curing fish was well understood in Egypt, and unquestionably in Phœnicia, since that industrious nation had early establishments for the purpose at the Golden Horn or Byzantium, at Portus Symbolorum in Tauric Chersonesus, and even at Calpe (Bisepharat?), in the present bay of Gibraltar. With regard to the controversy respecting the prophet Jonah having been swallowed by a huge sea-monster [WHALE], it may be observed that great cetaceans occur in the Mediterranean, as well as great sharks, and that, in a case where the miraculous intervention of Almighty power is manifest, learned trifling about the presence of a mysticete, or the dimensions of its gullet, is out of place.

The form of a fish (*Notius Poseidon*) was, from remote ages, a type of protective dominion, which the symbolizing spirit of the ancients caused to pass into Christianity; as appears from Eusebius (*Life of Constantine*), and St. Augustine (*De Civitate Dei*). On the walls of the oldest catacombs of Rome the representation of the IXΘΥΣ is frequently discernible, and always interpreted as an emblem of the Saviour.

Bochart's conclusions (*De pisce Tobie*, p. 748), respecting the fish which assailed Tobit, are totally inadmissible. *Silurus Glanis* is not a fish known in South Western Asia; but it may be worth noticing that the *Sesar* of the Indus is a crocodile, probably of the genus *Gavial*, which grows to a great size, is eaten, and has a gall bladder, still used to cure obstinate wounds and deflections. Whether any great saurian now ascends the Euphrates or Tigris may be a question; but as these animals in the East are ranked with fish, and pass from fresh water into salt, they are probably still found along the whole southern coast of Persia, and may anciently have frequented the rivers in question. We notice these particulars as they answer the conditions of Tobit's fish more completely than any other hitherto pointed out.—

C. H. S.

FITCHES. [KETSACH.]

FLAG. [ACHU.]

FLAGON (פִּיטוֹן; Sept. λίγανον). The word thus rendered in the English Bibles (2 Sam. vi. 19; 1 Chron. xvi. 3; Hos. iii. 1; Cant. ii. 5) means rather a *cake*, especially of dried figs or raisins, pressed into a particular form [FRUITS].

FLAX. [PISHTEN.]

FLEA (פִּיטוֹן, *pulex irritans*, Class *aptera*, Linn.; *siphonaptera*, Latr.; *aphanaptera*, Kirby) occurs only 1 Sam. xxiv. 14; xxvi. 20, where David thus addresses his persecutor Saul at the cave of Adullam: 'After whom is the king of Israel come out? after whom dost thou pursue?—after a flea; 'The king of Israel is come out to seek a flea!' In both these passages our translation omits the force of the word פִּיטוֹן, which is found in the Hebrew of each: thus, 'to pursue after, to seek *one* or a *single* flea.' In the former passage the Septuagint preserves it—ψάλλον ἐνός; in the latter it omits all mention of the flea, and reads καθὼς καταδιώκει ὁ νυκτικόραξ ἐν τοῖς ὄρεσι, 'as the owl hunteth on the mountains.' But another Greek version in the *Hexapla* reads

βύλλον ένα. The Vulgate preserves the word in both passages, *pulicem unum*. David's allusion to the flea displays great address. It is an appeal founded upon the immense disparity between Saul as the king of Israel, and himself as the poor contemptible object of the monarch's laborious pursuit. Hunting a flea is a comparison, in other ancient writings, for much labour expended to secure a worthless result.

Although this insect has been used as a popular emblem for insignificance, yet, when considered by itself, it has high claims upon the attention of the naturalist. Even to the naked eye there is something pleasing in its appearance, and elegant in its postures; but it is indebted to the microscope for our acquaintance with the flexible, highly polished, and ever clean suit of armour in which it is encased *cap-a-pie*, its finely-arched neck, large beautiful eye, antennæ, muscular jointed legs, its piercer and sucker—forming one most complicated instrument—the two long, hooked, sharp claws, in which its legs severally terminate. The agility of the flea places it at the head of all the leaping insects, when its strength is considered in relation to its size, it being able to leap, unaided by wings, 200 times its own length. It was certainly with misplaced wit that Aristophanes (*Nub.* 145) endeavoured to ridicule Socrates for having measured ψύλλαν ὀρθόσους ἄλλοισι τοὺς ἀτῆς πόδας, 'how many of its own lengths, at one spring, a flea can hop.' Such is the happy change in the state of science that philosophers have since done this with impunity: they have also traced the interesting career of this insect from the round smooth egg deposited on the creatures that can afford food to the larva, falling down through the hair to the skin; the shining pearl-coloured active larva, feeding on the scurfy surface of the cuticle, rolling itself into a ball when disturbed; the cocoon or silken bag which it spins around itself; and its re-appearance as a perfect insect. It is more than likely that the flea, besides participating in the happiness of all animated nature, and supplying a link in the universal chain of being, as well as serving the incidental use of chastising uncleanness, may also, along with many other tribes of insects, serve the purpose of the scavenger, in clearing away some source of disease (see Cuvier's *Animal Kingdom*, Lond. 1834, art. *Pulex*). Linnæus has assigned a personal service to mankind to some other insects, with which popular associations are even less pleasing, but which unerringly appear where the habits of mankind render their presence needful. Owing to the habits of the lower orders, fleas abound so profusely in Syria, especially during the spring, in the streets and dusty bazaars, that persons of condition always change their long dresses upon returning home. There is a popular saying in Palestine that 'the king of the fleas keeps his court at Tiberias;' though many other places in that region might dispute the distinction with that town (Kitto's *Physical History of Palestine*, p. 421).—J. F. D.

FLESH (בָּשָׂר). This word bears a variety of significations in Scripture:—

1. It is applied, generally, to the whole animated creation, whether man or beast; or, to all beings whose material substance is flesh (Gen. vi. 13, 17, 19; vii. 15, &c.

2. But it is more particularly applied to 'mankind'; and is, in fact, the only Hebrew word which answers to that term (Gen. vi. 12; Ps. xlv. 3; cxlv. 21; Isa. xl. 5, 6). In this sense it is used somewhat figuratively to denote that evil principle which is opposed to the spirit, and to God, and which it is necessary to correct and subdue (Gen. vi. 5; Job x. 4; Isa. xxxi. 3; Matt. xvi. 17; Gal. i. 16, &c.).

3. The word 'flesh' is opposed to נֶפֶשׁ *nepesh*, 'soul,' or 'spirit,' just as we oppose *body* and *soul* (Job xiv. 22; Prov. xiv. 30; Isa. x. 18).

4. The ordinary senses of the word, namely, the flesh of men or beasts (Gen. xli. 2, 19; Job xxxi. 23, 25), and flesh as used for food (Exod. xvi. 12; Lev. vii. 19), are both sufficiently obvious; and with respect to the latter see **FOOD**.

5. The word 'flesh' is also used as a modest general term for the secret parts, in such passages as Gen. xvii. 11; Exod. xxviii. 42; Lev. xx. 2; Ezek. xxiii. 20; 2 Peter ii. 7, 8, 10; Jude vii. In Prov. v. 11 the 'flesh of the intemperate' is described as being consumed by infamous diseases.

FLOCKS. [PASTURAGE.]

FLOOD. [DELUGE.]

FLOUR. [BREAD; MILL; OFFERINGS.]

FLOWERS. [PLANTS.]

FLUTE. [MUSIC.]

FLY. This word is used in the English Version to represent the two Hebrew words עֶרֶב and כְּבֵב. 1. עֶרֶב occurs Exod. viii. 21, 22, 24, 29, 31; Ps. lxxviii. 45, and cv. 21; all which passages relate to the plague of flies inflicted upon Pharaoh and his people. In the Sept. it is uniformly rendered *κυνόμυια*, or the dog-fly. In Exodus Jerome renders it by the following phrases and words, omne genus muscarum, muscæ diversi generis, muscæ hujusmodi, musca gravissima, and musca. In the Psalms he renders it *cynomyia*. It seems most probable that a *single species only* is intended, whatever it may be, from the way in which it is introduced, 'I will send the עֶרֶב אֲתָךְ, the *arob*,' compared with verses 29, 31, 'there remained not אֲתָךְ one,' that is, one *arob*, οὐδέμια, nec una quidem. The words, the *arob*, may be substituted for 'swarms of flies,' throughout the narrative, with only an apparent exception in the 24th verse; but there, the words כְּבֵב עֶרֶב, &c. may be rendered, the *arob* came numerous or grievously, (Sept. παρεγένετο ἡ κυνόμυια πλήθος, 'the dog-fly arrived, a multitude'); since instances of a similar use of the word כְּבֵב occur Gen. i. 9; Exod. ix. 3; x. 14, &c., where it appears to be used like the word *gravis* by the Romans. It has, however, been much debated what particular species is meant. Nothing can be gathered from the references to it in the Hebrew, farther than that it was 'upon Pharaoh, and upon the Egyptians,' that it filled their houses, covered the ground, corrupted or destroyed the land (Query, the inhabitants, Gen. vi. 12), and devoured their persons. (See also Wis. xvi. 9.) The rendering of the Septuagint, *κυνόμυια*, is entitled to much consideration. It is evidently compounded of *κύνων*, a dog, and *μύια*, a fly; and because both the one and the other of these creatures come uninvited, on some occasions, and though driven away, as often return, so the word formed of the union of the two, is used by ancient authors, to indicate *consummate im-*

pu'dence. Thus Homer represents Mars as applying the epithet to Minerva, for instigating the gods to quarrel (*Il.* xxi. 394). It is also referred to, as an insect, by Ælian, who, in describing the myops, tabanus, or horse-fly, says, it is similar to what is called the *κρυβώνας* (*Hist. Anim.* iv. 51). Philo, in his *Life of Moses* (i. 23, p. 401, ed. Mangey), expressly describes it as a biting insidious creature, which comes like a dart, with great noise, and rushing with great impetuosity on the skin, sticks to it most tenaciously. It seems likely that Jerome, in translating Exodus, derived the word from ערב, 'to mingle,' and understood by it a mixture of noxious creatures, as did Josephus, Aquila, and all the ancient translators. The diversity of Jerome's renderings in Exodus, however, betokens his uncertainty, and in the Psalms he has adopted that of the Septuagint. More modern writers, reasoning on other senses of the Hebrew word, and which are very numerous, have proposed several different insects. Thus, one of the meanings of ערב is 'to darken,' and Monffet observes that the name *synomyia* agrees with no kind of flies better than with those *black*, large, compressed flies, which boldly beset cattle, and not only obtain ichor, as other flies, but also suck out blood from beneath, and occasion great pain. He observes that they have no proboscis, but, instead of it, have double sets of teeth, like wasps, which they infix deeply in the skin; and adds that they greatly infest the ears of dogs (*Theat. Insect.* cxi.). Pliny describes an insect of this kind (*Hist. Nat.* xi. 40). So also Columella (vii. 13). See Pliny by Grandsagne and Cuvier, Parisii, 1828, vol. ii. p. 461, note. Others have proposed the *blatta Orientalis* or Ægyptia of Linnæus, as answering considerably to the characteristics of voracity, intrusion into houses, &c. &c. (Forskal, *Descrip. Animal.*, Præf. p. 22). The miracle involved in the plague of flies consisted, partly at least, in the creature being brought against the Egyptians in so great an abundance during winter. The particular species is, however, at present undetermined. 2. זבוב is probably the generic word for fly. It occurs Eccles. x. 1, and Isa. vii. 18, Sept. *μύα*, *musca*.

It enters into composition in the word בעל זבוב, fly-Baal, i. e. the god Baal (2 Kings i. 2, 3, 16), an oracular deity of the Ekronites [BAALZEBUB]. The phrase hissing, or rather *histing*, for the fly (Isa. vii. 18) is explained in the article BEE. (Bochart, a *Rosenmüller*; *Rosenmüller*, in loc.; Michaelis, *Suppl. ad Hebraic. Lex.* No. 1962; Oedmann's *Verm. Sammlungen*, H. ii. p. 150; Winer, *Bibl. Handwört.*)—J. F. D.

FOOD. [PASTURAGE.]

FOOD. The necessary act of taking food was, at a very early period of the world's history, connected immediately with religion. If regard was had to the source whence came the means of subsistence, it was natural that there should be some distinct recognition of that great and bountiful Being who gave rain from heaven, and fruitful seasons, filling men's hearts with joy and gladness (Acts xiv. 17). If scope was given to the feelings which bind man to man, and lead him to eat and drink in communion with his brethren, the additional pleasure hence experienced, and a due respect for the laws of hospitality, would awaken in the heart the religious

sympathies; and the sanctions of religion would soon come to cement bonds which convenience had originated, and to raise and hallow enjoyments which were designed and fitted for the preservation of the species. Man, too, has in all ages been led to set apart and offer to the Divinity a portion at least of what in each case was esteemed of highest value. But food is of all things the most valuable, since it is our life. In the grosser anthropomorphic systems of religion, the gods would also be considered as being gratified by food-offerings; if, indeed, some sort of ambrosia and nectar were not needed by them. Then those who served at the altar seemed to have a right to live by the altar (1 Cor. ix. 13); priests would therefore encourage, not without a corresponding approval on the part of the worshipper, such offerings and such appropriations to themselves as would at least supply the recurring wants of nature. And if we look at the final cause of this connection between the act of eating and the services of religion, we shall find a yet deeper reason, as well as a more powerful one, for their being occasionally united. Eating implies not only personal but social gratifications, if not of a very high order, yet of a very intense degree; and the appeal of religion to man while in the enjoyment of these pleasures is likely to be welcomed, heard, and obeyed. The social and the religious affections are thus aroused, made deep and intense, and then permanently blended together. The pleasing feelings which arise from the gratifications of the palate, and the enjoyments, if not endearments, of social intercourse, are thus, at least in part, transferred to religion, with which, by the natural workings of the heart, they become permanently and indissolubly associated.

How wise, then, was the provision which connected eating with the observances of the Mosaic religion. Especially when any signal event was to be commemorated, what could be so effectual as a ceremonial involving eating and drinking? The paschal lamb, for instance, and the unleavened bread, spoke in pleasing tones and by striking emblems, to each successive generation, of the great historical fact of which they were designed to be the perpetual memento. In like manner 'the Lord's Supper' (1 Cor. xi. 20), the breaking of bread from house to house (Acts ii. 46), and the ἀγάπαι, or love-feasts, 'feasts of charity' (Jude 12), were all, especially the first, both wisely designed and admirably fitted to bring into play, in connection with religion, the better feelings of humanity, to maintain in everlasting remembrance the events which they symbolized, to make eating and drinking an act of religion, and to make religion a pleasure. Strange, indeed, would it have been if Christianity, proceeding as it did from Him who knew well what was in man, and therefore knew well the powers by which man is swayed, and being, as it is, so wonderfully adapted to meet and supply our wants, had not made, on behalf of its great purposes, an appeal to that appetite and to those wants and pleasures which are not least among the great moving powers of both individual and social existence.

The productions of a country, at an early period of the world, necessarily determined its food. Palestine abounded with grain and various kinds of vegetables, as well as with animals of different

species. Such, accordingly, in general, was the sustenance which its inhabitants took.

The use of fire, and the state of the arts of life in a country, must also have important influence on its cookery; in other words, will go far to determine the state in which the natural productions of the earth will be eaten. If the grain is to become bread, a long and by no means easy process has to be gone through. Skill in preparing food is therefore held in high repute; so that, as in Homer, princes slay the cattle, and poetry details the process by which the carcass is made ready for being eaten (*Iliad*, i. 457).

Bread formed 'the staff of life' to the ancient Hebrews even more than to ourselves; but the modes of preparing it have been noticed under other heads [BREAD; MILK].

On a remarkable occasion a calf, tender and good, is taken, slain, dressed (roasted, most probably, *Judg.* vi. 19; *Gen.* xxvii. 7; *1 Sam.* ii. 13; *Exod.* xii. 8, 9; boiling was not known till long afterwards), and set before the guests, while the entertainer (Abraham) respectfully stood at their side, doubtless to render any desirable service. The sauce or accompaniments on this occasion were butter and milk. From *ch. xix. 3*, it may be inferred that the bread was unleavened.

The cases, however, to which reference has been made were of a special nature; and from them, as well as from what is recorded touching Isaac and Esau and Jacob, it appears that flesh meat was reserved as food for guests, or as a dainty for the sick; lentils, pulse, onions, grain, honey, and milk being the ordinary fare.

The agreeable, and perhaps in part the salubrious qualities of salt, were very early known and recognised: in *Lev.* ii. 13, it is expressly enjoined, 'Every oblation of thy meat-offering shalt thou season with salt; with all thine offerings shalt thou offer salt.'

Locusts were a permitted (*Lev.* xi. 22) and a very common food. At the present day they are gathered by the Bedouins in the beginning of April, and being roasted on plates of iron, or dried in the sun, are kept in large bags, and, when needed, eaten strewed with salt by handfuls.

Of four-footed animals and birds, the favourite food were sheep, goats, oxen, and doves. There are few traces of the eating of fish, at least in Palestine (*Num.* xi. 5; *Lev.* xi. 9-22). In the last passage a distinction is made between certain fish which might be eaten, and others which were forbidden. 'These shall ye eat of all that are in the waters: whatsoever hath fins and scales in the waters, in the seas, and in the rivers, them shall ye eat; and all that have not fins and scales, they shall be an abomination unto you.'

The distinction of clean and unclean animals, and of animals which might and those which might not be eaten, is found to have existed to a great extent in ancient Egypt. Among fish the oxyrinchus, the phagrus, and the lepidotus, were sacred, and might not even be touched. The inhabitants of Oxyrinchus objected to eat any fish caught by a hook, lest it should have been defiled by the blood of one they held so sacred. The phagrus was the eel; and the reason of its sanctity, like that of the oxyrinchus, was probably owing to its unwholesome qualities; the most effectual method of forbidding its use being to

assign it a place among the sacred animals of the country.

Neither the hippopotamus nor the crocodile appears to have been eaten by the ancient Egyptians. Some of the Egyptians considered the crocodile sacred, while others made war upon it (*Herod.* ii. 69). In some places it was treated with the most marked respect, fed, attended, adorned, and after death embalmed. But the people of Apollinopolis, Tentyris, Heracleopolis, and other places, held the animal in abhorrence: how far they carried their dislike may be seen in Juvenal (*Sat.* xv.); though something, probably, must be deducted from the account, in consideration of poetic licence.

Cats as well as dogs were held in high esteem by the ancient Egyptians. The former especially were objects of superstitious regard. When a cat died in a house a natural death, a general mourning throughout the family ensued; and to kill one of these revered animals was a capital offence.

Though it appears that swine frequently formed part of the stock of an Egyptian farm-yard, yet was the animal unclean and an abomination in the estimation of the Egyptians. Herodotus tells us (ii. 47) that if any one but touched a pig in passing, he was compelled to bathe himself and wash his garments; and those of the natives who were swineherds were a degraded caste, with whom others would not intermarry. It appears, however, from the historian's narrative, that, at the time when they sacrificed swine to the moon and to Bacchus, the Egyptians were wont to eat of their flesh, though on other occasions they scrupulously abstained from it.

Usages, if not laws, of a similar tendency, have existed among all nations. In our own country such usages are found. We abstain from some animals, we devour others. Often it would be very difficult to assign any reason, still more difficult to assign a sufficient reason. The cat is spared, the rabbit eaten. The beetle children torture, but value and preserve the lady-cow. A Frenchman delights in a frog, but, in common with an Englishman, loathes the idea of a rat. Caprice, custom, and casual associations, have often more to do in this matter than any definite or intelligible reason.

The Mosaic laws which regulated the use of animal food may be found in *Lev.* xi. and *Deut.* xiv. The grounds of many of these regulations may be ascertained with a greater or less degree of probability, provided the student is well acquainted with the mind and spirit of Hebrew antiquity. Considerations drawn from idolatrous usages, regard to health, the furtherance of agriculture, and established customs and tastes, had in each case an influence in the promulgation of these laws.

In the earliest times water was the common drink. That wine of an intoxicating tendency was drunk at a very early period appears from what happened to Noah (*Gen.* ix. 20), who seems to have made as well as drunk wine. Bread and wine are spoken of in *Gen.* xiv. 18, as offered for refreshment to Abraham by Melchizedek, king of Salem. Water was sometimes put to the wine; at others a strong drink was made by mixing with the wine aromatic herbs (*Ps.* lxxv. 9; *Isa.* v. 22), or a decoction derived from them; myrrh was

used for this purpose. Date-wine was in use, and probably the Egyptian or malt-wine, *ζῆθος, οἶνος κριθῶνος* (Herod. ii. 77). Jerome (*Opp.* iv. 364, ed. Bened.) says that 'drink, called Siceva by the Hebrews (שִׁיבָה), is every kind which can inebriate, or that which is made from grain, or of the juice of apples, or when the honey-comb is made (decoquantur) into a sweet and barbarous beverage, or the fruit of the palm expressed into a liquor, and when water receives a colour and a consistency from prepared herbs.' 'The common people' (Mark xiii. 37) drank an acrid sort of wine, which is rendered vinegar in our English Version (Ruth ii. 14; Matt. xxvii. 48). The Orientals frequently used wine in excess, so as to occasion intoxication, whence are drawn many striking figures in Holy Writ (Is. v. 11; xxviii. 1; xlix. 26; Jer. viii. 14; ix. 14; xvi. 48; Deut. xxxii. 42; Ps. lxxviii. 65). That indulgence in wine was practised in very ancient days is manifest from there being in the court of Pharaoh, at the time of Joseph, state-officers, who had charge of the wine, and served the monarch with it when he drank (Gen. xl. 1, 11; comp. Neh. i. 11; 1 Kings x. 5; 2 Chron. ix. 4).

For drinking-vessels there were used the cup and the bowl (Jer. xxxv. 5; Amos vi. 6; Exod. xxv. 33; Num. vii. 13, 84). The cup was generally of brass covered with tin, in form resembling a lily, sometimes circular. It is still used by



288. [Wine-cups. Persepolis.]

travellers, and may be seen in both shapes in the ruins of Persepolis (1 Kings vii. 26). The bowl (Exod. xxv. 33) assumed a variety of shapes, and bears many names. Some of these 'chargers' appear, from the presents made by the princes of Israel (Num. vii.), to have been of large size and great splendour; some were silver, some gold (1 Kings x. 21).

In Eastern climes the chief meal, or what we term dinner, is, in consequence of the heat of the middle period of the day, deferred till towards evening, a slight repast being taken before noon

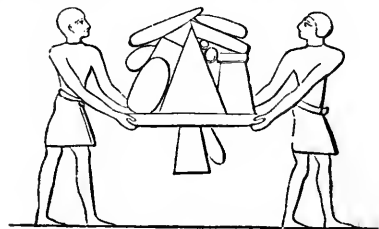

289. [Egyptian Table with Dishes.]

(Adam, *Rom. Antiq.* p. 377, ed. Major; Potter, ii. 625; Chardin, iv.; Jahn, i. 2). But from Gen.

xliii. 16, 25, it appears to have been the custom to dine at noon in the days of the patriarchs. The same seems to have been the case in Palestine at a later period (1 Kings xx. 16; comp. Acts x. 10; Luke xi. 37). Convivialities, however, were postponed till evening, and sometimes protracted to the following morning (Isa. v. 11; Mark vi. 21; Luke xiv. 24). The meal was preceded by washing of hands (Luke xi. 38; Mark vii. 2), which the mode of eating rendered necessary; and by an invocation of the divine blessing (1 Sam. ix. 13), termed in Samuel בִּרְכָה, and in Greek εὐλογία, εὐχαριστία, blessing, giving of thanks



290. [Modern Syrians at Meat.]

(Luke ix. 16; John vi. 11). Similar customs prevailed among the Greeks and Romans. Jahn (*Bib. Antiq.* p. 68) has given the short prayer, as preserved in the Talmud, which the Jews use, as follows: 'Blessed be thou, O Lord our God, King of the world, who hast produced this food (or this drink) from the earth (or the vine)' (Matt. xiv. 19; xv. 36; xxvi. 27).

The Hebrews, like the Greeks and Romans in their earlier history, ate sitting (Gen. xxvii. 19; Judg. xix. 6; 1 Sam. xx. 25). A carpet was spread, on which the meal was partaken. At a later period, however, particularly when Palestine came under the influence of Roman manners, the Jews reclined on cushions or couches (Esth. i. 6; Amos vi. 4; Luke vii. 37; ἀνεκλίθη, not 'sat,' as in the common translation, but 'reclined'). The custom of giving preference in point of seat or position to guests of high consideration appears from 1 Sam. ix. 22, to have been of ancient date (Amos iii. 12). In the time of Christ (Luke xiv. 8) the Pharisees, always eager for distinction, coveted the place of honour at meals and feasts. Women were not admitted to eat with the men, but had their meals supplied in their own private apartment (Esth. i. 6-9). In Babylon and Persia, however, females mingled with males on festive occasions (Dan. v. 2). In general the manner of eating was similar to what it is in the East at the present day. Special care was taken of favoured persons (Gen. xliii. 34; 1 Sam. i. 4; ix. 22; John xiii. 26). Neither knives, forks, nor spoons were employed for eating. The food was conveyed from the dish to the mouth by the right hand. The parties sat with their legs bent under them round a dish placed in the centre, and either took the flesh meat with their fingers from the dish, or dipped bits of their bread into the savoury mess, and conveyed them

to their mouths. In Ruth ii. 14, Boaz says to Ruth, 'Dip thy morsel in the vinegar;' which explains the language of our Lord, John xiii. 26, 'He it is to whom I shall give a sop when I have dipped it.' This presenting of food to a person is still customary, and was designed originally as a mark of distinction, the choice morsels being selected by the head of the family for the purpose. Drink was handed to each one of the guests in cups or goblets, and, at a very ancient period, in a separate cup to each person. Hence the word cup is used as equivalent to what we term a man's lot or destiny (Ps. xi. 6; lxxv. 8; Isa. li. 22; Matt. xxvi. 39).—J. R. B.

FOOL. The fool of Scripture is not an idiot, but an absurd person; not one who does not reason at all, but one who reasons wrong; also any one whose conduct is not regulated by the dictates of reason and religion. Foolishness, therefore, is not a privative condition, but a condition of wrong action in the intellectual or sentient being, or in both (2 Sam. xiii. 12, 13; Ps. xxxviii. 5). In the Proverbs, however, 'foolishness' appears to be sometimes used for lack of understanding, although more generally for perverseness of will.

FOOT. Of the various senses in which the word 'foot' is used in Scripture, the following are the most remarkable. Such phrases as the 'slipping of the foot,' the 'stumbling' of the foot, 'from head to foot' (to express the entire body), and 'foot-steps' (to express tendencies, as when we say of one that he walks in another's footsteps), require no explanation, being common to most languages. The extreme modesty of the Hebrew language, which has perhaps seldom been sufficiently appreciated, dictated the use of the word 'feet,' to express the parts and the acts which it is not allowed to name. Hence such phrases as the 'hair of the feet,' the 'water of the feet,' 'between the feet,' 'to open the feet,' 'to cover the feet,' all of which are sufficiently intelligible, except perhaps the last, which certainly does not mean 'going to sleep' as some interpreters suggest, but 'to dismiss the refuse of nature.'

'To be under any one's feet' denotes the subjection of a subject to his sovereign, or of a servant to his master (Ps. viii. 6; comp. Heb. ii. 8; 1 Cor. xv. 26); and was, doubtless, derived from the symbolical action of conquerors, who set their feet upon the neck or body of the chiefs whom they had vanquished, in token of their triumph. This custom is expressly mentioned in Scripture (Josh. x. 23), and is figured on the monuments of Egypt, Persia, and Rome. See an instance in the cut No. 256.

In like manner, 'to be at any one's feet,' is used for being at the service of any one, following him, or willingly receiving his instructions (Judg. iv. 10). The last passage, in which Paul is described as being brought up 'at the feet of Gamaliel,' will appear still clearer, if we understand that, as the Jewish writers allege, pupils actually did sit on the floor before, and therefore at the feet of, the doctors of the law, who themselves were raised on an elevated seat.

'Lameness of feet' generally denotes affliction or calamity, as in Ps. xxxv. 15; xxxviii. 18; Jer. xx. 10; Micah iv. 6, 7; Zech. iii. 9.

'To set one's foot' in a place signifies to take

possession of it, as in Deut. i. 36; xi. 34, and elsewhere.

'To water with the feet' (Deut. xi. 10) implies that the soil was watered with as much ease as a garden, in which the small channels for irrigation may be turned, &c. with the foot [GARDEN].

An elegant phrase, borrowed from the feet, occurs in Gal. ii. 14, where St. Paul says, 'When I saw that they walked not uprightly'—literally, 'not with a straight foot,' or 'did not foot it straightly.'

Nakedness of feet expressed mourning (Ezek. xxiv. 17). This must mean appearing abroad with naked feet; for there is reason to think that the Jews never used their sandals or shoes within doors. The modern Orientals consider it disrespectful to enter a room without taking off the outer covering of their feet. It is with them equivalent to uncovering the head among Europeans. The practice of feet-washing implies a similar usage among the Hebrews [FEET, WASHING OF]. Uncovering the feet was also a mark of adoration. Moses put off his sandals to approach the burning when the presence of God was manifested (Exod. iii. 5). Among the modern Orientals it would be regarded the height of profanation to enter a place of worship with covered feet. The Egyptian priests officiated barefoot; and most commentators are of opinion that the Aaronite priests served with bare feet in the tabernacle, as, according to all the Jewish writers, they did afterwards in the temple, and as the frequent washings of their feet enjoined by the law seem to imply [SANDALS].

The passage, 'How beautiful upon the mountains are the feet of him that bringeth glad tidings, that publisheth peace' (Isa. lii. 7), appears to signify that, although the feet of messengers and travellers are usually rendered disagreeable by the soil and dust of the way, yet the feet of these blessed messengers seemed, notwithstanding, even beautiful, on account of the glad tidings which they bore.

Respecting the 'washing of feet,' see **ABLUTION** and **WASHING**.

FOREHEAD. Marks upon the forehead, for the purpose of distinguishing the holy from the profane, are mentioned in Ezek. xi. 4, and again in Rev. vii. 3. These passages may be explained by reference to the customs of other nations. Thus the Rev. J. Maurice, speaking of the rites which must be performed by the Hindus before they can enter the great pagoda, says, 'an indispensable ceremony takes place, which can only be performed by the hand of a Brahmin; and that is, the impressing of their foreheads with the *tiluk*, or mark of different colours, as they may belong either to the sect of Veesnu or Seeva. If the temple be that of Veesnu, their foreheads are marked with a longitudinal line, and the colour used is vermilion. If it be the temple of Seeva, they are marked with a parallel line, and the colour used is turmeric or saffron. But these two grand sects being again sub-divided into numerous classes, both the size and the shape of the *tiluk* are varied in proportion to their superior or inferior rank. In regard to the *tiluk* I must observe, that it was a custom of very ancient date in Asia, to mark their servants. It is alluded to in these words of Ezekiel, where the Almighty commands his angels to 'Go through the midst

of the city, and set a mark on the foreheads of the men who sigh for the abominations committed in the midst thereof' (ix. 4).



291.

The classical idolaters used to consecrate themselves to particular deities on the same principle. The marks used on these occasions were various. Sometimes they contained the name of the god; sometimes his particular ensign, as the thunderbolt of Jupiter, the trident of Neptune, the ivy of Bacchus, &c.; or else they marked themselves with some mystical number whereby the god was described. Thus, the sun, who was signified by the number 608, is said to have been represented by the two numeral letters XII.

If this analogy be admitted, the mark on the forehead may be taken to be derived from the analogous custom among the heathen of bearing on their forehead the mark of the gods whose votaries they were. Some, however, would rather understand the allusion to refer to the custom of marking cattle, and even slaves, with the sign of ownership [STIGMATA].

There has been much speculation respecting the mark itself. It was a Jewish notion that it was the letter \aleph , because that was the first letter of the Hebrew word תורה 'the law,' as if it pointed out those who were obedient to the sacred code; or because it was the first letter of the word תחיה , 'thou shalt live.' It is indeed alleged that the angel had orders to write this mysterious letter with ink upon the foreheads of the righteous, and with blood upon the foreheads of the wicked; in the one case signifying, 'thou shalt live,' and in the other, 'thou shalt die.' The early Christian commentators readily adopted the notion that the mark was the letter \aleph , but alleged that its form was that of a cross in the old Samaritan alphabet, which was used in the time of Ezekiel. Indeed both Jerome and Origen distinctly allege that the letter still bore that form in their time; and although the letter does not retain that form in the present Samaritan alphabet, there is certainly evidence of its being represented on old coins by the character $\bar{\aleph}$; and another proof arises from the fact of its being re-

presented by \aleph in the Greek alphabet, which is derived from the Phœnician. It having been thus settled that the character marked on the forehead was the letter \aleph in its ancient cruciform shape, it was easy to reach the conclusion that the mark on the forehead denoted salvation by the cross of Christ.

This is very ingenious; but there is no proof that the mark was the letter \aleph , or any letter at all. The word employed is טו *tau*, and means simply a mark or sign (not a letter), and is so rendered in the Septuagint, the Targum, and by the best Jewish commentators. The name of the letter \aleph is, however, probably from this word, and in this fact we have perhaps the source of the conjecture. It is, however, a curious circum-

stance that the analogous Arabic word توي denotes a mark in the form of a cross, which was branded on the flanks or necks of horses and camels (Freitag's *Lex. Arab.* s. v.). See Hävernicks *Commentar. über Ezekiel*, and Gill's *Exposition, on Ezek. ix. 4*.

FORESKIN, the prepuce, which was taken off in circumcision [CIRCUMCISION].

FOREST. Tracts of wood-land are mentioned by travellers in Palestine, but rarely what we should call a forest. The word translated by 'forest' is ער , which does not necessarily mean more than 'wood-land.' There are, however, abundant intimations in Scripture that the country was in ancient times much more wooded than at present, and in parts densely so. The localities more particularly mentioned as woods or forests are—

1. *The forest of cedars on Mount Lebanon* (1 Kings vii. 2; 2 Kings xix. 23; Hos. xiv. 5, 6), which must have been much more extensive formerly than at present; although, on the assumption that the *eres* of Scripture (ער) is the *pinus cedrus*, or so-called 'cedar of Lebanon,' its growth is by no means confined, among those mountains, to the famous clump of ancient trees which has alone engaged the attention of travellers [ERES]. The American missionaries and others, travelling by unfrequented routes, have found woods of less ancient cedar-trees in other places.

The name of 'House of the Forest of Lebanon' is given in Scripture (1 Kings vii. 2; x. 27) to a palace which was built by Solomon in, or not far from, Jerusalem, and which is supposed to have been so called on account of the quantity of cedar-trees employed in its construction; or, perhaps, because the numerous pillars of cedar-wood suggested the idea of a forest of cedar-trees.

2. *The forest of oaks*, on the mountains of Bashan. The trees of this region have been already noticed under ALLON and BASHAN.

3. *The forest or wood of Ephraim*, already noticed under EPHRAIM, 4.

4. *The forest of Hareth*, in the south of Judah, to which David withdrew to avoid the fury of Saul (1 Sam. xxii. 5). The precise situation is unknown.

FOREST is used symbolically to denote a city, kingdom, polity, or the like (Ezek. xiv. 26). Devoted kingdoms are also represented under the image of a forest, which God threatens to burn or cut down. See Isa. x. 17, 18, 19, 31, where the briars and thorns denote the common people; 'the glory of the forest' are the nobles and those

of highest rank and importance. See also Isa. xxxii. 19; xxxvii. 24; Jer. xxi. 11; xxii. 7; xlv. 23; Zech. xi. 2. (Wemyss's *Clavis Symbolica*.)

FORNICATION. In Scripture this word occurs more frequently in its symbolical than in its ordinary sense.

In the Prophets woman is often made the symbol of the church or nation of the Jews, which is regarded as affianced to Jehovah by the covenant on Mount Sinai. In Ezek. xvi. there is a long description of that people under the symbol of a female child, growing up to the stature of a woman, and then wedded to Jehovah by entering into covenant with him. Therefore when the Israelites acted contrary to that covenant, by forsaking God and following idols, they were very properly represented by the symbol of a harlot or adulteress, offering herself to all comers (Isa. i. 2; Jer. ii. 20; Ezek. xvi.; Hos i. 2; iii. 11). And thus fornication, or adultery (which is fornication in a married state), became, and is used as, the symbol of idolatry itself (Jer. iii. 8, 9; Ezek. xvi. 26, 29; xxiii. 37). See Wemyss's *Clavis Symb.*, art. 'Woman.'

FORTIFICATIONS. 'FENCED CITIES.'

Inventions for the defence of men in social life are older than history. The walls, towers, and

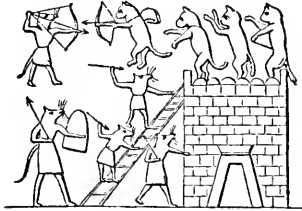

292.

gates represented on Egyptian monuments, though dating back to a period of fifteen centuries before the Christian era, bear evidence of an advanced state of fortifications—of walls built of squared stones, or of squared timber judiciously placed on the summit of scarp'd rocks, or within the circumference of one or two wet ditches, and furnished on the summit with regular battlements to protect the defenders. All these are of later invention than the accumulation of unhewn or rudely chipped uncemented stones, piled on each other in the form of walls, in the so called Cyclopean, Pelasgian, Etruscan, and Celtic styles, where there are no ditches, or towers, or other gateways than mere openings occasionally left between the enormous blocks employed in the work. As the three first styles occur in Etruria they show the progressive advance of military architecture, and may be considered as more primitive, though perhaps posterior to the era when the progress of Israel, under the guidance of Joshua, expelled several Canaanitish tribes, whose system of civilization, in common with that of the rest of Western Asia, bore an Egyptian type, and whose towers and battlements were remarkably high, or rather were erected in very elevated situations. When, therefore, the Israelites entered Palestine, we may assume that the 'fenced cities' they had to attack were, according to their degree of antiquity, fortified with more or less of art, but all with huge stones in the lower

walls, like the Etruscan. Indeed, Asia Minor, Armenia, Syria, and even Jerusalem, still bear

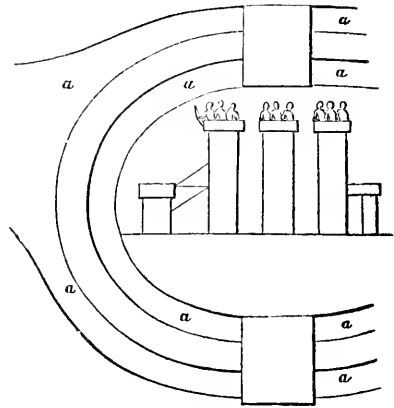

203. [a. Wet ditches.]

marks of this most ancient system, notwithstanding that this region, the connecting link between Asia and Africa, between the trade of the East and the West, and between the religious feelings of the whole earth, has been the common battlefield of all the great nations of antiquity, and of modern times, where ruin and desolation, oftentimes repeated, have been spread over every habitable place. Stones from six to fifty feet in length, with suitable proportions, can still be detected in many walls of the cities of those regions, wherever

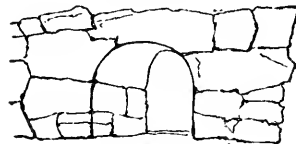
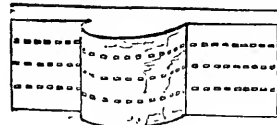

294.

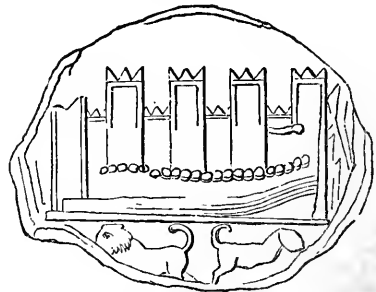

295.

quarries existed, from Nineveh, where beneath the surface there still remain ruins and walls of huge

stones, sculptured with bas-reliefs, originally painted, to Babylon, and Bassorah, where bricks, sun-dried or baked, and stamped with letters, are yet found, as well as in all the plains of the rivers where that material alone could be easily procured. The wall, חומה *choma*, was sometimes double or triple (2 Chron. xxxii. 5), successively girding a rocky elevation; and 'building a city' originally meant the construction of the wall.

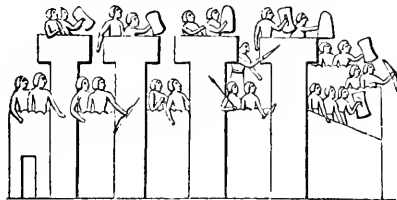

296.

Before wall-towers, מגדלות *migdaloth*, were introduced, the gate of a city, originally single, formed a kind of citadel, and was the strongest part of all the defences: it was the armoury of the community, and the council-house of the authorities. 'Sitting in the gate' was, and still is, synonymous with the possession of power, and even now there is commonly in the fortified gate of a royal palace in the East, on the floor above the door-way, a council-room with a kind of balcony, whence the sovereign sometimes sees his people, and where he may sit in judgment. Hence the Turkish government is not unfrequently termed *the Porte*, and in this sense allusion to gates often occurs in the Scriptures. The tower, צריח *tsaroch*, was another fortification of the earliest date, being often the citadel or last retreat when a city was taken; or, standing alone in some naturally strong position, was intended to protect a frontier, command a pass, or to be a place of refuge and deposit

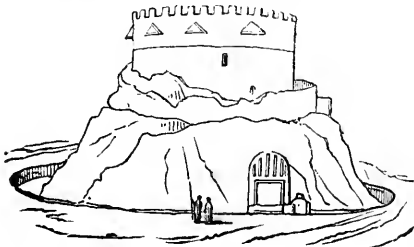

297.

of treasure in the mountains, when the plain should be no longer defensible. Some of these are figured among the Egyptian monuments, and in the west of England the round towers of Launceston, Restormel, Trematon, and Plympton show that similar means of defence were once employed by the Celts of this island, who may have derived their knowledge from Phœnician or Carthaginian traders. Watch-towers, מִצְפָּה *mizpah*, and טִירוֹת *terah*, used by shepherds all over Asia, and even now built on eminences above some city in the plain, in order to keep a look-out upon the distant country, were already in use and occasionally converted into places of defence (2 Chron. xxvi. 10; xxvii. 4). The gateways were closed

by ponderous folding doors, שַׁעַר *shaer*, שַׁעֲרִים *shaerim*, the valves or folds, דֵּלֶתִים *delethim*, being secured by wooden bars: both the doors and bars were in after times plated with metal. A ditch, חַל חַל *hal*, where the nature of the locality required it, was dug in front of the rampart, and sometimes there was an inner wall, with a second ditch before it. As the experience of ages increased, huge 'counter forts,' double buttresses, or masses of solid stone and masonry (not bulwarks*), were built in particular parts to sustain the outer wall, and afford space on the summit to place military engines (2 Chron. xxvi. 15).

As there was no system of construction strictly so called, but simply an application of the means of defence to the localities, no uniformity of adaptation existed, and, therefore, we refer to No. 292 of our illustrations, representing some primeval fable of the rats besieging the cats in their strong tower, where regular hewn courses of stones in the walls show skill in structure, and the inclined jambs of the door, with double impost,

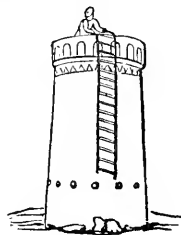

298.

experience in obviating a too great pressure from above. In the following cut (No. 299), taken from another Egyptian work, we have a series of towers, that in the middle being evidently the citadel or keep, and a gateway indicating that the wall is omitted, or is intended by the lines of the oval surrounding the whole. In No. 292 there is a scaling-ladder. In No. 299 we see a regular labarum, the most ancient example extant of this form of ensign, and the towers are manned with armed soldiers. In No. 293, another towered fortress, garrisoned with troops, is surrounded by a double ditch, and approached by bridges, both in front and rear. This representation refers to a city in Asia, attacked by one of the Egyptian conquering kings, anterior to the rise of the Assyrian and Babylonian power. No. 295 is taken from a seal, and is a symbol of Babylon, where the city, sustained by two lions, is shown standing on both sides of the Euphrates, having an outer wall; the inner rampart is flanked by numerous elevated and embattled towers. There is another, but less antique representation of Babylon, with its lions and towers, &c.; but the battlements are squared, not pointed, as in the first. Not very different from these double walls are those represented in the Egyptian painting copied in No. 296. The towers are here crowded with soldiers, some

* Eulwark, from the Dutch *bolwerk*, anciently called a mound, and in the sixteenth century always referable to bastion. Buttresses of the kind above mentioned still exist in the Celto-Roman walls at Pevensey in Sussex.

of whom, from the form of their shields, are obviously Egyptians. These are sufficient to give a

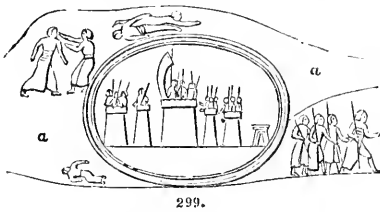

general idea of cities fenced entirely by art; but in No. 297 we give the Tsaroch tower, taken from one still extant in Persia, showing a ditch and gateway below in the mound or rock, its double outer walls and inner keep, very like Launceston castle. This was the kind of citadel which defended passes, and in the mountains served for retreat in times of calamity, and for the security of the royal treasures; and it was on account of the confined space within, and the great elevation of the ramparts, that private houses frequently stood upon their summit, as was the case when the harlot Rahab received Joshua's spies in Jericho (Josh. ii. 1).—C. H. S.

FORTUNATUS (Φουρτουνατος), a disciple of Corinth, of Roman birth or origin, as his name indicates, who visited Paul at Ephesus, and returned, along with Stephanus and Achaicus, in charge of that apostle's first Epistle to the Corinthian church; n. c. 59 (1 Cor. xvi. 17).

FOUNTAIN, a stream of 'living' or constantly running water, in opposition to standing or stagnant pools, whether it issues immediately from the ground or from the bottom of a well [AÏN]. On the more remarkable natural fountains of Palestine, see SPRINGS; WATER.

From the value of such supplies of water in arid countries, fountains figure much in the poetry of the East as the natural images of perennial blessings of various kinds. In the Scriptures fountains are made the symbols of refreshment to the weary, and also denote the perpetuity and inexhaustible nature of the spiritual comforts which God imparts to his people, whether by the influences of the Spirit, or through the ordinances of public worship. There are also various texts in which children, or an extended posterity, are, by a beautifully apt image, described as a fountain, and the father or progenitor as the source or spring from which that fountain flows (Deut. xxxiii. 28; Ps. lxxviii. 26; Prov. v. 16, 18; xiii. 14, &c.).

FOWL [BIRD; COCK].

FOX. [SHUAL.]

FRANKINCENSE [LEBONAH].

FROG. צִפְרָדִּי *tzephardca*; Arab. *akurrak*; Gr. βάρπαχος (Exod. liii. 2). Although the common frog is so well known that no description is needed to satisfy the reader, it may be necessary to mention that the only species recorded as existing in Palestine is the green (*Rana esculenta*), and that of all the authorities we have been able to consult, Dr. Richardson alone refers the species of Egypt to the green speckled grey frog (*Rana punctata*). But considering the immense extent of the Nile from south to north, and the amazing abundance of these animals which it contains in the state of spawn, tadpole, and complete frog, it

is likely that the speckled is not the only species found in its waters, and that different species, if they do not occur in the same locality, are at least to be met with in different latitudes. Storks and other waders, together with a multitude of various enemies, somewhat restrain their increase, which, nevertheless, at the spawning season is so enormous that a bowl can scarcely be dipped into the water without immediately containing a number of tadpoles. The speckled species is found westward even to the north of France, but is not common in Europe, and does not appear to croak in concert on this side of the Mediterranean: most likely it is not noisy in Egypt, since M. Sonnini, who wrote a detailed history of the Batrachians, and was personally well acquainted with the Nile, does not mention this species. It is lively, but no strong swimmer, the webs on the hinder toes extending only half their length: hence, perhaps, it is more a terrestrial animal than the common green frog, and, like the brown species, is given to roam on land in moist weather.



300.

Although it is very hazardous, in transactions of an absolutely miraculous nature, to attempt to point out the instruments that may have served to work out the purposes of the Almighty, we may conjecture that, in the plague of frogs, a species, the one perhaps we have just mentioned, was selected for its agility on land, and that, although the fact is not expressly mentioned, the awful visitation was rendered still more ominous by the presence of dark and rainy weather—an atmospheric condition never of long duration on the coast of Egypt, and gradually more and more rare up the course of the river. We have ourselves witnessed, during a storm of rain, frogs crowding into our cabin, in the low lands of Guiana, till they were packed up in the corners of the apartment, and continually falling back in their attempts to ascend above their fellows; and the door could not be opened without others entering more rapidly than those within could be expelled. Now, as the temples, palaces and cities of Egypt stood, in general, on the edge of the ever dry desert, and always above the level of the highest inundations, to be there visited by a continuation of immense number of frogs was assuredly a most distressing calamity; and as this phenomenon, in its ordinary occurrence within the tropics, is always accompanied by the storms of the monsoon or of the setting in of the rainy season, the dismay it must have caused may be judged of when we reflect that the plague occurred where rain seldom or never falls, where none of the houses are fitted to lead off the water, and that the animals appeared in localities where they had never before been found, and where, at all other times, the scorching sun would have destroyed

toem in a few minutes. Nor was the selection of the frog as an instrument of God's displeasure without portentous meaning in the minds of the idolatrous Egyptians, who, considered that animal a type of Pthah—their creative power—and also an indication of man in embryo. The magicians, indeed, appeared to make frogs come up out of the waters; but we must not understand that to them was given also the power of producing the animals. The effect which they claimed as their own was a simple result of the continuation of the prodigy effected by Moses and Aaron; for that they had no real power is evident, not only from their inability to stop the present plague, the control which even Pharaoh discovered to be solely in the hands of Moses, but also the utter failure of their enchantments in that of lice, where their artifices were incompetent to impose upon the king and his people.—C. H. S.

FRONTLETS [PHYLACTERIES].

FRUITS. פרי *peri*, fruit in general, vegetable or animal (Deut. vii. 13, *bis*; xxviii. 51, *bis*). It originated the English word 'fruit,' by the פ being sounded as *ph*, and subsequently converted into *f*. Under this head may perhaps be most appropriately noticed a classification of produce of great importance to a right understanding of the Bible, since the beauty and force of more than forty passages of the sacred record are impaired by inattention to it. We propose to show that the Hebrews had three generic terms designating three great classes of the fruits of the land, closely corresponding to what may be expressed in English as, 1. *Corn-fruit*, or field produce; 2. *Vintage-fruit*; 3. *Orchard-fruit*.

The term קיי *kayits*, 'summer-fruits,' appears to denote those less important species of fruit which were adapted only to immediate consumption, or could not be easily or conveniently conserved for winter use (Jer. xl. 10, 12). *Kayits* may have been included as a species under the head of Orchard-fruit: it would seem to indicate either the existence of some contrasted term, as 'winter-fruits,' or to imply that the products of the class under which it ranked as a species were generally distinguished by their capability of being preserved throughout the year. It is conceived that the products denoted by the third of the generic terms now to be considered, were chiefly characterized by their capacity of being stored up and preserved like our own orchard-fruit; and thus their generic name might be inclusive of *kayits*, 'summer-fruits,' though mainly and originally referring to 'winter-fruits.' The three terms spoken of as being so frequently associated in the Scriptures, and expressive of a most comprehensive triad of blessings, are DAGAN, TIROSH, and YITZHAR.

1. דגן *dagan*, 'fruit of the field,' or agricultural produce. Under this term the Hebrews classed almost every object of field culture [AGRICULTURE]. Dr. Jahn says, 'the word is of general signification, and comprehends in itself different kinds of grain and pulse, such as wheat, millet, spelt, wall-barley, barley, beans, lentils, meadow-cumin, pepper-wort, flax, cotton, various species of the cucumber, and perhaps rice' (*Bib. Antiq.* § 58). There is now no doubt among scholars that *dagan* comprehends the largest and most valuable species of vegetable produce; and

therefore it will be allowed that the rendering of the word in the common version by 'corn,' and sometimes by 'wheat,' instead of 'every species of corn' or field produce, tends to limit our conceptions of the Divine bounty, as well as to impair the beauty of the passages where it occurs. The same objection may be urged against the ordinary rendering of the associated terms, *tirosh* and *yitzhar*, as 'wine and oil.' Indeed, it is somewhat surprising that the almost universal acknowledgment of *dagan* as a very generic term has not, ere this, induced the learned to question the accuracy of this rendering of the sister terms, since it is neither usual nor natural, except by way of climax, to commingle very generic or abstract terms with names of specific articles, much less constantly to associate a general class of natural produce with particular articles of artificial preparation. In reading of 'a land of every species of corn,' we should naturally expect the declaration to continue consistently, 'of grapes and of fruit:' when, therefore, the transition is suddenly from growing 'corn of every kind' to specific and prepared products, 'wine' and 'oil,' a suspicion is raised as to the correctness of the rendering, which resolves itself into absolute certainty on consulting and comparing the passages of the Hebrew text. The infrequency of the mention of grapes and raisins, the natural or solid 'fruit of the vine,' in our version of the Scriptures, as compared with wine, the liquid preparation, has been a subject of remark. It is true that פיי *yayin* [WINE] is sometimes employed in the sense of grapes (as Cato and others of the Latins use *vinum*), and in this use of the word 'a land of corn and wine' really means, what Palestine was, 'a land of corn and grapes;' but this secondary and accommodated use of the term *yayin* does not supersede the necessity for a more generic word expressive of 'vintage-fruit,' viewed not merely as the *yielder* of wine, but as a valuable possession in itself.

2. תירוש *tirosh*, 'the fruit of the vine' in its natural or its solid state, comprehending grapes, moist or dried, and the fruit in general, whether in the early cluster or the mature and ripened condition (Isa. lxxv. 8, which is rendered by Βότρυς, *grape*, in the Septuagint, refers to the young grape; while Judg. ix. 13, where 'the vine said, Shall I leave my *tirosh* (fruit) which cheereth God and man?' as evidently refers to the ripened produce which was placed on the altar as a first-fruit offering in grateful acknowledgment of the Divine goodness). 'Sometimes,' says Dr. Jahn, 'the grapes were dried in the sun and preserved in masses, which were called ענבם *gvenabhim*, עשיש *eshishah*, צמוקים *tzimmoqim*, 1 Sam. xxv. 18; 2 Sam. xvi. 1; 1 Chron. xii. 40; Hos. iii. 1' (*Bib. Antiq.* § 69). *Tirosh* is derived from the verbal noun ירש *yarash*, 'to possess by inheritance' (whence Latin *hæres*, English *heir*), and was very naturally applied to designate the vintage-fruit, which, next to *dagan*, constituted one of the most valuable 'possessions' of the Jews.

It is also distinctly referred to as the *yielder* of wine, and therefore was not wine itself, but the raw material from which it was expressed or prepared. Dr. Conquest's amended translation of Micah vi. 15, is, 'Thou shalt sow, but thou shalt

not reap; thou shalt tread the olives, but thou shalt not anoint thee with oil (*shemen*, not *yitzhar*); and the grape (*tirosh*), but shalt not drink wine' (*yayin*). As the treading of the olive is represented as yielding oil, so is *tirosh* represented as that which, being trodden in the vat, should yield wine, which flowed out from an opening into the *lacus* or receptacle beneath. Archbishop Newcome, in his version of this text, has 'the grape of the choice wine;' while Julius Bate, M.A. observes on this passage—'Hence it is plain that *tirosh* is what is pressed, the grapes' (*Critica Hebræa*, 1767).

Dr. Jahn applies *tirosh* to the juice which flows from the grape-vat into the lower receptacle, and says, it is also called *new* wine and *γλεῦκος* (Acts ii. 13). This view, however, will, on examination, be found erroneous, opposed by the clear evidence of the context in the great bulk of the passages where the word occurs, classed with corn, first-fruits, tithes, and other natural produce, and countenanced only by its association with an equivocal rendering in two places. Joel ii. 24, the first of these texts, 'the floors shall be full of wheat, and the vats shall overflow with *tirosh*,' cannot be understood of the juice of the grape, but must refer to the fruit itself. It is most certain that grapes were put into the vat, not wine. The wine flowed out through an orifice into the receiving vessel, as the grapes were being trodden. These vats were very large, and were the treader to be placed in one so full that the juice would overflow the brim, he would be incapable of treading the grapes, if not actually in danger of suffocation [VAT]. The text presents a striking contrast to the picture of drought and desolation described in the preceding chapter, and represents, not only that the people should be satisfied with *dagan*, *tirosh*, and *yitzhar* (ii. 19), but more than satisfied; for the floors usually devoted to threshing corn should be full of כר (the best species of corn already threshed), and the vats (vessels not designed as stores for fruit, and which are inconvenient for treading when overfilled) should be heaped up with vintage and winter fruit so full that it would roll off to the ground, since they could hold no more. In the same sense we frequently employ the word 'overflow,' as, for example, 'The house was filled to overflowing.' A similar picture of plenty occurs in Prov. ii. 9, 10, where the grapevats are to be filled even to bursting, which certainly cannot mean that the wine shall be wasted! Isa. lxii. 8, 9 is the second text favouring a liquid interpretation of *tirosh*. The latter verse is thus translated by Dr. Lowth—'They that reap the harvest shall eat it, and praise Jehovah; and they that gather the vintage shall drink it in my sacred courts.' He justly observes that this has reference to the Law of Moses (Deut. xii. 17, 18; Lev. xix. 23-25), which commands the Israelites to eat (*achal*) the tithe of their *dagan*, *tirosh*, and *yitzhar* before the Lord, and, when they have planted all manner of trees for food, to count the fruit as uncircumcised for three years, then in the fourth year all the fruit thereof shall be holy to praise the Lord, and in the fifth they shall eat (*achal*) the fruit. 'This,' says Dr. Lowth, 'clearly explains the force of the expressions, "Shall praise Jehovah, and shall drink it in my sacred courts."' The apparent opposition between the passages will be

removed by understanding *shathah*, which primarily signifies 'to drink,' in its secondary sense of 'to suck.' It is thus appropriately rendered in the Prayer Book version of Ps. lxxv. 8. On a similar principle we modify the meaning of 'to eat,' when we speak of 'eating an orange;' thus too the Latins derived their generic word for fruits, *pomum*, from *pāua*, drink; and their name for the fruit of the service-tree from *sorbere*, 'to suck.' Dr. Lowth further, adds, that 'five MSS. (one ancient) have יכלוהו fully expressed, and so likewise שנתוהו' is found in nineteen MSS., three of them ancient.' Supposing *yishtoohoo* to be the original reading, the alteration to *youch-loohoo* must have been made by the ancient copyist under the impression which appears also to have rested on Dr. Lowth's mind, that a mode of consuming the fruits of the vintage different from drinking, was here designed by the use of *shathah*. This view is confirmed by the use of the verb קבץ *kabhats* (the participle of which is translated, 'They that have brought it together'), which implies the collecting of scattered things into a heap.

Dr. Jahn's definition of *tirosh*, as the juice which flows from the trodden grapes, is also negated by the fact that another word exactly expressive of the same thing, already exists, namely, עסיס *ausis*, from *ausas*, 'to tread down together.' Neither is it likely that it should be a generic name for wine, since such a term is found in יין *yayin*.

3. יצהר *yitzhar*, 'orchard-fruits,' especially winter or keeping fruits, as dates, figs, olives, pomegranates, citrons, nuts, &c. The etymology of *yitzhar* (whence perhaps the Saxon *ortzeard* *ortgeard*, and the old English word *hairsyard*, now *orchard*) quite accords with the claim advanced for it, as denoting a large and valuable class of fruits. Lexicologists properly refer it to the root צהר *tzahar*, expressive of a bright, glowing, and shining appearance. The name of the class was obviously suggested by the bright and glowing hue presented by many of the species, as the olive, the citron, and the orange. The name for the olive, זית, sometimes called 'the splendour-tree,' originated in a similar way, the root being י, 'bright,' 'splendid.' The name of another of the class, the orange, had a similar origin. The Latin *aurantium*, from *aurum*, 'gold,' by a slight change of spelling became the Italian *arancia*, whence, through the Provençal, the French *orange*. Through the Syro-Arabian channel we trace the Saracenic and Spanish name for the orange-flower, *azahar*, which probably sprang from some common stem with the Hebrew *tzahar*. Thus, too, *avrowth*, 'pot-herbs,' means 'shining things of a greenish hue,' from אורת, 'light,' 'brightness;' whence also the Latin name for gold, *aurum*, the French *or*, and our word for shining metals, *ore*.

As we distinguish *dagan* from *hithahh* (wheat), and *tirosh* from *ausis* and *yayin*, so must we *yitzhar* from שמן *shemen*, 'oil,' which are unfortunately confounded together in the common version. *Shemen*, beyond question, is the proper word for oil, not *yitzhar*: hence, being a specific thing, we find it in connection with a great variety of specific purposes, as sacrificial and holy uses, edibles, traffic, vessels, and used in

illustration of taste, smoothness, plumpness, insinuation, condition, fertility, and luxury. *Yitzhar*, as to the mode of its use, presents a complete contrast to *shemen*. It is not, even in a single passage, employed either by way of comparison, or in illustration of any particular quality common to it with other specific articles. In one passage only is it joined with $\text{דל}^{\text{י}}$ *zayith*, 'olive,' the oil of which it has been erroneously supposed to signify; and even here (2 Kings xviii. 32) it retains as an adjective the generic sense of the noun, 'preserving-fruit.' It should be read, 'a land of preserving-olives (*zayith yitzhar*) and dates (*debbash*).' Cato has a similar expression, *oleam conditivam*, 'preserving-olive-tree' (*De Re Rust.* vi.). It may be observed that the Latin terms *malum* and *pomum* had an extended meaning very analogous to the Hebrew *yitzhar*. Thus Varro asks, 'Non arboribus consita Italia est, ut tota *pomarium* videatur?' 'Is not Italy so planted with fruit-trees as to seem one entire *pomarium*?' i. e. orchard (*De Re Rustica*, i. 2).

Thus the triad of terms we have been considering would comprehend every vegetable substance of necessity and luxury commonly consumed by the Hebrews, of which first-fruits were presented or tithes paid; and this view of their meaning will also explain why the injunctions concerning offerings and tithes were sufficiently expressed by these terms alone (Num. xviii. 12; Dent. xiv. 23). Had *dagan* in these texts been restricted to *wheat*, no obligation would thereby have been imposed to present the first-fruits or the tithes of barley and other grain: had *tirosk* signified *grape-juice*, then this law could have been easily evaded by drying the fruit as raisins, or preserving it in other ways; and had *yitzhar* signified *oil*, it would have been difficult at all, and from these texts impossible, to elude the obligation to pay tithes or present first-fruits of a large and most valuable class of products, as dates, citrons, pomegranates, &c. But these texts are the most definite we can find in relation to the subject, and are evidently designed to be very comprehensive; and, consequently, as tithes were paid of all those fruits, the practice must interpret these expressions as including, 1st. Fruits of the field or land; 2nd. Fruits of the vintage; and, 3rd. Fruits of the orchard, including both summer and preserving fruits.

In conclusion, we will briefly recapitulate the results of our examination of the Scripture passages referring to *Dagan*, *Tirosk*, and *Yitzhar*, and exhibit their relative positions:—

a. They are found mutually associated in nineteen places. *Dagan* occurs with *tirosk* alone eleven times; with *yayin* only once, and there (Lam. ii. 12) *yayin* is used for grapes. *Tirosk* occurs thirty-eight times; in thirty places it is associated with the confessedly generic word *dagan*; in twenty-one with *yitzhar*; and it is found only six times without either *dagan* or *yitzhar*.

b. *Tirosk* occurs seven times with *rayshyth* or *biccover*, 'first-fruits'; ten times with *terob-hah*, 'offerings,' or *magnasayr*, 'tithes,' which were mainly the first of gathered fruits and grain in their natural state.

c. *Tirosk* is connected with *yayin* in three passages only; twice by way of climax merely

(Hos. iv. 11; Is. xxiv. 7-10), and once (Mic. vi. 15) as the yielder of wine, not wine itself.

d. *Tirosk* is not directly united with *shemen* (oil) in a single place.

e. The three terms are constantly and closely connected with expressions indicating increase of vegetable produce, or the spontaneous growth of the fruits of the earth, or the increase of objects of culture, especially the fruits of the field and the vineyard: they also occur in connection with terms expressive of fruital or animal produce, sometimes with the vine, olive, fig, or palm tree, but scarcely ever with their specific fruit, or with particular articles of diet; still more rarely are they connected with terms evincing the process of preparing or preserving them, or the vehicle or mode of their consumption. In all these respects they present a complete contrast to terms denoting specific products or artificial preparations, as *zayith* (olive), *shemen* (oil), *yayin* (wine), or *lehem* (food or bread).

f. In the very rare instances in which they do occur in connection with specific articles or circumstances, *special* reasons obviously exist for the fact, confirmatory of the view advanced as to their generic signification. The exceptions prove the rule.

g. Lastly, though the three terms are employed throughout a period of one thousand years (Num. xviii. 12, B.C. 1489, to Neh. xiii. 12, B.C. 409) by a series of fourteen authors, the bulk of whom also use *yayin* and *shemen*, occasionally in conjunction, yet not in one instance have they crossed *tirosk* with *shemen*, or *yayin* with *yitzhar*. On the contrary, the triad of generic terms have been cautiously and correctly discriminated from words merely denoting some of their species, or artificial preparations from them.—F. R. L.

FULLER. At the transfiguration our Saviour's robes are said to have been white, 'so as no fuller on earth could whiten them' (Mark ix. 3). Elsewhere we read of 'fullers' soap' (Mal. iii. 2), and of 'the fullers' field' (2 Kings xviii. 17). Of the processes followed in the art of cleaning cloth and the various kinds of stuff among the Jews we have no direct knowledge. In an early part of the operation they seem to have trod the cloths with their feet, as the Hebrew *Ain Rogel*, or En-rogel, literally Foot-fountain, has been rendered, on Rabbinical authority, 'Fullers' fountain,' on the ground that the fullers trod the cloths there with their feet. A subsequent operation was

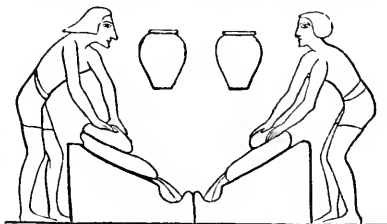

301.

probably that of rubbing the cloth on an inclined plane, in a mode which is figured in the Egyptian paintings, and still preserved in the East.

FULLERS' FOUNTAIN [EN-ROGEL].

FULLERS' SOAP [BORITH].

FUNERALS [BURIAL; MOURNING].

G.

GAAL (גאל, *miscarriage*; Sept. Γαάλ), son of Ebed. He went to Shechem with his brothers when the inhabitants became discontented with Abimelech, and so engaged their confidence that they placed him at their head. At the festival at which the Shechemites offered the first-fruits of their vintage in the temple of Baal, Gaal, by apparently drunken bravadoes, roused the valour of the people, and strove yet more to kindle their wrath against the absent Abimelech. It would seem as if the natives had been in some way intimately connected with, or descended from, the original inhabitants; for Gaal endeavoured to awaken their attachment to the ancient family of Hamor, the father of Shechem, which ruled the place in the time of Abraham (Gen. xxxiv. 2, 6), and which seems to have been at this time represented by Gaal and his brothers. Although deprived of Shechem, the family appears to have maintained itself in some power in the neighbourhood; which induced the Shechemites to look to Gaal when they became tired of Abimelech. Whether he succeeded in awakening among them a kind feeling towards the descendants of the ancient masters of the place, does not appear; but eventually they went out under his command, and assisted doubtless by his men, to intercept and give battle to Abimelech, when he appeared before the town. He, however, fled before Abimelech, and his retreat into Shechem being cut off by Zebul, the commandant of that place, he went to his home, and we hear of him no more. The account of this attempt is interesting, chiefly from the slight glimpse it affords of the position, at this period, of what had been one of the reigning families of the land before its invasion by the Israelites (Judg. ix. 26-48) *b.c.* 1026.

GABBATHA occurs John xix. 13, where the Evangelist states that Pontius Pilate, alarmed at last in his attempts to save Jesus, by the artful insinuation of the Jews, 'If thou let this man go, thou art not Cæsar's friend,' went into the prætorium again, and brought Jesus out to them, and sat down once more upon the βῆμα or tribunal, in a place called Λιθόστρωτον, but in the Hebrew Gabbatha. The Greek word, signifying literally *stone-paved*, is an adjective, and is generally used as such by the Greek writers; but they also sometimes use it substantively for a stone pavement, when ἔδαφος may be understood. In the Septuagint it answers to לִישָׁפֶת (2 Chron. vii. 3; Esther i. 6). Jerome reads, 'Sedit pro tribunali in loco qui dicitur Lithostrotos.' The Greek word, as well as the Latin, is frequently used to denote a pavement formed of ornamental stones of various colours, commonly called a *tesselated* or *mosaic pavement*. The partiality of the Romans for this kind of pavement is well known. It is stated by Pliny (*Hist. Nat.* xxxvi. 64) that, after the time of Sylla, the Romans decorated their houses with such pavements. They also introduced them into the provinces. Suetonius relates that Julius Cæsar, in his military expeditions, took with him the materials of tessellated pavements, ready prepared, that, wherever he encamped, they might be laid down in the prætorium (Casaubon, *ad Sueton.*

p. 38, &c., edit. 1605). From these facts it has been inferred by many eminent writers, that the τόπος λιθόστρωτος, or place where Pilate's tribunal was set on this occasion, was covered by a tessellated pavement, which, as a piece of Roman magnificence, was appended to the prætorium at Jerusalem. The emphatic manner in which St. John speaks of it agrees with this conjecture. It further appears from his narrative that it was *outside* the prætorium; for Pilate is said to have 'come out' to the Jews, who, for ceremonial reasons, did not go into it, on this as well as on other occasions (John xviii. 28, 29, 38; xix. 4, 13). Besides which, the Roman governors, although they tried causes, and conferred with their council (Acts xxv. 12), *within* the prætorium, always pronounced sentence in the open air. May not then this tessellated pavement, on which the tribunal was now placed, have been inlaid on some part of the terrace, &c. running along one side of the prætorium, and overlooking the area where the Jews were assembled, or upon a landing-place of the stairs, immediately before the grand entrance?

It has been conjectured that the pavement in question was no other than the one referred to in 2 Chron. vii. 3, and by Josephus, *De Bell. Jud.* vi. 1. 8, as in *the outer court of the temple*; but though it appears that Pilate sometimes sat upon his tribunal in different places, as, for instance, in the open market-place (*De Bell. Jud.* ii. 9. 3), yet the supposition that he would, on this occasion, when the Jews were pressing for a speedy judgment, and when he was overcome with alarm, *adjourn* the whole assembly, consisting of rulers of every grade, as well as the populace, to *any* other place, is very unlikely; and the supposition that such place was any part of the temple is encumbered with additional difficulties. The word Gabbatha remains to be considered. It is not certain that St. John intends Λιθόστρωτος as a translation or interpretation of Gabbatha: he may simply mean that the same place was called by these two names in Greek and Hebrew respectively. Yet it may be said that the names גַּבְבַּתָּא and Ἀπολλών, which he introduces in a similar way (Rev. ix. 11), are synonymous; and if the word Gabbatha be derived from גַּב, 'a surface,' it may correspond to the idea of a pavement; but if, as is usual, it be derived from גַּבַּח, 'to be high or elevated,' it may refer chiefly to the *terrace*, or uppermost landing of the stairs, &c., which might have been inlaid with a tessellated pavement. Schleusner understands an elevated mosaic pavement, on which the βῆμα was placed, before the prætorium. The most natural inference from St. John's statement is, that the word Gabbatha is 'Hebrew'; but it has been contended that the writers of the New Testament used this word, by way of accommodation, to denote the language (*Syriac*, or *Syro-Chaldaic*, it is said) which was commonly spoken in Judæa in their time, and that, when St. John says Ἐβραϊστὶ, he means in the Syro-Chaldaic; but into the extensive controversy respecting the vernacular language of the Jews at Jerusalem, in the time of our Saviour, this is not the place to enter. It may suffice for the present purpose to remark, that the ancient Syriac version, instead of Gabbatha, reads Gepiptha, *Dissert. De Λιθόστρώτῳ*, a Conrad Iken, Bremæ, 1725; Lightfoot's *Works*, vol. ii. pp. 614, 615, Lond 1684; Faberhægel, p. 318, f. ;

Hamelsveld, *Bibl. Geogr.* ii. 129; Seelen, *Meditt. Ereg.* i. 643; Jahn's *Archæol. Bibl.*—J. F. D.

GABRIEL (גַּבְרִיֵּאל, *the mighty one* [or *hero*] of God), the heavenly messenger who was sent to Daniel to explain the vision of the ram and the he-goat (Dan. vii.), and to communicate the prediction of the Seventy Weeks (Dan. ix. 21-27). Under the new dispensation he was employed to announce the birth of John the Baptist to his father Zechariah (Luke i. 11), and that of the Messiah to the Virgin Mary (Luke i. 26). Both by Jewish and Christian writers, Gabriel has been denominated an archangel. The Scriptures, however, affirm nothing positively respecting his rank, though the importance of the commissions on which he was employed, and his own words 'I am Gabriel, that stand in the presence of God' (Luke i. 19), are rather in favour of the notion of his superior dignity. But the reserve of the Inspired Volume on such points strikingly distinguishes its angelology from that of the Jews and Mohammedans, and, we may add, of the Fathers and some later Christian writers. In all the solemn glimpses of the other world which it gives, a great moral purpose is kept in view. Whatever is divulged tends to elevate and refine: nothing is said to gratify a prurient curiosity.

In the Book of Enoch, 'the four great archangels, Michael, Raphael, Gabriel, and Uriel,' are described as reporting the corrupt state of mankind to the Creator, and receiving their several commissions. To Gabriel he says, 'Go, Gabriel, against the giants, the spurious ones, the sons of fornication, and destroy the sons of the watchers from among the sons of men' (*Greek Fragment of the Book of Enoch*, preserved by Syn-cellus in Scaliger's notes on the *Chronicon*, of Eusebius, Amstel. 1658, p. 404). In the rabbinical writings Gabriel is represented as standing in front of the divine throne, near the standard of the tribe of Judah (Buxtorf, *Lex. Talmud.* s. v. גַּבְרִיֵּאל). The rabbins also say that he is the Prince of Fire, and appointed to preside over the ripening of fruit; that he was the only one of the angels who understood Chaldee and Syriac, and taught Joseph the seventy languages spoken at the dispersion of Babel; that he and Michael destroyed the host of Sennacherib, and set fire to the Temple at Jerusalem (Eisenmenger's *Entdecktes Judenthum*, th. ii. ss. 365, 379, 380, 383).

By the Mohammedans Gabriel is regarded with profound veneration. To him, it is affirmed, a copy of the whole Koran was committed, which he imparted in successive portions to Mohammed. He is styled in the Koran, the Spirit of Truth, and the Holy Spirit. In his hands will be placed the scales in which the actions of men will be weighed at the last day (Sale's *Koran*; D'Herbelot's *Bibliothèque Orientale*).—J. E. R.

GAD (גַּד). 1. A son of Jacob by his concubine Zilpah (Gen. xxx. 10, sq.), and who became the progenitor of one of the twelve tribes. The sons of Gad are enumerated in Gen. xlvi. 16, sq., and Num. i. 4, sq. At the time of the conquest of Canaan, the tribe of Gad counted 45,650 warriors (Num. i. 24): the position of their camp in the desert is given Num. ii. 14, and the names of their chiefs, vii. 10, sq.

As a reward for their having formed the vanguard in war of the army of the tribes collectively,

they were allowed to appropriate to their exclusive use some pastoral districts beyond the Jordan (Num. xxxii. 17, sq.).

The inheritance of this tribe, called the *land of Gad* (1 Sam. xiii. 7; Jer. xlix. 1), was situated beyond the Jordan in Gilead, north of Reuben, and separated on the east from Ammon by the river Jabbok. According to 1 Chron. v. 11, the Gadites had extended their possessions on the east as far as Salcah, though the latter had been allotted by Moses to Manasseh (Deut. iii. 10, 13): a proof how difficult it is to draw a strong line of demarcation between the possessions of pastoral tribes. The territory of Gad forms a part of the present Belka (Burckhardt, *Syria*, ii. 598).

In Josh. xiii. 25, the land of Gad is called 'half the land of the children of Ammon': not because the latter were then in possession of it, but probably because the part west of the Jabbok had formerly borne that name (comp. Judg. xi. 13).

The principal cities of Gad pass by the general appellation of the Cities of Gilead (Josh. xiii. 25).

The Gadites were a warlike people, and were compelled to be continually armed and on the alert against the inroads of the surrounding Arabian hordes (comp. Gen. xlix. 19; Deut. xxxiii. 20; 1 Chron. v. 19, sq.).—E. M.

2. **GAD**, a prophet contemporary with David, and probably a pupil of Samuel, who early attached himself to the son of Jesse (1 Sam. xxii. 5). Instances of his prophetic intercourse with David occur in 2 Sam xxiv. 11, sq.; 1 Chron. xxi. 9, sq.; xxix. 25. Gad wrote a history of the reign of David, to which the author of the 2nd book of Samuel seems to refer for further information respecting that reign (1 Chron. xxix. 29), *b.c.* 1052-1017.

GAD (גַּד; Sept. δαμόνιον, or, according to the reading of Jerome and of some MSS, τύχη) is mentioned in Isa. lxx. 11. The word admits of two different significations. If it be derived from גַּד in the sense of *to cut*, it may mean a *lot*, and, by a combination with the Arabic جَد, which means *to be new, to occur, to be fortunate*, may be legitimately taken to denote *fortune*. Indeed, some find this 'fortune,' although not as an idol, in Gen. xxx. 11, where the Sept. has rendered the Kethib גַּד by ἐν τύχη, which is approved by Selden, and especially by Tuch, who does not even wish to change the punctuation, but ascribes the Qametz to the influence of the pause (*Comment. über die Genesis*, ad loc.). This is the sense in which Gesenius, Hitzig, and Ewald have taken *Gad* in their respective versions of Isaiah. All render the clause, 'who spread a table to Fortune.' This view, which is the general one, makes Fortune in this passage to be an object of idolatrous worship. There is great disagreement, however, as to the power of nature which this name was intended to denote; and, from the scanty data, there is little else than mere opinion on the subject. The majority, among whom are some of the chief rabbinical commentators, as well as Gesenius, Münter, and Ewald, consider *Gad* to be the form under which the planet Jupiter was worshipped as the greater star of good fortune (see especially Gesenius, *Comment. über der Isaia*, ad loc.). Others,

among whom is Vitrina, suppose Gad to have represented the Sun; and Movers, the latest writer of any eminence on Syro-Arabian idolatry, takes it to have been the planet Venus (*Die Phönizier*, i. 650).

On the other hand, if *Gad* be derived from גַּד in the sense of *to press, to crowd*, it may mean *a troop, a heap* (to which sense there is an allusion in Gen. xlix. 19); and Hobeisel, as cited in Rosenmüller's *Scholæ*, ad loc., as well as Deyling, in his *Observat. Miscell.* p. 673, have each attempted a mode by which the passage might be explained, if *Gad* and *Meni* were taken in the sense of *troop* and *number*.—J. N.

GAD (גַּד) occurs in two places in Scripture, in both of which it is translated *coriander*, viz. Exod. xvi. 31, 'And it (manna) was like coriander (*gad*) seed, white; and the taste of it was like wafers made of honey;' Num. xi. 7, 'And the manna was as coriander seed, and the colour thereof as the colour of bdellium.' The manna which fell in the desert, and on which the Israelites were fed during their sojourn there, is usually described, from a collation of the different passages in which it is mentioned, as white, round, and like *gad*, which last has almost universally been considered to mean 'coriander' seed, though some prefer other seeds.



302. [*Coriandrum sativum*.]

The chief, and indeed only proof of *gad* signifying the coriander, has been adduced by Celsius (*Hierobot.* vol. ii. p. 81): 'Γοδ̄, quod Africanis *coriandrum* est, ut docet auctor ignotus sed utilissimus, qui Dioscoridem synonymis exoticis auxit et illustravit. Αἰγύπτιοι, inquit, ἔχουσιν, Ἀφροὶ γοδ̄: *coriandrum Ægyptii ochion* appellant, Afri *goid*.' This passage Sprengel incorporates with the text of Dioscorides, as well as the other synonyms, which are supposed by others, as above, to be additions by another but unknown ancient author. Rosenmüller, referring to this passage, observes: 'the Africans, i. e. Carthaginians, whose language, the Punic, was cognate with the Hebrew, called the coriander Γοδ̄, which word is not at all different from the Hebrew *gad*.' Celsius states that

the coriander is frequently mentioned in the *Talmud*. It was known to and used medicinally by Hippocrates: it is mentioned by Theophrastus, as well as Dioscorides, under the name of κόριον or κορίαννον; and the Arabs, in their works on *Matéria Medica*, give *korion* as the Greek synonym of coriander, which they call كوزيرة *kuzereeh*, the Persians *kushneez*, and the natives of India *dhunya*. It is known throughout all these countries, in all of which it is cultivated, being universally employed as a grateful spice, and as one of the ingredients of currie-powder. It is also common in Egypt. 'Ubique,' says Prosper Alpinus, 'in viridariis coriandrum provenit copiosissimum, quod omnes *Cusbaræ* appellant. Herbæque virentis usus in cibo est apud omnes Ægyptios familiarissimus. Etenim ferculum non parant sine foliis coriandri' (*De Plantis Ægypti*, c. xlii. p. 61). Pliny also, long before, mentioned 'coriandrum in Ægypto præcipuum.' It is now very common in the south of Europe, and also in this country, being cultivated, especially in Essex, on account of its seeds, which are required by confectioners, druggists, and distillers, in large quantities: in gardens it is reared on account of its leaves, which are used in soups and salads. The coriander is an umbelliferous plant, the *Coriandrum sativum* of botanists. The fruit, commonly called seeds, is globular, greyish-coloured, about the size of peppercorn, having its surface marked with fine striæ. Both its taste and smell are agreeable, depending on the presence of a volatile oil, which is separated by distillation.—J. F. R.

GADARA was the chief city or metropolis of *Peræa*, lying in the district termed *Gadaritis*, some small distance from the southern extremity of the sea of Galilee, sixty stadia from *Tiberias*, to the south of the river *Hieromax*, and also of the *Scheriat-al-Mandhur* (*Joseph. Antiq.* xiii. 13. 3; *Polyb.* v. 71. 3; *Joseph. De Bell. Jud.* iv. 8. 3; *Plin. Hist. Nat.* v. 15). It was fortified, and stood on a hill of limestone. Its inhabitants were mostly heathens. *Josephus* says of it, in conjunction with *Gaza* and *Hippos*, 'they were Grecian cities' (*Antiq.* xvii. 11. 4). After the place had been destroyed in the domestic quarrels of the Jews, it was rebuilt by *Pompey*, in order to gratify *Demetrius* of *Gadara*, one of his freedmen (*Joseph. De Bell. Jud.* i. 7. 7). *Augustus* added *Gadara*, with other places, to the kingdom of *Herod* (*Joseph. Antiq.* xv. 7. 2); from which, on the death of that prince, it was sundered, and joined to the province of *Syria* (*Joseph. De Bell. Jud.* ii. 6. 3). *Stephen* of *Byzantium* reckoned it a part of *Cœle-Syria*, and *Pliny* (*Hist. Nat.* v. 16) a part of the *Decapolis*. At a later period it was the seat of an episcopal see in *Palæstina Secunda*, whose bishops are named in the councils of *Nice* and *Ephesus* (*Reland, Palest.* pp. 176, 215, 223, 226).

Most modern authorities (*Winer, Handwörterb.*, *Raumer* in his *Palästina*, *Burckhardt*, *Seetzen*) find *Gadara* in the present village of *Om-keis*. *Buckingham*, however, identifies *Om-keis* with *Gamala* (*Trav. in Palest.*); though it may be added that his facts, if not his reasonings, lead to a conclusion in favour of the general opinion. Accordingly, taking *Om-keis* to be the ancient *Gadara*, we may avail ourselves in this article of

the descriptions of its ruins and scenery which Buckingham has given.

Limestone is a species of rock in which caverns of greater or less dimensions are easily and often naturally formed. Accordingly the hills on which Gadara was placed were full of caverns, which were used for tombs. Buckingham speaks of several grottoes, which formed the necropolis of the city, on the eastern brow of the hill. The first two examined by him were plain chambers hewn down so as to present a perpendicular front. The third tomb had a stone door, as perfect as on the day of its being first hung. The last was an excavated chamber, seven feet in height, twelve paces long, and ten broad; within it was a smaller room. Other tombs were discovered by Buckingham as he ascended the hill. He entered one in which were ten sepulchres, ranged along the inner wall of the chamber in a line, being pierced inward for their greatest length, and divided by a thin partition left in the rock, in each of which was cut a small niche for a lamp. Still more tombs were found, some containing sarcophagi, some without them; all, however, displaying more or less of architectural ornament.

On reaching the summit of the hill, Buckingham was rewarded by a very fine view. Though the country is stony and bare, and the hills destitute of wood and verdure, 'it was impossible,' he says, 'not to admire the commanding view and the grandeur, as well as the extent of the scene.' On the N.E. flowed the Nahr-el-Hami, the ancient Hieromax, coming westward, through high cliffs on its northern bank, and a bed of verdant shrubs on its southern, and bending its way, by the hot springs and ruins of the Roman bath on its edge, to increase the waters of the Jordan. On the N.W., in a deep hollow surrounded by lofty hills, was the still sea of Galilee or lake of Genesareth, on the southern bank of which stood the small village of Samak, and on the western the town of Tiberias, still preserving nearly its ancient name. From this lake the Jordan was seen to issue and wind its southern course through a desert plain.

The city formed nearly a square. The upper part of it stood on a level spot, and appears to have been walled all round, the acclivities of the hill being on all sides exceedingly steep. The eastern gate of entrance has its portals still remaining. Among the ruins Buckingham found a theatre, an Ionic temple, a second theatre, besides traces and remnants of streets and houses. The prevalent orders of architecture are the Ionic and the Corinthian.

Burckhardt also found near Gadara warm sulphurous springs. They were termed *Therma Helix*, and were reckoned inferior only to those of Baixæ (Euseb. *Onomast.*). According to Epiphanius (*Adv. Hæres.* i. 131) a yearly festival was held at these baths (Reland, p. 775). For coins, see Eckhel (*Doctr. Num.* iii. p. 348). The caverns in the rocks are also mentioned by Epiphanius (*l. c.*) in terms which seem to show that they were in his day used for dwellings as well as for tombs.

Gadara is the scene of the miracle recorded in Matt. viii. 28; Mark v. 1; Luke viii. 26. Buckingham's remarks on this event are well worth quoting:—'The accounts given of the habitation of the demoniac from whom the legion of devils was cast out here struck us very forcibly, while

we ourselves were wandering among rugged mountains, and surrounded by tombs still used as dwellings by individuals and whole families. A finer subject for a masterly expression of the passions of madness in all their violence, contrasted with the serenity of virtue and benevolence in him who went about doing good, could hardly be chosen for the pencil of an artist; and a faithful delineation of the rugged and wild majesty of the mountain-scenery here on the one hand, with the still calm of the waters of the lake on the other, would give an additional charm to the picture.' One of the ancient tombs was, when our traveller saw it, used as a carpenter's shop, the occupier of it being employed in constructing a rude plough. A perfect sarcophagus remained within, which was used by the family as a provision-chest.

The text of the original narratives which record the cure of the Gadarene demoniac, or demoniacs, has more than its share of difficulty in regard to the name of the locality where the event took place. Mark and Luke indeed agree in describing it as 'the country of the Gadarenes,' but Matthew calls it 'the country of the Gergesenes.' One various reading gives 'of the Gerasenes, another 'of the Gadarenes.' But Gerasa [GERASA] lay at a wide distance from the lake of Galilee, and possibly the difficulty which hence arose was that which led Origen to conjecture that the reading should be 'of the Gergesenes,' for with Origen this reading took its rise (Rosenmüller, ii. 2. 22; Reland, pp. 774, 806). Indeed to him the place as well as the name owes its existence. Gergesa is found in some maps, but the best authorities omit it (Kieppert's *Atlas*); for it is not found either in the Bible or Josephus, and Scholz has substituted in his text Γαδάρων for Γεργεσηνών. These remarks and emendations remove the difficulty presented in the *textus receptus* and the common version.—J. R. B.

GALATIA (Γαλατία, ἡ Γαλατικὴ χώρα), a province of Asia Minor, bounded on the north by Bithynia and Paphlagonia, on the south by Lycæonia, on the east by Pontus and Cappadocia, and on the west by Phrygia and Bithynia. It derived its name from the Gallic or Celtic tribes who, about 280 years B.C., made an irruption into Macedonia and Thrace. At the invitation of Nicomedes, king of Bithynia, they passed over the Hellespont to assist that prince against his brother Zibosta. Having accomplished this object, they were unwilling to retrace their steps; and strengthened by the accession of fresh hordes from Europe, they overran Bithynia and the neighbouring countries, and supported themselves by predatory excursions, or by imposts exacted from the native chiefs. After the lapse of forty years, Attalus I., king of Pergamus, succeeded in checking their nomadic habits, and confined them to a fixed territory. Of the three principal tribes, the Trocmi (Τρόκμοι) settled in the eastern part of Galatia near the banks of the Halys; the Tectosages (Τεκτόσαγες) in the country round Ancyra; and the Tolistobogii (Τολιστοβόγιοι) in the south-western parts near Pessinus. They retained their independence till the year B.C. 189, when they were brought under the power of Rome by the consul Cn. Manlius (Livy, xxxviii.; Polybius, xxii. 24), though still governed by their own princes. In the year B.C. 25 Galatia became a

Roman province. Under the successors of Augustus the boundaries of Galatia were so much enlarged that it reached from the shores of the Euxine to the Pisidian Taurus. In the time of Constantine a new division was made, which reduced it to its ancient limits; and by Theodosius I. or Valens it was separated into *Galatia Prima*, the northern part, occupied by the Trocmi and Tectosages, and *Galatia Secunda* or *Salutaris*: Ancyra was the capital of the former, and Pessinus of the latter.

From the intermixture of Gauls and Greeks Galatia was also called Gallo-Græcia (Γαλλο-γραικία, Strabo, xii. 5), and its inhabitants Gallo-Græci. But even in Jerome's time they had not lost their native language: 'Galatas excepto sermone Græco, quo omnis Oriens loquitur, propriam linguam eandem præne habere quam Treviros, nec referre si aliqua inde corruerint,' &c. (*Prolog. ad Comment. in Ep. ad Gal.*; De Wette's *Lehrbuch*, p. 231).

The Gospel was introduced into this province by the Apostle Paul. His first visit is recorded in Acts xvi. 6, and his second in Acts xviii. 23. (*Penny Cyclopædia*, arts. 'Celtæ' and 'Galatia'; Mannert's *Geographie der Griechen und Römer*, vi. 3, ch. 4; Merleker's *Lehrbuch der Historisch-comparativen Geographie*, iv. 1, p. 281.)—J. E. R.

GALATIANS, EPISTLE TO THE. The Pauline origin of this epistle is attested not only by the superscription which it bears (i. 1), but also by frequent allusions in the course of it to the great Apostle of the Gentiles (comp. i. 13-23; ii. 1-14), and by the unanimous testimony of the ancient church (Lardner, *Works*, vol. ii. 8vo.). It is corroborated also by the style, tone, and contents of the epistle, which are perfectly in keeping with those of the Apostle's other writings.

The parties to whom this epistle was addressed are described in the epistle itself as 'the churches of Galatia' (i. 2; comp. iii. 1). Into this district the Gospel was first introduced by Paul himself (Acts xvi. 6; Gal. i. 8; iv. 13, 19). Churches were then also probably formed; for on revisiting this district some time after his first visit it is mentioned that he 'strengthened the disciples' (Acts xviii. 23). These churches seem to have been composed principally of converts directly from Heathenism, but partly, also, of Jewish converts, both pure Jews and proselytes. Unhappily, the latter, not thoroughly emancipated from early opinions and prepossessions, or probably influenced by Judaizing teachers who had visited these churches, had been seized with a zealous desire to incorporate the rites and ceremonies of Judaism with the spiritual truths and simple ordinances of Christianity. So active had this party been in disseminating their views on this head through the churches of Galatia, that the majority at least of the members had been seduced to adopt them (i. 6; iii. 1, &c.). To this result it is probable that the previous religious conceptions of the Galatians contributed; for, accustomed to the worship of Cybele, which they had learned from their neighbours the Phrygians, and to the theosophic doctrines with which that worship was associated, they would be the more readily induced to believe that the fulness of Christianity could alone be developed through the symbolical adumbrations of an elaborate ceremonial (Neander, *Apostol. Zeitalter*, s. 400, 2te Aufl.).

From some passages in this epistle (*e. gr.* i. 11-24; ii. 1-21) it would appear also that insinuations had been disseminated among the Galatian churches to the effect that Paul was not a divinely-commissioned Apostle, but only a messenger of the church at Jerusalem; that Peter and he were at variance upon the subject of the relation of the Jewish rites to Christianity; and that Paul himself was not at all times so strenuously opposed to those rites as he had chosen to be among the Galatians. Of this state of things intelligence having been conveyed to the Apostle, he wrote this epistle for the purpose of vindicating his own pretensions and conduct, of counteracting the influence of these false views, and of recalling the Galatians to the simplicity of the Gospel which they had received. The importance of the case was probably the reason why the Apostle put himself to the great labour of writing this epistle with his own hand (vi. 11).

The epistle consists of *three* parts. In the *first* part (i.-ii.), after his usual salutations, Paul vindicates his own Apostolic authority and independence as a directly-commissioned ambassador of Christ to men, and especially to the Gentile portion of the race; asserting that the Gospel which he preached was the only Gospel of Christ,—expressing his surprise that the Galatians had allowed themselves to be so soon turned from him who had called them to a different Gospel,—denouncing all who had thus seduced them as troublers of the church, perverters of the doctrine of Christ, and deserving, even had they been angels from heaven, to be placed under an anathema instead of being followed,—maintaining the divine origin of his Apostolic mission, which he illustrates by the history of his conversion and early conduct in the service of Christ,—and declaring that, so far from being inferior to the other Apostles, he had ever treated with them on equal terms, and been welcomed by them as an equal. Having in the close of this part of the epistle been led to refer to his zeal for the great doctrine of salvation by the grace of God through faith in Christ, he enters at large, in the *second* part (iii.-iv.), upon the illustration and defence of this cardinal truth of Christianity. He appeals to the former experience of the Galatians as to the way in which they had received the Spirit, to the case of Abraham, and to the testimony of Scripture in support of his position that it is by faith and not by the works of the law that men are accepted of God (iii. 1-9). He proceeds to remind them that the law has brought a curse upon men because of sin, a curse which it has no power to remove, and from which the sinner can be redeemed only through the substitutionary work of Christ, by whose means the blessing of Abraham comes upon the Gentiles. And lest any should object that the law being of more recent origin than the covenant must supersede it, he shows that this cannot be the case, but that the covenant must be perpetual, whilst the law is to be regarded only in the light of a temporary and intercalary arrangement, the design of which was to forward the fulfilment of the promise in Christ (10-29). The relation of the Jewish church to the Christian is then illustrated by the case of an heir under tutors and governors as contrasted with the case of the same person when he is of age and has become master of all; and the Galatians are exhorted not willingly to

descend from the important and dignified position of sons to that of mere servants in God's house—an exhortation which is illustrated and enforced by an allegorical comparison of the Jewish church to Ishmael, the son of Hagar, and of the Christian to Isaac, the son of Sarah, and the Child of Promise (iv. 1-31). The *third* part of the Epistle (v.-vi.) is chiefly hortatory and admonitory: it sets forth the necessity of steadfast adherence to the liberty of the Gospel in connection with obedience to the moral law as a rule of duty, the importance of mutual forbearance and love among Christians, and the desirableness of maintaining a firm adherence to the doctrine of Christ and Him crucified. The epistle concludes with benedictions and prayers.

Respecting the time when and the place where this epistle was written, great diversity of opinion prevails. Marcion held this to be the earliest of Paul's epistles (Epiphanius, *Adv. Hæres.* xlii. 9); and Tertullian is generally supposed to favour the same opinion, from his speaking of Paul's zeal against Judaism displayed in this epistle as characteristic of his being yet a neophyte (*Adv. Marc.* i. 20); though, to us, it does not appear that in this passage Tertullian is referring at all to the *writing* of this epistle, but only to Paul's personal intercourse with Peter and other of the Apostles mentioned by him in the epistle (ii. 9-14). Michaelis also has given his suffrage in favour of a date earlier than that of the Apostle's second visit to Galatia, and very shortly after that of his first. Koppe's view (*Nov. Test.* vol. vi. p. 7) is the same, though he supposes the Apostle to have preached in Galatia *before* the visit mentioned by Luke in Acts xvi. 6, and which is usually reckoned his first visit to that district. Others, again, such as Mill (*Proleg. in Nov. Test.* p. 4), Calovius (*Biblia Illust.* t. iv. p. 529), and, more recently, Schrader (*Der Ap. Paulus*, th. i. s. 226), place the date of this epistle at a late period of the Apostle's life: the last, indeed, advocates the date assigned in the Greek MSS. and in the Syriac and Arabic versions, which announce that it was 'written from Rome' during the Apostle's imprisonment there. The majority, however, concur in a medium view between these extremes, and fix the date of this epistle at some time shortly after the Apostle's second visit to Galatia. This opinion appears to us to be the only one that has any decided support from the epistle itself. From the Apostle's abrupt exclamation in ch. i. 6, 'I marvel that ye are so soon removed from him that called you,' &c., it seems just to infer that he wrote this epistle not very long after he had left Galatia. It is true, as has been urged, that *ὄρω ταχέως* in this verse may mean 'so quickly,' as well as 'so soon'; but the abruptness of the Apostle's statement appears to us rather to favour the latter rendering: for, as a complaint of the *quickness* of their change respected the *manner* in which it had been made, and as the Apostle could be aware of that only by report, and as it was a matter on which there might be a difference of opinion between him and them, it would seem necessary that the *grounds* of such a charge should be stated; whereas if the complaint merely related to the shortness of time during which, after the Apostle had been among them, they had remained steadfast in the faith, a mere allusion to it was sufficient, as it was a matter not admitting of any diversity of opinion.

We infer, then, from this expression that this epistle was written not long after Paul had been in Galatia. The question, however, still remains, which of the two visits of Paul to Galatia mentioned in the Acts was it after which this epistle was written? In reply to this Michaelis and some others maintain that it was the *first*; but in coming to this conclusion they appear to have unaccountably overlooked the Apostle's phraseology (iv. 13), where he speaks of circumstances connected with his preaching the Gospel among the Galatians, *τὸ πρότερον*, *the former time*, an expression which clearly indicates that at the period this epistle was written, Paul had been at least *twice* in Galatia.* On these grounds it is probable that the Apostle wrote and despatched this epistle not long after he had left Galatia for the second time, and, perhaps, whilst he was residing at Ephesus (comp. Acts xviii. 23; xix. 1, sqq.). The reasons which Michaelis urges for an earlier date are of no weight. He appeals, in the first place, to ch. i. 2, and asks whether Paul would have used the vague expression, 'all the brethren,' without naming them, had it not been that the parties in question were those by whom he had been accompanied on his first visit to Galatia, viz. Silas and Timothy, and, 'perhaps, some others.' The answer to this obviously is, that had Paul referred in this expression to these individuals, who were known to the Galatians, he was much more likely on that very account to have named them than otherwise; and besides, the expression 'all the brethren that are with me' is much more naturally understood of a considerable number of persons, such as the elders of the church at Ephesus, than of two persons, and, 'perhaps, some others.' Again, he urges the fact that, about the time of Paul's first visit to Galatia, Asia Minor was full of zealots for the law, and that consequently it is easier to account for the seduction of the Galatians at this period than at a later. But the passage to which Michaelis refers in support of this assertion (Acts xv. 1) simply informs us that certain Judaizing teachers visited Antioch, and gives us no information whatever as to the time when such zealots entered Asia Minor. In fine, he lays great stress on the circumstance that Paul in recapitulating the history of his own life in the first and second chapters brings the narrative down only to the period of the conference at Jerusalem, the reason of which is to be found, he thinks, in the fact that this epistle was written so soon after that event that nothing of moment had subsequently occurred in the Apostle's history. But even admitting that the period referred to in this second chapter was that of the conference mentioned Acts xv. (though this is much doubted by many writers of note), the reason assigned by Michaelis for Paul's carrying the narrative of his life no further than this cannot be admitted: for it over-

* Prof. Stuart says, in bar of this conclusion, that '*πρότερον* means only a time antecedent to that in which he (Paul) wrote.' (*Notes to Fostick's Translation of Hug's Introd.* p. 748.) But, in making this remark, the learned professor has not observed that Paul's expression is not simply *πρότερον*, but *τὸ πρότερον*, which makes all the difference between the rendering 'in time past' and the rendering 'the former time.' The latter alone is proper here.

looks the design of the Apostle in furnishing that narrative, which was not certainly to deliver himself of a piece of mere autobiographical detail; but to show from certain leading incidents in his early Apostolic life how from the first he had claimed and exercised an independent Apostolic authority, and how his rights in this respect had been admitted by the pillars of the church, Peter, James, and John. For this purpose it was not necessary that the narrative should be brought down to a lower date than the period when Paul went forth as the Apostle of the Gentiles, formally recognised as such by the other Apostles of Christ. This fact, then, is as little in favour of Michaelis's theory as any of the other arguments which he has adduced.

Of commentaries on this epistle the most important are the following: Borger, *Interpretatio Ep. Pauli ad Galatas*, Svo. Lugd. Bat. 1807; Wiener, *Pauli Ep. ad Gal. perpetua Annot. illustravit*, Svo. ed. tertia, Lipsiæ, 1829; Rückert, *Commentar üb. d. Brief Pauli an d. Gal.*, Svo., Leipzig, 1833; Usteri, *Commentar üb. d. Br. Pauli an d. Gal. Svo.* Zürich, 1833; Hermann, *De Pauli Epist. ad Gal. tribus primis capitibus*, 4to. Lips. 1832.—W. L. A.

GALBANUM. [CHALBANEH.]

GALILEE (Γαλιλαία), the Greek form of the name given to one of the three principal divisions of Palestine, the other two being Judæa and Samaria. This name of the region was very ancient. It occurs in the Hebrew forms of *Galil* and *Galilah*, Josh. xx. 7; xxi. 3; 1 Kings ix. 11; 2 Kings xv. 29; and in Isa. viii. 23 we have גליל הנונים 'Galilee of the nations' (Γαλιλαία ἀλλοφύλων, 1 Macc. v. 15; Matt. iv. 15).

Galilee was the northernmost of the three divisions, and was divided into Upper and Lower. The former district had Mount Lebanon and the countries of Tyre and Sidon on the north; the Mediterranean Sea on the west; Abilene, Ἰβυρᾶ, and the country of Decapolis on the east; and Lower Galilee on the south. This was the portion of Galilee which was distinctively called 'Galilee of the nations,' or of the 'Gentiles,' from its having a more mixed population, *i. e.* less purely Jewish, than the others. Cæsarea Philippi was its principal city. Lower Galilee had Upper Galilee on the north, the Mediterranean on the west, the Sea of Galilee or Lake of Gennesareth on the east, and Samaria on the south. Its principal towns were Tiberias, Chorazin, Bethsaida, Nazareth, Cana, Capernaum, Nain, Cæsarea of Palestine, and Ptolemais. This is the district which was of all others the most honoured with the presence of our Saviour. Here he lived entirely until he was thirty years of age; and although, after the commencement of his ministry, he frequently visited the other provinces, it was here that he chiefly resided. Here also he made his first appearance to the apostles after his resurrection; for they were all of them natives of this region, and had returned hither after the sad events at Jerusalem (Matt. xxviii. 7).

Hence the disciples of Christ were called 'Galileans.' They were easily recognised as such; for the Galileans spoke a dialect of the vernacular Syriac different from that of Judæa, and which was of course accounted rude and impure, as all provincial dialects are considered to be, in com-

parison with that of the metropolis. It was this which occasioned the detection of St. Peter as one of Christ's disciples (Mark xiv. 70). The Galilean dialect (as we learn from Buxtorf, Lightfoot, and others), was of a broad and rustic tone, which affected the pronunciation not only of letters but of words. It partook much of the Samaritan and Syriac idiom; but, in the instance of Peter, it must have been the tone which bewrayed him, the words being seemingly too few for that effect.

The Galileans are mentioned by Josephus (*Antiq.* xvii. 10. 2; *De Bell. Jud.* ii. 10. 6; iii. 3. 2) as a turbulent and rebellious people, ready on all occasions to rise against the Roman authority. This character of them explains what is said in Luke xiii. 1, with regard to 'the Galileans whose blood Pilate had mingled with their sacrifices.' Josephus, indeed, does not mention any Galileans slain in the Temple by Pilate; but the character which he gives that people sufficiently corroborates the statement. The tumults to which he alludes were, as we know, chiefly raised at the great festivals, when sacrifices were slain in great abundance; and on all such occasions the Galileans were much more active than the men of Judæa and Jerusalem, as is proved by the history of Archelaus (*Joseph. Antiq.* xvii. 9. 10); which case, indeed, furnishes an answer to those who deny that the Galileans attended the feasts with the rest of the Jews.

The seditious character of the Galileans also explains why Pilate, when sitting in judgment upon Jesus, caught at the word Galilee when used by the chief priests, and asked if he were a Galilean (Luke xxiii. 8). To be known to belong to that country was of itself sufficient to prejudice Pilate against him, and to give some countenance to the charges, unsupported by impartial evidence, which were preferred against him, and which Pilate himself had, just before, virtually declared to be false.

GALILEE, SEA OF. [SEA.]

GALL occurs in its *primary* and *proper* meaning, as denoting the substance secreted in the gall-bladder of animals, commonly called bile, in the following passages: Job xvi. 13, 'He poureth out my gall,' מררתי; Sept. γῆρ χολῆν μου; Vulg. *viscera mea*. The metaphors in this verse are taken from the practice of huntsmen, who first surround the beast, then shoot it, and next take out the entrails. The meaning, as given by Bp. Heath, is, 'he entirely destroyeth me.' Job xx. 14 (describing the remorse of a wicked man), מרורת פתנים, 'the gall of adders' (which according to the ancients is the seat of their poison, *Plin. Hist. Nat.* ii. 37); Sept. χολη ἀσπίδος; Vulg. *fel aspidum*. Job xx. 25, where, to describe the certainty of a wicked man's destruction, it is said, 'the glittering sword cometh out of his gall,' מרורתו; Sept. *dialtras* αὐτοῦ, *his vitals*; Vulg. *amaritudinis sua*. In the story of Tobit the *gall* of a fish is said to have been used to cure his father's blindness (Tobit vi. 8; xi. 10, 13). Pliny refers to the use of the same substance for diseases of the eye, 'ad oculorum medicamenta utile habetur' (*Hist. Nat.* xxviii. 10); also speaking of the fish *callionymus*, he says, 'Fel cicatrices sanat, et carnes oculorum superfluas consumit' (xxxii. 4. 7). Galen and other writers praise the use of the liver of the *silyurus* in cases of dimness of sight. For the other senses of gall, see ROSA.—J. F. D.

GALLIO (Γαλλίωv). Junius Annæus Gallio, elder brother of Seneca the philosopher. His name was originally M. Ann. Novatus, but changed to Jun. Ann. Gallio in consequence of his adoption by Jun. Gallio the rhetorician ('pater Gallio,' Quintil. *Inst. Orat.* iii. 1. § 21; ix. 2. § 91). Seneca dedicated to him his treatise *De Vita Beata*, and in the preface to the fourth book of his *Naturales Questiones* describes him as a man universally beloved ('nemo mortalium uni tam dulcis est, quam hic omnibus'); and who, while exempt from all other vices, especially abhorred flattery ('inexpugnabilem virum adversus insidias, quas nemo non in sinum recipit'). According to Eusebius, he committed suicide before the death of Seneca ('Junius Gallio, frater Senecæ, egregius declamator, propria se manu interfecit,' *Thesaurus Temporum*, &c., p. 161, Amstel. 1658); but Tacitus speaks of him as alive after that event (*Annal.* xv. 73), and Dion Cassius states that he was put to death by order of Nero. He was *Proconsul* (ἀνθυπατεύωντος, *Tex. rec.* ἀνθυπάτου ὄντος, Tischendorf) of *Achaia* (Acts xviii. 12) under the Emperor Claudius, when Paul first visited Corinth, and nobly refused to abet the persecution raised by the Jews against the Apostle. Dr. Lardner has noticed the strict accuracy of Luke in giving him this designation, which is obscured in the Auth. Vers. by the use of the term *deputy* (*Credibility*, part i. book i. ch. i.; *Works*, i. 34).—J. E. R.

GAMALIEL (Γαμλιήλ), *God is my rewarder*), a member of the Sanhedrim in the early times of Christianity, who, by his favourable interference, saved the Apostles from an ignominious death (Acts v. 34). He was the teacher of the Apostle Paul before the conversion of the latter (Acts xxii. 3). He bears in the Talmud the surname of גמליהל *hazoken*, 'the old man,' and is represented as the son of Rabbi Simeon, and grandson of the famous Hillel: he is said to have occupied a seat, if not the presidency, in the Sanhedrim during the reigns of Tiberius, Caligula, and Claudius, and to have died eighteen years after the destruction of Jerusalem.

There are idle traditions about his having been converted to Christianity by Peter and John (Phot. *Cod. clxxi.* p. 199); but they are altogether irreconcilable with the esteem and respect in which he was held even in later times by the Jewish Rabbins, by whom his opinions are frequently quoted as an all-silencing authority on points of religious law. Neither does his interference in behalf of the Apostles at all prove—as some would have it—that he secretly approved their doctrines. He was a dispassionate judge, and reasoned in that affair with the tact of worldly wisdom and experience, urging that religious opinions usually gain strength by opposition and persecution (Acts v. 36, 37), while, if not noticed at all, they are sure not to leave any lasting impression on the minds of the people, if devoid of truth (ver. 38); and that it is vain to contend against them, if true (ver. 39). That he was more enlightened and tolerant than his colleagues and contemporaries, is evident from the very fact that he allowed his zealous pupil Saul to turn his mind to Greek literature, which, in a great measure, qualified him afterwards to become the Apostle of the Gentiles; while by the Jewish Palestine laws,

after the Maccabæan wars, even the Greek *language* was prohibited to be taught to the Hebrew youth (Mishna, סוטה *Sotah*, ix. 14).

Another proof of the high respect in which Gamaliel stood with the Jews long after his death, is afforded by an anecdote told in the Talmud respecting his tomb, to the effect that Onkelos (the celebrated Chaldean translator of the Old Testament) spent seventy pounds of incense at his grave in honour of his memory (יחזקיהו *Youchisin*, 59).—E. M.

GAMES. If by the word are intended mere secular amusements, which are the natural expression of vigorous health and joyous feeling, fitted, if not designed, to promote health, hilarity, and friendly feeling, as well as to aid in the development of the corporeal frame, we must look to other quarters of the globe, rather than to Palestine, for their origin and encouragement. The Hebrew temperament was too deep, too earnest, too full of religious emotion, to give rise to games having a national and permanent character. Whatever of amusement, or rather of recreation, the descendants of Abraham possessed, partook of that religious complexion which was natural to them; or rather the predominant religiousness of their souls gave its own hue, as to all their engagements, so to their recreations. The influence of religion pervaded their entire being; so that whatever of recreation they needed or enjoyed is for the most part found blended with religious exercises. Hence their great national festivals served at once for the devout service of Almighty God, and the recreation and refreshment of their own minds and bodies.

Games, however, are so natural to man, especially in the period of childhood, that no nation has been or can be entirely without them. Accordingly a few traces are found in the early Hebrew history of at least private and childish diversions. The heat of the climate too in Syria would indispose the mature to more bodily exertion than the duties of life imposed, while the gravity which is characteristic of the Oriental character might seem compromised by anything so light as sports. Dignified ease therefore corresponds with the idea which we form of Oriental recreation. The father of the family sits at the door of his tent, or reclines on the housetop, or appears at the city gate, and there tranquilly enjoys repose, broken by conversation, under the light and amid the warmth of the bright and breezy heavens, in the cool of the retiring day, or before the sun has assumed his burning ardours (Deut. xvi. 14; Lam. v. 14). Even among the active Egyptians, whose games have been figured on their mural tablets, we find little which suggests a comparison with the vigorous contests of the Grecian games. One of the most remarkable is the following (No. 302), showing what appears to be play with the single-stick.

Zechariah (viii. 5) alludes to the sportiveness of children in the streets as a sign and consequence of that peace and prosperity which are so free from alarm that the young take their usual games, and are allowed entire liberty by their parents:—'and the streets of the city shall be full of boys and girls playing in the streets thereof' (comp. Jer. xxx. 19). An interesting passage illustrative of these street-amusements is found in Matt. xi. 16:—'This generation is like

unto children sitting in the markets and calling unto their fellows, We have piped unto you and ye have not danced, we have mourned unto you and ye have not lamented.'

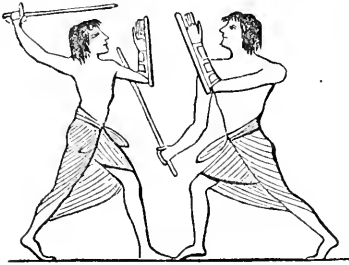

303.

That the elegant amusement of playing with tamed and trained birds was not unusual may be learnt from Job xli. 5:—'Wilt thou play with him (leviathan) as with a bird?' Commenting on Zech. xii. 3, Jerome mentions an amusement of the young, which we have seen practised in more than one part of the north of England. 'It is customary,' he says, 'in the cities of Palestine, and has been so from ancient times, to place up and down large stones to serve for exercise for the young, who, according in each case to their degree of strength, lift these stones, some as high as their knees, others to their middle, others above their heads, the hands being kept horizontal and joined under the stone.'

Music, song, and dancing were recreations reserved mostly for the young or for festive occasions. From Lam. v. 16, 'the crown is fallen from our head' (see the entire passage on the subject of games), it might be inferred that, as among the Greeks and Latins, chaplets of flowers were sometimes worn during festivity. To the amusements just mentioned frequent allusions are found in holy writ, among which may be given Ps. xxx. 11; Jer. xxxi. 13; Luke xv. 25. In Isaiah xxx. 29, a passage is found which serves to show how much of festivity and mirth was mingled with religious observances; the journey on festival occasions up to Jerusalem was enlivened by music, if not by dancing:—'Ye shall have a song as in the night when a holy solemnity is kept; and gladness of heart, as when one goeth with a pipe to come into the mountain of the Lord, to the Mighty One of Israel.' A passage occurs in 2 Sam. ii. 14, which may indicate the practice among the ancient Israelites of games somewhat similar to the jousts and tournaments of the middle ages. On the subject of dancing see Michaelis (*Mos. Recht*, art. 197). No trace is found in Hebrew antiquity of any of the ordinary games of skill or hazard which are so numerous in the western world.

The Grecian influence which made itself felt after the Exile led to a great change in the manners and customs of the Hebrew nation. They were soon an almost different people from what we find them in the days of their national independence and primitive simplicity. In Macc. i. 14, we find evidence that the Grecian games were introduced; and that a gymnasium was built under Antiochus Epiphanes:—'They built a place of exercise at Jerusalem, according to the custom

of the heathen.' Compare 2 Macc. iv. 12, 13, 14, where special mention is made of the prevalence of 'Greek fashions,' and 'the game of Discus;' though, as appears clearly from the last passage (v. 17), these practices were considered contrary to the Mosaic institutions, and were hateful to pious Israelites. The Herodian princes had theatres and amphitheatres built in Jerusalem and other cities of Palestine, in which were held splendid games, sometimes in honour of their Roman masters. We cite a remarkable passage to this effect from Josephus (*Antiq.* xv. 8. 1):—'Herod revolted from the laws of his country, and corrupted the ancient constitution by introducing foreign practices, while those religious observances which used to lead the multitude to piety were neglected. He appointed solemn games to be celebrated every fifth year in honour of Caesar, and built a theatre at Jerusalem, as also a very great amphitheatre in the plain—both costly works, but contrary to Jewish customs. He also called men together out of every nation: wrestlers and others, who strove for prizes in these games, were invited by the hope of reward and the glory of victory. The most eminent were got together, for the rewards were very great, not only to those that performed their exercise naked, but to musicians also. He moreover offered no small rewards to those who ran for prizes in chariot-races, when they were drawn by two, three, or four pairs of horses. He made also great preparation of wild beasts, and even of lions in great abundance, and of such other beasts as were either of uncommon strength or rarely seen. These fought one with another, or men condemned to death fought with them. Above all the rest the trophies gave most displeasure to the Jews, who imagined them to be images.' (See also *Antiq.* xvi. 5. 1; xix. 7. 4; xix. 8. 2; Eichhorn, *De Judæor. re scænica*, in the *Comment. Goetting. Rec.*) The drama does not appear to have been introduced, but Jews were in foreign countries actors of plays (*Joseph. Vita*, § 3). The passage already cited (see the original) is full of evidence how distasteful these heathenish games were to the more sound-minded part of the nation.

These facts make it the less surprising that allusions should be found in the New Testament writings to the Grecian games, on which we think it desirable to supply somewhat detailed information, in order to serve as illustrations of Scriptural language.

The fact that, as we have seen, the games of the amphitheatre were celebrated even in Jerusalem, serves to make it very likely that Paul, in 1 Cor. xv. 32; iv. 9, alludes to these detestable practices, though it is not probable that the apostle was himself actually exposed to the fury of the raging animals. Contrary to the opinion of some writers, the reference to these combats appears to us very clear, though it was only metaphorically that Paul 'fought with beasts at Ephesus.'

The word which the Apostle (1 Cor. xv. 32) uses is emphatic and descriptive, *θηριομαχία*. The *θηριομαχία* or beast-fight (*venatio* in Latin) constituted among the Romans a part of the amusements of the circus or amphitheatre. It consisted in the combat of human beings with animals. The persons destined to this barbarous kind of amusement were termed *θηρομάχοι*,

bestiarii. They were generally of two classes—1. Voluntary, that is, persons who fought either for amusement or for pay: these were clothed and provided with offensive and defensive weapons.



304.

2. Condemned persons, who were mostly exposed to the fury of the animals unclouted, unarmed, and sometimes bound (Cic. *Pro Sext.* 64; *Ep. ad Quint. Frat.* ii. 6; Senec. *De Benef.* ii. 19; Tertull. *Apol.* 9). As none but the vilest of men were in general devoted to these beast-fights, no punishment could be more condign and cruel than what was frequently inflicted on the primitive Christians, when they were hurried away 'to the lions' (as the phrase was), merely for their fidelity to conscience and to Christ, its Lord. Ephesus appears to have had some unenviable distinction in these brutal exhibitions (Schleusner, *in voc.*), so that there is a peculiar propriety in the language of the Apostle.

Of these beast-fights the Romans were passionately fond. The number of animals which appear to have been from time to time engaged in them, is such as to excite in the reader's mind both pity and aversion. Sylla, during his prætorship, sent into the arena no fewer than 100 lions, which were butchered by beings wearing the human shape. Pompey caused the destruction in this way of 600 lions. On the same occasion there perished nearly twenty elephants. These numbers, however, are small compared with the butchery which took place in later periods. Under Titus 5000 wild and 4000 tame animals, and in the reign of Trajan 11,000 animals, are said to have been destroyed.

The New Testament, in several places, contains references to the celebrated Grecian Games, though it may be allowed that some commentators have imagined allusions where none were designed. As might, from his heathen learning, be expected, it is Paul who chiefly supplies the passages in question. In Gal. ii. 2, 'Lest by any means I should run in vain;' v. 7, 'Ye did run well, who did hinder you?' Phil. ii. 16,

That I may rejoice in the day of Christ that I have not run in vain nor laboured in vain; Heb. xii. 1, 'Run with patience the race set before us;' xii. 4, 'Ye have not resisted unto blood, striving against sin' (*ἀνταγωνίζομενοι*); Phil. iii. 14, 'I press toward the mark for the prize;' 2 Tim. ii. 5, 'If a man strive he is not crowned except he strive lawfully.' The most signal passage, however, is found in 1 Cor. ix. 24-27, 'Know ye not that they which run in a race run all, but one receiveth the prize? So run that ye may obtain. And every man that striveth for the mastery is temperate in all things. Now they do it to obtain a corruptible crown; but we an incorruptible. I therefore so run, not as uncertainly; so fight I, not as one that beateth the air; but I keep under my

body, and bring it into subjection, lest that by any means, when I have preached to others, I myself should be a castaway.' In the Old Testament two passages contain a clear reference to games; Ps. xix. 5, 'Rejoiceth as a strong man to run a race;' Eccl. ix. 11, 'I said that the race is not to the swift.'

These Scriptural allusions are the more appropriate, because the Grecian games were in their origin and in their best days intimately connected with religion. Games in Greece were very numerous. They are traceable by tradition back to the earliest periods of Grecian civilization. Indeed, much of the obscurity which rests on their origin is a consequence and a sign of their high and even mythic antiquity.

Four of these games stood far above the rest, bearing the appellation of *τεροί*, 'sacred,' and deriving their support from the great Hellenic family at large, though each one had special honour in its own locality: these four were the Olympic, Pythian, Nemean, and Isthmian. The first were held in the highest honour. The victors at the Olympic games were accounted the noblest and happiest of mortals, and every means was taken that could show the respect in which they were held. These games were celebrated every five years at Olympia, in Elis, on the west side of the Peloponnesus. Hence the epoch called the Olympiads.

The gymnastic exercises were laid down in a well-planned systematic series, beginning with the easier (*κούφα*), and proceeding on to the more

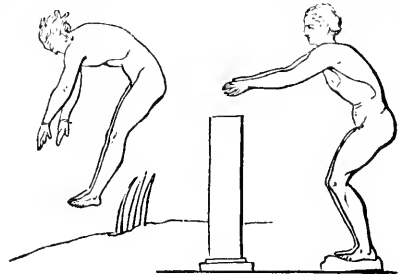

305.

difficult (*βαρέα*). Some of these were specially fitted to give strength, others agility; some educated the hands, others the feet. Among the

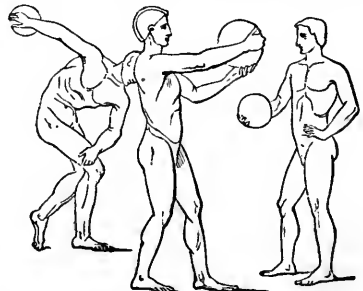

306.

lighter exercises was reckoned running (*δρόμος*), leaping (*ἄλμα*), quoiting (*δίσκος*), hurling the

javelin (ἀκόντιον). When skill had been obtained in these, and the consequent strength, then followed a severer course of discipline. This was two-fold—1, simple; 2, compound. The simple consisted of wrestling (πάλη), boxing (πυγμαχία):

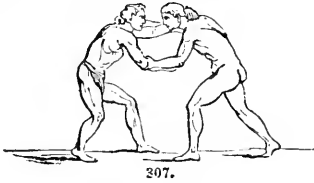

307.

the compound we find in the Pentathlon (the five contests), and the Pankration (or general trial of

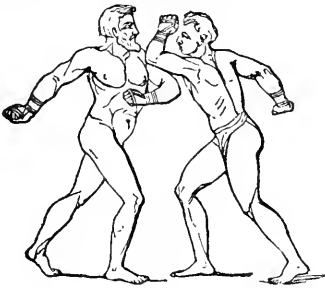

308.

strength). The Pentathlon was made up of the union of leaping, running, quoiting, wrestling, and hurling the spear; the Pankration consisted of wrestling and boxing. It is not necessary here to speak in detail of the distinctions which Galen makes between the ordinary motions of the body and those which were required in these exercises, since the names themselves are sufficient to make manifest how manifold, severe, long, and difficult the bodily discipline was, and the inference is easy and unavoidable that the effect on the bodily frame must have been of the most decided and lasting kind.

Racing may be traced back to the earliest periods of Grecian antiquity, and may be regarded as the first friendly contest in which men engaged. Accordingly the Olympic and Pythian, probably also the other games, opened with foot-races. Foot-racing, perfected by systematic practice, was divided into different kinds. If you ran merely to the end of the course (στάδιον), it was called stadium; if you went thither and back, you ran the double course



309.

(διάστος). The longest course was the δόλιχος, which required extraordinary speed and power of endurance. What it involved the ancients have

left in no small uncertainty. It is sometimes given as seven times over the stadium; at others, twelve times; at others again, twenty; and even the number of four and twenty times is mentioned. These lengths will give some idea of the severity of the trial, and serve to illustrate the meaning of the Apostle when he speaks of running with patience the race set before him (ὑπομονή, patience, sustained effort). Indeed, one Ladas, a victor at the Olympic games, in the ἐδολιχος or long race, was so exhausted by his efforts that, immediately on gaining the honour and being crowned, he yielded up his breath: a fact which also serves to throw light on Scriptural language, as showing with what intense eagerness these aspirants (δολιχοδρόμοι, long-runners) strove for perishing chaplets (φθαρτῶν στέφανον). In the preparatory discipline every thing was done which could conduce to swiftness and strength. The exercises were performed with the body naked and well oiled. Minute directions were established in order to prevent foul play (κακοτεχνία, κακούργια) of any kind, so that all the competitors might start and run on terms of entire equality—illustrating the words of Paul on the necessity of running lawfully. The contest was generally most severe; to reach the goal sooner by one foot was enough to decide the victory. How true and graphic then the descriptions given by Paul: it was, as the Apostle states, ἐν σταδίῳ, in the race-course, that the contests took place; every one striving for the victory was temperate in all things; nay more, he kept under his body and brought it into subjection. A passage is found in the *Enchiridion* of Epictetus, which shows with what propriety the terms which the Apostle employs were chosen by him: 'You wish to conquer at the Olympic games? so also do I; for it is honourable; but bethink yourself what this attempt implies, and then begin the undertaking. You must subject yourself to a determinate course; must submit to dietetic discipline (ἀναγκοτροφεῖν); must pursue the established exercises at fixed hours in heat and cold; must abstain from all delicacies in meat and drink; yield yourself unreservedly to the control of the presiding physician, and even endure flogging.'

It may well be supposed that the competitors employed all their ability, and displayed the greatest eagerness to gain the prize. The nearer, too, they approached to the goal, the more did they increase their efforts. Sometimes the victory depended on a final spring; happy he that retained power enough to leap first to the goal. The spectators, also, used every encouragement in their power, these favouring one competitor, those another:—

'Verbaque dicentem, nunc, nunc incumbere tempus,

Hippomene, propera. Nunc viribus utere totis.' All these remarks go to show how wisely Paul acted in selecting the figure, and how carefully he has preserved the imagery which belongs to it. A word employed in the Common Version, 1 Cor. ix. 27, 'Lest when I have preached to others I myself should be a castaway'—namely, *preached*, mars the figure. The original is κηρύξας—'acted the part of herard,' whose business it was to call the competitors to the contest and proclaim their victory, functions which Paul spent his life in performing.

Paul speaks in the same connection of running not as uncertainly, of fighting not as one who beateeth the air; alluding to the preludial exercises, trials of individual and of comparative strength, which took place in the course of training. These runnings and boxings had no immediate aim nor result, and implied no real competitor; hence the propriety of the terms which the sacred writer employs. Statius (*Theb.* vi. 587) has given a lively picture of some of the practices by which the runners endeavoured to give suppleness and agility to their limbs:

tunc rite citatos

Explorant, acuuntque gradus, variasque per artes
 Exstimulant docto languentia membra tumultu.
 Poplite nunc flexo sidunt, nunc lubrica forti
 Pectora collidunt plausu; nunc ignea tollunt
 Crura, brevemque fugam necopino fine repouunt.

After the herald had called the competitors into the lists, they sometimes tried their strength and exercised their frames, by running out and back on the course. Virgil (*Æn.* iv. 370) represents Dares as displaying the size and flexibility of his arms prior to his combat with Eryx:

Ostenditque humeros latos, alternaque jactat
 Brachia protendens, et verberat ictibus auras,

where, in *verberat ictibus auras*, we have even a verbal agreement with the Apostle's phraseology. (Compare *Æn.* v. 4, 46.) Among the proprieties of language for which the passage in I Cor. ix. is distinguished, may be placed the term which Paul employs to describe the prize. It is the specific word used in the case, namely *βραβεῖον*: this was the customary term, the employment of which was rendered proper from the name of the officers, *βραβεῖνται*, who gave the conqueror his crown. The entire passage indeed is singularly happy in its phraseology, thereby adding confirmation to the grounds on which the authority of the Epistle rests. We cannot, however, think one word well rendered in our English version, *ἀδόκιμος*, 'cast-away'; or, if this be a good rendering, the Apostle has at least failed in strict verbal propriety; for who were they in connection with the games who were, or were termed, castaway? *Δοκιμασία* was the term employed to describe the severe scrutiny which candidates for office underwent at Athens. Persons who were found unfit were termed *ἀδόκιμοι*, and as this verdict was a declaration of civic and social incapacity, not to say of moral turpitude, the word came to mean 'dishonoured.' This, or the word *rejected*, seems the proper rendering in the last verse of the ninth chap. of I Corinthians. The Apostle's fear evidently was, lest, after having put others on this noble undertaking, he himself should be at last found unfit to engage therein; for the allusion seems to be derived from the preparatory exercises of which he is immediately speaking, and not from the issue of the contest; and at the end of these preparatory exercises, a very severe examination had to be undergone by such as wished to 'run the race.' This interpretation may perhaps serve to set the Apostle's humility in a strong light; since he expresses his fear lest he should not be even admitted to enter the lists for 'the glorious prize.' If, however, any one prefers referring the word to the final issue of the contest of life, then the same meaning remains, and the Apostle says, that, after all his striving, he

may lose the crown, proving at last unequal to the achievement of the victory.

In writing to the Christians at Corinth there was a special propriety, on the part of the Apostle, in making allusions to the public games. Corinth was the place where one of the four Greek national games was celebrated, namely, the Isthmian. These games were so called from being held on the isthmus which joins northern with southern Greece—a spot of land most celebrated in Grecian history, alike in martial and commercial matters. No spot could well be chosen for such a purpose better than this isthmus, which lay in the very centre of Grecian civilization. In the narrowest part of this tongue of land, between Lechæum and Schœnus, stood the famous temple, sacred to the Isthmian Neptune. It was shaded by a pine grove. Here began the Isthmian games. Here also was a splendid theatre, and a race-course adorned with white marble. Other distinguished works of art adorned and hallowed the vicinity.

If we attempt to trace these games to their origin we are lost in the mists which envelope the mythical periods of the Greek national life. They were obviously connected with the worship of Neptune; the wide diffusion of which tended greatly to secure for the Isthmian games the great celebrity which they enjoyed, calling, as they did, competitors and spectators from all parts. The Persian war gave a new impulse to the Isthmian games. The Peloponnesian war, on the contrary—as being a contest of Greek against Greek—dimmed their glory, and abated their influence. Even when, at a later period, Corinth became a Roman colony, the games, so far from losing their importance, were exhibited under the Cæsars with an increased celebrity, so that Paul, in the picture which he drew, was writing to the eye of the Corinthian Christians. And, if corroboration of the credibility of the first letter were needed, we might find all we could wish in antiquities yet in existence; for a coin of Marcus Aurelius, and another of Commodus (and indeed others of a

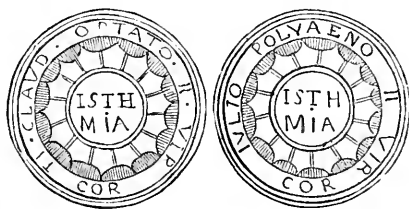

310.

later period), bear each one the inscription of *ISTH MIA*, the Isthmian Games. The Corinthians appear to have been inordinately fond of these amusements. They were held every three years. They comprised three leading divisions—musical, gymnastical, and equestrian contests. In the first the tyrant Nero carried off a crown, by destroying his too highly-gifted antagonist. The gymnastic contests were the same as those of which we have already spoken. A few words, however, may here be introduced as to the horse-racing, which has not been hitherto described. Generally the same kinds prevailed as at the Olympic and Pythian games. Chariot-races seem to have been practised in the earliest heroic times, since chariots were as

early as this used in battle, and the notices which have come down to us refer this kind of sport to the early period now indicated. It stood pre-

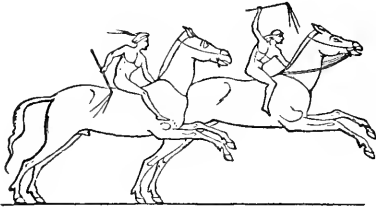

311.

eminently before other games. The skill and outlay which it required prevented any but persons of distinction—the wealthy, governors, princes, and kings—from engaging in its enjoyments. The Homeric competitors made use in their games of their two-horsed war-chariots, which they occupied each one alone, and drove themselves, though in battle it was not unusual for the reins to be entrusted to a charioteer. In the heroic ages these contests opened the games. To them belonged the highest prizes. In the Olympic games horse and chariot racing gradually branched out into different kinds. So much importance was attached to these games that historians have recorded the exact time when particular kinds were first introduced, and immortal poets sung the

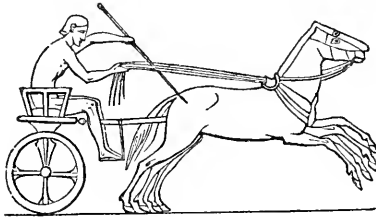

312.

praises alike of the victors and their horses. The four-horsed chariot-race (*ἀρμα τέθριππον*) took its origin in the twenty-fifth Olympiad. In the ninety-third Olympiad was held the first contest with two-horsed chariots. Foals were now made use of, as well as horses. For a time mules also were employed. Other varieties, mostly designed for a display of skill and splendour, came and went as fashion dictated. The number of chariots that might appear on the course at once cannot be accurately determined. Pindar (*Pyth. v. 46*) praises Arkesilas of Cyrene for having calmly brought off his chariot uninjured, in a contest where no fewer than forty took part. The course had to be gone over twelve times. The urgency of the drivers, the speed and exhaustion of the horses, may easily be imagined. The greatest skill was needed in turning the pillar which marked the extremity of the course, especially when the contending chariots were numerous. How to avoid the danger of collision, how to turn as near the pillar as possible, so as to save ground, were points of the greatest consequence, as Sophocles in his *Electra* intimates (West's *Trans.*).

Th' Athenian, with consummate art,
His course obliquely veered, and steering wide

With steady rein, the wild commotion pass'd
Of tumbling chariots and tumultuous steeds.

At the Olympic games the prize was simply a chaplet made of wild olive. The crowns were laid on a tripod, and placed in the middle of the course, so as to be seen of all. On the same table there were also exposed to view palm-branches, one of which was given into the hand of each conqueror at the same time with the chaplet. The victors, having been summoned by proclamation, were presented with the ensigns of victory, and conducted along the stadium, preceded by a herald, who proclaimed their honours, and announced their name, parentage, and country.

The real reward, however, was in the fame which ensued. A chaplet won in the chariot-races at Olympia was the highest of earthly honours. What congratulations from friends; how was the public eye directed to the fortunate conqueror; what honour had he conferred on his native city, and for what office was such an one unfit! What intense and deep delight must his bosom have been filled with when the full acclaim of assembled Greece fell upon his ear, coming in loud salutations and applauses from every part of the crowded course! Then came the more private attentions of individual friends. One brought a chaplet of flowers; another bound his head with ribbons. Afterwards came the triumphal sacrifice made to the twelve gods, accompanied by sumptuous feasting. The poet now began his office, gaining, in some cases, both for himself and the happy victor, an unexpected immortality. Music also lent her aid, and his name was sung wherever the noble accents of the Greek tongue asserted their supremacy. In order to perpetuate the memory of these great men, their names and achievements were entered into a public register, which was under the care of suitable officers. A no less privilege was that of having a statue of themselves placed either at the expense of their country or their friends, in the sacred grove of Jupiter. A perhaps still greater honour awaited the victor on his return home. The conquerors at the Isthmian games were wont to be received in their chariots, superbly attired, amid thronging and jubilant multitudes.

One or two other privileges belonged to these victors, such as immunity from public offices, and a certain yearly stipend. If to all this be added the strict scrutiny which competitors were obliged to undergo (in the best ages), so that none could enter the lists but such as were of pure Greek blood, and incorrupt in life, none but such as had undergone the required disciplinary training, and (in the case of the chariot and horse-races) none but those who could afford to possess and train horses in a country in which, as in Greece, horses, particularly in the earlier ages, were very scarce and dear; it will be seen that the distinction of the prize was not over-rated, when it was compared with a Roman triumph, nor that the description of Horace is too highly coloured—

palmaque nobilis
Terrarum dominos evehit ad Deos.

At the Isthmian games the prize was parsley during the mythic periods. In later ages the victor was crowned with a chaplet of pine leaves. Parsley, however, appears to have been also employed. If the conqueror had come off victorious

in the three great divisions—music, gymnastics, and racing—he was in the Pythian, as well as in the other sacred games, presented also with a palm-branch. The names of about seventy persons are preserved who gained honours at the Isthmian games, among which occurs that of the emperor Nero, who is recorded to have gained the victory in the character of harper and that of herald.

Let it not be thought that the use which especially Paul makes of the Grecian games is unbecoming the lofty subject of religion. Such an idea can be entertained by none but those who have the most superficial notions on the subject, and who possess no acquaintance with the spirit of classical antiquity. A full vindication of the propriety of these allusions would require a detailed exposition of the good which the games conferred on the Greek communities. One or two points only can be spoken of.

These games, taken in connection with the early and long training by which they were preceded, and of which they were both the natural result and reward, were a grand educational system, bearing primarily indeed in favour of the physical development, but also tending directly and powerfully to advance the highest intellectual and moral culture. The exercises through which the child, the youth, and the man were stage by stage conducted, each in succession becoming more difficult and more complex, as the bodily powers came into play and acquired vigour, were admirably adapted to give that union of strength and beauty in which physical perfection consists, and in which the Greek nations probably surpassed every other known people. But the vigour and energy which ensued imply health and hilarity; hence arise humane, kind, and generous dispositions; so that a good state of the body promoted moral soundness, and moral soundness, combined with bodily vigour, guaranteed intellectual activity and mental power. The existence of these exercises and these games in each separate state secured the development and activity of those feelings which made his own country to each one dear and venerable; while a narrow and selfish patriotism was greatly prevented, and emotions which embraced the whole Hellenic race were enkindled and fostered by those general meetings which, from time to time, called together, especially at Olympia, all who were not aliens from the Greek commonwealth, marked out by the use of that noble instrument of speech, the Greek tongue.

It is impossible not to look with admiration on the wise and careful measures which were taken in order to make the gymnasia schools of order and of moral propriety as well as of physical beauty. Aware of the importance of the training, Solon took the business under his special care, laying down minute regulations as to time, place, and extent, so that nothing might be left to chance or caprice. Then the school, in general, had its president—gymnasiarch,—and each separate department a separate head; as in the case of the torch-race, which had its lamparchy, or government, charged with the office of making, in connection with it, all necessary arrangements. There were, however, two officers whose names and functions strikingly serve to show how greatly these Grecian institutions had a favourable in-

fluence on character: the first was the *kosmetes*, whose name comes from a word (*κόσμος*) signifying order and beauty, and whose office consisted

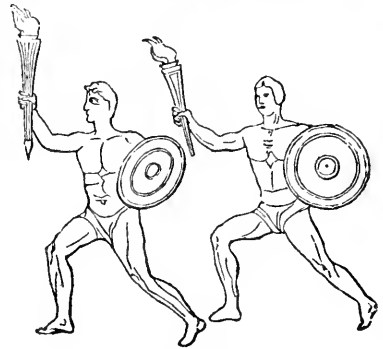

313. [Torch-race.]

in the special superintendence of every thing fitted to further these high qualities; the other officer was termed *sophronistes*; and his business was still more intimately conducive to inform the mind and give shape and pressure to the life, since, as his designation (from *σώφρων*) proves, he was required to guide the pupils to *σωφροσύνη*, a term for which we have no English equivalent, but which may perhaps be approximately rendered by 'sound-mindedness.' The elder Athenians were so solicitous to give a right direction to the influence of the gymnasium, the palaestra, and the stadium, that they annually elected ten *sophronistes* (one out of each tribe), and the honour which was attached to the office may be learnt from the fact that, in some inscriptions, their name stands before that of the *gymnasiarches* (heads of the gymnasia) themselves. The usual province of the *sophronistes* extended beyond the limits of the exercise-grounds, for they exercised over the youth a general legal oversight. Even their play-hours were under the eye of the *sophronist*. When the young men joined in the solemn procession of the grand national Panathenæa they were under the guardianship of the *sophronistes*. Were they present at the nocturnal festival held in honour of Hebe, they were still attended by and subject to their wise, experienced, and judicious *sophronist*. That something even of a sacred character belonged to these preparatory exercises appears from the fact that the *kosmetes* bore also the designation of *ιερέως* (priest), having charge of certain sacrifices.

Were there not other consideration in their favour, yet the severe examination to which candidates for admission to these contests were compelled to submit, would suffice to satisfy the reader that the tendency of the games was good, not less in a moral than a social point of view. Besides being questioned as to their condition—were they freemen or slaves?—and as to their blood—were they really Greeks?—they had also to satisfy their judges that their characters were free from all moral stain. In the public stadium the herald, laying his hand on the head of the candidate, inquired with a loud voice, 'Can any one accuse this man of any crime? Is he a robber or a slave? or wicked or depraved in his life?' If he successfully passed this ordeal the candi-

date was then conducted to the altar of Jupiter, the punisher of the perjured, where with solemn rites he was required to swear (if he could with truth and safety) that he had gone through the required preparatory course of discipline, and would abstain from every breach of the laws in the contest before him. On the subject here treated of see West's *Odes of Pindar*, 2nd edit.; Potter's *Antiquities of Greece*. By far the best work, however, is Krause's *Die Gymnastik und Agonistik der Hellenen*; and his *Die Pythien, Nemeen und Isthmien*, Leipzig, 1841.

J. R. B.

GARDEN. Several gardens are mentioned in the Scriptures, as the garden of Eden (Gen. ii. 8, 9, 10, 15), Abab's garden of herbs (1 Kings xxi. 2), the royal garden near the fortress of Zion (2 Kings xxi. 18; xxv. 4), the royal garden of the Persian kings at Susa (Esther i. 5; vii. 7, 8), the garden of Joseph of Arimathea (John xix. 41), and the garden of Gethsemane (John xviii. 1). It is clear, from Josh. v. 2, and Lam. ii. 6, that gardens were generally hedged or walled, as indeed Josephus expressly states respecting the gardens near Jerusalem (*De Bell. Jud.* v. 7). In Neh. ii. 5, and John xx. 15, gardeners and keepers of gardens by occupation are indicated.

Gardens were planted not only with fragrant and beautiful plants, but with various fruit-bearing and other trees (Gen. ii. 9; Jer. xxix. 5; Amos ix. 14). Thus we find mention of nut-gardens (Cant. vi. 14), pomegranate-gardens (Cant. iv. 13), olive-gardens (Deut. viii. 8; 1 Chron. xxvii. 28), vine-gardens (Cant. iv. 2; viii. 8). Here, however, we are not to suppose that the gardens were exclusively occupied by these fruits, but that they were severally predominant in the gardens to which they gave name. The distinction, for instance, between a vine-garden and a vineyard would be, that, in the latter, the vine was cultivated solely for use, whereas in the former it was planted for solace and ornament, to cover walls, and to be trained in arbours and on trellises.

Gardens were, when possible, planted near streams, which afforded the means of easy irrigation. This explains such passages as Gen. ii. 9, sq., and Isa. i. 30. But streams were few in Palestine, at least such as afforded water in summer, when alone water was wanted for irrigation: hence rain-water, or water from the streams which dried up in summer, was in winter stored up in reservoirs, spacious enough to contain all the water likely to be needed during the dry season. In fact many of our own large nurseries are watered in the same manner from reservoirs of rain-water. The water was distributed through the garden in numerous small rills, which traversed it in all directions, and which were supplied either by a continued stream from the reservoir, or had water poured into them by the gardeners, in the manner shown in the Egyptian monuments. These rills being turned and directed by the foot, gave rise to the phrase 'watering by the foot,' as indicative of garden irrigation (Deut. xi. 10). The following representation (No. 313) very clearly shows the way in which water was raised, by a balanced lever, from the stream or reservoir, and poured into a trough, whence it flowed into the various canals for irrigation. This method is still in use. There is a curious account of ancient garden irrigation

in Pliny (*Hist. Nat.* xix. 4), which the reader may consult with advantage.

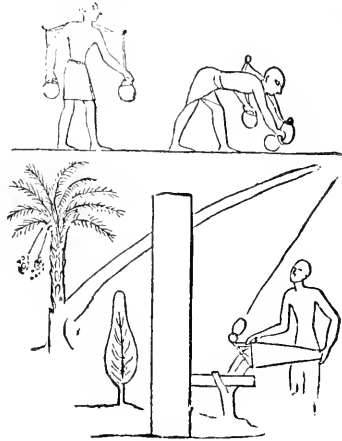

314. [Watering Garden.]

Gardens were dedicated to various uses among the Hebrews, such as we still find prevailing in the East. One most essential difference between them and our own is that they are not attached to or in any way connected with the residence, but are situated in the suburbs. We have known gardens from half a mile to a mile distant from the houses of the persons to whom they belonged. It is manifest that all the gardens mentioned in Scripture were outside the several towns. This is, however, to be understood of regular gardens, for shrubs and flowers were often planted in the open courts of the dwelling-houses.

People repair to their suburban gardens to take the air, to walk, and to refresh and solace themselves in various ways. For their use there is



315. [Garden-houses.]

mostly in each garden a kind of summer-house or pavilion, fitted up with much neatness, gaily

painted, and furnished with seats, where the visitors may sit and enjoy themselves. Here sometimes banquets were and are still given, attended by singing and music (Isa. li. 3; lxxv. 3). The custom of burying the dead in gardens is indicated in Gen. xxiii. 19, 20; 2 Kings xxi. 4; 1 Sam. xxv. 1; Mark xv. 46; and still occurs sometimes in the East, but is not very prevalent. We find it also among the Greeks (Heliiodorus, *Ethiop.* i. 2, p. 35), and the Romans (Suetonius, *Galba*, 20).

It is evident that the gardens of the Hebrews were in a very considerable degree devoted to the culture of medicinal herbs, the preparation of which in various ways was a matter of much solicitude with them (Jer. viii. 22). This is still the case in the East, where vegetable simples are as much employed in medicine as they were in this country in the times of Gerarde and Culpepper.

It would seem that the Jews were much in the habit of performing their devotions in gardens (Gen. xxiv. 63; Matt. xvi. 30; John ii. 48; xviii. 1, 2). This interesting practice, however, was idolatrously abused; for the worship of idols in these shady seclusions was not of unfrequent occurrence, and is often mentioned in Scripture (1 Kings xiv. 23; 2 Kings xvi. 4; xvii. 10; 2 Chron. xviii. 4; Isa. lxx. 3; lxxvi. 17; Jer. ii. 20; iii. 6; Ezek. xx. 25).

Such are the principal points of information concerning gardens which may be collected from Scripture, or which may be connected with the Scriptural intimations.

The Jews, in their ceremonial treatises, have frequent occasion to mention gardens, chiefly for the purpose of showing what plants or seeds might or might not be planted or sown together under the law against heterogeneous propagations (Lev. xix. 9; Deut. xxi. 9, 11). From this source some curious facts relating to the arrangements of gardens may be gleaned. The following are from the Mishmic treatise *Kilaim*, which is devoted to the general subject: 'Trees must not be grafted on trees of a different kind, nor one kind of shrub on another kind of shrub, nor yet trees on shrubs, nor shrubs on trees.' Rabbi Jehudah, however, sanctioned this last practice. 'Shrubs must not be planted in a sycamore-bush; rue must not be grafted on white cassia, because that would be a shrub on a tree; a scion of the fig-tree must not be planted among *chatzab* (supposed 'ivy'), to cool it; a vine branch must not be sunk (trained) into a melon bed, to instil its juices therein, because that is a tree on a plant; pumpkin-seed must not be set among mallow, in order that it may be preserved therein, as that is herb in herb.' 'In a garden bed that is six hands square five different kinds of seeds may be sown, namely, four kinds in the four corners of the bed, and a fifth in the centre. If the bed has a ridge (border), thirteen different kinds may be sown, three in each corner, and one in the middle of the bed.' 'All kinds of field-seeds must not be sown in a garden bed; but all kinds of herbs (garden-seed) may be sown therein.' 'A ridge (border) that had been one hand high, but is decreased in height, still remains good because it had been originally of lawful height.' This applies, of course, to the ridges by which different plants which might not lawfully mingle were separated. 'In a trench or dry kennel, one

hand deep, three different kinds of seeds may be sown, namely, one kind on each side and one kind in the middle.'

It is very evident that where such careful distinctions and rules of separation existed, great attention must have been required to the means of dividing the different plants from each other. This was effected not only by ridges and trenches, but by light fences of cane. This appears from what follows: 'A partition of canes is considered a fence, provided the space between each cane is less than three hands wide, so that a young kid cannot pass through. If there is a breach in the fence to the extent of ten amoth, it is considered as a gate (entrance). Should a greater portion of the fence be broken down, it is unlawful to sow or plant towards the breach. If there are several breaches in the fence, should the portion still standing be greater than that broken down, it is permitted; but should the portion broken down be greater than that standing, it is forbidden.' These examples are selected only as specimens of the endless modes by which the later Jews sought to carry out with minute and impossible exactness the useful regulation of the Mosaic law. For that law various reasons have been given, on which we are not required to pronounce any judgment; but it appears to us that the economical grounds which may be collected from the effects which appear to result from the interdicted practices, are quite sufficient in themselves, whether others exist or not. Thus we find enumerated among the radical defects of Hindu husbandry—the barbarous system of sowing two or three species of grain in one field.... The mode of reaping is equally defective; if two or three species of grain are sown in the same field, the Indian husbandman treads down a great part of his crop in order to collect each kind separately; indeed, so fond is he of this method of proceeding that he pursues it even when the crop is all of one kind, that he may select what he deems the ripest' (Temant's *Indian Recreations*, in *Edinb. Review*, iv. 320).

There is no reason to suppose that the gardens of the ancient Jews differed in any material respect from those which are still found in Palestine. Such difference as did exist was doubtless occasioned chiefly by the minute rules which were founded upon the law forbidding the intermixture of diverse plants and seeds. The gardens of the Holy Land have been mentioned by travellers in terms too vague and general to afford the basis of a satisfactory description. Dr. Olin seems to have paid most attention to them. Of the gardens near Shechem he says, 'Upon turning an angle in the steep gorge we found ourselves, as if by enchantment, in the midst of fruitful gardens filled with vegetables, flowers, and fruit-trees, and all in the highest perfection of luxuriance and beauty. Olives, vines, acacias, pomegranates, figs, mulberries, and several species of trees which I did not recognise, are crowded together in small enclosures, forming an impenetrable shade as well as an impenetrable thicket; and yet the capabilities of the soil seem not to be overburdened. Each separate tree and plant thrives to admiration, and seems rather to profit than suffer from the thick dark canopy of branches and foliage, which entirely excludes the sun's rays from the tangled huddle of trunks and roots. A beautiful mountain stream runs through the midst

of this forest of gardens, in a channel mostly artificial and sometimes covered; but the water often rises into small fountains, and forms several cascades" (*Travels in the East*, ii. 350). The orange and citron trees which abound in these gardens near Shechem (see Schubert, *Reise ins Morgenlande*, ii. 116) were probably those not recognised by Dr. Olin, from their not being in fruit at the time of his visit.

The mural paintings of the ancient Egyptians afford us much information respecting their gardens and processes of gardening. But the difference of climate, soil, and produce, in Egypt and Palestine, was too material to justify us in expecting much information from this source respecting the gardens of the Hebrews. As, however, some notions on this head must have been common to both countries, we subjoin the observations of Mr. Wathen on the gardens of Egypt (*Arts, &c. of Ancient Egypt*, p. 108).

"The ancient plans of gardens show that the Egyptians were not less fond than our ancestors of mathematical figures, straight walks, architectural decorations, and vegetable avenues; and that they as thoroughly entered into the idea of seclusion and safety suggested by enclosures within enclosures. It has been remarked that in some old English places there were almost as many walled compartments without, as apartments within doors; and the same may be said of Egyptian country-houses. This principle of seclusion, and an excessive love of uniform arrangement, are remarkably displayed in the plan of a large square garden given in Professor Rosellini's great work (*I Monumenti dell' Egitto*). Here—

"Grove nods at grove, each alley has a brother,
And half the platform just reflects the other."
This royal garden must have formed a most enviable retreat from "the intolerable day" of an Egyptian summer. The whole was shut in by an embattled wall. On one side a canal runs along just without the walls. In the centre of the enclosure is an oblong walled vineyard; the vines, planted in rows or avenues, are trailed above on trellis-work forming shady arched walks. The space on one side this central vineyard exactly corresponds to that on the other. In each there is a row of palms, an oblong tank with water-fowl, four flower-beds on a lawn, and an open summer-house on the margin overlooking the pool; an oblong walled compartment of trees; a second tank with water-fowl and flowers; and all along within the wall of circuit a row of trees of three kinds in regular alternations. At one end of the garden next the entrance is a building containing apparently one large room, perhaps for the royal entertainments; at the other end or back is a house of three stories, which commanded a view of the whole. This garden, with its sheltered walks, its groves and tanks of water, its seclusion and privacy, reminds us of the "fair garden" of Joacim in Babylon, with its baths, its deep shady coverts, and its "privy gate," in the apocryphal story of Susannah.

'Obelisks and pylons, with flagstaffs and streamers, seem to have been occasionally introduced as garden decorations. In the parched climate of Egypt a large supply of water is absolutely necessary for a thriving vegetation; hence tanks and canals form a chief feature in these villa scenes. With rows of palms laden with fruit on their

margin, they recall Jeremiah's poetical comparison of "the man that trusteth in the Lord" to "a tree planted by the waters, and that spreadeth out her roots by the river, and shall not see when heat cometh, but her leaf shall be green; and shall not be careful in the year of drought, neither shall cease from yielding fruit," contrasted with "the man who trusteth in man," who is "like the heath in the desert, and shall not see when good cometh, but shall inhabit the parched places in the wilderness, in a salt land and not inhabited" (Jer. xvii. 8).

GARLIC. [SHOM.]

GATE, DOOR (מִשְׁעָה; Sept. πύλη), the entrance to enclosed grounds, buildings, dwelling-houses, towns, &c. Thus we find mentioned—1. *Gates of cities*, as of Jerusalem, its sheep-gate, fish-gate, &c. (Jer. xxxvii. 13; Neh. i. 3; ii. 3; v. 3); of Sodom (Gen. xix. 1); of Gaza (Judg. xvi. 3). 2. *Gates of royal palaces* (Neh. ii. 8). 3. *Gates of the Temple*. The temple of Ezekiel had two gates, one towards the north, the other towards the east; the latter closed (Ezek. xliv. 1, 2), the other must have been open. 4. *Gates of tombs* (Matt. xxvii. 60). 5. *Gates of prisons*. In Acts xii. 10, mention is made of the iron-gate of Peter's prison (xvi. 27). Prudentius (*Perisætop. Hymn. v. 346*) speaks of gatekeepers of prisons. 6. *Gates of caverns* (1 Kings xix. 13). 7. *Gates of camps* (Exod. xxxii. 26, 27; see Hebr. xiii. 12). The camps of the Romans had generally four gates; of which the first was called *porta prætoria*, the second *decumana*, the third *principalis*, the fourth *quintana* (Rosin. *Antiq. Rom. x. 12*). The camp of the Trojans is also described as having had gates (Virgil, *Æn. ix. 724*).

We do not know of what materials the enclosures and gates of the temporary camps of the Hebrews were formed. In Egyptian monuments such enclosures are indicated by lines of upright shields, with gates apparently of wicker, defended by a strong guard.

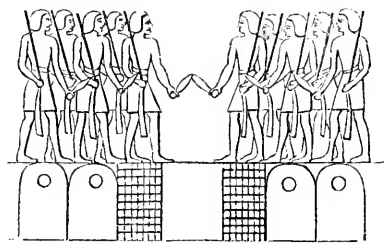

316. [Egyptian Camp-gate.]

GATES OF TOWNS.—As the gates of towns served the ancients as places of security [FORTIFICATIONS], a durable material was required for them, and accordingly we find mentioned—1. *Gates of iron and brass* (Ps. cvii. 16; Isa. xlv. 2; Acts xii. 10). It is probable that gates thus described were, in fact, only sheathed with plates of copper or iron (Faber, *Archæol. p. 297*); and it is probably in this sense we are to interpret the hundred brazen gates ascribed to the ancient Babylon. Thevenot (*Voyage, p. 283*) describes the six gates of Jerusalem as covered with iron: which is probably still the case with the four gates now open.

Other iron-covered gates are mentioned by travellers, such as some of the town gates of Algiers (*Pitt's Letter*, viii p. 10), and of the towers of the so-called iron bridge at Antioch (Pococke, vol. ii. pt. 1, p. 172). The principal gates of the great mosque at Damascus are covered with brass (Maundrell, p. 126). Gates of iron are also mentioned by Hesiod (*Theog.* 732), by Virgil (*Æn.* i. 482; vii. 609), and by Ovid (*Metam.* vii. 126).

2. *Gates of stone*, and of pearls, are mentioned in Isa. liv. 12, and Rev. xxi. 12, which, it has justly been supposed, refer to such doors, cut out of a single slab, as are occasionally discovered in ancient countries. At Esouan (Syene), in Upper Egypt, there is a granite gateway bearing the name of Alexander, the son of Alexander the Great (Wilkinson, iii. 403). The doors leading to the several chambers of the so-called 'Tombs of the Kings' near Jerusalem, were each formed of a single stone seven inches thick, sculptured so as to resemble four panels: the styles, muntins, and other parts were cut with great art, and exactly resembled those of a door made by a carpenter at the present day—the whole being completely smooth and polished, and most accurate in their proportions. The doors turned on pivots, of the same stone of which the rest of them were composed, which were inserted in corresponding sockets above and below, the lower tenon being of course short. This is one of the modes in which heavy doors of wood are now hung in the East. One of these doors was still hanging in Maundrell's time, and 'did not touch its lintel by at least three inches.' But all these doors are now thrown down and broken (Monconys, p. 308; Thevenot, p. 261; Pococke, ii. 21; Maundrell, *sub* March 28th; Wilde, ii. 299; Robinson, i. 530). Similar doors are described by Dr. Clarke (*Travels*, pt. ii. vol. i. p. 252) in the remarkable excavated sepulchres at Telmessus, on the southern coast of Asia Minor; and others were noticed by Irby and Mangles (*Travels*, p. 302) in the sepulchres near Bysan (Bethshan). There are stone doors to the houses in the Haouran beyond the Jordan (Burckhardt, p. 58); and the present writer has repeatedly seen in the north of Persia the street doors of superior houses composed of a single slab of a kind of slate. In the ancient sepulchre recently discovered, as described by Dr. Wilde (*Narrative*, ii. 343), the outer door is formed by a single slab, and moves on horizontal pivots that run into sockets cut in the pilasters at the top, in the manner of a swinging hinge.

3. *Gates of wood*. Of this kind were probably the gates of Gaza (*Judg.* xvi. 3). They had generally two valves, which, according to Faber's description (*Archæol.* p. 300), had sometimes smaller doors, or wickets, to afford a passage when the principal gate was closed—a fact which he applies to the illustration of Matt. vii. 13.

Gates were generally protected by some works against the surprises of enemies (*Jer.* xxxix. 4). Sometimes two gates were constructed one behind another, an outer and inner one; there were turrets on both sides (2 Sam. xvii. 24, 33; see Faber's *Archæol.* p. 301). The gates of the ancients were generally secured with strong heavy bolts and locks of brass or iron (*Deut.* iii. 5 · 1 Sam. xxiii. 7; 1 Kings iv. 13; 2 Chron. viii. 5; *Jer.* xlv. 2; xlix. 31; *Ps.* cxlviii. 13).

This was probably done with a view to the safety of the town, and to prevent hostile inroads (*Harmer's Observations*, vol. i. p. 188). The keys of gates, as well as of doors, were generally of wood; and Thevenot observes that gates might be opened even with the finger put into the key-hole—from which Harmer elucidates the passage in the Song of Solomon, v. 4.

The gates of towns were kept open or shut according to circumstances: in time of war they were closed against the inroads of the enemy (*Josh.* ii. 5), but they were opened when the enemy had been conquered. On festive occasions they were also thrown wide open; to which *Ps.* xxiv. 7 alludes. This opening of the gates, as well as closing them, was done by means of keys. That near the gates towers were often constructed, serving for defence against attacks of the enemy, may be inferred from *Deut.* iii. 5; 2 Sam. xviii. 21; *Judg.* ix. 35, comp. with 52. So Juvenal (*Sat.* vi. 290) puts the towers of the gates for the gates themselves. Virgil (*Æn.* vi. 550) represents the infernal gate as having a tower. Enemies, therefore, in besieging towns were most anxious to obtain possession of the gates as quickly as possible (*Deut.* xxviii. 52; *Judg.* ix. 40; 2 Sam. x. 8; xi. 33; 1 Kings viii. 37; *Job* v. 4; *Isa.* xxii. 7; xxviii. 6); and generally



317. [Gate of Konieh.]

the town was conquered when its gates were occupied by the invading troops (*Deut.* xxviii. 57; *Judg.* v. 8). This observation is made also by several Greek and Roman authors (Herodian, *Histor.* i. 12, § 14; Virgil, *Æn.* ii. 802, sq.). In or near the gates, therefore, they placed watchmen, and a sufficiently strong guard, to keep an eye on the movements of the enemy, and to defend the works in case of need (*Ju l.* xviii. 16; 2 Kings vii. 3; *Neh.* xiii. 22; see Herodian, *Histor.* iii. 2, § 21; Virgil, *Æn.* ii. 263, sq. 335).

We read that some portions of the law were to be written on the gates of towns, as well as on the doors of houses (*Deut.* vi. 9; xi. 20); and

If this is to be literally understood, it receives illustration from the practice of the Moslems in painting passages of the Koran on their public and private gates. Various artificial figures and inscriptions were engraved on their gates by the Romans (Virgil, *Georg.* iii. 26, sq.).

Criminals were punished without the gates (1 Kings xx. 13; Acts vii. 59), which explains the passage in Heb. xiii. 12. The same custom existed among the Romans (see Plaut. *Milit. Glorios.* act ii. sc. iv. 6, 7). At Rome executions took place without the Porta Metia or Esquilina. As to the gate through which Christ was led, before his crucifixion, opinions differ; some taking it to have been the dung-gate (Lamy, *Apparat. Geograph.* c. 13. § 3, p. 321); others, following Hottinger (*Cipp. Hebr.* p. 16) and Godwyn, understand it of the gate of judgment. But for all that concerns the gates of Jerusalem, we must refer to the article JERUSALEM.

Gates are often mentioned in Scripture as places at which were holden courts of justice, to administer the law and determine points in dispute: hence *judges in the gate* are spoken of (Gen. xix. 1; xxiii. 10, 18; xxxiv. 20; Deut. xvi. 18; xvii. 8; xxi. 19; xxv. 6, 7; Josh. xx. 4; Ruth iv. 1; 1 Sam. iv. 18; 2 Sam. xviii. 24; xix. 8; 1 Kings xxii. 10; Job xxix. 7; Prov. xxii. 22; xxiv. 7; Lament. v. 14; Amos v. 12; Zech. viii. 16). The reason of this custom is apparent; for the gates being places of great concourse and resort, the courts held at them were of easy access to all the people; witnesses and auditors to all transactions were easily secured (a matter of much importance in the absence or scanty use of written documents); and confidence in the integrity of the magistrate was ensured by the publicity of the proceedings. There was within the gate a particular place, where the judges sat on chairs, and this custom must be understood as referred to when we read that courts were held *under the gates*, as may be proved from 1 Kings xxii. 10; 2 Chron. xviii. 9. Apart from the holding of courts of justice, the gate served for reading the law, and for proclaiming ordinances, &c. (2 Chron. xxxii. 6; Neh. viii. 1, 3). We see from Prov. xxxi. 23; Lam. v. 14, that the inferior magistrates held a court in the gates, as well as the superior judges (Jer. xxxvi. 10); and even kings, at least occasionally, did the same (1 Kings xxii. 10 comp. with Ps. xxvii. 5). The gates at Jerusalem served the same purpose; but for the great number of its inhabitants, many places of justice were required. Thus we find that Nehemiah (iii. 32) calls a particular gate of this city the counsel-gate, or justice-gate; which seems to have had a preference, though not exclusive, since courts must have been holden in the other gates also. After the erection of the second temple, the celebrated great Sanhedrim, indeed, assembled in the so-called *conclave cesaræ* of the temple; but we find that one of the Synedria of Jerusalem, consisting of twenty-three members, assembled in the east-gate, leading to the court of Israel, the other in the gate looking to the temple mount. The same custom prevails to the present day among other Oriental nations, as in the kingdom of Morocco, where courts of justice are holden in the gate of the capital town (Döpler, *Theatrum pœnarum*, p. 9, sq.). Respecting the Abyssinians and inhabitants of Hindostan, we are likewise

assured that they employed their gates for courts of justice. Homer (*Iliad*, i. 198, sq.) states of the Trojans, that their elders assembled in the gates of the town to determine causes, and Virgil (*Æn.* i. 509, sq.) says the same. From Juvenal (*Satir.* iii. 11) it appears that with the Romans the porta Capena was used for this purpose (Gräv's *Thesaurus Antiq. Roman.* tom. x. p. 179). We may refer to J. D. Jacobi's *Dissert. de foro in portis*, Leipzig, 1714, where the custom of holding courts in the gates of towns is explained at large.

In Palestine gates were, moreover, the places where, sometimes at least, the priests delivered their sacred addresses and discourses to the people; and we find that the prophets often proclaimed their warnings and prophecies in the gates (Prov. i. 21; viii. 3; Isa. xxix. 21; Jer. xvii. 19, 20; xxvi. 10; xxxvi. 10).

Among the heathen gates were connected with sacrifices, which were offered in their immediate vicinity; in which respect the hills near the gates are mentioned (2 Kings xxiii. 8). In Acts xiv. 13, the gates of Lystra are referred to, near which sacrifice was offered; in which passage Camerarius, Dedien, and Heinsius take *πυλῶνας* to mean the town-gate.

The gate was, further, a public place of meeting and conversation, where the people assembled in large numbers to learn the news of the day, and by various talk to while away the too tedious hours (Ps. lxxix. 13). It was probably with this view that Lot sat under the gate of Sodom (Gen. xix. 1); which is more probable than the Jewish notion that he sat there as one of the judges of the city.

Under the gates they used to sell various merchandises, provisions, victuals, *e. g.* at Samaria (2 Kings vii. 1); and for this purpose there were generally recesses in the space under them (see Herodian, vii. 6. § 6). The same is stated by Aristophanes (*Equit.* 1245, ed. Dind.) of the gates of the Greeks. But with respect to the markets at gates, the present writer would note what has often occurred to his own notice in different parts of the East, which is, that the commodities sold at the gates are almost exclusively country produce, animal or vegetable, for the supply of the city, and not manufactured goods, which are invariably sold in the bazaars in the heart of the town. The gate-markets also are only held for a few hours early in the morning.

On an uproar having broken out at Jerusalem, the heads of the people met under the New-gate (Jer. xxix. 26), where they were sure to find insurgents. The town-gates were to the ancient Orientals what the coffee-houses, exchanges, markets, and courts of law, are in our large towns; and such is still the case in a great degree, although the introduction of coffee-houses has in this, and other respects, caused some alteration of Eastern manners. In capital towns the quidnuncs occasionally sat with the same views near the gate of the royal palace, where also the officers and messengers of the palace lounged about; and where persons having suits to offer, favours to beg, or wishing to recommend themselves to favourable notice, would wait day after day, in the hope of attracting the notice of the prince or great man at his entrance or coming forth (Esth. ii. 19, 21, iii. 2).

Gates are put figuratively for public places of

towns and palaces. The gates of a town are also put instead of the town itself (Gen. xii. 17; xxiv. 60; Deut. xiii. 12; Ps. lxxxvii. 2).

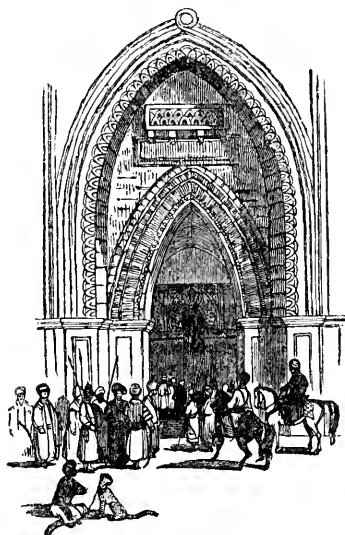

318. [Palace-Gate.]

The gates of death, and of hell, occur in Job xxxviii. 17; Ps. ix. 14; Micah ii. 13. Doors and gates of hell are chiefly introduced, Prov. v. 5; Isa. xxxviii. 10; Matt. xvi. 19; and the Jews go so far in their writings as to ascribe real gates to hell (Wagenseil, *Sota*, p. 220). Virgil (*Æn.* vi. 126) also speaks of infernal gates. The origin of this metaphorical expression is not difficult to explain; for it was very common to use the word gates as an image of large

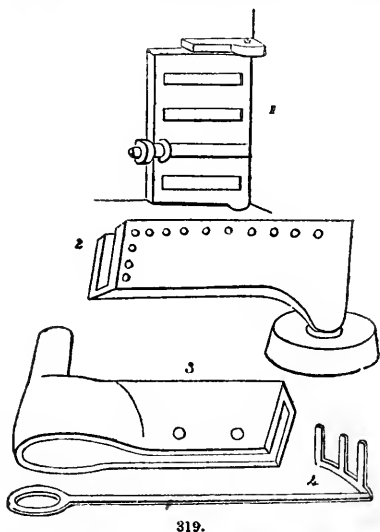

319.

empires (Ps. xxiv. 7); and in pagan authors the abode of departed souls is represented as the

residence of Pluto (see Virgil, *Æn.* vi. 417, sq.). In the passage, then, Matt. xvi. 19, by 'gates of hell' must be understood all aggressions by the infernal empire upon the Christian church.

Among the ancient Egyptians doors were frequently stained so as to imitate foreign wood. They were either of one or two valves, turning on pins of metal, and were secured within by bars and bolts. Some of the bronze pins have been discovered in the tombs of Thebes, and two of them, after Wilkinson, are figured in No. 319, figs. 2, 3. They were fastened to the wood with nails of the same metal. The stone lintels and floor behind the threshold of the tombs and temples still exhibit the holes in which the pins turned, as well as those of the bolts and bars, and the recess for receiving the opening valves. The folding-doors had bolts in the centre, sometimes above as well as below; a bar was placed across from one wall to the other; and in many cases they were secured by wooden locks passing over the centre (No. 320, fig. 4) at the junction of the two folds. 'It is difficult (remarks Sir J. G. Wilkinson) to say if these last were opened by a key, or merely slid backward and forward like a bolt; but if they were really locks, they were probably upon the

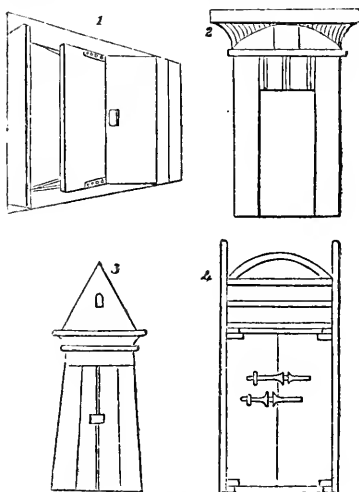

320.

principle of those now used in Egypt, which are of wood, and opened by a key furnished with several pins answering to a smaller number that fall down into the hollow movable tongue, into which the key is introduced when they open or fasten the lock.' For greater security they are also occasionally sealed with a mass of clay. This was also a custom of the ancient Egyptians, as appears from Herodotus (ii. 121); from tombs actually so closed at Thebes; and from the sculptures, as in No. 320, fig. 3, where the door is thus closed and sealed. To this custom there is an allusion in Job [CLAX]. At a later period, when iron came into general use, keys were made of that metal, of the shape shown in No. 319, fig. 4. Of the kind thus indicated were probably the lock and key which fastened the summer-parlour of King Eglon (Judg. iii. 23, 25). In this

case Elud locked the door, and took away the key; but when the servants became alarmed, they easily opened it with another key; which suggests that the lock, as in ancient Egypt or the modern East, was nothing more than a peculiarly constructed open bolt of wood, which the wooden or metal key was adapted to raise and thrust back. The forms of the Egyptian doors may be seen from the cuts. Fig. 1, No. 319, is from a curious ancient model, in the British Museum, of a small ancient Egyptian house, and may serve to show very clearly how the doors of small houses were formed, hung, and secured. The elegant cornice of the door, fig. 2, No. 320, will not escape observation; fig. 1 is a remarkable instance of a folding-door. The chief entrance to houses was through a pyramidal pylon on a projecting porch of columns, whose capitals were often ornamented with ribbons. Over the doorway was sometimes a brief hieroglyphical legend (Wathen, p. 101). This last circumstance reminds one of the writing on their doors recommended to the Israelites, as already noticed.

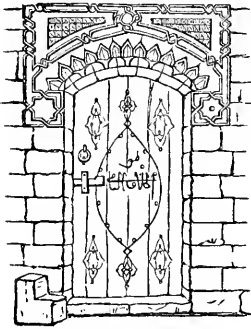

321.

A comparison of the ancient Egyptian doors with those now used in the East will probably suggest no incorrect notion of the provision among the ancient Hebrews in this respect. A sort of intermediate idea arising from this comparison will be found to furnish very satisfactory illustrations of most of the passages of Scripture which relate to the subject. The present cuts require little explanation. No. 321 is a very

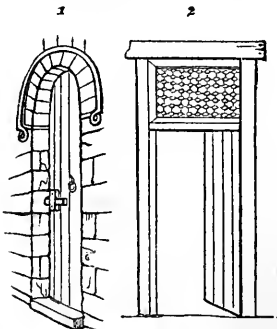

322.

usual form of the street-door of a private house. The inscription on the central compartment is

usually painted in white or black. It means, 'He (*i. e.* God) is the Creator, the Everlasting,' and brings strongly to mind the Hebrew custom to which we have more than once alluded. In No. 322 (fig. 2) is another street-door of a more simple character. Doors are generally unpainted throughout Western Asia and in Egypt. The other doors shown in the cuts belong to the internal front of the houses, and not to the external frontage or screen. Fig. 2, No. 322, has an open lattice over the door, and the elegant proportion of the whole entrance claims attention. No. 323 shows different forms of common doors,

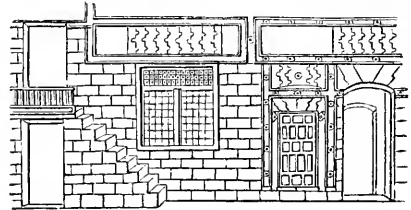

323.

and the whole piece affords an interesting illustration of the basement of an Eastern house, with the stone steps leading to the gallery, into which all the state rooms and family rooms open. In conclusion, we introduce an engraving intended to illustrate the highly-enriched doorways used in ornamental buildings, such as garden-houses, summer-houses, &c.

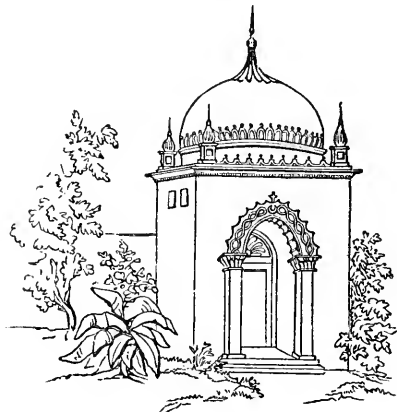

324.

In the interior of houses it is not unusual to see curtains instead of doors, especially in summer. This helps to keep the apartment cool, and also enables servants to enter without noise. This custom originated in the use of tents. Accordingly we find that all the entrances of the tabernacle had curtains, although the framework was of wood (Exod. xxvi. 31-33, 36, 37); and even in the temple a curtain or 'vail' formed the separation between the Holy and the Most Holy place.

GATH (גַּת); Sept. Γάθ; Joseph. Γίττα α Γίττη), one of the five princely cities of the Philistines, of which mention is made in Josh. xiii. 3

It was one of the cities upon which the ark is said to have brought calamity (1 Sam. v. 8, 9), and which offered in connection therewith a trespass-offering, each one a golden emerald (1 Sam. vi. 17). Goliath, of the family of giants which Joshua spared (Josh. xi. 22), of which other members may be found mentioned in Scripture (1 Chron. xxi. 5-8; 2 Sam. xxi. 19-22), has rendered Gath a word familiar from our childhood; but it is not certain whether Goliath was a native or merely a resident of Gath (1 Sam. xvii. 4). To Achish, king of Gath, David fled for fear of Saul (1 Sam. xxi. 10; xxvii. 2-7; Ps. lvi.). At his own entreaty David received from Achish the city of Ziklag. David dwelt in the country of the Philistines 'a full year and four months.' David's connection with Gath throws light on the feelings which dictated the words (2 Sam. i. 20), 'Tell it (the death of "Saul and Jonathan his son") not in Gath.' Micah also (i. 10) says, 'declare it (the wound come unto Judah, ver. 9) not at Gath.' It was conquered by David, and fortified both by him and by Rehoboam (2 Sam. viii. 1; 1 Chron. xviii. 1; 2 Chron. xi. 8). From 2 Sam. xv. 18, it appears that David had a band (600 men) of Gittites in his service at the time of the rebellion of Absalom. Their devotedness to him under Ittai their leader forms a beautiful episode in the history of David's varied fortune (2 Sam. xv. 19, sq.). Shimei's visit to Gath and its fatal consequences to himself may be read in 1 Kings ii. 39-46. In the reign of Solomon mention is made of a king of Gath (1 Kings iv. 24), who was doubtless a tributary prince, but powerful enough to cause apprehension to Solomon, as appears from the punishment he inflicted on Shimei. Under Jehoash, Hazael, king of Syria, took Gath (2 Kings xii. 17); from his successor, Benhadad, the place was recovered (2 Kings xiii. 24). It must, however, have soon revolted; for Uzziah (2 Chron. xxvi. 6), finding it necessary to war against the Philistines, 'broke down the wall of Gath.' Probably the conquest was not of long duration. This constant withstanding of the power of Jerusalem shows that Gath was a place of great resources and high eminence—a conclusion which is confirmed by the language employed by the prophets (Amos vi. 2; Micah i. 10). 'Gath,' says Jerome (*on Micah* i.), 'is one of the five Philistine cities lying near the confines of Judah, on the road from Eleutheropolis to Gaza; now it is a very large village.' On Jerem. xxv. the same authority declares that Gath was not far from Azotus. Modern travellers give no description of the place (Reland, *Palæst.* p. 785, sq.).

There was a Gath-hepher belonging to the children of Zebulun (Josh. xix. 10, sq.), the birth-place of the prophet Jonah (2 Kings xiv. 25), lying not far from Sepphoris on the road to Tiberias. Another Gath (Gath-rimmon, Josh. xix. 45) lay in the territory of Dan. It was a Levite city (Josh. xxi. 24; 1 Chron. vi. 69). In the time of Eusebius it was a very large village, 'twelve miles from Diospolis, as you go hence to Eleutheropolis' (*Onomast.*). The Gath-rimmon mentioned in Josh. xxi. 25, as being in the tribe of Manasseh, Raumer (*Palästina*) supposes to be another Levite city; but Winer (*Handwörterbuch*), with more likelihood, ascribes its origin to a mistake of the transcriber, who took the word

from the preceding verse. The Septuagint has *Baithoray*.—J. R. B.

GAULONITIS. [GOLAN.]

GAZA (גָּזָא; Sept. Γάζα; Arabic, *Ghuzzeh*) lies on the road leading from Akabah to Hebron, which passes along nearly the whole length of the great Wady-el-Arabah. It is on the sea-coast, in lat. 31° 29', long. 34° 29' (Robinson), in the country of the Philistines (Josh. xv. 47). It is a very ancient place, as we find it mentioned in Gen. x. 19, where it is given as one of the border-cities of the Canaanites. In Deut. ii. 23, it is found as the place unto which the Avims dwelt. Joshua smote the Canaanites as

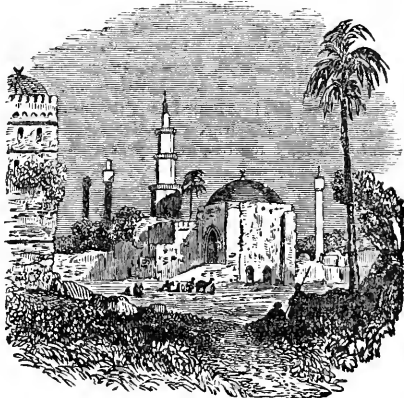

325.

far as Gaza (Josh. x. 41), but spared the Anakims (giants) that dwelt there (Josh. xi. 21, 22). In the division of the land, Gaza fell to the lot of Judah (Josh. xv. 47), and was taken by him with the coast thereof (Judg. i. 18), but its inhabitants were not exterminated (Judg. iii. 3). Gaza was one of the five Philistine cities which gave each a golden emerald as a trespass-offering to the Lord (1 Sam. vi. 17). Solomon's kingdom extended as far as Gaza (1 Kings iv. 24). But the place appears always as a Philistine city in Scripture (Judg. iii. 3; xvi. 1; 1 Sam. vi. 17; 2 Kings xviii. 8). Hezekiah smote the Philistines as far as Gaza (2 Kings xviii. 8). Gaza fell into the hands of the Egyptians, probably Pharaoh-Necho (Jer. xlvii. 1; comp. Herod. ii. 159). The prophets speak in severe terms against it (Jer. xxv. 20; xlvii. 5; Amos i. 6, 7; Zeph. ii. 4; Zech. ix. 5). After the destruction of Tyre it sustained a siege of two months against Alexander the Great (Joseph. *Antiq.* xi. 8. 4). Jonathan Maccabæus (1 Macc. xi. 61) destroyed its suburbs; Simon Maccabæus (1 Macc. xiii. 43) took the city itself, though not without extraordinary efforts. Alexander Jannæus spent a year in besieging it and punishing its inhabitants (*Antiq.* xiii. 13. 3). The place was rebuilt by Gabinius (*Antiq.* xv. 5. 3). It was among the cities given by Augustus to Herod (*Antiq.* xv. 7. 3), after whose death it was united to the province of Syria (*Antiq.* xvii. 11. 4).

Gaza is celebrated for the exploit recorded of Samson (Judg. xvi. 1-3), who 'took the doors of the gate of the city, and the two posts, and went

away with them, bar and all, and put them on his shoulders, and carried them up to the top of a hill that is before Hebron.' The Philistines afterwards took Samson, and put out his eyes, and brought him to Gaza, and bound him with fetters of brass, and he did grind in the prison-house: he, however, pulled down the temple of Dagon, god of the Philistines, and slew, together with himself, 'all the lords of the Philistines,' besides men and women (Judg. xvi. 21-30). It was near Gaza—on the road from Jerusalem to that place—that Philip baptized the eunuch 'of great authority under Candace, queen of the Ethiopians' (Acts viii. 26, sq.).

Gaza lay some distance from the sea (Arrian, ii. 26), though it had a port on the sea, called *Γάζα πρὸς θάλασσαν*, 'Gaza on the sea,' called also *Majuma* (*δ Μαϊούμας*), which Constantine called Constantia, from the name of his son, giving it, at the same time, municipal rights. Julian took away this name and ordered it to be called the port of Gaza. Subsequent emperors restored the name and the privileges of the place. It was afterwards called the sea-coast of Gaza. Further particulars may be read in Reland (*Palestina*, p. 791, sq.), where mention is made, from Pausanias, of something like a parallel to the feat of Samson; and where, as well as in Kuinoel (*in loc.*), and in Winer (*Handwörterbuch, in voc.*), explanatory circumstances may be found of the words in Acts viii. 26—'Gaza, which is desert.'—J. R. B.

GAZELLE. [ANTELOPE.]

GEBÄ (*גֶּבַע*; Sept. *Γαβαά*). It is often stated that Geba and Gibeah were names of the same place. The two names are indeed only masculine and feminine forms of the same word, signifying 'hill'; but that they were two different places is evident from Josh. xviii. 24; comp. 28; 1 Sam. xiii. 2, comp. 3; Isa. x. 29. Geba belonged to the tribe of Benjamin (Josh. xviii. 24), and was assigned to the priests (Josh. xxi. 17; 1 Chron. vii. 40). The Philistines were smitten from Geba unto Gazer by David (2 Sam. v. 25); Asa rebuilt Geba and Mizpeh with the stones of Ramah (1 Kings xv. 22; 2 Chron. xvi. 6). 'From Geba (in the north) to Beersheba' (in the south) (2 Kings xxiii. 8), expressed the whole extent of the separate kingdom of Judah, just as 'from Dan to Beersheba' expressed the whole length of Palestine. It would seem, from the manner in which Geba (*Gaba*) and Ramah are coupled in Neh. vii. 30, that they were very near each other, but the site of Geba is now unknown.

1. GEBÄ (*גֶּבַע*; Sept. *Γεβαλ*), a district, or perhaps sovereignty, south of Judæa, in the land of Edom. Gebal signifies a mountain, and apparently belongs not to the most ancient times, as it does not occur when the Israelites were actually in this quarter, but is first found in Ps. lxxxiii. 8, which was probably written in the time of Jehoshaphat. The country south of the Dead Sea, and on the east of the Ghor, or great valley, bears the same name (Jebal or Djebal) at the present day (Burckhardt, p. 401, sq.), and is doubtless the same as the Gebal of Scripture, the Gebalitis (or rather Gobolitis) of Josephus, and the Gebalene of the Romans. Josephus says, indeed, that the sons of Eliphaz, son of Esau,

settled in that part of Idumæa which was called Gebalitis, that that denominated from Amalek Amalekitis: 'For Idumæa (he adds) was the name of a large country, which in its several parts retained the names of its peculiar inhabitants' (*Antiq.* ii. 2. 1). We may therefore take Gebal as the name of the northernmost portion of Idumæa, which was nearest to Palestine.

2. GEBÄL. [GIBLITES.]

GEDALIAH (*גְּדַלְיָהּ*, *God-educated*; Sept. *Γεδολιάς*), son of Ahikam, and appointed by Nebuchadnezzar governor of Judæa after the destruction of Jerusalem. He was probably of the number of those who quitted the city at the instance of the prophet, justly despairing of the successful defence of a place which God had abandoned. Gedaliah had inherited his father's respect for Jeremiah (Jer. xl. 5, sq.), and was moreover enjoined by Nebuzardan to look to his safety and welfare. Gedaliah was in every way worthy of the difficult post he had to fill; and he adopted as the principle of his conduct that submission to existing circumstances which was requisite in one who believed that Judah had, according to the declared will of God, been justly doomed and punished for her iniquities, and who yet believed that His loving kindness had not utterly departed from her. He established the seat of his melancholy government at Mizpah in the tribe of Benjamin: and there the Jews, who had fled at the advance of the Chaldean armies, or when the troops of Zedekiah were dispersed in the plains of Jericho, quitting their retreats, began to gather around him. Gedaliah wisely counselled them to submission and quietness; and he promised on that condition to ensure them the undisturbed enjoyment of their possessions, and of the produce of the ground. In this hope the labours of the field were resumed, and the extraordinary returns of that season secured as if specially given to repair the recent injuries of war. But this calm was of short duration. Among those who returned was a member of the royal family, named Ishmael, who had taken refuge with Baalis, king of the Ammonites. He appears to have been irritated at seeing one who was not of the house of David seated upon even the shadow of David's throne; and some of the friends of Gedaliah believed him to be in a plot with Baalis to take away his life. But the noble-minded governor refused to entertain such a suspicion, and rejected with horror the proposal of an over-zealous friend, who offered to assassinate Ishmael. The suspicion which he thus generously repelled was, however, correct. He was murdered in the midst of a repast by this very Ishmael, whom he had received as a friend. This event happened about two months after the destruction of Jerusalem, and by it the present ruin of Judæa seemed to be consummated, B.C. 588 (2 Kings xxv. 22-26; Jer. xxxix. 14; xl. 5; xli. 18).

GEDER (*גְּדֵר*; Sept. *Γαδέρ*). This word signifies a *wall*, *enclosure*, or *fortified place*, and must be understood in this sense in the ensuing names. Geder itself was the name of an ancient town of the Canaanites, in the plain country of Judah (Josh. xii. 13), and was perhaps the same as Gederah.

GEDERAH (גֶּדֶרָה; Sept. Γάδρα), a city in the plain of Judah (Josh. xv. 36), probably the same with the preceding Geder, and with Bethgader of 1 Chron. ii. 51. It seems to have belonged to the family of Caleb.

GEDEROTH (גֶּדֶרֹת; Sept. Γεδρόρ), a city in the plain country of Judah (Josh. xv. 41), and one of those which the Philistines took from king Ahaz (2 Chron. xxviii. 18).

GEDOR (גֶּדוֹר; Sept. Γεδδώρ), an ancient city in the mountains of Judah (Josh. xv. 58), some of whose inhabitants joined David at Ziklag (1 Chron. xii. 7). It is doubtful whether this be the same Gedor in whose fertile valley the Simeonites found good pasture for their flocks (1 Chron. iv. 39). Dr. Robinson, travelling from Jerusalem to Gaza, came in sight of a place called Jedur, with ruins, on the brow of a mountain ridge, which he identifies with Gedor.

GEHAZI (גִּיזִי, *vision-valley*; Γιεζι), a servant of Elisha, whose entire confidence he enjoyed. His history is involved in that of his master [ELISHA]. He personally appears in reminding his master of the best mode of rewarding the kindness of the Shunamite (2 Kings iv. 14). He was present at the interview in which the Shunamite made known to the prophet that her son was dead, and was sent forward to lay Elisha's staff on the child's face, which he did without effect (2 Kings iv. 31). The most remarkable incident in his career is that which caused his ruin. When Elisha, with a noble disinterestedness, declined the rich gifts pressed upon him by the illustrious leper whom he had healed, Gehazi felt distressed that so favourable an opportunity of profiting by the gratitude of Naaman had been so wilfully thrown away. He therefore ran after the retiring chariots, and requested, in his master's name, a portion of the gifts which had before been refused, on the ground that visitors had just arrived for whom he was unable to provide. He asked a talent of silver and two dresses; and the grateful Syrian made him take two talents instead of one. Having deposited this spoil in a place of safety, he again appeared before Elisha, whose honour he had so seriously compromised. His master asked him where he had been? and on his answering, 'Thy servant went no whither,' the prophet put on the severities of a judge, and having denounced his crime, passed upon him the terrible doom, that the leprosy of which Naaman had been cured, should cleave to him and his for ever. 'And he went forth from his presence a leper as white as snow' (2 Kings v. 20-27). B.C. 894.

We afterwards find Gehazi recounting to king Joram the great deeds of Elisha, and, in the providence of God, it so happened that when he was relating the restoration to life of the Shunamite's son, the very woman with her son appeared before the king to claim her house and lands, which had been usurped while she had been absent abroad during the recent famine. Struck by the coincidence, the king immediately granted her application (2 Kings viii. 1-6).

Lepers were compelled to live apart outside the towns, and were not allowed to come too near to uninfected persons. Hence some difficulty has arisen with respect to Gehazi's interview with the king. Several answers occur. The interview

may have taken place outside the town, in a garden or garden-house; and the king may have kept Gehazi at a distance, with the usual precautions which custom dictated. Some even suppose that the incident is misplaced, and actually occurred before Gehazi was smitten with leprosy. Others hasten to the opposite conclusion, and allege the probability that the leper had then repented of his crime, and had been restored to health by his master [LEPERS].

GEHENNA. [HINNOM, VALLEY OF.]

GEMARA. [TALMUD.]

GEMARIAH (גִּמְרִיָּה, *God-perfected*; Sept. Γαμαρίας), the son of Shaphan, and a scribe of the temple in the time of Jehoiakim. Baruch read aloud the prophecies of Jeremiah to the people at the official chamber of Gemariah, which was attached to the new gate of the temple built by king Jotham (Jer. xxxvi. 10; comp. 2 Kings xv. 35). Gemariah's son Michaiah having reported this to his father, Baruch was invited to repeat the reading at the scribes' chamber in the palace, before Gemariah and other scribes and councillors, who gave an account of the matter to the king (Jer. xxxvi. 10-26). B.C. 607.

2. **GEMARIAH**, son of Hilkiah, who, with Elash, son of Shaphan, was sent to Babylon by king Zedekiah with his tribute-money for Nebuchadnezzar. He also took charge of a letter from Jeremiah to the Jewish captives at Babylon, warning them against the false prophets who deluded them by promises of a speedy return to their own land (Jer. xxix. 3, 4). B.C. 599.

GEMS. [STONES, PRECIOUS.]

GENEALOGY (from the Greek *γενεαλογία*, compounded of *γένος*, *race*, and *λόγος*, *discourse*) signifies a list of ancestors set down both in their direct and collateral order.

We read of no nation which was more careful to frame and preserve its genealogical tables than Israel. Their sacred writings contain genealogies which extend through a period of more than 3500 years, from the creation of Adam to the captivity of Judah. Indeed, we find from the books of Ezra and Nehemiah that the same carefulness in this matter was observed *after* the captivity; for in Ezra ii. 62 it is expressly stated that some who had come up from Babylon had sought their register among those that were reckoned by genealogy, but were not found; therefore were they, as polluted, removed from the priesthood. The division of the whole Hebrew nation into tribes, and the allotment to each tribe of a specified portion of the land of Canaan as an inalienable possession, rendered it indispensable that they should keep genealogical tables. God had, however, a still higher object than that of giving stability to property in Israel, in leading successive generations of His people thus to keep an accurate list of their ancestry. That they should do this was especially required from the moment that the voice of prophecy declared that the promised Messiah should be of the seed of Abraham, of the posterity of Isaac, of the sons of Jacob, of the tribe of Judah, and of the family of David.

The Rabbins affirm that after the Captivity the Jews were most careful in keeping their pedigrees (*Babyl. Gemar. Gloss. fol. xiv. 2*). Josephus

(*De Vita sua*, p. 998, D) states that he traced his own descent from the tribe of Levi by *public registers*. And he informs us that, however dispersed and depressed his nation were, they never neglected to have exact genealogical tables prepared from the authentic documents which were kept at Jerusalem; and that in all their sufferings they were particularly careful to preserve those tables, and to have them renewed from time to time. Since, however, the period of their destruction as a nation by the Romans, all their tables of descent seem to be lost, and now they are utterly unable to trace the pedigree of any one Israelite who might lay claim to be their promised, and still expected, Messiah. Hence Christians assert, with a force that no reasonable

and candid Jew can resist, that *Shiloh must have come*.

We find traces of the existence of the public tables of descent, to which Josephus refers, in the New Testament: the taxation spoken of by St. Luke ii. 2, 3, would clearly indicate this; for how could each one be able to go to his own city, unless he knew the specific tribe to which he belonged? Hence it was, we think, that St. Paul was able with confidence to appeal to the Hebrews concerning the lineage of Christ; 'for it is evident,' says he, 'that our Lord sprung out of Judah' (Heb. vii. 14; 2 Tim. ii. 8). To evince this beyond reasonable doubt, it pleased God to give us by his inspired servants, St. Matthew and St. Luke, the following genealogies:—

MATTHEW i. 2.

1 Abraham	1 Solomon	1 Jechonias, <i>i. e.</i> Jehoiachin.
2 Isaac	2 Roboam	2 Salathiel.
3 Jacob	3 Abia	3 Zorobabel.
4 Judah	4 Asa	4 Abiud.
5 Phares	5 Josaphat	5 Eliakim.
6 Esrom	6 Joram	6 Azor.
7 Aram	7 Ozias	7 Sadoc.
8 Aminadab	8 Joatham	8 Achim.
9 Naasson	9 Achaz	9 Eliud.
10 Salmon	10 Ezekias	10 Eleazar.
11 Booz	11 Manasses	11 Matthan.
12 Obed	12 Amon	12 Jacob.
13 Jesse	13 Josias	13 Joseph.
14 David	{ 14 Jechonias, <i>i. e.</i> Jehoiachin or Eliakim . . }	14 Jesus.

God.

LUKE iii. 23.

1 Adam	1 Thara	1 Eliakim	1 Joanna.
2 Seth	2 Abraham	2 Jonan	2 Juda.
3 Enos	3 Isaac	3 Joseph	3 Joseph.
4 Cainan	4 Jacob	4 Juda	4 Semei.
5 Maleleel	5 Juda	5 Simeon	5 Mattathias.
6 Jared	6 Phares	6 Levi	6 Maath.
7 Enoch	7 Esrom	7 Matthat	7 Nagge.
8 Mathusala	8 Aram	8 Jorim	8 Esli.
9 Lamech	9 Aminadab	9 Eliezer	9 Naum.
10 Noe	10 Naasson	10 Jose	10 Amos.
11 Sem	11 Salmon	11 Er	11 Mattathias.
12 Arphaxad	12 Booz	12 Elmodan	12 Joseph.
13 Cainan	13 Obed	13 Cosam	13 Janna.
14 Sala	14 Jesse	14 Addi	14 Melchi.
15 Heber	15 David	15 Melchi	15 Levi.
16 Phalec	16 Nathan	16 Neri	16 Matthat.
17 Ragau	17 Mattatha	17 Salathiel	17 Heli.
18 Saruch	18 Menan	18 Zorobabel	18 Joseph.
19 Nachor	19 Melea	19 Rhesa	19 Jesus.

We do not find that there was any objection made to these genealogies, either by Jew or Gentile, during the first century. Had any difficulty on this head existed, we may reasonably suppose that the Jews, of all others, would have been but too ready to detect and expose it. We may therefore fairly conclude that, whatever difficulty meets us now in harmonizing our Lord's pedigree as given by the two Evangelists, it could have had no place in the first age of the Christian church. In subsequent ages, however, objections were and still are made to the genealogies of Matthew and Luke. We shall now consider them, 1st, as they apply to the Evangelists *individually*; and 2ndly, as compared one with the other.

1st. It is objected that Jechonias was not the son of Josiah, but his grandson.—Answer: Matthew does not mean to say he was his son; for verses 11 and 12 are obviously intended to designate two different persons, viz. *Jehoiakim*, and his son *Jehoiachin*. That the former is the person meant in verse 11, is evident from the addition of 'his brethren.' Whose brethren? Not Jehoiachin's (or Jechonias), for he had none, but Jehoiakim's, viz. Jehoahaz and Zedekiah, the former of whom reigned before him (though a younger brother), and the latter after him (1 Chron. iii. 15, 16, 17). Admitting this, we see the consistency of the Evangelist as to the number of generations in the second and third series; whereas they who make Jechonias (verses 11, 12) to be the same person leave only

thirteen in the second series, if Jechonias be added to the third; or in the third, if he be placed to the second. If the objection had any truth, the Evangelist would be palpably inconsistent with himself! St. Jerome (*in Matthæum*, cap. i.) confirms this view:—‘If Jechonias be included in the first tessarodecade there will not be fourteen generations: we may therefore assume that the first Jechonias meant *Joakim* and the latter *Joachim*—the one spelt with the letters k and m, the other with ch and n; which letters, in the course of time, by fault of transcribers, were confounded by Greeks and Latins.’ Porphyry brought forward this objection against St. Matthew’s genealogy, and we find the same Father, in his *Comment. on Daniel*, thus replying:—‘In the Gospel of Matthew one generation seems to be wanting, for the second tessarodecade ends with Joakim, the son of Josiah, and the third begins with Joachim, the son of Joakim; Porphyry, ignorant of this, would exhibit his own skill in proving the falsity of the Evangelist St. Matthew.’

2nd. It is objected that Matthew omits three kings, viz. Ahaziah, Joash, and Amaziah (comp. 1 Chron. iii. and 2 Kings viii.), from his second series. In reference to this objection it might suffice to say that Matthew, finding fourteen generations from Abraham to David inclusively, contracted, most likely in order to assist memory and give uniformity, the second, and possibly the last series. If we compare Ezra vii. 1-5, with 1 Chron. vi. 3-13, it will be seen that Ezra, in detailing, with apparent particularity, his own lineal descent from Aaron, calls Azariah, who was high-priest at the dedication of the First Temple, the son, not of Johanan his father, but of Meraioth, his ancestor at the distance of six generations. Doubtless the desire of abridgment led him to omit those names with which there were connected no very remarkable associations. Some of the early Fathers, however, give a different solution of this difficulty. Hilary (*in Matthæum*, cap. i.) says: ‘Three generations are designedly passed over by Matthew; for Jaras is said to have begotten Ozias, when, in fact, he was the fourth from him, *i. e.* Jaras begat Ochazias from the Gentile family of Ahab, whose wife was Jezebel.’ That the omission of the three kings was a punishment inflicted upon the house of guilty Joram, to the fourth generation, is the view yet more pointedly put forth by St. Jerome also, and by many of our own best commentators.

3rd. Moreover it is said that St. Matthew terms Zorobabel the son of Salathiel, whereas in 1 Chron. iii. 19, he is called the son of *Padaiah*. How is this? We answer that the Septuagint version of 1 Chron. iii. agrees with Matthew, and that this is the manner in which Zorobabel is designated in Ezra, Nehemiah, and Haggai. Josephus also calls him the son of Salathiel. Were he not the immediate son of Salathiel, but of *Padaiah*, yet is it suitable to the language of the Jewish nation, to count the grandson the son of the grandfather. Thus Laban is called the son of Nahor (Gen. xxix. 5), as being the son of Bethuel, who was, in fact, the son of Nahor (ch. xxiv. 47). If, according to another manner of rendering ver. 17 and 18, Salathiel and Padaiah were brothers, Zorobabel might have been, by the Levirate law, the natural son of the one and the legal son of the other.

4th. It is again asked, if it be, as Matthew states, that Salmon, son of Naasson, prince of Israel, had married so remarkable a person as Rahab, how then comes it that such a circumstance is not noticed in the book of Joshua? This objection will have no force if we remember that this book, full as it is in describing the partition of Canaan among the several tribes, is yet very silent concerning the exploits, and even names, of the subordinate leaders of Israel. There is nothing therefore surprising in the circumstance that it should pass over in total silence Salmon’s marriage with Rahab. Had the matter in question been the espousal of Rahab by Joshua himself, the presumption against its truth would be very different. And indeed Kimchi, in his *Commentary on the Book of Joshua*, alludes a tradition to this effect, taken from the Babylonian Talmud. Every consideration, moreover, of a *chronological* character is in favour of the circumstance of the son of Naasson, born to him in the wilderness, being married to Rahab.

5th. But a far graver objection than that which is alleged against St. Matthew for having omitted names, is brought against St. Luke for having inserted that of *Cainan*, as son of Arphaxad—a name neither to be found in the Hebrew nor Samaritan text, nor yet in any of the Targums or versions, save the Septuagint. We may infer from the fact that neither Philo nor Josephus, who in other respects followed this version, receive this name as genuine, that it was not found in the earlier copies of the Septuagint. And it is clear, moreover, that Irenæus, Africanus, Eusebius, and Jerome, reject it as an interpolation. See on this subject Whitby’s *Preface to the Reader*, and Lightfoot’s *Harm.*; also Usher’s *Dissertation on Cainan*, and Kidder’s *Demonst. of Messiah*.

We are now to compare the Evangelists as to the points on which they agree and differ.

It does not appear that Celsus attacked the genealogies on the score of any *inconsistency* with each other. Not so the Emperor Julian; he made their discrepancies the specific ground of attack. Jerome (*in Matt. i.*) thus writes:—‘Julianus Augustus in this place attacks the Evangelists on the ground of *discrepancy*: Matthew calls Joseph the son of Jacob, whereas Luke calls him the son of Heli! Had Julian been better acquainted with the modes of speech of the Jews, he would have seen that one Evangelist gives the natural and the other the legal pedigree of Joseph.’

The first solution of the apparent discrepancies of the Evangelists (and to which this ancient father obviously here alludes) is that of Africanus, which, he informs us (Euseb. *Hist. Eccles. i. 7*), he received from the relatives of our Lord, who, because of their consanguinity to him, were called *Δεσπότες*. It is to the effect that Matthan, the third in the list from Joseph, in Matthew’s genealogy, and Melchi, the third in Luke’s list, married successively the same woman, by whom the former begat Jacob, and the latter Heli. Heli dying without issue, his maternal brother took his widow to wife, by whom he had Joseph, who, according to law (Deut. xxv. 6), was registered by Luke as the son of Heli, though naturally the son of Jacob, as Matthew records him. This is the explanation which was generally admitted by Eusebius, Nazianzen, the writer of *Ad orthodoxos*, and others, *for ages*.

Grotius, however, availing himself of the tradition that Heli and Jacob were both sons of the same mother, but of different fathers (Matthan and Melchi), supposes that *Luke* traces the natural pedigree of Christ, and Matthew the legal. This he argues on two grounds. First, that Salathiel *could not* have been the natural son of Jeconias, who was *childless*—according to the declaration of God by Jeremiah (xxii.)—and was, therefore, as Luke states, the son, properly so called, of Neri, of Nathan's line; and, secondly, that the *Levirate* law imposed no necessity on Jacob to marry Heli's widow, they being only *uterine* brothers. The learned commentator might have been led to this view by St. Ambrose, who, in his *Commentary on Luke*, says, 'Heli, fratre sine liberis decedente, copulatus est fratris uxori, et generavit filium Joseph, qui juxta legem Jacobi filius dicitur.' But both the reasons assigned by Grotius for differing from the solution of Africanus would seem to be founded on a *petitio principii*. It does not appear an ascertained fact that Salathiel was not the natural son of Jeconias, nor yet that the law which obliged a man to marry the widow of his deceased brother might be departed from when they were only *maternal* brethren; for even in cases of distant relationship the law seemed obligatory, as we see in the case of Boaz marrying Ruth, the widow of his distant kinsman. Whitby defends Africanus' account; Hammond, Le Clerc, and Wetstein, agree with Grotius.

Dr. Barrett, who, in his preliminary dissertation to a curious *fac-simile* of a most ancient MS. of St. Matthew's gospel, brings to bear upon this difficult question a large share of sound learning and correct criticism, objects to the above theory as given by Africanus and altered by Grotius, on the ground principally, that it refers entirely to the descent of Joseph from David, without attempting to prove that the son of Mary was the son of David. Dr. Barrett then states his own hypothesis, viz., that Matthew relates the genealogy of Joseph, and Luke that of Mary. He supposes a sufficient reason, that after Matthew had given his genealogical table another should be added by St. Luke, fully to prove that Christ, according to the flesh, derived his descent from David, not only by his supposed father Joseph, but also by his real mother Mary. The writers who agree in this opinion, Dr. B. divides into two classes. First, those who assert that the families of Solomon and Nathan met in Salathiel and Zorobabel, after which they separated, and were again re-united in Joseph and Mary: secondly, those who suppose that Salathiel and Zorobabel were distinct individuals, and deny that any union took place between them previously to the marriage of Joseph and Mary. He rejects this latter opinion because it seems to contradict the divine promise (2 Sam. vii. 12-16), which intimates that Christ should be *lineally* descended from David through *Solomon*. He therefore receives the former hypothesis, and supports it by numerous and profound arguments. (See his *Preliminary Dissertation to Codex Rescriptus*; see also, on both hypotheses, Lightfoot's *Harmony Ev.*; South's *Sermon on Rev. xii. 16, vol. iii.*; Wetstein, *ad Matthæum*, i. 17; Bishop Kidder's *Demonst. of Messiah*, part ii. to c. xii.; Hale's *Analysis of Chronology*, vol. iii.)

In constructing their genealogical tables, it is well known that the Jews reckoned wholly by males, rejecting, where the blood of the grandfather passed to the grandson through a daughter, the name of the daughter herself, and counting that daughter's husband for the son of the maternal grandfather (Num. xxvi. 33; xxvii. 4-7). On this principle Joseph, begotten by Jacob, marries Mary, the daughter of Heli: and in the genealogical register of his wife's family, is counted for Heli's son. Salathiel, begotten by Jeconiah, marries the daughter of Neri, and, in like manner, is accounted his son: in Zorobabel, the offspring of Salathiel and Neri's daughter, the lines of Solomon and Nathan coalesce; Joseph and Mary are of the same tribe and family; they are both descendants of David in the line of Solomon; they have in them both the blood of Nathan, David's son. Joseph deduces his descent from Abiud (Matt. i. 13), Mary from Rhesa (Luke iii. 27), sons of Zorobabel. The genealogies of Matthew and Luke are parts of one perfect whole, and each of them is essential to the explanation of the other. By Matthew's table we prove the descent of Mary, as well as Joseph, from Solomon; by Luke's we see the descent of Joseph, as well as Mary, from Nathan.

But still it is asked how know we that Mary was the daughter of Neri?

1. Because the angel Gabriel, at the Annunciation, told the Virgin that God would give her divine son the throne of his father David (Luke i. 32), and thus it was necessary to prove this by her genealogy afterwards.

2. Mary is called by the Jews בתעלי, 'the daughter of Heli;' and by the early Christian writers, 'the daughter of Joakim and Anna' (Lightfoot, *on Luke* iii. 23). But Joakim and Eliakim (as different names in Hebrew for God) are sometimes interchanged (2 Chron. xxxvi. 4): Eli or Heli then is the abridgment of Eliakim.

3. The Evangelist Luke has critically distinguished the *real* from the *legal* genealogy by a parenthetical remark: 'Ἰησοῦς ὁν (ὡς ἐνομιζέτο) υἱὸς Ἰωσήφ, τοῦ Ἁλί, 'Jesus being (as was reputed) the son of Joseph (but in reality), the son of Heli,' or his grandson by the mother's side, for so the ellipsis should be supplied. Moreover, on comparing the two tables, we find that from Abraham to David they agree with each other because they are in accordance with the genealogies of Genesis, Ruth, and 1 Chron. iii.; but from David to Joseph they are evidently distinct lines of pedigree, agreeing only in two persons, viz., Salathiel and Zorobabel.

Again, it is objected, that there are now in Luke's genealogy seventy-seven names; whereas Irenæus, Africanus, and other early fathers, acknowledge but seventy-two. But if, with them, we omit the names *Levi*, *Matthan*, and *Cainan*, as being interpolations, and also not count the first and the last, then the number will be reduced to seventy-two.

It is said that Abiud and Rhesa are called by the Evangelists the sons of Zorobabel, though in 1 Chron. iii. 19 we have no mention of them among his sons. We remark that it was a custom with the Jews to call the same person by different names, and that this custom was peculiarly prevalent about the time of the captivity

(Dan. i. 6, 7; also compare 2 Sam. iii. 3 with 1 Chron. iii. 1).

Lastly, it is inquired, whence the Evangelists had their genealogies from Zorobabel to Christ, there being nothing of them to be found in Scripture. We answer, from those authentic public tables kept by the Jews, of which, as before noticed, Josephus speaks; and regarding which also Eusebius (*Hist. Eccles.* i. 1) says, 'Omnes Hebræorum generationes descriptæ in Archivis Templi secretioribus habebantur.' It was doubtless from this source that they had the above named parts of our Lord's legal and natural pedigree; for, otherwise, they would have exposed themselves to the cavils of the Jews; nor could the Apostles have appealed, as they did, with confidence, to Christ's pedigree, as answering all the requirements of prophecy.

In addition to the works already referred to on this subject, the reader will do well to consult a learned essay by the Rev. W. H. Mill, D.D., being the Christian Advocate's publication for 1842.—J. W. D.

GENERATION. Considerable obscurity attends the use of this word in the English Version, which arises from the translators having merged the various meanings of the same original word, and even of several different words, in one common term, 'generation.' The remark is too just that, in the literal translations of the Scriptures, the word 'generation' generally occurs wherever the Latin has *generatio*, and the Greek *γενεά* or *γένεσις* (Rees's *Ency.* art. 'Generation'). The following instances seem to require the original words to be understood in some or other of their derivative senses—Gen. ii. 4, 'These are the generations' (תולדות); Sept. ἡ βίβλος γενέσεως; Vulg. *generationes*), rather 'origin,' 'history,' &c. The same Greek words, Matt. i. 1, are rendered 'genealogy,' &c. by recent translators: Campbell has 'lineage.' Gen. v. 1, 'The book of the generations' (ספר תולדת); Sept. as before; Vulg. *liber generationis*) is properly a *family register*, a history of Adam. The same words, Gen. xxxvii. 2, mean a history of Jacob and his descendants; so also Gen. vi. 9, x. 1, and elsewhere. Gen. vii. 1, 'In this generation' (בדור הזה); Sept. ἐν τῇ γενεᾷ ταύτῃ, Vulg. *in generatione hac*) is evidently 'in this age.' Gen. xv. 6, 'In the fourth generation' (דור); Sept. *γενεά*; Vulg. *generatio*) is an instance of the word in the sense of a *certain assigned period*. Ps. xlix. 19, 'The generation of his fathers' (דור אבותיו); Sept. *γενεᾶς πατέρων αὐτοῦ* Gesenius renders 'the dwelling of his fathers,' i. e. the grave, and adduces Isa. xxxviii. 12. Ps. lxxiii. 15, 'The generation of thy children' (דור בניך); Sept. *γενεᾶ τῶν υἱῶν σου*) is 'class,' 'order,' 'description;' as in Prov. xxx. 11, 12, 13, 14. Isa. liii. 8, 'Who shall declare his generation?' (דורו); Sept. *τὴν γενεὰν αὐτοῦ τίς διηγήσεται*; Vulg. *generatio*) Lowth renders 'manner of life,' in translation and note, but adduces no precedent. Some consider it equivalent to *ורע*, ver. 10: *γενεά* (Sept.) answers to *ורע*, Esther ix. 28. Josephus uses πολλήν *γενεάν*, *Antiq.* i. 10. 3 (Hengstenberg, *Christology of the Old Testament*, vol. i. Washington, 1836-9; Pauli, *Analect. Hebraic.* p. 162, Oxford, 1839). Michaelis renders 'Where was the providence that cared for his life?' Gesenius and Rosenmüller, 'Who of his

contemporaries reflected?' Seiler, 'Who can describe his length of life?' In the New Testament, Matt. i. 17, *γενεαί* is a series of persons, a succession from the same stock; so used by Josephus (*Antiq.* i. 7. 2); Philo (*Vit. Mos.* vol. i. p. 603); Matt. iii. 7, *γεννήματα ἐχιδνῶν*, is well rendered by Doddridge and others 'brood of vipers.' Matt. xxiv. 34, ἡ *γενεά* αὐτῆ means the generation or persons then living *contemporary with Christ* (see Macknight's *Harmony* for an illustration of this sense). Luke xvi. 8, *εἰς τὴν γενεὰν τὴν ἑαυτῶν*, 'in their generations,' &c., wiser in regard to their dealings with the men of their generation. Rosenmüller gives, *inter se*, 1 Pet. ii. 8, *γένος ἐκλεκτῶν*, is a 'chosen people,' quoted from Sept. Vers. of Isa. xliiii. 20. The ancient Greeks, and, if we may credit Herodotus and Diodorus Siculus, the Egyptians also, assigned a *certain period* to a generation. The Greeks reckoned three generations for every hundred years, i. e. 33½ years to each. Herod. ii. 142, *γενεαί τρεῖς ἀνδρῶν ἑκατὸν ἑτέα ἐστί*, 'three generations of men make one hundred years.' This is nearly the present computation. To the same effect Clem. Alexandrinus speaks (*Strom.* i. 2); so also Phavorinus, who, citing the age of Nestor from Homer (*Il.* i. 250), τῷ δ' ἦδη δύο μὲν *γενεαί*, 'two generations,' says, it means that *ὑπερέβη τὰ ἐξήκοιτα ἔτη*, 'he was above sixty years old.' The Greeks, however, assigned different periods to a *γενεά* at different times (Perizonius, *Orig. Ægypt.* p. 175, sq.; Jenson's, *Fercul. Literar.* p. 6). The ancient Hebrews also reckoned by the generation, and assigned different spaces of time to it at different periods of their history. In the time of Abraham it was one hundred years (comp. Gen. xv. 16, 'in the fourth generation they shall come hither'). This is explained in verse 13, and in Exod. xii. 40, to be four hundred years. Caleb was *fourth* in descent from Judah, and Moses and Aaron were *fourth* from Levi. In Deut. i. 35 ii. 14, Moses uses the term for thirty-eight years. In later times (Baruch vi., in the Epistle of Jeremiah, ver. 2) *γενεά* clearly means ten years. In Matt. i. 17, *γενεά* means a single descent from father to son [GENEALOGY]. Homer uses the word in the same sense (*Il.* i. 250); also Herodotus (i. 3).—J. F. D.

GENESIS (Sept. *Γενεσις*), the first book of the Pentateuch, is, in Hebrew, called בְּרֵאשִׁית, from the word with which it begins. This venerable monument, with which the sacred literature of the Hebrews commences, and which forms its real basis, is divided into two main parts; one universal, and one special. The most ancient history of the whole human race is contained in chapters i.-xi., and the history of Israel's ancestors, the patriarchs, in chapters xii.-l. These two parts are, however, so intimately connected with each other that it would be erroneous to ascribe to the first merely the aim of furnishing a universal history. The chief aim which pervades the whole is to show how the theocratic institution subsequently founded by Moses was rendered possible and necessary. The book, therefore, takes its starting-point from the original unity of the human race, and their original relation to God, and proceeds thence to the interruption of that relation by the appearance of sin, which gradually and progressively wrought an external and internal division in the human race for

want of the principles of divine life which originally dwelt in man in general, but which had subsequently been preserved only among a small and separate race—a race which in progress of time became more and more isolated from all the other tribes of the earth, and enjoyed for a series of generations the special care, blessing, and guidance of the Lord. The Mosaic theocracy appears, therefore, by the general tenor of Genesis, partly as a restoration of the original relation to God, of the communion of man with God, and partly as an institution which had been preparing by God himself through a long series of manifestations of his power, justice, and love. Genesis thus furnishes us with the primary view and notion of the whole of the theocracy, and may therefore be considered as the historical foundation without which the subsequent history of the covenant people would be incomplete and unintelligible.

The *unity* and *composition* of the work, which is a point in dispute among the critics in regard to all the books of the Pentateuch, have been particularly questioned in the case of Genesis. The question was raised whether the sources from which the writer of Genesis drew his information were written documents or oral tradition. Writers as early as Vitringa (*Obs. Sac.* i. 4), Richard Simon, Clericus, and others, though they were of opinion that Genesis is founded on written sources, did not undertake to describe the nature and quality of those sources. Another opinion, advanced by Otmar, in Henke's *Magaz.* ii., that Egyptian pyramids and other monuments of a similar nature were the sources of Genesis, was but transient in the critical world; while the attempt of some critics not only to renew the previous assumption that Genesis is founded on written sources, but also to determine more closely the character of those sources, has gained more lasting approval among the learned. Why different names of God are prevalent in different portions of Genesis is a question much discussed by early theologians and rabbis. Astruc, a Belgian physician, in his *Conjectures sur les Mémoires originiaux*, &c., Bruxelles, 1753-8, was the first to apply the two Hebrew names of God, *Jehovah* and *Elohim*, to the subject at issue. Astruc's demonstration had many feeble points. He assumed that there had originally existed a number of isolated documents, which had subsequently, by the fault of transcribers, been joined and strung together in the present form of Genesis. Eichhorn's critical genius procured for this hypothesis a favourable reception almost throughout the whole of Germany. Eichhorn pruned away its excrescences, and confined his own view to the assumption of only two different documents, respectively characterized by the two names of *Jehovah* and *Elohim*. Other critics, such as Ilgen (*Urkunden des Jerusalem Tempel-Archivs*, 1798), Gramberg (*Adumbratio libri Geneseos secundum fontes*, 1828), and others, went still farther, and pre-supposed three different documents in Genesis. Vater went much beyond Eichhorn. He fancied himself to be able to combat the authenticity of the Pentateuch by producing a new hypothesis. He substituted for Eichhorn's 'document-hypothesis' his own 'fragment-hypothesis,' which obtained great authority, especially on account of its being

adopted by De Wette. According to this opinion Genesis, as well as the greater part of the Pentateuch, consists of a great number of very small detached fragments, internally unconnected with each other, but transcribed *seriatim*, although originating in very different times and from different authors. This 'fragment-hypothesis' has now been almost generally given up. Even its zealous defenders, not excepting De Wette himself, have relinquished it. In its place the former 'document-hypothesis' has been resumed by some critics, simplified however, and supported by new and better arguments. There is at present a great variety of opinion among divines concerning this hypothesis. The leading features of this diversity may be comprised in the following summary. According to the view of Stähelin, De Wette, Ewald, Von Bohlen, Tuch, and others, Genesis is founded on two principal original documents. That of *Elohim* is closely connected in its parts, and forms a whole, while that of *Jehovah* is a mere complementary document, supplying details at those points where the former is abrupt and deficient, &c. These two documents are said to have been subsequently combined by the hand of an editor, so ably as often to render their separation difficult, if not altogether impossible. But Ranke, Hengstenberg, Drechsler, Hävernick, and others, maintain that Genesis is a book closely connected in all its parts, and composed by only one author, while the use of the two different names of God is not owing to two different sources on which Genesis is founded, but solely to the different significations of these two names. The use of each of the two names, *Jehovah* and *Elohim*, is everywhere in Genesis adapted to the sense of the passages in which the writer has purposely inserted the one name or the other. This point of view is the more to be considered, as it is the peculiar object of the author to point out in Genesis the gradual and progressive development of the divine revelations. The opponents have in vain attempted to discover in Genesis a few contradictions indicative of different documents in it; their very admission, that a fixed plan and able compilation visibly pervade the whole of the book, is in itself a refutation of such supposed contradictions, since it is hardly to be conceived, that an editor or compiler who has shown so much skill and anxiety to give unity to the book should have cared so little about the removal of those contradictions. The whole of Genesis is pervaded by such a freedom in the selection and treatment of the existing traditions, such an absence of all trace of any previous source or documents which might in some measure have confined the writer within certain limits of views and expressions, as to render it quite impracticable to separate and fix upon them specifically, even if there were portions in Genesis drawn from earlier written documents.

That first question concerning the unity of the book is closely connected with another question, respecting its authenticity, or whether Moses was the author of Genesis. We confine ourselves here to only a few remarks on the authenticity of Genesis in particular, and refer the reader for further information to the article *PENTATEUCH*. Some critics have attempted to ascertain the period when Genesis was composed, from a few passages

in it, which they say must be *anachronisms*, if Moses was really the author of the book (v. ex. gr. Tuch, *Commentar über Genesis*, p. lxxxv. sq.). Among such passages are, in particular, Gen. xii. 6; xiii. 7; 'And the Canaanite was then in the land.' This remark, they say, could only have been made by a writer who lived in Palestine after the extirpation of the Canaanites. But the sense of the passage is not that the Canaanites had not as yet been extirpated, but merely that Abraham, on his arrival in Canaan, had already found there the Canaanites. This notice was necessary, since the author subsequently describes the intercourse between Abraham and the Canaanites, the lords of the country. According to the explanation given to the passage by the opponents, such an observation would be quite a superfluous triviality. Also the name *Hebron* (Gen. xiii. 18; xxiii. 2), they say, was not introduced till after the time of Moses (Josh. xiv. 15; xv. 13). This, however, does not prove anything, since *Hebron* was the original Hebrew name for the place, which was subsequently changed into *Arba* (by a man of that name), but was restored by the Israelites on their entrance into Canaan. The opponents also maintain that the name of the place Dan (Gen. xiv. 14) was given only in the post-Mosaic period (Josh. xix. 47; Judg. xviii. 29). But the two last passages speak of quite a different place. There were two places called *Dan*; *Dan-Jaan* (2 Sam. xxiv. 6), and *Dan-Laish*, or *Leshem*. In Genesis, they further add, frequently occurs the name *Bethel* (xii. 8; xxviii. 19; xxxv. 15); while even in the time of Joshua, the place was as yet called *Luz* (Josh. xviii. 13). But the name *Bethel* was not first given to the place by the Israelites in the time of Joshua, there being no occasion for it, since Bethel was the old patriarchal name, which the Israelites restored in the place of *Luz*, a name given by the Canaanites. Another passage in Genesis (xxxvi. 31), 'Before there reigned any king over the children of Israel,' is likewise supposed to have been written at a period when the Jews had already a king over them. But the broachers of these objections forget that this passage refers to those promises contained in the Pentateuch in general, and in Genesis in particular (comp. Gen. xxxv. 11), that there should hereafter be kings among the Israelites as an independent nation. In comparing Israel with Edom (Gen. xxxvi.), the sacred writer cannot refrain from observing that Edom, though left without divine promises of possessing kings, nevertheless possessed them, and obtained the glory of an independent kingdom, long before Israel could think of such an independence; and a little attention to the sense of the passage will show how admirably the observation suits a writer in the Mosaic period. The passage (Gen. xv. 18) where the land of Israel is described as extending from the river of Egypt (the Nile) to the great river (Euphrates), it is alleged, could only have been penned during the splendid period of the Jews, the times of David and Solomon. *Literally* taken, however, the remark is inapplicable to any period, since the kingdom of the Jews at no period of their history extended so far. That promise must, therefore, be taken in a rhetorical sense, describing the central point of the proper country as situated between the two rivers.

The *historical* character of the contents of Genesis forms a more comprehensive subject of theological discussion. It is obvious that the opinions regarding it must be principally influenced by the dogmatical views and principles of the respective critics themselves. Hence the great variety of opinion that still prevails on that subject. Some, such as Vatke, Von Bohlen, and others, assert the whole contents of Genesis to be unhistorical. Tuch and others consider Genesis to be interwoven with mythical elements, but think that the rich historical elements, especially in the account of the patriarchs, can be clearly discerned. Some again limit the mythological part to the first two chapters only; while others perceive in the whole book a consistent and truly historical impress. The field of controversy is here so extensive, and the arguments on both sides are so numerous, that we must content ourselves in this article with a very few remarks on the subject. *Genesis* is a book consisting of two contrasting parts: the first part introduces us into the greatest problems of the human mind, such as the Creation and the fall of man; and the second, into the quiet solitude of a small defined circle of families. In the former, the most sublime and wonderful events are described with childlike simplicity; while, in the latter, on the contrary, the most simple and common occurrences are interwoven with the sublimest thoughts and reflections, rendering the small family circle a whole world in history, and the principal actors in it prototypes for a whole nation, and for all times. The contents in general are strictly religious. Not the least trace of mythology appears in it. Consequently there are no mythical statements, because whatever is mythical belongs to mythology, and Genesis plainly shows how very far remote the Hebrew mode of thinking was from mythical poetry, which might have found ample opportunity of being brought into play when the writer began to sketch the early times of the Creation. It is true that the narrations are fraught with wonders. But primeval wonders, the marvellous deeds of God, are the very subject of Genesis. None of these wonders, however, bear a fantastical impress, and there is no useless prodigality of them. They are all penetrated and connected by one common leading idea, and are all related to the counsel of God for the salvation of man. This principle sheds its lustrous beams through the whole of Genesis; therefore the wonders therein related are as little to be ascribed to the invention and imagination of man as the whole plan of God for human salvation. The foundation of the divine theoretical institution throws a strong light upon the early patriarchal times; the reality of the one proves the reality of the other, as described in Genesis.

The separate accounts in Genesis also manifest great internal evidence of truth if we closely examine them. They bear on their front the most beautiful impress of truth. The *cosmogony* in Genesis stands unequalled among all others known in the ancient world. No mythology, no ancient philosophy, has ever come up to the idea of a *creation out of nothing*. All the ancient systems end in Pantheism, Materialism, emanation-theory, &c. But the Biblical *cosmogony* occupies a place of its own, and there-

fore must not be ranked among, or confounded with, any of the ancient systems of mythology or philosophy. The mythological and philosophical cosmogonies may have been derived from the Biblical, as being later deprivations and misrepresentations of Biblical truth; but the contents of Genesis cannot, *vice versâ*, have been derived from mythology or philosophy. Moreover, only with the Biblical fundamental idea of the relation of God to his creatures, consequently only with the doctrine of creation out of nothing, is it possible to furnish an historical representation of creation. Every system deviating from this contains an internal contradiction against history, because it necessarily substitutes the idea of eternity for that of time; and consequently does not admit of any history, but only of either mythology or abstract reflection. The historical delineation also of the Creation and of the fall of man does not bear the least national interest or colouring, but is of a truly universal nature, while every mythus bears the stamp of the national features of the nation and country where it originated and found development. All mythi are subject to continual development and variations, but among the Hebrews the accounts in Genesis stand firm and immutable for all times, without the least thing being added or altered in them for the purpose of further development, even by the New Testament. What a solid guarantee must there be in this foundation of all subsequent revelations, since it has been admitted and maintained by all generations with such immovable firmness! The ancient heathen traditions coincide in many points with the Biblical accounts, and serve to illustrate and confirm them. This is especially the case in the ancient traditions concerning the Deluge (Gen. vi. 9), and in the list of nations in the tenth chapter; for instance (Gen. x. 4), Tarshish is called the son of Javan. This indicates that the ancient inhabitants of Tarshish or Tartessus in Spain were erroneously considered to be a Phœnician colony like those of other towns in its neighbourhood, and that they sprang from Javan, that is, Greece. That they were of Greek origin is clear from the account of Herodotus (i. 163). Also (ver. 8), Nimrod, the ruler of Babel, is called the son of *Cush*, which is in remarkable unison with the mythological tales concerning *Bel* and his Egyptian descent (comp. Diodor. Sic. i. 28, 81; Pausan. iv. 23, 5). *Sidon* alone is mentioned (ver. 15), but not *Tyrus* (comp. xlix. 13), which arose only in the time of Joshua (Josh. xix. 29); and that *Sidon* was an older town than *Tyrus*, by which it was afterwards eclipsed, is certified by a number of ancient reports (comp. Hengstenberg, *De Rebus Tyriorum*, pp. 6, 7).

With the patriarchal history (xii. sqq.) begins an historical sketch of a peculiar character. The circumstantial details in it allow us to examine more closely the historical character of these accounts. The numerous descriptions of the mode of life in those days furnish us with a very vivid picture. We meet everywhere a sublime simplicity quite worthy of patriarchal life, and never to be found again in later history. One cannot suppose that it would have been possible in a later period, estranged from ancient simplicity, to invent such a picture.

The authenticity of the patriarchal history

could be attacked only by analogy, the true historical test of negative criticism; but the patriarchal history has no analogy; while a great historical fact, the Mosaic theocracy itself, might here be adduced in favour of the truth of Genesis. The theocracy stands without analogy in the history of the human race, and is, nevertheless, true above all historical doubt. But this theocracy cannot have entered into history without preparatory events. The facts which led to the introduction of the theocracy are contained in the accounts of Genesis. Moreover, this preparation of the theocracy could not consist in the ordinary providential guidance. The race of patriarchs advances to a marvellous destination: the road also leading to this destination must be peculiar and extraordinary. The opponents of Genesis forget that the marvellous events of patriarchal history which offend them most, partake of that character of the whole, by which alone this history becomes commensurate and possible.

There are also many separate vestiges warranting the antiquity of these traditions, and proving that they were neither invented nor adorned; for instance, Jacob, the progenitor of the Israelites, is introduced not as the firstborn, which, if an unhistorical and merely external exaltation of that name had been the aim of the author, would have been more for this purpose.

Neither the blemishes in the history of Abraham, nor the gross sins of the sons of Jacob, among whom even Levi, the progenitor of the sacerdotal race, forms no exception, are concealed.

The same author, whose moral principles are so much blamed by the opponents of Genesis, on account of the description given of the life of Jacob, produces, in the history of Abraham, a picture of moral greatness which could have originated only in facts.

The faithfulness of the author manifests itself also especially in the description of the expedition of the kings from Upper to Western Asia; in his statements concerning the person of Melchizedek (Gen. xiv.); in the circumstantial details given of the incidents occurring at the purchase of the hereditary burial-place (ch. xxiii.); in the genealogies of Arabian tribes (ch. xxv.); in the genealogy of Edom (ch. xxxvi.); and in many remarkable details which are interwoven with the general accounts. In the history of Joseph the patriarchal history comes into contact with Egypt; and here the accounts given by ancient classical writers, as well as the monuments of Egypt, frequently furnish some splendid confirmations. For instance, the account given (xlvi. 13-26) of the manner in which the Pharaohs became proprietors of all the lands, with the exception of those belonging to the priests, is confirmed by Herodotus (ii. 109), and by Diodorus Siculus (i. 73). The manner of embalming described in Gen. l. entirely agrees with the description of Herodotus, ii. 84, &c. For other data of a similar kind, compare Hengstenberg (*Die Bücher Moses und Aegypten*, p. 21, sq.).

For the important commentaries and writings on Genesis, see the article PENTATEUCH.

GENNESARETH. [CINNERETH.]

GENNESARETH, LAKE OF. [SEA.]

GENTILES (Gentiles; Sept. ἔθνοι), a word which, both in the Hebrew *Goyim*, and in the Anglo-Latin 'Gentile,' by which we translate it, means literally, 'the nations.' It was applied by the Hebrews to all individuals or communities not under the law—that is, all the nations of the world excepting the Jews. But in later times some small states, and many individuals, embraced the law; and they were distinguished from the Gentiles, as well as from the Jews, by the name of PROSELYTES (*προσῆλυτοι*). In some places our authorized version has the word 'Gentiles' where the original has Ἕλληνες, which is usually and properly rendered 'Greeks.'

GEOGRAPHY, considered as a systematic description of the earth, took its rise at a much later period than other sciences, probably because it is of less essential necessity to man; yet the elements of the knowledge out of which scientific geography is constructed must have existed as soon as men turned their attention to the earth on which they dwelt, and found it necessary to journey from one part of its surface to another.

Like most other sciences, geography owes its elementary cultivation as a science to the Hellenic race, who, from the mythic period of their history down to the destruction of the Western empire (A.D. 476), continued to prosecute the study with more or less system, and to more or less definite results; yet it must be added that it is only in a qualified sense that the ancients may be said to have known or advanced scientific geography.

It is the Hebrews who present us with the earliest written information of a geographical kind. In the account of creation mention is made of a spot called Eden, out of which a river, after watering Paradise, ran, and 'from thence it was parted, and became into four heads' (fountains), which sent forth as many rivers, Pison, Gihon, Hiddekel, Phrat or Euphrates. Of these the last is the only stream that is identified. Josephus, on this point, says (*Antiq.* i. 2), 'The garden was watered by one river which ran round about the whole earth and was parted into four parts.' Pison he identifies with the Ganges, Gihon with the Nile, Hiddekel with the Tigris, and the Phrat with the Euphrates. The idea here presented is that of a vast circular plain (the earth), with water, a river, or the sea (*ὠκεανός* in Homer, *Il.* xxi. 196) encircling it, from which encircling body of water ran the said four rivers. Such, whether derived from the Hebrew Scriptures or not, was the earliest conception entertained of the earth. Any attempt to reconcile such a view with geographical facts must be futile. That some such idea was entertained among the Hebrews, even at a later period, appears from the words found in Ps. xxiv. 2, 'He hath founded it (the earth) upon the seas, and established it upon the floods' (see also Prov. viii. 27); though Job xxvi. 7, 'He stretcheth out the north over the empty place, and hangeth the earth upon nothing' (comp. Job xxxviii. 4, 6), would seem to intimate that the writer of that book entertained superior notions on the point. That, however, the general idea was that the earth formed an immense disk ('the circle of the earth'), above which were the substantial and firmly fixed heavens, the abode of God, while the earth beneath was his footstool, appears from the general phraseology employed in the sacred books,

and may be found specially exhibited or implied in the following passages:—Isa. xl. 21, sq.; Job xxxvii. 18; Ps. cii. 25. Of this wide circular expanse Jerusalem was considered the centre. Ezek. v. 5: 'I have set Jerusalem in the midst of the nations and countries that are round about her.' See the ensuing verses. The highlands of Armenia would appear to have been the first known to the human family. Descending from these some may have gone eastward, others westward. The latter alone are spoken of in Scripture. Coming south and west the progenitors of the world first became acquainted with the countries lying between the Euphrates and the Tigris, roughly termed Mesopotamia, whence they advanced still more south and west into Aram or Syria, Arabia, Canaan, and Egypt. These are the chief countries with which the ancient Hebrews seem to have possessed an acquaintance: yet if the national genealogical table found in Gen. x. is to be referred to the early period which its position in the Bible gives it, it would appear that the geographical knowledge of the Hebrews was, even before the flood, far more extensive, embracing even 'the isles of the Gentiles.' Winer (*Handwörterb.*, note to art. 'Erde'), however, with others, denies its historical value, and certainly other parts of Scripture by no means warrant us in ascribing to the Hebrews, before the Babylonish captivity, a wider range of knowledge than we have indicated above. This national calamity had the effect of enlarging the circle of their knowledge of the earth, or at least of making their knowledge of Assyria, Media, and Babylonia more minute and definite. It was to their neighbours the Phœnicians that the Israelites owed most of their geographical knowledge. This commercial people must have early acquired a superficial acquaintance with remote regions, while engaged in their maritime commercial expeditions. The knowledge they brought back to Palestine would spread beyond their own borders and reach the Hebrews, though they may not have been given to inquiry and study on subjects of the kind; nor is it safe to attempt to define at how early a period some rough notions of the isles of the Gentiles may, by means of the Phœnician navigators, have been spread about in the East. According to Clemens Alexandrinus (*Strom.* vi. 4. 36), the Egyptians had in circulation writings on geography. Their king Sesostrius may have had maps (*Schol. ad Apoll. Rhod.* iv. 292; Goguet, *Orig. des Loix*, ii. 227), though probably the first attempt to form a map (that is, a written catalogue of places, with something like their relative positions and distances roughly guessed) is to be ascribed to the men whom Joshua (Josh. xviii.) sent with orders to 'go through the land and describe it;' and the men 'went and passed through the land' and described it by cities into seven parts in a book.

At a later period, it is unquestionable that the Hebrews possessed a knowledge of the north-west, and a wider knowledge of the east, and even of the north of Asia (Ezek. xxvii; Isa. li. 27). From the period of the Maccabees the Jews entered into relations of a mercantile and political character, which extended their knowledge of the earth, and made them better acquainted with Asia Minor, Greece, and Italy. In the time embraced by the New Testament history they must have been

widely acquainted with the then known world, since colonies and individuals of their nation were spread over nearly the entire surface covered by ancient civilization, and identified with the Roman empire. The occasional, if not periodical, return of the Jews thus scattered abroad, or at least the relations which they would sustain with their mother country, must have greatly widened, and made less inaccurate, the knowledge entertained in Palestine of other parts of the world. Accordingly we read (Acts ii. 5, sq.) that, at the effusion of the Holy Spirit on the day of Pentecost, there were dwelling at Jerusalem Jews out of every nation under heaven.' See the enumeration of the countries whence they came in the context. For a knowledge of the commercial enterprises of the Phœnicians consult Leroy, *Mém. de l'Acad. des Inscr.* xxviii. 512; Bähr, *Excurs. ad Herod.* ii. 667. Information on the geographical knowledge of the Hebrews may be found in Huet, in Ugolini's *Thesaurus Antiq. Sacrarum*, vii. 244; d'Anville, *Mémoires de l'Acad. des Inscr.* xxx. 83; Bredow's *Untersuch. über Gesch. und Geogr.* ii. 263; Bellermann, *Bibl. Erdbeschr.* i. 143; Zeune's *Erdansichten*, p. 2. On the history of geography among the ancients the following works also may be consulted: Bangondy, *Essai sur l'Histoire de la Géog.* Paris, 1765; Blair, *History of the Rise and Progress of Geography*, London, 1781; Sprengel, *Geschichte der Wichtigsten Geogr. Entdeckung*, Halle, 1792; Ukert, *Geogr. der Griechen und Römer*, 1816; Forbiger, *Handbuch der Alten Geogr.*, Leipz. 1842; as well as the standard works of Ritter and Mannert. Among the older works, Reland's *Palestine (Palestina ex Monumentis Vet. illustrata*, Norimbergæ, 1716) continues to hold a distinguished place. Reland was professor of Oriental languages and ecclesiastical history at Utrecht, and died in 1718. There have been several editions of his work. It is divided into three books: the first treats of the names, situations, boundaries, divisions, rivers, mountains, and plains of Palestine; the second, of the distances of the principal places; and the third, of the cities and villages. His diligence in amassing information is very great. Maps, tables, and engravings of coins, enrich the work. It is reprinted in the sixth volume of Ugolini's great work, *Thesaurus Antiq. Sacrarum*. Much valuable, accurate, and interesting information, brought down to a recent date, may be found in Kitto's *Pictorial History of Palestine*, 1841.

Among the maps of Palestine the following deserve special mention:—that of Montanus, in his *Antiquitates Judaicae*, 1572; *La Palestine*, par d'Anville, 1781; *Carte Physique et Politique de la Syrie*, par C. Paultre, Paris, 1803; *Palästina*, von Reichardt; *Carte Topographique de l'Égypte et de plusieurs pays limitrophes, levée pendant l'Expédition de l'Armée Française*, construite par Jacotin. This author accompanied Napoleon in his expedition to Egypt, in the capacity of geographical engineer. He was aided by other officers of the army. Robinson says it 'is valuable only in the parts actually visited by the French engineers, namely, along the coast as far as to Akka, the region of Nazareth, and around Mount Tabor. The other parts are worthless, being apparently mere fancy sketches' (*Palest.* Pref. p. xi.). *Karte von Syrien*, von H. Berghaus, Gotha, 1835; of which Rauner (*Palästina*, 2d

edit. p. 18) speaks in favourable terms. *The Illustrated Atlas of Scripture Geography*, by W. Hughes, Lond. 1840, is a useful work. The student would do well to consult the maps in Robinson's *Palestine*.

Among the original sources of our knowledge of biblical geography stands first and chief the Bible itself. The value of the Bible in this respect is incomparable, and altogether peculiar, not only because it contains the earliest authentic history in the world, but because its statements are more minute and more accurate than can be found in other ancient authorities. The testimony of Oriental travellers on this point, whether direct or indirect, is full and unanimous. The more we have come to know, by actual inspection, of the countries and places of which the Bible speaks, the greater reason has there been found to repose confidence in the particulars which it supplies; and even to the present day the best itinerary through the Holy Land is the Bible, when expounded and applied by the aid of the native Aramæan population (Robinson's *Palestine*, Introduction). If preference is to be given to any particular parts of the holy volume, the Pentateuch, Joshua, the Gospels, and the Acts deserve special mention. In the New Testament, it is to some extent a new world that is opened out before the geographical student. Certainly, as might be expected, many places found in the Old Testament are sought in vain in the New; while, on the other hand, the New Testament mentions many hills, streams, cities, and countries, not presented in the Old. In a similar way, places which hold a high importance in the one sink or disappear in the other.

The remarks which were made under the head ANTIQUITIES, in relation to the value of the writings of Josephus, are equally applicable in the subject now under consideration.

Among the profane writers, Herodotus mentions Palestine, and probably Jerusalem, which he names Cadytis (Herod. i. 105; ii. 106, 157, 159; iii. 5, 62, 64, 91; iv. 39). Strabo (in the time of Augustus) treats of Palestine in the second chapter of his sixteenth book on Geography, mingling together much truth and much error. Ptolemæus, who died 161 years after Christ, treats of Palestine and the neighbouring countries in chapters xv.-xvii. of his fifth book. Dion Cassius relates the conquest of Palestine by Pompey (xxvii. 15-17), the siege of Jerusalem by Titus (lxi. 4-7), the restoration of the temple by Hadrian, and the insurrection of the Jews under the same emperor (lix. 12-14). Of the Roman writers, Pliny, in his *Natural History* (v. 13-19), treats of Syria, including Palestine, and supplies much useful information. Tacitus' *History*, from the first to the thirteenth chapter of the fifth book, also relates to our subject. He hated both Jews and Christians (*Annal.* xv. 44), and in consequence gave false colourings to much of what he said relating to them (*Hist.* v. 3, 4; ii. 79; *Annal.* ii. 42; xii. 23). Some information may also be found in Justin (xxxvi. 2), in Suetonius (*Augustus*, 93; *Claudius*, 25, 28; *Vespasian*, 4, 5; *Titus*, 4, 5), in Pomponius Mela (i. 2), and in Ammianns Marcellinus (xiv. 8, xxiii. 1).

Among the Fathers of the Church much serviceable knowledge on the subject of Biblical geo-

graphy may be found in the expository writings of Theodoret and Jerome. The most important work, however, is *Onomasticon urbium et locorum sacra Scriptura, seu liber de locis Hebraicis, Græce primum ab Eusebio Casariensi, deinde Latine scriptus ab Hieronymo*, opera J. Bonfrerii, 1707. Living as they did for a long time in Palestine, the writings both of Eusebius and Jerome possess peculiar value, which, however, grows less as the times of which they speak recede from their own.

Some Arabian writers are not without value. We have Edrisi, *Geographia Nubiensis*, Paris, 1619; also Abulfedæ *Tabula Syriae*, and his *Annales Mustemici*. Schultens, in his *Index Geographicus in Vitam Saladinæ*, Lugduni Batav. 1732, has collected many observations of Arabian authors on Palestine. See also Rosenmüller, *Handb. Bibl. Alter.* i. 34; Ritter, *Erdkunde*, ii. 478.

Certain itineraries or travelling guides are also of value as sources of information. These itineraries are of two kinds: 1. *Itineraria scripta*; 2. *Itineraria picta*. The last borrowed assistance from the art of drawing, and seem to have existed in earlier times under the Greek name of *πίναξ γεωγραφικός* (Strabo, i. p. 7; Ptol. i. 6, 20), or simply *πίναξ* (Strabo, ii. pp. 87, 90), or the Roman designation of *tabula* (Cic. *ad Att.* vi. 2; Propert. iv. 3. 35); sometimes also the Greek word, in Latin letters, *pinax*, was used (Cassiod. *De Inst. Div.* 25). See Reinganum, *Geschichte der Erd und Länder abbildungen der Alten*, Jena, 1839, i. 32. The first class were a kind of guide-books which were designed chiefly for official purposes, and gave, without any geographical remarks, the names of places met with on certain roads, with the distances, and the chief stopping places. These are collected in P. Bertii *Theatrum Geogr. Vet.* (Lugd. Bat. 1618), and in *Vetera Roman. Itineraria*, curante P. Wesselingio (Amstelod. 1735). We may specify, as of most service, the *Itinerarium Hierosolymitanum seu Burdigalense*, which belongs to the fourth century. It was made by a Christian, and gives the route from Bordeaux to Jerusalem, and from Heraclea through Rome to Milan, with some fulness and accuracy, mentioning the smaller intervening places where horses were changed (mutations) or the night passed (mansiones), with a few scattered historical notices, and, so far as Palestine and Jerusalem are concerned, with pretty exact statements as to the localities of sacred history. The *Itinerarium Antonini*, which gives the routes through all the provinces of the Roman empire, has been ascribed to the emperor Antoninus himself; but, though it may have taken its rise under his patronage, it must, in its actual state, be of a later date, since it mentions places which did not exist till a subsequent period. Extracts and specimens may be seen in Reland's *Palæstina*, p. 422, &c., where also (p. 421) may be found a specimen of the *Itineraria Picta*, executed in copper-plate. Of the *Itineraria Picta* there is a collection which, from its first possessor, Conrad Peutinger of Augsburg, is commonly called *Tabula Peutingeriana*, and probably comes down from the time of Alexander Severus, about A.D. 230. There is no original of it, but only a trustworthy transcript, made by a monk of the thirteenth century, on twelve folio parchment leaves.

These tables are a sort of rough chart or map, describing to the eye distances and direction, without regard to the shape or size of countries or the geographical position of places.

Of the works which have appeared treating directly or indirectly on the geography of Palestine from the eighth century downwards, the list is far too long to be here admitted, though many of them must be regarded in the light of valuable as well as original sources. The titles of a few we shall give, referring the reader to the works before specified for fuller details:—*Gesta Dei per Francos, sive Orientalium Expeditionum et regni Francorum Hierosolymitani Historia*, 1611; *Voyages de Rabbi Benjamin fils de Jona de Tudèle*, par Baratrier, Amsterd. 1731; *Elucidatio Terræ Sanctæ Historica*, auctore F. Quaresmio, olim T. S. Præsule, Antwerp, 1639; *A Journey from Aleppo to Jerusalem at Easter*, 1697, by Henry Maundrell, sixth edit. Oxf. 1740; T. Shaw's *Travels in Barbary and the Levant*, 1738; R. Pococke's *Travels in the East*, 1743; *Voyages en Syrie et en Egypte*, par Volney, 4th edit., 1807,—an interesting and accurate work, notwithstanding the peculiar opinions of the writer; *Travels in various countries of Europe, Asia, and Africa*, by E. D. Clarke, 4th edit. Lond. 1818; Seetzen, in Zach's *Monatlicher Correspondenz*, 1808; Burckhardt says of him that he was the most indefatigable traveller that ever visited Syria; *Travels in Syria and the Holy Land*, by Burckhardt, Lond. 1822; *Wallfahrten in Morgenlande*, von O. T. von Richter, Berlin, 1823; *Travels in Palestine*, by Buckingham, Lond. 1821; *Voyage de l'Arabie Pétrée*, par Léon de Laborde, Paris, 1830.

With the publication of Robinson's *Biblical Researches in Palestine* (London, 1841), a new era in some sort may be said to have commenced in Biblical geography. We do not allude to the preparation of mind which the author carried into the personal inquiries and observations which he made in the Holy Land, nor to the accuracy with which he both conducted and recorded his investigations, so much as to the principle on which he was, by the course of his researches, led to act, and on the recognition of which his valuable work is constructed, namely, the preference which he has wisely given to popular tradition, in regard to localities and facts, over the monkish legends that prevailed before his visit. He lays it down as a general principle (i. 374) 'that all ecclesiastical tradition respecting the ancient places in and around Jerusalem and throughout Palestine is of no value, except so far as it is supported by circumstances known to us from the Scriptures or from other contemporary history.' The effect of superstition has been the creation and transmission of a vast mass of false and legendary matter, which has imposed on the credulity of successive travellers. 'Even within the last two centuries, so far as the convents and travellers in Palestine are concerned, I fear the cause of Biblical geography can hardly be said to have greatly advanced' (Robinson. *Pref.* p. ix.). 'But there is in Palestine another kind of tradition with which the monasteries have had nothing to do, and of which they have apparently in every age known little or nothing—I mean the preservation of the ancient names of places among the common people. This is truly a natural and native tra-

dition, not derived in any degree from the influence of foreign convents or masters, but drawn in by the peasant with his mother's milk, and deeply seated in the genius of the Semitic language' (Robin. *Palest.* i. 376). After remarking that Seetzen and Burckhardt had pointed out a better course by seeking information among the Arab peasantry, Robinson says he adopted two principles in his examination of the Holy Land : 1. To avoid contact with the convents, to examine with the Scriptures in his hands, and to apply for information solely to the native Arab population; 2. To leave the beaten track, and direct attention to the least visited portions of the country (i. 377). Three periods of foreign tradition have had an influence in corrupting our knowledge of the geography of Palestine. The first falls about A.D. 333, when the influence of Constantine, Helena, and their like, gave rise to much topographical falsehood. The *Onomasticon* of Eusebius and the *Jerusalem Itinerary* are a record and a specimen of this period. The second is the age of the Crusades in the twelfth and thirteenth centuries; the tradition of which is best registered in the tract of Brocardus about A.D. 1283. The third period occurs at the beginning of the seventeenth century, when the volumes of Quaresmius exhibit in full the state of the tradition then current in the convents, the great source from which most European travellers have drawn their information. During these three periods the light of truth gradually became dim, and was at length stee quenched in darkness. The *Onomasticon*, however, with all its defects and wrong hypotheses, has yet preserved much of the tradition of the common people, and contains many names of places never since discovered, though still existing; while the few pages of Brocardus are worth more, in a topographical respect, than the unwieldy folios of Quaresmius (Robinson, *Preface*).—J. R. B.

GEPHEN (ἄμπελος). [VINE.]

GERAH (גֵּרָח; Sept. ὀβολός), the smallest piece of money among the Hebrews. Twenty made a shekel; one of them would therefore be worth three halfpence, according to the present value of silver (Exod. xxx. 13).

GERAR (גֵּרָר; Sept. Γεράρ), a town and district on the southernmost borders of Palestine, in the country of the Philistines, and not far from Gaza. It was visited by Abraham after the destruction of Sodom (Gen. xx. 1), and by Isaac when there was a dearth in the rest of Canaan (Gen. xxvi. 1). The incidents of their sojourn show that the district was very fertile. It was the seat of the first Philistine kingdom we read of, and gave name to it. The intercourse, differences, and alliances of the Hebrew fathers with the king and people of Gerar form a very curious and interesting portion of patriarchal history. It was still an important place in later times, as we may gather from 1 Chron. xiv. 13, 14. According to the ancient accounts Gerar lay in or near a valley, which appears to be no other than the great Wady Sheriah (or one of the branches of it), that comes down from Beersheba; besides we know that it was in the land of the Philistines, and that it was not far from Beersheba when Isaac resided there (Gen. xxvi. 1, 20, 23; 26-33; comp. xx. 1). The name continued to exist (perhaps as a matter

of tradition) for several centuries after the Christian era. Eusebius and Jerome (*Onomast. s. v. Gerar*) place it twenty-five Roman miles southward from Eleuthropolis; and Sozomen (*Hist. Eccles.* vi. 32; ix. 17) reports that a large and celebrated monastery stood there near a winter torrent. The abbot Silvanus resided there towards the end of the fourth century, and the name of Marcion, bishop of Gerar, appears among the signatures of the council of Chalcedon in A.D. 451. The name seems to have been afterwards lost, and Dr. Robinson was unable to discover any traces of it in the locality; but it is to be hoped that some possible remains of the convent may hereafter assist in recovering the knowledge of the site.

GERASA, now JERASH (not named in the Bible), was in the Decapolis, and formed the eastern boundary of Peræa. It lay on elevated ground, according to Ptolemy, in 68° 15' = 31° 45'. Its inhabitants were mostly heathen (Joseph. *De Bell. Jud.* iii. 3. 3; comp. iv. 9. 1; ii. 18. 5; *Antiq.* xiii. 15. 5). Origen speaks of it as a city of Arabia (Γέρασα τῆς Ἀραβίας ἐστὶν πόλις), which arose from the fact that it was a border city of Peræa, and lay next to Arabia. After the Roman conquests in the East, the country in which Gerasa lies became one of their favourite colonies, and ten principal cities were built on the east of the Jordan, giving the name of Decapolis to the land in which they stood. Gerasa was one, but not the greatest of these. The place was taken by storm by Alexander Jannæus, who was actuated by a desire of gaining a large treasure (Joseph. *De Bell. Jud.* i. 4. 8; *Antiq.* viii. 2. 3). Alexander died near it while besieging Regaba

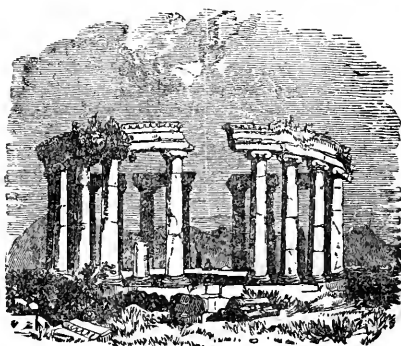

326.

(*Antiq.* xv. 5). Before the place had time to recover from this calamity, it was included among the number of those cities which were burnt by the enraged Jews in their vengeance on the Syrians, and on the Roman power generally, for the massacre of a number of their nation at Cæsarea (Joseph. *De Bell. Jud.* ii. 18. 1). A terrible revenge was taken by other cities, but Gerasa is honourably excepted (*De Bell. Jud.* ii. 18. 5). Annius, general under Vespasian, took the city; 'after which he set fire to their houses,' and what was remaining was all burnt down' (*De Bell. Jud.* iv. 9. 1). Gibbon enumerates this city among the line of fortresses from Bosra to Petra, which formed the frontier of the Syrian provinces

in the lower empire. Baldwin II. of Jerusalem destroyed its castle in the year 1122 (Will. Tyr. p. 825; *Histor. Hierosol.* p. 615). This was the native place of Nicomachus Gerasenus. Coins of Gerasa may be seen in Eckhel (*Num. Vet.* iii. 350). Its ruins were first discovered by Seetzen, and have often been subsequently visited. They have been pronounced superior to those of Palmyra.

On approaching Gerasa on the southern side, Buckingham first saw a triumphal gateway, nearly entire, which was of the Corinthian order. Within this gateway, on the left, he observed a fine naumachia for the exhibition of sea-fights, the channels for filling which with water were still visible. Corn was growing near it. Passing on amid heaps of ruined fragments, he came to a second gateway. Entering the city through this its southern gate, he came into a large and beautiful circular colonnade of the Ionic order, having passed a peripteral temple, above which on the left was an open theatre. A long avenue of columns of the Corinthian order, led through the whole length of the city. Climbing over huge masses of fallen columns and masonry, he noticed four columns on each side of the way of much greater size and height than the rest. Beyond this he came to a square, apparently once lined on both sides by an avenue of columns. He afterwards came to a portion of a semi-circular temple. A broken altar was near the ruins, on which was made out the name of Marcus Aurelius. Beyond this again were temples, colonnades, theatres, bridges, aqueducts, &c. These remarks will give an idea of the magnificence of these ruins, particularly when we add that the northern exit is a mile apart from the southern entrance. A necropolis lies not far from the northern wall, in which were found nearly a hundred sculptured sarcophagi above ground, having the appearance of having been ransacked for treasure. Near the necropolis were the remains of a small temple. The city stood on the facing slopes of two opposite hills, but, from the neighbouring heights, it appears to be seated in the hollow of a deep valley, encircled on all sides by lofty and verdant mountains. Near this spot is the modern village of Aiode. Some inscriptions found on the ruins may be seen in Buckingham's *Travels in Palestine*, p. 405.—J. R. B.

GERGESENES. [GADARA.]

GERIZIM, MOUNT. [EBAL AND GERIZIM.]

GERSHOM (גֶּרְשׁוֹם, *a stranger here*; Γηρσάμ), one of the two sons (the other was Eliezer) who were born to Moses in the land of Midian by Zipporah (Exod. ii. 22; xviii. 4). These sons of the great lawgiver held no other rank than that of simple Levites, while the sons of their uncle Aaron enjoyed all the privileges of the priesthood (1 Chron. xxiii. 14). The glory of being the children of such a father doubtless availed them more than the highest dignities; but we must nevertheless admire the rare disinterestedness of Moses in making no public provision—as he might so easily have done—for his own children.

GERSHON (גֶּרְשׁוֹן, *banisher*; Sept. Γηρσών), eldest son of the patriarch Levi, born in Canaan before the going down into Egypt. He is only known from his name having been given to one of the three great branches of the Levitical tribe.

The office of the Gershonites, during the marches in the wilderness, was to carry the vails and curtains of the tabernacle, and their place in the camp was west of the tabernacle (Gen. xlvii. 11; Exod. vi. 16; Num. iii. 17).

GESHEM (גֶּשֶׁם, *carcase*; Sept. Γησάμ), one of the enemies of the Jews under Nehemiah (Neh. vi. 6). He was probably a Samaritan, although on some account or other designated an Arabian (Neh. ii. 19), and seems to have been a subaltern officer at Jerusalem. He opposed the designs of the Jewish governor, talking of them as seditious, and turning them into ridicule. Eventually he took part in the plots of Tobiah against the life of Nehemiah (Neh. ii. 19; vi. 2-9), about B.C. 445.

GESHUR (גֶּשׁוּר; Sept. Γεδσοῦρ), a district of Syria (2 Sam. xv. 8; 1 Chron. ii. 23), which adjoined, on the east side of the Jordan, the northern border of the Hebrew territory, and lay between Mount Hermon, Maachab, and Baslan (Deut. iii. 13, 14; Josh. xii. 5). According to the boundaries of the Holy Land, as defined by Moses, Geshur would have formed part of it; but in Josh. xiii. 2, 13, it is stated that the Israelites had expelled neither the Geshurites nor the Maachathites, but dwelt together with them. That the Hebrews did not afterwards permanently subdue Geshur appears from the circumstance that, in David's time, this district had a king of its own, called Talmi, whose daughter, Maacab, was one of the wives of David (2 Sam. iii. 3). She was the mother of Absalom, who took refuge with his grandfather after the murder of Amnon, and remained three years in Geshur (2 Sam. xiii. 37; xv. 8). The word *Geshur* signifies a bridge, and corresponds with the Arabic *Jisr*, and in the same region where, according to the above data, we must fix Geshur, between Mount Hermon and the lake of Tiberias, there still exists an ancient stone bridge over the upper Jordan, called Jisr-Beni-Jakub, or 'the bridge of the children of Jacob,' i. e. the Israelites. (See a figure of this bridge in No. 176.) The ancient commercial route to and from Damascus and the East seems to have lain in this direction in the most ancient times (Gen. xxxvii. 25); and hence the probability that there was even then a bridge over the river, which (in times when bridges were rare) gave its name to the adjacent district.

GESHURITES, GESHURI; 1. The inhabitants of the above region [GESHUR]. 2. A people in the south of Palestine, near the Philistines (Josh. xiii. 2; 1 Sam. xxvii. 8).

GETHSEMANE (Γεθσημανῆ, seemingly from the Hebrew גֶּתְשֵׁמַנֶּה, *press*, and נֵיטְשֵׁן, *oil*, i. e. *oil-press*), the name of a small field, or garden, just out of Jerusalem, over the brook Kidron, and at the foot of the Mount of Olives. That which is now pointed out as the garden in which our Lord underwent his agony, occupies part of a level space between the brook and the foot of the Mount, and corresponds well enough in situation and distance with all the conditions which the narrative requires. It is about fifty paces square, and is enclosed by a wall of no great height, formed of rough loose stones. Eight very ancient olive-trees now occupy this enclosure, some of which are of very large size, and all exhibit symptoms of decay clearly

denoting their great age. The garden belongs to one of the monastic establishments, and much care has been taken to preserve the old trees from destruction. Several young trees have been planted to supply the place of those which have disappeared (Olin's *Travels*, ii. 115). Dr. Robinson remarks that there is nothing particular in this plot to mark it as the garden of Gethsemane; for adjacent to it are many similar enclosures, and many olive-trees equally old (*Researches*, i. 346). This, however, can be no ground for the doubt as to its identity which this learned writer suggests; for it is elsewhere a matter of complaint with him that the sites of Scriptural events are not thus left in the simplicity of their natural state, but are over-crowded with extraneous additions. Dr. Robinson admits the probability that this is the site which Eusebius and Jerome had in view; and, as no other site is suggested as preferable, we may be content to receive the traditional indication.

GEZER (גֵּזֶר; Sept. Γαζέρ and Γάζαρα), formerly a royal city of the Canaanites, and situated in what became the western part of the tribe of Ephraim. The Canaanites were not expelled from it at the conquest (Josh. x. 33; xvi. 5, 10; Judg. i. 29). It was, nevertheless, assigned to the Levites (Josh. xxi. 21). In after times, having been, on some occasion, destroyed by the Egyptians, it was rebuilt by Solomon.

GIANTS. The English word is derived immediately from the Latin *gigas*, which is only Greek in Roman letters; and *γίγας* itself is, in all likelihood, made up of *γινέσθαι* and *γέα* or *γη*, thus signifying 'the earth-born,' in allusion to classical fable.

These beings of unusual height are found in the early history of all nations, sometimes of a purely human origin, but more frequently supposed to have partaken also, in some way, of the supernatural and the divine.

The Scriptural history is not without its giants. The English word has several representatives in the original Hebrew, a consecutive notice of which will lead us to sketch the history of Biblical giants.

1. In Gen. vi. 4, we have the first mention of giants (גִּבּוֹרִים)—'There were giants in the earth in those days; and also after that, when the sons of God came in unto the daughters of men, and they bare children to them, the same became mighty men which were of old, men of renown.' A somewhat similar intercourse is made mention of in the second verse of the same chapter—'the sons of God saw the daughters of men that they were fair, and they took them wives of all which they chose.' Wellbeloved (*in loc.*) and others translate and interpret the passage so as to make it speak merely of 'men of violence; men who beat down, oppressed, and plundered the weak and defenceless.' Doubtless this is in agreement with the meaning of the original word. But these giants, as in other cases, would naturally be designated by a descriptive name, and great strength is generally accompanied by violence and oppression. In our judgment the bearing of the passage obviously favours the common notion of giants, and that the rather because their origin is traced to some unexplained connection with 'the sons of

God,' that is, with beings of high endowments, if not of a superior nature.

2. In Gen. xiv. 5, we meet with a race termed Rephaim (רִפְּתִים), as settled on the other side of the Jordan, in Ashteroth-Karnaim, whom Chedorlaomer defeated. Of this race was Og, king of Bashan, who alone remained, in the days of Moses (Deut. iii. 10), of the remnant of the Rephaim. A passage, which is obviously from a later hand, goes on to say—'Behold, his coffin (see Michaelis, Dathe, Rosenmüller) was a coffin of iron; is it not in Rabbath of the children of Ammon? nine cubits is its length and four cubits its breadth, according to the cubit of a man,' or the natural length of the cubit [CUBIT]. It does not appear to us to be enough to say that Og was 'no doubt a man of unusual stature, but we cannot decide with accuracy what his stature was from the length of the iron coffin in which he was placed' (Wellbeloved, *in loc.*). Whatever theory of explanation may be adopted, the writer of the passage clearly intended to speak of Og as a giant, and one of a race of giants (comp. Josh. xii. 4; xiii. 12). This race gave their name to a valley near Jerusalem, termed by the Seventy, ἡ κοιλία τῶν τριάντων. In Job xxvi. 5, Rephaim is rendered, in the common version, 'dead things,' to the entire loss of the force of the original. The Douay Bible gives the passage with truth as well as spirit, making it obviously refer to the old myth of the subjugation of the earth-born by divine power:—'Behold, the gyantes groan under the waters, and they that dwell with them. Hell is naked before them, and there is no covert to perdition.'

3. The Anakim (עַנְקִים or בְּנֵי עַנְק). In Num. xiii., the spies sent by Moses before his army to survey the promised land, report among other things—'The people be strong that dwell in the land; and, moreover, we saw the children of Anak' (ver. 28). This indirect mention of the children of Anak shows that they were a well-known gigantic race. In the 32nd and 33rd verses the statement is enhanced,—'It is a land that eateth up the inhabitants; and all the people that we saw in it are men of great stature. And there we saw the giants, the sons of Anak which came of the giants; and we were in our own sight as grasshoppers, and so we were in their sight.' However much of exaggeration fear may have given to the description, the passage seems beyond a doubt to show the writer's belief in a race of giants (Deut. ix. 2). From Deut. ii. 10, it appears that the size of the Anakim became proverbial, and was used as a standard with which to compare others. In the time of Moses they dwelt in the environs of Hebron (Josh. xi. 22). They consisted of three branches or clans—'Ahiman, Sheshai, and Talmi—the children of Anak' (Num. xiii. 22). They were destroyed by Joshua (Josh. xi. 21) 'from the mountains, from Hebron, from Debir, from Anab, and from all the mountains of Judah, and from all the mountains of Israel: Joshua destroyed them utterly with their cities. There was none of the Anakim left in the land of the children of Israel: only in Gaza, in Gath, and in Ashdod, there remained' (Judg. i. 20; Josh. xiv. 12).

4. From this remnant of the Anakim thus left in Gath of the Philistines, proceeded the famous Goliath (גִּלְיָת), 1 Sam. xvii. 4. This giant is

said to have been in height six cubits and a span. He challenged the army of Israel, and put the soldiers in great alarm. 'The army of the Philistines and that of Israel were, however, on the point of engaging, when David, the youngest son of Jesse, came near, bringing, at the command of his father, a supply of provisions to his three eldest brothers, who had followed Saul to the battle; and, becoming aware of the defiance which had been again just hurled at 'the armies of the living God,' he at once went and presented himself as a champion to the king; was offered, but refused, a coat of mail; and arming himself solely with a sling, smote the Philistine in his forehead, so that he fell upon his face to the earth, and was decapitated by David with his own sword. A general victory ensued. This achievement is ascribed to the divine aid (v. 46, 47). In 2 Sam. xxi. 19, 'Goliath the Gittite, the staff of whose spear was like a weaver's beam,' is said to have been slain by Elhanan, a chief in David's army. This apparent contradiction the common version tries to get over by inserting words to make this Goliath the brother of him whom David put to death. Winer (*Handwörterb.* s. v. Goliath) supposes that the former was a descendant of the latter, bearing the same, perhaps a family name. See, however, the parallel passage in 1 Chron. xx. 5. Other giants of the Philistines are mentioned in the passage before cited, 2 Sam. xxi. 16, sq., namely:—1. 'Ishbi-benob, which was of the sons of the giant, the weight of whose spear weighed three hundred shekels of brass, he being girded with a new sword, thought to have slain David; but Abishai, the son of Zeruiah, succoured him, and smote the Philistine and killed him.' 2. Saph, which was of the sons of the giant who was slain by Sibbechai. 3. 'A man of great stature, that had on every hand six fingers and on every foot six toes, four and twenty in number, and he also was born to the giant; and when he defied Israel, Jonathan, the son of Shimeah, the brother of David, slew him.' These four were sons of the giant in Gath, that is, probably of the Goliath of Gath whom David slew (1 Kings xx. 8; 2 Sam. xx. 22; 1 Sam. xvii. 4).

5. Another race is mentioned in Deut. ii. 10, the Emim (עַמִּיטִים), who dwelt in the country of the Moabites. They are described as a people 'great and many, and tall as the Anakims, which were also accounted giants' (Gen. xiv. 5).

6. The Zamzumim also (זַמְזוּמִים) (Deut. xxi. 20), whose home was in the land of Ammon—'that also was accounted a land of giants: giants dwelt therein of old time, and the Ammonites called them Zamzumims, a people great and many, and tall as the Anakims; but the Lord destroyed them before them, and they (the Israelites) succeeded them, and dwelt in their stead.'

From this enumeration it is clear that the Scriptures tell of giants in the olden time, and of races of giants; and that, though giants are mentioned as something singular and consequently as comparatively rare, they appear to have been, relatively to the numbers of the population, of frequent occurrence. Whatever deduction may be made for the influence of the passions in the narratives which have passed under review; and though it is true that more than one passage bears traces of interpolation; yet there is evidence that

Scriptural writers believed in giants and races of giants as a reality.

That the primitive races of men greatly surpassed others in stature is an opinion which finds ample support in ancient authors generally; and at an early period and under favourable circumstances, individuals and even tribes may have reached an unusual height and been of extraordinary strength. But many things concur to show that the size of the race did not differ materially from what it is at present. This is seen in the remains of human beings found in tombs; especially among the mummies of Egypt. To the same effect is the size of ancient armour, as well as architectural dimensions, and the measures of length which have been received from antiquity. Ancient writers who are free from the influence of fable, are found to give a concurrent testimony. 'Homer, when speaking of a fine man, gives him four cubits in height and one in breadth; Vitruvius fixes the usual standard of a man at six Roman feet; Aristotle's admeasurement of beds was six feet' (Millingen's *Curiosities of Medical Experience*, p. 14).

That great diversity as to height and size prevails in the human family, is well known. What the precise limits may be within which nature has worked in the formation of man, it would be difficult to determine. The account which Aristotle and others have given both of pigmies and of giants may be safely treated as fables. But the inhabitants of northern latitudes are well known to be below the ordinary standard, many of them scarcely exceeding four feet; while in temperate climates the height of the human race averages from four feet and a half to six feet; and instances are not wanting of persons who measured eight or nine feet. Some authors go so far as ten and eighteen, but these assertions seem to refer to fossil bones erroneously attributed to man. Humboldt says that the Guayaquilists measure six feet and a half, and that the Payaguans are equally tall, while the Caribbees of Cumana are distinguished by their almost gigantic size from all the other nations he had met with in the New World. The Patagonians were stated by the Spanish early navigators to measure seven feet four inches. This account appears to be an exaggeration; but more recent travellers—such as Bougainville, Byron, Wallis, Carteret, and Falkner—affirm that their height ranges from six to seven feet.

Cases of great individual height and strength are not seldom found, though now and then they have been much exaggerated. The tallest persons of whom we have a trustworthy record did not, according to Haller, exceed nine feet. Schreber, who has collected the description of the principal modern giants, found few above seven feet and a half; although he mentions a Swedish peasant of eight feet Swedish measure; and one of the guards of the Duke of Brunswick was eight feet six inches Dutch. One of the best authenticated cases in modern times is that of Parsons, who was by trade a blacksmith, and porter at Court in the early part of the 18th century. Hakewil (*Apology*, iii. 4. 3), Fuller (*Worthies*, Staffordshire), and Plott (*Nat. Hist. Stafford*, viii. 50) concur substantially in their accounts respecting him. He was seven feet two inches, and, on the authority of Fuller, 'he was proportionable in his parts, and had strength equa-

to his height, valour to his strength, temper to his valour; so that he disdained to do an injury to any single person. He would make nothing to take two of the tallest yeomen of the guards under his arms at once, and order them as he pleased.' We have in existence evidence of extraordinary height in the case of O'Brien, who was exhibited throughout England about the year 1781. His skeleton, preserved in the Museum of the Royal College of Surgeons in London, measures seven feet eleven inches in height. If we allow two inches for the softer parts of the body, his stature would be eight feet one inch. Other instances of still greater height are on record (see art. 'Giant,' in the *Encyclopædia Metropolitana*); but some are evidently fabulous, some are insufficiently authenticated, and others bear obvious signs of exaggeration. Nor, after all, is it of much consequence to what height the human frame may, in any individual case, have extended. There have been monsters of all kinds; and height, without health, vigour, and corresponding strength, is only a form of monstrosity; not to say that there are certain physical conditions of human existence which, if they do not forbid a height so great as some have fabled of, go far to deprive any very unusual size of even ordinary strength.

The possibility of a race of giants cannot well be denied. There is a known tendency in the human frame to perpetuate peculiarities which have been once evolved. Why not extraordinary 'procrity' as well as any other? In fact, the propagation of stature, whether high or low, is a phenomenon which we all see presented daily before our own eyes. Tall parents give birth to all children. The tallness is found to remain in families; and, doubtless, did not circumstances intervene to reduce the stature by intermarriage with short persons, the unusual height would be perpetuated in any given line. The inhabitants of Potsdam, descended to a great extent from the famous regiment of tall grenadiers which Frederick of Prussia took so much pains to bring together, are said to be still remarkable for exceeding the average height. The family of Scaligers appears to have been unusually tall.

It may also be to some extent admitted that, in the early ages, men may have surpassed the moderns in size and strength; so that Homer's *οἶοι νῦν βροτοὶ εἶσιν* may even then have had some ground, which has certainly since his time not grown less. For there are tendencies in the culture of a high civilization which, whatever they do for the mind, can hardly fail to reduce the size and lessen the strength of the body. It is a law in physiology that the exercise of any part or organ adds at once to its size, its vigour, and its power. In early periods the corporeal frame was in constant play, and in some states received especial care; while with us the body is dwarfed by comparative inactivity, as well as by insalubrious air and food. The natural consequence is a general diminution of physical strength, which, by going on for centuries, cannot well do otherwise than reduce the stature, and impair the effectiveness of the race.—J. R. B.

GIBBETHON (גִּבְתוֹן; Sept. Γαββαθών), a city of the Philistines, which was included in the territories of the tribe of Dan (Josh. xix. 44), and

was assigned to the Levites (Josh. xxi. 23). It was still in the hands of the Philistines in the time of Nadab, king of Israel, who besieged it, and was slain under its walls by Baasha, one of his own officers (1 Kings xx. 27; xvi. 15). Nothing is known of its site.

GIBBEAH (גִּבְעָה; Sept. Γαβαά). There were several places of this name, which, as before remarked [GEBBA], is the feminine form of the word Gibeah, and signifies a *hill*. Without doubt all the places so named were situated upon hills.

1. GIBBEAH OF BENJAMIN is historically the most important of the places bearing this name. It is often mentioned in Scripture. It was the scene of that abominable transaction which involved in its consequences almost the entire extirpation of the tribe of Benjamin (Judg. xix. 14, sq.). It was the birth-place of Saul, and continued to be his residence after he became king (1 Sam. x. 26; xi. 4; xv. 33; xxiii. 19; xxvi. 1); and here was the scene of Jonathan's romantic exploit against the Philistines (1 Sam. xiv.). It was doubtless on account of this its intimate connection with Saul, that the Gibeonites hanged up here his seven descendants (2 Sam. xxi. 6). Jerome speaks of Gibeah as, in his time, level with the ground (*Ep.* 86, *ad Eustoch.*), and since then it does not appear to have been visited by travellers till recently. Dr. Robinson, who made many valuable observations in this neighbourhood, detected Gibeah in the small and half-ruined village of Jeba, which lies upon a low, conical, or rather round eminence, on the broad ridge which shelves down towards the Jordan valley, and spreads out below the village in a fine sloping plain. The views of the Dead Sea and the Jordan, and of the Eastern mountains, are here very extensive. Among the ruins some large hewn stones, indicating antiquity, are occasionally seen. This place is about five miles north by east from Jerusalem.

2. GIBBEAH in the mountains of Judah (Josh. xv. 57), which, under the name of Gabaatha, Eusebius and Jerome place twelve Roman miles from Eleutheropolis, and state that the grave of the prophet Habakkuk was there to be seen. Dr. Robinson (*Researches*, ii. 327) identifies it with the village of Jebah, which stands upon an isolated hill, in the midst of Wady-el-Musurr, about ten miles south-west of Jerusalem.

3. GIBBEAH in Mount Ephraim, called Gibeah of Phineas, where the high-priest Eleazar (son of Aaron, was buried by his son Phineas (Josh. xxiv. 33). The *Onomasticon* makes it five Roman miles from Gophna, on the road to Neapolis (Shechem); which was itself fifteen Roman miles north of Jerusalem. Dr. Robinson finds it in a narrow valley called Wady-el-Jib, the Gech of Maudrell, lying just midway on the road between Jerusalem and Shechem.

GIBEON (גִּבְעוֹן; Sept. Γαβαών), a town celebrated in the Old Testament, but not mentioned in the New. It was 'a great city,' as one of the royal cities; and to its jurisdiction originally belonged Beeroth, Chephirah, and Kirjath-jearim (Josh. ix. 17; x. 2). It is first mentioned in connection with the deception practised by the inhabitants upon Joshua, by which, although Canaanites (Hivites), they induced the Jewish leader not only to make a league with them, and to spare their lives and cities, but also, in their de-

fence, to make war upon the five kings by whom they were besieged. It was in the great battle which followed, that 'the sun stood still upon Gibeon' (Josh. x. 12, 1-14). The place afterwards fell to the lot of Benjamin, and became a Levitical city (Josh. xviii. 25; xxi. 17), where the tabernacle was set up for many years under David and Solomon (1 Chron. xvi. 39; xxi. 29; 2 Chron. i. 3), the ark being at the same time at Jerusalem (2 Chron. i. 4). It was here, as being the place of the altar, that the young Solomon offered a thousand burnt-offerings, and was rewarded by the vision which left him the wisest of men (1 Kings iii. 4-15; 2 Chron. i. 3-13). This was the place where Abner's challenge to Joab brought defeat upon himself, and death upon his brother Asael (2 Sam. ii. 12-32), and where Amasa was afterwards slain by Joab (2 Sam. xx. 8-12). None of these passages mark the site of Gibeon; but there are indications of it in Josephus (*De Bell. Jud.* ii. 19. 1), who places it fifty stadia north-west from Jerusalem; and in Jerome (*Ep.* 86, *ad Eustoch.*): which leave little doubt that Gibeon is to be identified with the place which still bears the name of El-Jib; for Jib, in Arabic, is merely a contraction of the Hebrew Gibeon. The name *Gabaon* is indeed mentioned by writers of the time of the Crusades, as existing at this spot, and among the Arabs it then already bore the name of El-Jib, under which it is mentioned by Bohædinn (*Vita Saladin.* p. 243). Afterwards it was overlooked by most travellers till the last century, when the attention of Pococke was again directed to it.

El-Jib is a moderately sized village, seated on the summit of a hill, five miles north by west from Jerusalem. The houses stand very irregularly and unevenly, sometimes almost above one another. They seem to be chiefly rooms in old massive ruins, which have fallen down in every direction. One large building still remains, probably a former castle or tower of strength. Towards the east the ridge of the hill sinks a little, and here, a few rods from the village, just below the top of the ridge towards the north, is a fine fountain of water. It is in a cave, excavated in and under the high rock, so as to form a large subterranean reservoir. Not far below it, among olive-trees, are the remains of an open reservoir, about one hundred and twenty feet in length by one hundred in breadth. It was doubtless designed to receive the superfluous waters of the cavern, and there can be little question but that this was 'the Pool of Gibeon' mentioned in 2 Sam. ii. 13; and, in the whole, we find the 'Great [or many] waters of Gibeon' of Jer. xli. 12.

GIBLITES (גִּבְלִיִּים; Sept. Βίβλιται), the inhabitants of the city and district of Gebal in Phœnicia, 34° 7' N. lat., 35° 42' E. long., on the shore of the Mediterranean, under Mount Lebanon. 'The land of the Giblites,' with 'all Lebanon,' was assigned to the Israelites by the original appointment (Josh. xiii. 5); but it does not seem that they ever possessed themselves of it. The Giblites are denoted by the word rendered 'stone-squarers' in 1 Kings v. 18; from which it would seem that they were then subject to, or in close connection with, Tyre. It is doubtful whether this Gebal, or the one in Edom, is that mentioned in Ps. lxxxiii. 7. But in

Ezek. xxvii. 9, the Phœnician Giblites are distinctly mentioned as such, and preferably employed upon the shipping which formed the glory and strength of Tyre.

Gebal was called Byblos by the Greeks, and so the Septuagint has it here. It was an important place, and celebrated for the birth and worship of Adonis, the Syrian Thammuz. Pliny and other Roman authors call it Gabale (*Hist. Nat.* v. 20). The town still subsists under the name of Jebail. It is seated on a rising ground near the sea, at the foot of Lebanon, which here approaches close to the coast. It is walled on the three sides towards the land, and open on the west towards the sea, being perhaps about half a mile in circuit. Within the wall, which seems of the age of the Crusades, the chief building is an old castle, which has received modern repairs, and is now used as the abode of the agha or commandant. There are three or four open and lofty buildings belonging to the chief people of the place, a mosque with a low minaret, and an old Maronite church of good masonry; but the houses generally are of poor construction, and nearly half the space within the walls is occupied with the gardens of the inhabitants. The population is estimated at 2000. (Maundrell's *Journey*, p. 45; Burckhardt's *Syria*, p. 180; Buckingham's *Arab Tribes*, p. 455.)

GIDEON (גִּדְוֹן; Sept. Γεδεών), surnamed **JERUBBAAL** or **JERUBBESHETH**, fifth Judge in Israel, and the first of them whose history is circumstantially narrated. He was the son of Joash, of the tribe of Manasseh, and resided at Ophrah in Gilead beyond the Jordan.

The Midianites, in conjunction with the Amalekites and other nomade tribes, invaded the country every year, at the season of produce, in great numbers, with their flocks and herds. They plundered and trampled down the fields, the vineyards, and the gardens; they seized the cattle, and plundered man and house, rioting in the country, after the manner which the Bedouin Arabs practise at this day. After Israel had been humbled by seven years of this treatment, the Lord raised up a deliverer in the person of Gideon. He was threshing corn by stealth, for fear of its being taken away by the Midianites, when an angel of God appeared before him, and thus saluted him:—'The Lord is with thee, thou mighty man of valour.' Gideon expressed some doubt whether God was still with a people subject to such affliction, and was answered by the most unexpected commission—'Go in this thy might, and thou shalt save Israel from the hand of the Midianites: have not I sent thee?' Gideon still urged, 'Wherewith shall I save Israel? Behold my family is poor in Manasseh, and I am the least in my father's house.' The 'Wherewith' was answered by 'Surely I will be with thee.' He then demurred no more, but pressed his hospitality upon the heavenly stranger, who, however, ate not of what was set before him, but directing Gideon to lay it out upon the rock as upon an altar, it was consumed by a supernatural fire, and the angel disappeared. Assured by this of his commission, Gideon proceeded at once to cast down the local image and altar of Baal; and, when the people would have avenged this insult to their false god, their anger was averted through

the address of his father, who, by dwelling on the inability of Baal to avenge himself, more than insinuated a doubt of his competency to protect his followers. This was a favourite argument among the Hebrews against idolatry. It occurs often in the prophets, and was seldom urged upon idolatrous Israelites without some effect upon their consciences.

Gideon soon found occasion to act upon his high commission. The allied invaders were encamped in the great plain of Jezreel or Esdraelon, when he blew the trumpet, and thus gathered round him a daily increasing host, the summons to arms which it implied having been transmitted through the northern tribes by special messengers. The inquietude connected with great enterprises is more sensibly felt some days before than at the moment of action; and hence the two miraculous signs which, on the two nights preceding the march, were required and given as tokens of victory. The first night a fleece was laid out in the middle of an open threshing-floor, and in the morning it was quite wet, while the soil was dry all around. The next night the wonder was reversed, the soil being wet and the fleece perfectly dry (Judg. vii.).

Encouraged by these divine testimonies, Gideon commenced his march, and advanced to the brook Harod, in the valley of Jezreel. He was here at the head of 32,000 men; but, lest so large a host should assume the glory of the coming deliverance, which of right belonged to God only, two operations, remarkable both in motive and procedure, reduced this large host to a mere handful of men. First, by divine direction, proclamation was made that all the faint-hearted might withdraw; and no fewer than 22,000 availed themselves of the indulgence. The remaining 10,000 were still declared too numerous: they were therefore all taken down to the brook, when only those who lapped the water from their hands, like active men in haste, were reserved for the enterprise, while all those who lay down leisurely to drink were excluded. The former numbered no more than 300, and these were the appointed vanquishers of the huge host which covered the great plain (Judg. vii. 1-8).

The overheard relation of a dream, by which Gideon was encouraged (Judg. vii. 9-14), and the remarkable stratagem, with pitchers and torches, by which he overcame (ver. 15-23), are well known.

The routed Midianites fled towards the Jordan, but were pursued with great slaughter, the country being now roused in pursuit of the flying oppressor. The Ephraimites rendered good service by seizing the lower fords of the Jordan, and cutting off all who attempted escape in that direction, while Gideon himself pursued beyond the river those who escaped by the upper fords. Gideon crossed the Jordan a little below where it leaves the lake of Gennesareth, in pursuit of the Midianitish princes Zeba and Zalmunna. On that side the river, however, his victory was not believed or understood, and the people still trembled at the very name of the Midianites. Hence he could obtain no succour from the places which he passed, and town after town refused to supply even victuals to his fatigued and hungry, but still stout-hearted troop. He denounced vengeance upon them, but postponed its execution

till his return; and when he did return, with the two princes as his prisoners, he by no means spared those towns which, like Succoth and Penuel, had added insult to injury (Judg. viii. 4-17).

In those days captives of distinction taken in war were almost invariably slain. Zeba and Zalmunna had made up their minds to this fate; and yet it was Gideon's intention to have spared them, till he learned that they had put to death his own brothers under the same circumstances; upon which, as the avenger of their blood, he slew the captives with his own hand (Judg. viii. 18-21).

Among the fugitives taken by the Ephraimites were two distinguished emirs of Midian, named Oreb and Zeeb, whom they put to death. They took their heads over to Gideon, which amounted to an acknowledgment of his leadership; but still the always haughty and jealous Ephraimites were greatly annoyed that they had not in the first instance been summoned to the field; and serious consequences might have followed, but for the tact of Gideon in speaking in a lowly spirit of his own doings in comparison with theirs (Judg. vii. 14; viii. 4).

Gideon having thus delivered Israel from the most afflictive tyranny to which they had been subject since they quitted Egypt, the grateful people, and particularly the northern tribes, made him an offer of the crown for himself and his sons. But the hero was too well acquainted with his true position, and with the principles of the theocratical government, to accept this unguarded offer: 'I will not rule over you,' he said, 'neither shall my son rule over you: JEHOVAH, he shall rule over you.' He would only accept the golden ear-rings which the victors had taken from the ears of their slaughtered foes [EAR-RINGS]; and a cloth being spread out to receive them, the admiring Israelites threw in, not only the ear-rings, but other ornaments of gold, including the chains of the royal camels, and added the purple robes which the slain monarchs had worn, being the first indication of purple as a royal colour. The ear-rings alone weighed 1700 shekels, equal to 74 pounds 4 ounces, and worth, at the present value of gold, about 3300*l.* With this Gideon made an ephod, and put it in his city, even in Ophrah; and all Israel went thither a whoring after it; which thing became a snare unto Gideon and to his house.* An ephod, at least that of the high-priest, was an outer garment like a sleeveless tunic, to which was attached the oracular breast-plate, composed of twelve precious stones set in gold, and graven with the names of the twelve tribes. Another plainer description of ephod was worn by the common priests. The object of Gideon in making an ephod with his treasure is not very clear. Some suppose that it was merely designed as a trophy of Israel's deliverance: if so, it was a very strange one. It is more probable that as Gideon had, on his being first called to his high mission, been instructed to build an altar and offer sacrifice at this very place, he conceived himself authorized, if not required, to have there a sacerdotal establishment—for at least the tribes beyond the river—where sacrifices might be regularly offered. In this case the worship rendered there was doubtless in honour of Jehovah, but was still, however well intended, highly schismatical and irregular. Even in his lifetime it ~~was~~

have had the effect of withdrawing the attention of the people east of the Jordan from the Tabernacle at Shiloh, and thus so far tended to facilitate the step into actual idolatry, which was taken soon after Gideon's death. The probability of this explanation is strengthened when we recollect the schismatical sacerdotal establishments which were formed by Micah on Mount Ephraim, and by the Danites at Laish (Judg. xvii. 5-13; xviii. 29-31).

The remainder of Gideon's life was peaceable. He had seventy sons by many wives, and died at an advanced age, after he had 'ruled Israel' (principally the northern tribes and those beyond the river) for forty years: B.C. 1249 to 1209. He is mentioned in the discourse of Samuel (1 Sam. xii. 11), and his name occurs in Heb. xi. 32, among those of the heroes of the faith.

1. GIHON (גִּיחֹן; Sept. Γιών), a fountain near Jerusalem. The place outside the city to which the young Solomon was taken to be anointed king, was called Gihon, but its direction is not indicated (1 Kings i. 33, 38). Subsequently King Hezekiah 'stopped the upper water-course [or upper out-flow of the waters] of Gihon, and brought it straight down to the west side of the city of David' (2 Chron. xxxii. 30; xxxiii. 14). This was, perhaps, on occasion of the approach of the Assyrian army under Sennacherib, when, to prevent the besiegers from finding water, great numbers of the people laboured with much diligence in stopping the water of the fountains without the city, and in particular of 'the brook that ran through the midst of the land' (2 Chron. xxxii. 3, 4). The author of the book of Sirach (xlvi. 17) also states, that 'Hezekiah brought water into the midst of the city; he dug with iron into the rock, and built fountains for the waters.' The fountain of Gihon is also mentioned by Josephus. From a comparison of these passages the editor of the *Pictorial Bible* (on 2 Chron. xxxii.) arrived at the conclusion, since confirmed by Dr. Robinson (*Researches*, i. 313), that there existed anciently a fountain of Gihon, on the west side of the city, which was 'stopped' or covered over by Hezekiah, and its waters brought by subterranean channels into the city. Before that time it would naturally have flowed down through the valley of Gihon, and probably formed the brook which was stopped at the same time. 'The fountain may have been stopped, and its waters thus secured very easily by digging deep and erecting over it one or more vaulted subterranean chambers. Something of the very same kind is still seen in the fountains near Solomon's pools beyond Bethlehem, where the water rises in subterranean chambers, to which there is no access except down a narrow shaft like a well. In this way the waters of Gihon would be withdrawn from the enemy and preserved in the city, in which they would seem to have been distributed among various reservoirs and fountains.' From all these circumstances there seems little room to doubt that an open fountain, called 'the fountain of Gihon,' did anciently exist on the west of the city, the waters of which may still continue to flow by subterranean channels down to the ancient temple, and perhaps to Siloam. This fountain was probably near the present Upper Pool, in the valley west of Jerusalem. This Upper Pool is a large tank, which is

dry in summer, but in the rainy season becomes full, when its waters are conducted by a small rude aqueduct or channel to the vicinity of the Jaffa Gate, and so to the pool of Hezekiah within the city. (Comp. Robinson's *Researches*, i. 352, 512-514.)

2. GIHON; the name of one of the rivers of Paradise. [PARADISE.]

GILBOA (גִּלְבּוֹא; Sept. Γελβουά and Γελβοέ), a mountain memorable for the defeat of Saul by the Philistines, where his three sons were slain, and where he himself died by his own hand (1 Sam. xxviii. 4; xxxi. 1-8; 2 Sam. i. 6-21). The circumstances of the narrative would alone suffice to direct our attention to the mountains which bound the great plain of Esdraelon on the south-east, and are interposed between it and the Jordan valley. Here there are a number of ridges, with a general direction from north-west to south-east, separated by valleys running in the same direction. The largest of these valleys is the southernmost: it is a broad deep plain about two miles and a half wide, and leading direct into the Jordan valley. This is supposed to be distinctively (for the plain of Esdraelon is sometimes so called) the Valley of Jezreel. The mountains which bound it on the north appear to be those of Little Hermon; and the higher mountains which bound it on the south undoubtedly form Mount Gilboa. There is still, indeed, an inhabited village, in whose name of Jelbon that of Gilboa may be recognised.

GILEAD (גִּלְעָד; Sept. Γαλαάδ). 1. A group of mountains connected with Lebanon by means of Mount Hermon. It begins not far from the latter, and extends southward to the sources of the brooks Jabbok and Arnon, thus enclosing the whole eastern part of the land beyond the Jordan (Gen. xxxi. 21; Cant. iv. 1). According to Michaelis (*Mos. Recht*, i. 86), this mountain, which gave its name to the country so called, must be situated beyond the region sketched in our maps, and somewhere about the Euphrates.

Some difficulty has arisen as to its real situation from Judg. vii. 3, where it would appear that it lay on *this* side of the Jordan, in the plain of Jezreel. There is, however, no need of altering the reading of the text, as suggested by Le Clerc and Michaelis, since it merely implies that all those who should not feel inclined to prosecute the war against the Midianites farther than the mountain from which the latter had emerged, were at liberty to return home.

2. (a) The name of a large district beyond the Jordan, continually mentioned in the Scriptures in contradistinction to, or apart from, Bashan (Deut. iii. 13; Josh. xii. 5; xiii. 11; xvii. 1; 2 Kings x. 33; 1 Chron. v. 16; Mic. vii. 14); though, to judge from its geographical position (as given Num. xxxii. 26; Deut. iii. 12), it must have comprised the entire possessions of the two tribes of Gad and Reuben, and even the southern part of Manasseh (Deut. iii. 13; Num. xxxii. 40; Josh. xvii. 1-6). The cities Ramoth, Jabosh, and Jazer, are usually designated as lying in Gilead.

This region was distinguished for its rich products (Num. xxxii. 1) and aromatic simples; from which latter different sorts of balsam were prepared—facts confirmed by modern travellers

(Seetzen, Burckhardt, &c.), with the addition that the whole region is covered with groups of limestone mountains, intersected by fertile valleys.

(b) The name of the whole eastern part of the Jordan (Deut. xxxiv. 1; comp. 2 Kings x. 33; Judg. xx. 1).

The name *Gilead* continued to be used, in a general and geographical sense, even after the exile (1 Macc. v. etc.). Josephus (*Antiq.* xiii. 13. 5) designates it as a part of Arabia, while its special and topographical name was *Peræa*.

3. A city of this name is apparently mentioned Hos. vi. 8; so, at least, it is given in most of the ancient and modern versions, though the meaning may only be that Gilead is (like) a city full of iniquity, *i. e.* a union of iniquitous people.—

E. M.

1. GILGAL (גִּלְגָּל; Sept. Γάλαλα), the place where the Israelites formed their first encampment in Palestine, and which continued for some time to be their head-quarters while engaged in the conquest of the land (Josh. iv. 19, 20; ix. 6; x. 6, 7, &c.). It was here that they set up the twelve stones which they took out of the bed of the Jordan (iv. 19), which another head will bring under consideration [STONES]. Samuel used to visit Gilgal in his annual circuit as a judge; and here there was a school of the prophets (1 Sam. vii. 16; 2 Kings iv. 38). There is no notice of the place after the Captivity. Indeed, it does not seem that the name belonged at first to a town, although Gilgal eventually became an inhabited place. It appears to have been early abandoned, and Josephus does not seem to mention it as existing in his time. This writer places it on the east border of Jericho, ten stadia from that city, and fifty from the Jordan (*Antiq.* v. 1, 4, 11). From this it would seem to have been in the vicinity of the present village of the pseudo-Jericho, Riha, which is about the assigned distance from the river. No trace of the name or site can now be discovered.

2. GILGAL, a place in the region of Dor, whose king was subdued by Joshua (Josh. xii. 23). The Gilgal of Neh. xii. 29, and 1 Macc. ix. 2, is probably the same as this; as well as the ancient Galgala, which Eusebius and Jerome place six Roman miles north of Antipatris. In this neighbourhood there is still a village called Jiljuleh, which probably represents the ancient site.

GIRDLE. [ABNET; ARMOUR; DRESS.]

GIRGASHITES (גִּרְגָּשִׁי; Sept. Γεργασαῖοι), one of the families of Canaan, who are supposed to have been settled in that part of the country which lay to the east of the Lake of Genesareth. This conclusion is founded on the identity between the word Γεργασαῖοι, which the Septuagint gives for Girgashites, and that by which Matthew (viii. 28) indicates the land of the Gergesenes. But as this last reading rests on a conjecture of Origen, on which little reliance is now placed [GADARA], the conclusion drawn from it has no weight, although the fact is possible on other grounds. Indeed, the older reading, 'Gerasenes,' has sufficient resemblance to direct the attention to the country beyond the Jordan.

The Girgashites are conjectured to have been a part of the large family of the Hivites, as they are omitted in nine out of ten places in which the nations or families of Canaan are mentioned,

while in the tenth they are mentioned, and the Hivites omitted. Josephus states that nothing but the name of the Girgashites remained in his time (*Antiq.* i. 6. 2). In the Jewish Commentaries of R. Nachman, and elsewhere, the Girgashites are described as having retired into Africa, fearing the power of God; and Procopius, in his *History of the Vandals*, mentions an ancient inscription in Mauritania Tingitana, stating that the inhabitants had fled thither from the face of Joshua the son of Nun. The fact of such a migration is not unlikely; but we have very serious doubts respecting the inscription, mentioned only by Procopius, which has afforded the groundwork of many wonderful conclusions; such, for instance, as that the American Indians were descended from these expelled Canaanites. The notion that the Girgashites did migrate seems to have been founded on the circumstance that, although they are included in the list of the seven devoted nations either to be *driven out* or destroyed by the Israelites (Gen. xv. 20, 21; Deut. vii. 1; Josh. iii. 10; xxiv. 11), yet they are omitted in the list of those to be utterly destroyed (Deut. xx. 17), and are mentioned among those with whom, contrary to the Divine decree, the Israelites lived and intermarried (Judg. iii. 1-6).

GITITES (גִּתִּי; Sept. Γεθαῖοι), inhabitants or natives of Gath (Josh. xiii. 3). Obed-edom, although a Levite, is called a Gittite (2 Sam. vi. 10), possibly because he had been with David when at Gath, but much more probably from his being a native of Gath-rimmon, which was a city of the Levites. There seems no reason for extending this interpretation to Ittai (2 Sam. xv. 19), seeing that David expressly calls him 'a stranger' (foreigner), and, what is more, 'an exile.' He was at the head of 600 men, who were also Gittites, for they are called (ver. 22) his 'brethren.' They appear to have formed a foreign troop of experienced warriors, chiefly from Gath, in the pay and service of David; which they had perhaps entered in the first instance for the sake of sharing in the booty obtainable in his wars. We can conceive that the presence of such a troop must have been useful to the king in giving to the Hebrew army that organization and discipline which it did not possess before his time. As natives of Gath they were of course Philistines, and the Philistines were beyond comparison the best soldiers in Palestine; and although they were nationally enemies of Israel, it is easy to conceive various partial influences which might have drawn a troop of them into the service of the most renowned general and successful warrior of their time.

GITITH, a word which occurs in the title of Ps. viii., lxxxi., lxxxiv. [PSALMS].

GLASS, according to Pliny (*Hist. Nat.* xxxvi. 26), was discovered by what is termed accident. Some merchants kindled a fire on that part of the coast of Phœnicia which lies near Ptolemais, between the foot of Carmel and Tyre, at a spot where the river Belus casts the fine sand which it brings down; but, as they were without the usual means of suspending their cooking vessels, they employed for that purpose logs of nitre, their vessel being laden with that substance: the fire fusing the nitre and the sand produced glass. The Sidonians, in whose vicinity the discovery was

made, took it up, and having in process of time carried the art to a high degree of excellence, gained thereby both wealth and fame. Other nations became their pupils; the Romans especially attained to very high skill in the art of fusing, blowing, and colouring glass. Even glass mirrors were invented by the Sidonians—*etiam specula excogitaverant*. This account of Pliny is in substance corroborated by Strabo (xvi. 15), and by Josephus (*De Bell. Jud.* ii. 9). Yet, notwithstanding this explicit statement, it was long denied that the ancients were acquainted with glass properly so called; nor did the denial entirely disappear even when Pompeii offered evidences of its want of foundation. Our knowledge of Egypt has, however, set the matter at rest—showing at the same time how careful men should be in setting up mere abstract reasonings in opposition to the direct testimony of history. Wilkinson, in his *Ancient Egyptians* (iii. 88, sq.), has adduced the fullest evidence that glass was known to and made by that ingenious people at a very early period of their national existence. Upward of 3500 years ago, in the reign of the first Osirtasen, they appear to have practised the art of blowing glass. The process is represented

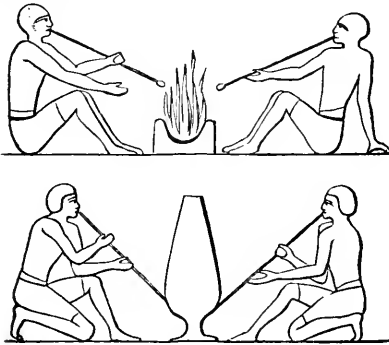

327.

in the paintings of Beni Hassan, executed in the reign of that monarch. In the same age images of glazed pottery were common. Ornaments of glass were made by them about 1500 years B.C.; for a bead of that date has been found, being of the same specific gravity as that of our crown glass. Many glass bottles, &c. have been met with in the tombs, some of very remote antiquity. Glass vases were used for holding wine as early as the Exodus. Such was the skill of the Egyptians in this manufacture, that they successfully counterfeited the amethyst, and other precious stones. Winckelmann is of opinion that glass was employed more frequently in ancient than in modern times. It was sometimes used by the Egyptians even for coffins. They also employed it, not only for drinking utensils and ornaments of the person, but for Mosaic work, the figures of deities, and sacred emblems, attaining to exquisite workmanship, and a surprising brilliancy of colour. The art too of cutting glass was known to them at the most remote periods; for which purpose, as we learn from Pliny (*Hist. Nat.* xxxvii. 4), the diamond was used. That the ancients had mirrors of glass is clear from the above cited words of Pliny; but the mirrors found in Egypt are

made of mixed metal, chiefly copper. So admirably did the skill of the Egyptians succeed in the composition of metals, that their mirrors were susceptible of a polish which has been but partially revived at the present day. The mirror was nearly round, having a handle of wood, stone, or metal. The form varied with the taste of the owner. The same kind of metal mirror was used by the Israelites, who, doubtless, brought it from Egypt. In Exod. xxxviii. 8, it is expressly said that Moses 'made the laver of brass of the looking-glasses (brazen mirrors) of the women.'

It would be justifiable to suppose that the Hebrews brought glass, and a knowledge how to manufacture it, with them out of Egypt, were not the evidence of history so explicit that it was actually discovered and wrought at their own doors. Whether it was used by them for mirrors is another question. That glass, however, was known to the Hebrews appears beyond a doubt. In Job xxvii. 17, זְכוּרִית is believed to mean glass, though it is rendered 'crystal' in the English version; a substance, in Winer's opinion (*Handwörterbuch*), signified by נְבִישׁ, which occurs in the ensuing verse, while the former is the specific name for glass. In the New Testament the word employed is *υαλος* (compare Aristoph. *Nubes*, 768). In Apoc. xxi. 18, we read 'The city was pure gold, like unto clear glass;' ver. 21, 'as it were transparent glass' (compare c. iv. 6). 'Molten glass' also occurs in Job xxxvii. 18, but the original נָר, and its corresponding word in Exod. xxxviii. 8, authorize the translation 'mirror'—that is of some metal. Indeed Winer, referring to Beckman (*Beiträge zur Gesch. der Erfindung*, iii. 319), expressly denies that glass mirrors were known till the thirteenth century—adding that they are still seldom seen in the East. Mirrors of polished metal are those that are mostly used, formed sometimes into such shapes as may serve for ornaments to the person. In the East mirrors had a connection with the observances of religion; females held them before the images of the goddesses, thereby manifesting their own humility as servants of the divinities, and betokening the prevalence in private life of a similar custom (Callimach. *Hymn. in Pallas*. 21; Senec. *Ep.* 95; Cyril, *De Adorat. in Spir.* ii. 64). That in the New Testament a mirror is intended in James i. 23, 'beholding his natural face in a glass,' appears certain; but the signification of the other passage in which the word *εσοπτρον* occurs, is by no means so clear. If by *εσοπτρον* a metal mirror is to be understood, the language employed is not without difficulties. The preposition *διά*, 'through,' is in such a case improper; 'face to face' presents an equally improper contrast, for in a mirror 'face answers to face' (Prov. xxvii. 19). So the general import of the passage seems to require a medium, and an imperfectly transparent medium, through which objects are beheld. This is confirmed by the words *εν ανιγματι, εν ενιγμας*, that is, with the meaning hidden or involved in outward coverings: in this state objects are seen mediately, not immediately (see the passages quoted by Wetstein); in the next the veil will be removed, and we shall see them as they are, as when two persons behold each other with no substance intervening. Hence the rendering in the common version appears not unsuitable, and the statement of the Apostle corresponds with

fact and experience; for it is obscurely, as through a dim medium, that we see spiritual objects. What the precise substance was which the Apostle thought of when he used the words it may not be easy to determine. It could not well be ordinary glass, for that was transparent. It may have been the *lapis specularis*, or a kind of talc, of which the ancients made their windows. This opinion is confirmed by Schleusner, who says that the Jews used a similar mode of expression to describe a dim and imperfect view of mental objects (Schottgen. *Hor. Heb.* in loc.) See Michaelis, *Hist. Vitri ap. Heb.* in *d. Comment. Soc. Goetting.* iv. 57; and Dr. Falconer on 'the knowledge of the ancients respecting Glass,' in the *Memoirs of the Lit. and Phil. Soc. of Manchester*, ii. 96.—J. R. B.

GLEDE (Deut. xiv. 13) is an obsolete name for the common kite, adopted in our version for רַחֵם *raah*, or, as Gesenius thinks, דָּאָה *daah*, there being a slight mutation in the initial letter of the word (comp. the parallel passage in Lev. xi. 14). The Septuagint renders it by γύψ, and the Vulgate by *milvus*. It has by some been taken for *Pernopterus*, noticed under RACHAM; and having there shown the species referred to Racham, in the uncertainty which here appears insurmountable, we can have recourse only to the very unsatisfactory inference that may be drawn from the root whence *raah* or *daah* may be derived. Etymologists agree to connect it with velocity or rapidity of flight; and that quality agrees perfectly with the Greek and Vulgate versions, for the kite has, in comparison with its bulk, very long wings, and a forked tail extending beyond them. It is a species that rises to a towering height, hangs apparently motionless in the sky, and darts down with immense velocity; but the legs and claws being weak, it is

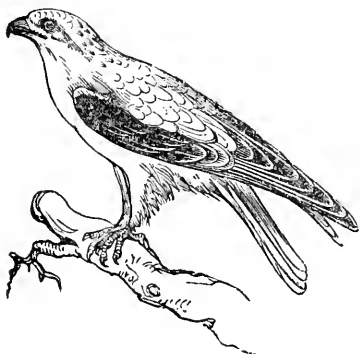

328. [*Milvus Ater.*]

cowardly, and feeds upon carrion, fish, insects, mice, and small birds. About Cairo kites are particularly abundant, mixing with the carrion vultures in their wheeling flight, and coming in numbers to the daily distribution of food awarded them. But the question whether the kite of Europe and that of Egypt are the same species, is not decided, though there is no want of scientific names for both species found in the valley of the Nile; one of which is certainly distinct from the European, and the other, if not so, is still a strongly marked variety. We find it noticed in various stages of

plumage, as *Milvus Ictinus*, *Milvus Etolius*, Savigny; *Falco Aegyptiacus* and *Falco Forskahlia*, Gmel.; *Falco cinereo-ferrugineus*, Forskahl; *Falco Arda*, Savigny; probably, also, *Falco parasiticus*, Lath. The bill of this species is dark; head and throat whitish, with brown streaks; body above dark grey brown, pale ferruginous below; tail but slightly forked; legs yellow. It is found in hieroglyphic paintings, coloured with sufficient accuracy not to be mistaken. The other species, which we figure above as *Milvus ater*, is the black kite, *Falco melanopterus*, Daudin; *Elanus Cæsius*, Savigny; *Falco Sominensis*, Lath.; *Le Blac*, Le Vaill, and *Kouhieh* of the Arabs. It has the head, neck, and back dark rusty grey; scapulars bordered with rusty; wing-coverts and primaries black, the last-mentioned tipped with white; tail rusty grey above, white beneath; bill dark; legs yellow. The manners of both species are much the same: it is likely that they are equally abundant at Cairo, and spread into Palestine. [HAWK.]—C. H. S.

GLORY, in the English Version, represents the words כְּבוֹד and δόξα. The Hebrew, כְּבוֹד, 'to be heavy,' is susceptible of the various *analogical* meanings which are derived from its root, viz. 'to be hard,' 'honoured,' 'rich,' &c. In Gen. xxxi. 1, 'all this glory'; Isa. x. 3, 'your glory'; lvi. 12, 'the glory of the Gentiles,' it means *wealth, abundance*. Ps. lxxix. 9, 'the glory of thy name,' i. e. *honour, reputation*. Isa. xxxv. 2; lx. 13, comp. x. 18, 'the glory of Lebanon,' i. e. *ornament*. Isa. viii. 7, 'the king of Assyria and all his glory,' is rendered by Lowth 'and all his force.' In some passages it conveys the ideas of the ancients respecting the bodily seat of certain passions. Among others, they thought *the liver* to be the seat of *anger and love*. Thus Horace (*Carm.* i. 13. 4), describing jealous anger or resentment—*Fervens difficili bile tumet jecur*,—'My burning liver swells with angry bile' (see notes of the Delphin edition. Comp. Persius, *Sat.* v. 129; Juvenal, *Sat.* vi. 647). Thus Ps. xvi. 9, 'My heart is glad and' כְּבוֹדִי, literally, 'my liver rejoiceth.' Gen. xlix. 6, 'mine honour' is rendered by Sept. τὰ ἡπαρὰ μου, 'my liver.' Lam. ii. 11, is literally rendered by our translators 'My liver is poured upon the earth,' indicating *violent grief*. 'To be heavy' is the *primary* meaning of the root; hence כְּבוֹד means 'the liver,' the *heaviest* of all the viscera; just as the lungs, the *lightest* of all, are in our language called *the lights* (Taylor's *Heb. Concord.*). In some instances the literal rendering of the Hebrew idiom in our version is attended with obscurity. I Sam. ii. 8, 'throne of glory' is 'a glorious throne.' Ps. xxiv. 7, 8, 'the king of glory' is 'the glorious or majestic king.' Ps. xxix. 3, 'the God of glory' is 'the glorious God,' and is so rendered in the Prayer-book version. In the New Testament, Luke ii. 9, 'the glory of the Lord snot,' is *an extreme splendour* (see also Acts vii. 2). In 1 Cor. ii. 8, 'Lord of glory' is 'glorious or illustrious Lord.' Rom. viii. 8, 'spirit of God' and 'spirit of Christ,' are 'a godly and Christian spirit, temper, or disposition.' *Remarkable events* are a well-known cause of the introduction of *new* words or *new senses* of words. The *appearances* of what is termed יהוה *יהוה*, כְּבוֹד יהוה, 'the glory of Jehovah,' Sept. δόξα Κυρίου, 'the Shechinah of the

Rabbins, so often referred to in the Old Testament, seem to have originated certain uses of the word, in the sense of *light*, and *visible splendour*, and numerous applications of these senses among the Hellenistic writers. It is first *distinctly* called by this term in Exod. xvi. 7, 10. It is described as being like a *bright fire* (Exod. xxiv. 17), and as *attended* with a cloud, Exod. xl. 34, 35. It is probable that the *tradition* of these phenomena influenced the representations of heathen poets, who so often describe the appearances of the deities as attended by a cloud, with a brightness in it (see Taubmann's *Notes on Virgil*). It is believed that the classical Greek writers never use δόξα in the sense of *light* or *splendour*. The nearest instance yet adduced is from Plutarch (*Nicias*, tom. i. p. 538, E), who speaks of Πλάτωνος ἐκλάμψασα δόξα, 'the glory of Plato shining forth.' It answers very frequently, in the Sept., to כבוד (Exod. xxiv. 17, 40; xxxiv. 35; Deut. v. 24, &c.) down to the Captivity. The following instances are offered of the Hellenistic uses, allusions, or applications of the word, *originated* by the events above mentioned:—Matt. vi. 29, 'Solomon in all his *glory*;' i. e. *visible* magnificence, as opposed to the *clothing*, called 'array' of the lilies. 1 Cor. xv. 41, 'the *glory*, i. e. *lustre*, of the sun, moon, and stars.' Jesus is called, Heb. i. 3, ἀπαύγασμα τῆς δόξης, 'the effulgence of his (the Father's) *glory*,' an evident allusion to Ezek. x. 4. Rom. i. 23, 'the *glory* of God' is 'the glorious *form* of God.' 2 Thes. i. 9, 'the *presence* of the Lord and the *glory* of his power.' 1 Tim. vi. 16, 'dwelling in *light*.' 1 Cor. xi. 7, 'man is the image and *glory* of God,' metonym. that which *exhibits* or *reflects* this *glory*, i. e. *symbol*, *demonstration*. Other events would also conduce to such peculiar uses of the word as the *shining of the face of Moses* (comp. Exod. xxxiv. 29; 2 Cor. iii. 7, 8; iv. 6); the splendour attending the *appearance of angels*, especially in later ages (Matt. xxviii. 3, &c.); the *transfiguration of Jesus*, in which it is said that Peter, James, and John, saw his *glory* (Luke ix. 32; comp. John i. 14; 2 Pet. i. 17, 19. See Macknight on Phil. iii. 21). And since the appearances, &c. alluded to, are connected with the Deity, the Saviour, angels, &c., the same word is also *consistently* adopted to denote the *participation* in the *glory* and *blessedness* of these beings which is reserved for the faithful. Col. iii. 4, 'appear with him in *glory*.' 2 Cor. iv. 17, 18; 2 Thess. ii. 14, 'the obtaining of the *glory* of our Lord Jesus Christ.' These senses of the word originated in the events recorded in the Scriptures, and are consequently confined to the writers of Scripture, or to those writers who adopted their ideas and language. For the *ordinary* senses and applications of the word, reference must be made to the Biblical Lexicons, as Robinson's, by Bloomfield; Parkhurst's, by H. J. Rose, &c.—J. F. D.

GNAT (κάνωψ; Vulg. *culex*; Order, *diptera*, Linn., *culicidae*, Latr.; occurs Matt. xxiii. 24). The common gnat scarcely yields to any insect in regard to the interesting facts which it presents to the naturalist. The following *outline* will recall the chief of them to the reader:—The boat-shaped *raft of eggs*, which the parent gnat forms, and leaves upon the water, so admirably constructed, that, though hollow, it neither becomes filled with water, nor sinks even under the tor-

rents of a thunder-shower; the aquatic *larva*, breathing, head downwards, through its *tufted spiracle*; its *hook* with which it seizes the animalcules on which it feeds; the variations and even *reverses of structure* it undergoes in the *pupa* state, now swimming, head *upwards*, by means of its finlike tail, and breathing through spiracles placed behind the *head*; the amazing transformation it undergoes when raising its shoulders out of the water, and upon the bursting of the skin which had enveloped them, the *perfect insect* emerges, its former covering now serving as a life-boat during those few critical moments while it disengages and trims its wings for flight, and commences its existence a winged creature in a new element, and instantly begins to suck the juices of animals or vegetables, while 'its shrill horn its fearful 'larum rings'; the complicated mechanism of its *tube*, which serves the purposes both of lancet and cupping-glass, and of inserting a fluid for liquefying the blood, and making it flow more freely. The various organs, comprehended in so small a structure, excited the wonder of Pliny (*Hist. Nat.* xi. 2), and attracted the notice of Socrates, as we learn from his poetical adversary Aristophanes (*Nubes*, 158); but the further discoveries of the microscope raise our wonder into a still higher principle. What has been said of the naturalist generally, is peculiarly true of him when examining this subject—*dum studet, orat.* 'I dare boldly affirm,' says Swammerdam, 'that the incomprehensible greatness of Deity manifests itself in these mysterious operations in a particular manner, and affords an opportunity of examining, as it were with our senses, the Divine nature,' p. 2. 51. The word *κάνωψ* seems to be the *generic* term for the gnat among the ancient Greek writers, under which they included several *species*, as we use the word 'fly,' and 'the fly;' though they give distinct names to some species, as the word *σέπφος*, &c. Rosenmüller observes that the *κάνωπες* of the Greeks seem to be the *ephemera* of Linnæus (apud Bochart, vol. iii. p. 444, 4to., Leips. 1793-6). Aristotle gives the name to a species whose larvæ are bred in the lees of wine, which is then called the *culex vinarius* (*Hist. An.* 5. 19). Pliny also refers to various species of gnats: 'varia sunt culicum genera' (*Hist. Nat.* xi. 35). 'Alii ex ficibus, ficarii dicti' (ibid.). Alii ex aceto nascuntur' (ibid.). 'Sunt etiam qui vocantur muliones. Alii centrina' (xvii. 27). We ourselves recognise several kinds under the common name, as gall gnats, horse, wheat, winter (see also Linn. *Syst. Nat.* Diptera, Culex). Our Saviour's allusion to the gnat is a kind of proverb, either in use in his time, or invented by himself; 'Blind guides, who strain out a gnat, and swallow down [bolt, as we say] a camel.' He adopts the antithesis of the *smallest insect* to the *largest animal*, and applies it to those who are superstitiously anxious in avoiding small faults, yet do not scruple to commit the greatest sins. The typographical error, 'strain at a gnat,' first found its way into King James's translation, 1611. It is 'strain out' in the previous translations. The custom of filtering wine, among the Jews, for this purpose, was founded on the prohibition of 'all flying, creeping things' being used for food, excepting the *saltatorii* (Lev. xi. 23). The custom seems alluded to by the Sept., which, in Amos vi. 6, reads διυλομενον

σίλον, 'filtered wine'—a passage having a similar scope. According to the Talmud, eating a gnat incurred scourging or excommunication. It is considered that the means adopted in ancient times to avoid the molestation of gnats, originated our English word *canopy*, from *κωνοπέδιον*, a bed with hangings of gauze to keep off gnats, or the gauze-net itself. It occurs in the Apocrypha (Judith x. 21), and elsewhere. In such a litter was Cleopatra carried to the battle of Actium (Horace, *Epod.* ix. 11). A curious speculation has lately been advanced respecting the use of *net-work*, found in a passage in Herodotus, which had heretofore baffled explanation. He says (ii. 96) that 'the people living in the marshy parts of Egypt sleep in lofty towers, to avoid the gnats, but that they also reside near the marshes, substitute a *net* with which the man catches fish in the day, and makes the following use of it at night :—Around and over the bed he sleeps on he casts the *net*, creeps under, and lays himself down. The gnats, *κώρωτες*, which, even if he was to wrap himself in a linen cloak when in bed, would bite through all, do not so much as even try the *net*.' Now the use of retreating to *towers* to avoid gnats could be understood, because it is well known that gnats never fly beyond a certain height. The modern Egyptians also sleep on the roof of their houses for the same purpose. Wilkinson (ii. 122) gives a drawing of an ancient Egyptian house, with a tower rising above the terrace-roof. Such an addition is also common in modern houses (Shaw's *Travels*, p. 214). But the efficacy of the *net-work* has been rendered *credible* by a statement of Mr. Spence to the Entomological Society—that the *house-fly* will not enter a window across which a *net* or even *lines of thread* are drawn (*Transact. Entomolog. Soc.* vol. i. p. 8, &c., 1834). If the *gnats* have a similar objection, then this may be regarded as an additional instance of the accuracy of Herodotus, when he relates things he actually observed, having been elucidated by modern discoveries (Vorstius, *De Adagiis*, N. T., p. 771, ed. Fischer; Kirby and Spence, *Introduct. to Entomology*; Bæliani *Spicileg.*; Grief, *Oraculum Christi contra percolantes culicem*, &c., Leips. 1749).—J. F. D.

GNOSTICISM. In the whole history of the human mind there is not a more instructive chapter, at once strange and sad, interesting to our curiosity and mortifying to our pride, than the history of Platonism sinking into Gnosticism, or, in other words, of Greek philosophy merging in Oriental mysticism; showing, on the one hand, the decline and fall of philosophy, and, on the other, the rise and progress of syncretism. Perhaps, also, it is the most remarkable instance on record, that out of the religious, moral, and political, in one word, the intellectual corruption which brings on the fall of great and mighty nations (so it doubtless was with Babylon and Thebes, and so we know it to have been with Athens and Rome), God's providence educes purer principles and higher hopes for the nations and people that rise out of their ashes, and who, if they will be taught wisdom and principle, righteousness and peace, by the errors and sufferings of those who have preceded them, may rise to higher destinies in the history of man's conduct and God's providence.

In the Bampton lectures of Dr. Edward Burton,

late Regius Professor of Divinity at Oxford, Gnosticism is attributed principally to the writings of Plato, as studied at Alexandria. Though the wisdom of Egypt may have influenced the Greeks and Romans through the mysticism of Pythagoras, though the Oriental doctrines of Babylon may have made their way amongst the Jews both of Jerusalem and Alexandria by means of *Æsir* Cabbala and Talmuds, and though some sects of declared Gnostics may have gone still more directly to the metaphysical, or rather mystical, genealogies of the Eastern Magi, still it is the opinion of Dr. Burton that it was the Greek writings of Plato which gave the extraordinary impulse of their genius, and, if we may use the word, of their fashion, to the lost writings of the Gnostics, as well as to those which remain to us of Philo and Plotinus; in a word, that Platonist, Philonist, and Gnostic, are but emanations at different distances from the Gnosis of Plato, though they have drawn so deeply from some fountains from which Plato drew more sparingly, and with far better taste, as to have muddied the clearer stream, and darkened the purer light which they derived primarily from the writings of Plato.

The character, learning, and station of Dr. Burton, the years of study he is known to have devoted to this subject, the judicious moderation with which he has spoken of the fathers, the general fairness and ability with which he has examined his authorities, the mass of valuable information he has accumulated in his notes, and, lastly, the ably reasoned theory which he has brought forward in his lectures, entitle his opinions on this subject to great attention. It is our purpose, therefore, in our present article on Gnosticism, as well as in the article upon the Logos, which may be considered a continuation of the subject, to give such a series of extracts from Dr. Burton's lectures, with references to some of the most valuable passages in his notes, as may bring his opinions, and the facts on which he grounds them, most fairly before the reader, adding at the close of each article such remarks as may have occurred to us. We take this course, as it does not seem quite honourable towards a great scholar and divine to present his thoughts in our own words (as Professor Matter, in his clever and agreeable work *Histoire Critique du Gnosticisme*, appears to us to have practised a little too much towards the learned and profound work of his great countryman Beausobre); nor, lastly, is it wise in one who is seeking to establish truth to diminish one jot or one tittle from a great authority. And, let us add, that a writer who has on the whole been so fair to his fellow labourers, to Beausobre, Mosheim, and Brucker, to Irenæus and Ittigius, as Professor Burton has been in his criticisms and acknowledgments, deserves himself to be had in remembrance, and not to be obscured in the works of those who have borrowed from him.

Dr. Burton states the object of his course to be 'to consider the heresies which infested the church in the lifetime of the apostles,' that is, as he afterwards shows, 'during the first century of the Christian era; for it seems certain that St. John survived the rest of the apostles, and the death of St. John, according to every account, very nearly coincided with the commencement of the second

century.' Respecting the probability of our finding traces of heresies in the New Testament, Dr. Burton remarks, 'If false doctrines were disseminated in the church while the apostles were alive, it is at least highly probable that they would allude to them in their writings.' He then proceeds to quote texts which clearly prove 'the existence of heresies in the days of the apostles themselves' (1 Cor. xi. 19; Gal. v. 20; Titus iii. 10; 1 John ii. 18, 19; Coloss. ii. 8; 1 Tim. vi. 20, 21; Rev. ii. 6, 15; 2 Tim. xvii. 18; 1 Tim. i. 19, 20; 2 Tim. i. 15; 3 John, ver. 9). After tracing the term heresy through its successive meanings to the present times, he adds, 'In the course of these lectures I shall speak of the heresies of the apostolic age in the sense which was attached to the term by the early fathers; and all that I wish to be remembered at present is, that the term is not to be understood according to modern ideas' (*i. e.* as limited to heterodoxies about the Trinity), 'but that an heretic is a man who embraces any opinion concerning religion, that opinion not being in accordance with the faith of the Gospel.' Why heresies were allowed to arise so early, and to spread their roots so deep and wide, Professor Burton presumes not to answer; but he quotes 1 Cor. xi. 19 as pointing out one of the principal good effects to be produced by such a trial of the Christian's faith. Approaching still nearer to his main subject, he adds, 'It will appear in the course of these lectures, that many persons who were called heretics in the first and second centuries had little or nothing in common with Christianity. They took such parts of the Gospel as suited their views or struck their fancy; but these rays of light they mixed up and buried in such a chaos of absurdity, that the apostles themselves would hardly have recognised their own doctrines. Such were most of the heresies in the lifetime of the apostles; and when we come to consider the state of philosophical opinion at that period, we shall cease to wonder that the fathers speak of so many heresies appearing in the lifetime of the apostles.'

Having thus glanced at the peculiar character of the heresies, or rather of the heresy, of which he is about to give an account, Dr. Burton proceeds to attribute its early prevalence, and the consequent errors it introduced into the religion of so many Christian converts, to the length of time (fifteen years) which Dr. Burton states to have elapsed between the conversion of St. Paul and his first journeying and preaching in Cilicia, Phrygia, Macedonia, Athens, and Corinth; during the latter part of which journey, namely whilst he was at Corinth, he appears to have written the earliest of his Epistles—the first Epistle to the Thessalonians. 'It appears, therefore, that seventeen years elapsed between the first promulgation of the Gospel and the date of the earliest writing which has come down to us. Those Epistles from which most evidence will be drawn concerning the early heresies, were written several years later; and I am speaking greatly within compass in saying, that the accounts which we have of heresies in the first century, are taken from documents which were written twenty years after the first promulgation of the Gospel. I have said that this fact is not always borne in mind by persons who are considering the events of the first century; and yet this period is unquestionably the most important

which ever has occurred in the annals of mankind.' In a subsequent passage he remarks, respecting the period in question, 'If it had not been for an incidental expression of St. Paul in his Epistle to the Galatians we should never have known that he passed three years in Arabia immediately after his conversion, nor that fourteen more years elapsed before the end of his first journey. Whether he passed the greater part of this period in his native city, Tarsus, and what was the nature of his occupation, we seek in vain to learn. We could hardly conceive that the chosen Apostle of the Gentiles would be inclined or permitted to delay the great work to which he had been called, nor would it be easy to imagine that the other Apostles were idle in spreading that Gospel which they had been so solemnly ordered to preach amongst all nations. The death of St. James, and the imprisonment of St. Peter, by order of Herod, prove that they were not idle, and that the Gospel made its way. But still it was not till fourteen years after our Lord's ascension that St. Paul travelled for the first time, and preached the Gospel to the Gentiles. Nor is there any evidence that during that period the other Apostles passed the confines of Judæa.'

Professor Burton proceeds as follows with his very striking argument: 'During the time when we have supposed the Apostles to have confined themselves to Judæa, the Gospel was making rapid progress in several parts of the world. This is the point to which I now wish to direct your attention, and particularly to the fact that this progress was without co-operation and control of the Apostles: which may itself be sufficient to furnish a reason for the appearance of so many heresies, and for such strange corruptions of Christianity in those early times.' He then marks, by quotations from the New Testament, the times and places when and where the Gospel must have been spread by those first converts whose accounts of what they had heard and seen preceded by so many years the journeyings and preachings of the Apostles (John xii. 20, 21; Acts ii. 9, 11; viii. 1; xi. 19), and concludes with the following summary of his argument: 'The Acts of the Apostles leave St. Paul at Tarsus, in the third year after his conversion (Acts ix. 30); and ten years afterwards we find him still at Tarsus, when Barnabas went thither, and brought him to Antioch. During this period the Gospel was making its way in many parts of the three quarters of the world, though as yet one of the Apostles had travelled beyond Judæa and when we come to consider the state of philoecopy at that time, and the fashion which prevailed of catching at any thing new, and of uniting discordant elements into fanciful systems, we shall not be surprised to find the doctrines of the Gospel disguised and altered, and that according to the language of that age many new heresies were formed.'

Professor Burton closes this striking view of the first progress of the Gospel through the reports of those who were not its authorized teachers, by pointing out what must have been the effect of such a state of things in Rome, Corinth, and Galatia; and then shows that the argument applies *a fortiori* to places which had not the teaching of the Apostles to correct this evil till a later time. 'How much more,' says he, 'must this have been the case in places which the Apostle

did not visit so soon, and where, as in Rome, the Gospel made its way for five-and-twenty years, with nothing but the zeal of individuals to spread it, and subject to all the fancies which those individuals might adopt.'

The greatest danger to which Christianity under such circumstances was exposed arose from that great Gnostic Heresy, which was long the rival, and too often the corrupter, of its purer doctrines. Simon Magus is considered by Professor Burton to have been the leader of that large division of the Gnostics who attempted to unite Gnosticism with Christianity; and the learned professor has attempted the somewhat difficult task of reconciling with the truth, and with one another, the strange accounts of this Heresiarch told by the Fathers. When we remember the obscure claims of one Euphrates, surnamed Persicus, to be the Father of Gnosticism, which have been advocated by Mosheim, it will appear most probable in itself, and most exculpatory of the Fathers, to consider both these personages to have been regarded in much the same light by some of the Fathers as *Æolus* and *Dorus* are now considered in the history of the Greek tribes; and that their learned ingenuity, not unmingled with something of the *odium Theologicum*, was let loose from all restraints, not so much against the real Simon of the Scriptures, as against Magus, who also might have been called Persicus. The other heresiarchs, Menander and his disciples Basilides and Saturninus, and afterwards Marcion and Valentinus, were in their turn leaders of the great Gnostic heresy, to which also Cerinthus belonged (to combat whose opinions St. John is said to have written his Gospel), as did the early sect of the Nicolaitans. 'When the reader of ecclesiastical history,' continues Dr. Burton, 'comes to the second century, he finds it divided into schools, as numerous and zealously attended as any which Greece or Asia boast in their happiest days. He meets with names totally unknown to him before, which excited as much sensation as those of Aristotle and Plato. He hears of volumes having been written in support of this new philosophy, not one of which has survived to our own day. His classical recollections are roused by finding an intimate connection between the doctrine of the Gnostics and of Plato: he hears of Jews who made even their exclusive creed bend to the new system: and what interests him most is, that in every page he reads of the baneful effect which Gnosticism had upon Christianity, by adopting parts of the Gospel scheme, but adopting them only to disguise and deform them.'

The following extracts contain Professor Burton's view of the Gnostic doctrines, with some remarks on the sources from which they were derived:—

'In attempting to give an account of these doctrines, I must begin with observing, what we shall see more plainly when we trace the causes of Gnosticism, that it was not by any means a new and distinct philosophy, but made up of selections from almost every system. Thus we find in it the Platonic doctrine of ideas, and the notion that every thing in this lower world has a celestial and immaterial archetype. We find in it evident traces of that mystical and cabalistic jargon which, after their return from captivity, deformed the religion of the Jews; and many Gnostics adopted

the Oriental notion of two independent co-eternal principles, the one the author of good, and the other of evil. Lastly, we find the Gnostic theology full of ideas and terms which must have been taken from the Gospel: as *Jesus Christ*, under some form or other, of *Æon*, emanation, or incorporeal phantom, enters into all their systems, and is the means of communicating to them that knowledge which raised them above all other mortals, and entitled them to their peculiar name.'

'The genius and very soul of Gnosticism was mystery: its end and object was to purify its followers from the corruptions of matter, and to raise them to a higher scale of being, suited only to those who were to become perfect by knowledge. We have a key to many parts of their system, when we know that they held matter to be intrinsically evil, of which, consequently, God could not be the author. Hence arose their fundamental tenet, that the Creator of the world, or *Demiurgus*, was not the same with the supreme God, the Author of good, and the Father of Christ. Their system allowed some of them to call the Creator *God*, but the title most usually given was *Demiurgus*. Those who embraced the doctrine of two principles supposed the world to have been produced by the evil principle; and in most systems, the Creator of the world, and not the Father of Christ, was looked upon as the God of the Jews, and the author of the Mosaic law. Some, again, believed that angels were employed in creating the world: but all were agreed in maintaining that matter itself was not created; that it was eternal; and that it remained inactive till the world was formed out of it by the Creator.'

'The supreme God, according to the Gnostics, had dwelt from all eternity in a pleroma of inaccessible light; and beside the name of first Father, or first Principle, they called him also *Bythos*, as if to denote the unfathomable nature of his perfections. This Being, by an operation purely mental, or by acting upon himself, produced two other beings of different sexes, from whom by a series of descents, more or less numerous according to different schemes, several pairs of beings were formed, who were called *æons*, from the periods of their existence before time was, or *emanations*, from the mode of their production. These successive *æons* or emanations appear to have been inferior each to the preceding; and their existence was indispensable to the Gnostic scheme, that they might account for the creation of the world without making God the author of evil. These *æons* lived through countless ages with their first Father. But the system of emanations seems to have resembled that of concentric circles, and they gradually deteriorated as they approached nearer and nearer to the extremity of the pleroma. Beyond this pleroma was matter, inert and powerless, though co-eternal with the supreme God, and, like him, without beginning. At length one of the *æons* passed the limits of the pleroma, and, meeting with matter, created the world after the form and model of an ideal world, which existed in the pleroma, or the mind of the supreme God.'

'Here it is that inconsistency is added to absurdity in the Gnostic scheme. For, let the intermediate *æons* be as many as the wildest imagination could devise, still God was the remote, if not

the proximate cause of creation. Added to which, we are to suppose that the Demiurgus formed the world without the knowledge of God, and that, having formed it, he rebelled against him. Here again we find a strong resemblance to the Oriental doctrine of two principles, good and evil, or light and darkness. The two principles were always at enmity with each other. God must have been conceived to be more powerful than matter, or an emanation from God could not have shaped or moulded it into form: yet God was not able to reduce matter to its primeval chaos, nor to destroy the evil which the Demiurgus had produced. What God could not prevent he was always endeavouring to cure: and here it is that the Gnostics borrowed so largely from the Christian scheme. The names, indeed, of several of their æons were evidently taken from terms which they found in the Gospel. Thus we meet with Logos, Monogenes, Zoe, Ecclesia, all of them successive emanations from the supreme God, and all dwelling in the pleroma. At length we meet with Christ and the Holy Ghost, as two of the last æons which were put forth. Christ was sent into the world to remedy the evil which the creative æon, or Demiurgus, had caused. He was to emancipate men from the tyranny of matter, or the evil principle; and by revealing to them the true God, who was hitherto unknown, to fit them, by a perfection and sublimity of knowledge, to enter the divine pleroma. To give this knowledge was the end and object of Christ's coming upon earth: and hence the inventors and believers of the doctrine assumed to themselves the name of *Gnostics*.'

It was in agreement with the Gnostic doctrine of the utter malignity of matter, which Professor Burton considers the very corner-stone of the Gnostic system (both as to the *knowledge* of divine things to which they pretended, and as to the *morality*, or, to speak more correctly, the *mortification*, which they inculcated), that the different Gnostic sects 'either denied that Christ had a real body at all, and held that he was an unsubstantial phantom; or granting that there was a man called Jesus, the son of human parents, they believed that one of the æons, called Christ, quitted the pleroma and descended upon Jesus at his baptism.'

It was upon this belief of the utter malignity of matter, on the one hand, and upon the elevating nature of the divine knowledge to which they pretended, on the other, that the morality of Gnosticism, if it deserves to be so called, was founded. 'If we would know the effect which the doctrines of the Gnostics had upon their moral conduct, we shall find that the same principle led to two very opposite results. Though the Fathers may have exaggerated the errors of their opponents, it seems undeniable that many Gnostics led profligate lives, and maintained upon principle that such conduct was not unlawful. Others, again, are represented as practising great austerities, and endeavouring by every means to mortify the body and its sensual appetites. Both parties were actuated by the same common notion, that matter is inherently evil. The one thought that the body, which is compounded of matter, ought to be kept in subjection, and hence they inculcated self-denial and the practice of moral virtue' [if the learned professor had said that they thought the body ought to be mortified, and for that purpose

inculcated a system of asceticism, we think he would have been more correct]; 'while others, who had persuaded themselves that knowledge was every thing, despised the distinctions of the moral law, which was given, as they said, not by the supreme God, but by an inferior æon, or a principle of evil, who had allied himself to matter.'

Professor Burton gives a brief and clear summary of the Gnostic doctrines in the following passage, which well deserves to be retained in the memory:—'The system was stated to have begun with Simon Magus; by which I would understand that the system of uniting Christianity with Gnosticism began with that heretic; for the seeds of Gnosticism, as we shall see presently, had been sown long before. What Simon Magus began was brought to perfection by Valentinus, who came to Rome in the former part of the second century; and what we know of Gnosticism is taken principally from writers who opposed Valentinus. Contemporary with him there were many other Gnostic leaders, who held different opinions; but in the sketch which I have given, I have endeavoured to explain those principles which, under certain modifications, were common to all the Gnostics. That the supreme God, or the Good Principle, was not the creator of the world, but that it was created by an evil, or at least an inferior being; that God produced from himself a succession of æons or emanations, who dwell with him in the Pleroma; that one of these æons was Christ, who came upon earth to reveal the knowledge of the true God; that he was not incarnate, but either assumed an unsubstantial body, or descended upon Jesus at his baptism; that the God of the Old Testament was not the father of Jesus Christ; that there was no resurrection or final judgment. This is an outline of the Gnostic doctrines as acknowledged by nearly all of them.'

Of the erroneous and mischievous nature of the Gnostic doctrines, and of the 'opposition of science, falsely so called,' to the doctrines of Christianity, we shall have to speak presently. For the present, we must confine ourselves to the *historical* portion of this curious and important subject, that is, to a statement of the facts of Gnosticism as given in the lectures of the Regius Professor.

Having given the above admirable outline of the great leading doctrines of the Gnostic heresy, or, rather, of the Gnostic school, he next proceeds to trace up Gnosticism itself to the three sources which we briefly indicated at the beginning of this article, to wit, the *Oriental doctrines* of the Magi of Babylon, or the belief in two principles, the causes of good and evil; secondly, the *Cabbala* of the Jewish doctors, who from the time of the captivity in Babylon had blended much of the Oriental doctrines with the Mosaic law, namely, in that traditional wisdom, and secret doctrine, and mystical interpretation which they pretended to have received; and, lastly, the *philosophy of Plato* (including that of his followers, Greek and Alexandrian, Jewish and Oriental)—that popular philosophy, in which Plato, following Pythagoras and deserting Socrates, set an example of blending philosophy with theosophy, which ended in merging the Philosophy of Greece in the Mysticism of the East.

We proceed to give Dr. Burton's very clear and striking history of Gnosticism (or, in other words, of eclecticism and syncretism, that is, of selecting opinions and uniting them together), in his own words.

'Some persons,' says he, 'have deduced Gnosticism from the Eastern notion of a good and evil principle; some from the Jewish Cabbala, and others from the doctrines of the later Platonists. Each of these systems is able to support itself by alleging very strong resemblances; and those persons have taken the most natural and probably the truest course, who have concluded that all these opinions contributed to build up the monstrous system which was known by the name of Gnosticism.'

'We will begin with considering that which undoubtedly was the oldest of the three, the *Eastern doctrine* of a good and evil principle. There is no fact connected with remote antiquity, which seems more certainly established, than that the Persian religion recognised two beings or principles, which, in some way or other, exercised an influence over the world and its inhabitants. To one they gave the name of Ormuzd, and invested him with the attributes of light and beneficence; the other they called Ahreman, and identified him with the notions of darkness and malignity. It has often been disputed, whether these two principles were considered as self-existing co-eternal gods, or whether they were subject to a third and superior power. Plutarch evidently considered that both of them had a beginning, and that one of them at least would come to an end; for he says that Ormuzd took its rise from light, and Ahreman from darkness; so that light and darkness must have existed before them: he adds, that the time would come when Ahreman would be destroyed, and an age of pure unmixed happiness would commence.' 'Upon the whole,' adds Professor Burton, 'I cannot but consider that those persons have taken a right view of this intricate subject, who represent the Persians as having been always worshippers of one supreme God.

'It is true that the simplicity of their worship was soon corrupted; and the heavenly bodies, particularly the great source of light and heat, became the object of adoration. It is undoubted that the sun, under the name of Mithra, received from them the highest honours; and it will solve many difficulties, if we conceive, that as their ideas became more gross, and the externals of religion occupied more of their attention, they came at length to identify the sun with the one supreme God. There is evidence that a difference of opinion existed among the Magi upon this subject. Some of them embraced what has been called the dualistic system, or the notion that both principles were uncreated and eternal; while others continued to maintain the ancient doctrine, either that one principle was eternal, and the other created, or that both proceeded from one supreme, self-existing source. This fundamental difference of opinion, together with the idolatry which was daily gaining ground, seems to have led to that reformation of religion, which, it is agreed on all hands, was effected in Persia by Zoroaster.' Dr. Burton considers this reformation of religion to have taken place in the reign of Darius Hystaspis. 'There may,' he observes, 'have been an identi-

fication of Mithra, or the sun, with the first cause: but to bring back his countrymen to an acknowledgment of a first cause is worthy the praises which have been bestowed on the name of Zoroaster.'

He further remarks, 'The Oriental writers are fond of asserting that Zoroaster conversed with the captive Jews, and borrowed from them many of his ideas. The fact is perhaps chronologically possible; and Zoroaster may well have consulted with the Jews, if it be true that the reform which he introduced consisted in establishing the doctrine' [Dr. Burton had before stated this to be a return to the ancient doctrine of Persia], 'that the two principles were subservient to a third, or higher principle, by which they were originally created.'

Professor Burton proceeds to consider the second source of Gnosticism, 'the mystical philosophy of the Jews, which has been known by the name *Cabbala*;' and he tells us that 'the Jewish cabbala may be loosely defined to be a mystical system, affecting the theory and practice of religion, founded upon oral tradition.' Farther on, in the third lecture, he gives the following account of the origin of the cabbala, and of the spirit in which it was composed, 'That extraordinary and infatuated people' [he is speaking of the Jewish tendency to go after strange gods] 'were from the earliest times inclined to engraft foreign superstitions upon their national worship; and when their idolatries at length caused the Almighty to destroy their city and send them captives to Babylon, they came in contact with a new system of superstition, different from that of Egypt or Canaan, which had before ensnared them. The Jews, who returned from Babylon at the end of their captivity, would be sure to bring with them some of the rites and customs of the people whom they had left: but they also found the evil already waiting for them at their doors. The mixed people who settled in Samaria, when Shalmeneser had depopulated it, set up a variety of idolatries, and joined them to the worship of the God of the Jews (2 Kings xvii. 24-31). Most of the idolaters were from the nations beyond the Euphrates; and this heterogeneous mixture of creeds continued in the country when the Jews returned from captivity. We know from Scripture, that of those who were the first to return, many formed marriages with the people of the neighbourhood (Ezra ix. 2); and the zeal with which Ezra endeavoured to prevent this intercourse showed that he considered the religion of his country to be in danger. We learn also from Josephus, that many Jews continued to live in the countries beyond the Euphrates; he speaks of them as many myriads; and he shows in several places that they kept up an intercourse with their countrymen at Jerusalem; they attended the festivals; they paid the didrachma to the temple, and sent their pedigrees to be registered at Jerusalem: all which shows that a constant communication was kept up between the Jews and those Eastern nations, where the religion of the Magi had lately been reformed by Zoroaster. In one sense the Jews had greatly profited by their captivity in Babylon; and we read no more of the whole nation falling into idolatry. The Persians, indeed, were not idolaters; and it was from them that the greatest effect was produced upon the

opinions of the Jews. It seems certain that their notions concerning angels received a considerable sanction from those of the Persians: and the three principal sects of Pharisees, Sadducees, and Essenes, show how far religious differences were allowed among them, and yet the unity of the faith was considered to be maintained. The Cabbala contains many doctrines concerning angels, and other mystical points, which can only have come from an Eastern quarter: and the secondary, or allegorical interpretation of Scripture, with which the Cabbala abounds, began soon after the return from the captivity.'

Dr. Burton gives rather too slight a sketch of the principles of the Cabbala, and remarks on its resemblance to those of the Gnostics: 'They,' the Cabbalists, 'did not hold the eternity of matter with the Greeks; nor, with the Persians, had they recourse to two opposite principles: they cut the knot which they could not solve; and they taught that God being a spirit, who pervaded all space, the universe also was not material, but spiritual, and proceeded by emanation from God. The first emanation was called in their language *the first man*, or the first begotten of God: and he was made the medium of producing nine other emanations, or *sephiroth*, from which the universe was formed. All this is highly mystical; and it is melancholy to see how the human mind can fall when it attempts the highest flights. Imperfectly as I have described the system of the Cabbalists, it will be seen that it bears no small resemblance to that of the Gnostics, who interposed several æons or emanations between the supreme God and the creation of the world.' Respecting the secondary and mystical interpretation of the Scriptures introduced by the Cabbalists, and carried so much farther by the Gnostics, he says: 'With the Gnostics, to interpret Scripture literally was the exception; and they only did it when it suited their purpose: their rule was to extort a hidden meaning from every passage, and to make every word, and almost every letter, contain a mystical allusion. There undoubtedly was a Cabbala, or secret doctrine, among the Jews, before we hear anything of the Gnostic philosophy: the latter, therefore, could not have contributed to produce the former.'

It will be obvious from the above statements that the Gnostics were as much indebted to the Cabbala, as the Cabbala had been to the Oriental doctrines. 'The notion of emanations, as has been observed by Professor Matter, is the essential feature of the Cabbala; and since there is no warrant for this in the Bible, nor did it appear in the prevailing schemes of heathen philosophy, he very naturally deduces it from the East, where many of the Magi taught that every thing emanated from God, the fountain of light.'

Professor Burton connects the second source of Gnosticism with the third, and, as he considers it, the greatest, or, at least, the most immediate cause of Gnosticism, namely *Platonism*, in the following passage: 'It is natural for us to ask, how the Cabbala came to receive a system of philosophy so far removed from the simplicity of the Mosaic; and how the opinions of the Jews, hitherto so exclusive and so little known, could produce any effect upon a system which, at the time of which we are speaking, was spread over great part of the world. A solution of these questions may pro-

bably be found by a consideration of the Platonic doctrines.' These doctrines he considers to have been 'the principal source of Gnosticism,' and to have had an effect 'upon the Cabbalistic philosophy of the Jews.'

In the Greek philosophy, as well as in the Greek Mythology or Cosmogony, the origin of evil was the same stumbling-block that it appears to have been to every system, imaginative or rational; and the Greeks had their own peculiar way of getting over the difficulty. 'The Grecian philosophy,' says Professor Burton, 'did not adopt the system of emanation. They all held that matter was eternal; and such undoubtedly was the opinion of Plato. This was the expedient by which all the philosophers thought to rescue God from being the author of evil; forgetting, as it appears, that at the same time they limited his omnipotence, and made him, though not the author of evil, yet himself subject to its influence: for a being who is all good, and yet restricted in his power, is undoubtedly subject to evil.—Here then was the basis, the false, the unphilosophical basis, on which all the Grecian sages built their systems. Matter was co-eternal with God; and the world was formed either by matter acting upon itself, or being acted upon by God. The school of Epicurus made matter act upon itself, and the Deity was reduced to a name. The Stoics and Peripatetics believed God to have acted upon matter; but it was from necessity, and not from choice.'

'Plato had already adopted a system more worthy of the Deity, and conceived that God acted upon matter of his own free will, and by calling order out of disorder formed the world. Plato certainly did not believe the world to be eternal, though such a notion is ascribed to Aristotle. Plato held the eternity of matter; but he believed the arrangement and harmony of the universe to be the work of the Deity. Here begins the peculiar intricacy of the Platonic system. Every thing, except the Deity, which exists in heaven or in earth, whether the object of sense or purely intellectual, was believed to have had a beginning. There was a time when it did not exist; but there never was a time, when the *Idea*, *i. e.* the form or archetype, did not exist in the mind of the Deity. Hence we find so many writers speak of three principles being held by Plato, the Deity, the *idea*, and matter. It is difficult to explain the Platonic doctrine of *ideas*, without running into mysticism or obscurity; but perhaps, if we lay aside for a time the doctrines of the ancients, and take our own notions of the Deity, we may be able to form some conception of Plato's meaning.'

'We believe that there was a time when the world which we inhabit, and every thing which moves upon it, did not exist; but we cannot say that there ever was a time when the works of creation were not present to the mind of the Deity. There may therefore be the image of a thing, though as yet it has received no material form; or, to use the illustration of the Platonists, the seal may exist without the impression.—Plato supposed these images to have a real existence, and gave to them the name of form, example, archetype, or *idea*; and the use which he made of them constitutes the peculiar character of the Platonic philosophy. He saw that these *ideas* not only preceded the creation of the world, but must have been present to the Deity from all eternity; and he

could assign them no other place than the mind of the Deity.'

The Gnostics, as we have seen, agreed with Plato in making matter co-eternal with God. They also believed that the material world was formed after an eternal and intellectual *idea*. This peculiar and mystical notion is the very soul of Platonism: and we learn from Irenæus that it was held by all the Gnostics. Both parties also believed in an intermediate order of beings between the supreme God and the inhabitants of the earth: these beings were supposed by both to have proceeded from the mind or reason of God: and it may furnish a clew to much of the Gnostic philosophy, if we suppose the æons of the Gnostics to be merely a personification of the ideas of Plato; or we may say generally, that the Gnostics formed their system of æons by combining the intellectual beings of the Platonic philosophy with the angels of the Jewish Scriptures.'

'There is, indeed, one material difference between the system of Plato and that of the Gnostics. According to the former, God ordered the intellectual beings which he had produced, to create the world; and he delegated this work to them, that he might not be himself the author of evil. But according to the Gnostics, the Demiurgus, one of the inferior æons, created the world without the knowledge of God. This is perhaps as rational an hypothesis as that of Plato himself; and the one may have very naturally grown into the other, during the frequent agitation of the question concerning the origin of evil. It may be observed, also, that the constant hostility which existed between the supreme God and the creative æon, or demiurgus, does not find any parallel in the Platonic philosophy. This was probably borrowed from the Eastern doctrine of a good and evil principle; and what the Scriptures say of Satan, the great adversary of man, may also have contributed to form the same doctrine.'

Such is Professor Burton's view of the doctrines of Gnosticism, and of the three great sources from which it originated, together with some of its effects upon Christianity, in diverting many of the first converts from a better faith into a vain philosophy, '*profane and vain babblings, and the oppositions of science falsely so called.*'

It will remain for us, in the article *LOGOS*, to lay before our readers Professor Burton's estimate of one of the most remarkable effects of Gnosticism upon Christianity; but as it relates to the *Logos* of St. John's Gospel, and as it ought, we think, to have been preceded by a more definite, not to say a more searching inquiry into the errors of Plato's philosophy (which are indeed very types or the principal faults of Gnosticism) than Dr. Burton has given to them, we propose there to show what were the false principles in Plato's philosophy which were propagated so widely by the Gnostic heresy, and from which Christianity offered to all who would be taught better things a means of escape.

We trust it has already become evident to our readers that, in presenting them with a brief and clear analysis of the doctrines and origin of Gnosticism in the very words of the late *Regius Professor of Divinity*, we have been influenced by no desire to save ourselves trouble of thought or composition. The character, learning, and station of Dr. Burton, and the many years of his innocent

and useful life which he devoted to the Gnostic heresy and the Apostolic age, must give authority to his opinions when fairly stated.—J. P. P.

GOAT. Chaldee, *izza*; Phœnician, *aza*; Arabic, *jidda* and *hedjaz*. Of the several Hebrew denominations of this animal there is no doubt, for the simple manners of the ancient Semitic nations multiplied the names of the few objects they had constantly before their eyes; and their domestic animals, in particular, received abundant general and distinctive appellations, according to sex, age, race, and conditions of existence or purpose. Thus we have for goat, עז *ez* (Gen. xxvii. 9); חַשִׁיפָה *chasiph* (1 Kings xx. 27); עֲטוּדָה *attud*, 'a he-goat,' or rather עֲטוּדִים *attudim*, 'he-goats' (Gen. xxxi. 10, 12); צִפִּיר *tzaphir*, 'a he-goat' (Dan. viii. 5, 21); שַׁעִיר *sair*, 'a hairy one' (Lev. iv. 24); יַעַל *jaal*, a kind of wild goat (1 Sam. xxiv. 2); אֶקוֹ *akko*, either the same or another species of wild goat (Exod. xxiii. 19); and גְּדִי *gedi*, 'a kid' (Gen. xxxviii. 17, &c.).

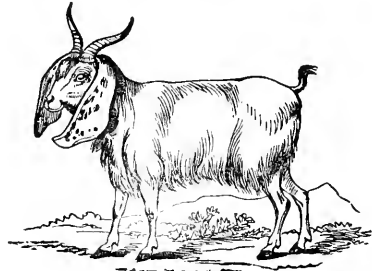

329. [Syrian Goat.]

The races either known to or kept by the Hebrew people were probably—1. The domestic Syrian long-eared breed, with horns rather small and variously bent; the ears longer than the head, and pendulous; hair long, often black;—2. The Angora, or rather Anatoli breed of Asia Minor, with long hair, more or less fine;—3. The Egyptian breed, with small spiral horns, long brown hair, very long ears;—4. A breed from Upper Egypt, without horns, having the nasal bones singularly elevated, the nose contracted, with the lower jaw protruding the incisors, and the female with udder very low and purse-shaped. This race, the most degraded by climate and treatment of all the domestic varieties, is clad in long coarse hair, commonly of a rufous brown colour, and so early distinct, that the earlier monuments of Egypt represent it with obvious precision. It is probable that some of the names which now appear synonymous were anciently applied to distinguish breeds from different regions. Thus *Tzaphir*, being of Chaldee origin, may have denoted a goat of a northern mountainous region; or may have been the same as *Tschäfer*, 'the leader of a flock'; while *Azazel*, on the contrary, applied in the Auth. Vers. to the scape-goat, might seem to be derived from the wandering Syrian or Phœnician breed of the coast, were it not shown in the next article to have a different reference.

The natural history of the domestic goat requires no illustration in this place, and its economic uses demand only a few words. Notwithstanding the offensive lasciviousness which causes it to be significantly separated from sheep, the goat was em-

ployed by the people of Israel in many respects as their representative. It was a pure animal for sacrifice (Exod. xii. 5), and a kid might be substituted as equivalent to a lamb: it formed a principal part of the Hebrew flocks; and both the milk and the young kids were daily articles of food. Among the poorer and more sober shepherd families, the slaughter of a kid was a token of hospitality to strangers, or of unusual festivity; and the prohibition, thrice repeated in the Mosaic law, 'not to seethe a kid in its mother's milk' (Exod. xxiii. 19; xxxiv. 26; and Deut. xiv. 21), may have originated partly in a desire to recommend abstemiousness, which the legislators and moralists of the East have since invariably enforced with success, and partly with a view to discontinuance a practice which was connected with idolatrous festivals, and the rites they involved. It is from goatskins that the leathern bottles to contain wine and other liquids are made in the Levant. For this purpose, after the head and feet are cut away, the case or hide is drawn off the carcass over the neck, without opening the belly; and the extremities being secured, it is dried with the hair in or outside, according to the use it is intended for. The old worn-out skins are liable to burst: hence the obvious propriety of putting new wine into new bottles (Matt. ix. 17). Harmer appears to have rightly referred the allusion in Amos iii. 12 to the long-eared race of goats: 'As the shepherd taketh out of the mouth of the lion two legs or a piece of ear, so shall the children of Israel be taken out that dwell in Samaria and Damascus.'



330. [Wild Goat of Sinai.]

Beside the domestic goats, Western Asia is possessed of one or more wild species—all large and vigorous mountain animals, resembling the ibex or bouquetin of the Alps. Of these, Southern Syria, Arabia, Sinai, and the borders of the Red Sea, contain at least one species, known to the Arabs by the name of Beden or Beddan, and Taytal—the *Capra Jaela* of Ham. Smith, and *Capra Sinaitica* of Ehrenberg. We take this animal to be that noticed under the name of *עַל*, Jaal or Jol, in the plural Jolim (1 Sam. xxiv. 2; Job xxxix. 1; Ps. civ. 18; Prov. v. 19). The male is considerably taller and more robust than the larger he-goats, the horns forming regular curves backwards, and with from 15 to 24 transverse elevated cross ridges, being sometimes near three feet long, and exceedingly ponderous: there is a beard under the chin, and the fur is dark brown; but the limbs

are white, with regular black marks down the front of the legs, with rings of the same colour above the knees and on the pasterns. The females are smaller than the males, more slenderly made, brighter rufous, and with the white and black markings on the legs not so distinctly visible. This species live in troops of 15 or 20, and plunge down precipices with the same fearless impetuosity which distinguishes the ibex. Their horns are sold by the Arabs for knife handles, &c.; but the animals themselves are fast diminishing in number.

In Deut. xiv. 5, *אֵיִלִּים Akko* is translated 'wild goat.' Schultens (*Origines Hebraicae*) conjectures that the name arose 'ob fugacitatem,' from its shyness, and consequent readiness to fly; and Dr. Harris points out what he takes to be a confirmation of this conjecture in Shaw's travels; who, from the translations of the Sept. and Vulgate, makes it a goat-deer, or Tragelaphus, such as the Lerwee or Fisitall, by mistake referred to *Capra Mambryca* of Linnæus; whereas that naturalist (*System. Nat.* 13th ed. by Gmelin) places Lerwee among the synonyms of *Ant. Cervicapra*, which does not suit Shaw's notice, and is not known in Western Asia. The Fisitall is, however, a ruminant of the African desert, possibly one of the larger Antilopidae, with long mane, but not as yet scientifically described. Akko, therefore, if it be not a second name of the Zamor, which we refer to the Kesch, or wild sheep (Chamois), as the species must be sought among ruminants that were accessible for food to the Hebrews, we should be inclined to view as the name of one of the Gazelles, probably the Ahu (*Ant. Subgutturosa*), unless the Abyssinian Ibex (*Capra Walie*) had formerly extended into Arabia, and it could be shown that it is a distinct species. We may here also remark upon the researches of Rüppell and of Hemprich and Ehrenberg, that they naturally sought in vain for the Abyssinian Ibex as it is figured in Griffiths' Cuvier, because, by some mistake of the letter engraver, he has affixed that name to the representation of *Ovis Tragelaphus* or Kesch.—C. H. S.

GOAT, SCAPE. Under this head we cannot do better than present the reader with the substance of a very ingenious article in Hengstenberg's *Die Bücher Moses und Aegypten*, one of the most interesting books on Egyptian antiquities, as applied to the illustration of Scripture, which has yet appeared, and of which an excellent translation has been produced in America, by R. D. C. Robbins, under the title of *Egypt and the Books of Moses*, 1843.

It appears to Dr. Hengstenberg, that an Egyptian reference must necessarily be acknowledged in the ceremony of the Great Atonement day: and in order to establish this reference, he first endeavours to substantiate his view of the meaning of the word *אָזָזִים Azazel*: which is, that it designates Satan. But this notion can only be placed in a right point of view by taking a general survey of the whole rite, in order to point out definitely the position which Azazel holds in it.

The account of this remarkable ceremony is contained in Lev. xvi.

First, in verses 1-10, the general outlines are given; and then follows, in verses 11, sq., the explanation of separate points. It is of no small

importance for the interpretation that this arrangement, which has been recognised by few interpreters, should be clearly understood. Aaron first offers a bullock as a sin-offering for himself and his house. He then takes a firepan full of coals from the altar, with fragrant incense, and goes within the vail. There he puts the incense on the fire before the Lord, and 'the cloud of the incense' (the embodied prayer) covers the mercy-seat which is upon the ark of the covenant, that he die not. Aaron then takes the blood of the bullock and sprinkles it seven times before the mercy-seat. After he has thus completed the expiation for himself, he proceeds to the expiation for the people. He takes two he-goats for a sin-offering for the children of Israel (xvi. 5). These he places before the Lord at the door of the tabernacle (xvi. 7). He casts lots upon them; one lot 'for the Lord' and one lot 'for Azazel' (xvi. 8). The goat upon which the lot for the Lord fell (xvi. 9) he offers for a sin-offering, brings the blood within the vail, and does with it as with the blood of the bullock. In this way is the sanctuary purified from the defilements of the children of Israel, their transgressions, and all their sins, so that the Lord, the holy one and pure, can continue to dwell there with them. After the expiation is completed, the second goat, on which fell the lot for Azazel, is brought forward (xvi. 10). He is first placed before the Lord to absolve him (לכפר עליו). Then Aaron lays his hands upon his head, and confesses over him the (forgiven) iniquities, transgressions, and sins of the children of Israel, puts them upon his head, and gives him to a man to take away, in order that he may bear the sins of the people into a solitary land (xvi. 22), into the desert, for Azazel (xvi. 10). Then Aaron offers a burnt-offering for himself, and one for the people.

Now, in respect to language, there can be no objection to interpreting Azazel as meaning Satan. That the Hebrew עֹזָזַל, *Azal*, corresponds to the Arabic عزل, was long ago asserted by Bochart and others, and is now generally admitted; and עֹזָזַל, *Azazel*, belongs to the form which repeats the second and third radicals. In reference to this form, Ewald remarks (*Gramm.* § 333), that it expresses general intension, and that the idea of continual, regular repetition, without interruption, is also specially expressed by the repetition of nearly the whole word. The Arabic word *Azala* signifies in that language 'semovit, dimovit, removit, descivit'; in the passive it signifies 'remotus, depositus fuit'; and the participle, *azul*, means 'a cæteris se sejungens.' In like manner *azal*, *mazul*, denote 'semotus, remotus, abdicatus.' From this two explanations of Azazel, as relating to Satan, may be deduced; either 'the apostate' (from God), or, 'the one entirely separate.' It is in favour of the latter that the signification 'descivit' is only a derived one, and that it is appropriate to the abode in the desert. The goat is sent to Azazel in the desert, in the divided land ('terra abscessa'). How then could he be designated by a more appropriate name than 'the separate one'?

And this explanation, as far as the facts of the case are concerned, is, in Hengstenberg's opinion, equally unexposed to any well grounded objec-

tion. The doctrinal signification of the symbolical action, as far as it has reference to Azazel, is this, that Satan, the enemy of the people of God, cannot harm those forgiven by God, but that they, with sins forgiven of God, can go before him with a light heart, deride him, and triumph over him.

The positive reasons which favour this explanation are the following:—

1. The manner in which the phrase עֹזָזַל, 'for Azazel,' is contrasted with לַיהוָה, 'for Jehovah,' necessarily requires that Azazel should denote a personal existence, and, if so, only Satan can be intended. 2. If by Azazel, Satan is not meant, there is no ground for the lots that were cast. We can then see no reason why the decision was referred to God; why the high-priest did not simply assign one goat for a sin-offering, and the other for sending away into the desert. The circumstance that lots are cast implies that Jehovah is made the antagonist of a personal existence, with respect to which it is designed to exalt the unlimited power of Jehovah, and to exclude all equality of this being with Jehovah. 3. Azazel, as a word of comparatively infrequent formation, and only used here, is best fitted for the designation of Satan. In every other explanation the question remains, 'Why, then (as it has every appearance of being), is the word formed for this occasion, and why is it never found except here?'

By this explanation the third chapter of Zechariah comes into a relation with our passage, entirely like that in which chap. iv. of the same prophecy stands to Exod. xxv. 31. Here, as there, the Lord, Satan, and the high-priest appear. Satan wishes by his accusations to destroy the favourable relations between the Lord and his people. The high-priest presents himself before the Lord, not with a claim of purity, according to law, but laden with his own sins and the sins of his people. Here Satan thinks to find the safest occasion for his attacks; but he is mistaken. Forgiveness baffles his designs, and he is compelled to retire in confusion. It is evident that the doctrinal part of both passages is substantially the same, and that the one in Zechariah may be considered the oldest commentary extant upon the words of Moses. In substance we have the same doctrine also in Rev. xii. 10, 11: 'the accuser of our brethren is cast down, who accuses them before our God day and night, and they overcame him by the blood of the Lamb.'

The relation in which, according to this explanation, Satan is here placed to the desert, finds analogy in other passages of the Bible, where the deserted and waste places appear as peculiarly the abode of the Evil Spirit. See Matt. xii. 43, where the unclean spirit cast out of the man is represented as going through 'dry places': also Luke viii. 27; and Rev. xviii. 2, according to which the fallen Babylon is to be the dwelling of all unclean spirits.

To the reasons already given, the Egyptian reference, which the rite bears according to this explanation, may be added—'a reference so remarkable, that no room is left for the thought that it has arisen through false explanation.'

Dr. Hengstenberg then proceeds to meet the objections which have been brought to bear against the view adopted by him—'adopted,' for this explanation is by no means a new one, though he

has brought it forward in greater force than before, and with new illustrations.

The most important of the objections, and the one which has exerted the greatest influence, is this, that it gives a sense which stands in direct opposition to the spirit of the religion of Jehovah. It is asked, 'Could an offering properly be made to the Evil Spirit in the desert, which the common precepts of religion in the Mosaic law, as well as the significance of the ceremony, entirely oppose?' To this Hengstenberg answers—'Were it really necessary to connect with the explanation of Azazel as meaning Satan, the assumption that sacrifice was offered to him, we should feel obliged to abandon it, notwithstanding all the reasons in its favour. But nothing is easier than to show that this manner of understanding the explanation is entirely arbitrary. The following reasons prove that an offering made to Azazel cannot be supposed:—

1. Both the goats are, in verse 5, taken together as forming unitedly one single offering, which wholly excludes the thought that one of them was brought as an offering to Jehovah, and the other to Azazel. And further, an offering which is made to a bad being can never be a sin-offering. The idea of a sin-offering implies holiness, hatred of sin in the being to whom the offering is made.

2. Both the goats were first placed at the door of the tabernacle of the congregation before the Lord. To him, therefore, they both belong; and when afterwards one of them is sent to Azazel, this is done in accordance with the wish of Jehovah, and also without destroying the original relation, since the one sent to Azazel does not cease to belong to the Lord.

3. The casting of lots also shows that both these goats were considered as belonging to the Lord. The lot is never used in the Old Testament except as a means of obtaining the decision of Jehovah. So then, here also, Jehovah decides which of the goats is to be offered as a sin-offering, and which to be offered to Azazel.

4. The goat assigned to Azazel, before he is sent away, is absolved (xvi. 21). The act by which the second goat is, as it were, identified with the first, in order to transfer to the living the nature which the dead possessed, shows to what the phrase 'for a sin-offering,' in verse 5, has reference. The two goats (as Spencer had before observed) became, as it were, one goat, and their duality rests only on the physical impossibility of making one goat represent the different points to be exhibited. Had it been possible, in the circumstances, to restore life to the goat that was sacrificed, this would have been done. The two goats, in this connection, stand in a relation entirely similar to that of the two birds in the purification of the leprous person in Lev. i. 4, of which the one leg was dipped in the blood of the one slain. As soon as the second goat is considered an offering to Azazel, the connection between it and the first ceases, and it cannot be conceived why it was absolved before it went away.

5. According to verse 21, the already forgiven sins of Israel are laid upon the head of the goat. These he bears to Azazel in the desert. But where there is already forgiveness of sin, there is no more offering.

The other objections which have on different

principles been made to this view are of less weight.

One of them, which alleges the apparent equality given under this explanation to the claims of Jehovah and of Satan, is answered by showing that it is rather calculated to act against the tendency of an ancient people to entertain that belief. The lot is under the direction of Jehovah, and is a means of ascertaining his will; and not a mediation between the two by an independent third agency, which decides to which the one and to which the other shall fall.

Another objection, founded on the belief that Satan nowhere appears in the Pentateuch, will not in this country be deemed to require much answer. It is entertained chiefly by those who believe that the presence of Satan in Scripture is owing to the influence of a foreign (Babylonian and Persian) theology upon Hebrew opinions; and it is answered by a reference to the book of Job, in which Satan appears distinctly, while even the objectors admit that this book was written long before the assigned influence existed. And if it were indeed necessary to refer the knowledge of Satan to a foreign influence, it might be perceived that quite as much is accomplished by referring to the Egyptian Typhon as to the Persian Ahreman. Hengstenberg also points to the intimations of the doctrine of Satan, which appear in Gen. iii., and remarks—'From a theological point of view, as well as from the nature of the case, it will be found almost impossible that a dogma which in the later period of the revelation holds so important a place, should not at least be referred to in the statement of the first principles of that revelation.

After exhibiting the positive reasons for this explanation, and disposing of the objections to it, Hengstenberg subjects to examination those among the various explanations that have been given, which are now current; and makes out that they are either philologically untenable with reference to the word Azazel, do not agree with the context, or are unsatisfactory in the result to which they conduct us.

If it has been thus established that Satan is to be understood by the term Azazel, then, argues Hengstenberg, an allusion to Egypt in the whole rite cannot be mistaken. In that country every bad influence or power of nature, and generally the bad itself, in a physical or ethical respect, was personified under the name of Typhon. The doctrine of a Typhon among the Egyptians is as old as it is firmly established. Representations of him are found on numerous monuments as old as the time of the Pharaohs. Herodotus speaks of Typhon (ii. 144. 56, and iii. 5). But Plutarch gives the most accurate and particular account, with, indeed, many incorrect additions.

The barren regions around Egypt generally belonged to Typhon. The desert was especially assigned to him as his residence, whence he made his wasting inroads into the consecrated land. 'He is,' says Creuzer, 'the lover of the degenerate Nephthys, the hostile Libyan desert, and of the sea-shore. There is the kingdom of Typhon. On the contrary, Egypt the blessed, the Nile-valley glittering with fresh crops, is the land of Isis.' Herodotus ascribes a similar dwelling to Typhon.

By a strange but very natural alteration, the Egyptians sought sometimes to propitiate the god

whom they hated, but feared, by offerings, and indeed by those which consisted of sacred animals. Sometimes, again, when they supposed that the power of the gods was prevalent and sustained them against him, they allowed themselves in every species of mockery and abuse. 'The obscured and broken power of Typhon,' says Plutarch, 'even now, in the convulsions of death, they seek sometimes to propitiate by offerings, and endeavour to persuade him to favour them; but at other times, on certain festival occasions, they scoff at and insult him. Then they cast mud at those who are of a red complexion, and throw down an ass from a precipice, as the Coptites do, because they suppose that Typhon was of the colour of the fox and the ass.'

The most important passage on the worship of Typhon is found in *De Is. et Osir.* p. 380: 'But when a great and troublesome heat prevails, which in excess either brings along with it destructive sickness or other strange or extraordinary misfortunes, the priests take some of the sacred animals, in profound silence, to a dark place. There they threaten them first and terrify them; and when the calamity continues, they offer these animals in sacrifice there.'

Now, the supposition of a reference to these *Typhonia sacra* Hilsius considers as a profanation. But it is seen at once that the reference contended for by him is materially different from that adopted by our author. The latter is a controversial one. In opposition to the Egyptian view, which implied the necessity of yielding respect even to bad beings generally, if men would insure themselves against them, it was intended by this rite to bring Israel to the deepest consciousness that all trouble is the punishment of a just and holy God, whom they, through their sins, have offended; that they must reconcile themselves only with him; that when that is done, and the forgiveness of sins is obtained, the bad being can harm no farther.

How very natural and how entirely in accordance with circumstances such a reference was, is evident from the facts contained in other passages of the Pentateuch, which show how severe a contest the religious principles of the Israelites had to undergo with the religious notions imbibed in Egypt. This is especially exhibited in the regulations in Leviticus xvii., following directly upon the law concerning the atonement-day, which prove that the Egyptian idol-worship yet continued to be practised among the Israelites. The same thing is also evident from the occurrences connected with the worship of the golden calf.

The assumption of a reference so specially controversial might indeed be supposed unnecessary, since in a religion, which teaches generally the existence of a powerful bad being, the error here combated, the belief that this being possesses other than derived power, will naturally arise in those who have not found the right solution of the riddle of human life in the deeper knowledge of human sinfulness.

But yet the whole rite has too direct a reference to a prescribed practice of propitiating the bad being, and implies that formal offerings were made to him—a thing which could never be the natural product of Israelitish scil, and could scarcely spring up there, since such an embodying of error contradicts fundamental principles among the Israelites respecting the being of Jehovah, which,

indeed, allows the existence of no other power with itself.

And, finally, there exists here a peculiar trait, which in Hengstenberg's opinion makes it certain that there is an Egyptian reference, namely, the circumstance that the goat was sent to Azazel into the desert. The special residence of Typhon was in the desert, according to the Egyptian doctrine, which is most intimately connected with the natural condition of the country. There, accordingly, is Azazel placed in our passage, not in the belief that this was literally true, but merely symbolically.

Such is the view taken by Professor Hengstenberg, and which we have endeavoured with all possible conciseness to place before the reader. Those who desire to contemplate the subject in different points of view will do well to consult the valuable dissertation in Professor Bush's *Notes on Leviticus* xvi., and previously published by him in the *American Biblical Repository* for July, 1842. Professor Bush takes notice of the opinion that Azazel was Satan: he shows that the Septuagint makes Azazel a person, and that the early Christian church, and most of the Jewish writers, regarded him as Satan. The professor is, however, not of this opinion; but he had not the advantage of having seen it as reproduced in the new and strong lights thrown upon it by Hengstenberg, whose vast erudition and soundness of theological opinion give great weight to any conclusion which his judgment approves. The subject is one of the most curious and interesting in Biblical literature; but it is also one on which it seems scarcely possible to realize an implicit conviction: and the present writer, in reporting the views of another, must admit that he, for himself, has not been able to do so.

GOD. The two principal Hebrew names of the Supreme Being (St. Jerome and the Rabbin enumerates ten, but they belong rather to his attributes) used in the Scriptures are יהוה *Jehovah*, and אֱלֹהִים *Elohim*. Dr. Havernick, in his erudite work, *Historisch-critische Einleitung ins alte Testament*, Berlin, 1839, proposes the reading יהוה *Jahveh* instead of יהוה *Jehovah*, meaning 'the Existing One,' while he derives אֱלֹהִים *Elohim*, from an ancient Hebrew root, now lost, אלה *colahit*, and thinks that the plural is used merely to indicate the abundance and super-richness contained in the Divine Being. With him, therefore, *Jehovah* is not of the same origin as the heathen *Jove*, but of a strictly peculiar and Hebrew origin. Both names, he admirably proves, are used by Moses discriminately, in strict conformity with the theological idea he wished to express in the immediate context; and, pursuing the Pentateuch nearly line by line, it is astonishing to see that Moses never uses any of the names at mere random or arbitrarily, but is throughout consistent in the application of the respective terms. *Elohim* is the abstract expression for absolute *Deity* apart from the special notions of unity, holiness, substance, &c. It is more a philosophical than devotional term, and corresponds with our term *Deity*, in the same way as *state* or *government* is abstractedly expressive of a king or monarch. *Jehovah*, however, he considers to be the revealed *Elohim*, the Manifest, Only, Per-

sonal, and Holy Elohim : Elohim is the Creator, Jehovah the Redeemer, &c.

To Elohim, in the later writers, we usually find affixed the adjective חיים *chayim* 'the living' (Jer. x. 10; Dan. vi. 20, 26; Acts xiv. 15; 2 Cor. vi. 16), probably in contradistinction to *idols*, which might be confounded in some cases with the true God, the linguistical difference in the Hebrew existing only in the plural, the former being called אֱלִילִים *Ellim* instead of *Elohim* (Lev. xix. 14; xxvi. 1; Hab. ii. 18).

The attributes ascribed to God by Moses are systematically enumerated in Exod. xxxiv. 6-7, though we find in isolated passages in the Pentateuch and elsewhere, additional properties specified, which bear more directly upon the dogmas and principles of religion, such as *e. g.* that he is not the author of sin (Gen. i. 31), although since the fall, man is born prone to sin (Gen. vi. 5; viii. 21, &c.). But as it was the avowed design of Moses to teach the Jews the Unity of God in opposition to the Polytheism of the other nations with whom they were to come in contact, he dwelt particularly and most prominently on that point, which he hardly ever omitted when he had an opportunity of bringing forward the attributes of God (Deut. vi. 4; x. 17; iv. 39; ix. 16, &c.; Num. xvi. xxii; xxxiii. 19, &c.; Exod. xv. 11; xxxiv. 6, 7, &c.).

In the Prophets and other sacred writers of the Old Testament, these attributes are still more fully developed and explained by the declarations that God is the first and the last (Is. xliv. 6), that He changes not (Hab. iii. 6), that the earth and heaven shall perish, but He shall endure (Ps. cii. 26)—a distinct allusion to the last doomsday—and that He is Omnipresent (Prov. xv. 3; Job xxxiv. 22, &c.).

In the New Testament also we find the attributes of God systematically classified (Rev. v. 12 and vii. 12), while the peculiar tenets of Christianity embrace, if not a farther, still a more developed idea, as presented by the Apostles and the primitive teachers of the church (comp. Semisch's Justin Martyr, vol. ii. p. 151, sq., translated by J. E. Ryland, 1843).

The expression 'to see God' (Job xix. 26; xlii. 5; Isa. xxxviii. 11) sometimes signifies merely to experience his help; but in the Old Testament Scriptures it more usually denotes the approach of death (Gen. xxxii. 30; Judg. vi. 23; xiii. 22; Isa. vi. 5).

The term בן אלהים, 'son of God,' applies to Kings (Ps. ii. 7; lxxviii. 6, 27). The usual notion of the ancients, that the royal dignity was derived from God, may here be traced to its source: hence the Homeric *διογενής βασιλευς*. This notion, entertained by the Oriental nations with regard to kings, made the latter style themselves *Gods* (Ps. lxxxii. 6).

בני אלהים, 'sons of God,' in the plural, implies inferior gods, angels (Gen. vi. 2; Job i. 6); as also faithful adherents, worshippers of God (Deut. xiv. 1; Ps. lxxxiii. 15; Prov. xiv. 26).

איש אלהים, 'man of God,' is sometimes applied to an angel (Judg. xiii. 6, 8); as also to a prophet (1 Sam. ii. 27; ix. 6; 1 Kings xiii. 1).

When, in the middle ages, scholastic theology began to speculate on the divine attributes, as the basis of systematic and dogmatic Christianity,

the Jews, it appears, did not wish to remain behind on that head, and collecting a few passages from the Old Testament, and more especially from Isa. xi. 2, and Chron. xxix. 11, where the divine attributes are more amply developed and enumerated, they strung them together in a sort of cabalistic tree, but in reality representing a human figure.

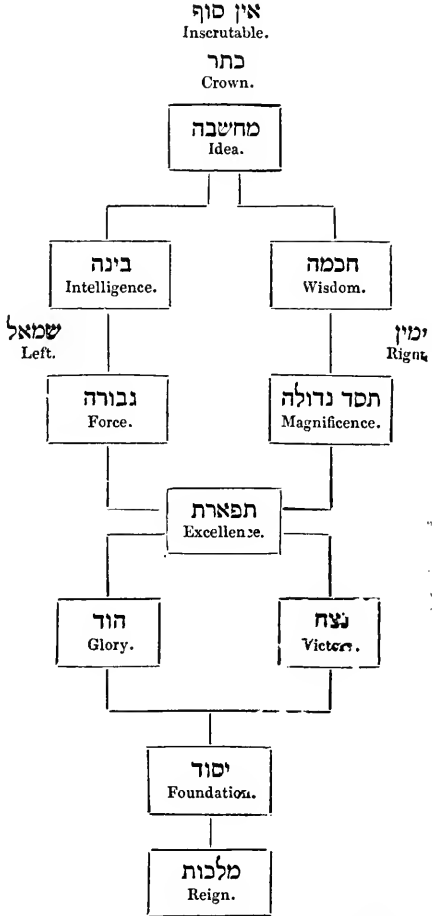

These attributes they call ספירות *Sephiroth* (numbered ones), and divide them into three upper (crown, wisdom, and intelligence) and seven lower. The first constitute the being of God, and the latter merely his virtues. Only the first three are called *intellects*, but not *attributes* (*Cabbala Denudata*).

Instead of giving the term *Sephiroth* an Hebrew derivation, from ספר *sophar*, 'to count,' 'number,' we would rather incline to assign it a Greek etymology, from σφαίρα, *globe, circle*, this *Sephiroth*-system representing among the cabalists the planetary system of ten spheres. The plural termination in *ת* it has in common with many similar words adopted by the Rabbins from the Greek; such as הדייטות, from *ἑδραίωσις*

מִן הַטְּוֹרָפִים from ἐπιτροπος, נִימוֹסִים from νομός, &c.—E. M.

GOEL. [BLOOD-REVENGE.]

GOG (גּוֹג) occurs Ezek. xxxviii. 3, 14, and xxxix. 11, as a proper name; that of a prince of *Magog* (מַגּוֹג), a people that were to come from the North to invade the land of Israel, and be there defeated. In a different sense, but corresponding with the assertions of other Oriental authors, in whose traditions this people occupy an important place, *Gog* occurs in Rev. xx. 8, as the name of a country.

Interpreters have given very different explanations of the terms *Gog* and *Magog*; but they have generally understood them as symbolical expressions for the heathen nations of Asia, or more particularly for the Scythians, a vague knowledge of whom seems to have reached the Jews in Palestine about that period. Thus Josephus (*Antiq.* i. 6. 3) has dropped the Hebrew word *Magog*, and rendered it by Σκύθαι; and so does Jerome, while Suidas renders it by Πέρσαι—a difference that matters but little in the main question, since Σκύθαι, in the ancient authors, is but a collective name for the northern but partially-known tribes (Cellar, *Notit.* ii. 753, sq.); and, indeed, as such a collective name, *Magog* seems also to indicate in the Hebrew the tribes about the Caucasian mountains (comp. Jerome on Ezek. *ibid.*). Bochart (*Phal.* iii. 13) supports the opinion of Josephus, though by but very precarious etymologies. According to Reinegge (*Descrip. of the Caucasus*, ii. 79) some of the Caucasian people call their mountains *Gog*, and the highest northern points *Magog*. The Arabians are of opinion that the descendants of *Gog* and *Magog* inhabit the northern parts of Asia, beyond the Tartars and

Slavonians, and they put **ياجوج وماجوج** always in conjunction, thereby indicating the extreme points of north and north-east of Asia (Bayer, in *Comment. Acad. Petrop.* i.; D'Herbelot, *Bibl. Orient.* p. 528). Nor are there wanting interpreters who understand by the *Gog* of Revelations the anti-Christ, and by the *Gog* of Ezekiel the Goths, who invaded the Roman empire in the 5th century of the Christian era.—E. M.

GOLAN (גּוֹלָן; Sept. Γαύλων) or GAULON, a Levitical town of Bashan, in the tribe of Manasseh (Deut. iv. 43; Josh. xx. 8; xxi. 27; 1 Chron. vi. 71), from which the small province of Gaulonitis (Γαυλωνίτις) took its name. The word is recognised in the present Jolan or Djolan, mentioned by Burckhardt (*Syria*, p. 286), as giving name to a district lying east of the lake of Tiberias, and composed of the ancient Gaulonitis, with part of Bashan and Argob. It is indeed clear, that the Gaulonitis of the later Jewish history must have included part of the more ancient Bashan, if Golan gave name to the province, seeing that Golan was certainly in Bashan. Some difficulty has been suggested as arising from the fact, that the Judas whom Josephus (*Antiq.* xviii. 1. 1) calls a Gaulonite, is called by St. Luke (Acts v. 37) a Galilæan. This is the more remarkable, as Josephus elsewhere (ex. gr. *De Bell. Jud.* ii. 20. 4) carefully distinguishes Galilee and Gaulonitis. Yet he himself elsewhere calls this very Judas a Galilæan (*Antiq.* xviii. 1. 6; xx. 5. 2; *De Bell.*

Jud. ii. 9. 1). It is, from this, probable that Judas had a double cognomen, perhaps because he had been born in Gaulonitis, but had been brought up or dwelt in Galilee; as Apollonius, although an Egyptian, yet was, from his place of residence, called Rhodius (see Kuinoel, *in Act.* v. 37).

GOLD. The Hebrew word זָהָב (*zahab*) is merely the mineralogical name of this metal, while the various kinds, in a purified state, are called כֶּתֶם, כֶּתֶם, כֶּתֶם, &c.

Gold was known and valued in very early times. Abraham was rich in gold (Gen. xiii. 2; xxiv. 35); and female ornaments were made of gold (Gen. xxiv. 22).

To judge from 1 Chron. xxii. 14; xxix. 4, the Jews must have been, in their palmy days, in possession of enormous quantities of this metal, considering the many tons of gold that were spent in the building of the temple alone, though the expression, *plenteous as stones* (2 Chron. i. 15), may be considered as hyperbolical. It is, however, confirmed by the history of the other Asiatic nations, and more especially of the Persians, that the period referred to really abounded in gold, which was imported in vast masses from Africa and the Indies (Heeren, *Ideen*, i. l. 37, sq.). The queen of Sheba brought with her (from Arabia Felix), among other presents, 120 talents of gold (2 Chron. ix. 9). The technical name of *goldsmiths* (צִרְפִּים *zorphim*) occurs for the first time in Judg. xviii. 4; and that of the *crucible* (מַצְרֵף *mazreph*) in Prov. xvii. 3. Both names are derived from the verb צָרַף *zoraph*, to purify (metal).—E. M.

GOLGOTHA (in Greek letters Γολγοθᾶ; in Aramæan ܓܘܠܓܘܬܐ). The original word signifies 'a skull,' as does its Latin representative, *Calvaria, Calvary*. Different opinions have prevailed as to why the place was so termed. Old fables assign as the reason, that Adam was interred at Golgotha, in order that where he lay who had effected the ruin of mankind, there also might the Saviour of the world suffer, die, and be buried (Reland, *Palæst.* p. 860). Many have held that Golgotha was the place of public execution, the Tyburn of Jerusalem; and that hence it was termed the 'place of a skull.' Another opinion is that the place took its name from its shape, being a hillock of a form like a human skull. The last is the opinion to which the writer of these remarks inclines. That the place was of some such shape seems to be generally agreed, and the traditional term *mount*, applied to Calvary, appears to confirm this idea. And such a shape, it must be allowed, is in entire agreement with the name—that is, 'skull.' To these considerations there are added certain difficulties which arise from the second explanation. So far as we know there is no historical evidence to show that there was a place of public execution where Golgotha is commonly fixed, nor that any such place, in or near Jerusalem, bore the name Golgotha. Nor is the term Golgotha descriptive of such a place; to make it so, to any extent, the name should have been 'skulls,' or 'the place of skulls.' Equally unapt is the manner in which the writers of the Gospels speak of the place: Matthew calls it 'a place called Golgotha; that is to say, a place of a skull;' Mark, 'the place Golgotha; which is,

being interpreted, the place of a skull; Luke, 'the place which is called Calvary;' John, 'a place called of a skull, which is called in the Hebrew Golgotha.' Now, no one of these descriptions is what would have been natural had Golgotha been a place or the place of public execution. An English writer would say, 'they took the criminal to Tyburn and executed him.' In the same manner would the biographers of Jesus have spoken—'they took him to Golgotha;' in such a case there was no need of explanations; and where Golgotha was every person would have known. In truth, the context seems to show that the Roman guard hurried Jesus away and put him to death at the first convenient spot; and that the rather because there was no small fear of a popular insurrection, especially as he was attended by a crowd of people. But where was the place? Not far, we may suppose from what has been said, from the judgment-hall, which was doubtless near the spot (Fort Antonia), where the Roman forces in Jerusalem were concentrated. From our plan of Jerusalem it will be seen that Fort Antonia lay on the north-west angle of the temple. Was it likely, then, that in the highly excited state of the public mind the soldiers should take Jesus southward; that is, through the whole breadth of the city? Somewhere in the north, it is clear, they would execute him, as thus they would most easily effect their object. But if they chose the north, then the road to Joppa or Damascus would be most convenient; and no spot in the vicinity would probably be so suitable as the slight rounded elevation which bore the name of Calvary. That some hillock would be preferred, it is easy to see, as thus the exposure of the criminal and the alleged cause of his crucifixion would be most effectually secured. But the particulars detailed by the sacred historians show that our Lord was not crucified on the spot, or very near the spot, where he was condemned, but was conducted some distance through the city. If so, this, as appears from our plan, must have been towards the west. Two points seem thus determined: the crucifixion was at the *north-west* of the city.

The account, as given in the Evangelists, touching the place of the crucifixion and burial of our Lord, is as follows:—Having been delivered by Pilate to be crucified, Jesus was led away, followed by a great company of people and women, who bewailed his fate. On the way the soldiers met one Simon, a Cyrenian, *coming out of the country*, who is compelled to bear Jesus' cross. When they were come to the place which is called Calvary, there they crucified him. This place was nigh to the city: and, sitting down, they watched him there. They that passed by reviled him, wagging their heads and scoffing. Likewise also the chief priests mocked him, with the scribes and elders; and the people stood beholding. The soldiers too mocked him. There stood by the cross of Jesus his mother, and his mother's sister, and Mary Magdalene. And all his acquaintance and the women that followed him from Galilee stood afar off, beholding these things. *In the place where he was crucified there was a garden, and in the garden a new sepulchre, hewn out in the rock; there laid they Jesus, and rolled a great stone to the door of the sepulchre.* The writer of the epistle to the Hebrews adds, that

Jesus suffered *without the gate*, subjoining, 'let us, therefore, go forth to him without the camp (or the city) bearing his reproach' (Heb. xiii. 12, 13; Matt. xxvii.; Mark xv; Luke xxiii.; John xix.).

We thus learn, as a positive fact, that the crucifixion and burial took place out of the city, and yet nigh to the city; and the statement of the writer to the Hebrews is confirmed by the incidental remark (Mark xv. 21), that the soldiers seized Simon, as he was 'coming out of the country.' It now appears, then, that Calvary lay at the north-west, and at the outside, of the city. The reader, on perusing the abstract just given of the evangelical narrators, combined with previous remarks, will find reason to think that Calvary was only just on the outer side of the second wall. It is also clear that the place was one around which many persons could assemble, near which wayfarers were passing, and the sufferers in which could be seen or addressed by persons who were both near and remote: all which concurs in showing that the spot was one of some elevation, and equally proves that 'this thing was not done in a corner,' but at a place and under circumstances likely to make Calvary well known and well remembered alike by the foes and the friends of our Lord. Other events which took place immediately after, in connection with the resurrection, would aid (if aid were needed) in fixing the recollection of the spot deep and ineffaceably in the minds of the primitive disciples.

Was it likely that this recollection would perish? Surely of all spots Calvary would become the most sacred, the most endearing, in the primitive church. The spot where Jesus was crucified, died, was buried, and rose again, must have been bound to the heart of every disciple in the strongest and most grateful bonds. We do not need history to tell us this; or, rather, there is a history—the history of man, of what human nature is, and feels, and loves—which declares the fact to every intelligent mind. Nor did the Jew, with his warm gushing affections, feel or such a point less vividly than his fellow men. 'The tombs of the prophets,' 'the sepulchre of David,' were, we read (Matt. xxiii. 29; Acts ii. 29), reverentially regarded, and religiously preserved from age to age. That of 'David's Lord' would assuredly not be neglected. It was a season of public religious festivity when our Lord suffered. Jerusalem was then crowded with visitors from foreign parts. Such too was the fact at the time of the effusion of the Holy Spirit. These pilgrims, however, soon returned home, and wherever they went many carried with them the news of the crucifixion of Jesus, and told of the place where he had been executed. When these had reached their homes they became, under Providential influences and the preaching of Apostles, in each case, a nucleus of an infant church, which would naturally preserve embedded in its heart the knowledge of Calvary. Perhaps no one spot on earth had ever so many to remember it and know its precise locality, as the place where Jesus died and rose again. First in Jerusalem, and soon in all parts of the earth, were there hearts that held the recollection among their most valued treasures.

We do not think these remarks need confirmation; but the passage in the Hebrews shows that

they are substantially correct. We there learn that far on in the first century Calvary was well known in the church; that the tradition was preserved, and preserved in so living a form as to be made the subject of a figurative illustration of Christian doctrine. The memory of distinguished places is among the least perishable of earthly things. Thermopylæ and Runnymede are yet, and will ever be, known. With how much more reason Calvary! At the first there were not only in Jerusalem and Palestine, but in all parts of the earth, hosoms which had found for it a shrine. Fathers would convey their knowledge and their impressions to sons; one generation and one church to another. The passage in the Hebrews would tend to keep alive the recollection. And thus from age to age there would be a regular transmission of the essential facts of the case, till at length the tradition became fixed in history, and a splendid edifice was raised in perpetual commemoration of the great events which rendered Golgotha the most remarkable spot on the wide earth. Before, however, we speak more of this edifice and this record, we must add that heathenism lent an aid to the Christian tradition. It was the fate of Jerusalem, after its capture by the Romans, to become a heathen city; even its name was changed into Colonia *Ælia Capitolina*. In the excess of their triumphant joy, the conquerors made Jupiter its patron God, and erected statues of Jupiter and Venus on the place where Jesus had been crucified (Sozomen, xi. 1). This was done not so much to insult as to conciliate. New-comers in religion have always availed themselves of established feelings, and therefore erected their sacred edifices on places already consecrated in the minds of the people. So was it when Christianity was planted in Great Britain. Many of our old churches stand on spots where stood before idolatrous temples. Such was the policy of the Romans. The mere fact of a temple to Venus standing on Calvary suffices to show that Calvary was the place where Jesus suffered. The temple thus takes up the tradition and transmits it in stone and marble to coming ages. This continuation of the tradition is the more important because it begins to operate at a time when the Christians were driven from Jerusalem. But the absence of the Christians from the holy city was not of long duration, and even early in the third century we find pilgrimages from distant places to the Holy Land had already begun, for the express purpose of viewing the spots which the presence and sufferings of the Saviour had rendered sacred and memorable (*Hist. Hierosol.* p. 591; Euseb. *Hist. Eccles.* vi. 11). A century later, Eusebius (A.D. 315) informs us that Christians visited Jerusalem from all regions of the earth for the same object. So early and so decided a current towards the holy city presupposes a strong, wide-spread, and long pre-eminent feeling—an established tradition in the church touching the most remarkable spots; a tradition of that nature which readily links itself with the actual record in Hebrews.

Early in the fourth century Eusebius and Jerome write down the tradition and fix the locality of Calvary in their writings. Eusebius was born at Cæsarea, in Palestine, about A.D. 270. In 315 he became a bishop in his native country, and died in 340. He was a most learned man, and

wrote a history of the Christian church. About 330 he composed his *Onomasticon*, which was expressly devoted to the business of determining and recording the sites of holy and other places in Palestine. This work of Eusebius, written in Greek, Jerome afterwards translated into Latin, and thus added his authority to that of Eusebius. Jerome took up his residence in the Holy Land in the latter part of the fourth century, and remained there till his death (for an estimate of the value of these geographical authorities see Reland, *Palæst.* p. 467, sq.). Pilgrims now streamed to Jerusalem from all parts of the world, and that site was fixed for Golgotha which has remained to the present hour.

This was done not merely by the testimony of these two learned fathers, but by the acts of the Emperor Constantine and his mother Helena. This empress, when very far advanced in life, visited Jerusalem for the express purpose of erecting a church on the spot where the Lord Jesus had been crucified. The preceding details show that the preservation of the memory of the locality was anything but impossible. Helena would naturally be solicitous to discover the true spot: whence ensues the likelihood that she was not mistaken. She had previously heard that the holy places had been heaped up and concealed by the heathen, and resolved to attempt to bring them to light, *εἰς φῶς ἀγαγεῖν* (Theoph. in *Chron.* p. 18; quoted in Reland, *Palæst.* under 'Golgotha'). 'On her arrival at Jerusalem she inquired diligently of the inhabitants. Yet the search was uncertain and difficult, in consequence of the obstructions by which the heathen had sought to render the spot unknown. These being all removed, the sacred sepulchre was discovered, and by its side three crosses, with the tablet bearing the inscription written by Pilate' (Robinson, *Bibl. Res.* ii. 14; Theodoret, i. 17). This account of her proceedings taken from one who labours to bring into discredit the whole of Helena's proceedings, and who is far too indiscriminate and sweeping in his hostility to the *primitive* traditions of the church, shows sufficiently that Helena was cautious in her proceedings, that there did exist a tradition on the subject, that by that tradition the empress was guided, and that she found reason to fix the site of Calvary on the spot where the heathen had erected their temple and set up their profane rites. That no small portion of the marvellous, not to say legendary and incredible, is mixed up in the accounts which the ecclesiastical historians have given, we by no means deny; but we see no reason whatever, and we think such a course very unphilosophical, to throw doubt unsparingly over the whole, as (by no means in the best taste) does Dr. Robinson. However, on the site thus ascertained, was erected, whether by Constantine or Helena, certainly by Roman influence and treasure, a splendid and extensive Christian temple. Socrates (*Eccles. Hist.* i. 17) says, 'the emperor's mother erected over the place where the sepulchre was a most magnificent church, and called it new Jerusalem, building it *opposite to that old deserted Jerusalem*.' This church was completed and dedicated A.D. 335. It was a great occasion for the Christian world. In order to give it importance and add to its splendour, a council of bishops was convened, by order of the emperor, from all the provinces of the empire, which as-

sembled first at Tyre, and then at Jerusalem. Among them was Eusebius, who took part in the solemnities, and held several public discourses in the holy city (Euseb. *Vit. Const.*; Robinson, ii. 13). The reader's attention is directed to the words above cited from Socrates, by which it appears that the church was built not in the old city, but opposite to it (*ἀντιπρόσωπον*). In this description Socrates is borne out by Eusebius (*Vit. Const.* iii. 33). A reference to the plan will show that such an account of its site corresponds with the locality on which the crucifixion and interment took place. The church of the holy sepulchre was burnt by the Persians in A.D. 614. It was shortly after rebuilt by Modestus with resources supplied by John Eleemor, patriarch of Alexandria. The Basilica or Martyrion erected under Constantine remained as before. The Mohammedans next became masters of Jerusalem. At length Harun er Rashid made over to Charlemagne the jurisdiction of the holy sepulchre. Palestine again became the scene of battles and bloodshed. Muezz, of the race of the Fatimites, transferred the seat of his empire to Cairo when Jerusalem fell into the hands of new masters, and the holy sepulchre is said to have been again set on fire. It was fully destroyed at the command of the third of the Fatimide kalifs in Egypt, the building being razed to the foundations. In the reign of his successor it was rebuilt, being completed A.D. 1048; but instead of the former magnificent Basilica over the place of Golgotha, a small chapel only now graced the spot. The crusades soon began. The crusaders regarded the edifices connected with the sepulchre as too contracted, and erected a stately temple, the walls and general form of which are admitted to remain to the present day (Robinson, ii. 61). So recently, however, as A.D. 1808 the church of the holy sepulchre was partly consumed by fire; but being rebuilt by the Greeks, it now offers no traces of its recent desolation.

We have thus traced down to the present day the history, traditional and recorded, of the buildings erected on Golgotha, and connected these edifices with the original events by which they are rendered memorable. To affirm that the evidence is irresistible may be going too far. Not less blameworthy is the carping and inculpatory tone pursued by Robinson in his review of the subject. Few antiquarian questions rest on an equally solid basis, and few points of history would remain settled were they subject to the same sceptical, not to say unfair, scrutiny which Robinson has here applied.

The sole evidence of any weight in the opposite balance is that urged by Robinson, that the place of the crucifixion and the sepulchre are now found in the midst of the modern city. But to render this argument decisive it should be proved that the city occupies now the same ground that it occupied in the days of Christ. It is, at least, as likely that the city should have undergone changes as that the site of the crucifixion should have been mistaken. The identity of such a spot is more likely to be preserved than the size and relative proportions of a city which has undergone more violent changes than probably any other place on earth. The present walls of Jerusalem were erected so late as A.D. 1542; and Robinson himself remarks, *en passant*, that a part of Zion is

now left out (p. 67). If, then, the city has been contracted on the south, and if, also, it was after the death of Christ expanded on the north, what should we expect but to find Golgotha in the midst of the modern city?

Jerusalem in the days of Christ had two walls, those termed in our plan of Jerusalem 'first' and 'second.' It is with the second wall that we are here chiefly concerned. It began at a tower, named Gennath, of the first wall, curved outward to the north, and ended at the castle of Antonia. The third wall ran as on the plan, embracing a wide suburb on the north and northwest. This comprehended a sort of new city, and was built in consequence of the large population which by degrees fixed their abode in the space which falls between the second and third walls. This wall was begun under Claudius, at least forty-one years after Christ (Joseph. *De Bell. Jud.* v. 4. 2; comp. Tacit. *Hist.* v. 12). This third wall, then, did not exist in the time of our Lord; and Robinson allows that if the present site of the sepulchre fell without the second wall, all the conditions of the general question would be satisfied. Our plan of the city shows that it may have fallen without the second wall. The city bulged out on the north, as it contracted on the south, thus bringing Golgotha into its central parts. Robinson, however, asserts that the second wall must either have excluded the pool of Hezekiah, which was in the city, or included the site of the sepulchre, which was out of the city. In our plan the second wall does neither, but leaves both where the Scriptures place them. But the distance from the western point of the temple to the present site of the sepulchre Robinson considers insufficient, it being only about a quarter of a mile. We know not that there is anything in Scriptural account which gives support to this notion. A distance of a quarter of a mile appears quite enough for the recorded events, to say nothing of the essential weakness of such a position; for how can Robinson know that his measures extended along the same ground as our Lord was hurried over? But reason has already been given why the Jews should have taken no very protracted course.

Two or three additional facts in confirmation of the identity of the present place may, finally, be adduced. Buckingham (*Palest.* p. 283) says, 'the present rock called Calvary, and enclosed within the church of the holy sepulchre, bears marks in every part that is naked of its having been a round nodule of rock standing above the common level of the surface.' Scholz (*De Golgotha situ*, p. 9) states that he traced the remains of a wall, which ran as the second wall on the plan runs, excluding Golgotha and taking in the pool of Hezekiah (Räumer, p. 352). It may also be remarked that since the publication of Robinson's work Räumer has put forth a piece (*Beitrag zur Bib. Geog.* 1843) in which he revises his *Palästina* so far as Robinson's ascertained results render necessary; but he remains of the same opinion in regard to the possibility of the present church of the sepulchre being out of the city. At most, a very few hundred yards only can the original Golgotha have lain from the present site, and the evidence in favour of its identity, if not decisive, is far stronger than any that has been adduced against it. At the best, then, very small

Is the reason for disturbing the convictions and distressing the hearts of the sincere believers who visit the holy sepulchre in order to give vent to their tearful gratitude and cherish their pious faith.—J. R. B.

GOLIATH. [GIANT.]

GOME (𐤂𐤌), translated 'rush' and 'bulrush,' is mentioned in four places of Scripture, from which there is no doubt that it was a plant growing in moist situations in Egypt, and employed in the construction of vessels of different kinds, intended to float upon the water, such as the ark in which Moses was hid, and vessels for transit (Job viii. 11; Isa. xxxv. 7; Exod. ii. 3; Isa. xviii. 2). The name *gome*, according to Celsius (*Hierobot.* vol. ii. p. 138), is derived from 𐤂𐤌 *gimme*, 'absorbere, bibere, quia in aqua nascitur, et aquam semper imbibit.' Though other plants are adduced by translators and commentators as the *gome* of Scripture, yet it is evident that only the *papyrus* can be meant, and that it is well suited to all the passages. Being in some respects so obvious, it could not escape the notice of all translators. Hence, in the Arabic Version, and in the *Annals of Eutychius*, the

word 𐤁𐤓𐤃 *burdee* is given as the synonym of *gome* in Exod. ii. 3. The Sept. in Job (viii. 11) gives 𐤁𐤓𐤃, in Isaiah (xviii. 2) 𐤁𐤓𐤃, and the Vulgate, in this last passage, *papyrus*. In Arabic authors on *Materia Medica*, we find the *papyrus* mentioned under the three heads of *Fafeer*, *Burdee*, and *Chartas*. *Fafeer* is said to be the Egyptian name of a kind of *burdee* (bur-reed) of which paper (*charta*) is made; and of *burdee*, the word *fafurus* (evidently a corruption of *papyrus*) is given as the Greek synonym.

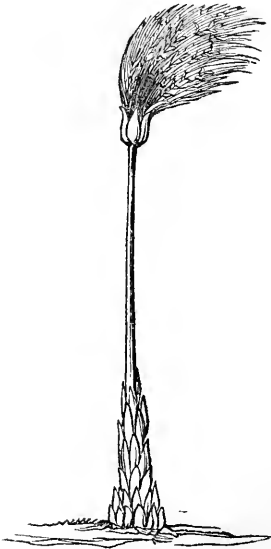

331.

The *papyrus* is now well known: it belongs to the tribe of *sedges* or *cyperaceæ*, and is not a rush or bulrush, as in the Authorized Version. It may be seen growing to the height of six or eight

feet, even in tubs, in the hothouses of this country, and is described by the ancients as growing in the shallow parts of the Nile. The root is fleshy, thick, and spreading; the stems triangular, eight or ten feet in height, of which two or so are usually under water, thick below but tapering towards the apex, and destitute of leaves; those of the base broad, straight, and sword-shaped, but much shorter than the stem. This last is terminated by an involucre of about eight leaves, sword-shaped and acute, much shorter than the many-rayed umbel which they support. The secondary umbels are composed only of three or four short rays, with an involucre of three awl-shaped leaflets. The flowers are in a short spike at the extremity of each ray. Cassiodorus, as quoted by Carpenter, graphically described it as it appears on the banks of the Nile, 'There rises to the view this forest without branches, this thicket without leaves, this harvest of the waters, this ornament of the marshes.'

The *papyrus* was well known to the ancients as a plant of the waters of Egypt. 'Papyrus nascitur in palustribus Ægypti, aut quiescentibus Nili aquis, ubi evagatæ stagniant' (Pliny, xiii. 11). Theophrastus, at a much earlier period, described it as growing, not in the deep parts, but where the water was of the depth of two cubits, or even less. It was found in almost every part of Egypt inundated by the Nile, in the Delta, especially in the Sebennytic nome, and in the neighbourhood of Memphis, &c. By some it was thought peculiar to Egypt; hence the Nile is called by Ovid 'amnis papyrifera.' So a modern author, Prosper Alpinus (*De Plant. Ægypti*, c. 36):—'Papyrus, quam *berd* Ægyptii nominant, est planta fluminis Nili.' By others it was thought to be a native also of India, of the Euphrates near Babylon, of Syria, and of Sicily. The genus *cyperus*, indeed, to which it is usually referred, abounds in a great variety of large aquatic species, which it is difficult for the generality of observers to distinguish from one another; but there is no reason why it should not grow in the waters of hot countries, as, for instance, near Babylon or in India. In fact, modern botanists having divided the genus *cyperus* into several genera, one of them is called *papyrus*, and the original species *P. nilotica*. Of this genus *papyrus* there are several species in the waters of India (Wight, *Contributions to the Botany of India*, Cyperæ, p. 88).

A brief description of the uses of this plant, as given in the works of the ancients, is thus summed up by Parkinson in his *Herbal*, p. 1207: 'The plant, say the ancients, is sweete, and used by the Egyptians, before that bread of corne was known unto them, for their food, and in their time was chewed, and the sweetness sucked forth, the rest being spit out; the roote serveth them not only for fewell to burne, but to make many sorts of vessels to use, for it yielded much matter for the purpose. *Papyrus ipse* (say they), that is the stalke, is profitable to many uses, as to make ships, and of the barke to weave, and make sailes, mats, carpets, some kinds of garments, and ropes also.' The construction of *papyrus* boats is mentioned by Theophrastus: so Pliny (*Hist. Nat.* vi. 24), 'Papyraceis navibus armentisque Nili;' and again (vii. 56), 'Naves primum repertas in Ægypto in Nilo ex papyro.' Plutarch, as quoted by Rosenmüller,

says, 'Isis circumnavigated the marshes in a *papyrus* wherry for the purpose of collecting the pieces of Osiris's body. From Heliodorus's account it appears that the Ethiopians made use of similar boats; for he relates that the Ethiopians passed in reed wherries over the Astaboras; and he adds that these reed wherries were swift sailing, being made of a light material, and not capable of carrying more than two or three men.' Bruce relates that a similar kind of boat was made in Abyssinia even in his time, having a keel of acacia wood, to which the *papyrus* plants, first sewed together, are fastened, being gathered up before and behind, and the ends of the plants thus tied together. Representations of some Egyptian boats are given in the *Pictorial Bible* (ii. p. 135); where the editor remarks that when a boat is described as being of reeds or rushes or *papyrus* (as in Egypt), a covering of skin or bitumen is to be understood. That the *papyrus* was employed for making paper is also well known, and Wilkinson mentions that from ancient paper being found at Thebes and elsewhere, it is evident that this application of it was much anterior to the time of Alexander the Great.—J. F. R.

GOMER (גֹּמֶר). 1. The eldest son of Japhet, son of Noah, whose descendants Bochart (*Phal.* iii. 8) supposes to have settled in Phrygia (Gen. x. 3; comp. 1 Chron. i. 5). Most of the interpreters take him to be the ancestor of the Celtæ, and more especially of the *Cimmerii*, Κιμμέριοι, who were already known in the time of Homer (*Odys.* xi. 14). To judge from the ancient historians (Herodotus, Strabo, Plutarch, &c.), they had in early times settled to the north of the Black Sea, and gave their name to the Crimea, the ancient *Chersonesus Taurica*. But the greater part of them were driven from their territories by the Scythians, when they took refuge in Asia Minor, B. C. 7.

In the Scriptures, however, the people named Gomer imply rather an obscure and but vaguely known nation of the barbarous north (Rosenmüller, *Alterth.* i. 1. 235, sq.)

Josephus (*Antiq.* i. 6. 1) says expressly, that the ancestor of the Galatians, a Celtic colony, was called Gomer (Michael. *Suppl.* p. 335, sq.). The Jerusalem Targum gives Gen. x. 3 with גֹּמֶרִיקִי *Africanus*; Arab. تارقي *Turca*.

2. The name of the daughter of Diblaim, wife of the prophet Hosea (Hosea i. 3).—E. M.

GOMÖRRHA, one of 'the cities of the plain,' destroyed along with Sodom. An account of that catastrophe is given under SONOM.

GOPHER WOOD (עֵץ גֹּפֶר, *etz-gopher*) is mentioned only once in Scripture, as the material of which Noah was directed to build the ark (Gen. vi. 14), 'Make thee an ark of gopher wood; rooms shalt thou make in the ark, and shalt pitch it within and without with pitch' (*khemar*, probably 'bitumen'). In endeavouring to ascertain the particular kind of wood which is mentioned in the above passage, we can get assistance only from the name, the country where the wood was supposed to have been procured, or the traditional opinions respecting it. That nothing very satisfactory has been ascertained is evident from the various interpretations that have been given of this word, so that some have preferred, as in our Authorized Version, to retain the original Hebrew.

The Septuagint renders it 'squared timbers,' αὐτὸς Jerome, in the Vulgate, renders it 'planned wood' and 'pitched wood.' Some have adopted the opinion that a kind of pine-tree is intended; and others that several species may be included, as they all yield resin, tar, and pitch. The Persian translator has also adopted the pine; but Celsius objects that it was never common in Assyria and Babylonia. The Chaldee version and others give the cedar, because it was always plentiful in Asia, and was distinguished by the incorruptible nature of its wood. But cedar is a very general term, and correctly applied, as we have seen [ERES], only to different kinds of juniper. These, though yielding excellent wood, remarkable for its fragrance, never grow to a large size in any warm country. Eutychius, patriarch of Alexandria, relates in his *Annals* (p. 34), as quoted by Celsius (*Hierobot.* i. p. 331), that the ark was made of a wood called *sag* or *saj* صن خشب الساج. The

sag or *saj* has been thought by some to be the ebony, but apparently without any foundation. Still less is there any likelihood of its being a shrub like *juniperus sabina*, as indicated in a note by Rosenmüller, Eng. transl. p. 261. It is curious, as already alluded to in the *Essay on the Antiquity of Hindoo Medicine*, as mentioned by Forskal, that the woods imported from India into Arabia are *saj*, *abnoos* (ebony) and *sissoo* (*Dalbergia sissoo*). Some Persian writers on *Materia Medica* consider *saj* to be the *sāl* (*shorea robusta*), another valued and much used Indian timber tree, but common only along the foot of the Himalayan mountains. The *teak* is the best known and the most highly valued timber tree on the Malabar coast, and it has long been imported into Arabia, and also into Egypt. One of the names by which it is known in India is *sagoon*. The *saj* is described in some Persian works, chiefly translations from the Arabic, as having large leaves like elephants' ears. This applies well to the leaves of the *teak* tree; and there is little doubt, therefore, that the *saj* of Arab authors is the *teak* tree. With respect to its being the gopher wood, the present writer has already remarked in the above work: 'The gopher wood of Scripture is so differently translated by different commentators, that it is difficult to form even a conjecture on the subject; besides being used so early a period, and mentioned only once. It need not have been alluded to, except that the Arabic version translates it *saj*, which is the *teak*, and not likely to have been the wood employed.' The Chaldee Samaritan translator, for *gopher*, gives, as a synonym, *sisam*, of which Celsius says (*Hierobot.* i. p. 332), 'Vocem obscuram, sive referas ad ξύλα σαμάμινα, quæ ex Indiis adferri scribit Arrianus (*Peripl. Mar. Erythr.* p. 162), et Ebeno similia perhibent alii (Salmas. in *Solin.* p. 727).' The *sisam* is probably the above *sissoo*, mentioned by Forskal as imported in his time into Arabia, and which is a highly-valued, dark-coloured wood, of which one kind is called blackwood (*Dalbergia latifolia*). The greatest number of writers have been of opinion that by the gopher wood we are to understand the cypress; and this opinion is supported by such authorities as Fuller in his *Sacred Miscellanies*; Bochart (*Geogr. Sacra*); as well as by Celsius,

Hierobot. It has been stated that the letters *g* and *ph*, *k* and *p*, differ only in the soft or hard manner in which they are pronounced, and therefore that *gopher* and *kupar* differ very little in sound, and that *ισσοῖς* in the Greek *κνυπίσσιος* is a mere addition to the root. It is argued further that the wood of the cypress, being almost incorruptible, was likely to be preferred; that it was frequently employed in later ages in the construction of temples, bridges, and even ships; and that it was very abundant in the countries where, according to these authors, the ark is supposed to have been built, that is, in Assyria, where other woods are scarce. But wherever the ark was built, there would be no deficiency of timber if there was a certain degree of moisture with warmth of climate; and we know not what change of climate may have taken place at the Deluge. The pine tribe, including the cypress, appears as likely as any other to have been employed, usually growing as they do in extensive forests, and yielding straight and easily worked timber, calculated, from its resinous nature, effectually to resist moisture, especially if covered with pitch and tar, which might easily have been prepared from the refuse branches and timber, and used as well as the natural bitumen. But the whole of these suggestions amount only to conjectures, and there seems no possibility of arriving at a satisfactory conclusion.—J. F. R.

GOSHEN (גֹּשֶׁן; Sept. Γεσέν, Γεσέμ), a province or district of Egypt in which Jacob and his family settled through the instrumentality of his son Joseph, and in which they and their descendants remained for a period of 430 years (Gen. xlv. 10; xlv. 28; xlvii. 27; l. 8; Exod. viii. 22; ix. 26). The Bible does not present any definite information as to the precise locality of Goshen, and of course later authorities possess only an inferior value. There are, however, incidental expressions, allusions, and implications in the Scriptures, which afford aid in determining the spot. That Goshen lay on the eastern side of the Nile may be justifiably inferred from the fact that Jacob is not reported to have crossed that river; nor does it appear that the Israelites did so in their flight out of Egypt. With this inference all the language employed (see the passages as given above), to say the least, agrees, if it does not afford an indirect evidence in its favour. By comparing Exod. xiii. 17 and 1 Chron. vii. 21, it appears that Goshen bordered on Arabia (see Gen. xlv. 10, Sept. Γεσέμ Ἀραβίας) as well as Palestine, and the passage of the Israelites out of Egypt shows that the land was not far removed from the Red Sea. It appears probable that we may fix the locality of Goshen in Lower Egypt, on the east side of the Pelusiatic branch of the Nile, in the district around Heroopolis. The Septuagint renders the words גֹּשֶׁן מִצְרָיִם 'land of Goshen' (Gen. xlv. 28), καθ' Ἡρώων πόλιν, εἰς γῆν Παρμεσσῆ, thus identifying Goshen with Rameses, or the district of Pithom or Heroopolis. (See map, No. 3, in Knight's Illuminated Atlas.) This would make Goshen correspond with one of the divisions of what was anciently termed the Præfectura Arabica, Ti-Arabia, the eastern district, lying, that is, on the eastern or Arabian side of the Nile. This division was that of Heliopolis or On, Matariyeh, or Ain-Shems.

An attempt has been made to define it accurately, so as to identify Goshen (Roseum. *Alterthum.*, iii. 246) with the Nomos Arabia (Ptol. iv. 5), or the country of Esch-schar Kijah (the eastern land), which stretches south from Pelusium as far as Belbeis (north-east from Cairo), and to the north-east borders of the desert El Dschehar. Traces are found here, it is thought, of the residence of the Israelites, in large heaps of ruins, a few hours' journey to the north-east of Cairo, which the Arabs call *Tell el Jhud* (Jews' hills), or *Turbah el Jhud* (Jews' graves) (Niebuhr, i. 100). According to Bois Aymé (*Descrip. de l'Égypte*, viii. 111) Goshen was the valley Sabal-yar, which begins in the vicinity of Belbeis, and embraces the district of Heroopolis. Robinson (*Palestine*, i. 37) makes light of the evidence supposed to be supplied by 'the mounds of the Jews,' just mentioned. He says, 'If there is any historical foundation for this name, which is doubtful, these mounds can only be referred back to the period of the Ptolemies, in the centuries immediately before the Christian era, when great numbers of Jews resorted to Egypt and erected a temple at Leontopolis.' This opinion, however, appears to us somewhat arbitrary. And whatever the actual origin of these mounds, the ordinary account of them may be the transmission or echo of a very ancient tradition. Robinson, however, does not deny that Goshen is to be found about where the best authorities ordinarily place it, as will appear from the following quotation; we regret that the wish here spoken of was not fulfilled: 'It had been our wish to take a more circuitous route from Suez to Cairo, descending the eastern branch or canal of the Nile beyond Belbeis, as far as to the province of Shur-kiyeh, and thence along the valley of the ancient canal to the head of the gulf of Suez. Our object in taking this route would have been to make inquiries and observations personally in relation to the land of Goshen and the Exodus of the Israelites' (i. 54). The following passage, however, will serve to prove that even the desert is not unsuited to pastoral purposes:—'The desert which we were now crossing is not sandy, but its surface, for the most part, is a hard gravel, often strewn with pebbles. Numerous wadys, or shallow water-courses, intersect its surface. In all these wadys there are usually to be found scattered tufts of herbs or shrubs, on which the camels browse as they pass along, and which serve likewise as their pasturage when turned loose at night. During the rainy season and afterwards, the inhabitants of Belbeis and the Shur-kiyeh, as probably did the Israelites of old, still drive their mingled flocks of sheep and goats for pasturage to this quarter of the desert.'

Laborde (*Arabia Petrea*, p. 58) fixes Goshen in the country around Belbeis, on the eastern side of the Nile. Speaking of his journey from Cairo by Belbeis to Suez, he says, 'This plain is the province of Goshen, where the children of Egypt settled and multiplied; it was here that the meeting occurred between Jacob, the patriarch, and Joseph, the minister and master of Egypt.' Laborde passed the banks of the canal which formerly united the Nile with the Red Sea, and which, he says, Bonaparte was the first in modern times to observe. M. Quatremère has endeavoured to define the locality, and by comparing several pas-

sages collected from different writers, he infers that the Wady Tumilat (Wady Tamlate in Laborde) in which the canal of Cairo terminates is the land of Goshen: such at least seems to have been the opinion of Saadias and Abu Saïd, the authors of the earliest Arabic Versions of the Old Testament—the one for the use of the Jews, and the other for that of the Samaritans (*Mém. Géogr. sur l'Égypte*). J. D. Michaelis was of opinion (*Spicil.* p. 371) that Goshen extended from Palestine along the Mediterranean as far as the Tanitic mouth of the Nile, and thence inland up to Heliopolis, embracing a sweep of country so as to take in a part of Arabia, bordering on Egypt. The various opinions that have been held on the subject may be found classified and considered by Bellermann in his *Handb. d. Bibl. Lit.* iv. 191-220 (see also Jablonsky, *Dissert.* viii. *de Terra Gosen*).

This district was suitable for a nomadic people, who would have been misplaced in the narrow limits of the valley of the Nile. Children of the desert, or at least used as they were to wander freely from one fertile plain to another with their flocks and herds, the sons of Jacob required a spot where the advantages of an advanced civilization could be united with unrestricted freedom, and abundance be secured without the forfeiture of early and cherished habits. The several opinions which we have given substantially agree in referring Goshen to the country intervening between the desert of Arabia and Palestine on the one side, and the Pelusiac arm of the Nile on the other, with the Mediterranean at the base. The district assigned to Jacob and his family was chosen for its superiority (Gen. xlvii. 6), 'In the best of the land make thy father and brethren to dwell, in the land of Goshen let them dwell;' and the subsequent increase of the Israelites themselves, as well as the multiplication of their cattle, shows that the territory was one of extraordinary fertility. Time and circumstances have doubtless had their effect on the fertility of a country in which the desert is ever ready to make encroachments so soon as the repelling hand of man is relaxed or withdrawn. But Laborde (p. 53) represents the vicinity of Heliopolis as still covered with palm-trees, and as having an enclosure, comprehending a considerable space of ground, which is covered every year by the inundation of the Nile to the height of five feet. We are not, however, to expect evidences of luxuriant fertility. The country was chosen for its pre-eminent fitness for shepherds. If a nomadic tribe had wide space and good pasture-grounds, they would have 'the best (for themselves) of the land,' and these advantages the district in which we have placed Goshen abundantly supplied in ancient times, when the waters of the Nile were more liberally dispensed than at present to the eastern side of the country. Nothing is needed but water to make the desert fertile. 'The water of the Nile soaks through the earth for some distance under the sandy tract (the neighbourhood of Heliopolis), and is everywhere found on digging wells eighteen or twenty feet deep. Such wells are very frequent in parts which the inundation does not reach. The water is raised from them by wheels turned by oxen and applied to the irrigation of the fields. Whenever this takes place the desert is turned into a fruitful

field. In passing to Heliopolis we saw several such fields in the different stages of being reclaimed from the desert; some just laid out, others already fertile. In returning by another way more eastward, we passed a succession of beautiful plantations wholly dependent on this mode of irrigation' (Robinson's *Palestine*, vol. i. p. 36).—

J. R. B.

GOSPEL. The Greek word *εὐαγγέλιον*, *glad tidings*, is translated in the English Version by the word *Gospel*, viz., *God's spell*, or the *Word of God*. The central point of Christian preaching was the joyful intelligence that the Saviour had come into the world (Matt. iv. 23; Rom. x. 15); and the first Christian preachers, who characterized their account of the person and mission of Christ by the term *εὐαγγέλιον*, were themselves called *εὐαγγελισταί* (Eph. ii. 11; Acts xxi. 8). The former name was also prefixed to the written accounts of Christ; and as this intelligence was noted down by various writers in various forms, the particle *κατὰ* (e. g. *εὐαγγέλιον κατὰ Ματθαίου*) was inserted. We possess four such accounts; the first by Matthew, announcing the Redeemer as the promised King of the Kingdom of God; the second by Mark, declaring him 'a Prophet mighty in deed and word' (Luke xiv. 19); the third by Luke, of whom it might be said that he represented Christ in the special character of the Saviour of sinners (Luke vii. 36, sq.; xv. 18-9, sq.); the fourth by John, who represents Christ as the Son of God, in whom deity and humanity became one. The ancient church gave to Matthew the symbol of the lion, to Mark that of man, to Luke that of the ox, and to John that of the eagle; these were the four faces of the cherubim. The cloud in which the Lord revealed himself was borne by the cherubim, and the four Evangelists were also the bearers of that glory of God which appeared in the form of man.

Concerning the order which they occupy in the Scriptures, the oldest Latin and Gothic Versions, as also the Codex Cantabrigiensis, place Matthew and John first, and after them Mark and Luke, while the other MSS. and old versions follow the order given to them in our Bibles. As dogmatical reasons render a different order more natural, there is much in favour of the opinion that their usual position arose from regard to the chronological dates of the respective composition of the four gospels: this is the opinion of Origen, Irenæus, and Eusebius. All ancient testimonies agree that Matthew was the earliest, and John the latest Evangelist. The relation of the Gospel of John to the other three Gospels, and the relation of the Gospels of Matthew, Mark, and Luke to each other, is very remarkable. With the exception of the history of the Baptist, and that of Christ's passion and resurrection, we find in John not only narratives of quite different events, but also different statements even in the above sections, the strongest of which is that relating to the crucifixion of Christ, which—according to the first three Gospels—took place on the first day of the Passover, while, to judge from John xiii. 1, 29; xviii. 28; xix. 14, 31, it would appear that it had taken place on the eve of the day on which the passover was to be eaten, but which was either not eaten at all by our Lord, or was anticipated by him by a day. On the other hand, the

first three Evangelists not only tolerably harmonize in the substance and order of the events they relate, but correspond even sentence by sentence in their separate narratives (comp. *ex. gr.* Mark i. 21-28 with Luke iv. 31-37; Matt. viii. 31-34; Mark vi. 34; v. 17; Luke viii. 32-37, etc.). The thought that first suggests itself on considering this surprising harmony is, that they all had mutually drawn their information from one another. Thus Grotius, *ex. gr.*, is of opinion that Matthew was the oldest source, and that Mark drew his information both from Matthew and Luke; again, according to Büsching, Luke was the oldest, and Matthew made use of Luke and Mark; while most critics in Germany have adopted the view of Griesbach, that Matthew was the oldest, and was made use of by Luke, and that Mark derived his information both from Matthew and Luke. Following the suggestion of Rore, some of the most modern critics, such as Weisse, Wilke (in his work entitled *Ur-evangelist*, 1838), and Bauer, are, on the other hand, of opinion that Mark was the original evangelist, and that Matthew and Luke derived their information from him. The difference of these opinions leads to the suspicion that none of them are right, more especially when we consider that, notwithstanding the partial harmony of the three evangelists in the choice of their sentences, there is still a surprising difference in them as regards the words of those sentences; a fact which compelled the critics who suppose that the evangelists made use of each other's writings, to account everywhere for such deviations, and frequently to have recourse to the most trivial and pedantic arguments. To us these differences in word and phrase would appear inconceivable were we disposed to assume that the evangelists had copied one another.

Wilke has tried, with great show of learning and much confidence, to defend his opinion, that Mark's Gospel was the primitive text; but Wilke also is obliged to have recourse to the most artificial hypotheses; one of which is, that even Mark has subsequently been extended by glossarial additions, because he could account in no other way for the omission of Matthew and Luke to copy the seven sections peculiar to Mark. Another difficulty, viz. that the text of Matthew often harmonizes more with the text of Luke than with that of Mark, he is obliged to meet by assuming that Matthew reformed the text of Mark in conformity with that of Luke, etc. These difficulties led to the supposition, already brought forward by Le Clerc, Semler, and Lessing, that there existed originally a *Protevangeli*um, or primitive Gospel, composed by the Apostles in the Aramæan language, which was afterwards variously recast in the Greek tongue by authors who made use of each other. This hypothesis was particularly developed by Eichhorn and Marsh, but is now again generally relinquished on account of the serious objections against it.—1. By this hypothesis it is assumed that the parts in which all the three harmonize existed in the original evangelium, while the *plus* consists of additions by the separate writers. Now, how are we to account, in a natural way, for their frequent harmony in these additions also? This objection can only be answered in a very artificial manner. 2. The chronological order would thus remain

the same. 3. Luke in his proœmium does not mention an original evangelium, but, on the contrary, speaks of various reports from eye-witnesses. 4. It is not likely that the knowledge of such original evangelium should not have been preserved for some time; but none of the ancient writers know anything about it.

Herder suggested another hypothesis, which has been very ably defended by Gieseler, in his work *Ueber die Entstehung und frühesten Schicksale der Evangelien*, 1818; namely, that our written gospels are founded upon a cyclus of oral traditions; that the original witnesses of the life of our Lord at first confined the narration of their testimony to Jerusalem and Judæa, where the facts which had occurred in Galilee were little known; and that by frequently repeating these accounts, not only a certain sphere of facts, but also of phrases, and partially also of words, became the fixed standard for these narrations, without, however, encroaching altogether on the free choice of the narrator. But this assumption, likewise, is liable to objections:—1. If the Apostles had really fixed for the primitive oral gospel a certain set of facts, how does it happen, then, that the evangelists disagree so much in their chronological arrangement? (comp. Luke iv. 16, sq. with Matt. xiii. 53, sqq.). 2. If the cycle of traditions was fixed by the Apostles, why, then, does John so entirely deviate from it? 3. According to Papias, Mark collected what Peter preached as circumstances required. Papias states that on this account Peter could not have written a complete *σύνταξις*. Does it not follow from this that Peter had no fixed standard, or pattern, or cycle for his preaching? 4. According to Luke i. 1, 2, several earlier writers had put together (*ἀνατάσσασθαι*) into a narration the facts told to them by eye-witnesses. Does this not indicate that it was the writers who first brought into connection the accounts of the eye-witnesses? These arguments are, however, not quite incontrovertible. As to John, he is, throughout, original; and, having written at an advanced age and far from Palestine, he may certainly have pursued a course of his own. Papias's assertion does not render impossible the fact that Peter communicated a certain fixed cycle of facts. The same reason which induced Papias to consider the Gospel of Mark an incomplete syntaxis, because it does not contain everything, may also have induced him to consider as such the communications of Peter. The phrase *ἀνατάσσασθαι διήγησιν* in Luke does not precisely indicate that the relations of the eye-witnesses had no connection. Of more importance certainly is the argument derived from the chronological position of certain facts in Matthew and Luke. However, as regards Luke, there cannot be the least doubt that his Gospel, as well as the *Acts*, was composed and arranged from already existing original documents; a fact confirmed among other reasons also by the good Greek in the preface of his Gospel, and in the last chapters of the *Acts*, where he himself appears in his narration as the travelling companion of Paul. This good Greek style forms a striking contrast with the Hellenic Greek used in the historical part of his Gospel, and in the first and greater portion of the *Acts*. If, therefore, he found documents on some separate parts of the life of our Lord, which had been

committed to writing from the oral communications of the Apostles and Evangelists, these documents might certainly have been arranged in a chronologically different manner. 1. If we possess in the Gospel of the most ancient Evangelist and Apostle the pattern of oral tradition, how can it be that Luke compiles his Gospel from private documents, and thus changes the order of the arrangement? and how can it be that Mark in this respect partially follows Luke? This different arrangement of the events is observable not only in one or two isolated instances, but the order of all the events in Matt. iv. 23; xiv., differs from that of Mark and Luke. 2. It cannot be denied that though Matthew frequently adds to his narration some expressions which indicate the time of the events, there is also frequently wanting all such indications, as well in Matthew as in Luke. It has long been assumed that Matthew, in his narrative of the sayings of Christ, has grouped together kindred sayings; for instance, various parables (ch. xiii.); denunciations against the Pharisees (ch. xxiii.). Since, therefore, Matthew frequently does not connect the various events chronologically, but rather according to their similarity, it is likely that he had no intention to furnish the succession of the times, and there is no reason to suppose that the apostles had any definite pattern for a compendium of gospel history. We therefore suppose it to be necessary to limit the hypothesis of an oral protevangelium to the fact that certain groups of speeches and events in the history of our Lord were, from the very beginning of Christianity, frequently narrated and also written down. Hence it will be understood why the sentences in various evangelists are frequently arranged in a similar manner, and why the evangelists frequently differ in their phraseology, in the *plus* or *minus* of their communications, and in their arrangement. The learned Schott concludes his *Isagoge* with a confession which deprives criticism of all hope even for the future: 'etsi lubenter largiamur ejusmodi conjecturam cujus ope, quæcunque disceptari possint de his illius rectoribus evangeliorum canonicorum parallelis prorsus definiantur, *haud facile unquam prodituram esse.*' 'Although we would gladly allow such a conjecture, by the aid of which any doubt concerning these or those more correct parallels of the canonical gospels may be fully determined, yet it cannot easily be ever advanced.'

As the three Evangelists mutually supply and explain each other, they were early joined to each other, by Tatian, about A.D. 170, and by Ammonius, about A.D. 230,* and the discrepancies among them early led to attempts to reconcile them.† An ingenious essay of this kind was written by Augustine in his book *De Consensu Evangelistarum*. Starting from the principle of a *verbal inspiration* in the Gospels, every difference in expressions and facts was considered as a proof that the speeches and facts had repeatedly occurred. This opinion is advanced, for instance, in Andreas Ossiander's *Harmonia Evangelistarum*. The subject is, however, more freely handled by Calvin, Chemnitz, Kaiser, Gerhard, and others, in their respective works, *De Har-*

monia Evangelistarum. Gerhard's book, in three folio volumes, is one of the most comprehensive exegetical works on the four Gospels. Strauss has drawn his principal argument against the unhistorical character of the Gospels from these discrepancies; but he is in the first instance wrong in supposing that the Evangelist had the intention of relating the particulars of events scrupulously in a chronological order; nor is he less wrong in seeing in every deviation a contradiction, and in the attempts at reconciliation, productions of mere dogmatic prejudice, while he is himself guilty of prejudice, by the very aversion he shows against every attempt at such reconciliation!

When we consider that one and the same writer, namely, Luke, relates the conversion of Paul (Acts ix. 22, 26), with different incidental circumstances, after three various documents, though it would have been very easy for him to have annulled the discrepancies, we cannot help being convinced that the Evangelists attached but little weight to minute preciseness in the incidents, since, indeed, the historical truth of a narration consists less in them, in the relation of minute details, than in the correct conception of the character and spirit of the event. An exposition and refutation of the most recent attacks against the truth of the Evangelical history on account of this discrepancy, may be seen in Tholuck's *Glaubwürdigkeit der Evangelischen Geschichte*; and in his *Review of Strauss's Life of Christ in Literarischer Anzeiger*, 1838; also in Ebrard's *Wissenschaftliche Kritik der Evangelischen Geschichte*, 2 vols. 1842. This last work is a compendium of all critical investigations into the history contained in the Gospels.—A. T.

GOSPELS, SPURIOUS (APOCRYPHA). The canon of the New Testament, as we have already seen, having been finally settled before the close of the fourth century, the rejected writings which bore the names of the Apostles and Evangelists soon sunk into oblivion, and few, if any, have descended to our times in their original shape. From the decree of Gelasius and a few other sources we have the names and a few detached notices of a good many of these productions. We shall first speak of those which are still extant.

THE HISTORY OF JOSEPH THE CARPENTER, which has been preserved in the East in an Arabic translation, was first made known in Europe in the commencement of the sixteenth century by Isidore de Isolanis in his *Summa de donis Sti. Josephi*. He observes that the 'Catholics of the East' commemorate St. Joseph on the 19th March, and read the legend of the saint, omitting certain parts which are not approved in the Roman church. This work was first published by Wallin, at Leipzig, in 1722, from an Arabic MS. of the thirteenth century, in the *Bibliothèque du Roi*, accompanied with a Latin translation. It was divided by Wallin into chapters and verses. It is also found in Coptic, Sabidic, and Memphic. It is highly esteemed by the Copts. The former part, to chap. ix., appears to have been derived from an ancient Gospel of the Infancy. The Latin was republished by Fabricius.

THE GOSPEL OF THE INFANCY was first published by Henry Sike, at Utrecht, in 1697, from an Arabic MS. Sike's Latin version was republished by Fabricius, who divided it into chapters.

* Such putting together is called *synopsis*.

† *Harmonies*.

The Arabic was divided into corresponding chapters by Thilo, in 1832.

There are several MSS. of this gospel extant, the oldest of which known is that in the Medicean Library, written in 1299. The narratives which it contains were current in the second century, and the account contained in this gospel respecting Christ's learning the alphabet is mentioned by Ireneus (*Adv. Hæres.* i. 20) as a fabrication of the Marcosians. The Gospel of the Infancy is found in the catalogue of Gelasius, and it is especially remarkable from the fact that it was most probably this gospel which was known to Mohammed, who seems to have been unacquainted with any of the canonical Scriptures, and who has inserted some of its narrations in the Koran. The *Sepher Toldoth Jesu*, a well-known publication of the Jews, contains similar fables with those in this gospel (Wagenseil's *Sota*). This work was received as genuine by many of the Eastern Christians, especially the Nestorians and Monophysites. It was found to have been universally read by the Syrians of St. Thomas, in Travancore, and was condemned at the Synod of Diamper, in 1599, by Archbishop Menezes, who describes it as 'the book called the *Gospel of the Infancy*, already condemned by the ancients for its many blasphemous heresies and fabulous histories.' Wherever the name Jesus occurs in this

gospel, he is universally entitled **الرب**, while Christ is called **السيد**. This was a distinction introduced by the Nestorians. The Blessed Virgin is also entitled the Lady Mary. The Persians and Copts also received this gospel (De la Brosse's *Lexic. Pers. voc. Tinctoria ars*). The original language was probably Syriac. It is sometimes called the Gospel of Peter, or of Thomas.

THE GOSPEL OF THOMAS THE ISRAELITE (Greek), a work which has flowed from the same source with the former, was first published by Cotelierus (*Notes on the Constitutions of the Apostles*, l. vi. c. 17, tom. i. p. 348), from an imperfect MS. of the fifteenth century. It was republished and divided into chapters by Fabricius. The most perfect edition was that of Mingarelli, in the *Nuova Raccolta d' Opuscoli scientifiche e filosofice*, Venet. 1764, from a Bologna MS. of the fifteenth century. Mingarelli (who believed it to have been a forgery of the Manichees) accompanied his text with a Latin translation. Thilo has given a complete edition from a collation of Mingarelli's work with two MSS. preserved at Bonn and Dresden. This gospel relates the fable of Christ's learning the Greek alphabet, in which it agrees with the account in Ireneus. In other Gospels of the Infancy (as in that published by Sike) he is represented as learning the Hebrew letters. It has been questioned whether this is the same work which is called the Gospel of Thomas, by Origen, Ambrose, Bede, and others. This gospel probably had its origin among the Gnostics, and found its way from them, through the Manichees, into the church; but having been more generally received among the heretics it was seldom copied by the monks, which accounts for the paucity of MSS. Nicephorus says that the Gospel of Thomas contained 1300 **στίχοι** [STICHOMETRY]. This

pseud-epigraphical work is probably the foundation of all the histories of Christ's infancy, but it is supposed to have been recast and interpolated.

THE PROTEVANGELION OF JAMES has descended to us in the original Greek, and was first published by Bibliander, at Basel, in 1552, in a Latin version by William Postell, who asserted that it was publicly read in the Greek churches, and maintained that it was a genuine work of the Apostle James, and intended to be placed at the head of St. Mark's Gospel. These commendations provoked the wrath of the learned Henry Stephen, who insinuated that it was fabricated by Postell himself, whom he calls 'a detestable monster' (*Introduction au Traité de la Conformité des Merveilles Anciennes avec les Modernes*, 1566). It was reprinted in the *Orthodoxographia* of J. Herold, Basil, 1555; and again in the *Orthodoxographia*, vol. i. (1569), of Jacob Grynæus, who entertained a very favourable opinion of it. Subsequent discoveries have proved that, notwithstanding the absurdity of Postell's high pretensions in favour of the authenticity of this gospel, Stephen's accusations against him were all ill-founded. There had, even at the time when Stephen wrote, been already a Greek translation published by Neander, of which Stephen was not aware; it appeared among the Apocrypha annexed by Oporin to his edition of Luther's Catechism, Basel, 1564. It was republished by Fabricius (who divided it into chapters), and subsequently by Birch and Thilo. Thilo collated for his edition six Paris MSS., the oldest of which is of the tenth century. From the circumstance of these MSS. containing a Greek calendar or martyrology, and from other internal evidences, there seems little doubt that this gospel was formerly read in the Greek church (Montfaucon, *Palæogr. Græc.* p. 304). There are also extant versions of the Gospel of the Infancy in the Arabic and other languages of the Eastern churches, among which they appear to have possessed a high degree of authority.

Although this work is styled by Postell the *Protevangeliium*, there is no MS. authority for this title, nor for the fact of its being ascribed to St. James the Apostle. It only appears that the author's name is James. The narrations of this Gospel were known to Tertullian (*Adv. Gnost.* c. viii.), Origen (*Com. in Matt.* p. 223), Gregory Nyssen (*Orat. in diem Nat. Christ.* : *Opp.* vol. iii. p. 346), Epiphanius (*Hæres.* 79. § 5), the author of the *Imperfect Work on Matt.* : Chrysost. *Opp.* tom. vi. p. 24), and many others among the ancients.

THE GOSPEL OF THE NATIVITY OF MARY (Latin). Although the Latins never evinced the same degree of credulity which was shown by the Greeks and Orientals in regard to these fabulous productions, and although they were generally rejected by the fathers, they were again revived about the sixth century. Notwithstanding their contemptuous rejection by Augustine and Jerome, and their condemnation by Popes Innocent and Gelasius, they still found readers in abundance. Gelasius expressly condemns the book concerning the *Nativity of St. Mary and the Midwife*.

The Gospel of the Nativity of Mary, which most probably, in its present form, dates its origin from the sixth century, has been even recommended by the pretended authority of St. Jerome.

There is a letter extant, said to be written by the Bishops Chromatius and Heliodorus to Jerome, requesting him to translate out of Hebrew into Latin the history of the *Birth of Mary*, and of the *Birth and Infancy of Christ*, in order to oppose the fabulous and heretical accounts of the same, contained in the apocryphal books. To this Jerome accedes, observing at the same time that the real author of the book was not, as they supposed, the Evangelist Matthew, but Seleucus the Manichee. Jerome observes that there is some truth in the accounts, of which he furnishes a translation from the original Hebrew. These pretended letters of Jerome are now universally acknowledged to be fabrications; but the apocryphal gospel itself, which is the same in substance with the *Protevangelion of James*, is still extant in Jerome's pretended Latin version. This gospel was republished by Mr. Jones from Jerome's works. It is from these Gospels of the Infancy that we have learned the names of the parents of the Blessed Virgin, Joachim (although Bede reads Eli) and Anna. The narratives contained in these gospels were incorporated in the *Golden Legend*, a work of the thirteenth century, which was translated into all the languages of Europe, and frequently printed. There are extant some metrical accounts of the same in German, which were popular in the era of romance. These legends were, however, severely censured by some eminent divines of the Latin church, of whom it will be sufficient to name Alcuin, in his *Homilies*, in the ninth, and Fulbert and Petrus Damianus (bishop of Ostia) in the eleventh century. 'Some,' says the latter, 'boast of being wiser than they should be, when, with superfluous curiosity, they inquire into the names of the parents of the Blessed Virgin, for the Evangelist would surely not have failed to have named them if it were profitable to mankind' (*Sermon on the Nativity*). Eadmer, the monk, in his book on the *Excellence of the Virgin*, writes in a similar strain (cap. ii. Anselm. *Opp.* p. 435, Paris, 1721). Luther also inveighs against the readers of these books (*Homil. ed. Walch.* tom. xi.; and *Table-Talk*, ch. vii. tom. xxii. p. 396).

There were several editions of Jerome's pretended translation published in the fifteenth century, one of them by Caxton. It is printed by Thilo from a Paris MS. of the fourteenth century, and divided by him into twenty-four chapters, after a MS. of the fifteenth century in the same library. One of the chief objects of the writer of these gospels seems to be to assert the Davidical origin of the Virgin, in opposition to the Manichees.

Mr. Jones conceives that the first author of these ancient legends was a Hellenistic Jew, who lived in the second century, but that they were added to and interpolated by Seleucus at the end of the third, who became their reputed author; and that still further additions were made by the Nestorians, or some late Christians in India. Lardner (*Credibility*, vol. viii.) so far differs from Mr. Jones as to believe the author not to have been a Jew. That these legendary accounts have not altogether lost their authority appears from the *Life of St. Joseph*, in the last number of the *Catholic Magazine* (December, 1843).

The Gospel of the Nativity of Mary was received by many of the ancient heretics, and is

mentioned by Epiphanius, St. Augustine, and Gelasius. The Gnostics and Manichees endeavoured to found on its authority some of their peculiar opinions (such as that Christ was not the Son of God before his baptism, and that he was not of the tribe of Judah, but of that of Levi); as did also the Collyridians, who maintained that too much honour could not be paid to the Blessed Virgin, and that she was herself born of a virgin, and ought to be worshipped with sacrifices.

Although the GOSPEL OF MARCON, or rather that of St. Luke as corrupted by that heretic in the second century, is no longer extant, Professor Hahn has endeavoured to restore it from the extracts found in ancient writers, especially Tertullian and Epiphanius. This work has been published by Thilo.

Thilo has also published a collation of a corrupted Greek GOSPEL OF ST. JOHN, found in the archives of the Knights Templars in Paris. This work was first noticed (in 1828) by the Danish Bishop Muentzer, as well as by Abbé Grégoire, ex-bishop of Blois. It is a vellum MS. in large 4to., said by persons skilled in palæography to have been executed in the thirteenth or fourteenth century, and to have been copied from a Mount Athos MS. of the twelfth. The writing is in gold letters. It is divided into nineteen sections, which are called *gospels*, and is on this account supposed to have been designed for liturgical use. These sections, corresponding in most instances with our chapters (of which, however, the twentieth and twenty-first are omitted), are subdivided into verses, the same as those now in use, and said to have been first invented by Robert Stephen [VERSES]. The omissions and interpolations (which latter are in barbarous Greek) represent the heresies and mysteries of the Knights Templars. Notwithstanding all this, Thilo considers it to be modern, and fabricated since the commencement of the eighteenth century.

One of the most curious of the apocryphal gospels is the GOSPEL OF NICODEMUS, or ACTS OF PILATE. It is a kind of theological romance partly founded on the canonical gospels. The first part, to the end of ch. xv., is little more than a paraphrastic account of the trial and death of Christ, embellished with fabulous additions. From that to the end (ch. xxviii.) is a detailed account of Christ's descent into hell to liberate the spirits in prison, the history of which is said to have been obtained from Lenthuis and Charinus, sons of Simeon, who were two of those 'saints who slept,' but were raised from the dead, and came into the holy city after the resurrection. This part of the history is so far valuable, that it throws some light upon the ancient ideas current among Christians on this subject. It is therefore considered by Birch (*Auctarium*, Proleg. p. vi.) to be as valuable in this respect as the writings of the Fathers.

The subscription to this book states that it was found by the emperor Theodosius among the public records in Jerusalem, in the hall of Pontius Pilate (A.D. 380). We read in chap. xxvii. that Pilate himself wrote all the transactions from the relation of Nicodemus, who had taken them down in Hebrew; and we are informed by Epiphanius that the Quartadecimans appealed to the *Acts of Pilate* in favour of their opinions as to the proper time of keeping Easter

It was written in these Acts that our Saviour suffered on the eighth Kal. of April, a circumstance which is stated in the subscription to the present *Acts*. It is uncertain, however, when this work was first called by the name of Nicodemus.

The two ancient apologists, Justin Martyr and Tertullian, both appeal in confirmation of our Saviour's miracles and crucifixion to the *Acts of Pilate* (Justin Martyr, *Apology*, pp. 76, 84; Tertullian, *Apol.* c. 21, or English transl. by Chevallier, 1833). From this circumstance it has been generally held that such documents must have existed, although this fact has been called in question by Tanaquil Faber and Le Clerc (Jones, *On the Canon*, vol. ii. p. 282, pt. iii. ch. 29). These appeals, however, in all probability first furnished the idea of the present pious fraud. Mr. Jones supposes that this may have been done in order to silence those pagans who denied the existence of such Acts. The citations of those Fathers are all found in the present work.

We have already seen that a book entitled the *Acts of Pilate* existed among the Quartadecimans, a sect which originated at the close of the third century. We are informed by Eusebius that the heathens forged certain Acts of Pilate full of all sorts of blasphemy against Christ, which they procured (A.D. 303) to be dispersed throughout the empire; and that it was enjoined on schoolmasters to put them into the hands of children, who were to learn them by heart instead of their lessons. But the character of the Gospel of Nicodemus, which contains no blasphemy of the kind, forbids us to identify it with those *Acts*. This gospel probably had its origin in a later age. From the circumstance of its containing the names of Lenthinus and Charinus, Mr. Jones conceives it to have been the work of the celebrated fabricator of gospels, Lucius Charinus, who flourished in the beginning of the fourth century. It is certainly not later than the fifth or sixth. 'During the persecution under Maximin,' says Gieseler (*Eccles. Hist.* vol. i. § 24, note), 'the heathens first brought forward certain calumnious *Acts of Pilate* (Euseb. ix. 5), to which the Christians opposed others (Epiphian. *Har.* 79, § 1), which were afterwards in various ways amended. One of these improved versions was called afterwards the Gospel of Nicodemus.'

Beausobre suspected that the latter part of the book (the descent into hell) was taken from the *Gospel of Peter*, a work of Lucius Charinus now lost. Thilo (*Codex Apocryphus*) thinks that it is the work of a Jewish Christian, but it is uncertain whether it was originally written in Hebrew, Greek, or Latin. The only Greek writer who cites it is the author of the *Synaxarion*, and the first of the Latins who uses it is the celebrated Gregory of Tours (*Hist. Franc.* i. 20, 23).

The Gospel of Nicodemus (in Latin) was one of the earliest books printed, and there are subsequent editions in 1490, 1516, 1522, and 1538, and in 1569 in the *Orthodoxographia* of Grynæus. It was afterwards published by Fabricius (*Cod. Apoc.*), who divided it into chapters. Fabricius gives us no information respecting the age or character of his MS., which is extremely defective

and inaccurate. Mr. Jones republished this, with an English version.

The Greek Gospel of Nicodemus was first published from an incorrect Paris MS. by Birch (*Auctarium*), and subsequently, from a collation of several valuable manuscripts, the most ancient of which are of the thirteenth century, by Thilo, with the Latin text of the very ancient MS. at Einsidl, described by Gerbert in his *Iter Alemannicum*. It has been shown by Smidt (*Bibl. für Kritik und Exegese*) that the present MSS. exhibit in their citations from the canonical books a text of the sixth century, and consequently that this gospel is extremely useful in a critical point of view.

The esteem in which this work was held in the middle ages may be seen from the number of early versions which were in popular use, of which innumerable MSS. have descended to our times. The earliest of these is the Anglo-Saxon translation, printed at Oxford in 1698, from a Cambridge MS. (Thwaites's *Heptateuchus*). This is a translation from the Latin, as none of the Greek MSS. contain Pilate's letter to Claudius. There are also MSS. of the same in the Bodleian and Canterbury libraries. That in the Bodleian is divided into thirty-four chapters. There are several MSS. of the English version in the Bodleian, one in Sion College, and one in English verse in Pepys's collection. It was also translated by Wickliffe; and there were versions printed in London, in 1507 and 1509, by Julian Notary and Wynkyn de Worde, which ran through several editions (Panzi's *Annals*). The latest published before Mr. Jones's work was by Joseph Wilson in 1767. He says nothing of the age of his MS., but the following specimen from the prologue may not prove uninteresting:—

'It befel in the eighteenth year of the seigniory of Tiberius Cæsar, Emperour of Rome, and in the seigniory of Herod, who was King of Galilee, the 8th Kalend of April, which is the 25th day of March, the fourth year of the son of Velom, who was Counsellor of Rome, and *Olympias had been afore two hundred years and two*; at this time Joseph and Annas were lords above all justices of peace, mayors and Jews. Nicodemus, who was a worthy prince, did write this blessed history in Hebrew, and Theodosius the emperor did translate it out of Hebrew into Latin, and Bishop Turpin did translate it out of Latin into French, and hereafter did ensue the blessed history called the Gospel of Nicodemus.' The regard, indeed, in which this book was held in England will be understood from the fact that, in 1524, Erasmus acquaints us that he saw the Gospel of Nicodemus affixed to one of the columns of the cathedral of Canterbury.

Translations were also common in French, Italian, German, and Swedish. In the French MSS. and editions it is united with the old romance of *Perceforest, King of Great Britain*. There was also a Welsh translation (Lluyd's *Archeologia*, p. 256), and the work was known to the Eastern Christians, and has been even supposed to be cited in the Coptic liturgy; but this has been shown by Ludolf to be a mistake, as the lesson is from the history of Nicodemus, in John iii.

Of the gospels no longer extant, we know

little more than that they once existed. We read in Irenæus, Epiphanius, Origen, Eusebius, and other ecclesiastical writers, of the Gospels of Eve or of Perfection, of Barnabas (ancient and modern), of Bartholomew, of Basilides, of Hesy-chius, of Judas Iscariot, of the Valentinians, of Apollon, of Cerinthus, of the Twelve Apostles, and several others. Some of these were derived from the Gnostics and other heretics; others, as the Gospel of Matthias, are supposed by Mill, Grabe, and most learned men to have been genuine gospels now lost. Those of which we have the fullest details are the *Gospel of the Egyptians* and that of the NAZARENES. This latter is most probably the same with that of the Hebrews, which was used by the Ebionites. It was supposed by St. Jerome to have been a genuine Gospel of St. Matthew, who, he says, wrote it in the Hebrew language and letters. He copied it himself from the original in the library of Cæsarea, translated it into Greek and Latin, and has given many extracts from it. Grabe conceived this gospel to have been composed by Jewish converts soon after our Lord's ascension, before the composition of the canonical Gospel of St. Matthew. Baronius, Grotius, Father Simon, and Du Pin, look upon it as the Gospel of St. Matthew—interpolated, however, by the Nazarenes. Baronius and Grabe think that it was cited by Ignatius, or the author of the Epistles ascribed to him. Others look upon it as a translation altered from the Greek of St. Matthew. Mr. Jones thinks that this Gospel was referred to by St. Paul in his Epistle to the Galatians. It is referred to by Hege-sippus (Euseb. *Ecl. Hist.* iv. 22), Clemens Alexandrinus (*Strom.* ii. p. 280), Origen (*Comm. on John*; *Hom.* viii. in *Matt.*), and Eusebius (*Hist. Ecl.* iii. 25, 27, 39). Epiphanius (*Hær.* §§ 29, 30) acquaints us that it was held in great repute by the ancient Judaizing Christians, and that it began thus: 'It came to pass in the days of Herod king of Judea that John came baptizing with the baptism of repentance in the river Jordan,' &c. It consequently wanted the genealogy and the two first chapters.

The GOSPEL OF THE EGYPTIANS is cited by Clemens Alexandrinus (*Strom.* iii. pp. 445, 452, 453, 465), Origen (*Hom. in Luc.* p. 1), Ambrose, Jerome (*Præf. to his Comm. on Matt.*), and Epiphanius (*Hæres.* lxii. § 2). Grabe, Mill, Du Pin, and Father Simon, who thought highly of this Gospel, looked upon it as one of the works referred to by St. Luke in the commencement of his Gospel. Mill ascribes its origin to the Es-senes, and supposes this and the former Gospel to have been composed in or a little before A.D. 58. It is cited by the Pseudo-Clement (*Second Epistle to the Corinthians*, or Chevallier's Translation, 1833), who is generally supposed to have written not before the third century. (See Car. Chr. Schmidt's *Corpus omnium vet. Apoc. extra Biblia*; Kleuker, *De Apoc. N. T.*; Hencke, *De Pilati actis probab.*; W. L. Brunn, *De indole, ætate et usu libr. Apoc. vulgo inscripti Evangel. Nicodemii*, Berlin, 1794; Birch's *Auctarium*, Fasc. 1, Hafn. 1804. Hone's *Apocryphal N. T.*, London, 1820, which in its external form was designed to be an imitation of the English New Testament, is of no critical use. The *Orthodoxographia* of Grynæus, 7 vols. in 2, fol. Basil,

1569, of which there was formerly a copy in the British Museum, which exists there no longer, but there is a fine copy in Mr. Darling's valuable Clerical Library.)—W. W.

GOURD. [KIKAYON.]

GOZAN (𐤆𐤐𐤍; Sept. Γωζάν), a river of Media, to the country watered by which Tig-lath-pileser first, and afterwards Shalmaneser, transported the captive Israelites (1 Chron. v. 26; 2 Kings xvii. 6). It is unnecessary to trouble the reader with antiquated conjectures concerning this river, as, since the appearance of Major Rennell's *Geography of Herodotus*, Lond. 1800 (which contains a section, xv., 'Concerning the disposal of the Ten Tribes of the Jews,' pp. 389-407), there has been scarcely a dissenting voice to his conclusion—that the Gozan is no other than the present Ozan, or, with the prefix, Kizzil-Ozan (Golden River), which is the principal river of that part of Persia that answers to the ancient Media. Everything in criticism or travel which has since transpired has tended to confirm this most happy conjecture. When Major Rennell wrote it was scarcely known so well as it is now, to what extent the Oriental Jews themselves connect the memories of the first captivity with the country through which the Kizzil-Ozan flows. This river rises eight or nine miles south-west of Sennah, in Kurdistan. It runs along the north-west frontier of Irak, and passes under the Kafulan Koh, or Mountain of Tigris, where it is met by the Karanku. These two rivers combined force a passage through the great range of Caucasian, and, during their course, form a junction with the Sharood. The collective waters, under the designation of Sifeed Rood or White River, so named from the foam occasioned by the rapidity of its current, flow in a meandering course through Ghilan to the Caspian Sea (Sir John Macdonald Kinneir's *Geograph. Memoir of the Persian Empire*, pp. 121, 122; Morier's *Second Journey*, p. 208; Ker Porter's *Travels*, i. 267). The present writer, in crossing the river in September, under the Kafulan Koh, by a bridge of three arches, found it there a low but rapid stream, flowing between well wooded banks, and in a deep channel which afforded manifest traces of its breadth and impetuosity when swollen by the periodical rains and by the drainage of the mountains.

GRAPE. [VINE.]

GRASS. [DISHA and CHAZIR.]

GRASSHOPPER (𐤆𐤐𐤍). The creature denoted by this Hebrew word so evidently belongs to the class of 'flying creeping things' (Lev. xi. 21, 22), that the grasshopper, according to the common acceptation of the word, can scarcely be the proper translation. Other reasons render it most probable that a species of locust is intended. It is, therefore, referred to the general English word [LOCUST], under which the various species will be considered which are not already treated of under the Hebrew names [CHARGOL; CHASIL].

J. F. D.

GRAVE. [BURIAL.]

GREECE. The relations of the Hebrews with the Greeks were always of a distant kind, until the Macedonian conquest of the East; hence in the Old Testament the mention of the Greeks is naturally rare. It appears by Cruen's *Concord*

ance that 'Tubal and Javan,' in connection, are named four times, Dan and Javan once (Ezek. xxvii. 19), and Javan, translated by us Greece and Greeks, five times, of which three are in the book of Daniel. Of these passages, that which couples Dan and Javan is generally referred to a different tribe [see JAVAN]; in the rest Javan is understood of Greece or its people. The Greek nation had a broad division into two races, Dorians and Ionians: of whom the former seem to have long lain hid in continental parts, or on the western side of the country, and had a temperament and institutions more approaching to the Italic. The Ionians, on the contrary, retained many Asiatic usages and tendencies, witnessing that they had never been so thoroughly cut off as the Dorians from Oriental connection. When afterwards the Ionic colonies in Asia Minor rose to eminence, the Ionian race, in spite of the competition of the half Doric Æolians, continued to attract most attention in Asia; and it is not wonderful that the Ionian name (for *Javan* is the same word as *Idaw*) should have maintained its extensive application in Oriental usage. Just so in the 'Perse' of the tragic poet Æschylus, the Persians are made to style all the Greeks *Idawes*, i. e. Javan.

The few dealings of the Greeks with the Hebrews seem to have been rather unfriendly, to judge by the notice in Zech. ix. 13. In Joel iii. 6, the Tyrians are reproached for selling the children of Judah and Jerusalem to the Grecians: but at what time, and in what circumstances, must depend on the date assigned to the book of Joel [see JOEL]. With the Greeks of Cyprus or Chittim, the Hebrews were naturally better acquainted; and this name, it would seem, might easily have extended itself in their tongue to denote the whole Greek nation. Such at least is the most plausible explanation of its use in I Macc. i. 1, and viii. 1.

The Greeks were eminent for their appreciation of beauty in all its varieties: indeed their religious creed owed its shape mainly to this peculiarity of their mind; for their logical acuteness was not exercised on such subjects until quite a later period. The puerile or indecent fables of the old mythology may seem to a modern reader to have been the very soul of their religion; but to the Greek himself these were a mere accident, or a vehicle for some embodiment of beauty. He thought little whether a legend concerning Artemis or Apollo was true, but much whether the dance and music celebrating the divinity were solemn, beautiful, and touching. The worship of Apollo, the god of youth and beauty, has been regarded as characterizing the Hellenic in contrast with the older Pelasgian times; nor is the fact without significance, that the ancient temple and oracle of Jupiter at Dodona fell afterwards into the shade in comparison with that of Apollo at Delphi. Indeed the Dorian Spartans and the Ionian Athenians alike regarded Apollo as their tutelary god, who was *Ἀπόλλων πατρώος* at Athens, and *Ἀπόλλων Καρρείος* at Amyclæ. Whatever the other varieties of Greek religious ceremonies, no violent or frenzied exhibitions arose out of the national mind; but all such *orgies* (as they were called) were imported from the East, and had much difficulty in establishing themselves on Greek soil. Quite at a late period the managers

of orgies were evidently regarded as mere jugglers of not a very reputable kind (see Demosth. *De Coronâ*, § 79, p. 313); nor do the Greek States, as such, appear to have patronized them. On the contrary, the solemn religious processions, the sacred games and dances, formed a serious item in the public expenditure; and to be permanently excluded from such spectacles would have been a moral death to the Greeks. Wherever they settled they introduced their native institutions, and reared temples, gymnasia, baths, porticoes, sepulchres, of characteristic simple elegance. The morality and the religion of such a people naturally were alike superficial; nor did the two stand in any close union. Bloody and cruel rites could find no place in their creed, because faith was not earnest enough to endure much self-abandonment. Religion was with them a sentiment and a taste rather than a deep-seated conviction. On the loss of beloved relatives they felt a tender and natural sorrow, but unclouded with a shade of anxiety concerning a future life. Through the whole of their later history, during Christian times, it is evident that they had little power of remorse, and little natural firmness of conscientious principle: and, in fact, at an earlier and critical time, when the intellect of the nation was ripening, an atrocious civil war, that lasted for twenty-seven years, inflicted a political and social demoralization, from the effects of which they could never recover. Besides this, their very admiration of beauty, coupled with the degraded state of the female intellect, proved a frightful source of corruption, such as no philosophy could have adequately checked. From such a nation then, whatever its intellectual pretensions, no healthful influence over its neighbours could flow, until other and higher inspiration was infused into its sentiment.

Among the Greeks the arts of war and peace were carried to greater perfection than among any earlier people. In navigation they were little behind the Tyrians and Carthaginians; in political foresight they equalled them; in military science, both by sea and land, they were decidedly their superiors; while in the power of reconciling subject-foreigners to the conquerors and to their institutions, they perhaps surpassed all nations of the world. Their copious, cultivated, and flexible tongue carried with it no small mental education to all who learned it thoroughly; and so sagacious were the arrangements of the great Alexander throughout his rapidly acquired Asiatic empire, that in the twenty years of dreadful war between his generals which followed his death, no rising of the natives against Greek influence appears to have been thought of. Without any change of population adequate under other circumstances to effect it, the Greek tongue and Greek feeling spread far and sank deep through the Macedonian dominions. Half of Asia Minor became a new Greece; and the cities of Syria, North Palestine, and Egypt, were deeply imbued with the same influence. Yet the purity of the Hellenic stream was various in various places; and some account of the mixture it underwent will be given in the Article HELLENISTS.

When a beginning had been made of preaching Christianity to the Gentiles, Greece immediately became a principal sphere for missionary

exertion. The vernacular tongue of the Hellenistic Christians was understood over so large an extent of country, as almost of itself to point out in what direction they should exert themselves. The Grecian cities, whether in Europe or Asia, were the peculiar field for the Apostle Paul; for whose labours a superintending Providence had long before been providing, in the large number of devout Greeks who attended the Jewish synagogues. Greece Proper was divided by the Romans into two provinces, of which the northern was called Macedonia, and the southern Achaia (as in 2 Cor. ix. 2, &c.); and we learn incidentally from Acts xviii. that the pro-consul of the latter resided at Corinth. To determine the exact division between the provinces is difficult; nor is the question of any importance to a Biblical student. Achaia, however, had probably very nearly the same frontier as the kingdom of modern Greece, which is limited by a line reaching from the gulf of Volo to that of Arta, in great part along the chain of Mount Othrys. Of the cities celebrated in Greek history, none are prominent in the early Christian times except Corinth. Laconia, and its chief town Sparta, had ceased to be of any importance: Athens was never eminent as a Christian church. In Macedonia were the two great cities of Philippi and Thessalonica (formerly called Thermo); yet of these the former was rather recent, being founded by Philip the Great; the latter was not distinguished above the other Grecian cities on the same coast. Nicopolis, on the gulf of Ambracia (or Arta), had been built by Augustus, in memory of his victory at Actium, and was, perhaps, the limit of Achaia on the western coast (Tacitus, *Annal.* ii. 53). It had risen into some importance in St. Paul's days, and, as many suppose, it is to this Nicopolis that he alludes in his epistle to Titus. (See further under ACHÆIA and NICOPOLIS.)—F. W. N.

GREYHOUND. [ZARZIR; DOG.]

GRINDING. [MILL.]

GUEST. [HOSPITALITY.]

H.

HABAKKUK (חַבְקֻק), one of the most distinguished Jewish prophets, who flourished about 610 B.C., the name descending in the form of שְׁעוּר, from חֶבֶק, *amplecti*, and denoting, as observed by Jerome, as well as a 'favourite' as a 'struggler.' Abarbanel thinks that in the latter sense it has allusion to the patriotic zeal of the prophet, fervently contending for the welfare of his country; but other prophets did the same; and in the first and less distant signification, the name would be one like Theophilus, 'a friend of God,' which his parents may have given him for a good omen. The Greeks, not only the Septuagint translators but the fathers of the Church, probably to make it more sonorous, corrupt it into Ἀραβακούκ, Ἀραβακούρω, or as Jerome writes, Ἀβακούρω, and only one Greek copy, found in the library of Alcalá in Spain, has Ἀββακούκ, which seems to be a recent correction made to suit the Hebrew text. Of this prophet's birth-place, parentage, and life we have only apocryphal and conflicting accounts. The Pseudo-Epiphanius (*De Vitis Prophet.* Opp. tom.

ii. 18, p. 247) states that he was of the tribe of Simeon, and born in a place called Βηδοκούρη (*al.* Βηδοχεύρη); that he fled to Ostracine when Nebuchadnezzar attacked Jerusalem, but afterwards returned home, and died two years before the return of his countrymen. But rabbinical writers assert that he was of the tribe of Levi, and name different birth-places (Huetius, *Dem. Evang.* Prop. iv. p. 508). In the apocryphal appendix to Daniel, in the story of Bel and the Dragon, we are told that an angel seized Habakkuk by the hair, when he was in Judæa carrying food to his reapers in the field, and transported him through the air to the lions' den in Babylon, where Daniel then lay; and that, after having provided the latter with victuals, he was the same day carried back to his own country in like manner. Eusebius notices that in his time the tomb of Habakkuk was shown in the town of Ceila, in Palestine; and this is repeated also by Nicephorus (*Hist. Eccles.* xii. 48), and Sozomen (vii. 29); still there are other writers who name different places where, according to common opinion, he had been buried (Carpov, *Introd. ad libros canonicos V. T.*, p. 402).

A full and trustworthy account of the life of Habakkuk would explain his imagery, and many of the events to which he alludes; but since we have no information on which we can depend, nothing remains but to determine from the book itself its historical basis and its age. Now, we find that in chap. i. the prophet sets forth a vision, in which he discerned the injustice, violence, and oppression committed in his country by the rapacious and terrible Chaldeans, whose oppressions he announces as a divine retribution for sins committed; consequently he wrote in the Chaldean period, shortly before the invasion of Nebuchadnezzar which rendered Jehoiakim tributary to the king of Babylon (2 Kings xxiv. 1). When he wrote the first chapter of his prophecies, the Chaldeans could not yet have invaded Palestine, otherwise he would not have introduced Jehovah saying (i. 5), 'I will work a work in your days, which ye will not believe, though it be told you;' (ver. 6) 'for I raise up the Chaldeans, that bitter and hasty nation, which shall march through the breadth of the land to possess the dwelling-places that are not theirs.' From ver. 12 it is also evident that the ruin of the Jews had not then been effected; it says, 'the Lord ordained them for judgment, established them for correction.' Agreeably to the general style of the prophets, who to lamentations and announcements of divine punishment add consolations and cheering hopes for the future, Habakkuk then proceeds in the second chapter to foretell the future humiliation of the conquerors, who plundered so many nations. He also there promulgates a vision of events shortly to be expected; (ver. 3) 'the vision is yet for an appointed time, but at the end it shall speak, and not lie; though it tarry, wait for it, because it will surely come; it will not tarry.' This is succeeded in the third chapter by an ode, in which the prophet celebrates the deliverances wrought by the Almighty for his people in times past, and prays for a similar interference now to mitigate the coming distresses of the nation; which he goes on to describe, representing the land as already waste and desolate, and yet giving encouragement to hope for a return

of better times. Some interpreters are of opinion that ch. ii. was written in the reign of Jehoiachin, the son of Jehoiakim (2 Kings xxiv. 6), after Jerusalem had been besieged and conquered by Nebuchadnezzar, the king made a prisoner, and, with many thousands of his subjects, carried away to Babylon; none remaining in Jerusalem, save the poorest class of the people (2 Kings xxiv. 14). But of all this nothing is said in the book of Habakkuk, nor even so much as hinted at; and what is stated of the violence and injustice of the Chaldæans does not imply that the Jews had already experienced it. The prophet distinctly mentions that he sets forth what he had discerned in a vision, and he, therefore, speaks of events to be expected and coming. It is also a supposition equally gratuitous, according to which some interpreters refer ch. iii. to the period of the last siege of Jerusalem, when Zedekiah was taken, his sons slain, his eyes put out, the walls of the city broken down, and the temple burnt (2 Kings xxv. 1-10). There is not the slightest allusion to any of these incidents in the third chapter of Habakkuk; and from the 16th verse it appears, that the destroyer is only coming, and that the prophet expresses fears, not of the entire destruction of the city, much less of the downfall of the state, but only of the desolation of the country. It thus appears beyond dispute, that Habakkuk prophesied in the beginning of the reign of Jehoiakim, about the year stated above. Carpsov (*Introductio ad libr. canon. V. T.*, pp. 79, 410) and Jahn (*Introd. in libros sacros V. T.*, ii. § 120) refer our prophet to the reign of Manasseh, thus placing him thirty odd years earlier; but at that time the Chaldæans had not as yet given just ground for apprehension, and it would have been injudicious in Habakkuk prematurely to fill the minds of the people with fear of them. Some additional support to our statement of the age of this book is derived from the tradition, reported in the apocryphal appendix to Daniel and by the Pseudo-Epiphanius, that Habakkuk lived to see the Babylonian exile; for if he prophesied under Manasseh he could not have reached the exile at an age under 90 years; but if he held forth early in the reign of Jehoiakim he would have been only 50 odd years old at the time of the destruction of Jerusalem and of the exile. He was, then, a contemporary of Jeremiah, but much younger, as the latter made his first appearance in public as early as b.c. 629, in the thirteenth year of Josiah. Ranitz (*Introductio in Hab. Vatic.* pp. 24, 59), Stirkel (*Prolog. ad interp. tertii cap. Hab.* pp. 22, 27), and De Wette (*Lehrbuch der Historisch-kritischen Einleit.* Berlin, 1840, p. 338) justly place the age of Habakkuk before the invasion of Judæa by the Chaldæans.

The style of this prophet has been always much admired. Lowth (*De Poesi Hebræor.* p. 287) says: 'Poeticus est Habaccuci stylus; sed maxime in oda, quæ inter absolutissimas in eo genere merito numerari potest.' Eichhorn, De Wette, and Rosenmüller are loud in their praise of Habakkuk's style; the first giving a detailed and animated analysis of the construction of his prophecies (*Einleitung in das A. T.* iii. p. 333). He equals the most eminent prophets of the Old Testament—Joel, Amos, Nahum, Isaiah; and the ode in ch. iii. may be placed in competition with Ps. xviii. and lxviii. for originality and sub-

limity. His figures are all great, happily chosen, and properly drawn out. His denunciations are terrible, his derision bitter, his consolation cheering. Instances occur of borrowed ideas (ch. iii. 19, comp. Ps. xviii. 34; ch. ii. 6, comp. Isa. xiv. 7; ch. ii. 14, comp. Isa. xi. 9); but he makes them his own in drawing them out in his peculiar manner. With all the boldness and fervour of his imagination, his language is pure and his verse melodious. Eichhorn, indeed, gives a considerable number of words which he considers to be peculiar to this prophet, and supposes him to have formed new words, or altered existing ones, to sound more energetic or feeble, as the sentiments to be expressed might require: but his list needs sifting, as De Wette observes (*Einleitung*, p. 339); and בִּיקִלּוֹל, ch. ii. 16, is the only unexceptionable instance. The ancient catalogues of canonical books of the Old Testament do not, indeed, mention Habakkuk by name; but they must have counted him in the twelve minor prophets, whose numbers would otherwise not be full. In the New Testament some expressions of his are introduced, but his name is not added (Rom. i. 17; Gal. iii. 11; Heb. x. 38, comp. Hab. ii. 4; Acts xiii. 40, 41, comp. Hab. i. 5).

The best auxiliaries, ancient and modern, to the interpretation of the book of Habakkuk are the following:—

1. Introductory works: T. C. Friederich, *Historisch-kritischer Versuch über Hab. Zeitalter und Schriften*, in Eichhorn's *Allg. Biblioth. des Bibl. Lit.* x. 379-400; A. C. Ranitz, *Introductio in Hab. Vatican.*, Lipsiæ, 1808; Hänlein, *Symb. Crit. ad Interp. Vatican. Hab.*, Erlangæ, 1795.

2. General commentaries: Abarbanel, *Rabbinicus Comment. in Hab.*, Latine redditus a Diderico Sprecherio, Helmst. 1790; D. Chytræi *Lectiones in Proph. Hab.*, in his *Opp.* t. ii.; Kofod, *Commentarius crit. atque exeget.*, Götting, et Lips. 1792; I. A. Timpstedtii *Animadv. phil. et crit.* Upsal. 1795; 4.—Rosenmüller, *Scholia in V. T.* vol. vi.

3. Translations with notes, explanatory and critical: S. F. G. Wahl (Hanover, 1790), G. C. Horst (Gotha, 1798), and K. M. Tusti (Leipzig, 1721).

4. Commentaries on single chapters:—The first and second chapters are interpreted by G. A. Rupertii in the *Commentatt. Theol.* ed. Velthusen, Kuinoel et Rupertii, iii. 403, sq. The third chapter is explained by G. Perschke (Frankfort, 1777), G. A. Schroeder (Gröning, 1781), Ob. F. Schnurrer (Tüb. 1786; also in his *Dissertat. phil. crit.* p. 342), and by Moerner (Upsalæ, 1791).—

J. v. H.

HAB-BARKANIM, or BARKANIM. [THORNS.]

HABAZZELETH. [CHABAZZELETH.]

HABERGEON. [ARMS; ARMOUR.]

HABOR (חָבֹר; Sept. Ἀβὸρ), or rather CHABOR, a city or country of Media, to which portions of the ten tribes were transported, first by Tiglath-pileser, and afterwards by Shalmaneser (2 Kings xvii. 6; xviii. 11). It is thought by some to be the same mountainous region between Media and Assyria, which Ptolemy (*Geog.* vi. 1) calls Chaboras (Χαβόρας). This notion has the name, and nothing but the name, in its favour. Habor was by the river Gozan; and as we have accepted Major Rennell's conclusion, that Gozan was the

present Kizzil-Ozan [GOZAN], we are bound to follow him in fixing the position of Habor at the town of Abhar, which is situated on a branch of that river, and has the reputation of being very ancient. At this place Mr. Morier found ruins composed of large sun-dried bricks compacted with straw, like some of those found at Babylon. As this kind of construction is an infallible sign of remote antiquity, it so far affords a most important corroboration of Major Rennell's conjecture.

HADAD (𐤇𐤏𐤃); Sept. 'Aδād) is equivalent to Adad, the name of the chief deity of the Syrians [ADAD], and borne, with or without additions, as a proper name, or more probably as a title, like 'Pharaoh' in Egypt, by several of the kings of Southern Syria.

1. HADAD, king of Edom, who defeated the Midianites in the intervening territory of Moab (Gen. xxxvi. 35; 1 Chron. i. 46). This is the only one of the ancient kings of Edom whose exploits are recorded by Moses. Another king of Edom of the same name is mentioned in 1 Chron. i. 51.

2. HADAD, king of Syria, who reigned in Damascus at the time that David attacked and defeated Hadad-ezer, king of Zobah, whom he marched to assist, and shared in his defeat. This fact is recorded in 2 Sam. viii. 5, but the name of the king is not given. It is supplied, however, by Josephus (*Antiq.* vii. 5. 2), who reports, after Nicolas of Damascus, that he carried succours to Hadadezer as far as the Euphrates, where David defeated them both.

3. HADAD, a young prince of the royal race of Edom, who, when his country was conquered by David, contrived, in the heat of the massacre committed by Joab, to escape with some of his father's servants, or rather was carried off by them into the land of Midian. Thence Hadad went into the desert of Paran, and eventually proceeded to Egypt. He was there most favourably received by the king, who assigned him an estate and establishment suited to his rank, and even gave him in marriage the sister of his own consort, by whom he had a son, who was brought up in the palace with the sons of Pharaoh. Hadad remained in Egypt till after the death of David and Joab, when he returned to his own country in the hope of recovering his father's throne (1 Kings xi. 14-22). The Scripture does not record the result of this attempt further than by mentioning him as one of the troublers of Solomon's reign, which implies some measure of success. After relating these facts the text goes on to mention another enemy of Solomon, named Rezin, and then adds (ver. 25), that this was 'besides the mischief that Hadad did; and he abhorred Israel and reigned over Syria.' On this point the present writer may quote what he has elsewhere stated—'Our version seems to make this apply to Rezin; but the Septuagint refers it to Hadad, reading 𐤇𐤏𐤃 Edom, instead of 𐤇𐤏𐤃 Aram or Syria, and the sense would certainly be improved by this reading, inasmuch as it supplies an apparent omission; for without it we only know that Hadad left Egypt for Edom, and not how he succeeded there, or how he was able to trouble Solomon. The history of Hadad is certainly very obscure. Adopting the Septuagint reading, some conclude that Pharaoh used his interest with Solomon to allow Hadad to reign

as a tributary prince, and that he ultimately asserted his independence. Josephus, however, seems to have read the Hebrew as our version does, "Syria" not "Edom." He says that Hadad, on his arrival in Edom, found the territory too strongly garrisoned by Solomon's troops to afford any hope of success. He therefore proceeded with a party of adherents to Syria, where he was well received by Rezin, then at the head of a band of robbers, and with his assistance seized upon part of Syria and reigned there. If this be correct, it must have been a different part of Syria from that in which Rezin himself reigned, for it is certain, from verse 24, that he (Rezin) did reign in Damascus. Carrieres supposes that Hadad reigned in Syria after the death of Rezin; and it might reconcile apparent discrepancies, to suppose that two kingdoms were established (there were more previously), both of which, after the death of Rezin, were consolidated under Hadad. That Hadad was really king of Syria seems to be rather corroborated by the fact, that every subsequent king of Syria is, in the Scripture, called Ben-Hadad, "son of Hadad," and in Josephus simply Hadad; which seems to denote that the founder of the dynasty was called by this name. We may observe that, whether we here read Aram or Edom, it must be understood as applying to Hadad, not to Rezin' (*Pictorial Bible*, on 2 Kings xi. 14).

HADADEZER (𐤇𐤏𐤃𐤇𐤏𐤃, *Hadad-helped*; Sept. 'Aδρααζάρ), or HADADREZER, king of Zobah, a powerful monarch in the time of David, and the only one who seems to have been in a condition seriously to dispute with him the predominancy in south-western Asia. He was defeated by the Israelites in the first campaign (b.c. 1032) in the neighbourhood of the Euphrates, with a great loss of men, war-chariots, and horses, and was despoiled of many of his towns (2 Sam. viii. 3; 1 Chron. xviii. 3). This check not only impaired, but destroyed his power. A diversion highly serviceable to him was made by a king of Damascene-Syria (whom the Scripture does not name, but who is the same with Hadad, 3), who, coming to his succour, compelled David to turn his arms against him, and abstain from reaping all the fruits of his victory (2 Sam. x. 6, sq.; 1 Chron. xix. 6, sq.). The breathing-time thus afforded Hadadezer was turned by him to such good account that he was able to accept the subsidies of Hanun, king of the Ammonites, and to take a leading part in the confederacy formed by that monarch against David. The first army brought into the field was beaten and put to flight by Abishai and Joab; but Hadadezer, not yet discouraged, went into the countries east of the Euphrates, and got together the forces of all his allies and tributaries, which he placed under the command of Shophach, his general. To confront so formidable an adversary, David took the field in person, and in one great victory so completely broke the power of Hadadezer, that all the small tributary princes seized the opportunity of throwing off his yoke, of abandoning the Ammonites to their fate, and of submitting quietly to David, whose power was thus extended to the Euphrates.

HADAR. [ETZ-HADAR.]

HADAS (𐤇𐤏𐤃), always translated 'myrtle,' occurs in several passages of the Old Testament,

as in Isaiah xli. 19; Iv. 13; Neh. viii. 15; Zech. i. 8, 10, 11. The Hebrew word *hadas* is identical with the Arabic **هدس** *hadas*, which in the dialect of Arabia Felix signifies the myrtle-tree (Richardson's *Pers. and Arabic Dict.*). The myrtle is, moreover, known throughout Eastern countries, and is described in Arabic works under the name **أس** *As*. The present writer found the berries of the myrtle sold in the bazaars of India under this name (*Illust. Himal. Bot.* p. 217). Esther is supposed by Simonis (*Bibl. Cabinet*, xi. 262) to be a compound of *As* and *tur*, and so to mean a fresh myrtle; and hence it would appear to be very closely allied in signification to *Hadassah*, the original name of Esther. Almost all translators unite in considering the myrtle as intended in the above passages; the Sept. has **μυρσίνη**, and the Vulgate *myrtus*.

The myrtle has from the earliest periods been highly esteemed in all the countries of the south of Europe, and is frequently mentioned by the poets: thus Virgil (*Ecl.* ii. 54)—

Et vos, O lauri, carpum, et te, proxima myrte:
Sic positæ quoniam suaves miscetis odores.

By the Greeks and Romans it was dedicated to Venus, and employed in making wreaths to crown lovers, but among the Jews it was the emblem of justice. The note of the Chaldee Targum on the name Esther, according to Dr. Harris, is, 'they call her Hadassah because she was just, and those that are just are compared to myrtles.'



332.

The repute which the myrtle enjoyed in ancient times it still retains, notwithstanding the great accession of ornamental shrubs and flowers which has been made to the gardens and greenhouses of Europe. This is justly due to the rich colouring of its dark green and shining leaves, contrasted with the white starlike clusters of its flowers, affording in hot countries a pleasant shade under its

branches, and diffusing an agreeable odour from its flowers or bruised leaves. It is, however, most agreeable in appearance when in the state of a shrub, for when it grows into a tree, as it does in hot countries, the traveller looks under instead of over its leaves, and a multitude of small branches are seen deprived of their leaves by the crowding of the upper ones. This shrub is common in the southern provinces of Spain and France, as well as in Italy and Greece; and also on the northern coast of Africa, and in Syria. The poetical celebrity of this plant had, no doubt, some influence upon its employment in medicine, and numerous properties are ascribed to it by Dioscorides (*i.* 127). It is aromatic and astringent, and hence, like many other such plants, forms a stimulant tonic, and is useful in a variety of complaints connected with debility. Its berries were formerly employed in Italy, and still are so in Tuscany, as a substitute for spices, now imported so plentifully from the far East. A wine was also prepared from them, which was called *myrtidanium*, and their essential oil is possessed of excitant properties. In many parts of Greece and Italy the leaves are employed in tanning leather. The myrtle, possessing so many remarkable qualities, was not likely to have escaped the notice of the sacred writers, as it is a well-known inhabitant of Judæa. Hasselquist and Burckhardt both notice it as occurring on the hills around Jerusalem. It is also found in the valley of Lebanon. Capt. Light, who visited the country of the Druses in 1814, says, he 'again proceeded up the mountain by the side of a range of hills abounding with myrtles in full bloom, that spread their fragrance round,' and, further on, 'we crossed through thickets of myrtle.' Irby and Mangles (*p.* 222) describe the rivers from Tripoli towards Galilee as generally pretty, their banks covered with the *myrtle*, olive, wild vine, &c. Savary, as quoted by Dr. Harris, describing a scene at the end of the forest of Platanea, says, 'Myrtles, intermixed with laurel-roses, grow in the valleys to the height of ten feet. Their snow-white flowers, bordered with a purple edging, appear to peculiar advantage under the verdant foliage. Each myrtle is loaded with them, and they emit perfumes more exquisite than those of the rose itself. They enchant every one, and the soul is filled with the softest sensations.'—J. F. R.

HADASSAH. [ESTHER.]

HADES, a Greek word (**ᾍδης**) by which the Septuagint translates the Hebrew **שְׁאוֹל** *sheol*, denoting the abode or world of the dead, in which sense it occurs frequently in the New Testament, where it is usually rendered 'hell' in the English version. The word *hades* means literally *that which is in darkness*. In the classical writers it is used to denote *Orcus*, or the infernal regions. According to the notions of the Jews, *sheol* or *hades* was a vast receptacle where the souls of the dead existed in a separate state until the resurrection of their bodies. The region of the blessed during this interval, or the inferior paradise, they supposed to be in the upper part of this receptacle; while beneath was the abyss or *gehenna* (Tartarus), in which the souls of the wicked were subjected to punishment.

The question whether this is or is not the doctrine of the Scriptures is one of much im-

portance, and has, first and last, excited no small amount of discussion. It is a doctrine received by a large portion of the nominal Christian church; and it forms the foundation of the Roman Catholic doctrine of Purgatory, for which there would be no ground but for this interpretation of the word *hades*.

The question therefore rests entirely upon the interpretation of this word. At the first view the classical signification would seem to support the sense above indicated. On further consideration, however, we are referred back to the Hebrew *sheol*: for the Greek term did not come to the Hebrews from any classical source, or with any classical meanings, but through the Septuagint as a translation of their own word; and whether correctly translating it or not is a matter of critical opinion. The word *hades* is therefore in nowise binding upon us in any classical meaning which may be assigned to it. The real question therefore is, what is the meaning which *sheol* bears in the Old Testament, and *hades* in the New? A careful examination of the passages in which these words occur will probably lead to the conclusion, that they afford no real sanction to the notion of an intermediate place of the kind indicated, but are used by the inspired writers to denote *the grave*—the resting place of the bodies both of the righteous and the wicked; and that they are also used to signify *hell*, the abode of miserable spirits. But it would be difficult to produce any instance in which they can be shown to signify the abode of the spirits of just men made perfect, either before or after the resurrection.

In the great majority of instances *sheol* is in the Old Testament used to signify *the grave*, and in most of these cases is so translated in the Authorized Version. It can have no other meaning in such texts as Gen. xxxvii. 35; xlii. 38; 1 Sam. ii. 6; 1 Kings ii. 6; Job xiv. 13; xvii. 13, 16; and in numerous other passages in the writings of David, Solomon, and the prophets. But as the grave is regarded by most persons, and was more especially so by the ancients, with awe and dread, as being the region of gloom and darkness, so the word denoting it soon came to be applied to that more dark and gloomy world which was to be the abiding place of the miserable. Where our translators supposed the word to have this sense, they rendered it by 'hell.' Some of the passages in which this has been done may be doubtful; but there are others of which a question can scarcely be entertained. Such are those (as Job xi. 8; Ps. cxxxix. 8; Amos ix. 3) in which the word denotes the opposite of heaven, which cannot be the grave, nor the general state or region of the dead, but hell. Still more decisive are such passages as Ps. ix. 17; Prov. xxiii. 9; in which *sheol* cannot mean any place, in this world or the next, to which the righteous as well as the wicked are sent, but the penal abode of the wicked as distinguished from and opposed to the righteous. The only case in which such passages could by any possibility be supposed to mean the grave, would be if the grave—that is, extinction—were the *final* doom of the unrighteous.

In the New Testament the word $\alphaἰδης$ is used in much the same sense as $אֵלֶּשֶׁת$ in the Old, except that in a less proportion of cases can it be

construed to signify 'the grave.' There are still, however, instances in which it is used in this sense, as in Acts ii. 31; 1 Cor. xv. 55; but in general the *hades* of the New Testament appears to be no other than the world of future punishments (e. g. Matt. xi. 23; xvi. 18; Luke xvi. 23).

The principal arguments for the intermediate *hades*, as deduced from Scripture, are founded on those passages in which things 'under the earth' are described as rendering homage to God and the Saviour (Philip. ii. 10; Rev. v. 13, &c.) If such passages, however, be compared with others (as with Rom. xiv. 10, 11, &c.), it will appear that they must refer to the day of judgment, in which every creature will render some sort of homage to the Saviour; but *then* the bodies of the saints will have been already raised, and the intermediate region, if there be any, will have been deserted.

One of the seemingly strongest arguments for the opinion under consideration is founded on 1 Pet. iii. 19, in which Christ is said to have gone and 'preached to the spirits in prison.' These spirits in prison are supposed to be the holy dead—perhaps the virtuous heathen—imprisoned in the intermediate place, into which the soul of the Saviour went at death, that he might preach to them the Gospel. This passage must be allowed to present great difficulties. The most intelligible meaning suggested by the context is, however, that Christ by his spirit preached to those who in the time of Noah, while the ark was preparing, were disobedient, and whose spirits are *now* in prison, abiding the general judgment. The prison is doubtless *hades*, but what *hades* is must be determined by other passages of Scripture; and, whether it is the grave or hell, it is still a prison for those who yet await the judgment-day. This interpretation is in unison with other passages of Scripture, whereas the other is conjecturally deduced from this single text.

Another argument is deduced from Rev. xx. 14, which describes 'death and *hades*' as 'cast into the lake of fire' at the close of the general judgment—meaning, according to the advocates of the doctrine in question, that *hades* should then cease as an intermediate place. But this is also true if understood of the grave, or of the general intermediate *condition* of the dead, or even of hell, as once more and for ever reclaiming what it had temporarily yielded up for judgment—just as we every day see criminals brought from prison to judgment, and after judgment returned to the prison from which they came.

It is further urged, in proof of Hades being an intermediate place other than the grave, that the Scriptures represent the happiness of the righteous as incomplete till after the resurrection. This must be admitted; but it does not thence follow that their souls are previously imprisoned in the earth, or in any other place or region corresponding to the Tartarus of the heathen. Although at the moment of death the disembodied spirits of the redeemed ascend to heaven, and continue there till the resurrection, it is very possible that their happiness shall be incomplete until they have received their glorified bodies from the tomb, and entered upon the full rewards of eternity.

A view supported by so little force of Scripture, seems unequal to resist the contrary evidence which may be produced from the same source, and which it remains briefly to indicate. The effect of this

is to show that the souls of the redeemed are described as proceeding, after death, at once to heaven—the *place of final happiness*, and those of the unredeemed to the *place of final wretchedness*.

In Heb. vi. 12, the righteous dead are described as being in actual inheritance of the promises made to the fathers. Our Saviour represents the deceased saints as already, before the resurrection (for so the context requires), 'like unto the angels,' and 'equal to the angels' (Matt. xxii. 30; Luke xx. 36); which is not very compatible with their imprisonment even in the happier region of the supposed Hades. Our Lord's declaration to the dying thief—'This day shalt thou be with me in Paradise' (Luke xxiii. 43), has been urged on both sides of the argument; but the word is here not Hades, but Paradise, and no instance can be produced in which the paradise beyond the grave means anything else than that 'third heaven,' that 'paradise' into which the Apostle was caught up, and where he heard 'unutterable things' (2 Cor. xii. 2, 4). In the midst of that paradise grows the mystic 'tree of life' (Rev. ii. 7), which the same writer represents as growing near the throne of God and the Lamb (xxii. 2). In Eph. iii. 15, the Apostle describes the whole church of God as being at present in heaven or on earth. But, according to the view under consideration, the great body of the church would be neither in heaven nor on earth, but in Hades—the intermediate place. In Heb. xii. 21-24, we are told that in the city of the living God dwell not only God himself, the judge of all, and Jesus, the mediator of the new covenant, and the innumerable company of angels, but also 'the spirits of just men made perfect'—all dwelling together in the same holy and happy place. To the same effect, but, if possible, still more conclusive, are the various passages in which the souls of the saints are described as being, when absent from the body, present with Christ in heaven (comp. 2 Cor. v. 1-8; Philip. i. 23; 1 Thess. v. 10). To this it is scarcely necessary to add the various passages in the Apocalyptic vision, in which St. John beheld, as inhabitants of the highest heaven, around the throne of God, myriads of redeemed souls, even before the resurrection (Rev. v. 9; vi. 9; vii. 9; xiv. 1, 3). Now the 'heaven' of these passages cannot be the place to which the term Hades is ever applied, for that word is never associated with any circumstances or images of enjoyment or happiness [HEAVEN].

As these arguments seem calculated to disprove the existence of the more favoured region of the alleged intermediate place, a similar course of evidence militates with equal force against the existence of the more penal region of the same place. It is admitted by the staunchest advocates for the doctrine of an intermediate place, that the souls of the wicked, when they leave the body, go immediately into punishment. Now the Scripture knows no place of punishment after death but that which was prepared for the devil and his angels. This place they *now* inhabit; and this is the place to which, after judgment, the souls of the condemned will be consigned (comp. 2 Pet. ii. 4; Matt. xxv. 41). This verse of Peter is the only one in Scripture in which any reference to the word Tartarus occurs: here then, if anywhere, we should find that intermediate place corresponding to the Tartarus of the heathen, from whom the word is bor-

rowed. But from the other text we can be quite certain that the Tartarus of Peter is no other than the hell which is to be the final, as it is, in degree, the present doom of the wicked. That this hell is Hades is readily admitted, for the course of the argument has been to show that Hades is hell, whenever it is not the grave. 'Whether the righteous and the wicked, after the judgment, will go literally to the same places in which they were before situated, it is not material to inquire. But, both before and after the judgment, the righteous will be in the same place with their glorified Saviour and his holy angels; and this will be heaven: and before and after the judgment the wicked will be in the same place with the devil and his angels; and this will be hell' (Dr. Enoch Pond, *On the Intermediate Place, in American Biblical Repository*, for April, 1841, whom we have here chiefly followed: comp. Knapp's *Christian Theology*, § 104; Meyer, *De Notione Orci ap. Hebræos*, Lub. 1793; Bahrens, *Freimüthige Unterss. über d. Orkus d. Hebræer*, Halle, 1786).

The notion repelled in this article was entertained by Justin Martyr, Irenæus, Tertullian, and many other of the early Christian fathers. This, however, proves nothing in its favour, as the same notion was common among the Jews themselves, in and before the time of Christ. It may even have been entertained by the Seventy when they translated the Hebrew *sheol* by the Greek *hades*. The question connected with Hades has indirectly brought under view two of the three notions respecting the state of the soul after death. The third notion is that of those who hold that the soul is in a perfectly quiescent condition until the resurrection. This requires notice under another head [SOUL: see also HEAVEN; HELL].

HAGAR (הַגָּר, a stranger; Sept. Ἄγαρ), a native of Egypt, and servant of Abraham; but how or when she became an inmate of his family we are not informed. The name Hagar, which is pure Hebrew, signifying *stranger*, having been probably given her after her arrival, and being the one by which she continued to be designated in the patriarch's household, seems to imply that her connection with it did not take place till long after this family had emigrated to Canaan; and the presumption is that she was one of the female slaves presented to Abraham by Pharaoh during his visit to Egypt (Gen. xii. 16). But some derive the name from גָּר, *to flee*; and suppose it to have been applied to her from a remarkable incident in her life, to be afterwards mentioned; just as the Mahomedans call the flight of Mahomet by the collateral term 'Hegira.' Whatever were her origin and previous history, her servile condition in the family of Abraham must have prevented her from being ever known beyond the limits of her humble sphere, had not her name, by a spontaneous act of her mistress, become indissolubly linked with the patriarch's history. The long continued sterility of Sarah suggested to her the idea (not uncommon in the East) of becoming a mother by proxy through her handmaid, whom, with that view, she gave to Abraham as a secondary wife [ABRAHAM; ADOPTION; CONCUBINE].

The honour of such an alliance and elevation was too great and unexpected for the weak and ill-regulated mind of Hagar: and no sooner did she find herself in a delicate situation, which made

her, in the prospect of becoming a mother, an object of increasing interest and importance to Abraham, than she openly indulged in triumph over her less favoured mistress, and showed by her altered behaviour a growing habit of disrespect and insolence. The feelings of Sarah were severely wounded, and she broke out to her husband in loud complaints of the servant's petulance. 'My wrong be upon thee,' she cried—language which is generally considered an impassioned burst of temper, in which she unjustly charged Abraham with causing or encouraging, by his marked attention to the concubine, the ill usage she met with; but it appears susceptible of other constructions much more favourable to Sarah's

character. The words ך ע חסדי signify either 'My wrong be *super te*,' as Cocceius and others render it, *i. e.* lieth upon thee, pointing to his duty as her protector, and soliciting his interference, or else 'My wrong is *propter te*—on your account. 'I have exposed myself to these indignities solely out of my intense anxiety to gratify you with a son and heir.' Whichever of these interpretations we prefer, the exclamation of Sarah expresses bitter indignation at the misconduct of her slave; and Abraham, whose meek and prudent behaviour is strikingly contrasted with the violence of his wife, leaves her with unfettered power, as mistress of his household, to take what steps she pleases to obtain the required redress. In all Oriental states where concubinage is legalized, the principal wife has authority over the rest; the secondary one, if a slave, retains her former condition unchanged, and society thus presents the strange anomaly of a woman being at once the menial of her master and the partner of his bed. In like manner Hagar, though taken into the relation of concubine to Abraham, continued still, being a dotal maid-servant, under the absolute power of her mistress, who, after her husband had left her to take her own way in vindication of her dignity as the principal wife, was neither reluctant nor sparing in making the minion reap the fruits of her insolence. Sarah, indeed, not content with the simple exertion of her authority, seems to have resorted even to corporal chastisement, the word תענה conveying such a meaning, and hence Augustine has drawn an elaborate argument for inflicting civil penalties on heretics (*Epist.* xlviii.). But whether she actually inflicted blows, or merely threw out menaces to that effect, cannot be determined, as the two renderings, 'Sarah afflicted' and 'would afflict' her, have received equal support from respectable lexicographers and versions. Sensible, at length, of the hopelessness of getting the better of her mistress, Hagar determined on flight; and having seemingly formed the purpose of returning to her relations in Egypt, she took the direction of that country; which led her to what was afterwards called Shur, through a long tract of sandy uninhabited country, lying on the west of Arabia Petrea, to the extent of 150 miles between Palestine and Egypt. In that lonely region she was sitting by a fountain to replenish her skin-bottle or recruit her wearied limbs, when the angel of the Lord, whose language on this occasion bespeaks him to have been more than a created being, appeared, and in the kindest manner remonstrated with her on the course she was pursuing, and

encouraged her to return by the promise that she would ere long have a son, whom Providence destined to become a great man, and whose wild and irregular features of character would be indelibly impressed on the mighty nation that should spring from him. Obedient to the heavenly visitor, and having distinguished the place by the name of Beer-lahai-roi, 'the well of the visible God,' Hagar retraced her steps to the tent of Abraham, where in due time she had a son; and having probably narrated this remarkable interview to Abraham, that patriarch, as directed by the angel, called the name of the child Ishmael, 'God hath heard.'

Fourteen years had elapsed after the birth of Ishmael when an event occurred in the family of Abraham, by the appearance of the long-promised heir, which entirely changed the prospects of that young man, though nothing materially affecting him took place till the weaning of Isaac, which, as is generally thought, was at the end of his third year. Ishmael was then a lad of seventeen years of age; and being fully capable of understanding his altered relations to the inheritance, as well as having felt perhaps a sensible diminution of Sarah's affection towards him, it is not wonderful that a disappointed youth should inconsiderately give vent to his feelings on a festive occasion, when the newly-weaned child, clad according to custom with the sacred symbolic robe, which was the badge of the birthright, was formally installed heir of the tribe (see *Biblioth. Bibl.* vol. i.; Vicas, *Annot.* 32; Bush on Gen. xxvii. 15). Our feelings of justice naturally lead us to take part with Ishmael, as hardly dealt with in being so unexpectedly superseded after having been so long the acknowledged heir. But the procedure of Abraham in awarding the claim to the inheritance to Isaac in preference to his elder son was guided by the special command of God; and it may be remarked, moreover, that it was in harmony with the immemorial practice of the East, where the son of a slave or secondary wife is always supplanted by that of a free woman, even if born long after. The harmony of the weaning feast was disturbed by Ishmael being discovered mocking. The Hebrew word צחק , though properly signifying 'to laugh,' is frequently used to express strong derision, as in Gen. xix. 14; Neh. ii. 19; iv. 1; Ezek. xxiii. 32; accompanied, as is probable on some of the occasions referred to in these passages, with violent gestures; and in accordance with this idea the Chaldee and Septuagint versions render it by 'I play,' which is used by the latter in 2 Sam. ii. 14-17, as synonymous with boxing, whence it might very justly be characterized as persecution (Gal. iv. 29). This conduct gave mortal offence to Sarah, who from that moment would be satisfied with nothing short of his irrevocable expulsion from the family; and as his mother also was included in the same condemnation, there is ground to believe that she had been repeating her former insolence, as well as instigating her son to his improprieties of behaviour. So harsh a measure was extremely painful to the affectionate heart of Abraham; but his scruples were removed by the timely appearance of his divine counsellor, who said, 'Let it not be grievous in thy sight, because of the lad, and because of thy bondwoman: in all that Sarah hath said unto thee, hearken unto her voice: 'for,' **adds**

the Targum of Jonathan, 'she is a prophetess.' Accordingly, what she said is called the Scripture (Gal. iv. 30), and the incident affords a very remarkable instance of an overruling Providence in making this family feud in the tent of a pastoral chief 4000 years ago the occasion of separating two mighty peoples, who, according to the prophecy, have ever since occupied an important chapter in the history of man. Hagar and Ishmael departed early on the day fixed for their removal, Abraham furnishing them with the necessary supply of travelling provisions. The Septuagint, which our translators have followed, most absurdly represents Ishmael as a child, placed along with the travelling-bags on the heavily-loaded shoulders of Hagar. But a little change in the punctuation, the observance of the parenthetical clause, and the construction of the word 'child' with the verb 'took,' remove the whole difficulty, and the passage will then stand thus: 'And Abraham rose up early in the morning, and took bread, and a bottle of water (and gave it unto Hagar, putting it on her shoulder), and the child, and sent her away.'

In spite of their instructions for threading the desert, the two exiles missed their way. Overcome by fatigue and thirst, increasing at every step under the unmitigated rays of a vertical sun, the strength of the young Ishmael, as was natural, first gave way, and his mother laid him down in complete exhaustion under one of the stunted shrubs of this arid region, in the hope of his obtaining some momentary relief from smelling the damp in the shade. The burning fever, however, continued unabated, and the poor woman, forgetting her own sorrow, destitute and alone in the midst of a wilderness, and absorbed in the fate of her son, withdrew to a little distance, unable to witness his lingering sufferings; and there 'she lifted up her voice and wept.' In this distressing situation the angel of the Lord appeared for the purpose of comforting her, and directed her to a fountain, which, concealed by the brushwood, had escaped her notice, and from which she drew a refreshing draught, that had the effect of reviving the almost lifeless Ishmael. This well, according to the tradition of the Arabs, who pay great honour to the memory of Hagar, is Zemzem, near Mecca.

Of the subsequent history of Ishmael we have no account, further than that he established himself in the wilderness of Paran, in the neighbourhood of Sinai, was married by his mother to a countrywoman of her own, and maintained both himself and family by the produce of his bow.—R. J.

HAGARENES. [ARABIA.]

HAGGAI (חַגַּי; Sept. and Joseph. Ἀγγαῖος; Jerome and Vulg. Aggæus or Aggeus, otherwise Haggæus), one of the twelve minor prophets, and the first of the three who, after the return of the Jews from the Babylonian exile, prophesied in Palestine. Of the place and year of his birth, his descent, and the leading incidents of his life, nothing is known which can be relied on. Some assert that he was born in Babylon, and came to Jerusalem when Cyrus, in the year B.C. 536, allowed the Jews to return to their country (2 Chron. xxxiv. 23; Ezra i. 1).—The new colony consisting chiefly of people belonging to the tribes of Judah,

Benjamin, and Levi, with a few from other tribes. The more fabulous traditions of Jewish writers, who pass him for an Assessor of the *Synagoga Magna*, and enlarge on his literary avocations, have been collected by Carpov (*Introductio in V. T.* iii. p. 426). This much appears from his prophecies, that he flourished during the reign of the Persian monarch Darius Hystaspis, who ascended the throne B.C. 521. These prophecies are comprised in a book of two chapters, and consist of discourses so brief and summary as to have led some German theologians to suspect that they have not come down to us in their original complete form, but are only an epitome (Bichhorn, *Einleitung in das A. T.* iii. § 598; Jahn, *Introductio in libros sacros Vet. Fed.*, edit. 2, Vienna, 1814, § 156). Their object generally is to urge the rebuilding of the Temple, which had indeed been commenced as early as B.C. 535 (Ezra iii. 10), but was afterwards discontinued, the Samaritans having obtained an edict from the Persian king, which forbade further procedure, and influential Jews pretending that the time for rebuilding the Temple had not arrived, since the seventy years predicted by Jeremiah applied to the Temple also, from the time of the destruction of which it was then only the sixty-eighth year. As on the death of Pseudo-Smerdis, and the consequent termination of his interdict, the Jews still continued to wait for the end of the seventy years, and were only engaged in building splendid houses for themselves, Haggai began to prophesy in the second year of Darius, B.C. 520.

His first discourse (ch. i.), delivered on the first day of the sixth month of the year mentioned, foretells that a brighter era would begin as soon as Jehovah's house was rebuilt; and a notice is subjoined, stating that the address of the prophet had been effective, the people having resolved on resuming the restoration of the Temple. The second discourse (ch. ii. 1-9), delivered on the twenty-first day of the seventh month, predicts that the glory of the new Temple would be greater than that of Solomon's, and shows that no fear need be entertained of the Second Temple not equalling the first in splendour, since, in a remarkable political revolution, the gifts of the Gentiles would be brought thither. The third discourse (ch. ii. 10-19), delivered on the twenty-fourth day of the ninth month, refers to a period when building materials had been collected, and the workmen had begun to put them together; for which a commencement of the Divine blessing is promised. The fourth and last discourse (ch. ii. 20-23), delivered also on the twenty-fourth day of the ninth month, is exclusively addressed to Zerubbabel, the political chief of the new Jewish colony, who, it appears, had asked for an explanation regarding the great political revolutions which Haggai had predicted in his second discourse: it comforts the governor by assuring him they would not take place very soon, and not in his lifetime. The style of the discourses of Haggai is suitable to their contents: it is pathetic when he exhorts; it is vehement when he reproves; it is somewhat elevated when he treats of future events; and it is not altogether destitute of a poetical colouring, though a prophet of a higher order would have depicted the splendour of the Second Temple in brighter hues. The language labours under a poverty of terms, as may be observed in the constant repetition of the same expressions.

ג. ה. יהוה. כה אמר יהוה (i. 2, 5, 7), נאם יהוה three times in one verse (ii. 4), with חזק three times in the same verse, and רחן three times also in one verse (i. 14). Eichhorn (*Einleitung*, § 599) attributes these repetitions to an attempt at ornament, rendering the writer disposed to recur frequently to a favourite expression. The prophetic discourses of Haggai, בְּנוֹאת הַגִּי נְבִיאָה, are referred to in the Old and New Testament (Ezra v. 1; vi. 14; Heb. xii. 26; comp. Hagg. ii. 7, 8, 22). In most of the ancient catalogues of the canonical books of the Old Testament, Haggai is not, indeed, mentioned by name; but as they specify the twelve minor prophets, he must have been included among them, as otherwise their number would not be full. Josephus, mentioning Haggai and Zechariah (*Antiq.* xi. 4. § 5, p. 557), calls them δύο προφήται. (See generally Rosenmüller, *Scholia in Vet. Test.* vii. 4. p. 74; Jahn, *Einleitung in die göttlichen Bücher des Alten Bundes*, ii. 2. p. 658; Bertholdt, *Einleitung*, iv. p. 169.)—J. v. H.

HAGIOGRAPHIA, Sacred Writings. The word ἁγιογραφα is first found in Epiphanius (*Panarium*, p. 58), who used it, as well as γραφεία, to denote the third division of the Scriptures, called by the Jews כְּתוּבִים, or the *Writings*, consisting of five books [ΜΕΓΙΛΛΟΤΗ], viz. the three poems (אִמְת), Job, Proverbs, and the Psalms, and the two books of Chronicles.

These divisions are found in the Talmud (*Bava Bathra*, fol. 1, ed. Amsterd.), where the sacred books are classified under the *Law*, the *Prophets*, and the *Writings* (*Cetubim*). The last are thus enumerated (l. c.):—Ruth, the book (*sepher*) of Psalms, Job, Proverbs, Ecclesiastes (*Koheleth*), the Song of Songs, Lamentations, Daniel, and the books (*megilloth*) of Esther, Ezra, and Chronicles. The Jewish writers, however, do not uniformly follow this arrangement, as they sometimes place the Psalms, or the book of Job, as the first of the Hagio-grapha. Jerome gives the arrangement followed by the Jews in his time. He observes that they divided the Scriptures into five books of Moses, eight prophetic books (viz. 1. Joshua; 2. Judges and Ruth; 3. Samuel; 4. Kings; 5. Isaiah; 6. Jeremiah; 7. Ezekiel; 8. The twelve prophets), and nine *Hagio-grapha*, viz. 1. Job; 2. David, five parts; 3. Solomon, three parts; 4. Koheleth; 5. Canticles; 6. Daniel; 7. Chronicles; 8. Esdras, two books [viz. Ezra and Nehemiah]; 9. Esther. 'Some, however,' he adds, 'place Ruth and Lamentations among the Hagio-grapha rather than among the prophetic books.' We find a different arrangement in Josephus, who reckons thirteen prophetic books, and four containing hymns and moral precepts; from which it would appear that after the time of Josephus the Jews comprised many books among the prophets which had previously belonged to the Hagio-grapha. It has, however, been considered as more probable that Josephus had no authority from manuscripts for his classification.

The earliest notice which we find of these divisions is that contained in the prologue to the book of Ecclesiastics, written B.C. 130, the author of which refers to the Law, the Prophets, and the *other books*: by which last were most probably meant the Hagio-grapha. Philo also speaks of the Laws, the Prophets, the Hymns, and the other books, but without classifying them. In the New Testa-

ment we find three corresponding divisions mentioned, viz. the Law, the Prophets, and the Psalms; which last book has been supposed to have given its name to the third division, from the circumstance of its then being the first in the catalogue (Luke xxiv. 44). Hävernick, however (*Handbuch*, p. 78), supposes that Luke calls the Hagio-grapha by the name of Psalms, rather on account of the poetical character of several of its parts. The 'book of the Prophets' is referred to in the New Testament as a distinct volume (Acts vii. 42, where the passage indicated is Amos v. 25, 26). It is well known that the second class was divided by the Jews into the early Prophets, viz. Joshua, Judges, Samuel, and Kings; and the later Prophets, viz. Isaiah, Jeremiah, Ezekiel (called the major prophets), and the book of the twelve (minor) prophets.

When this division of books was first introduced it is now impossible to ascertain. Probably it commenced after the return from the exile, with the first formation of the canon. Still more difficult is it to ascertain the principle on which the classification was formed. The rabbinical writers maintain that the authors of the *Cetubim* enjoyed only the lowest degree of inspiration, as they received no immediate communication from the Deity, like that made to Moses, to whom God spake face to face; and that they did not receive their knowledge through the medium of visions and dreams, as was the case with the prophets or the writers of the second class; but still that they felt the Divine Spirit resting on them and inspiring them with suggestions. This is the view maintained by Abarhanel (*Pref. in Proph. priores*, fol. 20. l.), Kimchi (*Pref. in Psalm.*), Maimonides (*More Nevochim*, ii. 45, p. 317), and Elias Levita (*Tisbi*); which last writer defines the word כְּתוּב to mean a *work written by divine inspiration*. The placing of Ruth among the Hagio-grapha, and especially the separation of Lamentations from Jeremiah, seems, however, to be irreconcilable with this hypothesis; nor is it easy to assign a satisfactory reason why the historical books of Joshua, Judges, Samuel, and Kings should be placed among the *Prophets*, and the book of Chronicles among the *Hagio-grapha*. The reasons generally assigned for this, as well as for placing in the third class the books of Psalms, Daniel, and Job, are so fanciful and unsatisfactory as to have led Christian writers to form other and more definite classifications. It will suffice to mention the reason assigned by Rabbi Kimchi for excluding Daniel from the book of Prophets, viz. that he has not equalled the other prophets in his visions and dreams. Others assign the late date of the book of Daniel as the reason for the insertion of it, as well as of some historical books, in the Hagio-grapha, inasmuch as the collection of the Prophets was closed at the date of the composition of this book (De Wette, § 255). Bertholdt, who is of this opinion (*Einleitung*, vol. i. p. 70, sqq.), thinks that the word *Cetubim* means 'books newly introduced into the canon' (p. 81). Hengstenberg (*Authentic der Daniel*, &c., p. 25, sqq.) follows the ancient opinion of the rabbins, and maintains that the book of Daniel was placed in the Hagio-grapha in consequence of the lower degree of inspiration attached to it; but herein he is opposed by Hävernick (*Handbuch*, p. 62). De Wette (§ 13) supposes

that the two first divisions (the *Law* and the *Prophets*) were closed a little after the time of Nehemiah (comp. 2 Macc. ii. 13, 14), and that perhaps at the end of the Persian period the Jews commenced the formation of the *Hagiographa*, which long remained 'changeable and open.' The collection of the Psalms was not yet completed when the two first parts were formed.

It has been concluded from Matt. xxiii. 35 and Luke xi. 51, comp. with Luke xxiv. 44, that as the Psalms were the first, so were Chronicles the last book in the *Hagiographa* (Carpozov, *Introd.* iv. p. 25.) If, when Jesus spoke of the righteous blood shed from the blood of Abel (Gen. iv. 8) to that of Zechariah, he referred, as most commentators suppose, to Zechariah the son of Jehoiada (2 Chron. xxiv. 20, 21), there appears a peculiar appositeness in the appeal to the first and the last books in the canon. The book of Chronicles still holds the last place in the Hebrew Bibles, which are all arranged according to the threefold division. The late date of Chronicles may in some measure account for its separation from the book of Kings; and this ground holds good whether we fix the era of the Chronicler, with Zunz, at about b.c. 260, or, with the eminent Roman Catholic, Professor Movers, the able defender of the antiquity and authenticity of the book, we conceive him to have been a younger contemporary of Nehemiah, and to have written about b.c. 400 (*Kritische Untersuchung über die Biblische Chronik*, Bonn, 1834). The circumstance of the existence of a few acknowledged later additions, such as 1 Chron. iii. 19-24, does not militate against this hypothesis. De Wette conceives that the genealogy in this passage comes down only to the third generation after Nehemiah.

The word *Hagiographa* is once used by Jerome in a peculiar sense. Speaking of Tobit, he asserts that the Jews, cutting off this book from the catalogue of the divine Scriptures, place it among those books which they call *Hagiographa*. And again, of Judith he says, 'by the Jews it is read among the *Hagiographa*, whose authority is not sufficient to confirm debated points;' but, as in the latter instance, the greater number of manuscripts read *Apocrypha*, which is doubtless the true reading, it is highly probable that the word *Hagiographa*, used in reference to the book of Tobit, has arisen from the mistake of a transcriber. The two words were in the middle ages frequently used as synonymous [DEUTERO-CANONICAL]. *Hagiographa* has been also used by Christian writers as synonymous with Holy Scripture.

The Alexandrian translators have not been guided by the threefold division in their arrangement of the books of Scripture. We have already [DEUTERO-CANONICAL] given the order of the Codex Alexandrinus. In the Vatican Codex Tobit and Judith are placed between Nehemiah and Esther. Wisdom and Ecclesiasticus follow Canticles. Baruch and Lamentations follow Jeremiah, and the Old Testament concludes with the four books of Maccabees. Luther (who introduced into the Bible a peculiar arrangement, which in the *Old Testament* has been followed in the English Authorized Version) was the first who separated the canonical from the other books. Not only do the Alexandrian translators, the Fathers, and Luther differ from the Jews in the order of succession of the sacred books, but among

the Jews themselves the Talmudists and Masorites, and the German and Spanish manuscripts follow each a different arrangement.—W. W.

HAIR. [A1.]

HAIR is frequently mentioned in Scripture, and in scarcely anything has the caprice of fashion been more strikingly displayed than in the various forms which the taste of different countries and ages has prescribed for disposing of this natural covering of the head. The Greeks let their hair grow to a great length, and their natural fondness for this attribute of beauty has been perpetuated not only by the frequently recurring epithet of Homer, *καρηκουδωρες*, as descriptive of the *'Αχαιοί*, but by the circumstance of the poets and artists of that ancient people representing even the gods themselves with long hair. The early Egyptians, again, who were proverbial for their habits of cleanliness, removed the hair as an incumbrance, and the almost unavoidable occasion of sordid and offensive negligence. They shaved even the heads of young children, leaving only certain locks, as an emblem of youth, on the front, the back, and the sides. In the case of royal children those on the sides were covered and enclosed in a bag, which hung down conspicuously as a badge of princely rank. All classes amongst that people, not excepting the slaves imported from foreign countries, were required to submit to the tonsure (Gen. xli. 14); and yet, what was remarkable in the inhabitants of a hot climate, while they removed their natural hair, they were accustomed to wear wigs, which were so constructed that 'they far surpassed,' says Wilkinson, 'the comfort and coolness of the modern turban, the reticulated texture of the ground-work on which the hair was fastened allowing the heat of the head to escape, while the hair effectually protected it from the sun (*Anc. Egyptians*, iii. 354). Different from the custom both of the Greeks and the Egyptians, that of the Hebrews was to wear their hair generally short, and to check its growth by the application of scissors only. The priests at their inauguration shaved off all their hair, and when on actual duty at the temple, were in the habit, it is said, of cutting it every fortnight. The only exceptions to this prevailing fashion are found in the case of the Nazarites, whose hair, from religious duty, was *not* to be cropped during the term of their vow; of young persons who, during their minority, allowed their hair to hang down in luxuriant ringlets on their shoulders; of such effeminate persons as Absalom (2 Sam. xiv. 26); and of Solomon's horse-guards, whose vanity affected a puerile extravagance, and who strewed their heads every day with particles of gold-dust (Josephus, *Antiq.* viii. 7). Although the Hebrews wore their hair short, they were great admirers of strong and thickset locks; and so high a value did they set on the possession of a good head of hair, that they deprecated nothing so much as baldness; to which, indeed, so great ignominy was attached that, whether a man was destitute of hair or not, bald-head became a general term expressive of deep and malignant contempt (2 Kings ii. 23) [BALDNESS]. To prevent or remedy this defect they seem, at an early period, to have availed themselves of the assistance of art, not only for beautifying the hair, but increasing its thickness; while the heads of the priests were anointed with an unguent of a peculiar kind, the in-

redients of which, with their various proportions, were prescribed by divine authority, and the composition of which the people were prohibited, under severe penalties, from attempting to imitate (Exod. xxx. 32). This custom spread till anointing the hair of the head became a general mark of gentility and an essential part of the daily toilet; the usual cosmetics employed consisting of the best oil of olives mingled with spices, a decoction of parsley-seed in wine, and more rarely of spikenard (Ps. xxiii. 5; xlv. 7; Eccles. ix. 8; Mark xiv. 3). The prevailing colour of hair among the Hebrews was dark; 'locks bushy and black as a raven,' being mentioned in the description of the bridegroom as the perfection of beauty in mature manhood (Sol. Song, v. 11). Hence the appearance of an old man with a snow-white head in a company of younger Jews, all whose heads, like those of other Eastern people, were jet black—a most conspicuous object—is beautifully compared to an almond-tree, which in the early part of the year is in full blossom, while all the others are dark and leafless (Eccles. xii. 5). A story is told of Herod, that in order to conceal his advanced age, he used secretly to dye his gray locks with a dark pigment (Joseph. *Antiq.* xvi. 8); and although the anecdote was probably an unfounded calumny on that prince, yet that it was customary with many of his Roman contemporaries to employ artificial means for changing or disguising the silver hue of age, is sufficiently apparent from the works of Martial and other satirical poets. From Rome the fashion spread into Greece and other provinces, and it appears that the members of the church of Corinth were, to a certain extent, captivated by the prevailing taste, some Christians being evidently in the eye of the Apostle, who had attracted attention by the cherished and womanly decoration of their hair (1 Cor. xi. 14-16). To them the letter of Paul was intended to administer a timely reproof for allowing themselves to fall in with a style of manners which, by confounding the distinctions of the sexes, threatened a baneful influence on good morals: and that not only the Christian converts in that city, but the primitive church generally, were led by this admonition to adopt simpler habits, is evident from the remarkable fact that a criminal, who came to trial under the assumed character of a Christian, was proved to the satisfaction of the judge to be an impostor, by the luxuriant and frizzled appearance of his hair (Tertullian, *Apol.*; Fleury, *Les Mœurs des Chrétiens*).

With regard to women, the possession of long and luxuriant hair is allowed by Paul to be an essential attribute of the sex—a graceful and modest covering provided by nature; and yet the same Apostle elsewhere (1 Tim. ii. 9) concurs with Peter (1 Pet. iii. 9) in launching severe invectives against the ladies of his day for the pride and passionate fondness they displayed in the elaborate decorations of their head-dress. As the hair was pre-eminently the 'instrument of their pride' (Ezek. xvi. 39, margin), all the resources of ingenuity and art were exhausted to set it off to advantage and load it with the most dazzling finery; and many when they died caused their longest locks to be cut off, and placed separately in an urn, to be deposited in their tomb as the most precious and valued relics. In the daily use of cosmetics

they bestowed the most astonishing pains in arranging their long hair; sometimes twisting it round on the crown of the head, where, and at the temples, by the aid of gum, which they knew as well as the modern belles, they wrought it into a variety of elegant and fanciful devices—figures of coronets, harps, wreaths, diadems, emblems of public temples and conquered cities, being formed by the mimic skill of the ancient friseur; or else, plaiting it into an incredible number of tresses, which hung down the back, and which, when necessary, were lengthened by ribbons so as to reach to the ground, and were kept at full stretch by the weight of various wreaths of pearls and gold fastened at intervals down to the extremity. From some Syrian coins in his possession Hartmann (*Die Hebräer in am Putzische*) has given this description of the style of the Hebrew coiffure; and many ancient busts and portraits which have been discovered exhibit so close a resemblance to those of Eastern ladies in the present day, as to show that the same elaborate and gorgeous disposition of their hair has been the pride of Oriental females in every age.

From the great value attached to a profuse head of hair arose a variety of superstitious and emblematic observances, such as shaving parts of the head, or cropping it in a particular form; parents dedicating the hair of infants (Tertullian, *De Anima*) to the gods; young women theirs at their marriage; warriors after a successful campaign; sailors after deliverance from a storm; hanging it up on consecrated trees, or depositing it in temples; burying it in the tomb of friends, as Achilles did at the funeral of Patroclus; besides shaving, cutting off, or plucking it out, as some people did; or allowing it to grow in sordid negligence, as was the practice with others, according as the calamity that befell them was common or extraordinary, and their grief was mild or violent.

Various metaphorical allusions are made to hair by the sacred writers, especially the prophets. 'Cutting off the hair' is a figure used to denote the entire destruction of a people by the righteous retributions of Providence (Isa. vii. 20). 'Gray hairs here and there on Ephraim' portended the decline and fall of the kingdom of Israel (Hos. vii. 9). 'Hair like women's' forms part of the description of the Apocalyptic locusts, and historically points to the prevailing head-dress of the Saracens, as well as the voluptuous effeminacy of the Antichristian clergy (Rev. ix. 8). And, finally, 'hair like fine wool' was a prominent feature in the appearance of the deified Redeemer, emblematic of the majesty and wisdom that belong to him (Rev. i. 14).

HALAH (חֵלָה; Sept. Ἁλαε), or rather CHALACH, a city or district of Media, upon the river Gozan, to which, among other places, the captives of Israel were transplanted by the Assyrian kings. Many, after Bochart (*Geog. Sacra*, iii. 14. p. 220), have conceived this Halah or Chalach to be the Calachene which Ptolemy places in the north of Assyria. But if the river Gozan be the Kizzil-Ozan, Halah must needs be sought elsewhere, and near that river. Accordingly Major Rennell indicates as lying along its banks a district of some extent, and of great beauty and fertility, named Chalchal, having within it a

remarkably strong position of the same name, situated on one of the hills adjoining to the mountains which separate it from the province of Ghilan (*Geog. of Herod.* p. 396).

HALLELUJAH (הַלְלוּ־יְהוָה), or **ALLELUIA** (Ἀλληλοῦῖα), a word which stands at the beginning of many of the Psalms. From its frequent occurrence in this position it grew into a formula of praise, and was chanted as such on solemn days of rejoicing. This is intimated by the Apocryphal book of Tobit (xiii. 18), when speaking of the rebuilding of Jerusalem, 'And all her (Jerusalem's) streets shall sing Alleluia' (comp. Rev. xix. 1, 3, 4, 6). This expression of joy and praise was transferred from the synagogue to the church, and is still occasionally heard in devotional psalmody. It is so often found in the beautiful hymns of John and Charles Wesley, that the frequent use of it has almost become a characteristic of the religious body named after the former.

HAM (חַם). 1. The youngest son of Noah (*Gen.* v. 32; comp. ix. 24). Having provoked the wrath of his father by an act of indecency towards him, the latter cursed him and his descendants to be slaves to his brothers and their descendants (ix. 25). To judge, however, from the narrative, Noah directed his curse only against Canaan (the fourth son of Ham) and his race, thus excluding from it the descendants of Ham's three other sons, Cush, Mizraim, and Phut (*Gen.* x. 6). How that curse was accomplished is taught by the history of the Jews, by whom the Canaanites were subsequently exterminated. The general opinion is, that all the Southern nations derive their origin from Ham (to which the Hebrew root חַם, *hot*, not unlike the Greek *ἄθλωες*, lends some force). *Cush* is supposed to have been the progenitor of the nations of East and South Asia, more especially of South Arabia, and also of Ethiopia; *Mizraim*, of the African nations, including the Philistines and some other tribes which Greek fable and tradition connect with Egypt; *Phut*, likewise of some African nations; and *Canaan*, of the inhabitants of Palestine and Phœnicia. On the Arabian traditions concerning Ham, *vid.* D'Herbelot (*Bibl. Orient. art.* 'Ham').

2. A poetical name for the land of Egypt (*Ps.* lxxviii. 51; cv. 23, 27; cvi. 22). In the Egyptian language **XHMI**, or **KHME**, signifies *black*. Plutarch also (*De Isid. et Osir.* 33) calls Egypt *Chemia*: τῆν Αἴγυπτον ἐν τοῖς μάχιστα μελάνγειον ὄσαν, ὡσπερ τὸ μέλαν τοῦ ὀφθαλμοῦ, Χημίαν καλοῦσιν.

In *Gen.* xiv. 5 occurs a country or place called *Ham*, belonging to the *Zuzim*, but its geographical situation is unknown.—E. M.

HAMAN (חַמָּן), a name of the planet *Mercury*; Sept. Ἄμαν), a favourite of the king of Persia, whose history is involved in that of Esther and Mordecai. He is called an Agagite; and as Agag was a kind of title of the kings of the Amalekites [**AGAG**], it is supposed that Haman was descended from the royal family of that nation. He or his parents probably found their way to Persia as captives or hostages; and that the foreign origin of Haman was no bar to his advancement at court, is a circumstance quite in union with the most ancient and still subsisting

usages of the East. Joseph, Daniel, and Mordecai afford other examples of the same kind.

It is unnecessary to repeat the particulars of a story so well known: as that of Haman. The circumstantial details of the height which he attained and of his sudden downfall, afford, like all the rest of the book of Esther, a most faithful picture of the customs of an Oriental court and government, and furnish invaluable materials for a comparison between the regal usages of ancient and modern times. The result of such a comparison will excite surprise by the closeness of the resemblance; for there is not a single fact in the history of Haman which might not occur at the present day, even in its merely formal characteristics, and which, indeed, is not of frequent occurrence in different combinations. The boundless credit which Haman enjoyed with Ahasuerus; the homage which all the court in consequence paid to him; the royal signet-ring, the impression from which gave such authority to all written orders, and placed the doom of nations in the hands of its possessor; the price of blood which Haman offered to the king; the iniquitude of that inordinate power which could endure no rival, and which the shadow of opposition offended and alarmed; and the form of poetical justice given to the final retribution in the hanging of Haman upon a gallows which he had prepared for another;—all these are traits which would at the present day be received in Asia as the unexaggerated record of current events.

Even the decree for the extermination of the Jews which was granted at the request of Haman, however startling it may appear to those whose notions are grounded upon European institutions, would appear in no wise strange under an Oriental government. Even in Europe the fanaticism and tyranny of ancient governments often produced similar proscriptions (sometimes with reference to the very same people), which, under the mildness and tranquillity of modern institutions, we are as little able to comprehend. But in the East we have still no difficulty in discovering the traces of the same excesses of despotism, the same blind submission in the people, the same respect for the seal of the sovereign, and the same passive resignation to the sword which he uplifts or to the bowstring which he sends. Even in our own day we have seen imperial firmans consign to utter destruction in the mass the Greeks, the Druses, and the Maronites; and such things must and will occur wherever the extermination of a people is unhappily so easy a matter that it costs a despot no further trouble than the drawing of a ring from his finger. Other times and other names make all the difference—the manners are the same. It may be well to observe that Haman never mentions Mordecai himself to the king; and that in speaking of the Jews he does not name them directly, but describes them as 'a certain people' dispersed through the kingdom, and living separate under laws of their own (*Esth.* iii. 8). That this people, or any other subject to his sceptre, should require to be thus descriptively indicated, seems to show how little the king knew of the actual state of his dominions, or of persons beyond the immediate circle of the court. The death of Haman appears to have taken place about the year B.C. 510.

HAMATH (חַמַּתַּי; Sept. Ἐμᾶθ), one of the smaller kingdoms of Syria, having Zobah on the east and Rehob on the south. This last kingdom, lying within the greater Mount Hermon, is expressly said to have been taken possession of by the Israelites, and, like Dan or Laish, which is represented to have been in the valley of Beth-rehob (Judg. xviii. 28), is used to denote the northern boundary of the Holy Land. Thus it it is said (Num. xiii. 21) that the spies 'went up and searched the land, from the wilderness of Zin unto Rehob, as men come to Hamath,' which lay to the south of Rehob, beyond Hermon. The approach to it from the south is by an opening or mountain-pass, called 'the entrance of Hamath,' and 'the entering in of Hamath,' which, being the passage from the northern extremity of the land of Israel into Syria, is sometimes used to describe the boundary of the former in this direction, as 'from the entering in of Hamath to the river of Egypt' (1 Kings viii. 65). This 'entering in of Hamath' answers to the route taken by Burckhardt (*Syria*, p. 249) from El-Bekaa, or the southern part of the valley between the two chains of Libanus and Anti-Libanus, to Banias. As there does not appear, from his description, to be any elevated ground in this route, there would seem to be a depression of the chain which bears the name of Jebel es-Sheikh.

The kingdom of Hamath, or, at least, the southern or central parts of it, appear to have nearly corresponded with what was afterwards denominated Cœle-Syria; but northwards, it stretched as far as the city Hamath on the Orontes, which seems to have been the capital of the whole country. This city was called Epiphania by the Greeks, under which name it was known to Josephus (*Antiq.* i. 6. 2; comp. Michaelis, *Spicil.* ii. 52) and Jerome (*Quæst. in Gen.* x. 15; *Comment. in Ezek.* xviii. 15, 16); but it has now resumed its more ancient denomination, which indeed was probably never lost among the native population. Toi was king of Hamath at the time when David conquered the Syrians of Zobah; and it appears that he had reason to rejoice in the humiliation of a dangerous neighbour, as he sent his own son Joram to congratulate the victor (2 Sam. viii. 9, 10). In the time of Hezekiah the town along with its territory was conquered by the Assyrians (2 Kings xvii. 24; xviii. 34; xix. 13; Isa. x. 9; xi. 11); and afterwards by the Chaldeans (Jer. xxxix. 2, 5). Abulfeda, the Arabian geographer, who was prince of Hamath in the fourteenth century, correctly states (*Tab. Syriæ*, p. 108) that this city is mentioned in the books of the Israelites. He adds, 'It is reckoned one of the most pleasant towns of Syria. The Orontes flows round the greater part of the city on the east and north. It boasts a lofty and well-built citadel. Within the town are many dams and water-machines, by means of which the water is led off by canals to irrigate the gardens and supply private houses. It is remarked of this city and of Schiazar that they abound more in water-machines than any other cities in Syria.' This description still, in a great degree, applies. Hamath is a picturesque town, of considerable circumference, and with wide and convenient streets. In Burckhardt's time the attached district contained 120 inhabited villages, and 70 or 80 that lay waste. The western part of this district

forms the granary of Northern Syria, though the harvest never yields more than a tenfold return, chiefly on account of the immense numbers of mice, which sometimes completely destroy the crops (Pococke, *Travels*, ii. 209; Burckhardt, *Travels in Syria*, p. 249; Richter, *Wallfahrten*, p. 231; comp. Rosenmüller's *Bib. Geography*, ii. 243-246).

HANAMEEL, a kinsman of Jeremiah, to whom, before the siege of Jerusalem, he sold a field which he possessed in Anathoth, a town of the Levites (Jer. xxxii. 6-12). If this field belonged to Hanameel as a Levite, the sale of it would imply that an ancient law had fallen into disuse (Lev. xxv. 34); but it is possible that it may have been the property of Hanameel in right of his mother. The transaction was conducted with all the forms of legal transfer, and was intended to evince the certainty of restoration from the approaching exile, by showing that possessions which could be established by documents would yet be of future value to the possessor (B.C. 587).

1. HANANI (חַנַּנִּי, *gracious*; Sept. Ἀνανι), a prophet under the reign of Asa, king of Judah, by whom he was seized and imprisoned for announcing that he had lost, from want of due trust in God, an advantage which he might have gained over the king of Syria (2 Chron. xvi. 7). The precise occasion of this declaration is not known. This Hanani is supposed to be the same who was father of another prophet, named Jehu (1 Kings xvi. 7); but circumstances of time and place seem adverse to this conclusion.

2. HANANI, a brother of Nehemiah, who went from Jerusalem to Shushan, being sent most probably by Ezra, and brought that information respecting the miserable condition of the returned Jews which led to the mission of Nehemiah. Hanani came back to Judæa, probably along with his brother, and, together with one Hananiah, was appointed to take charge of the gates of Jerusalem, and see that they were opened in the morning and closed in the evening at the appointed time. The circumstances of the time and place rendered this an important and responsible duty, not unattended with some danger (Neh. vii. 2, 3). B.C. 455.

1. HANANIAH (חַנַּנְיָהּ, *Jehovah's goodness*; Sept. Ἀνανιᾶ), a false prophet of Gibeon, who, by opposing his prophecies to those of Jeremiah, brought upon himself the terrible sentence, 'Thou shalt die *this year*, because thou hast taught rebellion against the Lord.' He died accordingly (Jer. xxviii. 1, sq.), B.C. 596.

2. HANANIAH. [SHADRACH.]

3. HANANIAH, the person who was associated with Nehemiah's brother Hanani in the charge of the gates of Jerusalem. The high eulogy is bestowed upon him, that 'he was a faithful man, and feared God above many' (Neh. vii. 2) [HANANI 2].

HAND, the organ of feeling, rightly denominated by Galen the instrument of instruments, since by its position at the end of the fore-arm, its structure and its connection with the mind, the hand admirably executes the behests of the human will, and acquires and imparts to man incomparable skill and power. By the peculiarities of

its conformation—the inclination of the thumb to the palm, the comparative length of the thumb and of the fingers, ‘the hollow of the hand,’ and the fleshy protuberances by which that hollow is mainly formed—this member is wonderfully adapted to the purposes for which it was designed, and serves to illustrate the wisdom and providence of the great Creator (*The Hand, its Mechanism, and vital Endowments, as evincing Design*, by Sir Charles Bell). In no one quality is the hand more distinguished as an instrument than in the flexibility of the parts, and the ease with which the whole is moved—a power which is owing to the complexity of its structure, consisting, as it does, of no fewer than twenty-seven separate bones, which are bound together and put in motion by nineteen muscles.

The hand itself serves to distinguish man from other terrestrial beings. No other animal has any member comparable with the human hand. The trunk of the elephant unites the attributes of skill and power to a surprising extent, but yields the palm to the hand. The fore-foot of the ouranoutang, though possessed of extraordinary properties, is greatly inferior to the hand. In the chimpanzee the thumb is so short as not to extend further than the root of the fingers.

Of the two hands the right has a preference derived from natural endowment. Its universal use, as the chief instrument in acting, serves to show that its superiority is something more than an accident. But the preference which it holds is only a part of the general advantage which the right side has over the left, not only in muscular strength, but also in its vital or constitutional properties (Bell).

Considering the multiplex efficacy of the human hand, the control which it has given man, the conquest over the external world which it has enabled him to achieve, and the pleasing and useful revolutions and improvements which it has brought about, we are not surprised to read the glowing eulogy in which Cicero (*De Nat. Deor.* ii. 60) has indulged on the subject, nor to find how important is the part which the hand performs in the records of divine revelation. From the properties already described, the student of Scripture is prepared to see the hand employed in holy writ as a symbol of skill, strength, and efficacy. As a part of that general anthropomorphism, without whose aid men in the early ages could probably have formed no conception of God, and which, after all, is less gross among the ancient Hebrews than among other contemporary nations, the Deity is frequently spoken of in the records of revelation as if possessed of hands; though it may be questioned if such phraseology was, even in primitive times, anything more than figurative, a setting forth of the unknown by the known, a sort of pictorial writing in divine things. It is, however, pretty safe to affirm, that many vulgar errors in religion owe their origin and support to the inaptitude of men to look through the sign to the thing signified, to pass from the shadow upwards to the substance, to divest eternal truth of its temporary vestments. Were this more generally effected, God would not be regarded as seated in some part of space on a throne of gold, with his son placed literally at his ‘right hand;’ but the scriptural representations would be seen to indicate the ceaseless providence and constant

supervision of the Creator, in which the risen and glorified Jesus has an intimate interest and a supreme share.

The ordinary usages of Scripture in regard to ‘hand,’ ‘right hand,’ &c., must be familiar to the student, and the passages on which the representations above made are founded, are too easy of access, by means of a Concordance, to need being enumerated here: it may therefore be more useful to confine the rest of our remarks to one or two specific and more important points.

The phrase ‘sitting at the right hand of God,’ as applied to the Saviour of the world, is derived from the fact that with earthly princes a position on the right hand of the throne was accounted the chief place of honour, dignity, and power:—‘upon thy right-hand did stand the queen’ (Ps. xlv. 9; compare 1 Kings ii. 19; Ps. lxxx. 17). The immediate passage out of which sprang the phraseology employed by Jesus may be found in Ps. cx. 1: ‘Jehovah said unto my Lord, sit thou at my right hand until I make thine enemies thy footstool.’ Accordingly the Saviour declares before Caiaphas (Matt. xxvi. 64; Mark xiv. 62), ‘Ye shall see the Son of man sitting on the right hand of power, and coming in the clouds of heaven;’ where the meaning obviously is that the Jews of that day should have manifest proofs that Jesus held the most eminent place in the divine favour, and that his present humiliation would be succeeded by glory, majesty, and power (Luke xxiv. 26; 1 Tim. iii. 16). So when it is said (Mark xvi. 19; Rom. viii. 34; Col. iii. 1; 1 Pet. iii. 22; Heb. i. 3; viii. 1) that Jesus ‘sits at the right hand of God,’ ‘at the right hand of the Majesty on high,’ we are obviously to understand the assertion to be that, as his Father, so he worketh always (John v. 17) for the advancement of the kingdom of heaven, and the salvation of the world.

As the hand is the great instrument of action, so is it eminently fitted for affording aid to the mind, by the signs and indications which it makes. Thus to lay the hand on any one was a means of pointing him out, and consequently an emblem of setting any one apart for a particular office or dignity. *Imposition of hands* accordingly formed, at an early period, a part of the ceremonial observed on the appointment and consecration of persons to high and holy undertakings. In Num. xxvii. 19 Jehovah is represented as thus speaking to Moses, ‘Take thee Joshua, the son of Nun, a man in whom is the spirit, and lay thine hand upon him, and set him before Eleazar the priest, and before all the congregation, and give him a charge in their sight,’ &c.: where it is obvious that the laying on of hands did neither originate nor communicate divine gifts; for Joshua had ‘the spirit’ before he received imposition of hands; but was merely an instrumental sign for marking him out individually, and setting him apart, in sight of the congregation, to his arduous work. Similar appears to be the import of the observance in the primitive church of Christ (Acts viii. 15-17; 1 Tim. iv. 14; 2 Tim. i. 6). A corruption of this doctrine was, that the laying on of hands gave of itself divine powers, and on this account Simon, the magician (Acts viii. 18), offered money, saying ‘Give me also this power, that on whomsoever I lay hands he may receive the Holy Ghost,’ in-

tending probably to carry on a gainful trade by communicating the gift to others.

In Col. ii. 13, 14, 'the law of commandments contained in ordinances' (Ephes. ii. 15), is designated 'the *hand-eriting* of ordinances that was against us,' which Jesus blotted out, and took away, nailing it to his cross; phraseology which indicates the abolition, on the part of the Saviour, of the Mosaic law (Wolfius, *Cura Philolog. in N. T.* iii. 16).—J. R. B.

HANDICRAFT. In the early periods to which the Scriptural history refers we do not meet with those artificial feelings and unreasonable prejudices against hand-labour which prevail and are so banefully influential in modern society. The entire circle of achievement which man had effected in the natural world, was, in ancient times, too immediately and too obviously connected with the labour of the hands, which is, in truth, the great primary source of wealth, for any feeling regarding it to prevail but one of high estimation. When hand-labourers were seen on every side, and found in every grade of life, and when the products of their skill and industry were the chief, if not the sole, advantages which civilization gave, handicraftsmen, as they were among the great benefactors, so were they among the chief favourites of human kind. Accordingly, even the creation of the world is spoken of as the work of God's hands, and the firmament is said to show his handy-work (Ps. viii. 3; xix. 1; Gen. ii. 2; Job xxxiv. 19). The primitive history, too, which the Bible presents is the history of hand-labourers. Adam dressed the garden in which God had placed him (Gen. ii. 15), Abel was a keeper of sheep, Cain a tiller of the ground (Gen. iv. 3), Tubal-cain a smith (Gen. iv. 22). These references prove how soon men gave themselves to the labours of the hand, and these and similar passages serve to show what were the earliest employments, did not the nature of the case suffice to assure us that the most necessary arts would be first cultivated. The general nature of this article does not require any extensive or detailed inquiry into the hand-labours which the Israelites practised before their descent into Egypt; but the high and varied culture which they found there, declares that any history of hand-labour must be very defective the sources of which are found exclusively in the Bible. The shepherd-life which the patriarchs previously led in their own pasture-grounds, was not favourable to the cultivation of the practical arts of life, much less of those arts by which it is embellished. Egypt, in consequence, must have presented to Joseph and his father not only a land of wonders, but a source of rich and attractive knowledge. And though the herdsman-sort of life which the Hebrews continued to lead would not be conducive to their advancement in either science or art; yet it cannot be doubted that they derived in no slight degree those advantages which have always been reaped by a less cultured people, when brought into proximity or contact with a high state of civilization.

Another source of knowledge to the Hebrews of handicrafts were the maritime and commercial Phœnicians. Commerce and navigation imply great skill in art and science; and the pursuits to which they lead largely increase the skill whence they emanate. It is not, therefore,

surprising that the origin of so many arts has been referred to the north-eastern shore of the Mediterranean Sea; nor is there any difficulty in understanding how arts and letters should be propagated from the coast to the interior, conferring high advantages on the inhabitants of Syria in general, as well before as after the settlement of the Hebrew tribes in the land of promise. At first the division of labour was only very partial. The master of the family himself exercised such arts as were found of absolute necessity. Among these may be reckoned not only those which pasturage and tillage required, but most of those which were of that rough and severe nature which demand strength as well as skill; such, for instance, as the preparation of wood-work for the dwelling, the slaying of animals for food, which every householder understood, together with the art of extracting the blood from the entire carcass. The lighter labours of the hand fell to the share of the housewife; such as baking bread—for it was only in large towns that baking was carried on as a trade (2 Sam. xiii. 8),—such, also, as cooking in general, supplying the house with water, no very easy office, as the fountains often lay at a considerable distance from the dwelling: moreover, weaving, making of clothes for males as well as females, working in wool, flax, hemp, cotton, tapestry, richly coloured hangings, and that not only for domestic use, but for 'merchandise,' were carried on within the precincts of the house by the mistress and her maidens (Exod. xxxv. 25; 1 Sam. ii. 19; 2 Kings xxiii. 7; Prov. xxxi.).

The skill of the Hebrews during their wanderings in the desert does not appear to have been inconsiderable; but the pursuits of war and the entire absorption of the energies of the nation in the one great work of gaining the land which had been given to them, may have led to their falling off in the arts of peace; and from a passage in 1 Sam. (xiii. 20) it would appear that not long after they had taken possession of the country they were in a low condition as to the instruments of handicraft. A comparatively settled state of society, however, soon led to the revival of skill by the encouragement of industry. A more minute division of labour ensued. Trades, strictly so called, arose, carried on by persons exclusively devoted to one pursuit. Thus in Judg. xvii. 4 and Jer. x. 14, 'the founder' is mentioned, a trade which implies a practical knowledge of metallurgy; the smelting and working of metals were well known to the Hebrews (Job xxxvii. 18); brass was in use before iron; arms and instruments of husbandry were made of iron. In Exodus (xxxv. 30-35) a passage occurs which may serve to specify many arts that were practised among the Israelites, though it seems also to intimate that at the time to which it refers artificers of the description referred to were not numerous.—'See, the Lord hath called by name Bezaleel, and hath filled him with the spirit of God, in knowledge and all manner of workmanship, and to devise curious works, to work in gold, and in silver, and in brass, and in the cutting of stones, to set them, and in carving of wood, to make any manner of cunning work; and he hath put in his heart that he may teach; both he and Aholiab: them hath he filled with wisdom of heart to work all manner of work

of the engraver; and of the cunning workman, and of the embroiderer in blue and in purple, in scarlet and in fine linen, and of the weaver.' From the ensuing chapter (ver. 34) it appears that gilding was known before the settlement in Canaan. The ark (Exod. xxxvii. 2) was overlaid with pure gold within and without. The cherubim were wrought ('beaten,') Exod. xxxv. 7) in gold. The candlestick was of beaten gold (verses 17, 22). Wire-drawing was probably understood (Exod. xxxviii. 4; xxxix. 3). Covering with brass (Exod. xxxviii. 2) and with silver (Prov. xxvi. 23) was practised. Architecture and the kindred arts do not appear to have made much progress till the days of Solomon, who employed an incredible number of persons to procure timber (1 Kings v. 13, sq.); but the men of skill for building his temple he obtained from Hiram, king of Tyre (1 Kings v. sq.; 1 Chron. xiv. 1; 2 Chron. ii. 7). Without pursuing the subject into all its details (see Scholz, *Handb. der Bib. Archäol.* p. 390, sq.; De Wette, *Lehrb. der Archäol.* p. 115, sq.; Winer, *Realwört.* art. 'Handwerke'), we remark that the intercourse which the Babylonish captivity gave the Jews seems to have greatly improved their knowledge and skill in both the practical and the fine arts, and to have led them to hold them in very high estimation. The arts were even carried on by persons of learning, who took a title of honour from their trade (Rosenmüller, *Morgenl.* vi. 42). It was held a sign of a bad education if a father did not teach his son some handicraft—quicunque filium suum non docet aliquid officium est ac si doceret eum latrocinium—'whoever does not teach his son a trade, teaches him robbing' (Lightfoot, p. 616; Mish. Tr. *Pirke Aboth.* ii. 2; Wagenseil's *Sota*, p. 597; Othon. *Lex. Rabb.* 491).

In the Apocrypha and New Testament there are mentioned tanners (Acts ix. 43), tent-makers (Acts xviii. 3); in Josephus (*De Bell. Jud.* v. 4. 1) cheese-makers; domestics (κουρσεί, *Antiq.* xvi. 11. 5); in the Talmud, with others we find tailors, shoe-makers, blood-letters, glaziers, goldsmiths, plasterers. Certain handicraftsmen could never rise to the rank of high-priest (Mish. Tr. *Kiddush*, 82. 1), such as weavers, barbers, fullers, perfumers, cuppers, tanners; which pursuits, especially the last, were held in disesteem (Mishna, Tr. *Megillah*, iii. 2; Othon. *Lex. Rabb.* 155; Wetstein, *N. T.* ii. 516). In large cities particular localities were set apart for particular trades, as is the case in the East to the present day. Thus in Jeremiah (xxxvii. 21) we read of 'the bakers' street.' So in the Talmud (*Mishna*, v. 169, 225) mention is made of a flesh-market; in Josephus (*De Bell. Jud.* v. 4. 1) of a cheese-market; and in the New Testament (John v. 2) we read of a sheep-market. See Iken, *Antiq. Hebr.* iii.-ix. p. 578, sq.; Bellermann, *Handb.* i. 22, sq.—J. R. B.

HANDKERCHIEF, NAPKIN (σουδάριον; Vulg. *sudarium*), occurs in Luke xix. 20; John xi. 44; xx. 7; Acts xix. 12. The Greek word is adopted from the Latin (like κήσος, μεμβράνα, and many others), and probably, at first, had the same meaning with it, and which, being derived from *sudo*, to perspire, corresponds to our word (pocket) *handkerchief*. The Greek rhetorician Pollux (A.D. 180) remarks that the word σουδάριον had supplanted not only the ancient Greek word for handkerchief, ἡμιτύβιον or ἡμι-

τύβιον, which he considers an Egyptian word, but even the more recent term καψιδράτιον: Τὸ δὲ ἡμιτύβιον ἔστι μὲν καὶ τοῦτο Αἰγύπτιον, εἴη δ' ἂν κατὰ τὸ ἐν τῇ μέσῃ κωμαρδίᾳ, καψιδράτιον καλούμενον, ὃ νῦν σουδάριον ὀνομάζεται (Onomast. vii. 16). The influence of the Romans caused the introduction of this word even among the Orientals. The rabbins have סודרין. In the Syriac version סודרין answers to the Hebrew תפוחין, a veil (margin, sheet or apron); and in Chaldee סודר or סודרה is used for a veil or any linen cloth (Buxtorf, *Lex. Chal.* p. 1412). It is indeed but natural to expect that a foreign word, introduced into any language, should be applied by those who borrow it in a looser sense than they do from whom it is obtained. Hence, although the Latin word *sudarium* is generally restricted to the forementioned meaning, yet in the Greek and Syriac languages it signifies, chiefly, napkin, wrapper, &c. These observations prepare us for the different uses of the word in Scripture. In the first instance (Luke xix. 20) it means a wrapper, in which the 'wicked servant' had laid up the pound entrusted to him by his master. For references to the custom of laying up money, &c. in σουδάρια, both in classical and rabbinical writers, see Wetstein's *N. T.* on Luke xix. 20. In the second instance (John xi. 44) it appears as a kerchief, or cloth attached to the head of a corpse. It was perhaps brought round the forehead and under the chin. In many Egyptian mummies it does not cover the face. In ancient times among the Greeks it did. Niccolans (*De Græcor. Luctu*, c. iii. § 6, Thiel. 1697). Maimonides, in his comparatively recent times, describes the whole face as being covered, and gives a reason for the custom (Tract *Efel*, c. 4). The next instance is that of the σουδάριον which had been 'about the head' of our Lord, but which, after his resurrection, was found rolled up, as if deliberately, and put in a place separately from the linen clothes, χωρὶς ἐντεταλιγμένον εἰς ἓνα τόπον. The last instance of the Biblical use of the word occurs in the account of 'the special miracles' wrought by the hands of Paul (Acts xix. 11); 'so that σουδάρια (handkerchiefs, napkins, wrappers, shawls, &c.) were brought from his body to the sick; and the diseases departed from them, and the evil spirits went out of them.' The Ephesians had not un-naturally inferred that the apostle's miraculous power could be communicated by such a mode of contact; and certainly cures thus received by parties at a distance, among a people famed for their addictedness to 'curious arts,' i. e. magical skill, &c., would serve to convince them of the truth of the gospel, by a mode well suited to interest their minds. The Apostle is not recorded to have expressed any opinion respecting the reality of this intermediate means of those miracles. He had doubtless sufficiently explained that these and all the other miracles 'wrought by his hands,' i. e. by his means, were really wrought by God (ver. 11) in attestation of the mission of Jesus. If he himself did not entertain exactly the same ideas upon the subject as they did, he may be considered as conceding to, or rather not disturbing unnecessarily, popular notions, rendered harmless by his previous explanation, and affording a very convenient medium for achieving much higher purposes. If the connection be-

tween the *secondary* cause and the effect was *real*, it reminds us of our Saviour's expression, 'I perceive that virtue is gone out of me' (Mark v. 30); which is, however, regarded by many critics as a popular mode of saying that he knew that a miracle had been wrought by his power and efficacy—a mode of speaking in *unison* at least with the belief of the woman that she should be healed if she could but touch the hem of his garment unperceived by him, and perhaps even conceded to, in accordance with the miracles wrought through the medium of contact related in the Old Testament (1 Kings xvii. 21; 2 Kings iv. 29, &c.), and in order, by a superior display, in regard both to speed and extensiveness, to demonstrate his supremacy by a mode through which the Jews were best prepared to perceive it (Luke vi. 19; Schwarz, *ad Olear. de Stylo N. T.* p. 129; Soler. *de Pileo*, p. 17; Pierson, *ad Mær.* p. 348; Lydii *Flor. Spars. ad Pass. J. C.* p. 5; Drusius, *Quæst. Heb.* c. 2; Rosenmüller and Kuinoel on the passages).—J. F. D.

HANGING. [PUNISHMENTS.]

HANNAH, properly CHANNAH (חַנָּה, *graciousness*; Sept. Ἀννα), wife of a Levite named Elkanah, and mother of Samuel. She was very dear to her husband, but being childless was much aggrieved by the insults of Elkanah's other wife Peninnah, who was blessed with children. The family lived at Ramathaim-zophim, and, as the law required, there was a yearly journey to offer sacrifices at the sole altar of Jehovah, which was then at Shiloh. Women were not bound to attend; but pious females free from the cares of a family often did so, especially when the husband was a Levite. Every time that Hannah went there childless she declined to take part in the festivities which followed the sacrifices, being then, as it seems, peculiarly exposed to the taunts of her rival. At length, on one of these visits to Shiloh, while she prayed before returning home, she vowed to devote to the Almighty the son which she so earnestly desired (Num. xxx. 1, sq.). It seems to have been the custom to pronounce all vows at the holy place in a loud voice, under the immediate notice of the priest (Deut. xxiii. 23; Ps. xxvi. 14); but Hannah prayed in a low tone, so that her lips only were seen to move. This attracted the attention of the high-priest, Eli, who suspected that she had taken too much wine at the recent feast. From this suspicion Hannah easily vindicated herself, and returned home with a lightened heart. Before the end of that year Hannah became the rejoicing mother of a son, to whom the name of Samuel was given, and who was from his birth placed under the obligations of that condition of Nazaritship to which his mother had vowed him. B.C. 1171.

Hannah went no more to Shiloh till her child was old enough to dispense with her maternal services, when she took him up with her to leave him there, as, it appears, was the custom when one already a Levite was placed under the additional obligations of Nazaritship. When he was presented in due form to the high-priest, the mother took occasion to remind him of the former transaction: 'For this child,' she said, 'I prayed, and the Lord hath given me my petition which I asked of him' (1 Sam. i. 27). Hannah's gladness afterwards found vent in an exulting chant,

which furnishes a remarkable specimen of the early lyric poetry of the Hebrews, and of which many of the ideas and images were in after times repeated by the Virgin Mary on a somewhat similar occasion (Luke i. 46, sq.).

After this Hannah failed not to visit Shiloh every year, bringing a new dress for her son, who remained under the eye and near the person of the high-priest [SAMUEL]. That great personage took kind notice of Hannah on these occasions, and bestowed his blessing upon her and her husband. The Lord repaid her abundantly for that which she had, to use her own expression, 'lent to him'; for she had three sons and two daughters after Samuel.

HANUN (חַנּוּן, *bestower*; Sept. Ἀνών), son and successor of Nabash, king of the Ammonites. David, who had in his troubles been befriended by Nabash, sent, with the kindest intentions, an embassy to condole with him on the death of his father, and to congratulate him on his own accession. The rash young king, however, was led to misapprehend the motives of this embassy, and to treat with gross and inexorable indignity the honourable personages whom David had charged with this mission. Their beards were *half* shaven, and their robes cut short by the middle, and they were dismissed in this shameful trim; which can be appreciated only by those who consider how reverently the beard has always been regarded by the Orientals [BEARD] (B.C. 1038). When the news of this affront was brought to David, he sent word to the ambassadors to remain at Jericho till the growth of their beards enabled them to appear with decency in the metropolis. He vowed vengeance upon Hanun for the insult; and the vehemence with which the matter was taken up forms an instance, interesting from its antiquity, of the respect expected to be paid to the person and character of ambassadors. Hanun himself looked for nothing less than war as the consequence of his conduct; and he subsidized Hadarezer and other Syrian princes to assist him with their armies. The power of the Syrians was broken in two campaigns, and the Ammonites were left to their fate, which was severe even beyond the usual severities of war in that remote age [AMMONITES; DAVID] (2 Sam. x.; 1 Chron. xix.).

HARA (הָרָא), a Chaldee form for הָרָה, *mountain* (Gesenius); Vulg. *Ara*. One of the places to which the tribes beyond the Jordan were carried away by Tiglath-pileser. The word occurs only in a single passage (1 Chron. v. 26); in the Septuagint and Syriac version it is altogether omitted. The Chaldee Paraphrast renders it by טוּרֵי קְבֻלָּא, *mountains of darkness*. Bochart and Gesenius conjecture that it is a name for the northern part of Media, which in Arabic is called *Algehal*, 'the mountainous region,' to which the Hebrew term corresponds. Media, Bochart observes, is called *Aria* by the Greeks, and the inhabitants are denominated Arii (Ἄριοι) (Herod. vii. 62; Bochart, *Geog. Sacra*, iii. 14. p. 194; Gesenius, *The-saurus*, s.v.; Michaelis, *Supplementa ad Lex. Heb.*, vol. i. p. 570).—J. E. R.

HARADAH, a camp or station of the Israelites (Num. xxxiii. 24) [WANDERING].

HARAM. [HOUSE.]

1. HARAN, eldest son of Terah, brother of

Abraham and Nahor, and father of Lot, Milcah, and Iscah. He died before his father Terah; which, from the manner in which it is mentioned, appears to have been a much rarer case in those days than at present (Gen. xi. 27, sq.).

HARAN, or rather CHARAN (חָרָן; Sept. Χάρραν), called by the Greeks Charran, and by the Romans Charrae. It was situated in the north-western part of Mesopotamia, on a river of the same name running into the Euphrates. It is supposed to have been so called from Haran, the father of Lot and brother of Abraham; but there appears no ground for this conclusion except the identity of names. Abraham, after he had been called from Ur of the Chaldees, tarried here till his father Terah died, when he proceeded to the land of Canaan (Gen. xi. 31, 38; Acts vii. 4). The elder branch of the family still remained at Haran; which led to the interesting journeys thither described in the patriarchal history—first, that of Abraham's servant to obtain a wife for Isaac (Gen. xxiv.), and next, that of Jacob when he fled to evade the wrath of Esau (Gen. xxviii. 10). The plain bordering on this town is celebrated in history as the scene of a battle in which the Roman army was defeated by the Parthians, and the Triumvir Crassus killed. Abulfeda (*Tab. Syriae*, p. 164) speaks of Haran as formerly a great city, which lay in an arid and barren tract of country in the province of Viar Modbar. The Sabians had a chapel there which was dedicated to Abraham.

Haran still retains its ancient name in the form of Harran, and is only peopled by a few families of wandering Arabs, who are led thither by a plentiful supply of water from several small streams. It is situated in a flat and sandy plain $\approx 36^{\circ} 40'$ N. lat., $39^{\circ} 2'$ $45''$ E. long.

HARE (חַרְזִי *arnebeth*; Arab. *arneb*) occurs in Lev. xi. 6, and Deut. xiv. 7, and, in both instances, it is prohibited from being used as food, because it chews the cud, although it has not the hoof divided. But the hare belongs to an order of mammals totally distinct from the ruminants, which are all, without exception, bisulca, the camel's hoof alone offering a partial modification. They have all four stomachs; incisor teeth, with some slight modification in the camel, solely in the lower jaw; molars made for grinding, and the lower jawbone articulated, so as to admit of the circular action required for that purpose, when the food, already swallowed, is forced up to be thoroughly triturated. All these characters and faculties are wanting in the hare, which belongs to the order rodentia; for, in common with porcupines, squirrels, beavers, and rats, it has incisor teeth above and below, set like chisels, and calculated for gnawing, cutting, and nibbling. The word 'nibble' itself shows an affinity to the Semitic particle *neb* in the names above cited.) The stomach of rodents is single, and the motion of the mouth, excepting when they masticate some small portion of food reserved in the hollow of the cheek, is more that of the lips, when in a state of repose the animals are engaged in working the incisor teeth upon each other. This practice is a necessary condition of existence, for the friction keeps them fit for the purpose of nibbling, and prevents their growing beyond a proper length. It is a provision of nature in the whole order of

rodents; and, if by any accident the four cutting teeth be rendered inefficient by not closing upon each other at the exact line of contact, they grow rapidly beyond serviceable use, exceed the opening of the mouth, and impede feeding till the animal perishes from want. As hares do not subsist on hard substances, like most of the genera of the order, but on tender shoots and grasses, they have more cause, and therefore a more constant craving, to abrade their teeth; and this they do in a manner which, combined with the slight trituration of the occasional contents of the cheeks, even modern writers, not zoologists, have mistaken for real rumination. In the German versions, the expression *wiederkauen*, 'to chew again,' is much more correct than the English phrase, 'to chew the cud,' because this last implies a faculty which re-chewing does not, and which the hare does not possess.

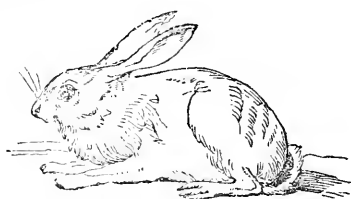

333. [Syrian Hare.]

Physiological investigation having fully determined these questions, it follows that both with regard to the Shaphan and the Hare we should understand the original in the above passages, rendered 'chewing the cud,' as merely implying a second mastication, more or less complete, and not necessarily that faculty of true ruminants, which derives its name from a power to draw up aliment, after deglutition, when worked into a ball, from the first stomach into the mouth, and there to submit it to a second grinding process. The act of 'chewing the cud' and 're-chewing' being considered identical by the Hebrews, the sacred law-giver, not being occupied with the doctrines of science, no doubt used the expression in the sense in which it was then understood. It may be added, that a similar opinion, and consequent rejection of the hare as food, pervaded many nations of antiquity, who derived their origin, or their doctrines, from a Semitic source; and that among others it existed among the British Celts, probably even before they had any intercourse with Phœnician merchants.

There are two distinct species of hare in Syria, one, *Lepus Syriacus*, or Syrian hare, nearly equal in size to the common European, having the fur ochry buff, and *Lepus Sinaiticus*, or hare of the desert, smaller and brownish. They reside in the localities indicated by their trivial names, and are distinguished from the common hare, by a greater length of ears, and a black tail with white fringe. There is found in Egypt, and higher up the Nile, a third species, represented in the outline paintings on ancient monuments, but not coloured with that delicacy of tint required for distinguishing it from the others, excepting that it appears to be marked with the black speckles which characterize the existing species.—C. H. S.

HARETH, a forest in Judah, to which David fled from Saul (1 Sam. xxii. 5) [FOREST].

HARLOT, WHORE, STRANGE WOMAN, &c. (זֹנָה); Sept. πόρνη; Vulg. meretrix; קַדְשָׁה, נְכַרְיָה, קָרְיָה, &c. The first of these English words, to which various etymologies have been assigned, signifies a prostitute for lust or gain. The mercenary motive is more evident in the second, from the German *huren*, Dutch *hueren*, 'to hire.' It is equally apparent in the Greek πόρνη, from πρῶνά, 'to sell'; and in the Latin meretrix, from mereor, 'to earn.' Thus Ovid (*Amor.* i. 10, 21):—

'Stat meretrix certo cuius mercabilis ære,

Et miserae jussu corpore quaerit opes.'

The first Hebrew word (זֹנָה) occurs frequently, and is often rendered in our version by the first of these English words, as in Gen. xxxiv. 31, &c., and sometimes, without apparent reason for the change, by the second, as in Prov. xxiii. 27, and elsewhere. The first English word is also applied to different Hebrew words, whereby important distinctions are lost. Thus in Gen. xxxviii. 15, the word is זֹנָה, 'harlot,' which, however, becomes changed to קַדְשָׁה, 'harlot,' in vers. 21, 22, which means, literally, a consecrated woman, a female (perhaps priestess) devoted to prostitution in honour of some heathen idol. The distinction shows that Judah supposed Tamar to be a heathen: the facts, therefore, do not prove that prostitution was then practised between Hebrews. The following elucidation is offered of the most important instances in which the several words occur:—

First, זֹנָה. From the foregoing account of Judah it would appear that the 'veil' was at that time peculiar to harlots. Judah thought Tamar to be such, 'because she had covered her face.' Mr. Buckingham remarks, in reference to this passage, that 'the Turcoman women go unveiled to this day' (*Travels in Mesopotamia*, i. 77). It is contended by Jahn and others that in ancient times all females wore the veil (*Bibl. Archæol.* p. 127). Possibly some peculiarity in the size of the veil, or the mode of wearing it, may have been (שֵׁת זֹנָה), Prov. vii. 10) the distinctive dress of the harlot at that period (see New Translation, by the Rev. A. De Sola, &c. pp. 116, 248-9). The priests and the high-priest were forbidden to take a wife that was (*had been*, Matt. xxi. 31) a harlot. Josephus extends the law to all the Hebrews, and seems to ground it on the prohibition against oblations arising from prostitution, Deut. xxiii. 18 (*Antiq.* iv. 8. 23). The celebrated case of Rahab has been much debated. She is, indeed, called by the word usually signifying harlot (Josh. ii. 1; vi. 17; Sept. πόρνη; Vulg. meretrix; and in Heb. xi. 31; James ii. 25); but it has been attempted to show that the word may mean an innkeeper [РАХАВ]. The next instance introduces the epithet of 'strange woman.' It is the case of Jephthah's mother (Judg. xi. 2), who is also called a harlot (πόρνη; meretrix); but the epithet אִשָּׁה אַחֵרָה, 'strange woman,' merely denotes foreign extraction. Josephus says ξένος περι την μητέρα, 'a stranger by the mother's side.' The masterly description in Prov. vii. 6, &c. may possibly be that of an abandoned married woman (ver. 19, 20), or of the solicitations of a courtesan, 'fair speech,' under such a pretension. The mixture of religious observances (ver. 14) seems illustrated

by the fact that 'the gods are actually worshipped in many oriental brothels, and fragments of the offerings distributed among the frequenters' (Dr. A. Clarke's *Comment.* in loc.). The representation given by Solomon is no doubt founded upon facts, and therefore shows that in his time prostitutes plied their trade in the 'streets' (Prov. vii. 12; ix. 14, &c.; Jer. iii. 2; Ezek. xvi. 24, 25, 31). Since the Hebrews regarded Jehovah as the husband of his people, by virtue of the covenant he had made with them (Jer. iii. 1); therefore, to commit fornication is a very common metaphor in the Scriptures to denote defections on their part from that covenant, and especially by the practice of idolatry [FORNICATION]. Hence the degeneracy of Jerusalem is illustrated by the symbol of a harlot (Isa. i. 21), and even that of heathen cities, as of Nineveh (Nah. iii. 4). Under this figure the prophet Ezekiel delivers the tremendous invectives contained in ch. xvi., xxiii. In the prophecy of Hosea the illustration is carried to a startling extent. The prophet seems commanded by the Lord to take 'a wife of whoredoms and children of whoredoms' (ch. i. 2), and to 'love an adulteress' (ch. iii. 1). It has, indeed, been much disputed whether these transactions were real, or passed in vision only; but the idea itself, and the diversified applications of it throughout the prophecy, render it one of the most effective portions of Scripture [HOSEA].

Secondly, קַדְשָׁה (occurs Gen. xxxviii. 15, 21, 22; Deut. xxiii. 17; Hos. iv. 14). It has been already observed that the proper meaning of the word is consecrated prostitute. The very early allusion to such persons, in the first of these passages, agrees with the accounts of them in ancient heathen writers. Herodotus refers to the 'abominable custom of the Babylonians, who compelled every native female to attend the temple of Venus once in her life, and to prostitute herself in honour of the goddess' (i. 199; Baruch, vi. 43). Strabo calls prostitutes, who, it is well known, were at Athens dedicated to Venus, ἱερῶδουλοι γυναῖκες, 'consecrated servants,' 'votaries' (*Geog.* viii. p. 378; Grotius, *Annotat. on Baruch*; Beloe's *Herodotus*, Notes, vol. i. p. 272, Lond. 1806). The transaction related in Numbers xv. 1-15 (comp. Ps. cvi. 28) seems connected with idolatry. The prohibition in Deut. xxiii. 17, 'there shall be no קַדְשָׁה, "whore," of the daughters of Israel,' is intended to exclude such devotees from the worship of Jehovah (see other allusions, Job xxxvi. 14; 1 Kings xiv. 24; xv. 12).

Thirdly, נְכַרְיָה, 'the strange woman' (1 Kings xi. 1; Prov. v. 20; vi. 24; vii. 5; xxiii. 27; Sept. ἀλλοστρία; Vulg. aliena, extranea). It seems probable that some of the Hebrews in later times interpreted the prohibition against fornication (Deut. xxii. 41) as limited to females of their own nation, and that the 'strange women' in question were Canaanites and other Gentiles (Josh. xxiii. 13). In the case of Solomon they are specified as Moabites, Ammonites, Edomites, Zidonians, and Hittites. The passages referred to discover the character of these females. To the same class belongs זֹרָה, 'the strange woman' (Prov. v. 3, 20; xxii. 14; xxiii. 33; γύνη πόρνη, ἀλλοστρία; meretrix, aliena, extranea): it is sometimes found זֹרָה אִשָּׁה (Prov. ii. 16; vii. 5)

To the same class of females belongs כסילות אשת, 'the foolish woman,' i. e. by a common association of ideas in the Shemitish dialects, *sinful* (Ps. xiv. 1). The description in Prov. ix. 14, &c. illustrates the character of the female so designated. To which may be added אשת רע, 'the evil woman' (Prov. v. 24).

In the New Testament *πόρνη* occurs in Matt. xxi. 31, 32; Luke xv. 30; 1 Cor. vi. 15, 16; Heb. xi. 31; James ii. 25. In none of these passages does it necessarily imply prostitution for gain. The likeliest is Luke xv. 30. It is used symbolically for a city in Rev. xvii. 1, 5, 15, 16; xix. 2, where the term and all the attendant imagery are derived from the Old Testament. It may be observed in regard to Tyre, which (Isa. xxiii. 15, 17) is represented as 'committing fornication with all the kingdoms of the world upon the face of the earth,' that these words, as indeed seems likely from those which follow, may relate to the various arts which she had employed to induce *merchants* to trade with her' (Patrick, *in loc.*). So the Sept. understood it, *ἔστραυ ἐμπορίων πάσαις ταῖς βασιλείαις τῆς οἰκουμένης ἐπὶ πρόσωπον τῆς γῆς*. Schleusner observes that the same words in Rev. xviii. 3 may also relate to *commercial dealings*. (Winer's *Realwörterb.* s. v. HURE; RAHAB; Fessellii *Adversar. Sacr.* ii. 27. l. 2; Witteb. 1650. Frisch, *De muliere peregrina ap. Hebr.* Lips. 1744). —J. F. D.

HARMONIES. The object of Harmonies is to arrange the Scriptures in chronological order, so that the mutual agreement of the several parts may be rendered apparent, and the true succession of events clearly understood. With this view various scholars have compiled harmonies of the Old Testament, of the New, and of particular portions of both. Harmonies of the Old Testament exhibit the books disposed in chronological order, as is done by Lightfoot in his 'Chronicle of the Times, and the order of the Texts of the Old Testament;' and by Townsend in his 'Old Testament arranged in Historical and Chronological order.' Harmonies of the New Testament present the gospels and epistles distributed in like order, the latter being interspersed among the Acts of the Apostles. In this way Townsend has proceeded in his valuable work entitled, 'The New Testament arranged in Chronological and Historical order.' Books, however, of this kind are so few in number, that the term *harmony* is almost appropriated by usage to the *gospels*. It is this part of the New Testament which has chiefly occupied the attention of those inquirers whose object is to arrange the Scriptures in their true order. The memoirs of our Lord written by the four Evangelists, have chiefly occupied the thoughts of those who wish to show that they all agree, and mutually authenticate one another. Accordingly, such compositions are exceedingly numerous. The four gospels narrate the principal events connected with our Lord's abode on earth, from his birth to his ascension. There must therefore be a general resemblance between them, though that of John contains little in common with the others, being apparently supplementary to them. Yet there are considerable diversities, both in the order in which facts are narrated, and in the facts themselves. Hence the difficulty of weaving the accounts of the four into a continuous

and chronological history. Those portions of the Gospels that relate to the *resurrection* of the Saviour have always presented the greatest obstacles to the compilers of harmonies, and it must be candidly admitted that the accounts of this remarkable event are not easily reconciled. Yet the labours of West and Townson, especially the latter, have served to remove the apparent contradictions. In addition to them may be mentioned Cranfield and Hales, who have endeavoured to improve upon the attempts of their predecessors.

In connection with harmonies the term *diatesaron* frequently occurs. It denotes a continued narrative selected out of the four Gospels, in which all repetitions of the same or similar words are avoided. It is thus the *result* of a harmony, since the latter, properly speaking, exhibits the entire texts of the four Evangelists, arranged in corresponding columns. In popular language the two are often used synonymously.

The following questions relative to harmonies demand attention:—

1. Have *all* or *any* of the Evangelists observed chronological arrangement in their narratives?

2. What was the duration of our Lord's ministry?

1. It was the opinion of Osiander and his followers, that *all* the Evangelists record the facts of the Saviour's history in their true order. When therefore the same transactions are placed in a different order by the writers, they were supposed to have happened more than once. It was assumed that they took place as often as they were differently arranged. This principle is too improbable to require refutation. Instead of endeavouring to solve difficulties, it boldly meets them with a clumsy expedient. Improbable however as the hypothesis is, it has been adopted by Macknight. It is our decided conviction that *all* the Evangelists have not adhered to chronological arrangement.

The question then arises, have *all* neglected the order of time? Newcome and many others espouse this view. 'Chronological order,' says this writer, 'is not precisely observed by any of the Evangelists; St. John and St. Mark observe it most; and St. Matthew neglects it most.' Bishop Marsh supposes that Matthew probably adhered to the order of time, because he was for the most part an eye-witness of the facts. The others, he thinks, neglected the succession of events. The reason assigned by the learned prelate in favour of Matthew's order, is of no weight, as long as the *inspiration* of Mark, Luke, and John, is maintained. If they were infallibly directed in their compositions, they were in a condition equally favourable to *chronological* narration.

A close inspection of Matthew's Gospel will show that he did not intend to mark the true succession of events. He gives us no definite expressions to assist in arranging his materials in their proper order. Very frequently he passes from one occurrence to another without any note of time; sometimes he employs a *τότε*, sometimes *ἐν ταῖς ἡμέραις ἐκεῖναις*, *ἐν ἐκείνῳ τῷ καιρῷ*, or *ἐν ἐκείνῃ τῇ ἡμέρᾳ*. Rarely is he so minute as to use *μεθ' ἡμέρας* ἐξ (xvii. 1). In short, time and place seem to have been subordinated to the grand object which he had in view, viz., the lively exhibition

of Jesus in his person, works, and discourses. In pursuing this design, he has often brought together similar facts and addresses. Although, therefore, Kaiser founds upon the phrases we have adduced a conclusion the very reverse of ours, yet we believe that Matthew did not propose to follow chronological order. The contrary is obviously implied.

Mark again is still more indefinite than Matthew. Even the *general* expressions found in the first Gospel are wanting in his. The facts themselves, not their true succession, were the object of his attention. Chronological order is not observed in his Gospel, except in so far as that Gospel agrees with Luke's. Yet Cartwright, in his Harmony published about 1630, makes the arrangement of Mark his rule for method.

With regard to Luke, it is probable that he intended to arrange every thing in its true place, because at the beginning of his work, he employs the term *καθεξῆς*. This word is often referred to *succession of events*, without involving *time*; but it seems clearly to imply *chronological* succession (comp. Acts xi. 4). Although, therefore, Grotius and many others oppose the latter view, we cannot but coincide with Beza when he says: 'In harmonia Evangelistarum scribenda, rectiorem ordinem servari putem si in iis quæ habent communia, reliqui ad Lucam potius accommodentur, quam Lucas ad cæteros' (comp. also Olshausen, *Die Echtheit der vier Canon Evang.*, &c., Band i. ss. 82, 3, dritte Aufl.). We may therefore conclude that this Evangelist usually follows the chronological order, especially when such passages as iii. 1 and iii. 23 are considered, where exact notices of time occur. But as the Gospel advances, those expressions which relate to time are as indeterminate as Matthew's and Mark's. Frequently does he pass from one transaction to another without any note of time; and again, he has *μετὰ ταῦτα, ἐν μιᾷ τῶν ἡμερῶν*. In consequence of this vagueness, it is very difficult, if not impossible, to make out a complete harmony of the Gospels according to the order of Luke, because we have no precise data to guide us in inserting the particulars related by Matthew and Mark in their proper places, in the third Gospel. All that can be determined with any degree of probability is, that Luke's order seems to have been adopted as the true, chronological one. Whether the writer has deviated from it in any case, may admit of doubt. We are inclined to believe, that in *all minute particulars* chronological arrangement is not observed. The *general body* of facts and events seems to partake of this character, not every *special circumstance* noticed by the Evangelist. But we are reminded that the *assignment of dates* is distinct from *chronological arrangement*. A writer may narrate all his facts in the order in which they occurred, without specifying the particular time at which they happened; or, on the other hand, he may mark the dates without arranging his narrative in chronological order. But attention to one of these will naturally give rise to a certain opinion with regard to the other. The more indeterminate the notifications of time, the less probable is it that time was an element kept before the mind of the writer. If there be a few dates assigned with exactness, it is a *presumption* that the true ar-

range is observed in other parts where no dates occur. In the succession of events Luke and Mark generally agree.

With regard to John's Gospel, it has little in common with the rest except the two last chapters. It is obvious, however, that his arrangement is chronological. He carefully marks, in general, whether one, two, or three days happened between certain events. His Gospel is therefore of great use in compiling a synopsis.

On the whole, we should make the Gospel of Luke the document to which the others should be subordinated in point of arrangement, not neglecting at the same time that of John in conjunction with it, wherever it is possible to connect them.

Still it appears that there are not sufficient data in the four Evangelists to enable the inquirer to compose a harmony in *exact chronological order*, so as to preclude objections to its arrangement. Since times and places have been left so indeterminate, it is hopeless to conceive of a diatessaron chronologically accurate in all particulars. The problem may continue to employ the ingenuity of inquirers, without affording an adequate compensation for the learning and labour bestowed upon it.

2. What was the duration of our Lord's ministry?

This is a question upon which the opinions of the learned have been much divided, and which cannot be settled with conclusive certainty. In order to resolve it, it is necessary to mark the different Passovers which Christ attended. Looking to the Gospels by Matthew, Mark, and Luke, we should infer that he was present at no more than two; the first at the time of his baptism, the second immediately before his crucifixion. But in John's Gospel *three* Passovers at least are named during the period of our Lord's ministry (ii. 13; vi. 4; xi. 55). It is true that some writers have endeavoured to adapt the Gospel of John to the other three, by reducing the Passovers mentioned in the former to *two*. So Priestley, Vossius, and Mann. In order to accomplish this, it was conjectured that *πάσχα*, in ch. vi. 4, is an interpolation, and then that *ἑορτή* denotes some other Jewish festival. Bishop Pearce went so far as to conjecture that the *entire verse* has been interpolated. For these rash speculations there is no authority. The received reading must here be followed (Lücke's *Commentar über Johannes*, dritte Aufl., zweiter Theil, s. 104). In addition to these passages, it has been thought by many that another Passover is referred to in v. 1, where, although *πάσχα* does not occur, *ἡ ἑορτή* is supposed to denote the same feast. But this is a subject of dispute. Irenæus is the oldest authority for explaining it of the Passover. Cyril and Chrysostom, however, referred it to the Feast of *Pentecost*; an opinion approved of by Erasmus, Calvin, and Beza. But Luther, Chemnitz, Calovius, Scaliger, Grotius, and Lightfoot, returned to the ancient view of Irenæus. Kepler seems to have been the first who conjectured that it meant the Feast of *Purin* immediately preceding the Second Passover. He was followed by Petau, Lamy, D'Outrein, &c. Cocceius, followed by Kaiser, referred it to the *Feast of Tabernacles*. While Kepler and Petau intimated that it *may possibly* have been the *Feast of Dedication*. Bengel defended the opinion of Chrysostom; while Hug

with much plausibility endeavours to show that it alludes to the feast of *Purim* immediately before the Passover. The latter view is adopted by Tholuck, Olshausen, and Clausen; though Greswell maintains that the Passover is meant.

It would occupy too much space to adduce the various considerations that have been urged for and against the two leading opinions, viz. the *Passover* and the *Feast of Purim*. The arguments advanced on either side are not conclusive. There is still room for doubt. The true meaning of *ἑσπρῆ* (for Lachmann has rightly expunged the article from before it) is still indeterminate (see especially Lücke *über Johannes*, dritte Aufl., zweiter Theil, ss. 1-15, and Hug's *Introduction* translated by Fosdick, § 64, p. 447, sqq.). To us it appears most probable that the most ancient hypothesis is correct; although the circumstances urged against it are neither few nor feeble.

Sir Isaac Newton and Macknight suppose that five Passovers intervened between our Lord's baptism and crucifixion. This assumption rests on no foundation. Perhaps the term *ἑσπρῆ* in John vii. 2 may have given rise to it; although *ἑσπρῆ* is explained in that passage by *σκηνοπηγία*.

It has been well remarked by Bishop Marsh, that the Gospel of John presents almost insuperable obstacles to the opinion of those who confine Christ's ministry to one year. If John mentions but three Passovers, its duration must have exceeded two years; but if he mentions four, it must have been longer than three years. During the first three centuries it was commonly believed that Christ's ministry lasted but one year, or one year and a few months. Such was the opinion of Clemens Alexandrinus and Origen. Eusebius thought that it continued for above three years; which hypothesis became general. The ancient hypothesis, which confined the time to one year, was revived by Mann and Priestley; but Newcome, with more judgment, defended the common view, and refuted Priestley's arguments. In interweaving the Gospels of Matthew, Mark, and Luke, with that of John, the intervals between the Passovers are filled up by various transactions. Were the number of these feasts determinate and precise, there would be a general agreement in the filling up of the times between them; but in consequence of the uncertainty attaching to the subject, harmonies are found materially to differ in their modes of arrangement. One thing is evident, that the moderns in their endeavours after a chronological disposition of the Gospels, adopt a far more rational course than the ancients. The latter strangely supposed that the first six chapters of John's Gospel relate to a period of Christ's ministry prior to that with which the other three evangelists begin their accounts of the miracles. Thus John *alone* was supposed to narrate the events belonging to the earlier part of his ministry, while Matthew, Mark, and Luke related the transactions of the last year.

The most ancient Harmony of the Gospels of which we have any account was composed by Tatian of Syria in the second century; but it is now lost (see H. A. Daniel's *Tatianus der Apologet.*, Halle, 1837, 8vo.). In the third century, Ammonius* was the author of a Harmony sup-

posed to be still extant. Eusebius of Cæsarea also composed a Harmony of the Gospels about A.D. 315. In it he divided the Gospel history into ten canons or tables, according as different facts are related by one or more of the evangelists. These ancient Harmonies, however, differ in character from such as belong to modern times. They are summaries of the life of Christ, or *indexes* to the four Gospels, rather than a chronological arrangement of different facts, accompanied by a reconciliation of apparent contradictions. In modern times, Andreas Osiander published his *Harmony of the Gospels* in 1537. He adopted the principle that the evangelists constantly wrote in chronological order. Cornelius Jansenius' *Concordia Evangelica* was published in 1549. Martin Chemnitz's *Harmony* was first published in 1593, and afterwards, with the continuations of Leyser and Gerhard, in 1628. Chemnitz stands at the head of that class of harmonists who maintain that in one or more of the four Gospels chronological order has been neglected; while Osiander is at the head of those harmonists who maintain that all the Gospels are arranged in chronological order. Other harmonies were published by Lightfoot (1654), Cradock (1668), Lamy (1689), Le Clerc (1699), Toinard (1707), Whiston (1702), Rus (1727-8-30), Bengel (1736), Hauber (1737), Doddridge (1739 and 40), Pilkington (1747), Macknight (1756), Bertling (1767), Griesbach (1776, 97, 1809, 22), Newcome (1778), Priestley (1777 in Greek, and 1780 in English), Michaelis (1788, in his Introduction), White (1799), De Wette and Lücke (1818), Matthæi (1826), Kaiser (1828), Roediger (1829), Clausen (1829), Greswell (1830), Carpenter (1838), Reichel (1840), and Overbeck (1843).

The latest work of importance which has appeared in Germany on this subject is that of Ziegler.

In connection with Greswell's *Harmonia Evangelica*, the same author's *Dissertations upon the Principles and Arrangement of a Harmony of the Gospels*, of which a second edition has been published, deserve notice. These dissertations are exceedingly elaborate, and demand a patient perusal. The learned writer has greatly distinguished himself as the most laborious of modern harmonists. His work is the most copious that has appeared, at least since the days of Chemnitz's folios. Some of his fundamental principles, however, are questionable. On the whole, were we confined to one Harmony of the Gospels, we should prefer that of Newcome to any other. But to adopt any one implicitly, is more than the enlightened inquirer can consent to do. We should therefore recommend a minute examination of the works published by Newcome, Greswell, Michaelis, De Wette and Lücke, and Clausen.

The above list contains the *best Harmonies* and *Diataxarons* of the Gospels. Some are written in Greek, or Greek and Latin, others in Latin,

Eusebius and Jerome in ancient, as also Bayle and Basnage in modern times, have fallen into this mistake. The same blunder is committed by the writer of the article 'Ammonius Saccas' in Smith's *Dictionary of Greek and Roman Biography and Mythology*. See Neander's *Allgem. Geschichte*, i. 3. S. 1183, Murdock's *Mosheim*, vol. i. p. 174, note 18 (3rd edit. New York).

* This Ammonius is not to be confounded with Ammonius Saccas the philosopher, although

others in German and Greek, others in English. The entire number of Harmonies is very great. Those who wish to see lists tolerably complete may consult Fabricii *Bibliotheca Græca*, vol. iv., ed. Harles; Walchii *Bibliotheca Theologica*, tom. iv.; Michaelis's *Introd.*, by Marsh, vol. iii., with the translator's very valuable notes.—S. D.

HAROD (הַרְוֹד; Sept. Ἀράδ), a brook not far from Jezreel and Mount Gilboa. The name means 'palpitation,' and it has been suggested that it originated in consequence of the alarm and terror of most of the men who were here tested by Gideon (Judg. vii. 1-3); but this supposition seems very far-fetched, and the name more probably arose from some peculiarity in the outflow of the stream.

HAROSHETH OF THE GENTILES (הַרְשֵׁת הַגִּיּוֹת; Sept. Ἀρισάθ τῶν ἔθνων), a city supposed to have been situated near Hazor, in the northern parts of Canaan, called afterwards Upper Galilee, or Galilee of the Gentiles [GALILEE]. Harosheth is said to have been the residence of Sisera, the general of the armies of Jabin, king of Canaan, who reigned in Hazor. To this place Jabin himself was pursued and defeated by Deborah and Barak (Judg. iv. 2, 13, 16).

HARP. [MUSIC.]

HART [AJAL; ANTELOPE]. Fallow-deer having been omitted as a separate article, and there being some confusion in the history of the Asiatic and African *Cervidæ*, increased perhaps by the remarks of Ehrenberg (*Symb. Physic. dec. i.*) under the head of *Ant. Leucoryx*, it may be proper to take notice of his attempt to demonstrate, with the aid of Bochart and Rosenmüller, who wrote when the zoology of Syria was almost unknown, that *Antholops* and *Jachmur* denoted fallow-deer, and particularly such as were of a white colour! But Cuvier, in his *Ossemens Fossiles*, has shown that *Dama* among the ancients was oftener intended to refer to the antelope than to the fallow-deer, of which he had sought the native region in vain for many years. The species appeared to be largest in Spain; and it was only after the second edition of his work was in the press that he first received a wild young specimen, shot in the woods south of Tunis. Northern Africa, therefore, may be the original residence of this animal; although it is found wild also in Sweden, where palmated horns are more evidently useful to clear the snow from autumnal verdure; and recent fossil remains attest that it was a native of the whole of western Europe. There is, however, no evidence that it was ever found, or that it now exists, in Asia, or that an occasional *Albino* of any species should have obtained the particular names above cited. Neither Cuvier, nor it appears Ehrenberg, was acquainted with the existence of the *Cervus Barbarus* of northern Africa; which, though allied to the Corsican stag, wants the bisantler, has the horns somewhat flattened, and is slightly speckled: it therefore appears to be intermediate with fallow-deer.

This species, we are assured, has been seen east of the Nile, in the desert of Arabia, and is there reputed to be fond of eating fish (small lizards)—a propensity which impels other species to attack even dangerous serpents; and there is on the north of Palestine the *Gewasen* of Armenia, a

species of stag of the *Rusa* group, which comes westward into Anatolia, and is not unlikely the real *Zamor* (זָמֹר) of Scripture, since the name *Saumor* is still in use for the *Rusa* of India and Caubul; and in that case *Akko* (אֲכֹ) would naturally designate the *Tragelophus* [GOAT]. Since the discovery of gunpowder great modifications have taken place in the residence of the sporting and more ferocious animals. We know, as yet, little of those ranging in Southern Arabia, and across the Shat-ul-Arab into Persia, and therefore have no just right to deny that there are any species of *Oryx* which may occasionally still visit, or which formerly did frequent, the borders of the Euphrates.—C. H. S.

HAVILAH (הַוִּילָה; Sept. Εὐιάδ). 1. A district in Arabia Felix, deriving its name from the second son of Cush (Gen. x. 7), or, according to others, from the second son of Joktan (Gen. x. 29; comp. xxv. 18). There can be no doubt, however, of the existence of a double Havilah; one founded by the descendant of *Ham*, and the other by that of *Shem*. Niebuhr (*Beschr. von Arab.*, pp. 270, 280) actually found in Yemen two districts called *Chaulan* or *Haulan* (probably the

present **خولان**), one between Saana and Mecca, and the other a few leagues south-east from Saana; which latter Büsching (*ErdBesch.* v. i. 601) considers to be the Havilah founded by the son of Cush, as mentioned Gen. x. 7 (Michaelis, *Spicil.* i. 189, sq.; ii. 202). From Gen. xxv. 18, it would appear that the land of Havilah formed the eastern boundary of the Israelites, and so likewise from 1 Sam. xv. 7, where it seems, moreover, to have been a possession belonging to the Amalekites. Others, however, take this Havilah also for a district in Arabia, and understand by *Shur*, the city *Pelusium* or *Sin* (Ezek. xxx. 15) in Egypt (see Michaelis on this passage).

2. **הַוִּילָה**; Sept. Εὐιάδ, a land rich in gold, bdellium, and shoham, mentioned in Gen. ii. 11, in the geographical description of Paradise. Some identify this with the preceding; but others take it to be *Chwala* on the Caspian Sea, from whence that sea itself is said to have derived the Russian name of *Chwalinskoy more* (Sea of Chwala); and others suppose it a general name for India (*T. Hieros.* הַנְּדִיָּה), in which case the river *Pison*, mentioned as surrounding it, would be identified with the *Ganges*.—E. M.

HAVOTH-JAIR (the Hebrew and Arabic הַוּוֹת הַיַּר). *Havoth* signifies 'cabins' or 'huts,' such as belong to the Arabians, and a collection of which is regarded as forming a hamlet or village. The district of Havoth-jair (*Jair's hamlets*), mentioned in Num. xxxii. 41, and Deut. iii. 14, was beyond the Jordan in the land of Gilead, and belonged to the half-tribe of Manasseh.

HAURAN (הַרְוֹן; Sept. Ἀυρανίτις), a tract or region of Syria, south of Damascus, which is twice mentioned under this name in Scripture (Ezek. xlvii. 16, 18). It was probably of small extent originally; but received extensive additions from the Romans under the name of Auranitis. At present it reaches from about twenty miles south of Damascus to a little below Bozra, including the rocky district of El-Ledja, the ancient Trachonitis, and the mountainous

region of Jebel-Hauran. Within its limits are also included, besides Trachonitis, Ituræa or Ittur, now called Jedour, and part of Batanæa or Bashan. It is represented by Burckhardt as a volcanic region, composed of porous tufa, pumice, and basalt, with the remains of a crater on the Tel Shoba, which is on its eastern border. It produces, however, crops of corn, and has many patches of luxuriant herbage, which are frequented in summer by the Arab tribes for pasturage. It also abounds with interesting remains of cities, scattered over its surface, among which are found Greek inscriptions.

HAWK (𐤇 netz; Sept. *ἰεπᾶξ*; Vulg. *accipiter*, an unclean bird; Lev. xi. 16; Deut. xiv. 15; Job xxxix. 26). The English name is an altered form of the old word fawk or falk, and in natural history represents several genera of raptorial birds; as does the Arabic *naz*, and, no doubt, also the Hebrew *netz*. Western Asia and Lower Egypt, and consequently the intermediate territory of Syria and Palestine, are the habitation or transitory residence of a considerable number of species of the order *Raptores*, which, even including the shortest-winged, have great powers of flight, are remarkably enterprising, live to a great age, are migratory, or followers upon birds of passage, or remain in a region so abundantly stocked with pigeon and turtle-dove as Palestine, and affording such a variety of ground to hunt their particular prey—abounding as it does in mountain and forest, plain, desert, marsh, river and sea-coast. We shall here enumerate, so far as our information will permit, the *Falconide* of this region, exclusive of those mentioned in other articles [**AZANIAH**; **EAGLE**; **GLEDE**; **KITE**].

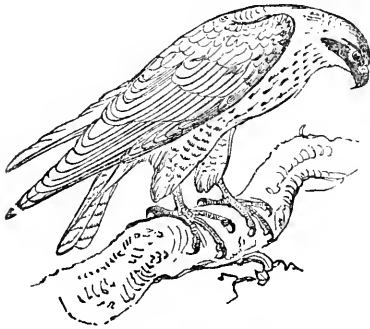

334. [Peregrine Falcon.]

Falcons, or the 'noble' birds of prey used for hawking, have for many ages been objects of great interest, and still continue to be bought at high prices. They are consequently imported from distant countries, as central Asia, Iceland, Barbary, &c. Their love of liberty often renders them irreclaimable when once on the wing; and their powers and boldness, independent of circumstances, and the extent of range which the long-winged species in particular can take, are exemplified by their presence in every quarter of the globe. The *Falco communis*, or Peregrine falcon, is so generally diffused as to occur even in New Holland and South America. As a type of the genus, we may add that it has the two foremost quill-feathers of almost equal length, and that when the wings

are closed they nearly reach the end of the tail. On each side of the crooked point of the bill there is an angle or prominent tooth, and from the nostrils backwards a black streak passes beneath the eye and forms a patch on each side of the throat, giving the bird and its congeners a whiskered and menacing aspect.

Next we may place *Falco Aroeris* of Sir J. G. Wilkinson, the sacred hawk of Egypt. This, if it be not in reality the same as, or a mere variety of, the Peregrine, should have retained the ancient epithet of *Hierax*, and the hawkers' name of *Sacre*, derived from the Arabic *Sagr*, which evidently applies to it. This bird has the same moustachio marks, and from them the old name *Gernonia*, which in base Latinity indicates whiskers, may have been derived. Innumerable representations of it occur in Egyptian monuments, since, in the character of *Iorhat*, or bird of victory, it overshadows kings and heroes, like the *Garuda*, *Sinury*, and the *Humma* bird of Eastern Asia; but it is also an emblem of Re, the Sun, and numerous other divinities; for an account of which we refer to Sir J. G. Wilkinson's *Manners and Customs of the Ancient Egyptians*, 2d Series.

The Hobby, *Falco subbuteo*, is no doubt a second or third species of sacred hawk, having similar gernonia. Both this bird and the tractable Merlin, *Falco aesalon*, are used in the falconry of the inferior Moslem landowners of Asiatic Turkey.

Besides these the Kestrel, *Falco tinnunculus*, occurs in Syria, and *Falco tinnunculoides*, or lesser Kestrel, in Egypt; and it is probable that both species visit these two territories according to the seasons.

To the 'noble' birds we may add the Gerfalcon, *Falco gyrfalco*, which is one-third larger than the Peregrine: it is imported from Tartary and sold at Constantinople, Aleppo, and Damascus. The great birds fly at antelopes, bustards, cranes, &c.; and of the genus *Astur*, with shorter wings than true falcons, the Goshawk, *Falco palumbarius*, and the Falcon Gentil, *Falco gentilis*, are either imported, or taken in their nests, and used to fly at lower and aquatic game. It is among the above that the seven species of hunting hawks enumerated by Dr. Russell must be sought; though from the circumstance that the Arabic names of the birds alone were known to him, it is difficult to assign their scientific denominations; but the following identification is tolerably evident—1. *Al-Huz* or *Baraban* is the Gerfalcon; 2. *Al-Saphy*, the Peregrine; 3. *Al-Shaheen*, the Doctor himself asserts to be the Falcon Gentil; 4. *Al-Zygranuz*, the Goshawk. One of the remaining species is, no doubt, the Merlin; and the last, *Al-Bashak*, is the crested Buzard, *Falco Bacha*, which is most abundant in Africa, and the principal enemy of the Shaphan (*Hyrax*). The smaller and less powerful hawks of the genus *Nisus* are mostly in use on account of the sport they afford, being less fatiguing, as they are employed to fly at pigeons, partridges, quails, Pterocles, Katta, and other species of Ganga. There are various other raptorial birds, not here enumerated, found in Syria, Arabia, and Egypt. We have at this moment before us coloured representations of three such, copied from the painted sculptures of ancient Egypt; and in conformity with the common laws of animated nature, the Nile cannot be without a variety of species feeding on the produce of its waters and

its visitors; but the above enumeration will be found, we trust, sufficient for our present purpose.—C. H. S.

HAY. [CHATZIR.]

HAZAEI (חַזְאֵל, *vision of God*; Sept. Ἀζαήλ), an officer of Benhadad, king of Syria, whose eventual accession to the throne of that kingdom was made known to Elijah (1 Kings xix. 15); and who, when Elisha was at Damascus, was sent by his master, who was then ill, to consult the prophet respecting his recovery. He was followed by forty camels bearing presents from the king. When Hazael appeared before the prophet, he said, 'Thy son Benhadad, king of Syria, hath sent me to thee, saying, Shall I recover of this disease? The answer was, that he *might* certainly recover. 'Howbeit,' added the prophet, 'the Lord hath showed me that he shall surely die.' He then looked stedfastly at Hazael till he became confused: on which the man of God then wept; and when Hazael respectfully inquired the cause of this outburst, Elisha replied by describing the vivid picture then present to his mind of all the evils which the man now before him would inflict upon Israel. Hazael exclaimed, 'But what! Is thy servant a dog that he should do this great thing?' The prophet explained that it was as king of Syria he should do it. Hazael then returned, and delivered to his master that portion of the prophetic response which was intended for him. But the very next day this man, cool and calculating in his cruel ambition, took a thick cloth, and, having dipped it in water, spread it over the face of the king, who, in his feebleness, and probably in his sleep, was smothered by its weight, and died what seemed to his people a natural death (2 Kings viii. 8, &c.) B.C. 855. We are not to imagine that such a project as this was conceived and executed in a day, or that it was suggested by the words of Elisha. His discomposure at the earnest gaze of the prophet, and other circumstances, show that Hazael at that moment regarded Elisha as one to whom his secret purposes were known. In that case, his cry, 'Is thy servant a dog,' &c., was not, as some suppose, a cry of joy at the first view of a throne, but of horror at the idea of the public atrocities which the prophet described. This was likely to shock him more than it would do after he had committed his first crime, and obtained possession of a throne acquired at such a cost.

The further information respecting Hazael which the Scriptures afford is limited to brief notices of his wars with Abaziah and Joash, kings of Judah, and with Jehoram, Jehu, and Jehoiabaz, kings of Israel (2 Kings viii. 28; ix. 14; x. 32; xii. 17; xiii. 3; 2 Chron. xxii. 5). It is difficult to distinguish the several campaigns and victories involved in these allusions, and spread over a reign of forty years; but it is certain that Hazael always had the advantage over the Hebrew princes. He devastated their frontiers, rent from them all their territories beyond the Jordan, traversed the breadth of Palestine, and carried his arms into the states of the Philistines; he laid siege to Jerusalem, and only retired on receiving the treasures of the temple and the palace. The details of these conquests redeemed to the very letter the appalling predictions of Elisha. This

able and successful, but unprincipled usurper left the throne at his death to his son Benhadad.

HAZARMAVETH, the third son of Joktan (Gen. x. 26), whose name is judged to have been preserved in the Arabian province of Hadramaut [ARABIA].

HAZEL. [LUTZ.]

HAZEROTH, the third station of the Israelites after leaving Sinai, and either four or five days' march from that mountain (Num. xi. 35; xxxiii. 17; comp. x. 33) [WANDERING].

HAZEON-TAMAR. [EN-GEDI.]

HAZOR (חֲזָרָה; Sept. Ἀζόρα), a city near the waters of lake Merom (Huleh), the seat of Jabin, a powerful Canaanitish king, as appears from the summons sent by him to all the neighbouring kings to assist him against the Israelites. He and his confederates were, however, defeated and slain by Joshua, and the city burnt to the ground (Josh. xi. 1, 10-13; Joseph. *Antiq.* v. 5. 1). But by the time of Deborah and Barak the Canaanites had recovered part of the territory then lost, had rebuilt Hazor, and were ruled by a king with the ancient royal name of Jabin, under whose power the Israelites were, in punishment for their sins, reduced. From this yoke they were delivered by Deborah and Barak, after which Hazor remained in quiet possession of the Israelites, and belonged to the tribe of Naphtali (Josh. xix. 36; Judg. iv. 2). Hazor was one of the towns rebuilt or much improved by Solomon (1 Kings ix. 15), and was one of the fortified places of Galilee which the Assyrians under Tiglath-pileser first took on invading Palestine from the north (2 Kings xv. 29). There is no modern notice of this town. Raumer, indeed, queries whether it may not have been the ancient town of Naason, which King Baldwin IV. passed on his way from Tiberias to Saphet (Will. Tyr. p. 1014); and his reason for this conjecture is that the Vulgate gives Naason for the Asor (Ἀζόρα) of Tobit i. 1 (Raumer, *Palästina*, p. 126).

HEAD. ὄψις; Greek, κεφαλή; Latin, *caput*; Gothic, *hauþith*; Anglo-Saxon, *heafod*; German, *kopf*. The root is *kep* or *cap*, denoting that which holds: thus the head etymologically signifies *the container*, the name designating the function. But as the head is the topmost part of the human body, it came derivatively to signify that which is highest, chief (*chef* in French, from the same *kep* or *cap*), the highest in position locally being regarded as highest in office, rank, or dignity: whence, as the head is the centre of the nervous system, holds the brain, and stands above all the other parts, Plato regarded it as the seat of the deathless soul; and it has generally been considered as the abode of the intellect or intelligence by which man is enlightened and his walk in life directed; while the heart, or the parts placed near it, have been accounted the place where the affections lie (Gen. iii. 15; Ps. iii. 3; Eccles. ii. 14). The head and the heart are sometimes taken for the entire person (Is. i. 5). Even the head alone, as being the chief member, frequently stands for the man (Prov. x. 6). The head also denotes sovereignty (1 Cor. xi. 3). Covering the head, and cutting off the hair, were signs of mourning and tokens of distress, which were enhanced by throwing ashes on the head, together with sackcloth (Amos viii. 10; Job i. 20; Lev. xxi. 5; Dent

iv. 1; 2 Sam. xiii. 10; Esther iv. 1); while anointing the head was practised on festive occasions, and considered an emblem of felicity (Eccles. ix. 8; Ps. xxiii. 5; Luke vii. 46). It was usual to swear by the head (Matt. v. 36).

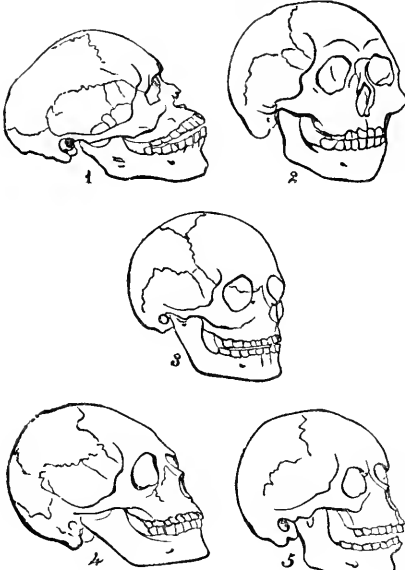

335. 1. Ethiopian; 2. Mongolian; 3. Caucasian; 4. Malay; 5. American.

The general character of the human head is such as to establish the identity of the human race, and to distinguish man from every other animal. At the same time different families of mankind are marked by peculiarities of construction in the head, which, though in individual cases, and when extremes are compared together, they run one into the other to the entire loss of distinctive lines, yet are in the general broadly contrasted one with the other. These peculiarities in the structure of the skull give rise to and are connected with other peculiarities of feature and general contour of face. In the union of cranial peculiarities with those of the face certain clear marks are presented, by which physiologists have been able to range the individuals of our race into a few great classes, and in so doing to afford an unintentional corroboration of the information which the Scriptures afford regarding the origin and dispersion of mankind. Camper, one of the most learned and clear-minded physicians of the eighteenth century, has the credit of being the first who drew attention to the classification of the human features, and endeavoured, by means of what he termed the facial angle, to furnish a method for distinguishing different nations and races of men, which, being himself an eminent limner, he designed for application chiefly in the art of drawing, and which, though far from producing strictly definite and scientific results, yet affords views that are not without interest, and approximations that at least prepaire the way for something better (see a collection of Camper's pieces entitled *Œuvres qui ont pour Objet l'His-*

toire Naturelle, la Physiologie, et l'Anatomie comparée, Paris, 1803). It is, however, to the celebrated J. F. Blumenbach, whose merits in the entire sphere of natural history are so transcendent, that we are mainly indebted for the accurate and satisfactory classifications in regard to cranial structure which now prevail. Camper had observed that the breadth of the head differs in different nations; that the heads of Asiatics (the Kalmucs) have the greatest breadth; that those of Europeans have a middle degree of breadth; and that the skulls of the African negroes are the narrowest of all. This circumstance was by Blumenbach made the foundation of his arrangement and description of skulls. By comparing different forms of the human cranium together, that eminent physiologist was led to recognise three great types to which all others could be referred—the Caucasian, Mongolian and Ethiopic. These three differ more widely from each other than any other that can be found; but to these three Blumenbach, in his classification of skulls, and of the races of men to which they belong, added two others, in many respects intermediate between the three forms already mentioned. In this way five classes are established, corresponding with five great families. 1. The Caucasian family, comprising the nations of Europe, some of the Western Asiatics, &c., have the head of the most symmetrical shape, almost round, the forehead of moderate extent, the cheek bones rather narrow, without any projection, but a direction downwards from the molar process of the frontal bone; the alveolar edge well rounded; the front teeth of each jaw placed perpendicularly; the face of oval shape, straight, features moderately prominent; forehead arched; nose narrow, slightly arched; mouth small; chin full and round. 2. The second is the Mongolian variety. 3. Ethiopian. 4. Malay and South Sea Islanders. 5. American. The description of their peculiarities may be found in Prichard's *Researches into the Physical History of Man*, 2nd edit. vol. i. p. 167, sq. The reader may also consult Lawrence's *Lectures on the Natural History of Man*; J. Muller's *Handbuch der Physiologie*. But the most recent, if not the best, work on the subject before us is Prichard's *Natural History of Man*, 1843; a work which comprises and reviews, in the spirit of a sound philosophy, all that has hitherto been written and discovered on the origin, physical structure, and propagation over the earth of the race of man. In this invaluable work full details may be found of the methods of studying the human head of which we have spoken, and of some others, not less interesting in themselves, nor less valuable in their results (see particularly p. 116, sq.).—J. R. B.

HEART. All the phrases, more or less metaphorical, in which this word occurs, are rendered intelligible, without detailed examples, when we are told that the heart was, among the Hebrews, regarded poetically not only as the seat of the passions and emotions, as of love, pleasure, and grief, but also of the intellectual faculties—the mind, the understanding. In the original Scriptures, as well as in the English and other translations, the word 'heart,' therefore, constantly occurs where 'mind' is to be understood, and would be used by a modern English writer. We say modern, because the ancient usage of the English word

'heart' was more conformable than the present to that of the Hebrews.

HEATH. [OROR.]

HEAVEN, the state and place of blessedness in the life to come.

Of the nature of this blessedness it is not possible that we should form any adequate conception, and, consequently, that any precise information respecting it should be given to us. Man, indeed, usually conceives the joys of heaven to be the same as, or, at least, to resemble the pleasures of this world; and each one hopes to obtain with certainty and to enjoy in full measure, beyond the grave, that which he holds most dear upon earth—those favourite employments or particular delights which he ardently longs for here, but which he can seldom or never enjoy in this world, or in the enjoyment of which he is never fully satisfied. But one who reflects soberly on the subject, will readily see that the happiness of heaven must be a very different thing from earthly happiness. In this world the highest pleasures of which our nature is capable satiate by their continuance, and soon lose the power of giving positive enjoyment. This alone is sufficient to show that the bliss of the future world must be of an entirely different kind from what is called earthly joy and happiness, if we are to be there *truly* happy, and happy *for ever*. But since we can have no distinct conception of those joys which never have been and never will be experienced by us here in their full extent, we have of course no words in human language to express them, and cannot therefore expect any clear description of them even in the Holy Scriptures. Hence the Bible describes this happiness sometimes in general terms, designating its greatness (as in Rom. viii. 18-22; 2 Cor. iv. 17, 18); and sometimes by various figurative images and modes of speech, borrowed from everything which we know to be attractive and desirable.

The greater part of these images were already common among the Jewish contemporaries of Christ; but Christ and his apostles employed them in a purer sense than the great multitude of the Jews. The Orientals are rich in such figures. They were employed by Mohammed, who carried them, as his manner was, to an extravagant excess, but who at the same time said expressly that they were mere figures, although many of his followers afterwards understood them literally, as has been often done in a similar way by many Christians.

The following are the principal terms, both literal and figurative, which are applied in Scripture to the condition of future happiness.

Among the *literal* appellations we find ζωή, ζωή αἰώνιος, which, according to Hebrew usage, signify 'a happy life,' or 'eternal well-being,' and are the words rendered 'life,' 'eternal life,' and 'life everlasting,' in the Auth. Version (*e. g.* Matt. vii. 14; xix. 16, 29; xxv. 46): δόξα, δόξα τοῦ Θεοῦ, 'glory,' 'the glory of God' (Rom. ii. 7, 10; v. 2); and εἰρήνη, 'peace' (Rom. ii. 10). Also αἰώνιον βάρος δόξης, 'an eternal weight of glory' (2 Cor. iv. 17); and σωτηρία, σωτηρία αἰώνιος, 'salvation,' 'eternal salvation' (Heb. v. 9), &c.

Among the *figurative* representations, we may place the word 'heaven' itself. The abode of departed spirits, to us who live upon the earth, and

while we remain here, is invisible and inaccessible, beyond the bounds of the visible world, and entirely separated from it. There they live in the highest well-being, and in a nearer connection with God and Christ than here below. This place and state cannot be designated by any more fit and brief expression than that which is found in almost every language, namely, 'heaven,'—a word in its primary and material signification denoting the region of the skies, or the visible heavens. This word, in Hebrew שָׁמַיִם *shamayim*, in Greek οὐρανός, is therefore frequently employed by the sacred writers. It is there that the highest sanctuary or temple of God is situated, *i. e.* it is there that the omnipresent God most gloriously reveals himself. This, too, is the abode of God's highest spiritual creation. Thither Christ was transported: he calls it the house of his Father, and says that he has therein prepared an abode for his followers (John xiv. 2).

This place, this 'heaven,' was never conceived of in ancient times, as it has been by some modern writers, as a particular planet or world, but as the wide expanse of heaven, high above the atmosphere, or stary heavens; hence it is sometimes called the *third* heaven, as being neither the atmosphere nor the stary heavens.

Another figurative name is 'Paradise,' taken from the abode of our first parents in their state of innocence, and transferred to the abode of the blessed (Luke xxiii. 43; 2 Cor. xii. 4; Rev. ii. 7; xxii. 2).

Again, this place is called 'the heavenly Jerusalem' (Gal. iv. 26; Heb. xii. 22; Rev. iii. 12), because the earthly Jerusalem was the capital city of the Jews, the royal residence, and the seat of divine worship; the 'kingdom of heaven' (Matt. xxv. 1; Jas. ii. 5); the 'heavenly kingdom' (2 Tim. iv. 18); the 'eternal kingdom' (2 Pet. i. 11). It is also called an 'eternal inheritance' (1 Pet. i. 4; Heb. ix. 15), meaning the possession and full enjoyment of happiness, typified by the residence of the ancient Hebrews in Palestine. The blessed are said 'to sit down at table with Abraham, Isaac, and Jacob,' that is, to be a sharer with the saints of old in the joys of salvation; 'to be in Abraham's bosom' (Luke xvi. 22; Matt. viii. 11), that is, to sit near or next to Abraham [Bosom]; 'to reign with Christ' (2 Tim. ii. 11), *i. e.* to be distinguished, honoured, and happy as he is—to enjoy regal felicities; to enjoy 'a Sabbath,' or 'rest' (Heb. iv. 10, 11), indicating the happiness of pious Christians, *both* in this life and in the life to come.

All that we can with certainty know or infer from Scripture or reason respecting the blessedness of the life to come, may be arranged under the following particulars:—1. We shall hereafter be entirely freed from the sufferings and adversities of this life. 2. Our future blessedness will involve a continuance of the real happiness of this life.

1. The entire exemption from suffering and all that causes suffering here, is expressed in the Scripture by words which denote rest, repose, refreshment, after performing labour and enduring affliction. But all the terms which are employed to express this condition, define (in the original) the promised 'rest,' as rest after labour, and exemption from toil and grief; and not the absence of employment, not inactivity or indolence

(2 Thess. i. 7; Heb. iv. 9, 11; Rev. xiv. 13; comp. vii. 17).

This deliverance from the evils of our present life includes—

1. Deliverance from this earthly body, the seat of the lower principles of our nature and of our sinful corruption, and the source of so many evils and sufferings (2 Cor. vi. 1, 2; 1 Cor. xviii. 15).

2. Entire separation from the society of wicked and evil-disposed persons, who, in various ways, injure the righteous man and embitter his life on earth (2 Tim. iv. 18). It is hence accounted a part of the felicity even of Christ himself in heaven to be 'separate from sinners' (Heb. vii. 26).

3. Upon this earth everything is inconstant, and subject to perpetual change; and nothing is capable of completely satisfying our expectations and desires. But in the world to come it will be different. The bliss of the saints will continue without interruption or change, without fear of termination, and without satiety (Luke xx. 36; 2 Cor. iv. 16, 18; 1 Pet. i. 4; v. 10; 1 John iii. 2, sq.).

II. Besides being exempt from all earthly trials, and having a continuance of that happiness which we had begun to enjoy even here, we have good reason to expect hereafter other rewards and joys, which stand in no natural or necessary connection with the present life. For our entire felicity would be extremely defective and scanty, were it to be confined merely to that which we carry with us from the present world, to that peace and joy of soul which result from reflecting on what we may have done which is good and pleasing in the sight of God; since even the best man will always discover great imperfections in all that he has done. Our felicity would also be incomplete were we compelled to stop short with that meagre and elementary knowledge which we take with us from this world,—that knowledge so broken up into fragments, and yielding so little fruit, and which, poor as it is, many good men, from lack of opportunity, and without any fault on their part, never here acquire. Besides the natural rewards of goodness, there must, therefore, be others, which are *positive*, and dependent on the will of the Supreme Legislator.

On this point almost all philosophers are, for the above reasons, agreed—even those who will admit of no *positive punishments* in the world to come. But for want of accurate knowledge of the state of things in the future world, we can say nothing definite and certain as to the nature of the positive rewards. In the doctrine of the New Testament, however, positive rewards are considered most obviously as belonging to our future felicity, and as constituting a principal part of it. For it always represents the joys of heaven as resulting strictly from *the favour of God*, and as being *undeserved* by those on whom they are bestowed. Hence there must be something more added to the natural good consequences of our actions, something which cannot be considered as the necessary and natural consequences of the good actions we may have here performed. But, on this subject, we know nothing more in general than this, that God will so appoint and order our circumstances, and make such arrangements, that the principal faculties

of our souls—reason and affection, will be heightened and developed, so that we shall continually obtain more pure and distinct knowledge of the truth, and make continual advances in holiness.

The following remarks may be of some use in illustrating this subject:—

(1). In this life God has very wisely allotted various capacities, powers, and talents, in different ways and degrees, to different men, according to the various ends for which he designs them, and the business on which he employs them. Now there is not the least reason to suppose that God will abolish this variety in the future world; it will rather continue there in all its extent. We must suppose, then, that there will be, even in the heavenly world, a diversity of tastes, of labours, and of employments, and that to one person this, to another that field, in the boundless kingdom of truth and of useful occupation, will be assigned for his cultivation, according to his peculiar powers, qualifications, and tastes. A presentment of this truth is contained in the idea, which was widely diffused throughout the ancient world, viz., that the manes will continue to prosecute, in the future life, the employments to which they had been here accustomed. At least such arrangements will doubtless be made by God in the future life, that each individual will there develop more and more the germs implanted within him by the hand of the Creator; and will be able, more fully than he ever could do here, to satisfy the wants of his intellectual nature, and thus to make continual progress in the knowledge of everything worthy of being known, of which he could only learn the simplest elements in this world; and he will be able to do this in such a way that the increase of knowledge will not be detrimental to piety, as it often proves on earth, but rather promotive of it. To the sincere and ardent searcher after truth it is a rejoicing and consoling thought that he will be able hereafter to perfect that knowledge which here has so many deficiencies (1 Cor. xiii. 9).

But there is danger of going too far on this point, and of falling into strange misconceptions. Various as the tastes and wants of men in the future world will doubtless be, they will still be in many respects different from what they are here; because the whole sphere of action, and the objects by which we shall there be surrounded, will be different. We shall there have a changed and more perfect body, and by this single circumstance shall be freed at once from many of the wants and inclinations which have their seat in the earthly body. And this will also contribute much to rectify, enlarge, and perfect our knowledge. Many things which seem to us very important and essential during this our state of infancy upon earth, will hereafter doubtless appear in a different light: we shall look upon them as trifles and children's play, and employ ourselves in more important occupations, the utility and interest of which we may have never before imagined.

Some theologians have supposed that the saints in heaven may be taught by *immediate divine revelations* (lumen gloriæ); especially those who may enter the abodes of the blessed without knowledge, or with only a small measure of it; e. g. children and others who have died in ignorance, for which they themselves were not to blame.

On this subject nothing is definitely taught in the Scriptures; but both Scripture and reason warrant us in believing that provision will be made for all such persons in the world to come. A principal part of our future happiness will consist, according to the Christian doctrine, in the enlarging and correcting of our knowledge respecting God, his nature, attributes, and works, and in the salutary application of this knowledge to our own moral benefit, to the increase of our faith, love, and obedience. There has been some controversy among theologians with regard to the *vision of God* (*visio Dei intuitiva, sensitiva, beatifica, comprehensiva*). The question is, whether the saints will hereafter behold God with the eyes of the mind, *i. e.* merely know him with the understanding.

But in the Scriptures God is always represented as a being invisible by the bodily eye (*ἀόρατος*), as, indeed, every spirit is. The texts of Scripture which speak of *seeing God* have been misunderstood: they signify, sometimes, *the more distinct knowledge of God*, as we speak of knowing by seeing, of seeing with the eyes of the mind (John i. 18; 1 John iii. 2; iv. 12; comp. v. 20; 1 Tim. vi. 16); and Paul uses *θεάσασθαι* and *γνωσκειν* as synonymous (1 Cor. xiii. 12, 13; comp. v. 10). Again, they express the idea of *felicity*, the enjoyment of God's favour, the being thought worthy of his friendship, &c. Still more frequently are both of these meanings comprehended under the phrase *to see God*. The image is taken from Oriental princes, to see whose face, and to be in whose presence, was esteemed a great favour (Matt. v. 8; Heb. vii. 14). 'Without holiness, οὐδεὶς ὄψεται τὸν Κύριον.' The opposite of this is to be removed from God and from his face.

But Christ is always represented as one who will be *personally visible* to us, and whose personal, familiar intercourse and guidance we shall enjoy. Herein Christ himself places a chief part of the joy of the saints (John xiv. xvii., &c.); and the apostles often describe the blessedness of the pious by the phrase *being with Christ*. To his guidance has God entrusted the human race, in heaven and on earth. And Paul says (2 Cor. iv. 6), we see 'the brightness of the divine glory in the face of Christ,' he is 'the visible representative of the invisible God' (Col. i. 15). According to the representation contained in the Holy Scriptures, the saints will dwell together in the future world, and form, as it were, a kingdom or state of God (Luke xvi.; xx. 38; Rom. viii. 10; Rev. vii. 9; Heb. xii. 22). They will there partake of a common felicity. Their enjoyment will doubtless be very much heightened by friendship, and by their confiding intercourse with each other. We must, however, separate all earthly imperfections from our conceptions of this heavenly society. But that we shall there recognise our former friends, and shall be again associated with them, was uniformly believed by all antiquity. And when we call to mind the affectionate manner in which Christ soothed his disciples by the assurance that they should hereafter see him again, should be with him, and enjoy personal intercourse and friendship with him, in that place to which he was going (John xiv. 3; comp. 1 Pet. i. 8), we may gather just grounds for this belief. Paul indeed says expressly that

we shall be with Christ, in company with our friends who died before us (*ἀμα σὺν αὐτοῖς*, 1 Thess. iv. 17); and this presupposes that we shall recognise them, and have intercourse with them, as with Christ himself.

1. HEBER (עֶבֶר, *one of the other side*; Sept. Ἐβερ and Ἐβερ), son of Salah, who became the father of Peleg at the age of 34 years, and died at the age of 464 (Gen. x. 24; xi. 14; 1 Chron. i. 25). His name occurs in the genealogy of Christ (Luke iii. 35). There is nothing to constitute Heber a historical personage; but there is a degree of interest connected with him from the notion, which the Jews themselves entertain, that the name of Hebrews, applied to them, was derived from this alleged ancestor of Abraham. No historical ground appears why this name should be derived from him rather than from any other personage that occurs in the catalogue of Shem's descendants; but there are so much stronger objections to every other hypothesis, that this perhaps is still the most probable of any which have yet been started.

2. HEBER (הֶבֶר; Sept. Χαβερ), a descendant of Hobab, son of Jethro, and brother of the wife of Moses. His wife was the Jael who slew Sisera, and he is called Heber the Kenite (Judg. iv. 11, 17; v. 24), which seems to have been a name for the whole family (Judg. i. 16). Heber appears to have lived separate from the rest of the Kenites, leading a patriarchal life, amid his tents and flocks. He must have been a person of some consequence, from its being stated that there was peace between the house of Heber and the powerful king Jabin. At the time the history brings him under our notice his camp was in the plain of Zaanaim, near Kedesh in Naphtali [JAEI; KENITES].

HEBREW LANGUAGE. The Hebrew language is that which was the national idiom of those descendants of 'Eber which received the distinctive name of the People of Israel, and, as such, was that in which all the books of the Old Testament (with the exception of the few Chaldee passages occurring in those after the Babylonian captivity) were originally composed. It belongs to the Semitic, or, as it is more appropriately called, the Syro-Arabian family of languages; and it occupies a central point amidst all the branches of this family, as well with reference to the geographical position of the country in which it prevailed, as with reference to the degree of development to which it attained. In point of antiquity, however, it is the oldest form of human speech known to us, and, from the early civilization, as well as from the religious advantages of the Hebrews, has preserved to us the oldest and purest form of the Syro-Arabian language.*

If we except the terms 'lip of Canaan' (שפת כנען) in Isa. xix. 18—where the diction is of an elevated character, and is so far no evidence that this designation was the one commonly employed—the only name by which the Hebrew language is mentioned in the Old Testament is 'Jewish' (יהודית), used adverbially, *Judaicè*, in Jewish, 2 Kings xviii. 26, 28; Isa. xxxvi. 11, 13;

* It may suffice here to refer generally to Ewald's *Hebrew Grammar*, §§ 1-18, 135-160, where the whole subject of this article is treated of.

2 Chron. xxxii. 18*), where the feminine may be explained as an abstract of the last formation, according to Kwald's *Hebr. Gram.* §§ 314, 457, or as referring to the usual gender of יְהוּדִי understood. In a strict sense, however, 'Jewish' denotes the idiom of the kingdom of Judah, which became the predominant one after the deportation of the ten tribes. It is in the Greek writings of the later Jews that 'Hebrew' is first applied to the language, as in the $\epsilon\beta\rho\alpha\iota\sigma\tau\acute{\iota}$ of the prologue to Ecclesiasticus, and in the $\gamma\lambda\omega\sigma\sigma\alpha\ \tau\acute{\omega}\nu\ \epsilon\beta\rho\alpha\iota\omega\nu$ of Josephus. (The $\epsilon\beta\rho\alpha\iota\sigma\ \delta\iota\alpha\lambda\epsilon\kappa\tau\omicron\varsigma$ of the New Testament is used in contradistinction to the idiom of the Hellenist Jews, and does not mean the ancient Hebrew language, but the then vernacular Aramaic dialect of Palestine.) Our title to use the designation *Hebrew* language is, therefore, founded on the fact that the nation which spoke this idiom was properly distinguished by the ethnographical name of *Hebrews*.

The appellation *Hebrews* may, indeed, originally have embraced more tribes than the Israelites, as it appears from Genesis (x. 21, 25) that the descendants of Iotjan had some claim to it. Nevertheless, it was soon appropriated to the Israelites as their distinctive name as a nation in the earlier periods of their history, and (after giving place, in the intervening centuries, to that of *Israel*, and, subsequently to the deportation of the ten tribes, to that of *Jews*) was at length revived not long before the Christian era—when, however, it also served to distinguish the Jews of Palestine from the Hellenist Jews—and passed over, together with that of *Jews*, to the classical writers. As for the origin of the name, there are two theories (besides that which makes it a patronymic from 'Eber), one of which, by deriving 'ibri from the verb עבר , to pass over, assumes the name to have been assigned to Abraham by the Canaanites, in consequence of his having crossed the Euphrates, so that the word means *transitor*; while the other assumes that, as Mesopotamia is called the country *beyond the river* (עבר הנהר , *עבר*, Jos. xxiv. 2), 'ibri is derived from the preposition עבר in that combination, so that the word should mean *transfluvialis*, one of the people who dwell on the other side of the river. If the fact that the Sept. translators have rendered 'the Hebrew,' in Gen. xiv. 13, by $\delta\ \text{περάτης}$, and Aquila by $\delta\ \text{περατήρης}$ (from περαίν , 'the country over the water'; cf. Joseph. *De Bell. Jud.* ii. 20. 4) may not prove that both these opinions existed at the date of those versions, yet they establish the existence of one of them. However distinct these views may be, they have frequently been confounded; but many early Christian writers, such as Origen and Jerome, favoured the former theory, viz. that 'ibri is derived from the verb. The latter appears to have been virtually held by Diodorus Tarsensis, whose words are: $\text{περάτης καλεῖ τὸν Ἀβρὰμ ὄσανε πέραν οἰκούντα τοῦ Ἰορδάνου}$ (see the note of Flam. Nobilius *ad loc.* in Walton's *Bibl. Polyglot.* tom. vi.); and expressly by Chry-

sostom, who, in his 35th homily on Genesis, says: $\text{ἐπειδὴ γὰρ πέραν τοῦ Εὐφράτου τὴν κατοικίαν εἶχε, διὰ τοῦτο καὶ περάτης ἐλέγετο}$. This view is the one which has found most favour in recent times. S. Morinus, who rejects both these views, encounters the former with very pertinent arguments; especially when he insists that, even if there were evidence that the name *Hebrew* was imposed on Abraham by the Canaanites, it could not, in the first signification, have been a distinctive name, at a period when so many tribes must have recently passed westwards over the Euphrates (*De Ling. Primæva*, p. 64). Hezel also has stated some of the best objections to each theory, in his *Geschichte der Heb. Sprache*, § 4; and Ewald in his latest work, *Geschichte des Volkes Israel*, i. 334, has briefly, though emphatically, declared both to be untenable.

The best evidences which we possess as to the form of the Hebrew language, prior to its first historical period, tend to show that Abraham, on his entrance into Canaan, found the language then prevailing among almost all the different tribes inhabiting that country to be in at least dialectual affinity with his own. This is gathered from the following facts: that nearly all the names of places and persons relating to those tribes admit of Hebrew etymologies; that, amidst all the accounts of the intercourse of the Hebrews with the nations of Canaan, we find no hint of a diversity of idiom; and that even the comparatively recent remains of the Phœnician and Punic languages bear a manifest affinity to the Hebrew. But whether the Hebrew language, as seen in the earliest books of the Old Testament, is the very dialect which Abraham brought with him into Canaan; or whether it is the common tongue of the Canaanite nations, which Abraham only adopted from them, and which was afterwards developed to greater fulness under the peculiar moral and political influences to which his posterity were exposed, are questions which, in the absence of conclusive arguments, are generally discussed with some dogmatical prepossessions. Almost all those who support the first view contend also that Hebrew was the primitive language of mankind. S. Morinus, in the work above cited, and Löscher, in his *De Causis Ling. Hebr.*, are among the best champions of this opinion; but Hävernick has recently advocated it with such modifications as make it more acceptable (*Einleit. in das Alte Test.*, I. i. p. 148, sq.). The principal argument on which they depend is that, as the most important proper-names in the first part of Genesis (as Cain, Seth, and others) are evidently founded on Hebrew etymologies, the essential connection of these names with their etymological origins involves the historical credibility of the records themselves, and leaves no room for any other conclusion than that the Hebrew language is coeval with the earliest history of man. The advocates of the other opinion attach some weight to the cogency with which they infer, from the phenomena of the Hebrew language itself, that its roots were at one period bilateral, and were afterwards developed to the compass of three consonants. They also rest on the evidence which Gen. xxxi. 47 affords that the near relatives of Abraham, residing too in the country from which he had recently emigrated, spoke *Aramaic*; and they think this warrants

* The passage in Neh. xiii. 24 is not included here, because, as will be seen below, it is a disputed point at what time the Hebrew language ceased to be a living tongue; and it depends on the decision of that question whether the 'Jewish' of Nehemiah means *Hebrew* or *Aramaic*.

the conclusion that Aramaic must have been the vernacular dialect of Abraham himself. Lastly, Gesenius lays some stress on the circumstance that the language not only denotes *west* by מִן , *sea*, but that it does not possess any other word to express that sense.

The history of the Hebrew language, as far as we can trace its course by the changes in the diction of the documents in which it is preserved, may be here conveniently divided into that of the period preceding, and that of the period succeeding, the Exile. If it be a matter of surprise that the thousand years which intervened between Moses and the Captivity should not have produced sufficient change in the language to warrant its history during that time being distributed into subordinate divisions, the following considerations may excuse this arrangement. It is one of the signal characteristics of the Hebrew language, as seen in all the books prior to the Exile, that notwithstanding the existence of some isolated, but important, archaisms, such as in the form of the pronoun, &c. (the best collection of which may be seen in Hävernick, *l. c.* p. 183, sq.) it preserves an unparalleled general uniformity of structure. The extent to which this uniformity prevails may be estimated, either by the fact that it has furnished many modern scholars, who reason from the analogies discovered in the changes in other languages in a given period, with an argument to show that the Pentateuch could not have been written at so remote a date as is generally believed (Gesenius, *Gesch. der Hebr. Sprache*, § 8); or, by the conclusion, *à fortiori*, which Hävernick, whose express object it is to vindicate its received antiquity, candidly concedes that 'the books of Chronicles, Ezra and Nehemiah are the *earliest* in which the language differs sensibly from that in the historical portions of the Pentateuch' (*Einleit.* i. p. 180). We are here solely concerned with the fact that this uniformity of type exists. The general causes to which it is to be ascribed are to be sought in the genius of the language itself, as less susceptible of change; in the stationary civilization of the Hebrews during the period; and in their comparative isolation, as regarded nations of foreign language (see Ewald's *Hebr. Gram.* § 7). The particular causes depend on the age and author assigned to each book falling within this period, and involve questions utterly alien to the scope of this article.

In the canonical books belonging to the first period, the Hebrew language appears in a state of mature development. Although it still preserves the charms of freshness and simplicity, yet it has attained great regularity of formation, and such a precision of syntactical arrangement as ensures both energy and distinctness. Some common notions of its laxity and indefiniteness have no other foundation than the very inadequate scholarship of the persons who form them. A clearer insight into the organism of language absolutely, joined to such a study of the cognate Syro-Arabian idioms as would reveal the secret, but no less certain, laws of its syntactical coherence, would show them to what degree the simplicity of Hebrew is compatible with grammatical precision.

One of the most remarkable features in the language of this period is the difference which distinguishes the diction of poetry from that of prose. This difference consists in the use of un-

usual words and flexions (many of which are considered to be Aramaisms or Archaisms, although in this case these terms are nearly identical), and in a harmonic arrangement of thoughts, as seen both in the parallelism of members in a single verse, and in the strophic order of longer portions; the delicate art of which Ewald has traced with pre-eminent success in his *Poetische Bücher des Alt. Bundes*, vol. i.

The Babylonian captivity is assigned as the commencement of that decline and corruption which mark the second period in the history of the Hebrew language; but the Assyrian deportation of the ten tribes, in the year B.C. 720, was probably the first means of bringing the Aramaic idiom into injurious proximity to it. The Exile, however, forms the epoch at which the language shows evident signs of that encroachment of the Aramaic on its integrity, which afterwards ended in its complete extinction. The diction of the different books of this period discovers various grades of this Aramaic influence; and in some cases approaches so nearly to the type of the first period, that it has been ascribed to mere imitation.

An interesting question has been raised as to the precise time at which the Hebrew ceased to be the living vernacular language of the Jews. Some learned men, among whom are Kimchi, Buxtorf, and Walton, maintain that the Jews entirely lost the living use of Hebrew during the Captivity. Others, as Pfeiffer and Löscher, argue that it is quite unreasonable, considering the duration and other circumstances of the Exile, to suppose that the Jews did not retain the partial use of their native tongue for some time after their return to Palestine, and lose it by slow degrees at last. The points on which the question chiefly turns, are the sense in which the words כְּפֻרְשֵׁי and יְהוּדִית in Neh. viii. 8; xiii. 24, are to be taken; and Hengstenberg, in his *Authentic des Daniel*, p. 299, sq., and Gesenius, in his *Gesch. d. Hebr. Sprache*, § 13, are the best modern advocates of either view. But, on whichever side the truth may be here, it is certain that the language continued to be understood and used in writing by the educated, for some time after the Exile, as is evident from the date of the latest Biblical books; and it is found in the inscriptions on the coins of the Maccabees. No decisive evidence, however, shows at what exact time it became a virtually dead language; although there is every reason to conclude that, more than a century before the Christian era, it gave place altogether in writing, as before in speech, to that corrupt Aramaic dialect, which some have called the Syro-Chaldaic, and that it was thenceforth solely studied, as the language of the sacred books, by the learned.

The palæographical history of the Hebrew language requires a brief notice, at least as far as regards the results of modern inquiries. The earliest monuments of Hebrew writing which we possess are the *genuine* coins of the Maccabees, which date from the year B.C. 143. The character in which their inscriptions are expressed bears a very near resemblance to the Samaritan alphabet, and both are evidently derived from the Phœnician alphabet. The Talmud also, and Origen and Jerome, both attest the fact that an ancient Hebrew character had fallen into disuse; and, by stating that the Samaritans employed it, and by giving some descriptions of its form, they distinctly

prove that the ancient character spoken of was essentially the same as that on the Hasmonæan coins. It is, therefore, considered to be established beyond a doubt that, before the exile, the Hebrews used this ancient character (the Talmud even calls it the 'Hebrew'). At what period, however, the square Hebrew character of our printed books was first adopted, is a matter of some dispute. The Talmud, and Origen and Jerome ascribe the change to Ezra; and those who, like Gesenius, admit this tradition to be true in a limited sense, reconcile it with the late use of the ancient letters on the coins, by appealing to the parallel use of the Kufic character on the Mahomedan coins, for several centuries after the Nischi was employed for writing; or, by supposing that the Maccabees had a mercantile interest in imitating the coinage of the Phœnicians. The other opinion is that, as the square Hebrew character has not, to all appearance, been developed directly out of the ancient stiff Phœnician type, but out of an alphabet bearing near affinity to that found in the Palmyrene inscriptions, a combination of this paleographical fact with the intercourse which took place between the Jews and the Syrians under the Seleucidæ, renders it probable that the square character was first adopted at some inconsiderable but undefinable time before the Christian era. Either of these theories is compatible with the supposition that the square character underwent many successive modifications in the next centuries, before it attained its full calligraphical perfection. The passage in Matt. v. 18 is considered to prove that the copies of the law were already written in the square character, as the *jod* of the ancient alphabet is as large a letter as the *aleph*; and the Talmud and Jerome speak as if the Hebrew MSS. of the Old Testament were, in their time, already provided with the final letters, the *Taggin*, the point on the broken horizontal stroke of \aleph , and other calligraphical minutiae.*

The origin of the vowel-points is to be ascribed to the effort which the Jewish learned men made to preserve the pronunciation of their sacred language, at a time when its extinction as a living tongue endangered the loss of the traditional memory of its sound. Every kind of evidence renders it probable that these signs for the pronunciation were first introduced about the seventh century of the Christian era, that is, after the completion of the Talmud, and that the minute and complex system which we possess was gradually developed, from a few indispensable signs, to its present elaborateness. The existence of the

* Some have attempted to find, in the discrepancies between the Septuagint and the Hebrew text, the basis for discovering in what character the MSS. from which they translated must have been written, by trying to reduce these discrepancies to mistakes of one letter for another. Eichhorn favours the notion that the Septuagint was made from MSS. in the Samaritan character; while Gesenius decides that the letters which are interchanged are only alike in the square character. The decision of this question would in some degree affect the view entertained of the antiquity of the square character. The latest author on this subject, however, Frankel, asserts that the evidence does not preponderate on either side (*Vorstudien zu der Septuaginta*, 1841, p. 213).

present complete system can, however, be traced back to the eleventh century. The skilful investigation of Hupfeld (in the *Studien und Kritiken* for 1830) has proved that the vowel-points were unknown to Jerome and the Talmud; but, as far as regards the former, we are able to make a high estimate of the degree to which the traditional pronunciation, prior to the use of the points, accorded with our Masoretic signs: for Jerome describes a pronunciation which agrees wonderfully well with our vocalisation. We are thus called on to avail ourselves thankfully of the Masoretic punctuation, on the double ground that it represents the Jewish traditional pronunciation, and that the Hebrew language, unless when read according to its laws, does not enter into its full dialectual harmony with its Syro-Arabian sisters.

Although it may be superfluous to enforce the general advantages, not to say indispensable necessity, of a sound scholarlike study of the Hebrew language to the theological student, yet it may be allowable to enumerate some of those particular reasons, incident to the present time, which urgently demand an increased attention to this study. First, we have an ancient honourable name to regain. Selden, Castell, Lightfoot, Pocock, Walton, Spencer, and Hyde, were once contemporary ornaments of our country. We daily see their names mentioned with deference in the writings of German scholars; but we are forcibly struck with the fact that, since that period, we have hardly, with the exception of Lowth and Kennicott, produced a single Syro-Arabian scholar whose labours have signally advanced Biblical philology. Secondly, the bold inquiries of the German theologians will force themselves on our notice. It is impossible for us much longer to be ignorant of their existence; for that which no English bookseller ventures to undertake finds a more enterprising publisher in America, and soon visits our shores in an English dress. These investigations are conducted in a spirit of philological and historical criticism which has never yet been brought to bear, with such force, on the most important Biblical questions. The wounds which they deal to the ancient traditions cannot be healed by reference to commentators whose generation knew nothing of our doubts and difficulties. The cure must be sympathetic; it must be effected by the same weapon that caused the wound. If the monstrous disproportion which books relating to ecclesiastical antiquity bear, in almost every theological bookseller's catalogue, over those relating to Biblical philology, be an evidence of the degree to which these studies have fallen into neglect, and if the few books in which an acquaintance with Hebrew is necessary, which do appear, are a fair proof of our present ability to meet the Germans with their own weapons—then there is indeed an urgent necessity that theological students should prepare for the increased demands of the future.—J. N.

HEBREW OF THE HEBREWS (עִבְרִית עִבְרָאִית), emphatically a Hebrew, one who was so by both parents, and that by a long series of ancestors, without admixture of Gentile or even proselyte blood. Of this the Jews were as proud as were those Christians in Spain who called themselves Old Christians, of having no mixture of Moorish blood.

HEBREWS. The question as to the origin of

the Hebrew name is incidentally considered in the article HEBREW LANGUAGE.

HEBREWS, EPISTLE TO THE. In the received text this composition appears as part of the Canonical Scriptures of the New Testament, and also as the production of the apostle Paul. For neither of these assumptions is the evidence allowed on all hands to be conclusive; and hence the greatest diversity of opinion prevails among critics as to the claims of this epistle, some contending for its canonical authority and Pauline origin, some denying both of these, and some admitting the former, whilst they repudiate the latter. As the question of its canonicity becomes of importance as a *separate* question only where its Pauline authorship is denied, and as on the latter of these points we mean to advocate the side of the affirmative, it will not be necessary to occupy space with any discussion of the former by itself. We shall proceed accordingly to the consideration of the question of the authorship of this composition.

On no subject, perhaps, in the department of the higher criticism of the New Testament, have opinions been more divided and more keenly discussed, than on this. Of those who have rejected the claims of the apostle Paul to the authorship of this epistle, some have advocated those of Barnabas, others those of Luke, others those of Clement of Rome, others those of Silas, others those of Apollos, others those of some unknown Christian of Alexandria, and others those of some 'apostolic man,' whose name is no less unknown. Of these hypotheses some are so purely conjectural and destitute of any basis either historical or internal, that the bare mention of them as the vagaries of learned men is almost all the notice they deserve. That which ascribes this production to Apollos was first suggested by Luther, and it has been in more recent times adopted by Heumann, Bertholdt, De Wette, Bleek, and, apparently, also Tholuck. Unsupported as this theory is by a shadow of direct evidence either external or internal, it would deserve only to be passed over in silence, were it not for the great names which have espoused it, and the ingenious reasons they have urged in its support. As, however, it rests entirely on the hypothesis that the author of this epistle must have been an Alexandrian, we shall defer any remarks upon it till we come to examine that hypothesis. The claims of Silas have been urged by Böhme in the introduction to his commentary on this epistle (Lips. 1825), and by Mynster in the *Studien und Kritiken*, bd. ii. s. 344; but they have adduced nothing in support of these claims which might not with equal plausibility have been urged on behalf of any other of the companions of Paul. The same might almost be said regarding the supposition that Clement is the author of this work; for though his name is mentioned by Origen in relation to this subject, it is only as that of the supposed amanuensis of Paul, whom Origen's statement sets forth as the reputed author of the epistle, as we shall have occasion more fully to see afterwards; and though Jerome and Philastrius attest that some in the Roman Church ascribed the authorship of this epistle to Clement, the very terms in which they give the statement show that it is one to which they thought no credit was to be attached; nor does a com-

parison of the style and contents of this epistle with those of Clement's extant productions tend to any other conclusion than that the author of the one could not have been the author of the other. The claims of Luke apparently rise a degree higher from the circumstance that, besides being named by Origen, Jerome, and Philastrius, as dividing with Clement the honours which, these writers testify, were in certain quarters assigned to the latter, there is a character of similarity in respect of language and style between this epistle and the acknowledged productions of the evangelist. But on this circumstance no stress can legitimately be laid. For, 1st, where there is no other evidence, or at least none of any weight, in favour of identity of authorship, mere general similarity of style cannot be allowed to possess much force. 2ndly. Assuming the epistle to be the production of Paul, it is easy to account for the resemblance of its style to that of Luke, from the fact that Luke was for so many years the companion and disciple of Paul; for it is well known that when persons for a long time associate closely with each other, and especially when one of the parties is an individual of powerful intellect whose forms of thought and modes of speech imperceptibly impress themselves on those with whom he associates, they fall insensibly into a similarity of tone and style both of speaking and writing. To this, indeed, Chrysostom whose authority in all such matters must be allowed to stand very high, expressly ascribes the similarity of Luke's style to that of Paul, when, contrasting the language of the former with that of Mark, he says, *ἕκαστος δὲ ὁμοίως τὸν διδάσκον ἐμιμήσατο· ὁ μὲν [ὁ Λουκᾶς] τὸν Παῦλον ὑπὲρ τοὺς ποταμοὺς ῥέοντα· ὁ δὲ [ὁ Μάρκος] τὸν Πέτρον βραχυλογίᾳ ἐπιμελούμενον* (*Hom. iv. in Matt.*, quoted by Forster, *Apostolical Authority of the Epistle to the Hebrews*, p. 648). 3rdly. It is not in the epistle to the Hebrews alone that a resemblance to the style of Luke may be detected: the same feature pervades all Paul's epistles, especially those of a later date, as has been frequently observed by critics. This argument, then, if used against the Pauline origin of the epistle to the Hebrews would prove too much, as it would go to invalidate the claims of almost all the acknowledged writings of the apostle. In fine, whilst there are such resemblances of style, &c., as have been referred to between this epistle and the writings of Luke, there are *differences* of a nature so weighty as completely to overbalance these resemblances, and authorize the conclusion that the author of the latter could not also be the author of the former. Both Stuart (*Comment.* vol. i. p. 333, Lond. 1828) and Eichhorn (*Einleit.* bd. iii. s. 465) justly lay stress on the greater predominance of Jewish feelings in the Epistle to the Hebrews than in any of Luke's writings, and still more on the marked familiarity with the peculiarities of the Jewish schools displayed by the writer of the epistle, but of which no traces are apparent in any of the writings of the evangelist. Both writings display the combination of the Palestinian and the Hellenistic character on the part of their author; but in the Epistle to the Hebrews the former so decidedly predominates over the latter, whilst the reverse is the case with the writings of Luke, that it seems to the last degree improbable that the same person

could have written both. It appears, therefore, that for the theory which ascribes this epistle to Luke, there is no evidence of any kind which will bear examination, but, on the contrary, not a little against it. That which claims the authorship of this epistle for Barnabas has in its support the testimony of Tertullian (*De Pudicitia*, c. 20), with whom, as we learn from Jerome (*Epist.* 129, *ad Dardanum*), several (*plerique*) among the Latins concurred.* For this opinion Tertullian, in the passage referred to, assigns no reasons, and Jerome appears to have treated it as a mere conjecture resting upon Tertullian's authority alone; for, in his catalogue of ecclesiastical writers (c. 5), he refers to this opinion as one 'juxta Tertullianum,' whilst he says that the opinion that Luke was the author was one 'juxta quosdam.' Hug is of opinion (*Introd.* p. 596, Fosdick's transl.), that in this passage we have not Tertullian's own view so much as a concession on his part to those whom he was opposing, and who, because of the very passage he is about to quote from the Epistle to the Hebrews (vi. 4-8), were inclined to reject the claims of that epistle to be esteemed the production of Paul. This conjecture is of use, as it tends to show that Tertullian might have another reason for ascribing this epistle to Barnabas than his total ignorance that it had ever been imputed to Paul, as has been confidently inferred by several writers from the fact that it was obviously to the interest of his argument to uphold the Pauline origin of this epistle had he been aware of it. In recent times the ablest defender of this hypothesis is Ullmann, who has devoted to it an article in the first volume of his journal, the *Studien und Kritiken*, but the evidence he adduces in favour of it is very feeble. After enlarging on the testimony of Tertullian, he proceeds to the internal evidence in favour of Barnabas; but of the six reasons he assigns for ascribing the epistle to him, none possesses any force. The first, viz. the traces in the epistle of an Alexandrian education on the part of the author, supposing it granted, would not apply particularly to Barnabas, who was a native of Cyprus, and who, though Ullmann says, 'he had perhaps been in Alexandria,' for aught we know had never seen that seat of allegorical learning. The second, viz. that Barnabas being a Levite was the more likely, on that account, to understand the Jewish ritual, as we see the author of this epistle did, is of no weight, for there is nothing stated in the epistle on that head which any intelligent Jew might not have known, whether a Levite or not. The third, viz. that what the author of this epistle says concerning the law, divine revelation, faith, &c., is very

Pauline, and such as we might expect from a companion of Paul, such as Barnabas was; the fourth, viz. that the tenor of the epistle is worthy such a man as Barnabas; the fifth, viz. that the writer of this epistle speaks of the Saviour very frequently by the appellation δ 'Ιησοῦς, which Dr. Ullmann thinks indicates that the writer must have known our Lord during his personal ministry, which was probably the case with Barnabas; and the sixth, viz. that the names of persons mentioned in this epistle are names which Barnabas might have referred to had he written it—are reasons such as it would be idle to refute, and such as fill us with surprise that a man of Ullmann's learning and vigour should have gravely adduced them. With regard to the fifth also, Olshausen has justly observed (*Opusc. Theologica*, p. 115) that if it were certain that Barnabas had enjoyed the advantage of our Lord's personal ministry, it would clearly prove that he was not the author of this epistle, for the latter distinctly classes himself with those by whom this advantage had not been enjoyed (ch. ii. 3). Stuart and some others have laid great stress on the contrast afforded by this epistle to the extant epistle which passes under the name of Barnabas, in respect of style, tone, and general character, as supplying indubitable evidence that the former is the production of a different and a far superior mind. Of this there can be no question, and, were we quite certain that the epistle ascribed to Barnabas was really his production, the argument would be conclusive. But though some very distinguished names may be cited in support of its authenticity, the greater weight, both of authority and evidence, is against it [BARNABAS, EPISTLE OF]. The total absence of any reason in favour of imputing the authorship of the Epistle to the Hebrews to Barnabas affords sufficient ground for rejecting this hypothesis without our attempting to adduce dubious and uncertain reasons against it.

It only remains that we should consider the alleged traces of an Alexandrian origin in this epistle. These have been much insisted upon by Eichhorn, Schulz, Bleek, and others; but they are not such, we think, as will carry conviction to any impartial inquirer. The standard of comparison by which the supposed Alexandrian tone of this epistle is evinced, is supplied by the writings of Philo, between which and this epistle it is affirmed that there is so close a resemblance that it can be accounted for only on the supposition that the author of the latter was, like Philo, an Alexandrian Jew. Now before this reasoning can be so much as looked at, it behoves those who use it to point out clearly how much of Philo's peculiar style and sentiment was owing to his Jewish, and how much to his Alexandrian, education or habits of thought; because, unless this can be done, it will be impossible to show that any alleged peculiarity necessarily bespeaks an Alexandrian origin, and could not possibly have appeared in the writings of a pure Jew of Palestine. No attempt, however, of this sort has been made; on the contrary, it has been assumed that whatever is Philonian is therefore Alexandrian, and hence, all resemblances between the writings of Philo and the Epistle to the Hebrews have been urged as certain proofs that the latter must have been written by a converted Jew of Alex-

* Ullmann (*Stud. und Krit.* i. 391) has laboured to show that the 'plerique' in this passage must be understood of persons belonging to the Eastern church, the 'Græci sermonis scriptores,' of whom Jerome speaks in the same sentence. Had he read the passage attentively, however, he would have perceived that what Jerome says is, that though in his day 'plerique eam vel Barnabæ vel Clementis arbitrantur,' it was viewed as Paul's 'non solum ab ecclesiis Orientis, sed ab omnibus retro [i. e. antiquioribus] ecclesiasticis Græci sermonis scriptoribus.' If all the Greek writers judged it to be Paul's, how could many of them ascribe it to Barnabas?

andria. Such an assumption, however, we would by no means concede; and we feel confirmed in this by an examination of the evidence adduced in support of the alleged Alexandrian character of this epistle. As Stuart has, we think, clearly shown (i. 321), and as even Tholuck, though obviously inclining the other way, has candidly admitted (*Comment. on the Hebrews*, i. p. 68, § 7), there is nothing in this evidence to show that this epistle might not have been written by a Jew who had never left the bounds of Palestine. It is worthy of notice that several of the points on which Eichhorn chiefly insists as favouring his view, such as the prevalence of typical expositions of the Mosaic ritual in this epistle, and the greater elegance of its language and style (*Einkleit.* iii. 443 ff.), are given up by Bleek, and that of the two chiefly insisted upon by the latter, viz. the close affinity between this epistle and the writings of Philo, and the alleged mistake in regard to the furniture of the tabernacle which Bleek charges upon the author of this epistle in ch. ix. 3, 4, and which he thinks no Jew of Palestine could have committed, both are relinquished by Tholuck as untenable (comp. the valuable remarks of Hug, *Introd.* p. 584, note, Fosdick's transl.). With regard to the latter, it may be remarked that, even supposing it proved that the writer of this epistle had erred in asserting that the pot containing the manna and Aaron's rod were placed in the ark of the testimony, and that, supposing *θυμιατήριον* to denote the altar of incense, and not the censer, he had fallen into the mistake of placing this within instead of without the veil, nothing could be thence deduced in favour of the Alexandrian origin of the author. For, with regard to the former of these it was a matter on which the Jews of Palestine had no better means of information than those of any other place, since, in the Temple as then standing, none of the furniture of the Holy of Holies had been preserved; and with regard to the latter, as it could not be the result of ignorance either in a Jew of Palestine or in a Jew of Alexandria, but must have been a piece of mere *inadvertence* on the part of either, it seems rather too much to conclude that it was such as the latter alone was capable of committing. That, however, there is no blunder in the case, has, we think, been very satisfactorily shown by Deyling (*Obs. Sac.* tom. ii. No. 47) and others (comp. Stuart and Tholuck *in loc.*).

On the alleged Alexandrian tone of this epistle rests, as already remarked, the entire claims of Apollos to the authorship. In setting aside the former, therefore, we of necessity repudiate also the latter. But it may be permitted us to remark that, even supposing the former established, the latter would by no means follow, any more than because a work produced in Germany in the present day was deeply tinged with Hegelianism, it would follow from that alone, that it must be the production of Strauss rather than of Weisse, or any other disciple of Hegel's school. The adoption of this theory by Dr. Tholuck, after his exposure of the unsoundness of Bleek's reasonings, has filled us with surprise. 'Still,' says he (i. 69), 'could it be rendered probable that any distinguished person having intercourse with Paul, were an Alexandrian, and of Alexandrian culture, we might, with the greatest appearance of

truth, regard him as the author of the epistle. Now such an one is found in the person of Apollos.' What is this but to say, 'The arguments for the Alexandrian origin of this epistle. I must confess, prove nothing; but show me an end to be gained by it and I will admit them to be most conclusive!' Such a statement affords, we think, very clear evidence that the disposition to ascribe this epistle to Apollos is to be traced not to any constraining force of evidence, but exclusively to what Olshausen in his strictures on Bleek (*Opusc.* p. 92) justly denounces as the main source of that able writer's errors on this question—'Quod non ab omni partium studio alienum animum servare ipsi contigit.'

We have occupied so much space in the examination of these hypotheses, partly because we wish to make it apparent how slender and shadowy are the grounds on which the opponents of the Pauline origin of this epistle are content to acquiesce in the claims of the parties who have been put forward as the Apostle's competitors; and partly because, before proceeding to consider the evidence directly for and against the claims of the Apostle, we are desirous to make it apparent that, unless these claims can be substantiated, we must give up as hopeless all attempts to ascertain the author of this epistle. Our sole choice lies here between Paul and some unknown writer of the apostolic age. This gives the question a character of no small importance, for it renders it virtually a question as to the canonical authority of this epistle. In the formation of the New Testament Canon we have no reason to believe that any supernatural aid was vouchsafed; but each church received or rejected books according as they were satisfied or not with the evidence historical and internal of their having proceeded from some apostolic source [CANON]. The only ground, therefore, upon which we can receive any book as canonical, is its being shown that it was received in the primitive churches as sanctioned by apostolic authority, confirmed by a comparison of its contents with the general doctrines of the Bible, and of its style and statements with those of the known writings of the party to whom it is ascribed. Where this cannot be done the mere antiquity of the book proves nothing to the point; the fact that, however ancient, the book cannot be shown to have been received by those who alone were qualified to judge accurately of such matters, as either the production of an apostle or of some known individual who wrote under the sanction and guidance of an apostle, is enough to set aside all its claims to be revered as a part of the divine word. Now if all attempts to ascribe the Epistle to the Hebrews to the pen of any of the known companions of Paul must be regarded as futile, it follows that unless it can be shown to have been received by the early churches as the production of the Apostle himself, and that upon grounds not incompatible with actual evidence to the contrary, it must be struck out from its place in the sacred Canon, and, masterly as it is, be ranked with the productions of uninspired human wisdom.

Referring our readers for particulars to the able and copious discussion of this question furnished by the works of Stuart (*Commentary*, vol. i.), Forster (*The Apostol. Authority of the Ep. to the Hebrews*, &c.), and Hug, we shall attempt to

present a condensed outline of the evidence, both for and against the Pauline authorship of this epistle. Following the example of Hug and Forster, we shall commence with the *internal evidence*, taking up first that in favour of the Pauline origin of the epistle.

1. A person familiar with the doctrines on which Paul is fond of insisting in his acknowledged epistles, will readily perceive that there is such a correspondence in this respect between these and the Epistle to the Hebrews, as supplies good ground for presuming that the latter proceeded also from his pen. That Christianity as a system is superior to Judaism in respect of clearness, simplicity and moral efficiency; that the former is the substance and reality of what the latter had presented only the typical adumbration; and that the latter was to be abolished to make way for the former, are points which, if more fully handled in the Epistle to the Hebrews, are familiar to all readers of the Epistles of Paul (comp. 2 Cor. iii. 6-18; Gal. iii. 22; iv. 1-9, 21-31; Col. ii. 16, 17, &c.). The same view is given in this epistle as in those of Paul, of the divine glory of the Mediator, not simply as *θεάνθρωπος*, but specifically as the *εἰκὼν τοῦ θεοῦ*, the reflection or manifestation of Deity to man (comp. Col. i. 15-20; Phil. ii. 6; Heb. i. 3, &c.); His condescension is described as having consisted in an impoverishing, and lessening, and lowering of Himself for man's behalf (2 Cor. viii. 9; Phil. ii. 7, 8; Heb. ii. 9); and His exaltation is set forth as a condition of royal dignity, which shall be consummated by all His enemies being put under His footstool (1 Cor. xv. 25-27; Heb. ii. 8; x. 13; xii. 2). He is represented as discharging the office of a *μεσίτης*, a word which is never used except by Paul and the writer of this epistle (Gal. iii. 19, 20; Heb. viii. 6); His death is represented as a sacrifice for the sins of man; and the peculiar idea is announced in connection with this, that He was prefigured by the sacrifices of the Mosaic dispensation (Rom. iii. 22-26; 1 Cor. v. 7; Eph. i. 7; v. 2; Heb. vii.-x.). Peculiar to Paul and the author of this epistle is the phrase *ὁ θεὸς τῆς εἰρήνης* (Rom. xv. 33, &c.; Heb. xiii. 20); and both seem to have conceived of the *χαρίσματα* under the aspect of *διαρρέσεις* and *μερίσμοι πνεύματος* (1 Cor. xii. 4; Heb. ii. 4). It is worthy of remark also that the momentous question of a man's personal acceptance with God is answered in this epistle in the same peculiar way as in the acknowledged Epistles of Paul. All is made to depend upon the individual's exercising what both Paul and the author of this epistle call *πίστις*, and which they both represent as a realizing apprehension of the facts, and truths, and promises of revelation.* By both

also the power of this *πίστις* is frequently referred to and illustrated by the example of those who had distinguished themselves in the annals of the Jewish race (comp. Rom. iii. 4; v. 2; Heb. iii. 6; Gal. iii. 5-14; Heb. x. 38; xi. 40). On all these points the sentiments of this epistle are so obviously Pauline, that not only did Origen remark that it contained τὰ νοήματα Παύλου, but even the most decided opponents of its Pauline authorship in recent times have laid it down as undeniable that it must have been written by some companion and disciple of Paul. 2. Some of the figures and allusions employed in this epistle are strictly Pauline. Thus the word of God is compared to a *sword* (Eph. vi. 17; Heb. iv. 12); inexperienced Christians are *children* who need *milk*, and must be instructed in the *elements*, whilst those of *maturer* attainments are *full-grown men* who require *strong meat* (1 Cor. iii. 1, 2; xiv. 20; Gal. iv. 9; Col. iii. 14; Heb. v. 12, 13; vi. 1); redemption through Christ is an *introduction* and an *entrance with confidence* unto God (Rom. v. 2; Eph. ii. 18; iii. 12; Heb. x. 19); afflictions are a *contest* or *strife* ἀγών (Phil. i. 30; Col. ii. 1; Heb. x. 32); the Christian life is a *race* (1 Cor. ix. 24; Phil. iii. 14; Heb. xii. 1); the Jewish ritual is a *λαρρεία* (Rom. ix. 4; Heb. ix. 1, 6); a person under the constraint of some unworthy feeling or principle is *ἐποχος δουλείας* (Gal. v. 1; Heb. ii. 15) &c. The fact that these and other such like figurative phrases occur only in this epistle and in the acknowledged Epistles of Paul, affords strong evidence that the former is his production, for in nothing does a writer more readily betray himself than by the use of peculiar and favourite figures. 3. Certain marked characteristics of Paul's style are found in this epistle. This department of the internal evidence has, more, perhaps, than any other, been canvassed by recent critics, and in some cases opposite conclusions have been drawn from the same phenomena. Thus the occurrence of *ἅπασα λεγομένα* in this epistle has been adduced by the German scholars *against* the Pauline origin of it, whilst Stuart and Forster have both rested on this part as strongly *in favour* of that conclusion; and as it appears to us with justice, for if it be made out from Paul's acknowledged writings that the use of unusual words is a characteristic of his style (and this has been placed by these writers beyond all question), it is obvious that the occurrence of the *same* characteristic in this epistle, so far from being an argument *against*, is, as far as it goes, an argument *for* our ascribing it to Paul. On arguments, however, based on such minute phenomena, we are not disposed to rest much weight on either side. Every person must be aware that an author's use of words is greatly modified by the circumstances under which he writes or the design he has in writing; and the literature of every country presents us with numerous cases of authors, whose works, written at different periods, and with different designs, present far greater diversities of expression than any which have been pointed out between the Epistle to the Hebrews and the acknowledged Epistles of Paul. Hence cautious critics have declined to rest

* Bleek and Tholuck have both endeavoured to show that the *πίστις* of the Epistle to the Hebrews is not the same as the *πίστις* of Paul's acknowledged writings, but with singular want of success in our view. Tholuck's chief argument, and which he urges as of more weight than any Bleek has advanced, is, that the writer has not here contrasted νόμος and πίστις, the ἔργα νόμου, and the ἔργα πίστεως, as Paul would have done. But how can this be said when the great lesson of the epistle is, that *always*, even *under the law itself*, πίστις was the medium of

acceptance and the channel of divine blessing to men?

much in questions of literary parentage upon what Bentley calls (*Dissert. on Phalaris*, p. 19, Lond. 1699) 'censures that are made from stile and language alone,' and which, he adds, 'are commonly nice and uncertain, and depend upon slender notices.' Apart, however, from such minute niceties, there are certain marked peculiarities of style which attach to particular writers, and flow so directly from the character of their genius or education, that they can hardly express themselves in discourse without introducing them. Now such peculiarities the writings of Paul present, and the occurrence of them has always been felt to afford no small evidence of the authenticity of any production claiming to be his in which they are found. Paley, in enumerating these (*Hovæ Paulinæ*), has laid stress chiefly on the following: A disposition to the frequent use of a word, which cleaves as it were to the memory of the writer, so as to become a sort of *cant* word in his writings; a propensity 'to go off at a word,' and enter upon a parenthetic series of remarks suggested by that word; and a fondness for the paronomasia, or play upon words. In the Epistle to the Hebrews these peculiarities of Paul's style are richly exemplified; an evidence in favour of its Pauline origin which can never be effeebled by adducing words, phrases, or features of style *peculiar* to this epistle, unless it can be first shown that it was *impossible* for Paul to have used such. 4. There is a striking analogy between Paul's use of the Old Testament and that made by the writer of this epistle. Both make frequent appeals to the Old Testament; both are in the habit of accumulating passages from different parts of the Old Testament, and making them bear on the point under discussion (comp. Rom. iii. 10-18; ix. 7-33, &c.; Heb. i. 5-14; iii.; x. 5-17); both are fond of linking quotations together by means of the expression *καὶ παλιν* (comp. Rom. xv. 9-12; 1 Cor. iii. 19, 20; Heb. i. 5; ii. 12, 13; iv. 4, x. 30); both make use of the same passages, and that occasionally in a sense not naturally suggested by the context whence they are quoted (1 Cor. xv. 27; Eph. i. 22; Heb. ii. 8; Rom. i. 17; Gal. iii. 11; Heb. x. 38); and both, in one instance, quote the same passage in the same way, but in a form in which it does not agree with the Sept., and with an addition of the words *λέγει κύριος*, not found in the Hebrew; thereby indicating that the passage is given in both instances as it was present to the memory of one and the same writer (comp. Rom. xiii. 19; Heb. x. 30). On the other hand, great stress has been laid by the opponents of the Pauline origin of this epistle on the fact, that whilst Paul in his acknowledged writings quotes from the Hebrew original in preference to the Sept. where the latter differs from the former, the author of this epistle quotes exclusively from the Sept., even when it departs very widely from the Hebrew. To this it may be replied: 1st, That both Paul and the author of this epistle quote *generally* from the Sept.; 2ndly, That where the Sept. differs from the Hebrew, Paul does not *always* follow the Hebrew in preference to the Sept. (comp. Rom. ii. 24; x. 11-18; xi. 27; xv. 12; 1 Cor. i. 19, &c.); and, 3rdly, That the writer of this epistle does not *always* follow the Sept. where it differs from the Hebrew, but occasionally deserts the former for the latter (*e. gr.* x. 30; xiii. 5). These is no ground, therefore,

for this objection to the Pauline origin of this epistle. *In fine*: The Epistle to the Hebrews contains some personal allusions on the part of the writer which strongly favour the supposition that he was Paul. These are the mention of his intention to pay those to whom he was writing a visit speedily, in company with Timothy, whom he affectionately styles 'our brother,' and whom he describes as having been set at liberty, and expected soon to join the writer (Heb. xiii. 23); the allusion to his being in a state of imprisonment at the time of writing, as well as of his having partaken of their sympathy while formerly in a state of bondage among them (Heb. xiii. 19; x. 34); and the transmission to them of a salutation from the believers in Italy (Heb. xiii. 24); all of which agree well with the supposition that Paul wrote this epistle while a prisoner at Rome.

Such is an outline of the internal evidence furnished by this epistle of its Pauline origin. Let us now glance at the main objections which from various sources have been urged against it.

1. It is unaccountable that Paul, had he written this epistle, should have withheld his name. But is it less unaccountable that Clement, or Apollos, or Luke, had any of them been the author, should have withheld his name? Might not Paul write anonymously as well as any other man? *Why* he should have done so in this case we admit our inability to say satisfactorily; the only apparent reason, as far as we have been able to see, being the more rhetorical character of the production, which *might* induce the author to waive the usual form of epistolary address. But our inability to assign the reason why this work should have been issued anonymously cannot surely be held to be an argument against its authenticity, else it would be impossible to establish the authenticity of any anonymous production unless we could satisfactorily show what were the author's reasons for withholding his name—a thing which in five cases out of six it is impossible to do. 2. 'This epistle is more calmly and logically written than it was possible for the energetic Paul to have written; all the analogies between Judaism and Christianity are calmly investigated and calmly adduced; the materials are arranged in the strictest order, and carefully wrought out according to this disposition, and conclusion follows conclusion with the greatest regularity; the language also is rotund and choice, and the representation unusually clear. All this is unlike Paul' (Eichhorn, *Einleit.* iii. 459). It will perhaps surprise our readers to find the author of the Epistle to the Romans pronounced so utterly incapable of calm, connected, and logical reasoning, that it is inconceivable he should have written the Epistle to the Hebrews. If there be one thing for which Paul's writings are more remarkable than another, it is their dialectic accuracy; and as for calmness, whilst we admit that as a whole there is less of ardour and vehemence in this epistle than in the majority of Paul's acknowledged epistles, we think this is to be ascribed to the fact that a large portion of it is occupied with remarks of an explanatory and illustrative kind—remarks which are usually made in a calmer tone than where the design of the writer is to expose error, or to exhort to duty; and, on the other hand, we would assert that in

those parts of the epistle where his subject calls the writer to the utterance of reproof, warning, or exhortation, the language is equally ardent with that used in any analogous passages in the writings of Paul. This brings us to the closing part of Eichhorn's objection, which relates to the use in this epistle of a more rotund, elegant, and perspicuous style than we find usually in the epistles of Paul. Now it must be admitted here that this composition does partake much more of the character of a flowing, continuous discourse, than is found in the apostle's acknowledged productions. The question, however, is not, Whether Paul might not for some sufficient reason prefer attempting such a discourse in this particular case? a question which it would surely be absurd to discuss; but, Whether, *supposing* him to make the attempt, it is conceivable that he should succeed in it to the extent realized by the writer of this epistle? Eichhorn concludes in the negative; but on what grounds? Apparently on the grounds that the apostle's acknowledged writings present no specimens of such success; so that his argument is this: Supposing Paul to have attempted to write rhetorically, it is impossible he should have succeeded so well, because we find that, where he makes no such attempt, his style is far from being rhetorical! Of such reasoning we are content to say, 'Valeat quantum valere potest. We may also hint that, in our opinion, there is no passage in the Epistle to the Hebrews, imposing as it is, which might not have flowed from the same pen which composed the 8th chapter of Romans, and the 13th of 1st Corinthians.—3. 'Whilst we occasionally meet Pauline *termini*, we find precisely in the *leading ideas* of the epistle a terminology different from that of Paul' (Tholuck, i. 39, Eng. transl.). The instances specified by Dr. Tholuck are the use of *ἱερείς*, *ποιμήν*, and *ἀπόστολος*, as designations of Christ; of *ἑμολογία*, which he says is confined to this epistle; of *ἐγγίξεν τῷ θεῷ*; and of *τελειοῦν*, with its derivatives in the sense in which it is used Heb. vii. 19. Now, with regard to this objection, it may be observed, 1st. That supposing all the instances adduced by Tholuck to be unimpeachable, and supposing no reason could be assigned why Paul should use such in writing to Hebrews, when he did not use them in writing to others, still the objection cannot have much weight with any person accustomed to weigh evidence, because not only is the number of Pauline *termini* found in this epistle far greater than the number of *termini* which, according to Tholuck, are 'foreign to the apostle to the Gentiles;' but it is always less likely that the peculiar phrases of a writer should be borrowed by another, than that a writer noted for the use of peculiar words and phrases should, in a composition of a character somewhat different from his other productions, use terms not found elsewhere in his writings. But, 2ndly, let us examine the instances adduced by Tholuck, and see whether they bear out his reasoning. 'Paul nowhere calls Christ *priest*.' True; but though Paul, in writing to churches composed more or less of Gentile converts, whose previous ideas of priests and priestly rites were anything but favourable to their receiving under sacerdotal terms right notions of Christ and his work, never calls Christ a priest, is that any reason for our concluding that in writing to Jews, who had

amongst them a priesthood of divine organization, and writing for the express purpose of showing that that priesthood was typical of Christ, it is inconceivable that the apostle should have applied the term *priest* to Christ? To us the difficulty would rather seem to be to conceive how, in handling such a topic, he could *avoid* calling Christ a priest.—'Paul nowhere calls Christ a *shepherd* and an *apostle*, as the writer of this epistle does.' But the whole weight of this objection to the Pauline origin of this epistle must rest on the assumption that Paul never uses figurative appellations of Christ in his writings; for if he do, why not here as well as elsewhere? Now it could only be the grossest unacquaintance with the apostle's writings which could lead any to affirm this. The very opposite tendency is characteristic of them. Thus we find Christ termed *τέλος νόμου* (Rom. x. 4), *διάκονον περιτομῆς* (xv. 18), *τὸ πάσχα ἡμῶν* (1 Cor. v. 7), *ἡ πέτρα* (x. 4), *ἀπαρχή* (xv. 23), *ἐν ἄνδρῳ* (2 Cor. ii. 2), *ἀκρογωνιαίου* (Eph. ii. 20), &c. With these instances before us, why should it be deemed so utterly incredible that Paul could have called Christ *ἀπόστολος* and *ποιμήν*, that the occurrence of such terms in the epistle before us is to be held as a reason for adjudging it not to have been written by him? With regard to the use of *ἑμολογία* in the sense of *religious profession*, the reader may compare the passages in which it occurs in this epistle with Rom. x. 9; 2 Cor. ix. 13; 1 Tim. vi. 12, and judge for himself how far such a usage is foreign to the apostle. The phrase *ἐγγίξεν τῷ θεῷ* occurs once in this epistle (vii. 19), and once in the Epistle of James; Paul also once uses the verb actively (Phil. ii. 30); and, on the other hand, the author of this epistle once uses it intransitively (x. 25). As there is thus a perfect analogy in the usage of the verb between the two, why it should be supposed improbable that Paul should use it in reference to God, or why a phrase used by James should be deemed too Alexandrian to be used by Paul, we feel ourselves utterly at a loss to conceive. With regard to the use of *τελειοῦν*, Dr. Tholuck himself contends (*Appendix*, ii. 297) that it everywhere in this epistle retains the idea of *completing*; but he cannot understand how Paul could have contemplated the work of redemption under this term in this epistle, since in no other of his epistles is it so used. This difficulty of the learned professor may, we think, be very easily removed, by remarking that it does not appear to have been Paul's design elsewhere, so fully at least as here, to represent the superiority of Christianity over Judaism, as that arises from the former being sufficient, whilst the latter was not sufficient, to *complete* men in a religious point of view, *i. e.* to supply to them all they need, and advance them to all of which they are capable. That this is the theme of the writer the passages in which the word in question occurs show; and we see no reason why such an idea might not have occurred to Paul as well as to any other man.

Such are the objections on which the more recent impugnors of the Pauline authorship of this epistle seem inclined to lay most stress. A multitude of others have been urged by Bertholdt, Schulz, Seyffarth, &c., which have been carefully noticed and replied to by Stuart, but which it is unnecessary to adduce here, as their futility seems

very generally admitted even by those who take the anti-Pauline side.

It appears, therefore, that from the epistle itself nothing can be gathered materially unfavourable to the opinion that Paul was its author, whilst there is much in it strongly tending to support that opinion. It yet remains that we should look at the external evidence bearing on this question. Here we shall find the same conclusion still more decisively supported.

Passing by, as somewhat uncertain, the alleged testimony of Peter, who is supposed (2 Pet. iii. 15, 16) to refer to the Epistle to the Hebrews as the composition of Paul, and passing by, also, the testimonies of the apostolic fathers, which, though very decisive as to the antiquity and canonical authority of this epistle (see Forster's *Inquiry*, § 13), yet say nothing to guide us to the author, we come to the testimony of the Eastern church upon this subject. Here we meet the important fact, that of the Greek fathers not one ascribes this epistle to any but Paul. Pantænus (ap. Euseb. *Hist. Eccles.* vi. 14), in the second century, ascribes it to the apostle; and so does Clement of Alexandria (*ibid.*, *Stromat.* vi. 645, et sæpe). Origen (ap. Euseb. *Hist. Eccles.* vi. 15), in affirming that the Pauline authorship of this epistle was in his day matter of *ancient tradition*, assents to the truth of this opinion, and in noticing what he thinks the un-Pauline features of the style, mentions that a report was extant to the effect that, whilst the ideas were Paul's, the words were those of Clement of Rome or of Luke; though, so far from regarding this as certain, he says that 'God knows who was the writer (*i. e.*, as the context shows, *the amanuensis*) of this epistle.' Eusebius, whilst he places this epistle among the *ἀντιλεγόμενα*, knowing that in the church at Rome its claims had been questioned, nevertheless often quotes it as Paul's (see the passages in Lardner's *Credibility; Works*, iv. 249, ed. 1788), and includes it as received by the church generally among the Pauline epistles (*Hist. Eccles.* iii. 25). A number of other testimonies from the Eastern church may be found in Lardner (vol. vi. p. 391), fully justifying the assertion above made. Jerome also assures us (*Ep. ad Dardanum*) that it was received as Paul's by all the Greek writers. Nor does it appear that in any part of the Eastern church the Pauline origin of this epistle was ever doubted or suspected (comp. Olshausen, *Opusc. Theolog.* p. 95).

In the Western church this epistle did not meet with the same early and universal reception. Notwithstanding the regard shown for it by Clement, the church at Rome seems to have placed it under a ban (comp. Euseb. *Hist. Eccles.* iii. 3; vi. 20, see Heinichen's note); and hence Tertullian ascribed it to Barnabas, and others to Luke and Clement, whilst no Latin writer is found during the first three centuries who ascribed it to Paul. In the middle of the fourth century, Hilary of Poitiers quotes it as Paul's; and from that time the opinion seems to have gained ground till the commencement of the fifth century, when it speedily became as general in the Western as it had been in the Eastern churches (Lardner, vol. vi. p. 393). Now, of what value is this state of opinion in the early churches of the West in the question of evidence now before us? To judge of this, we must bear in mind that the sole amount of evi-

dence arising from the testimony of the Latin churches is *negative*; all we can conclude from it, at the most, is that they had no sufficient evidence in favour of this epistle being Paul's; they do not seem to have had a shadow of historical evidence against its being his. The claims of Barnabas, Clement, and Luke, rest upon mere individual conjecture, and have no historical support. Supposing, then, that the rejection of this epistle by the Latins cannot be accounted for by circumstances peculiar to them, still this fact cannot diminish the weight of evidence accruing from the unanimity of the Greeks and Asiatics. Had the Latins been as unanimous in favour of Apollon or Clement as the Eastern churches were in favour of Paul, the case would have been different. The value of Paul's claims would in that case have been equal to the difference between the value of the Eastern tradition and the value of the Western. This would have furnished a somewhat puzzling problem; though even in that case the superiority of the Eastern witnesses to the Western would have materially advocated the claims of the apostle. As the case stands, *all* the positive evidence extant is in favour of the Pauline authorship of this epistle; and the only thing against it is that in the Latin churches there appears to have been no commonly received tradition on the subject. Under such circumstances, the claims of the apostle are entitled to be regarded as fully substantiated by the external evidence.

The result of the previous inquiry may be thus stated. 1. There is no substantial evidence external or internal in favour of any claimant to the authorship of this epistle except Paul. 2. There is nothing incompatible with the supposition that Paul was the author of it. 3. The preponderance of the internal, and all the direct external, evidence, go to show that it was written by Paul.

Assuming the Pauline authorship of the epistle, it is not difficult to determine *when* and *where* it was written. The allusions in ch. xiii. 19, 21, point to the closing period of the apostle's two years imprisonment at Rome as the season during 'the serene hours' of which, as Hug describes them (*Introd.* p. 603), he composed this noblest production of his pen. In this opinion almost all who receive the epistle as Paul's concur; and even by those who do not so receive it, nearly the same time is fixed upon, in consequence of the evidence furnished by the epistle itself of its having been written a good while after those to whom it is addressed had become Christians, but yet before the destruction of the Temple.

That the parties to whom this epistle was addressed were converted Jews, the epistle itself plainly shows. Ancient tradition points out the church at Jerusalem, or the Christians in Palestine generally, as the recipients. Stuart contends for the church at Cæsarea, not without some show of reason.

An early opinion that the epistle was first written in Hebrew or Aramaic, and then translated into Greek, has found in Michaelis a strenuous defender (*Introd.* iv. p. 221). The arguments he adduces, however, are more specious than sound; and it has been abundantly shown by Lardner, Hug, Eichhorn, and others, that this opinion is untenable. Why Paul should have

written in Greek to persons residing in Judæa is best answered by the reasons which Hug (*Introd.* p. 326, sqq.) and Diodati (*De Christo Græce loquente exercitatio*, &c., edited by O. T. Dobbin, L.L.B., Lond. 1813) have adduced, to show that Greek was at that time well known to the mass of the Jews (comp. Tholuck, i. 78).

Some have doubted whether this composition be justly termed an epistle, and have proposed to regard it rather as a treatise. The salutations, however, at the close, seem rather to favour the common opinion; though it is of little moment which view we espouse.

The design of this epistle is to dissuade those to whom it is written from relapsing into Judaism, and to exhort them to hold fast the truths of Christianity which they had received. For this purpose the apostle shows the superiority of the latter over the former, in that it was introduced by one far greater than angels, or than Moses, from whom the Jews received their economy (i. iii.), and in that it affords a more secure and complete salvation to the sinner than the former (iv. x.). In demonstrating the latter position the apostle shows that in point of dignity, perpetuity, sufficiency, and suitableness, the Jewish priesthood and sacrifices were far inferior to those of Christ, who was the substance and reality, whilst these were but the type and shadow. He shows, also, that by the appearance of the anti-type the type is necessarily abolished; and adduces the important truth, that now, through Christ, the privilege of personal access to God is free to all. On all this he founds an exhortation to a life of faith and obedience, and shows that it has ever been only by a spiritual recognition and worship of God that good men have participated in his favour (xi.). The epistle concludes, as is usual with Paul, with a series of practical exhortations and pious wishes (xii.-xiii.).

Of Commentaries on this epistle the following may be enumerated as ranking among the best. Owen's *Exposition of the Epistle to the Hebrews, with preliminary exercises*, 4 vols. folio, Lond. 1668-84; Maclean's *Paraphrase and Commentary on the Epistle to the Hebrews*, 2 vols. 8vo., Lond. 1819; Stuart's *Commentary on the Epistle to the Hebrews*, 2 vols. 8vo., Lond. 1828; 1 vol. *ibid.* 1831; Carpzov, *Sacra Exercit. in Pauli Ep. ad Heb.* 8vo., Helmst. 1750; Storr, *Pauli Brief. an d. Heb. erläutert*, 8vo., Tüb. 1809; Ernesti, *Lectiones Acadd. in Ep. ad Heb.* 8vo., Lips. 1795; Böhme, *Ep. ad Heb. lat. vert. et comment. perpet. instruxit*, 8vo., Lips. 1825; Kuinoel, *Comment. in Ep. ad Heb.* 8vo., Lips. 1831; Bleek, *Der. Br. an d. Heb. erläutert u.s.w.* 2 bd., Berl. 1828-40. Tholuck, *Kommentar zum Br. an d. Heb.* 8vo., Hamb. 1840 (2te. Aufl.), translated into English by James Hamilton, M.A., and J. E. Ryland, Esq., 2 vols. 8vo., Edin. 1842.—W. L. A.

HEBRON (חֶבְרוֹן; Sept. Χεβρών), a town in the south of Palestine and in the tribe of Judah, 18 miles south from Jerusalem, in 31° 32' 30" N. lat., 35° 8' 20" E. long., at the height of 2664 Paris feet above the level of the sea (Schubert). It is one of the most ancient cities existing, having, as the sacred writer informs us, been built 'seven years before Zoan in Egypt,' and being mentioned even prior to Damascus (Num. xiii. 22;

Gen. xiii. 18; comp. xv. 2). Its most ancient name was Kirjath-arba, that is, 'the city of Arba,' from Arba, the father of Anak and of the Anakim who dwelt in and around Hebron (Gen. xxiii. 2; Josh. xiv. 15; xv. 3; xxi. 11; Judg. i. 10). It appears to have been also called Mamre, probably from the name of Abraham's Amoritic ally (Gen. xxiii. 19; xxxv. 27; comp. xiv. 13, 28). The ancient city lay in a valley; and the two remaining pools, one of which at least existed in the time of David, serve, with other circumstances, to identify the modern with the ancient site (Gen. xxxvii. 14; 2 Sam. iv. 12). Much of the life-time of Abraham, Isaac, and Jacob was spent in this neighbourhood, where they were all entombed; and it was from hence that the patriarchal family departed for Egypt by the way of Beersheba (Gen. xxxvii. 14; xli. 1). After the return of the Israelites, the city was taken by Joshua and given over to Caleb, who expelled the Anakim from its territories (Josh. x. 36, 37; xiv. 6-15; xv. 13-14; Judg. i. 20). It was afterwards made one of the cities of refuge, and assigned to the priests and Levites (Josh. xx. 7; xxi. 11, 13). David, on becoming king of Judah, made Hebron his royal residence. Here he reigned seven years and a half; here most of his sons were born; and here he was anointed king over all Israel (1 Sam. ii. 1-4, 11; 1 Kings ii. 11; 2 Sam. v. 1, 3). On this extension of his kingdom Hebron ceased to be sufficiently central, and Jerusalem then became the metropolis. It is possible that this step excited a degree of discontent in Hebron which afterwards encouraged Absalom to raise in that city the standard of rebellion against his father (2 Kings xv. 9, 10). Hebron was one of the places fortified by Rehoboam (2 Chron. xi. 10); and after the exile the Jews who returned to Palestine occupied Hebron and the surrounding villages (Neh. xi. 15).

Hebron is not named by the prophets, nor in the New Testament; but we learn from the first book of Maccabees, and from Josephus, that it came into the power of the Edomites, who had taken possession of the south of Judah, and was recovered from them by Judas Maccabæus (1 Macc. v. 65; Joseph. *Antiq.* xii. 8, 6). During the great war, Hebron was seized by the rebel Simon Giorides, but was re-captured and burnt by Cerealis, an officer of Vespasian (Joseph. *De Bell. Jud.* iv. 9; vii. 9). Josephus describes the tombs of the patriarchs as existing in his day; and both Eusebius and Jerome, and all subsequent writers who mention Hebron down to the time of the Crusades, speak of the place chiefly as containing these sepulchres. In the course of time the remarkable structure enclosing the tombs of Abraham and the other patriarchs was called the 'Castle of Abraham,' and by an easy transition this name came to be applied to the city itself; till in the time of the Crusades the names of Hebron and Castle of Abraham were used interchangeably. Hence, as Abraham is also distinguished among the Moslems by the appellation of *el Khulil*, 'the Friend' (of God), this latter epithet became, among them, the name of the city; and they now know Hebron only as *el Khulil* (Robinson's *Researches*, ii. 456).

Soon after the Crusaders had taken Jerusalem, Hebron also appears to have passed into their hands, and, in 1190, was bestowed as a fief

upon Gerhard of Avennes; but two years after it is described as being in ruins (Wilken, *Gesch. der Krus.* ii. 41; Saewulf, *Peregrin.* p. 269). In 1167 Hebron was raised to the rank of a bishopric, and the title of bishop of Hebron long remained in the Romish church; for it occurs so late as A.D. 1365. But it was merely nominal; for after the capture of Jerusalem by Saladin in 1187, Hebron also reverted to the Moslems, and has ever since remained in their possession. In the modern history of Hebron the most remarkable circumstance is the part which the inhabitants of the town and district took in the rebellion of 1831, and the heavy retribution which it brought down upon them. They held out to the last, and gave battle to Ibrahim Pasha near Solomon's Pools. They were defeated; but retired and entrenched themselves in Hebron, which Ibrahim carried by storm, and gave over to sack and pillage. The town has not yet recovered from the blow it then sustained.

In the fourteenth century pilgrims passed from Sinai to Jerusalem direct through the desert by Beersheba and Hebron. In the following century this route seems to have been abandoned for that by Gaza; yet the pilgrims sometimes took Hebron in their way, or visited it from Gaza. The travellers of that period describe as existing here an immense charitable establishment, or hospital, where 1200 loaves of bread, besides oil and other condiments, were daily distributed to all comers, without distinction of age or religion, at the annual expense of 20,000 ducats.

Hebron continued to be occasionally visited by European travellers down to the latter part of the seventeenth century; but from that time till the present century it appears to have been little frequented by them. The principal travellers who have been more recently there are Seetzen, Ali Bey, Irby and Mangles, Poujoulat, Monro, Stephens, Paxton, Lord Lindsay, Russegger, Schubert, Dr. Robinson, and Dr. Olin.

The town of Hebron lies low down on the sloping sides of a narrow valley (of Mamre), chiefly on the eastern side, but in the southern part stretches across also to the western side. The houses are all of stone, high and well built, with windows and flat roofs, and on these roofs are small domes, sometimes two or three to each house. This mode of building seemed to Dr. Robinson peculiar to Judæa, as he had not observed it further north than Nabalus. It is, however, common in the countries farther east, where wood is scarce. The streets are narrow, seldom more than two or three yards in width; the pavement, where one exists, is rough and difficult. The bazaars are to a considerable extent covered, either by some kind of awning, or by arches springing from the tops of the houses and spanning the street. The goods in them are thus secured from the effects of the sun and rain, but the streets are rendered gloomy as well as damp. The shops are well furnished, better indeed than those of towns of the same class in Egypt, and the commodities are of a very similar description. The only display of local manufactures is the produce of the glass-works, for which the place has long been celebrated in these parts. The articles manufactured consist almost exclusively of glass lamps, many of which are exported to Egypt, and rings of coloured glass

worn by females on the arms. Gates are placed not only at the entrance of the city, but in different parts of the interior, and are closed at night for the better preservation of order, as well as to prevent communication between the different quarters. This is a rude contrivance much resorted to in Eastern towns from the want of an efficient ambulatory night-watch.

There are nine mosques in Hebron, none of which possess any architectural or other interest, with the exception of the massive structure which is built over the tombs of the patriarchs. This is esteemed by the Moslems one of their holiest places, and Christians are rigorously excluded from it. The only Europeans who have found their way to the interior are Ali Bey and Giovanni Finati, the Italian servant of Mr. Bankes. The best account of it, from whatever source derived, is that furnished by the Rev. V. Monro, who states that 'the mosque, which covers the cave of Machpelah, and contains the patriarchal tombs, is a square building with little external decoration, at the south end of the town. Behind it is a small cupola, with eight or ten windows, beneath which is the tomb of Esau, excluded from the privilege of lying among the patriarchs. Ascending from the street, at the corner of the mosque, you pass through an arched way by a flight of steps to a wide platform, at the end of which is another short ascent; to the left is the court, out of which, to the left again, you enter the mosque. The dimensions within are about forty paces by twenty-five. Immediately on the right of the door is the tomb of Sarah, and beyond it that of Abraham, having a passage between them into the court. Corresponding with these, on the opposite side of the mosque, are those of Isaac and Rebekah, and behind them is a recess for prayer, and a pulpit. These tombs resemble small huts, with a window on each side and folding-doors in front, the lower parts of which are of wood, and the upper of iron or bronze bars plated. Within each of these is an imitation of the sarcophagus which lies in the cave below the mosque, which no one is allowed to enter. Those seen above resemble coffins with pyramidal tops, and are covered with green silk, lettered with verses from the Koran. The doors of these tombs are left constantly open; but no one enters those of the women—last, men do not. In the mosque is a baldakin, supported by four columns, over an octagonal figure of black and white marble inlaid, around a small hole in the pavement, through which a chain passes from the top of the canopy to a lamp continually burning to give light in the cave of Machpelah, where the actual sarcophagi rest. At the upper end of the court is the chief place of prayer; and on the opposite side of the mosque are two larger tombs, where are deposited the bodies of Jacob and Leah' (*Summer's Ramble*, i. 245). The cave itself he does not describe, nor does it appear that even Moslems are admitted to it; for Ali Bey (a Spaniard travelling as a Moslem) does not even mention the cave below while describing the shrines of the mosque. John Sanderson (A.D. 1601) expressly says that none might enter, but that persons might view it, as far as the lamp allowed, through the hole at the top, Moslems being furnished with more light for the purpose than Jews. At an earlier period, however, when the

Holy Land was in the power of the Christians, access was not denied; and Benjamin of Tudela says that the sarcophagi above ground were shown to the generality of pilgrims as what they desired to see; but if a rich Jew offered an additional fee, an iron door is opened, which dates from the time of our forefathers who rest in peace, and with a burning taper in his hands the visitor descends into a first cave, which is empty, traverses a second in the same state, and at last reaches a third, which contains six sepulchres, those of Abraham, Isaac, and Jacob, and of Sarah, Rebekah, and Leah, one opposite the other. All these sepulchres bear inscriptions, the letters being engraved; thus upon that of Abraham: "This is the sepulchre of our father Abraham, upon whom be peace;" even so upon that of Isaac and all the other sepulchres. A lamp burns in the cave and upon the sepulchres continually, both night and day; and you there see tubs filled with the bones of Israelites; for it is a custom of the house of Israel to bring hither the bones and relics of their forefathers, and leave them there, unto this day' (*Itinerary*, i. 77; ed. Asher, Berlin, 1840). The identity of this place with the cave of Machpelah is one of the few local traditions in Palestine which even Dr. Robinson suffers to pass without dispute, and may therefore be taken for granted.

The court in which the mosque stands is surrounded by an extensive and lofty wall, formed of large stones, and strengthened by square buttresses. This wall is the greatest antiquity in Hebron, and even Dr. Robinson supposes that it may be substantially the same which is mentioned by Josephus (*Antiq.* i. 14; *De Bell. Jud.* iv. 9. 7), and by Eusebius and Jerome (*Onomast.* s. v. *Arboch*) as the sepulchre of Abraham. The enclosed structure is usually ascribed to the empire Helena; but Dr. Robinson thinks it more likely to have been erected by the Crusaders, and that till their time no building existed within the great wall. If, however, we rightly understand the Rabbi Benjamin, he says there was a synagogue here under the Moslems (before the Crusades); but he certainly ascribes to the Gentiles (Christians) the six sepulchres which appear above ground. If this were so, they have since been renewed by the Moslems, as those which now exist are, as described, quite similar to the Moslem shrines of Jewish saints which the present writer has seen in countries where Christians never had power. A common Moslem tomb in the neighbourhood of Hebron passes as the tomb of Abner. He was certainly interred in this city (2 Sam. iii. 32); and the head of Ishbosheth, after his assassination, was deposited in the same sepulchre (2 Sam. iv. 12); but there is slight evidence in favour of the tradition which professes to point out this locality to the modern traveller.

Besides this venerable wall, there is nothing at Hebron bearing the stamp of antiquity, save two reservoirs for rain water outside the town. One of these is just without the southern gate in the bottom of the valley. It is a large basin, 133 feet square, and 21 feet 8 inches deep. It is built with hewn limestone of very solid workmanship, and obviously of ancient date. The depth of water of course varies at different times of the year: in May, it is 14 feet. The descent is by flights of steps at the four corners, by which the

water is brought up in vessels and skins, and poured out into troughs for the flocks, or carried away for domestic uses. Just at the north end of the main part of the town is another and smaller pool, also occupying the bed of the valley, and measuring 85 feet by 55, with a depth of 18½ feet, containing (in May) 7 feet of water. These cisterns, which are connected with no perennial springs, and which are filled only by the rains, seem (at least in summer) to be the main dependence of the inhabitants for water, although that of the larger pool is neither clear nor clean. As these pools are doubtless of high antiquity, one of them is in all likelihood the 'pool of Hebron' over which David hanged up the assassins of Ishbosheth (2 Sam. iv. 12).

The present population of Hebron has not been clearly ascertained. Monro heard it called 10,000, but thought half that number more probable. Dr. Robinson, however, was inclined to receive the larger number; but Dr. Olin was assured by the resident Jewish chief rabbi that it did not exceed 4000 or 5000; and as the Jews at Hebron are mostly Europeans, their information is of more value than that of Asiatics, who have a singular vacancy of ideas in numerical computations. Mr. Stent also states the population at 5000, on the authority of Bishop Alexander's chaplain at Jerusalem (*Egypt and Holy Land*, ii. 113). Most of the inhabitants are Moslems, of fierce and intolerant character. There are no resident Christians. The Jews amount to about one hundred families, mostly natives of different countries of Europe, who have emigrated to this place for the purpose of having their bones laid near the sepulchres of their illustrious ancestors. They have two synagogues and several schools. As usual, they have a quarter of the city to themselves, where the streets are narrow and filthy, and the houses mean. In a few instances, however, they are in tolerable repair and whitewashed—a circumstance which Dr. Olin judged peculiar to Hebron, as he had not observed it elsewhere.

The environs of Hebron are very fertile. Vineyards and plantations of fruit-trees, chiefly olive-trees, cover the valleys and arable grounds; while the tops and sides of the hills, although stony, are covered with rich pastures, which support a great number of cattle, sheep, and goats, constituting an important branch of the industry and wealth of Hebron. The hill country of Judah, of which it is the capital, is indeed highly productive, and under a paternal government would be capable of sustaining a large population. That it did so once, is manifest from the great number and extent of ruined terraces and dilapidated towns. It is at present abandoned, and cultivation ceases at the distance of two miles north of the town. The hills then become covered with prickly and other stunted trees, which furnish Bethlehem and other villages with wood. See the various travellers above named as having visited Hebron, and in particular, Dr. Robinson, Dr. Olin, Rev. V. Monro, and Schubert.

HEDUOSMON (Gr. *ἡδύοσμον*, i. e. having a sweet smell), translated *mint*, is mentioned in Matt. xxiii. 23: 'Woe unto you, Scribes and Pharisees, hypocrites! for ye pay tithes of *mint* and anise (properly *dill*) and cummin, and have omitted the weightier matters of the law; and, again, in Luke xi. 42: 'But woe unto you, Pha-

rises! for ye tith *mint* and rue, and all manner of herbs, and pass over judgment and the love of God: these ought ye to have done, and not to leave the other undone.' All the plants mentioned in the above passages belong to the smaller ones cultivated in gardens in Europe, and which usually come under the denomination of sweet herbs. Lady Calcott inquires whether mint was one of the bitter herbs which the Israelites ate with the Paschal Lamb; and infers the probability of its being so from our own practice of eating lamb with mint sauce. Dr. Harris argues that mint, anise, and cummin were not tithed, and that the Pharisees only paid tithes of these plants from an overstrained interpretation of the law. But, in the article ANETHON (DILL), it may be seen that dill was tithed, and it is one of the herbs mentioned along with mint. The meaning, therefore, seems to be, that the Pharisees, while, in conformity with the law, they paid these minute tithes, neglected the most important moral duties,—truth, justice, and mercy; for it is added, 'these ought ye to have done, and not to leave the other undone.'

336. [*Mentha sylvestris*.]

The plant ἡδύσμος or ἡδύσμων, so called 'ab odoris bonitate vel jucunditate,' was also called *μίνθα* and *μίνθος* by the Greeks, and *mentha*, or *menta*, by the Romans. The Arabs give *minthee*

as the Greek synonyme of their نَعْنَاع *nana*; and

in India, Persian works give *podeena* as the Hindee name of the latter. *Podeena* is the common name of a species of mint cultivated in the gardens of North-Western India. These names are interesting as occurring in works on *Materia Medica*; because both were employed by early translators as the equivalent of ἡδύσμων in the above passages of Matthew and Luke; and all European translators, according to Celsius, concur in considering *mint* as intended. The species most common in Syria is *mentha sylvestris*, found by Russell at Aleppo, and mentioned by him as one of the herbs cultivated in the gardens

there. It also occurs in Greece, Taurus, Caucasus, the Altai Range, and as far as Cashmere, whence we have obtained specimens. *M. arvensis*, of which *M. sativa* (Linn.) is one of the varieties, is also a widely diffused species, being found in Greece, in parts of Caucasus, in the Altai Range, and in Cashmere. Mint is highly esteemed in Eastern countries, and apparently was so also by the Jews. Celsius says, 'Paretus olus fuisse in Judæa quondam notum, et Judæis ob virtutes et præstantiam singularem acceptissimum.' It was much esteemed by the ancients, as Pliny (*Hist. Nat.* xix. 47) testifies: 'Mentæ nomen suavitas odoris apud Græcos mutavit, cum alioqui mintha vocaretur: unde veteres nostri nomen declinaverunt. Grato menta mensas odore percurrit in rusticis dapibus; and again (xx. 53), 'Mentæ ipsius odor animum excitat et sapor aviditatem in cibis, ideo embammatum mixturæ familiaris.' Dioscorides also (iii. 41) mentions it as useful to the stomach, and peculiarly grateful as a condiment. Mint was employed by the ancients in the preparation of many dishes. 'Hinc in Apicii libro coquinario, singulis fere paginis menthæ tam viridis, quam aridæ, mentio' (Cels. *Herobot.* i. p. 516). 'Sic apud Ebræos in cibis receptam fuisse mentham manifeste tradunt Talmudici Tract. *Shem. Ve Jobel*, vii. 2; et Tract. *Oketzin*, i. 2; *Sheb.* vii. 1. Unde et olerum decimationi subjecta fuit' (Ib. p. 517).

It is difficult to determine the exact species or variety of mint employed by the ancients. There are numerous species very nearly allied to one another. They usually grow in moist situations, and are herbaceous, perennial, of powerful odour, especially when bruised, and have small reddish-coloured flowers, arranged in spikes or whorls. The taste of these plants is bitter, warm, and pungent, but leaving a sensation of coolness on the tongue: in their properties they are so similar to each other, that either in medicine, or as a condiment, one species may safely be substituted for another. But the species *M. sylvestris* and *M. arvensis*, which have been mentioned above, probably yielded the varieties cultivated in Palestine.—J. F. R.

HEIFER. RED. [SACRIFICE.]

HEIR. [BIRTHRIGHT; INHERITANCE.]

HELBON (הֶלְבוֹן; Sept. Χελβών), or CHELBON, a name which occurs only in Ezek. xxvii. 18, where 'the wine of Helbon' is named among the commodities brought to the great market of Tyre. The Syriac, Symmachus, the Chaldee, and Vulgate, all regard the word as an appellative descriptive of the quality of the wine as 'pingue vinum' or 'vinum dulce coctum.' But it is better to accept the indication of the Septuagint, which, by giving the proper name Χελβών, must be supposed to have had in view that old city of Syria which appears under the form of Chalybon (Χαλυβών) in Ptolemy (*Geog.* v. 15) and Strabo (xv. p. 505). The latter author mentions this Chalybon as a place famous for wine; and in describing the luxury of the kings of Persia, he says they would have wheat brought from Assos in Æolia, Chalybonian wine out of Syria, and water from the Eulaus (the river Ulai of Dan. viii. 2), which was the lightest of any. Athenæus repeats the fact of the kings of Persia drinking only the Chalybonian wine (*Sympos.* i. 22).

Now, it is generally agreed that the ancients

Chalybon is represented by the modern Aleppo. At the present time, when the prohibitions of the Moslem religion occasion much neglect in respect to wines, we can merely judge by comparison of the qualities of the ancient wines in these parts. Thevenot, however, informs us that a strong wine is made from the grapes of Aleppo (*Travels*, part i. p. 25); and Russell (*Nat. Hist. of Aleppo*, i. 80) states that although the white wines are thin and poor, and difficult to keep, the red wine,

which is deep-coloured, is strong and heady, and more apt to produce drowsiness than to raise the spirits. But one third part of the white wine mixed with two of the red produces a liquor tolerably palatable, and much lighter than the red wine by itself. This wine is preferred by the Europeans, who use it when the wines of Provence (their usual beverage) happen to be scarce.

Aleppo, styled by the natives Haleb, is situated in N. lat. 36° 11' 25'', E. long. 37° 9', and



337. [Aleppo.—Helbon.]

is seventy-six miles from the sea by way of Scanderoon, in a straight line, and ninety miles by way of Antioch. It is one of the few ancient cities of these parts which have retained their ancient importance; and this it owes to its happy position upon the line of the commercial intercourse of Asia Minor and Syria with Egypt, and of Europe and Westernmost Asia with the countries beyond the Euphrates. It seems to have risen to commercial importance on the decline of Palmyra, to which 't succeeded. It is indeed remarkable that the earliest mention of the place, in Ezekiel, occurs in a commercial connection, and in the same connection it would probably be mentioned at the present day. As the town is only once named, and then only with reference to its wine, and as no Biblical interest is attached to it, we must refer to general or geographical dictionaries for an account of its history and present condition. It may suffice to indicate that it has long ranked as the capital of Syria, and as the third, if not the second city of the Ottoman empire. It has suffered dreadfully from earthquakes at different times, and has never recovered the terrible visitation of this kind which it sustained in 1822: the population, which was formerly reckoned above 200,000, is not supposed to reach half that number at present.

HELIOPOLIS. [On.]

HELL. Much that belongs to this subject has already been considered under the head HADES. It is there shown that hell is represented by the word הַשְׁאוֹל (*Sheol*) in the Old and by αἵδης (*Hades*) in the New Testament. But as both these words mean also the grave or the condition of the dead, hell, as the place of final punishment for sinners, is more distinctively indicated by the term Gehenna (γέεννα), which is the word translated 'hell' in Matt. v. 22, 29, 30; x. 28; xviii. 9; xxiii. 15, 33; Mark ix. 43, 45, 47; Luke xii. 5; James iii. 6. It is also distinctively indicated by such phrases as 'the place of torment' (Luke xvi. 28); 'everlasting fire' (Matt. xxv. 41); 'the hell of fire, where the worm dieth not, and the fire is not quenched' (Mark ix. 44). The dreadful nature of the abode of the wicked is implied in various figurative expressions, such as 'outer darkness,' 'I am tormented in this flame,' 'furnace of fire,' 'unquenchable fire,' 'where the worm dieth not,' 'the blackness of darkness,' 'torment in fire and brimstone,' 'the ascending smoke of their torment,' 'the lake of fire that burneth with brimstone' (Matt. viii. 12; xiii. 42; xxii. 13; xxv. 30; Luke xvi. 24; comp. Matt. xxv. 41;

Mark ix. 43-48; Jude 13; comp. Rev. xiv. 10, 11; xix. 20; xx. 14; xxi. 8). The figure by which hell is represented as burning with fire and brimstone is probably derived from the fate of Sodom and Gomorrah, as well as that which describes the smoke as ascending from it (comp. Rev. xiv. 10, 11, with Gen. xix. 24, 28). To this coincidence of description Peter also most probably alludes in 2 Pet. ii. 6.

The names which in many of the other instances are given to the punishments of hell, are doubtless in part figurative, and many of the terms which were commonly applied to the subject by the Jews are retained in the New Testament. The images, it will be seen, are generally taken from death, capital punishments, tortures, prisons, &c. And it is the obvious design of the sacred writers, in using such figures, to awaken the idea of something terrible and fearful. They mean to teach that the punishments beyond the grave will excite the same feelings of distress as are produced on earth by the objects employed to represent them. We are so little acquainted with the state in which we shall be hereafter, and with the nature of our future body, that no strictly literal representation of such punishments could be made intelligible to us. Many of the Jews, indeed, and many of the Christian fathers, took the terms employed in Scripture in an entirely literal sense, and supposed there would be actual fire, &c. in hell. But from the words of Christ and his apostles nothing more can with certainty be inferred than that they meant to denote great and unending miseries.

The punishments of sin may be distinguished into two classes—1. *Natural* punishments, or such as necessarily follow a life of servitude to sin: 2. *Positive* punishments, or such as God shall see fit, by his sovereign will, to inflict.

1. Among the natural punishments we may rank the privation of eternal happiness (Matt. vii. 21, 23; xxii. 13; xxv. 41; comp. 2 Thess. i. 9); the painful sensations which are the natural consequence of committing sin, and of an impenitent heart; the propensities to sin, the evil passions and desires which in this world fill the human heart, and which are doubtless carried into the world to come. The company of fellow-sinners and of evil spirits, as inevitably resulting from the other conditions, may be accounted among the natural punishments, and must prove not the least grievous of them.

2. The positive punishments have been already indicated. It is to these chiefly that the Scripture directs our attention. 'There are but few men in such a state that the merely natural punishments of sin will appear to them terrible enough to deter them from the commission of it. Experience also shows that to threaten positive punishment has far more effect, as well upon the cultivated as the uncultivated, in deterring them from crime, than to announce, and lead men to expect, the merely natural consequences of sin, be they ever so terrible. Hence we may see why it is that the New Testament says so little of natural punishments (although these beyond question await the wicked), and makes mention of them in particular far less frequently than of positive punishments; and why, in those passages which treat of the punishments of hell, such ideas and images are constantly employed as suggest

and confirm the idea of positive punishment' (Knapp's *Christian Theology*, § 156).

As the sins which shut out from heaven vary so greatly in quality and degree, we should expect from the justice of God a corresponding variety both in the natural and the positive punishments. This is accordingly the uniform doctrine of Christ and his apostles. The more knowledge of the divine law a man possesses, the more his opportunities and inducements to avoid sin, the stronger the incentives to faith and holiness set before him, the greater will be his punishment if he fails to make a faithful use of these advantages. 'The servant who knows his lord's will and does it not, deserves to be beaten with many stripes': 'To whom much is given, of him much will be required' (Matt. x. 15; xi. 22, 24; xxiii. 15; Luke xii. 48). Hence St. Paul says that the heathen who acted against the law of nature would indeed be punished; but that the Jews would be punished more than they, because they had more knowledge (Rom. ii. 9-29). In this conviction, that God will, even in hell, justly proportion punishment to sin, we must rest satisfied. We cannot now know more; the precise degrees as well as the precise nature of such punishments are things belonging to another state of being, which in the present we are unable to understand (Knapp's *Christian Theology*, translated by Leonard Woods, Jun., DD., §§ 156-158; Storr and Flatt's *Biblical Theology*, with Schmucker's Additions, § iii. 58).

HELLENIST (Ἑλληνιστής). This word is derived from the Greek verb ἐλληνίζω, which in Aristotle means 'to talk (good) Greek' (*Rhetoric*, iii. 5. 1; 12. 1); but, according to the analogy of other verbs in —ίζω, it might mean 'to favour the Greeks,' or 'to imitate Greek manners.' In the New Testament it seems to be appropriated as the name of those persons who, being of Jewish extraction, nevertheless talked Greek as their mother-tongue; which was the case generally with the Jews in Egypt, Syria, Asia Minor, and Greece; and in fact, through the influence of the Greek cities in northern Palestine (Decapolis), it would appear that the Galileans from their childhood learned nearly as much Greek as Hebrew. The appellation *Hellenist* is opposed to that of *Hebrew* in Acts vi. 1: in Acts ix. 29 the reading is not so certain, yet probably it should there also be 'Hellenists,' meaning unconverted Jews. Modern critics have accordingly agreed to denominate the Jewish dialect of Greek 'Hellenistic;' and, whatever name be used, the thing itself ought to be distinctly conceived of.

The Greeks who conquered the Persian empire spoke many different dialects; and the leading nation, the Macedonians, were too deficient in literary pretensions to give an exclusive currency to their own idiom. A necessary result of this was, that even in the written style the current Greek became more or less a compound of several dialects; and much more must this have happened to the speech which foreigners learned to talk as Greek. They could not discriminate Ionic and Macedonian words and phrases from those of Attica; and while they fused the language into a new mould, they would also fail to learn the niceties of Greek grammar, and the peculiarities of its genius. Add to this, that each separate people was of course liable to introduce its

own idioms into the Greek—a source of corruption less influential perhaps in the case of those languages (such as Phrygian and Persian) which belonged to the Indo-European stock, but which in the case of the Jews must have been peculiarly powerful, both because of the eminent contrast between the genius of their tongue and that of the Greek, and because their national literature had taken so deep a hold. In consequence, so similar in style are most parts of the New Testament and of the Apocrypha to the Old Testament, that even the best scholar would fail of finding out from the English translation, close as it is, in which of the two languages the original was written.

The last remark, however, has its exceptions; for in the Hellenistic Greek the Jewish element is not always equally predominant. As might naturally be expected, it is generally found to be most abundant in the translations from Hebrew, such as the Alexandrine Version of the Old Testament and the first book of Maccabees. The Apocalypse, of all original compositions in Greek, though full of natural eloquence, is the most thoroughly Hebraic, and most violates the laws of Greek grammar. Next to it, the three first Gospels and the first half of the Acts may be fitly reckoned, and perhaps after these the Gospel and Epistles of John. Still more vigorous and natural Greek is found in the Catholic Epistles and in those of Paul; better still is the latter half of the Acts, and the preface to the third Gospel, which is nearly or quite on a par with the Epistle to the Hebrews. The book called The Wisdom of Solomon, and the second book of Maccabees, are likewise written in a Greek decidedly superior to the common Hellenistic style. But from all other Jewish writers Josephus and Philo are separated by a long interval. Their studies led them to a close perusal of classical authors, whose idiom they have anxiously imitated, and with much success.

Every such arrangement as has been just given must be liable to objections. We cannot, for instance, draw so sharp a line between the first and second half of the Acts of the Apostles as may seem to be implied. No writer of the New Testament has so great inequality of style as Luke; of which a more striking illustration is not needed than the sudden change from the preface of his Gospel to the actual narrative. It seems impossible to assign this to any other cause than his having worked up into his own account the very words and sentences of those from whom he gained his information, though he has done this in such a way that here and there a better Greek phraseology seems to come out. In the latter part of the Acts, where he is describing what he himself saw, the style is almost free from Jewish idiom, and, though not perfectly the language of European Greece, is yet deeply imbued with its spirit. Again, it is not easy to decide in what place we should rank the Gospel and Epistles of John. In them we complain of meagreness of vocabulary and general monotony. In Matthew, Mark, and Luke the genius of the Hebrew language obtrudes itself, on the whole, more than in John, and yet the style of John is rather to be called less Hebraic than more Greek. This may be plausibly ascribed to his long absence from Palestine and from Hebrew influences, and to the absorption of his mind in contemplations peculiarly his own. Once more,

the Epistles of Peter, James, and Jude contain a profusion of Ionic or poetical words, beyond what can have entered into the spoken tongue, and scarcely to be paralleled in the contemporaneous prose Greek. It might almost seem that the writers (as often happens to foreigners learning our language, or indeed to half-educated persons) had never learned to feel the difference between the poetical and the common diction. In this respect these Epistles may be judged hardly as good Greek as those of Paul: still they have, in common with his, a certain freedom, fluency, and vigour; and their differences may be ascribed to peculiarities rather of mind than, strictly speaking, of dialect.

It belongs to a grammar to detail all that distinguishes the Greek of the New Testament (see Winer's excellent *Grammatik des neu-testamentlichen Sprach-idioms*). But in fact, by knowing Hebrew and Greek, it might almost have been predicted what sort of errors and defects would exist in the degenerate tongue. Whatever specially characterizes the Greek would be ill-learned or lost, such as the use of numerous particles, the sequence of moods and tenses, the multifarious use of the participles, the delicate proprieties of prepositions and their cases. It was to be expected that a part of the vocabulary would never be learned at all, and another large part be slightly misapplied; that Hebrew secondary and metaphorical senses would be obtruded on Greek words; that various new vocables or compounds would arise, not always generated according to a sound analogy; that in the structure of sentences the tame uniform concatenated Hebraic idiom would, to a great extent, supersede the periodic and varying form of the Greek sentence, flexible for rhetorical energy or logical perspicuity; and (as an indication of the fact) that the conjunction *and* would predominate over all others. This is exactly what has occurred. A still further step is a neglect of the common laws of concord, which, however, is generally restricted within narrow limits. Only in the Apocalypse do we meet with very gross instances of it; such as, *ἀπὸ Ἰησοῦ Χριστοῦ, ὁ μάρτυς ὁ πιστός* (i. 5); *τὴν γυναικα ἢ λέγουσα* (ii. 20); *τῷ ἀγαπήσαντι ἡμᾶς, καὶ ἐποίησεν ἡμᾶς, ἵνα ποιήσαντι* (i. 5, 6). The repetition also of the pronoun, as in the last instance, so natural to the Hebrew, is slavish in the Greek. Once only (and that not without dispute) is an instance found of the singular idiom which technical grammar has denominated *iu* Hebrew *Vau conversive*; viz. *καὶ ἐτελέσθη* in *τελεσθήσεται* (x. 7). In the Greek of the New Testament generally the optative mood is observed to be very rare; which appears as the first stage of the process by which it has vanished in modern Greek. So too, instead of the participle, the infinitive is substituted in Hebrew fashion; which often gives an ungraceful stiffness to passages otherwise well written. As a single instance, in James iii. 3, *ἰδοὺ, τῶν ἰππῶν τοὺς χαλινούς εἰς τὰ στόματα βάλλομεν πρὸς τὸ πείσθαι αὐτοὺς ἡμῶν* . . . down to *βάλλομεν* the Greek is good, and suited to the elevated tone of the writer, but the words which follow spoil it to a classical ear.

The Epistle to the Hebrews differs from all the other compositions of the New Testament, in being the writing of one who has evidently spent much pains on the cultivation of his style. With a few

exceptions, it is scarcely more thoroughly idiomatic than the 27th chapter of the Acts; but it is full of indications that the writer had not only moved in circles where good Greek was talked, but had studied well-written models, and aimed to imitate them. In point of mere style it may be fairly compared with the Wisdom of Solomon (although the *subject* of the latter book often throws the sentences into a more Hebrew form); and in fact both appear to exhibit sufficient marks of the Alexandrian culture.

It has been thought unnecessary here to enter into detail concerning the old controversies between the Purists, who tried to prove that all the Greek of the New Testament was classical, and the Hebraists, who overdid the opposite argument (Winer's *Gram.* § 1, edit. of 1836); for on this subject there are no longer two opinions amongst the learned.

The fact that so large a portion of the Jewish nation was Hellenistic, was destined to work great results on the Christian cause. Indeed, in some sense, Christianity itself may be said to have had its human birth among Hellenists, since Jesus himself and the majority of his disciples were reared in Galilee, and were probably nearly as familiar with the Greek as with the Hebrew tongue. Nevertheless, during the early times which followed the day of Pentecost, no striking result appears from this, except that it must have facilitated communication with the Jews of the dispersion. The important part which the Hellenists were to sustain, was first indicated by the preaching of Stephen; who discerned the lower place which must be assigned to the national law of Moses in the kingdom of Messiah. Stephen, indeed, was abruptly cut off by the odium which his principles caused; but the same were soon after adopted, and yet more efficiently inculcated, by his persecutor Saul, to whom the high office was allotted of establishing the peculiar system of doctrine which thenceforward distinguished the Gentile from the Jewish church. The Epistle of James (whether written, as Neander thinks, before the development of the Pauline views or not) exhibits to us undoubtedly the state of Christian doctrine in the mother-church of Jerusalem. We see in it the higher spirit of Christ struggling to put down the law into its right place, but having by no means as yet brought out into their full clearness the distinguishing doctrines of the gospel. All of these were preached and established by Paul in his own churches, founded among Gentile proselytes to Hellenistic Judaism, and from them in no long time were imbibed by all Gentile Christendom. But, simultaneously, the struggle began within the church itself between the Hebraic and the Hellenistic spirit. The (so-called) first council at Jerusalem (Acts xv.) decided, for the time at least, that the Mosaic law was not to be enforced upon the Gentiles, but it did not lessen the importance of it to Jewish Christians; and it would appear that the Hebrew spirit became afterwards even stronger still within the Jerusalem church, if we may interpret literally the words of James (Acts xxi. 20):—'Thou seest, brother, how many thousands of Jews there are which believe, and they are all zealous of the law.' At any rate it appears certain that the resistance to the Pauline doctrine continued intense in the

great body of the Hebrew Christians; for they show themselves in ecclesiastical history only under the names of Nazarenes and Ebionites, and are always regarded as (more or less) heretical by the Gentile churches, since they held only the bare rudimental creed on which the original Pentecostal church was founded; and pertinaciously rejected the distinguishing tenets of Paul, which were confirmed by Peter, and perhaps extended by John. This first and greatest of controversies ended in the extinction of the Hebrew churches, which had refused to grow with the growth of the Christian spirit in its highest and most favoured leaders. But long before that event the Hellenistic Jews had been swallowed up in the mass of Gentile believers; and to follow the further development of the Grecian mind within the bosom of Christianity, belongs, not to this article, but to a history of Gentile Christendom.

F. W. N.

HELMET. [ARMS; ARMOUR.]

HELPS (ἀντιλήψεις; Vulg. *opulationes*; I Cor. xii. 28). The Greek word, signifying aids or assistances, has also this meaning, among others, in the classical writers (e. g. Diad. Sic. i. 87). In the Sept. it answers to עֲזָרָה (Ps. xxii. 19), to עֲזָרָה (Ps. cviii. 12), and to עֲזָרָה (Ps. lxxxiii. 8). It is found in the same sense, Ecclus. xi. 12; 2 Macc. xi. 26; and in Josephus (*De Bell. Jud.* iv. 5 1). In the New Testament it occurs once, viz. in the enumeration of the several orders or classes of persons possessing miraculous gifts among the primitive Christians (*ut supra*), where it seems to be used by metonymy, the abstract for the concrete, and to mean *helpers*; like the words *δυνάμεις*, 'miracles,' i. e. *workers of miracles*; *κυβερνήσεις*, 'governments,' that is, *governors*, &c., in the same enumeration. The Americans, it is well known, by a similar idiom, call their servants 'helps.' Great difficulty attends the attempt to ascertain the nature of the office so designated among the first Christians. Theophylact explains ἀντιλήψεις by ἀντιχέσθαι τῶν ἀσθενῶν, *helping or supporting the infirm*. And so Gennadius, in *Œcumenius*. But this seems like an inference from the etymology (see Gr. of Acts xx. 35). It has been assumed by some eminent modern writers that the several 'orders' mentioned in ver. 28, correspond respectively to the several 'gifts' of the Spirit enumerated in ver. 8, 9. In order, however, to make the two enumerations tally, it is necessary to make 'divers kinds of tongues' and 'interpretation of tongues,' in the one, answer to 'diversities of tongues' in the other, which, in the present state of the received text, does not seem to be a complete correspondence. The result of the collation is that ἀντιλήψεις answers to 'prophecy;' whence it has been inferred that these persons were such as were qualified with the gift of 'lower prophecy,' to help the Christians in the public devotions (Barrington's *Miscellanea Sacra*, i. 166; Macknight on I Cor. xii. 10-28). Another result is, that 'governments' answers 'to discerning of spirits.' To both these Dr. Hales very reasonably objects, as unlikely, and pronounces this tabular view to be 'perplexed and embarrassing' (*New Analysis*, &c., Lond. 1830, iii. 289). Bishop Horsley has adopted this classification of the gifts and office-bearers, and points out as 'helps,' i. e. persons gifted with 'prophecies or predictions,' such per-

sons as Mark, Tychicus, Onesimus. Vitringa, from a comparison of ver. 28, 29, 30, infers that the ἀντιλήψεις denote those who had the gift of interpreting foreign languages (*De Synag. Vet.* ii. 505, Franque. 1696); which, though certainly possible, as an arbitrary use of a very significant word, stands in need of confirmation by actual instances. Dr. Lightfoot also, according to his biographer, adopted the same plan and arrived at the same conclusion (Strype's *Life of Lightfoot*, prefixed to his *Works*, p. 4, Lond. 1684). But Lightfoot himself explains the word 'persons who accompanied the apostles, baptized those who were converted by them, and were sent to places to which they, being employed in other things, could not come, as Mark, Timothy, Titus.' He observes that the Talmudists sometimes call the

Levites לכהנים מוסערי, 'the helpers of the priests' (vol. ii. p. 781). Similar catalogues of miraculous gifts and officers occur Rom. xii. 6-8, and Eph. iv. 11, 12; but they neither correspond in number nor in the order of enumeration. In the former, 'prophecy' stands first, and in the latter, second; and in the former many of the terms are of wide import, as 'ministering,' while minute distinctions are made between others, as between 'teaching' and 'exhortation,' 'giving' and 'showing mercy.' Other writers pursue different methods, and arrive at different conclusions. For instance, Hammond, arguing from the etymology of the word, and from passages in the early writers, which describe the office of relieving the poor as peculiarly connected with that of the apostles and bishops by the deacons, infers that ἀντιλ. 'denotes a special part of the office of those men which are set down at the beginning of the verse.' He also explains κυβερνήσεις as another part of their office (Hammond, *Comment. in loc.*). Schleusner understands 'deacons who had the care of the sick.' Rosenmüller, 'Diaconi qui pauperibus, peregrinis, ægrotis, mortuis, procurandis præerant.' Bishop Pearce thinks that both these words may have been originally put in the margin to explain δυνάμεις, 'miracles or powers,' and urges that ἀντιλ. is nowhere mentioned as a gift of the Spirit, and that it is not recapitulated in ver. 29, 30: Certainly the omission of these two words would nearly produce exactitude in the recapitulation. Bowyer adopts the same conjecture; but it is without support from MSS. or versions. He also observes that to the end of ver. 28 some copies of the Vulgate add 'interpretationes sermonum,' ἐρμηνείας γλωσσῶν; as also the later Syriac, Hilary, and Ambrose. This addition would make the recapitulation perfect. Chrysostom and all the Greek interpreters consider the ἀντιλ. and κυβερν. as importing the same thing, viz. functionaries so called with reference to the two different parts of their office: the ἀντιλ. superintending the care of the poor, sick, and strangers; the κυβερν. the burial of the dead, and the executorship of their effects, including the care of their widows and orphans, rather managers than governors (Blomfield's *Recensio Synopt.*). After all it must be confessed, with Doddridge, that 'we can only guess at the meaning of the words in question, having no principles on which to proceed in fixing it absolutely' (*Family Expositor*, on 1 Cor. xii. 28). (Alberti, *Glossar.* p. 123; Saicer *Thesaur.* in voc.; Sal-

masius, *De Fœnore Trapezitico*, p. 409; Wolfii *Curæ Philolog.* Basil. 1741.)—J. F. D.

1. HEMAN (חֶמָן; Sept. Αἰμὼν), a person of the tribe of Judah, named with others celebrated for their wisdom, to which that of Solomon is compared (1 Kings iv. 31; 1 Chron. ii. 6). The considerations stated under ΕΤΙΑΝ will distinguish this Heman from the following, with whom he is sometimes confounded.

2. HEMAN, a Kohathite of the tribe of Levi, and one of the leaders of the temple-music as organized by David (1 Chron. vi. 33; xvi. 41, 42). This, doubtless, is the Heman to whom the 88th Psalm is ascribed.

HEMLOCK. [ROSH.]

HERAKLES (Ἡρακλῆς) is mentioned in 2 Macc. iv. 19, as the Tyrian god to whom the Jewish high-priest Jason sent a religious embassy (θεσποί), with the offering of 300 drachmæ of silver. That this Tyrian Hercules (Herod. ii. 44) is the same as the Tyrian Baal, is evident from a bilingual Phœnician inscription found at Malta (described by Gesenius, *Monum. Ling. Phœn.* i. 96), in which the Phœnician words, 'To our Lord, to Melkarth, the Baal of Tyre,' are represented by the Greek Ἡρακλεῖ Ἀρχηγέει. Moreover, Herakles and Astarte are mentioned together by Josephus (*Antiq.* viii. 5. 3), just in the same manner as Baal and Ashtoreth are in the Old Testament. The further identity of this Tyrian Baal with the Baal whom the idolatrous Israelites worshipped, is evinced by the following arguments, as stated chiefly by Movers (*Die Phönizier*, i. 178). The worship of Baal, which prevailed in the time of the Judges, was put down by Samuel (1 Sam. vii. 4), and the effects of that suppression appear to have lasted through the next few centuries, as Baal is not enumerated among the idols of Solomon (1 Kings xi. 5-8; 2 Kings xxiii. 13), nor among those worshipped in Judah (2 Kings xxiii. 12), or in Samaria, where we only read of the golden calves of Jeroboam (1 Kings xii. 28; xv. 26). That worship of Baal which prevailed in the reign of Ahab, cannot, therefore, be regarded as a mere continuation or revival of the old Canaanite idolatry (although there is no reason to doubt the essential identity of both Baals), but was introduced directly from Phœnicia by Ahab's marriage with the Sidonian princess Jezebel (1 Kings xvi. 31). In like manner, the establishment of this idolatry in Judah is ascribed to the marriage of the king with a daughter of Jezebel. (Comp. Josephus, *Antiq.* viii. 13. 1; ix. 6. 6.)

The power of nature, which was worshipped under the form of the Tyrian Hercules, Melkarth, Baal, Adonis, Moloch, and whatever his other names are, was that which originates, sustains, and destroys life. These functions of the Deity, according to the Phœnicians, were represented, although not exclusively, by the sun, the influence of which both animates vegetation by its genial warmth, and scorches it up by its fervour.

Almost all that we know of the worship of the Tyrian Hercules is preserved by the classical writers, and relates chiefly to the Phœnician colonies, and not to the mother-state. The eagle, the lion, and the thumy-fish, were sacred to him, and are often found on Phœnician coins. Pliny expressly testifies that human sacrifices were offered

up every year to the Carthaginian Hercules (*Hist. Nat.* xxxvi. v. 12); which coincides with what is stated of Baal in Jer. xix. 5, and with the acknowledged worship of Moloch.

Movers endeavours to show that Herakles and Hercules are not merely Greek and Latin synonyms for this god, but that they are actually derived from his true Phœnician name. This original name he supposes to have consisted of the syllables ΛΗ (as found in ΛΗ , lion, and in other words), meaning *strong*, and ΚΛ , from ΚΛ , to *conquer*; so that the compound means *Ar conquers*. This harmonizes with what he conceives to be the idea represented by Hercules as the destroyer of Typhonic monsters (*l. c.* p. 430). Melkarth, the Μελίκαρθος of Sanchoniathon, occurs on coins only in the form Μελκάρτη . We must in this case assume that a *kaph* has been absorbed, and resolve the word into Κρητὴς βασιλεύς , *king of the city, πολιοῦχος*. The bilingual inscription renders it by Ἀρχηγέτης ; and it is a title of the god as the patron of the city—J. N.

HERMAS, Ἡρμάς , one of the Christians at Rome, to whom Paul addressed special salutations in his Epistle (Rom. xvi. 14). Of his history and station in life nothing is known. By several writers, ancient and modern, he has been reputed to be the author of a work entitled *The Shepherd of Hermas*, which from its high antiquity and the supposed connection of the writer with St. Paul, has been usually classed with the epistles of the so-called Apostolic Fathers. It was originally written in Greek, but we possess it only in a Latin version (as old as the time of Tertullian), a few fragments excepted, which are found as quotations in other ancient authors. It has been divided by modern editors (for in the manuscript copies there is no such division) into three books; the first consisting of four visions, the second of twelve commands, and the third of ten similitudes. It is called the 'Shepherd' (δ Ποιμήν, *Pastor*), because the Angel of Repentance (*Nuntius Penitentiae*), at whose dictation Hermas professes that he wrote the second and third books, appeared in the garb of a shepherd—'habitu pastorali, pallio albo amictus, peram in humeris, et virgam in manu gestans.' It is doubtful whether the author really believed that he saw the visions he describes, or merely adopted the fiction to render his work more attractive. It is frequently quoted by Clemens Alexandrinus, either by the author's name (*Strom.* i. 29. § 181; *Opp.* ed. Klotz, ii. 119; ii. 1. § 3; *Opp.* ii. 124), or by the phrase 'the Shepherd says' (*Strom.* i. 17. § 85; *Opp.* ii. 60; ii. 12. § 55; *Opp.* ii. 158; ii. 9. § 43; *Opp.* ii. 150; ii. 12. § 55; *Opp.* ii. 158; iv. 9. § 76; *Opp.* ii. 318; vi. 6. § 46; *Opp.* iii. 125), though he does not expressly identify the author as the Hermas in Rom. xvi. Eusebius is more definite. In his *Eccles. Hist.* (iii. 3) he says, 'The apostle, in the salutations at the end of his Epistle to the Romans, makes mention among others of Hermas, who, it is said, wrote the book called the Shepherd; it is to be noted that this book is called in question ($\alpha\upsilon\tau\iota\lambda\acute{\epsilon}\lambda\epsilon\kappa\tau\alpha\iota$), so that it cannot be ranked among the books received as canonical ($\acute{\epsilon}\nu$ $\delta\omicron\mu\omicron\lambda\omicron\gamma\omicron\mu\acute{\epsilon}\nu\omicron\iota\varsigma$). By others it is judged to be a most necessary book for elementary instruction. And we know that it is publicly read in churches, and that some very ancient writers

make use of it.' Elsewhere he says, 'among the spurious ($\acute{\epsilon}\nu$ $\tau\omicron\iota\varsigma$ $\nu\theta\beta\omicron\iota\varsigma$) are to be placed the Acts of Paul, the Book called the Shepherd, and the Revelation of Peter' (*Hist. Eccles.* iii. 25). And in giving an account of the opinions of Irenæus (*Hist. Eccles.* v. 8.), he remarks, 'the book ($\tau\eta\eta$ $\gamma\rho\alpha\phi\eta$) of the Shepherd he not only knew, but received with approbation, saying, Well spake the book (η $\gamma\rho\alpha\phi\eta$) which says, "first of all believe that there is one God."' This passage has been adduced, but, perhaps, improperly, to prove that Irenæus regarded 'The Shepherd' as canonical: the word $\gamma\rho\alpha\phi\eta$, by some here translated *Scripture*, may mean simply the book or writing (Lardner's *Credibility*, ch. xvii.; *Works*, ii. 171). Origen often quotes 'The Shepherd', speaks of it as useful, and, in his opinion, inspired: *ut puto, divinitus inspirata* (*Ep. ad Rom. Comment.* lib. x.; *Opera*, vii. 437, ed. Lommatzsch). Elsewhere he describes it as 'a book circulated in the church, but not universally acknowledged to be divine' (*Comment. in Evang. Matt. Hom.* xiv.; *Opp.* iii. 316). Jerome also states that 'it was publicly read in some of the churches of Greece, though among the Latins it was almost unknown' (*De Illust. Vir.* cap. x). The testimonies of other writers are given by Cotelierius and Fabricius. If it be admitted that 'The Shepherd' was written by the Hermas of St. Paul, its date must be fixed towards the end of the first century. Some eminent critics, however, ascribe it to Hermas, a brother of Pius, who was Bishop of Rome about a.d. 141. Mosheim argues at some length, and with no little vehemence, in favour of this opinion; but the only authorities he adduces on its behalf are some lines in a poem against the Marcionites, falsely attributed to Tertullian, the fragment of an anonymous work on the canon, published by Muratori in his *Antiquitates Ital. Med. Ævi*, and a passage in the *Liber Pontificalis*, respecting Easter, there said to be from a book called the Shepherd, written by Hermas, the brother of Pius, but not found in the work that has come down to us under that title (*Commentaries on the Affairs of the Christians*, vol. i. pp. 180-188, Vidal's transl). The same opinion is advocated by Dr. Hefele, in the *Tübingen Theol. Quart. Schrift.*, 1839. Dr. Neander, while he allows that it may be doubted whether 'The Shepherd' was written by the Hermas of St. Paul, seems to consider the other supposition still more questionable, since we cannot determine what credit is due to the authorities adduced in its favour, and it is difficult to reconcile with the later origination of the work, the high esteem in which it was held in the age of Irenæus and Clement of Alexandria (*Allgemeine Geschichte*, &c. Abth. i. Band 2, p. 1139, 2nd edit.) Impartial judges will probably agree with Mosheim, that 'The Shepherd' contains such a mixture of folly and superstition with piety, of egregious nonsense with momentous truth, as to render it a matter of astonishment that men of learning should ever have thought of giving it a place among the inspired writings.

The Shepherd of Hermas was first published at Paris in 1513, and is included in the editions of the apostolic fathers by Cotelierius, Galland, and Hefele. Fabricius also published it in his *Codex Apocryphus*, Hamburgi, 1719. Archbishop Wake's translation is well known.—J. E. R.

HERMES (Ἑρμῆς), the Mercurius of the Romans, was the messenger of the gods, and was equally characterized by adroitness of action and readiness of speech. He was also the customary attendant of Jupiter when he appeared on earth (Ovid, *Fast.* v. 495). These circumstances explain why the inhabitants of Lystra (Acts xiv. 12), as soon as ever they were disposed to believe that the gods had visited them in the likeness of men, discovered Hermes in Paul, as the chief speaker, and as the attendant of Jupiter. It seems unnecessary to be curious whether the representations of Mercury in ancient statues accord with the supposed personal appearance of Paul, and especially in the matter of the beard of the latter; for all known representations of the god differ in much more important particulars from the probable costume of Paul (*e. g.* in the absence of any garment at all, or in the use of the short chlamys merely; in the caduceus, the petasus, &c.). It is more reasonable to suppose that those who expected to see the gods mixing in the affairs of this lower world, in human form, would not look for much more than the outward semblance of ordinary men. Comp. the 'dissimulantque deos' of Ovid (*l. c.* 504.)—J. N.

HERMOGENES (Ἑρμογένης) and PHYGGELLUS, disciples of Asia Minor, and probably companions in labour of St. Paul. They abandoned him during his second imprisonment at Rome, doubtless from alarm at the perils of the connection (2 Tim. i. 15).

HERMON (הַרְמֹן; Sept. Ἀερμών), a mountain which formed the northernmost boundary of the country beyond the Jordan which the Hebrews conquered from the Amorites (Deut. iii. 8), and which, therefore, must have belonged to Anti-Libanus, as is, indeed, implied or expressed in most of the other passages in which it is named. In Deut. iii. 9 it is said to have been called by the Sidonians Sirion (שִׁרְיֹן), and by the Amorites, Shenir (שֵׁנִיר), both of which words signify 'a coat of mail.' In the next chapter (iv. 49) it is called Mount Sion (שִׁיֹן), meaning 'an elevation,' 'a high mountain'—which it was well entitled to be designated by way of excellence, being (if correctly identified with Jebel Es-sheikh) by far the highest of all the mountains in or near Palestine. In the later books of the Old Testament, however (as in 1 Chron. v. 23; Sol. Song iv. 8), Shenir is distinguished from Hermon properly so called. Since modern travellers have made us acquainted with the country beyond the Jordan, no doubt has been entertained that the Mount Hermon of those texts is no other than the present Jebel Es-sheikh, or the Sheikh's mountain, or, which is equivalent, Old Man's Mountain, a name it is said to have obtained from its fancied resemblance (being topped with snow, which sometimes lies in lengthened streaks upon its sloping ridges) to the hoary head and beard of a venerable sheikh (Elliot, i. 317). This Jebel Es-sheikh is a south-eastern, and in that direction culminating, branch of Anti-Libanus. It is probably the highest of all the Lebanon mountains, and is thought to rival Mont Blanc, though, as Elliot observes, the high ground on which it stands detracts considerably from its apparent altitude, and makes it a less imposing object than that king of European mountains as viewed from the Italian valley of Aosta. Its top

is covered with snow throughout the summer, and must therefore rise above the point of perpetual congelation, which in this quarter is about 11,000 feet. It might, perhaps, be safe to add another 1000 feet for the height above that point, making in all 12,000 feet; but we must wait the result of more accurate observations than have yet been made. Some statements make it so low as 10,000 feet. Dr. Clarke, who saw it in the month of July, says 'the summit is so lofty that the snow entirely covered the upper part of it, not lying in patches, but investing all the higher part with that perfect white and smooth velvet-like appearance which snow only exhibits when it is very deep.' Dr. Robinson only differs from the preceding by the statement that the snow is perpetual only in the ravines, so that the top presents the appearance of radiant stripes, around and below the summit (*Bib. Researches*, iii. 314). The mention of Hermon along with Tabor in Ps. lxxxix. 12, led to its being sought near the latter mountain, where, accordingly, travellers and maps give us a 'Little Hermon.' But that passage, as well as Ps. cxxxiii. 3, applies better to the great mountain already described; and in the former it seems perfectly natural for the Psalmist to call upon these mountains, respectively the most conspicuous in the western and eastern divisions of the Hebrew territory, to rejoice in the name of the Lord. Besides, we are to consider that Jebel Es-sheikh is seen from Mount Tabor, and that both together are visible from the plain of Esdraelon. There is no reason to suppose that the so-called Little Hermon is at all mentioned in Scripture. Its actual name is Jebel ed-Duh; it is a shapeless, barren, and uninteresting mass of hills, in the north of the valley of Jezreel and opposite Mount Gilboa.

HERODIAN FAMILY. Josephus introduces us to the knowledge of the Herodian family in the fourteenth book of his *Antiquities*. He there tells us (c. i. § 3) that among the chief friends of Hyrcanus, the high-priest, was an Idumæan, named Antipater, distinguished for his riches, and no less for his turbulent and seditious temper. He also quotes an author who represented him as descended from one of the best of the Jewish families which returned from Babylon after the captivity, but adds that this statement was founded on no better grounds than a desire to flatter the pride and support the pretensions of Herod the Great. The times were favourable to men of Antipater's character; and, while he obtained sovereign authority over his native province of Idumæa, he contrived to subject Hyrcanus completely to his will, and to induce him to form an alliance with Aretas, from which he trusted to secure the best means for his own aggrandizement. Having so far accomplished his designs as to make himself the favourite ally of Rome, he obtained for his son Phasælus the governorship of Jerusalem, and for Herod, then only fifteen years old, the chief command in Galilee.

Herod soon distinguished himself by his talents and bravery. The country was at that time infested with numerous bands of robbers. These he assailed and vanquished, and his success was proclaimed, not only throughout Galilee, but in Judæa and the neighbouring countries. This increasing popularity of a member of the family of Antipater alarmed the ruling men at

Jerusalem, and they willingly hearkened to the complaints made against Herod by some of the relatives of those whom he had slain. He was accordingly summoned to take his trial before the Sanhedrim: nor did he disobey the summons; but on the day of trial he appeared at the tribunal gorgeously clad in purple, and surrounded by a numerous band of armed attendants. His acquittal was speedily pronounced. One only of the judges ventured to speak of his guilt, and the venerable old man prophesied that, sooner or later, this same Herod would punish both them and Hyrcanus for their pusillanimity.

In the events which followed the death of Cæsar, Herod found fresh opportunities of accomplishing his ambitious designs. By collecting a considerable tribute from Cassius in Galilee, he obtained the friendship of that general, and was appointed to the command of the army in Syria. No less successful with Marc Antony, he overcame the powerful enemies who represented the dangerous nature of his ambitious views, and was exalted, with his brother Phasælus, to the dignity of tetrarch of Judæa. They had not, however, long enjoyed their office when the approach of Antigonus against Jerusalem compelled them to meditate immediate flight. Phasælus and Hyrcanus fell into the hands of the enemy; but Herod, making good his escape, hastened to Rome, where he pleaded his cause and his former merits with so much skill, that he was solemnly proclaimed king of the Jews, and endowed with the proper ensigns and rights of royalty. Augustus, three years afterwards, confirmed this act of the senate; and Herod himself scrupled not to perpetrate the most horrible crimes to give further stability to his throne. The murder of his wife Mariamne, a daughter of Hyrcanus, and of his two sons Alexander and Aristobulus, place him in the foremost rank of those tyrants whose names blacken the page of history. Of the massacre at Bethlehem the Jewish historian says nothing; but it has been well observed that such an event, in a reign marked by so many horrible deeds, and occurring as it did in a small, obscure town, was not likely to obtain a place in the national annals. As a vain attempt to set aside the purposes of God, it affords a startling instance of the awful follies to which the acutest and most politic of rulers may be tempted by the love of empire. Had Herod not proved, by the acts here alluded to, the little confidence which he felt in himself, or in the actual claims which his courage and ability gave him to dominion, he might have merited the title of Great, conferred on him by his admirers. His reign, prolonged through thirty-seven years, was in many respects prosperous; and the splendour of his designs restored to Jerusalem, as a city, much of its earlier magnificence.

According to the custom of the times, Herod made his sons the heirs to his kingdom by a formal testament, leaving its ratification to the will of the emperor. Augustus assenting to its main provisions, Archelaus became tetrarch of Judæa, Samaria, and Idumæa; Philip, of Trachonitis and Ituræa; and

HEROD ANTIPAS, of Galilee and Peræa. This Herod was first married to a daughter of King Aretas of Arabia; but forming an unholy attachment for Herodias, the wife of his brother Philip, he soon became involved in a course of guilt

which ended in his utter ruin. Aretas, to avenge his daughter, sent a considerable army against Herod, whose generals in vain attempted to oppose its progress. The forces which they led were totally destroyed, and instant ruin seemed to threaten both Herod and his dominions. An appeal to the Romans afforded the only hope of safety. Aretas was haughtily ordered by the emperor to desist from the prosecution of the war, and Herod accordingly escaped the expected overthrow. But he was not allowed to enjoy his prosperity long. His nephew Agrippa having obtained the title of King, Herodias urged him to make a journey to Italy and demand the same honour. He weakly assented to his wife's ambitious representations; but the project proved fatal to them both. Agrippa anticipated their designs; and when they appeared before Caligula they were met by accusations of hostility to Rome, the truth of which they in vain attempted to disprove. Sentence of deposition was accordingly passed upon Herod, and both he and his wife were sent into banishment, and died at Lyons in Gaul.

HEROD AGRIPPA, alluded to above, was the son of Aristobulus, so cruelly put to death by his father Herod the Great. The earlier part of his life was spent at Rome, where the magnificence and luxury in which he indulged reduced him to poverty. After a variety of adventures and sufferings he was thrown into bonds by Tiberius; but on the succession of Caligula was not only restored to liberty, but invested with royal dignity, and made tetrarch of Abilene, and of the districts formerly pertaining to the tetrarchy of Philip. His influence at the Roman court increasing, he subsequently obtained Galilee and Peræa, and at length Judæa and Samaria, his dominion being thus extended over the whole country of Palestine.

To secure the good-will of his subjects, he yielded to their worst passions and caprices. Memorable instances are afforded of this in the apostolic history, where we are told that 'He stretched forth his hands to vex certain of the church, and he killed James, the brother of John, with the sword; and because he saw it pleased the Jews, he proceeded further to take Peter also' (Acts xii. 1-3). His awful death, described in the same chapter, and by Josephus almost in the same words (*Antiq.* xix. 8), occurred in the fifty-fourth year of his age.

HEROD AGRIPPA, the son of the above-named, was in his seventeenth year when his father died. The emperor Claudius, at whose court the young Agrippa was then residing, purposed conferring upon him the dominions enjoyed by his father. From this he was deterred, says Josephus, by the advice of his ministers, who represented the danger of trusting an important province of the empire to so youthful a ruler. Herod was, therefore, for the time, obliged to content himself with the small principality of Chalcis, but was not long after created sovereign of the tetrarchies formerly belonging to Philip and Lyسانias; a dominion increased at a subsequent period by the grant of a considerable portion of Peræa. The habits which he had formed at Rome, and his strong attachment to the people to whose rulers he was indebted for his prosperity, brought him into frequent disputes with his own nation. He

died, at the age of seventy, in the early part of the reign of Trajan.—H. S.

HERODIANS, a class of Jews that existed in the time of Jesus Christ, whether of a political or religious description it is not easy, for want of materials, to determine. The passages of the New Testament which refer to them are the following, Mark iii. 6; xii. 13; Matt. xxii. 16; Luke xx. 20. The particulars are these:—the ecclesiastical authorities of Judæa having failed to entrap Jesus by demanding the authority by which he did his wonderful works, especially as seen in his expurgation of the temple; and being incensed in consequence of the parable spoken against them, namely, 'A certain man planted a vineyard,' &c., held a council against him, and associating with themselves the Herodians, sent an embassy to our Lord with the express but covert design of ensnaring him in his speech, that thus they might compass his destruction. The question they put to him was one of the most difficult—'Is it lawful to pay tribute to Cæsar?' The way in which Jesus extricated himself from the difficulty and discomfited his enemies is well known.

Do these circumstances afford any light as to what was the precise character of the Herodians? Whatever decision on this point may be arrived at, the general import of the transaction is very clear, and of a character highly honourable to Jesus. That his enemies were actuated by bad faith, and came with false pretences, might also be safely inferred. Luke, however, makes an express statement to this effect, saying (xx. 18-20), 'they sought to lay hands on him; and they feared the people; and they watched him, and sent forth spies which should feign themselves just men, that they might take hold of his words, that so they might deliver him unto the power and authority of the governor.' The aim, then, was to embroil our Lord with the Romans. For this purpose the question put had been cunningly chosen. These appear to have been the several feelings whose toils were around Jesus—the hatred of the priests, the favour of the people towards himself, and their aversion to the dominion of the Romans, their half faith in him as the Messiah, which would probably be converted into the vexation and rage of disappointment, should he approve the payment of tribute to Rome; another element of difficulty had in the actual case been deliberately provided—the presence of the Herodians. Altogether the scene was most perplexing, the trial most perilous. But what additional difficulty did the Herodians bring? Herod Antipas was now Tetrarch of Galilee and Peræa, which was the only inheritance he received from his father Herod the Great. As Tetrarch of Galilee he was specially the ruler of Jesus, whose home was in that province. The Herodians then may have been subjects of Herod, Galilæans, whose evidence the priests were wishful to procure, because theirs would be the evidence of fellow-countrymen, and of special force with Antipas as being that of his own immediate subjects (Luke xxiii. 7).

Herod's relations with Rome were in an unsafe condition. He was a weak prince, given to ease and luxury, and his wife's ambition conspired with his own desires to make him strive to obtain from the Emperor Caligula the title of king.

For this purpose he took a journey to Rome, and was banished to Lyons in Gaul.

The Herodians may have been favourers of his pretensions: if so, they would be partial hearers, and eager witnesses against Jesus before the Roman tribunal. It would be a great service to the Romans to be the means of enabling them to get rid of one who aspired to be king of the Jews. It would equally gratify their own lord, should the Herodians give effectual aid in putting a period to the mysterious yet formidable claims of a rival claimant of the crown.

We do not see that the two characters here ascribed to the Herodians are incompatible; and if they were a Galilæan political party who were eager to procure from Rome the honour of royalty for Herod (Mark vi. 14, the name of king is merely as of courtesy), they were chosen as associates by the Sanhedrim with especial propriety.

The deputation were to 'feign themselves just men,' that is, men whose sympathies were entirely Jewish, and, as such, anti-heathen: they were to intimate their dislike of paying tribute, as being an acknowledgment of a foreign yoke; and by flattering Jesus, as one who loved truth, feared no man, and would say what he thought, they meant to inveigle him into a condemnation of the practice. In order to carry these base and hypocritical designs into effect, the Herodians were appropriately associated with the Pharisees; for as the latter were the recognised conservators of Judaism, so the former were friends of the aggrandisement of a native as against a foreign prince.

Other hypotheses may be found in Paulus on the passage in Matt.; in Wolf, *Cura Phil.* i. 311, sq.; see also J. Steuch, *Diss. de Herod.* Lund. 1706; J. Floder, *Diss. de Herod.* Upsal. 1761.—
J. R. B.

HERODIAS. [HERODIAN FAMILY.]

HERON (אָנָפִי) *anaphah*, Lev. xi. 19; Deut. xiv. 18). The original is a disputed name of an unclean bird, which has also been translated kite, woodcock, parrot, and crane. For the first of these

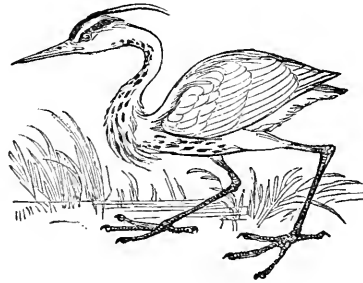

338. [Ardea Herodias.]

see GLEDE; the second is rare and only a momentary visitor in Palestine; the third, surely, required no prohibition where it was not a resident species, and probably not imported till the reign of Solomon; and, as to the crane, we have already shown it to have been likewise exotic, making only a momentary appearance, and that rarely, in Syria, where it is commonly represented by the African species *Grus virgo* (crane). If the Hebrew name be derived from אָנָפִי *anaph*, 'to breathe short,' or 'to sniff through the nostrils with

an irritated expression, the most obvious application would be to the goose, a bird not, perhaps, otherwise noticed in the Hebrew Scriptures, though it was constantly eaten in Egypt, was not held unclean by the Jews, and, at some seasons, must have frequented the lakes of Palestine. The heron, though not so constantly hissing, can utter a similar sound of displeasure with much more meaning, and the common species *Ardea cinerea* is found in Egypt, and is also abundant in the Hauran of Palestine, where it frequents the margins of lakes and pools, and the reedy water-courses in the deep ravines, striking and devouring an immense quantity of fish. The Greek *ἄνοπαλα* (Hom. *Odyss.* i. 320), though in sound resembling *anaphah*, is not, therefore, as Bochart pretends, necessarily a mountain hawk; for then the root could not be taken from *anaph*, unless it applied to one of the smaller species, such as the Kestrel or sparrow-hawk.—C. H. S.

HESHBON (הֶשְׁבֹן; Sept. Ἑσσεβών; Euseb. Ἑσσεβών), a town in the southern district of the Hebrew territory beyond the Jordan, parallel with, and twenty-one miles east of, the point where the Jordan enters the Dead Sea, and nearly midway between the rivers Jabbok and Arnon. It originally belonged to the Moabites; but when the Israelites arrived from Egypt, it was found to be in the possession of the Amorites, whose king, Sihon, is styled both king of the Amorites and king of Heshbon, and is expressly said to have 'reigned in Heshbon' (Josh. iii. 10; comp. Num. xxi. 26; Deut. ii. 9). It was taken by Moses (Num. xxi. 23-26), and eventually became a Levitical city (Josh. xxi. 39; 1 Chron. vi. 81) in the tribe of Reuben (Num. xxxii. 37; Josh. xiii. 17); but being on the confines of Gad, is sometimes assigned to the latter tribe (Josh. xxi. 39; 1 Chron. vi. 81). After the ten tribes were sent into exile, Heshbon was taken possession of by the Moabites, and hence is mentioned by the prophets in their declarations against Moab (Isa. xv. 4; Jer. xlviii. 2, 34, 45). Under King Alexander Jannæus we find it again reckoned as a Jewish city (Joseph. *Antiq.* xiii. 15. 4). In the time of Eusebius and Jerome it was still a place of some consequence under the name of Esbus (Ἑσβός); but at the present day it is known by its ancient name of Heshbon, in the slightly modified form of Hesban. The ruins of a considerable town still exist, covering the sides of an insulated hill, but not a single edifice is left entire. The view from the summit is very extensive, embracing the ruins of a vast number of cities, the names of some of which bear a strong resemblance to those mentioned in Scripture. There are reservoirs connected with this and the other received towns of this region. These have been supposed to be the pools of Heshbon mentioned by Solomon (Cant. vii. 4); but, say Irby and Mangles, 'The ruins are uninteresting, and the only pool we saw was too insignificant to be one of those mentioned in Scripture.' In two of the cisterns among the ruins they found about three dozen of human skulls and bones, which they justly regard as an illustration of Gen. xxxvii. 20 (*Travels*, p. 472; see also Burckhardt, George Robinson, Lord Lindsay, &c.).

HEZEKIAH (הֶזְקִיָּא; Sept. Ἑζεκίας), son of

Ahaz, and thirteenth king of Judah, who reigned from B.C. 725 to B.C. 696.

From the commencement of his reign the efforts of Hezekiah were directed to the reparation of the effects of the grievous errors of his predecessors; and during his time the true religion and the theoretical policy flourished as they had not done since the days of David. The Temple was cleared and purified; the utensils and forms of service were restored to their ancient order; all the changes introduced by Ahaz were abolished; all the monuments of idolatry were destroyed, and their remains cast into the brook Kedron. Among the latter was the brazen serpent of Moses, which had been deposited first in the Tabernacle, and then in the Temple, as a memorial of the event in which it originated; and it is highly to the credit of Hezekiah, and shows more clearly than any other single circumstance the spirit of his operations, that even this interesting relic was not spared when it seemed in danger of being turned to idolatrous uses. Having succeeded by his acts and words in rekindling the zeal of the priests and of the people, the king appointed a high festival, when, attended by his court and people, he proceeded in high state to the Temple, to present sacrifices of expiation for the past irregularities, and to commence the reorganised services. A vast number of sacrifices evinced to the people the zeal of their superiors, and Judah, long sunk in idolatry, was at length reconciled to God (2 Kings xviii. 1-8; 2 Chron. xxxix.).

The revival of the great annual festivals was included in this reformation. The Passover, which was the most important of them all, had not for a long time been celebrated according to the rites of the law; and the day on which it regularly fell, in the first year of Hezekiah, being already past, the king, nevertheless, justly conceiving the late observance a less evil than the entire omission of the feast, directed that it should be kept on the 14th day of the second month, being one month after its proper time. Couriers were sent from town to town, inviting the people to attend the solemnity; and even the ten tribes which formed the neighbouring kingdom were invited to share with their brethren of Judah in a duty equally incumbent on all the children of Abraham. Of these some received the message gladly, and others with disdain; but a considerable number of persons belonging to the *northernmost* tribes (which had more seldom than the others been brought into hostile contact with Judah) came to Jerusalem, and by their presence imparted a new interest to the solemnity. A profound and salutary impression appears to have been made on this occasion; and so strong was the fervour and so great the number of the assembled people, that the festival was prolonged to twice its usual duration; and during this time the multitude was fed abundantly from the countless offerings presented by the king and his vobles. Never since the time of Solomon, when the whole of the twelve tribes were wont to assemble at the Holy City, had the Passover been observed with such magnificence (2 Chron. xxx.).

The good effect of this procedure was seen when the people carried back to their homes the zeal for the Lord which had thus been kindled, and proceeded to destroy and cast forth all the

abominations by which their several towns had been defiled; thus performing again, on a smaller scale, the doings of the king in Jerusalem. Even the 'high places,' which the pious kings of former days had spared, were on this occasion abolished and overthrown; and even the men of Israel, who had attended the feast, were carried away by the same holy enthusiasm, and, on returning to their homes, broke all their idols in pieces (2 Chron. xxxi. 1).

The attention of this pious and able king was extended to whatever concerned the interests of religion in his dominions. He caused a new collection of Solomon's proverbs to be made, being the same which occupy chaps. xxv. to xxix. of the book which bears that name. The sectional divisions of the priests and Levites were re-established; the perpetual sacrifices were recommenced, and maintained from the royal treasure; the stores of the temple were once more filled by the offerings of the people, and the times of Solomon and Jehoshaphat seemed to have returned (2 Chron. xxxi.). These improvements indicate the peculiar nature of the operations required to establish the character of a good prince under the Hebrew theocracy. It was not necessary that he should create new and beneficial institutions; even from the most reforming king it was only required that he should re-establish the old institutions which had fallen into neglect, and to abolish all recent innovations adverse to their principles. Of all people the Hebrews lived most on the memories of the past; and the retrospective character of all their reformations necessarily arose out of the divine authority by which their institutions had been established, and their perfect adaptation to their condition as a peculiar people.

This great work having been accomplished and consolidated (2 Kings xvii. 7, &c.), Hezekiah applied himself to repair the calamities, as he had repaired the crimes, of his father's government. He took arms, and recovered the cities of Judah which the Philistines had seized. Encouraged by this success, he ventured to withhold the tribute which his father had paid to the Assyrian king; and this act, which the result shows to have been imprudent, drew upon the country the greatest calamities of his reign. Only a few years before, namely, in the fourth of his reign, the Assyrians had put an end to the kingdom of Israel and sent the ten tribes into exile; but had abstained from molesting Hezekiah, as he was already their tributary. Seeing his country invaded on all sides by the Assyrian forces under Sennacherib, and Lachish, a strong place which covered Jerusalem, on the point of falling into their hands, Hezekiah, not daring to meet them in the field, occupied himself in all necessary preparations for a protracted defence of Jerusalem, in hope of assistance from Egypt, with which country he had contracted an alliance (Isa. xxx. 1-7). Such alliances were not favoured by the Divine sovereign of Israel and his prophets, and no good ever came of them. But this alliance did not render the good king unmindful of his true source of strength; for in quieting the alarms of the people he directed their attention to the consideration that they in fact had more of power and strength in the divine protection than the Assyrian king possessed in all his host: 'There

is more with us than with him: with him is an arm of flesh, but with us is the Lord our God to help us and fight our battles.' Nevertheless, Hezekiah was himself distrustful of the course he had taken, and at length, to avert the calamities of war, sent to the Assyrian king offers of submission. Sennacherib, who was anxious to proceed against Egypt, consented to withdraw his forces on the payment of three hundred talents of silver and thirty talents of gold; which the king was not able to raise without exhausting both his own treasury and that of the temple, and stripping off the gold with which the doors and pillars of the Lord's house were overlaid (2 Kings xviii. 7-16).

But after he had received the silver and gold, the Assyrian king broke faith with Hezekiah, and continued to prosecute his warlike operations. While he employed himself in taking the fortresses of Judæa, which it was important to secure before he marched against Egypt, he sent three of his generals, Rabshakeh, Tartan, and Rabсарis, with part of his forces, to threaten Jerusalem with a siege unless it were surrendered, and the inhabitants submitted to be sent into Assyria; and this summons was delivered in language highly insulting not only to the king and people, but to the God they worshipped. When the terms of the summons were made known to Hezekiah, he gathered courage from the conviction that God would not fail to vindicate the honour of his insulted name. In this conviction he was confirmed by the prophet Isaiah, who, in the Lord's name, promised the utter discomfiture and overthrow of the blasphemous Assyrian: 'Lo, I will send a blast upon him, and he shall hear a rumour, and shall return to his own land, and I will cause him to die by the sword in his own land' (2 Kings xix. 7). The rumour which Sennacherib heard was of the advance of Tiribakah the Ethiopian to the aid of the Egyptians, with a force which the Assyrians did not deem it prudent to meet; but, before withdrawing to his own country, Sennacherib sent a threatening letter to Hezekiah, designed to check the gladness which his retirement was likely to produce. But that very night the predicted blast—probably the hot pestilential south wind—smote 180,000 men in the camp of the Assyrians, and released the men of Judah from all their fears (2 Kings xviii. 17-37; xix. 1-34; 2 Chron. xxxii. 1-23; Isa. xxxvi. 37).

It was in the same year, and while Jerusalem was still threatened by the Assyrians, that Hezekiah fell sick of the plague; and the aspect which the plague-bill assumed assured him that he must die. In this he was assured by Isaiah, who warned him that his end approached. The love of life, the condition of the country—the Assyrians being present in it, and the throne of David without an heir—caused him to grieve at this doom, and to pray earnestly that he might be spared. And his prayer was heard in heaven. The prophet returned with the assurance that in three days he should recover, and that fifteen additional years of life should be given to him. This communication was altogether so extraordinary, that the king required some token by which his belief might be justified; and accordingly the 'sign' which he required was granted to him. The shadow of the sun went back upon the dial of Ahaz, the ten degrees it had gone down [DIAL.]

This was a marvel greater than that of the cure which the king distrusted; for there is no known principle of astronomy or natural philosophy by which such a result could be produced. A cataplasm of figs was then applied to the plague-boil, under the direction of the prophet, and on the third day, as foretold, the king recovered (2 Kings xx. 1-11; 2 Chron. xxxii. 24-26; Isa. xxxviii.). [PLAGUE].

The destruction of the Assyrians drew the attention of foreign courts for a time towards Judæa, and caused the facts connected with Hezekiah's recovery, and the retrogression of the shadow on the dial, to be widely known. Among others Merodach Baladan, king of Babylon, sent ambassadors with presents to make inquiries into those matters, and to congratulate the king on his recovery. Since the time of Solomon the appearance of such embassies from distant parts had been rare at Jerusalem; and the king, in the pride of his heart, made a somewhat ostentatious display to Baladan's ambassadors of all his treasures, which he had probably recovered from the Assyrians, and much increased with their spoil. Josephus (*Antiq. x. 2. 2*) says that one of the objects of the embassy was to form an alliance with Hezekiah against the Assyrian empire; and if so, his readiness to enter into an alliance adverse to the theocratical policy, and his desire to magnify his own importance in the eyes of the king of Babylon, probably furnished the ground of the divine disapprobation with which his conduct in this matter was regarded. He was reprimanded by the prophet Isaiah, who revealed to him the mysteries of the future, so far as to apprise him that all these treasures should hereafter be in the possession of the Babylonians, and his family and people exiles in the land from which these ambassadors came. This intimation was

received by the king with his usual submission to the will of God; and he was content to know that these evils were not to be inflicted in his own days. He has sometimes been blamed for this seeming indifference to the fate of his successors; but it is to be borne in mind that at this time he had no children. This was in the fourteenth year of his reign, and Manasseh, his successor, was not born till three years afterwards (2 Kings xx. 12-19; 2 Chron. xxxii. 31; Isa. xxxix.). The rest of Hezekiah's life appears to have been peaceable and prosperous. No man before or since ever lived under the certain knowledge of the precise length of the span of life before him. When the fifteen years had expired, Hezekiah was gathered to his fathers, after a reign of twenty-nine years. He died sincerely lamented by all his people, and the public respect for his character and memory was testified by his corpse being placed in the highest niche of the royal sepulchre (2 Kings xx. 20, 21; 2 Chron. xxxii. 32, 33).

HIEL (חִיל, *God liveth*; Sept. Ἀχιήλ), a native of Beth-el, who rebuilt Jericho, above 500 years after its destruction by the Israelites, and who, in so doing, incurred the effects of the imprecation pronounced by Joshua (1 Kings xvi. 34).

Accursed the man in the sight of Jehovah,
Who shall arise and build this city, even Jericho;
With the loss of his first-born shall he found it,
And with the loss of his youngest shall he fix its
gates (Josh. vi. 26).—J. E. R.

HIERAPOLIS (Ἱεράπολις), a city of Phrygia, not far from Colossæ and Laodicea, where there was a Christian church under the charge of Epaphros, as early as the time of St. Paul, who commends him for his fidelity and zeal (Coloss.

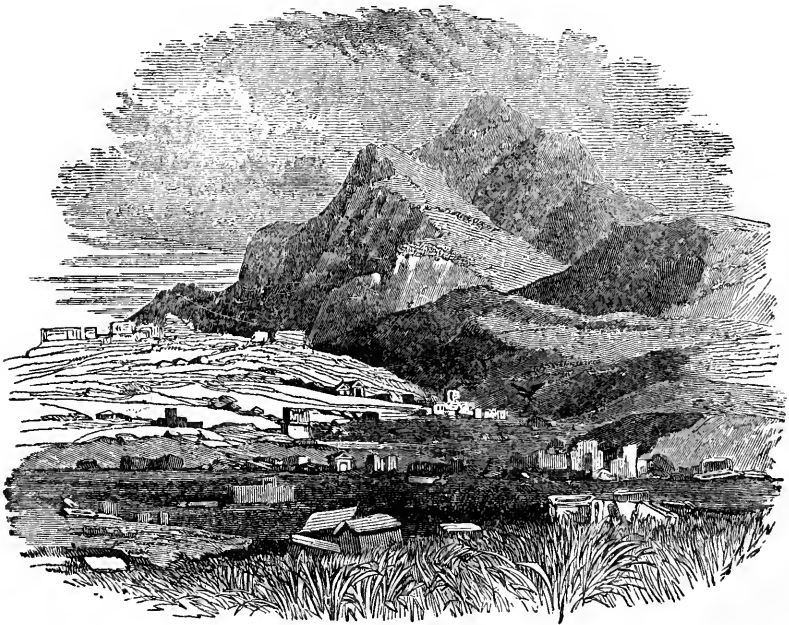

iv. 12, 13.) The place is visible from the theatre at Laodicea, from which it is five miles distant northward.

Smith, in his journey to the Seven Churches (1671), was the first to describe the ancient sites in this neighbourhood. He was followed by Pococke and Chandler; and more recently by Richter, Cockrell, Hartley, and Arundell.

The place now bears the name of Pamluck-kale (Cotton-castle), from the white appearance of the cliffs of the mountain on the lower summit, or rather an extended terrace, on which the ruins are situated. It owed its celebrity, and probably the sanctity indicated by its ancient name (Holy City), to its very remarkable springs of mineral water, the singular effects of which, in the formation of stalactites and incrustations by its deposits, are shown in the accounts of Pococke (ii. pt. 2, c. 13) and Chandler (*Asia Minor*, c. 68), to have been accurately described by Strabo (xiii. p. 629). A great number and variety of sepulchres are found in the different approaches to the site, which on one side is sufficiently defended by the precipices overlooking the valleys of the Lycus and Mæander, while on the other sides the town walls are still observable. The magnificent ruins clearly attest the ancient importance of the place. The main street can still be traced in its whole extent, and is bordered by the remains of three Christian churches, one of which is upwards of 300 feet long. About the middle of this street, just above the mineral springs, Pococke, in 1741, thought that he distinguished some remains of the Temple of Apollo, which, according to Damascius, quoted by Photius (*Biblioth.* p. 1054), was in this situation. But the principal ruins are a theatre and gymnasium, both in a state of uncommon preservation; the former 346 feet in diameter, the latter nearly filling a space of 400 feet square. Strabo (*loc. cit.*) and Pliny (*Hist. Nat.* v. 29) mention a cave called the Plutonium, filled with pestilential vapours, similar to the celebrated Grotto del Cane in Italy. High up the mountain-side is a deep recess far into the mountain; and Mr. Arundell says that he should have supposed that the mephitic cavern lay in this recess, if Mr. Cockrell had not found it near the theatre, the position anciently assigned to it. He adds that the experiments made in this mountain-side recess do not seem very conclusive, and conjectures that it may be the same in which Chandler distinguished the area of a stadium (Arundell, *Asia Minor*, ii. 210). The same writer gives, from the *Oriens Christianus*, a list of the bishops of Hierapolis down to the time of the emperor Isaac Angelus. Fuller accounts of the ruins, &c., may be seen in the authors named above (comp. also Col. Leake's *Geogr. of Asia Minor*, pp. 252, 253).

HIGH PLACES AND GROVES. As high places and groves are almost constantly associated in Scripture, it seems undesirable to separate them in our consideration.

By 'high places' (במות *bamoth*) we are content to understand natural or artificial eminences, where worship by sacrifice or offering was made, usually upon an altar erected thereon.

By a 'grove' we understand a plantation of trees around a spot in the open air set apart for worship and other sacred services, and therefore

around or upon the 'high places' which were set apart for the same purposes.

In looking at matters of this nature we are constantly liable to error, and constantly do err, from not taking into account the altered circumstances under which the same subject may be brought before us in the course of a long series of ages. Thus, with reference to the present topic, it is manifest that the patriarchs worshipped in groves and upon high places; and much difficulty has been felt in reconciling this with the deep reprobation with which the practice is mentioned at a later period. It seems to have occurred to no one that the conditions of the question had altered in the course of ages; and that what was more anciently an indifferent or laudable custom, had in the lapse of time become, by abuses and corrupting associations, criminal and dangerous. Yet we incline to think that this is the real solution of the difficulties by which this question has seemed to be surrounded.

We find traces of these customs so soon after the deluge, that it is probable they existed prior to that event. It appears that the first altar after the deluge was built by Noah upon the mountain on which the ark rested (Gen. viii. 20). Abraham, on entering the Promised Land, built an altar upon a mountain between Beth-el and Hai (xii. 7, 8). At Beersheba he planted a grove, and called there upon the name of the everlasting God (Gen. xxi. 33). The same patriarch was required to travel to the mount Moriah, and there to offer up his son Isaac (xxii. 2, 4). It was upon a mountain in Gilead that Jacob and Laban offered sacrifices before they parted in peace (xxxi. 54). In fact, such seem to have been the general places of worship in those times; nor does any notice of a temple, or other covered or enclosed building for that purpose, occur. Thus far all seems clear and intelligible. There is no reason in the mere nature of things why a hill or a grove should be an objectionable, or, indeed, why it should not be a very suitable, place for worship. Yet by the time the Israelites returned from Egypt, some corrupting change had taken place, which caused them to be repeatedly and strictly enjoined to overthrow and destroy the high places and groves of the Canaanites wherever they found them (Exod. xxxiv. 13; Deut. vii. 5; xii. 2, 3). That they were not themselves to worship the Lord on high places or in groves is implied in the fact that they were to have but one altar for regular and constant sacrifice; and it was expressly enjoined that near this sole altar no trees should be planted (Deut. xvi. 21).

It is evident from the prohibition itself that other nations continued to preserve the primeval practice of worshipping upon high places and in groves. Among them circumstances had arisen which rendered it inexpedient that the practice should be continued by the chosen people. What these circumstances were we must ascertain from the accounts given by the heathen themselves, for the Scripture does not explain this matter. And it is important to observe that the heathen writers perfectly agree with Scripture in describing hills and groves as the earliest places of worship.

It is possible that the Canaanites had not yet fallen into rank idolatry in the time of Abraham—at least, not into such idolatries as defiled the

very places in which they worshipped. We know, at all events, that their iniquity was not full in those earlier times, but that when the Israelites invaded the land their iniquity was full to overflowing. As included in this, we may with tolerable certainty infer that their religion had become so grossly erroneous and impure, that it was needful to place under ban even their places of worship, which might otherwise bring the Israelites into danger by the associations which had become connected with them.

The great object of the law was to attach the Israelites to the worship of the One Jehovah, the Creator of heaven and earth, and to preserve them from the polytheism into which the nations had fallen. Now it is certain that the Canaanites had become polytheistic, and, consequently, that their high places and groves were dedicated to different gods. By continuing or adopting the use of this custom, the Israelites would infallibly have fallen into the same notions. They would probably have begun by worshipping Jehovah himself under different names and attributes, which would eventually have been erected into distinct gods. There could not be polytheism without idolatry, all but the one God being idols. The one condition, therefore, involves the other; and injunctions or statements beyond this apply to the forms which the idolatry assumed, in the character and attributes of the worshipped gods.

The information derivable from heathen writers cannot of course ascend beyond the first forms of idolatry; for, as idolaters, they had no notion or tradition of the times when idolatry had no existence. Now, by universal consent, the earliest idolatry was solar and planetary; the heavenly bodies being worshipped at first in their natural appearances, and at length by representative figures and images. It is clear that this was the case among the Canaanites and the other nations with whom the Israelites were brought into contact. And here much might be said of, for much is suggested by, the sacrifice of Balaam, who upon each of the high places where he sacrificed, built *seven* altars, and offered *seven* bullocks and *seven* rams on every altar. Here there was manifestly a polytheistic reference, and the number *seven* suggests a planetary one; although Balaam certainly had a historical knowledge at least of the true God, and was, after a sort, his worshipper.

As long as the nations continued to worship the heavenly bodies themselves, they worshipped in the open air, holding that no walls could contain infinitude. Afterwards, when the symbol of fire or of images brought in the use of temples, they were usually built in groves and upon high places, and sometimes without roofs. The principle on which high places were preferred is said to have been, that they were nearer to the gods, and that on them prayer was more acceptable than in the valleys (Lucian, *De Sacrif.* i. 4). The ancient writers abound in allusions to this worship of the gods upon the hill-tops; and some of their divinities took their distinctive names from the hill on which their principal seat of worship stood, such as Mercurius Cyllenius, Venus Erycina, Juppiter Capitolinus, &c. To prove facts so well known as this preference and special appropriation of high places, is scarcely necessary; but among other authorities the following may be consulted: Sophocles, *Trachin.* 1207, 1208; Herod. i. 131;

Xenoph. *Cyrop.* viii. 7, p. 500; Strabo, xv. p. 732, Appian, *De Bello Mithrid.* § 131.

The groves which ancient usage had established around the places of sacrifice for the sake of shade and seclusion, idolatry preserved not only for the same reasons, but because they were found convenient for the celebration of the rites and mysteries, often obscene and abominable, which were gradually superadded. Then the presence of a grove of a particular species of tree at the principal seat of the worship of a particular god, would occasion trees of the same kind to be planted at other seats of the same worship; whence that kind of tree came to be regarded as specially appropriate to the particular idol; and, in process of time, there was no important tree which had not become the property of some god or goddess, so that every stranger who passed by a sacred grove could determine by the species of tree of which it was composed to what God the high place, altar, or temple with which it was connected belonged. To this effect there is an interesting passage in the beginning of Pliny's twelfth book: 'Trees were formerly the only temples of the gods; and even now the simple peasantry, in imitation of this ancient custom, dedicate to some god the finest tree of their district. Nor do we ourselves adore with more reverence the statues of the gods resplendent with ivory and gold, than the sacred groves and the holy silence which reigns in them. Trees were also anciently, as at present, consecrated to particular divinities; as the *esculus* to Jove (*ut Jovis esculus*, which seems to have been a kind of oak), the laurel to Apollo, the olive to Minerva, the myrtle to Venus, the poplar to Hercules. It is also believed that as the heavens have their proper and peculiar deities, so also the woods have theirs, being the Fauns, the Sylvaus, and certain goddesses' (doubtless, such demi-goddesses as the dryades and hamadryades). To this it may be added that groves were enjoined by the Roman law of the twelve tables as part of the public religion. Plutarch (*Numa*, i. 61) calls such groves *ἄσκη θεῶν*, 'groves of the gods,' which he says Numa frequented, and thereby gave rise to the story of his intercourse with the goddess Egeria. In fact, a degree of worship was, as Pliny states, transferred to the trees themselves. They were sometimes decked with ribbons and rich cloths, lamps were placed on them, the spoils of enemies were hung from them, vows were paid to them, and their branches were encumbered with votive offerings. Traces of this arborolatry still exist everywhere, both in Moslem and Christian countries; and even the Persians, who abhorred images as much as the Hebrews ever did, rendered homage to certain trees. The story is well known of the noble plane-tree, near Sardis, before which Xerxes halted his army a whole day, while he rendered homage to it, and hung royal offerings upon its branches (Herod. vii. 31). There is much curious literature connected with this subject which we leave untouched; but the reader may consult Sir W. Ouseley's learned dissertation on Sacred Trees, appended to the first volume of his *Travels in the East*.

This statement of the notions connected with religious worship in high places and in groves seems amply to support the view we have taken as to the nature of the dangers which the prohibition of it

was designed to obviate. The explanation as to the special appropriation of trees to particular gods alone suffices to throw a flood of light upon the injunction to cut down the sacred groves of the Canaanites; seeing that while these groves remained, it would be impossible to dissociate the idea of the god to which the trees had been consecrated; and the disgraceful orgies which were celebrated under their obscure shade, would alone suffice to explain the same injunction on the ground of the holy abhorrence with which the scene of such abominations must be regarded by One who is of purer eyes than to behold iniquity.

The injunctions, however, respecting the high places and groves were very imperfectly obeyed by the Israelites; and their inveterate attachment to this mode of worship was such that even pious kings, who opposed idolatry by all the means in their power, dared not abolish the high places at which the Lord was worshipped. And it appears to us likely, that this toleration of an acknowledged irregularity arose from the indisposition of the people living at a distance from the temple to be confined to the altar which existed there; to their determination to have places nearer home for the chief acts of their religion—sacrifice and offering; and to the apprehension of the kings that if they were prevented from having places for offerings to the Lord in their own neighbourhood, they would make the offerings to idols. This view of the case seems to be strongly confirmed by the fact that we hear no more of this propensity to worship in high places and in groves after synagogues and regular religious services had been established in the towns and gave sufficient operation to the disposition among men to create a local interest in religious observances.

It is more difficult to explain how it happens that, in the face of the prohibition against sacrificing at more than one altar, many persons of piety, and even prophets, not only did so, but, in some instances, did so in high places: Gideon, for instance, at Ophrah (Judg. vi. 25), Manoaah in Dan (Judg. xiii. 16-29), Samuel at Mizpeh (1 Sam. vii. 10), and at Bethlehem (xvi. 5), David in the threshing-floor of Ornan (1 Chron. xxi. 22), and Elijah on Mount Carmel (1 Kings xviii. 30, sq.). It will, however, be observed that in these cases the parties either acted under an immediate command from God, or were invested with a general commission of similar force with reference to such transactions. As this law more immediately concerned the honour of God, and derived all its force from his command, being based on no obvious principle of duty, He undoubtedly had a right to supersede it in particular instances, in which the attendant circumstances and the character of the parties precluded the possibility of the abuses against which it was framed to guard. It has also been suggested that greater latitude was allowed in this point before the erection of the temple gave to the ritual principles of the ceremonial law a fixity which they had not previously possessed. This is possible; for it is certain that all the authorized examples occur before it was built, excepting that of Elijah; and that occurred under circumstances in which the sacrifices could not possibly have taken place at Jerusalem, and in a kingdom where no authorized altar to Jehovah then existed.

HIGH-PRIEST. [PRIESTS.]

HILKIAH (הִלְכִיָּהוּ; Sept. Χελκιάζ). Several persons of this name occur in Scripture, of whom the following are the chief: 1. The father of Jeremiah (Jer. i. 1). 2. A high-priest in the reign of Josias (2 Kings xxii. 4, 8, 10). 3. The father of Eliakim (2 Kings xviii. 18, 26; Isa. xxii. 20).

HIN, a Hebrew liquid measure [WEIGHTS AND MEASURES.]

HIND (אֲיָלָה *ajalah*, Gen. xlix. 21; 2 Sam. xxii. 34; Job xxxix. 1; Ps. xviii. 33, &c.), the female of the hart or stag, doe being the female of the fallow-deer, and roe being sometimes used for that of the roebuck. All the females of the

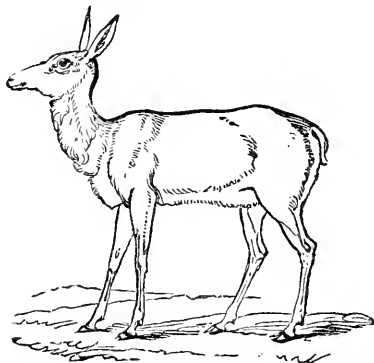

340.

Cervide, with the exception of the reindeer, are hornless. It may be remarked on Ps. xviii. 33 and Hab. iii. 19, where the Lord is said to cause the feet to stand firm like those of a hind on high places, that this representation is in perfect harmony with the habits of mountain stags; but the version of Prov. v. 19, 'Let the wife of thy bosom be as the beloved hind and favourite roe,' seems to indicate that here the words are generalized so as to include under *roe* monogamous species of antelopes, whose affections and consortship are permanent and strong; for stags are polygamous. Finally, the emendation of Bochart on the version of Gen. xlix. 21, where for 'Naphthali is a hind let loose, he giveth goodly words,' he, by a small change in the punctuation of the original, proposes to read 'Naphthali is a spreading tree, shooting forth beautiful branches,' restores the text to a consistent meaning, agreeing with the Sept., the Chaldee paraphrase, and the Arabic version. [AJAL, HART].—C. H. S.

HINNOM, or rather Ben-Hinnom (בְּנֵי הַנֹּחַם; Sept. *βενὸννὸμ*), an unknown person, whose name was given to the valley which bounds Jerusalem on the north, below Mount Zion, and which in Scripture is often mentioned in connection with the horrid rites of Moloch, which under idolatrous kings were there celebrated (Josh. xv. 8; xviii. 16; Neh. xi. 30; Jer. vii. 31; xix. 2). When Josiah overthrew this idolatry, he defiled the valley by casting into it: the bones of the dead, the greatest of all pollutions among the Hebrews; and from that time it became the common jakes of Jerusalem, into which all refuse of the city was cast, and where the combustible portions of that

refuse were consumed by fire. Hence it came to be regarded as a sort of type of hell, the Gehenna of the New Testament being no other than the name of this valley of Hinnom (Ge-Hinnom); see Matt. v. 22, sq.; Mark ix. 43; Luke vii. 5; John iii. 6 [HADES; JERUSALEM].

1. HIRAM (חִירָם; Sept. Χειράμ), king of Tyre at the commencement of David's reign. He sent an embassy to felicitate David on his accession, which led to an alliance, or strengthened a previous friendship between them. It seems that the dominion of this prince extended over the western slopes of Lebanon; and when David built himself a palace, Hiram materially assisted the work by sending cedar-wood from Lebanon, and able workmen to Jerusalem (2 Sam. v. 11; 1 Chron. xiv. 1), B.C. 1055.

2. HIRAM, king of Tyre, son of Abibaal, and grandson of the Hiram who was contemporary with David, in the last years of whose reign he ascended the throne of Tyre. Following his grandfather's example, he sent to Jerusalem an embassy of condolence and congratulation when David died and Solomon succeeded, and contracted with the new king a more intimate alliance than ever before or after existed between a Hebrew king and a foreign prince. The alliance seems to have been very substantially beneficial to both parties, and without it Solomon would scarcely have been able to realise all the great designs he had in view. In consideration of large quantities of corn, wine, and oil, furnished by Solomon, the king of Tyre agreed to supply from Lebanon the timber required for the temple, to float it along the coast, and deliver it at Joppa, which was the port of Jerusalem (1 Kings v. 1, sq.; ix. 10, sq.; 1 Chron. ii. 3, sq.). The vast commerce of Tyre made gold very plentiful there; and Hiram supplied no less than 500 talents to Solomon for the ornamental works of the temple, and received in return twenty towns in Galilee; which, when he came to inspect them, pleased him so little, that he applied to them a name of contempt, and restored them to the Jewish king (2 Chron. viii. 2) [CABUL]. It does not, however, appear that the good understanding between the two kings was broken by this unpleasant circumstance; for it was after this that Hiram suggested, or at least took part in, Solomon's traffic to the Eastern seas—which certainly could not have been undertaken by the Hebrew king without his assistance in providing ships and experienced mariners (1 Kings ix. 27; x. 11, &c.; 2 Chron. viii. 18; ix. 10, &c.), B.C. 1007 [OPHIR; SOLOMON; PHŒNICIANS].

3. HIRAM, or HURAM, son of a widow of the tribe of Dan, and of a Tyrian father. He was sent by the king of the same name to execute the principal works of the interior of the temple, and the various utensils required for the sacred services. We recognise in the enumeration of this man's talents by the king of Tyre a character common in the industrial history of the ancients, namely, a skilful artificer, knowing all the arts, or at least many of those arts which we practise, in their different branches [HANDICRAFT]. It is probable that he was selected for this purpose by the king from among others equally gifted, in the notion that his half Hebrew blood would render him the more acceptable at Jerusalem.

HISTORY. Under this term we here intend to give, not a narrative of the leading events detailed in the Bible, but such general remarks on the Biblical history as may enable the reader to estimate the comparative value, and apply for information to the proper sources, of historical knowledge, as presented in or deduced from the sacred records. The question of inspiration we here leave untouched, because it is one of a dogmatical nature, which will be fully discussed in a separate article. The historical books that are contained in the Bible pass, therefore, under review as other historical documents, and are subjected to the same rules of criticism as those which are applied to the productions of profane writers. And if the believer should, in consequence, find himself for a moment deprived in imagination of a basis of reliance, he will be repaid by the fact that, while he thus meets the unbeliever on his own ground, he is enabled, by the application of recognised principles of historical criticism, to prove beyond a question that no history in existence can compare with the Biblical history either in age, credibility, value, or interest.

The subject-matter contained in the Biblical history is of a wide and most extensive nature. In its greatest length and fullest meaning it comes down from the creation of the world till near the close of the first century of the Christian era, thus covering a space of some 4000 years. The books presenting this long train of historical details are most diverse in age, in kind, in execution, and in worth; nor seldom is it the fact that the modern historian has to construct his narrative as much out of the implications of a letter, the highly coloured materials of poetry, the far-reaching visions of prophecy, and the indirect and allusive information of didactic and moral precepts, as from the immediate and express statements of history strictly so denominated. The history of Herodotus, embracing as it does most of the world known at his time, and passing, under the leading of a certain thread of events, from land to land,—this history, with its naive, graphic, gossip, and traveller-like narratives, interweaving in a succession of fine old tapestries many of the great events and moving scenes which had, up to his time, taken place on the theatre of the world, presents to the intelligent reader a continuation of varied gratifications. But even the history of Herodotus must yield to that contained or implied in the Bible, not merely in extent of compass, but also in variety, in interest, and beyond all comparison, in grandeur, importance, and moral and spiritual significance. The children of the faithful Abraham seem to have had one great work of Providence intrusted to them, namely, the development, transmission, and infusion into the world of the religious element of civilization. Their history, accordingly, is the history of the rise, progress, and diffusion of true religion, considered in its source and its developments. Such a history must possess large and peculiar interest for every student of human nature, and pre-eminently for those who love to study the unfoldings of Providence, and desire to learn that greatest of all arts—the art of living at once for time and for eternity.

The Jewish history contained in the Bible embraces more and less than the history of the

Israelites;—more, since it begins with the beginning of the earth and narrates with extraordinary brevity events which marked the period terminated by the flood, going on till it introduces us to Abraham, the primogenitor of the Hebrew race; less, since, even with the assistance of the poetical books, its narratives do not come down to a later date than some 600 years before the birth of Christ. The historical materials furnished relating to the Hebrew nation may be divided into three great divisions: 1. The books which are consecrated to the antiquity of the Hebrew nation—the period that elapsed before the era of the judges. These works are the Pentateuch and the book of Joshua, which, according to Ewald (*Geschichte des Volkes Israel*, i. 72), properly constitute only one work, and which may be termed the great book of original documents. 2. The books which describe the times of the judges and the kings up to the first destruction of Jerusalem; that is, Judges, Kings, and Samuel, to which belongs the book of Ruth: ‘all these,’ says Ewald, ‘constitute also, according to their last formation, but one work, which may be called the Great Book of Kings.’ 3. The third class comprises the books included under the head of Hagiographa, which are of a much later origin, Chronicles, with Ezra and Nehemiah, forming the great book of general history reaching to the Grecian period. After these books come those which are classed together under the name of Apocrypha, whose use in this country we think unduly neglected. Then the circle of evangelical records begins, which closed within the century that saw it open. Other books found in the Old and New Testaments, which are not properly of a historical character, connect themselves with one or other of these periods, and give important aid to students of sacred history.

Biblical history has not hitherto been satisfactorily treated. Particular parts of it may indeed have received the kind and degree of attention required, but most writers who have treated that history as a whole have been swayed, some by one, some by another warping influence, so that the Bible has been made to speak the most diverse tongues, now in favour of a naturalism which finds an impossibility in every miracle, and now in favour of a mysticism which sees a great spiritual secret in every fact, if not in every letter. It is useless indeed to expect that men will not be influenced by their pre-conceptions; but they cannot be justified, when they profess to write history, in ascribing their opinions and forcing their views on writers who lived thousands of years before them, and with whose modes of thinking and manner of writing they have not much in common. History and the philosophy of history, the history of fact and the history of opinion, the statement of what men have done, said, and thought, and the discussion of what is true and proper, are two different and very distinct departments of knowledge and art, the confounding of which must lead to perplexity and may involve us in serious error. The proper way to treat of biblical history is what we may term the *historical* (in other words the chronological) deduction of the facts presented, as these facts were seen, believed, and recorded by the several writers. An historian of the Hebrews should as far as possible place himself, and aim to place the mind of his readers, in

the centre of the mind of each biblical historian, in order that, by seeing as the Hebrew saw, he may, aided by skill and light which the Hebrew did not and could not possess, present a vivid picture of the several periods that are passed in review. These remarks are not intended to be taken so as to exclude the exercise of criticism on authorities and alleged facts; but it must be historical not philosophical criticism—criticism whose implements, processes, and spirit, are borrowed from philology, which is the hand-maid of history, not the crucible of modern anti-supernaturalism, which, starting from a preconceived notion, some persons would say, a huge, dark falsehood, tries to extinguish every ray of heavenly light which may struggle amid the darkness of earth, and to make history as rayless and dull as itself. Philosophy has its own sphere, in which we have no desire to give it disturbance, but we do object to its attempting to pass off its own offspring as pure historical results.

Biblical history was often treated by the older writers as a part of church history in general, as they considered the history given in the Bible as presenting different and successive phases of the church of God (*Buddei Hist. Eccles.* 2 vols. 1726-29; Stolberg, *Geschichte der Religion Jesu*, i. 111). Other writers have viewed this subject in a more practical light, presenting the characters found in the Bible for imitation or avoidance; among whom may be enumerated Hess (*Geschichte der Israeliten vor den Zeiten Jesu*). Hess also wrote a history of Jesus (*Geschichte Jesu*; Zürich, 1775); but the best work is a more recent, and a very valuable one, by Niemeyer (*Characteristik der Bibel*, Halle, 1830). Among the more strictly learned writers several have had it in view to supply the gaps left in the succession of events by the Bible, out of sources found in profane writers. Here the chief authors are of English birth, namely, Prideaux, Shuckford, Russell; and for the New Testament, the learned, cautious, and fair-dealing Lardner [*CHRONOLOGY*]. There is a valuable work by G. Langen: *Versuch einer Harmonie der heiligen und profan scrib. in der Geschichte der Welt*, Bayreuth, 1775-80. Jahn, in his *Bib. Archäologie*, has, according to Gesenius (art. ‘Bib. Geschichte’ in Ersch and Gruber’s *Allg. Enc.*), made free use of Prideaux. Other writers have pursued a strictly chronological method, such as Usher (*Annales Vet. N. T.* London, 1650), and Des Vignoles (*Chronologie de l’Hist. Sainte*, Berlin, 1738). Heeren (*Handb. der Geschichte*, p. 50) recommends, as containing many valuable inquiries on the monarchical period, the following work: J. Bernharti *Commentatio de causis quibus effectum sit ut regnum Judæ diutius persisteret quam regnum Israel*, Lovanni, 1825. Heeren also declares that Baer’s *Handbuch der Geschichte des II. Volkes*, 1800, is the best introduction both to the history and the antiquities of the Hebrew nation; though Gesenius complains that he is too much given to the construction of hypotheses. The English reader will find a useful but not sufficiently critical compendium in *The History of the Hebrew Commonwealth*, translated from the German of John Jahn, D.D. A far more valuable as well as more interesting, yet by no means faultless work, is Milman’s

History of the Jews, published originally in Murray's *Family Library*. A more recent and very valuable work, Kitto's *Pictorial History of Palestine*, 1841, combines with the Bible history of the Jews the results of travel and antiquarian research, and is preceded by an elaborate Introduction, which forms the only Natural History of Palestine in our language.

German theologians are strongly imbued with the feeling that the history of the Hebrews has yet to be written. Niebuhr's manner of treating Roman history has had a great influence on them, and has aroused the theological world to new efforts, which have by no means yet come to an end; nor can we add that they have hitherto led to very definite and generally approved results. The works of Jost (*Gesch. d. Israel. s. d. Zeit. der Maccab.* 1820-9), and Nork (*Das Leben Moses aus Astron. Stand. betrachtet*, 1838), and others, must not be overlooked by the professional student; nor will he fail to study with care the valuable introductions to the knowledge of the Old Testament put forth in Germany, with which we have nothing comparable in our language: among these introductions we can confidently recommend—*Einleitung in das alte Test.* von I. G. Eichhorn (a work which forms an epoch); *Lehrbuch der Hist. Krit. Einleit. in die Bücher des A. Test.* von W. M. L. de Wette, 5th edit. 1840; and *Handb. der Hist. Krit. Einleit. in das alte Testament*, von H. A. Ch. Hävernick, 1806; in which last work a more full and thorough treatment of the subject may be found. Of the more recent works we may mention Stähelin's *Kritische Untersuchungen über der Pentateuch*, &c. 1843; and H. Ewald's *Geschichte des Volkes Israel bis Christus*, Erster Band, 1843. Something worth notice may also be found in *De Anno Hebræorum Jubileo*, scripsit J. T. K. Kranold. Ewald intends his present work to be a complete history of the Israelites, and considers it as a continuation of his *Die Propheten des Alten Bundes*, 1840. We have not space to give an account here of the views which these writers put forth, and we mean our recommendation of them to extend only to the calm, dignified, and profoundly learned manner in which they handle their subject, subjoining that works like these must eventually produce a great influence in the theological world.

The sources of Biblical history are chiefly the Biblical books themselves. Any attempt to fix the precise value of these sources in a critical point of view would require a volume instead of an article. Whatever hypothesis, however, may eventually be held touching the exact time when these books, or any of them, were put into their actual shape, as also touching the materials out of which they were formed, one thing appears very certain, that (to take an instance) Genesis, the earliest book (probably), contains most indubitable as well as most interesting historical facts; for though the age, the mode of life, and the state of culture differ so widely from our own, we cannot do otherwise than feel that it is among men and women, parents and children—beings of like passions with ourselves,—and not with mere creations of fancy or fraud, that we converse when we peruse the narratives which this composition has so long preserved. The conviction is much strengthened in the minds of those who, by per-

sonal acquaintance with the early profane writers, are able to compare their productions with those of the Hebrews, which were long anterior, and must, had they been of an equally earthly origin, have been at least, equally deformed by fable. The sole comparison of the account given in Genesis of the creation of the world with the Cosmogonies of heathen writers, whether Hindoo, Greek, or Latin, is enough to assure the impartial reader that a purer, if not a higher influence, presided over the composition of Genesis, than that whence proceeded the legends or the philosophies of heathenism; nor is the conclusion in the slightest degree weakened in the writer's mind by any discrepancy which modern science may seem to show us between its own discoveries and the statements in Genesis. The Biblical history, as found in its Biblical sources, has a decided peculiarity and a great recommendation in the fact that we can trace in the Bible more clearly and fully than in connection with any other history, the first crude elements and the early materials out of which all history must be constructed. How far the literature supplied in the Bible may be only a relic of a literary cyclus called into being by the felicitous circumstances and favourable constitution of the great Shemitic family, but which has perished in the lapse of ages, it is now impossible to determine; but had the other portions of this imagined literature been of equal religious value with what the Bible offers, there is little risk in affirming that mankind would scarcely have allowed it to be lost. The Bible, however, bears traces that its were not the only books current in the time and country to which it relates; for writing, writers, and books are mentioned without the emphasis and distinction which always accompany new discoveries or peculiar local possessions, and as ordinary, well-known, and matter-of-course things. And it is certain that we do not possess all the works which were known in the early periods of Israelite history, since in Numbers xxi. 14 we read of 'the book of the wars of the Lord,' and in Joshua x. 13, of 'the book of Jasher.' Without writing, history, properly so called, can have no existence. Under the head Writing we shall trace the early rudiments and progress of that important art: here we merely remark that an acquaintance with it was possessed by the Hebrews at least as early as their Exodus from Egypt—a fact which shows at least the possibility that the age of the Biblical records stands some thousand years or more [CHRONOLOGY] prior to the earliest Greek historian, Herodotus.

There is another fact which has an important bearing on the worth and credibility of the Biblical narratives, namely, that the people of which they speak were a *commemorative race*, were, in other words, given to create and preserve memorials of important events. Even in the patriarchal times we find monuments set up in order to commemorate events. Jacob (Gen. xxviii. 18) 'set up a pillar' to perpetuate the memory of the divine promise; and that these monuments had a religious import and sanction appears from the statement that 'he poured oil upon the top of the pillar' (see Gen. xxxi. 45; Josh. iv. 9; 1 Sam. vii. 12; Judg. ix. 6). Long-lived trees, such as oak and terebinth, were made use of as remembrancers (Gen. xxxv. 4; Josh. xxiv. 26). Commemorative names, also, were given to per-

sons, places, and things; and from the earliest periods it was usual to substitute a new and descriptive for an old name, which may in its origin have been descriptive too (Exod. ii. 10; Gen. ii. 23; iv. 1). Genealogical tables appear, moreover, to have had a very early existence among the people of whom the Bible speaks, being carefully preserved first memoriter, afterwards by writing, among family treasures, and thus transmitted from age to age. These, indeed, as might be expected, appear to have been the first beginnings of history—a fact which is illustrated and confirmed by the way in which what we should term a narrative or historical sketch is spoken of in the Bible, that is, as ‘the book of the generation’ (‘of Adam,’ Gen. v. 1): a mode of speaking which is applied even to the account of the creation (Gen. ii. 4), ‘these are the generations of the heavens and the earth when they were created.’ The genealogical tables in the Bible (speaking generally) are not only of a very early date, but are free from the mixtures of a theological and cosmogonical kind which are found in the early literature of other primitive nations, wearing the appearance of being, so far at least as they go, true and complete lists of individual and family descent (Gen. v. 1). But, perhaps, the most remarkable fact connected with this subject is the employment of poetry at a very early period to perpetuate a knowledge of historical events. Even in Gen. iv. 23, in the case of Lamech, we find poetry thus employed, that is, by the great-grandson of the primitive father. Other instances may be found in Exod. xv.; Judg. v.; Josh. x. 13; 2 Sam. i. 18. This early use of poetry, which must be regarded as a considerable step in civilization, implies a still earlier pre-existent culture; confutes the notion that human society began with a period of barbarism; looks favourably on the hypothesis that language had an immediately divine origin; explodes the position that the Hebrews were at first an ignorant, untutored, and unlettered race; and creates a presumption on behalf of their historical literature. Poetry is a good vehicle for the transmission of great leading facts; for, though it may throw over fact a colouring borrowed from the imagination, yet the form in which it appears gives warning that such hues are upon its details, which hues, besides being themselves a species of history, are then easily removed, while the form shuts up and holds in the facts intrusted to the custody of verse, and so transmits them to posterity without additions and without loss. By means of these several forms of commemoration much knowledge would be preserved from generation to generation, and to their existence from the first may we ascribe the brief, but still valuable, notices which the Bible presents of the primitive ages and condition of the world.

Other sources for at least the early Biblical history are comparatively of small value. Josephus has gone over the same periods as the Bible treats of, but obviously had no sources of consequence relating to primitive times which are not open to us, and in regard to those times does little more than add here and there a patch of a legendary or traditional hue which could have been well spared. His Greek and Roman predilections and his apologetical aims detract from his value, while in relation to the early his-

tory of his country he can be regarded in no other light than a sort of philosophical interpreter; nor is it till he comes to his own age that he has the value of an independent (not even then an impartial) eye-witness or well-informed reporter. In historical criticism and linguistic knowledge he was very insufficiently furnished. The use of both Josephus and Philo is far more safe for the student of the New Testament than for the expounder of the old.

The Talmud and the Rabbins afford very little assistance for the early periods, but might probably be made to render more service in behalf of the times of the Saviour than has been generally allowed. The illustrations which Lightfoot and Wetstein have drawn from these sources are of great value; and Gröner, in his *Jahrhundert des Heils* (Stuttgart, 1838), has made an ample use of the materials they supply in order to draw a picture of the first century, a use which the learned author is at no small pains to justify. The compilations of the Jewish doctors, however, require to be employed with the greatest caution, since the Rabbins were the depositaries, the expounders, and the apologists of that corrupt form of the primitive faith and the Mosaic institutions which has been called by the distinctive name of Judaism, which comprised an heterogeneous mass of false and true things, the colluvies of the East as well as light from the Bible, and which, to a great extent, lies under the express condemnation of Christ himself. How easy it is to propagate fables on their authority, and to do a disservice to the Gospel records, may be learnt from the fact that older writers, in their undue trust of Rabbinical authority, went so far as to maintain that no cock was allowed to be kept in Jerusalem because fowls scratched unclean things out of the earth, though the authority of Scripture (which in the case they refused to admit) is most express and decided (Matt. xxvi. 34; Mark xiv. 30, 60, 72). On the credibility of the Rabbins see Ravii *Diss. Phil. Theol. de eo quod Fidei merentur*, etc. in Oelrich's *Collect. Opusc. Hist. Phil. Theol.*; Wolf, *Bibl. Hebr.* ii. 1095; Fabricius, *Bibliog. Antiq.* i. 3, 4; Brunsmann, *Diss. de Judaica levitate*, Hafnia, 1705.

The classic authors betray the grossest ignorance almost in all cases where they treat of the origin and history of the Hebrew people; and even the most serious and generally philosophic writers fall into vulgar errors and unaccountable mistakes as soon as they speak on the subject. What, for instance, can be worse than the blunder or prejudice of Tacitus, under the influence of which he declared that the Jews derived their origin from Mount Ida in Crete; that by the advice of an oracle they had been driven out of Egypt; and that they set up in their temple at Jerusalem as an object of worship the figure of an ass, since an animal of that species had directed them in the wilderness and discovered to them a fountain (Tacit. *Hist.* v. 1, 2). Dion Cassius (xxxvii. 17) relates similar fables. Plutarch (*Quæst. Sympos.* iv. 5) makes the Hebrews pay divine honours to swine, as being their instructors in agriculture, and affirms that they kept the Sabbath and the Feast of Tabernacles in honour of Bacchus. A collection of these gross misrepresentations, together with a profound and successful inquiry into their origin, and a full exposure of their false-

hood, may be found in a paper by Dr. J. G. Müller, recently published in the *Theologische Studien und Kritiken* (1843, Viertes Heft. p. 393).—J. R. B.

HITTITES (חִיטִּי; Sept. *Xerraiot*), or children of Heth, one of the tribes of Canaanites which occupied Palestine before the Israelites (Gen. xv. 20; Exod. iii. 8; xxiii. 23). They lived in and about Hebron; and Abraham, when he abode in that neighbourhood, was treated by them with respect and consideration (Gen. xxiii. 3-7, 11, 12). This intimacy led to Esau's marriage with two women of this nation, to the grief and annoyance of his parents (Gen. xxvi. 34, 35; xxxvi. 2). The Hittites are described in Num. xiii. 29, along with the Amorites, as 'dwelling in the mountains,' that is in what were afterwards called 'the mountains of Judah,' of which Hebron was the chief town. Uriah, who had the high honour of being one of David's thirty 'worthies,' and, unhappily for him, the husband of Bathsheba, is called a Hittite (2 Sam. xi. 3, 6; 1 Kings ix. 20). He was, doubtless, a proselyte, and probably descended from several generations of proselytes; but the fact shows that Canaanitish blood was in itself no bar to advancement in the court and army of David. Solomon subjected the remaining Hittites to the same tribute of bond-service as the other remnants of the Canaanite nations (1 Kings ix. 20). Of all these the Hittites appear to have been the most important, and to have been under a king of their own: for 'the kings of the Hittites' are, in 1 Kings x. 29, coupled with the kings of Syria as purchasers of the chariots which Solomon imported from Egypt. We might have supposed that this was some different division of the Hittite family living far away somewhere in the north. But in 2 Kings vii. 6 we find that when the Syrians, besieging Samaria, heard the sound of advancing chariots, they concluded that the king of Israel (Joram I.) had hired against them 'the kings of the Hittites and the kings of the Egyptians.' Now the mention of the Egyptians shows that the noise came from the south, from which quarter it seems they and the Egyptians were the only people who could be expected to make an attack with chariots. This identifies them with the southern Hivites, who were subject to the sceptre of Judah, and it shows also that it was they who purchased Egyptian chariots from the factors of Solomon. The Hittites were still present in Palestine as a distinct people after the Exile, and are named among the alien tribes with whom the returned Israelites contracted those marriages which Ezra urged, and Nehemiah compelled, them to dissolve (Ezra ix. 1, &c.; comp. Neh. xiii. 23-28). After this we hear no more of the Hittites, who probably lost their national identity by intermixture with the neighbouring tribes or nations.

HIVITES (חִיבִּי; Sept. *Ebalot*), one of the nations of Canaan which occupied Palestine before the Israelites (Gen. x. 17; Exod. iii. 8, 17; xxiii. 23; Josh. iii. 10). They occupied the northern and north-eastern part of the country. In Judg. iii. 3, it is stated that 'the Hivites dwelt in Mount Hermon, from Mount Baal-hermon unto the entering in of Hamath;' and in Josh. xi. 3, the Hivites are described as living

'under Hermon in the land of Mizpeh.' The 'cities of the Hivites' are mentioned in 2 Sam. xxiv. 7, and, from being associated with Sidon and Tyre, must have been in the north-west. A remnant of the nation still existed in the time of Solomon, who subjected them to a tribute of personal labour, with the remnants of other Canaanitish nations which the Israelites had been unable to expel (1 Kings ix. 20). A colony of this tribe was also found in Northern Palestine, occupying the towns of Gideon, Chephirah, Beeroth, and Kirjath-jearim; and these obtained from Joshua a treaty of peace by stratagem (Josh. ix. 3-17; xi. 19).

HOBAB, kinsman of Moses and priest or prince (for the word חֹבָב carries both significations) of Midian, a tract of country in Arabia Petraea, on the eastern border of the Red Sea, at no great distance from Mount Sinai. The family of this individual seems to have observed the worship of the true God in common with the Hebrews (Exod. xviii. 11, 12); and from this circumstance some suppose it to have been a branch of the posterity of Midian, fourth son of Abraham, by Keturah; while others, on the contrary, maintain that the aspersion cast upon Moses for having married a Cushite is inconsistent with the idea of its genealogical descent from that patriarch (see Calmet).

Considerable difficulty has been felt in determining who this person was, as well as his exact relation to Moses; for the word חֹבָב, which, in Exod. iii. 1, Num. x. 29, Judg. iv. 11, is translated *father-in-law*, and in Gen. xix. 14, *son-in-law*, is a term of indeterminate signification, denoting simply relationship by marriage; and besides, the transaction which in one place (Exod. xviii. 27) is related of Jethro, is in another related of Hobab. The probability is, that as forty years had elapsed since Moses' connection with this family was formed, his father-in-law (Exod. ii. 18) Renel or Raguel (the same word in the original is used in both places) was dead, or confined to his tent by the infirmities of age, and that the person who visited Moses at the foot of Sinai was his brother-in-law, called Hobab in Num. x. 29, Judg. iv. 11; Jethro in Exod. iii. 1; and חֹבָב in Judg. i. 16, which, in chap. iv. 11, is rendered improperly 'the Kenite.'

About a year after the Exodus he paid a visit to Moses, while the Hebrew camp was lying in the environs of Sinai, bringing with him Zipporah, Moses' wife, who, together with her two sons, had been left with her family while her husband was absent on his embassy to Pharaoh. The interview was on both sides affectionate, and was celebrated first by the solemn rites of religion, and afterwards by festivities, of which Aaron and the elders of Israel were invited to partake. On the following day, observing Moses incessantly occupied in deciding causes that were submitted to him for judgment, his experienced kinsman remonstrated with him on the speedy exhaustion which a perseverance in such arduous labours would superinduce; and in order to relieve himself, as well as secure a due attention to every case, he urged Moses to appoint a number of subordinate officers to divide with him the duty of the judicial tribunals, with power to decide in all common affairs, while the weightier and more serious matters were reserved to himself. This wise sug-

gestion the Hebrew legislator adopted (Exod. xviii.).

When the Hebrews were preparing to decamp from Sinai, the kinsman of Moses announced his intention to return to his own territory; but if he did carry that purpose into execution, it was in opposition to the urgent solicitations of the Jewish leader, who entreated him, for his own advantage, to cast in his lot with the people of God; at all events to continue with them, and afford them the benefit of his thorough acquaintance with the wilderness. 'Leave us not, I pray thee,' said Moses, 'forasmuch as thou knowest how we are to encamp in the wilderness, and thou *mayest be to us instead of eyes*;' which the Septuagint has rendered *καὶ ἔσθ' ἐν ἡμῖν πρεσβύτερος*—'and thou shalt be an elder amongst us.' But there can be little doubt that the true meaning is that Hobab might perform the office of a hybeer or guide [CARAVAN]—his influence as an Arab chief, his knowledge of the routes, the situation of the wells, the places for fuel, the prognostics of the weather, and the most eligible stations for encamping, rendering him peculiarly qualified to act in that important capacity. It is true that God was their leader, by the pillar of cloud by day and of fire by night, the advancement or the halting of which regulated their journeys and fixed their encampments. But beyond these general directions the tokens of their heavenly guide did not extend. And as smaller parties were frequently sallying forth from the main body in quest of forage and other necessities, which human observation or enterprise were sufficient to provide, so Moses discovered his wisdom and good sense in enlisting the aid of a native sheik, who, from his family connection with himself, his powerful influence, and his long experience, promised to render the Israelites most important services.—R. J.

HOBNIM (חֹבְנִים) occurs only in one passage of Scripture, where the prophet Ezekiel (xxvii. 15), referring to the commerce of Tyre, says, 'The men of Dedan were thy merchants; many isles were the merchandise of this hand: they brought thee for a present horns of ivory and ebony (*hobnim*).' The Hebrew word is translated 'Ebony' in all the European versions; but, as Bochart states (*Hierozoicon*, i. 20, pars ii.), the Chaldee version, followed by R. Selomo and other Jews, as well as the Greek and Arabic versions, render *hobnim* by *pea-fowl* (*pavones*): 'Itaque soli veterum Symmachus et Hieronymus viderunt (חֹבְנִים) *hobnim* esse *hebenum*.' Some of the Hebrew critics, however, as Kimchius, also acknowledge this: '*Hobnim* lignum interpretantur, quod Arabicè vocatur *abenus*.' Of the correctness of this opinion there can now be no doubt. In the first place, we may allude to Dedan being considered one of the ports of Arabia on the Persian Gulf, or at least to the south of the Red Sea; and secondly, as observed by Bochart, '*hobnim* et *hebenus* sunt voces non absimiles,' the latter word being variously written by ancient authors, as *ἔβην*, *ἔβενος*, *ἔβενον*, *ebenus* and *hebenus*. The last form is used by Jerome in his Latin, and *ἔβενος* by Symmachus, in his Greek version. The Arabs have *أبنوس*, which they apply to Ebony, and by that name it is known in northern India at the present day. Forskål mentions *abnoos* as one

of the kinds of wood imported in his time from India into Arabia. Whether the Arabic name be a corruption of the Greek, or the Greek a modification, as is most likely, of some Eastern name, we require some other evidence, besides the occurrence of the word in Arabic works on *Materia Medica*, to determine; since in these, Greek words are sometimes employed as the principal terms for substances with which they are not well acquainted. *Bardust* is, however, given by some as the Arabic name; *abnoos* as the Persian. We found the latter applied to ebony in North-west India, as did Forskål in the Red Sea.

Ebony wood was highly esteemed by the ancients, and employed by them for a variety of purposes. It is very appropriately placed in juxtaposition with ivory, '*quamvis unum ex animali, alterum ex arbore petatur*. Quippe, ut notat Fullerus (*Miscell.* vi. 14) *utriusque est extremum color eodem excellentiæ gradu*. Ebori videlicet pulcherrimi candoris, hebeno speciosissimi nigroris. Utrumque politissimum, nitidissimum, et incomparabili lævare conspicuum. Unde est, quod in eodem usque fere adhibentur, et ex utroque arcus fiunt, pectines, tabulæ lusoriæ, cultorum manubria,' &c. (Bochart, *l. c.*). Ivory and Ebony are probably, however, also mentioned together because both were obtained from the same countries—Ethiopia and India; and, among the comparatively few articles of ancient commerce, must, from this cause, always have been associated together, while their contrast of colour and joint employment in inlaid work, would contribute as additional reasons for their being adduced as articles characteristic of a distinct commerce.



841. [*Diospyros Ebenum*.]

But it is not in Ezekiel only that ebony and ivory are mentioned together. For Diodorus, as quoted by Bochart, tells us that an ancient king of Egypt imposed on the Ethiopians the payment of a tribute of ebony, gold, and elephants' teeth. So Herodotus (iii. 97), as translated by Bochart, says, '*Ethiopes Persis pro trienniali tributo vehunt duos chænicæ auri apyri (id est, ignem nõndum experti), et ducentas ebeni phalangas, et magnos*

elephanti dentes viginti.' Pliny, referring to this passage, remarks, 'But Herodotus assigneth it rather to Ethiopia, and saith, that every three years the Ethiopians were wont to pay, by way of tribute, unto the kings of Persia, 100 billets of the timber of that tree (that is Ebene), together with gold and yvorie;' and, again, 'From Syene (which confineth and boundeth the lands of our empire and dominion) as farre as to the island Meroë, for the space of 996 miles, there is little ebene found: and that in all those parts betweene there be few other trees to be found, but date trees, which peradventure may be a cause, that Ebene was counted a rich tribute and deserved the third place, after gold and ivory' (Holland's *Pliny*, xii. 4).

It is sometimes stated that the ancients supposed ebony to come only from India. This arose probably from the passage of Virgil (*Georg.* ii. 117):—

‘———— sola India nigrum
Fert ebenum —————.’

But the term 'India' had often a very wide signification, and included even Ethiopia. Several of the ancients, however, mention both Indian and Ethiopian ebony, as Dioscorides and Pliny; while some mention the Indian, and others the Ethiopian only, as Lucan (*Phars.* x. 304).

— 'nigris Meroë fecunda colonis,
Læta comis ebeni.'

The only objection to the above conclusion of any weight is, that *hobnium* is in the plural form. To this Bochart and others have replied, that there were two kinds of ebony, as mentioned by Theophrastus, Dioscorides, &c., one Ethiopian, the other Indian. Fuller and others maintain that the plural form is employed because the ebony was in pieces: 'refert ad ebeni palangas, quæ ex India et Æthiopia magno numero afferebantur. Φάλαγγας vocant Herodotus et Arrianus in Periplo. Plinius *palangas*, aut *phalangas*, variante scriptura, id est, fustes teretes, et qui navibus supponuntur, aut quibus idem onus plures bajulant' (Bochart, *l. c.*). But the names of other valued foreign woods, as ΣΗΥΤΤΙΜ and ΑΛΜΥΓΓΙΜ, are also used in the plural form. Besides *abnoos*, Arab authors, as stated by Bochart (*l. c.*), mention other woods as similar to and substituted for ebony: one of these is called *sheez*, *sheezee*; also *sasem* and *semsem*, in the plural form *semasim*; described as *nigrum lignum ad patinas conficiendas*. Hence, in the Koran, 'de iis, qui in gehenna torquentur,' it is said, 'Exibunt ex igne post aliquam in eo moram; exibunt, inquam, tanquam ligna *semasim*;' that is, black, from being burnt in the fire. That such a wood was known we have the testimony of Dioscorides—'Ἐνιοὶ δὲ τὰ σησάμινα ἢ ἀκάνθινα ξύλα, ἐμφορῆ ὄντα, ἀντὶ ἐβένου πωλοῦσι;' 'Nonnulli sesamina aut acanthina ligna, quod consimilia sunt, pro ebene vendunt.' Some critics, and even Sprengel, in his late edition of Dioscorides, read *σικκάμινα*, instead of *σησάμινα*, for no other reason apparently but because *σικκάμινα* denotes a tree with which European scholars are acquainted, while *sesamina* is only known to those who consult Oriental writers, or who are acquainted with the products of the East. Bochart rightly observes, 'Cave igitur ne quidquam mutes. Aliud enim hic *sesamina*

quam vulgo. Nempse ligna illius arboris quæ Arabicè *sasim* et *semsem* appellatur, et ita plurali *semasim*. Itaque Dioscoridis Arabs interpretis hic recte habet, &c. ساسيم *sesama*; and so

also 'Arrianus in *Periplo* meminit *φάλαγγων σησάμινων* καὶ ἐβένων, palangarum sesaminarum et ebeninarum, quæ ex Indiæ urbe Barygasis in Persidem afferuntur' (Bochart, *l. c.*). The above word is by Dr. Vincent translated *sesamum*; but this is an herbaceous oil plant.

If we look to the modern history of ebony, we shall find that it is still derived from more than one source. Thus, Mr. Holtzappel, in his recent work on Turning, describes three kinds of ebony. 1. One from the Mauritius, in round sticks like scaffold poles, seldom exceeding fourteen inches in diameter, the blackest and finest in the grain, the hardest and most beautiful. 2. The East Indian, which is grown in Ceylon and the Peninsula of India, and exported from Madras and Bombay in logs from six to twenty and sometimes even twenty-eight inches in diameter, and also in planks. This is less wasteful, but of an inferior grain and colour to the above. 3. The African, shipped from the Cape of Good Hope in billets, the general size of which is from three to six feet long, three to six inches broad, and two to four inches thick. This is the least wasteful, as all the refuse is left behind; but it is the most porous, and the worst in point of colour. No Abyssinian ebony is at present imported: this, however, is more likely to be owing to the different routes which commerce has taken, but which is again returning to its ancient channels, than to the want of ebony in the ancient Ethiopia. From the nature of the climate, and the existence of forests in which the elephant abounds, there can be no doubt of its being well suited to the group of plants which have been found to yield the ebony of Mauritius, Ceylon, and India, namely, the genus *Diospyros* of botanists. Of this several species yield varieties of ebony as their *heart-wood*, as *D. Ebenum* in the Mauritius, and also in Ceylon, where it is called *kaluwara*. It is described by Retz 'foliis ovato-lanceolatis, acuminatis, gemmis hirtis;' and he quotes as identical *D. glaberrima* (Fr. Rottb. Nov. Act. Havn. ii. p. 540, tab. 5). *D. Ebenaster* yields the bastard ebony of Ceylon, and *D. hirsuta*, the Calamander wood of the same Island, described by Mr. Holtzappel as of a chocolate brown colour, with black stripes and marks, and stated by him to be considered a variety of ebony. *D. Melanoxyylon* of Dr. Roxburgh is the ebony-tree of Coromandel, and is figured among Coromandel plants (f. No. 46): it grows to be a large tree in the mountainous parts of Ceylon, and in the Peninsula of India—in Malabar, Coromandel, and Orissa. The black part of the wood of this tree alone forms ebony, and is found only in the centre of large trees, and varies in quantity according to the size and age of the tree. The outside wood is white and soft, and is soon destroyed by time and insects, leaving the black untouched (Roxb. *Fl. Ind.* ii. p. 530). Besides these, there is in the Peninsula of India a wood called *blackwood* by the English, and *sit-sal* by the natives: it grows to an immense size, is heavy, close-grained, of a greenish black colour, with lighter coloured veins running in various directions. It is yielded

by the *Dalbergia latifolia*. To the same genus belongs the *Sissoo*, one of the most valued woods of India, and of which the tree has been called *Dalbergia Sissoo*. The wood is remarkably strong, of a light greyish hue, with darker coloured veins. It is called *Sissoo* and *Sheeshum* by the natives of India. This is the name which we believe is referred to by Arab authors, and which also appears to have been the original of the *Sesamina* of Dioscorides and of the Periplus. The name may be applied to other nearly allied woods, and therefore, perhaps, to that of the above *D. latifolia*. It is a curious confirmation of this that Forskål mentions that, in his time, شيشم *shishum*, with teak and ebony, was among the woods imported from India and Arabia. It is satisfactory to have apparently such satisfactory confirmation of the general accuracy of ancient authors, when we fully understand the subjects and the products of the countries to which they allude.—J. F. R.

HOG. [BOAR; SWINE.]

HONEY. In the Scripture there are three words denoting different sweet substances, all of which are rendered by 'honey' in the Authorized Version. These it is necessary to distinguish.

1. יַעַר *yaar*, which only occurs in 1 Sam. xiv. 25, 27, 29; Cant. v. 1; and denotes the honey of bees and that only.

2. נֶפֶת *nepeth*, honey that drops, usually associated with the comb, and therefore bee-honey. This occurs in Ps. xix. 10; Prov. v. 3; xxiv. 13; xxvii. 7; Cant. iv. 11.

3. דְּבֵשׁ *debesh*. This is the most frequent word. It sometimes denotes bee-honey, as in Judg. xiv. 8, but more commonly a vegetable honey distilled from trees, and called *manna* by chemists; also the syrup of dates, and even dates themselves. It appears also sometimes to stand as a general term for all kinds of honey.

We shall here confine our remarks to honey in general, and that of bees in particular, referring for the vegetable honey to **MANNA**, and for the date-honey to **DRINK**, **STRONG**.

It is very evident that the land of Canaan abounded in honey. It is indeed described as 'a land flowing with milk and honey' (Exod. iii. 8, &c.); and which we apprehend to refer to *all* the sweet substances which the different Hebrew words indicate, as the phrase seems too large to be confined to the honey of bees alone. Yet the great number of bees in Palestine has been noticed by many travellers; and they were doubtless still more common in ancient times when the soil was under more general cultivation. A recent traveller, in a sketch of the natural history of Palestine, names bees, beetles, and mosquitoes, as the insects which are most common in the country (Schubert, *Reise ins Morgenlande*, ii. 120).

The natural history of the bee, with illustrations of the passages of Scripture in which its name occurs, has been given under a distinct head [**BEE**]; and the use of honey in food, under another [**FOOD**]. The principal use of the present notice is therefore that of an index to the other articles in which the different parts of this large subject are separately investigated.

The 'wild honey' (μέλι ἄγριον) which with locusts, formed the diet of John the Baptist, was

probably the vegetable honey, which we refer to **MANNA**.

No travellers in the East have given us much information respecting the treatment of bees, or any peculiar modes of preparing the honey.

Honey was not permitted to be offered on the altar (Lev. ii. 11). As it is coupled with leaven in this prohibition, it would seem to amount to an interdiction of things sour and sweet. Aben Ezra and others allege that it was because honey partook of the fermenting nature of leaven, and when burnt yielded an unpleasant smell—qualities incompatible with offerings made by fire of a sweet savour unto the Lord. But Maimonides and others think it was for the purpose of making a difference between the religious customs of the Jews and the heathen, in whose offerings honey was much employed. The first-fruits of honey were, however, to be presented, as these were destined for the support of the priests, and not to be offered upon the altar.

Under the different heads to which we have referred, the passages of Scripture relating to honey are explained. The remarkable incident related in 1 Sam. xiv. 24-32, requires, however, to be here noticed. Jonathan and his party coming to the wood, find honey dropping from the trees to the ground, and the prince extends his rod to the honeycomb to taste the honey. On this the present writer is unable to add anything to what he has stated elsewhere (*Pictorial Bible*, in loc.), which is to the following effect:—First, we are told that the honey was on the ground, then that it dropped, and lastly, that Jonathan put his rod into the honeycomb. From all this it is clear that the honey was bee-honey, and that honey-combs were above in the trees, from which honey dropped upon the ground; but it is not clear whether Jonathan put his rod into a honeycomb that was in the trees or shrubs, or into one that had fallen to the ground, or that had been formed there.

Where wild bees are abundant they form their combs in any convenient place that offers, particularly in cavities or even on the branches of trees; nor are they so nice as is commonly supposed in the choice of situations. In India particularly, and in the Indian islands, the forests often swarm with bees. 'The forests,' says Mr. Roberts, 'literally flow with honey; large combs may be seen hanging on the trees, as you pass along, full of honey' (*Oriental Illustrations*). We have good reason to conclude, from many allusions in Scripture, that this was also, to a considerable extent, the case formerly in Palestine. Rabbi Ben Gershom and others indeed fancy that there were bee-hives placed 'all of a row' by the wayside. If we must needs have bee-hives, why not suppose that they were placed in the trees, or suspended from the boughs? This is a practice in different parts where bees abound, and the people pay much attention to realise the advantages which their wax and honey offer. The woods on the western coast of Africa, between Cape Blanco and Sierra Leone, and particularly near the Gambia, are full of bees, to which the negroes formerly, if they do not now, paid considerable attention for the sake of the wax. They had bee-hives, like baskets, made of reeds and sedge, and hung on the out-boughs of the trees, which the bees easily appropriated for the purpose

of forming their combs in them. In some parts these hives were so thickly placed that at a distance they looked like fruit. There was also much wild honey in the cavities of the trees (Jobson's *Golden Trade*, p. 30, in Astley's Collection). Moore confirms this account, and adds, that when he was there, the Mandingoes suspended in this way straw bee-hives not unlike our own, boarded at the bottom, and with a hole for the bees to go in and out (*Travels into the inland parts of Africa*, Drake's Collection). As to the other supposition, that the honeycomb had been formed on the ground, we think the context rather bears against it; but the circumstance is not in itself unlikely, or incompatible with the habits of wild bees. For want of a better resource they sometimes form their honey in any tolerably convenient spot they can find in the ground, such as small hollows, or even holes formed by animals. Mr. Burchell, in his *Travels in South Africa*, mentions an instance in which his party (Hottentots) obtained about three pounds of good honey from a hole which had formerly belonged to the weazel kind. The natives treated this as a usual circumstance, and indeed their experience in such affairs was demonstrated by the facility with which they managed to obtain the honey without being injured by the bees.

HOOK, HOOKS. The following Hebrew words are so rendered in the English Version:

חֶבֶק, חֶבֶקָה, וּ, מִזְלֵי, מְנוּמְרָה, שֶׁפְּתִימִים, צִנָּה, סִיר. The idea of a *thorn* enters into the etymology of several of them, probably because a thorn, *hooked* or straight, was the earliest instrument of this kind. Tacitus thus describes the dress of the ancient Germans, Sagum, fibula, aut si desit spina conserutum; a 'loose mantle, fastened with a clasp, or, when that cannot be had, with a thorn' (*Germ.* 17).

1. חֶבֶק; (2 Kings xix. 28). 'I will put my hook in thy nose.' Sept. *θῆσω τὰ ἄγκιστρα μου ἐν τοῖς μυκῆσσι σου*; Vulg. *circulum in naribus tuis*. In the parallel passage (Isa. xxxvii. 29) the Sept. reads, *καὶ ἐμβαλῶ φιδὸν εἰς τὴν βίνδ σου*, 'I will put my muzzle, halter, or noose,' &c. Jehovah here intimates his absolute control over Sennacherib, by an allusion to the practice of leading buffaloes, camels, dromedaries, &c., by means of a cord, or of a cord attached to a ring, passed through the nostrils (Shaw's *Travels*, pp. 167, 8, 2nd edit.); Job xli. 1 [xl. 25] 'Canst thou draw out Leviathan with a hook?' (חֶבֶק) occurs Isa. xix. 8, and Hab. i. 15; *ἄγκιστρον, hamum*) or his tongue with a cord which thou lettest down? Canst thou place a reed-cord (אֲנָכִי, comp. Gr. *σχοῖνος*) in his nose, or bore through his cheek with a thorn? (*clasp*, or possibly bracelet, &c.) Sept. *ἔξει δὲ δράκοντα ἐν ἄγκιστρῷ, περιθήσει δὲ φορβάλαν περὶ βίνα αὐτοῦ; ἢ δήσει κρίκον ἐν τῷ μυκῆτρῳ αὐτοῦ, ψελλίψ δὲ τρυπήσει τὸ χεῖλος αὐτοῦ*. 'Wilt thou draw out a dragon with a hook? Wilt thou bind a hand about his nose? Wilt thou fasten a ring in his nose, or bore his lip with a bracelet?' (Vulg. An extrahere poteris Leviathan hamo, et fune ligabis linguam ejus? Nunquid pones circulum in naribus ejus, aut armilla perforabis maxillam ejus?) 'Wilt thou put a ring in his nostrils, or bore through his cheek with a bracelet?' This passage in Job has undergone the following speculations 'see, for

instance, Harris's *Nat. Hist. of the Bible*, at. Leviathan, Lond. 1825). It has been assumed, that Bochart has completely proved the Leviathan to mean the *crocodile* (Rosenmüller on Bochart, vol. iii. 737, &c., 769, &c., Lips. 1796). Herodotus has then been quoted, where he relates that the Egyptians near Lake Mæris select a crocodile, render him tame, and suspend ornaments to his ears, and sometimes gems of great value; his fore-feet being adorned with *bracelets* (ii. 69); and the mummies of crocodiles, having their ears thus bored, have been discovered (Kenrick's *Egypt of Herodotus*, p. 97, Lond. 1841). Hence it is concluded that this passage in Job refers to the facts mentioned by Herodotus; and, doubtless, the terms employed, especially by the Sept. and Vulg., and the *third and following verses*, favour the supposition; for there the captive is represented as suppliant and obsequious, in a state of security and servitude, and the object of diversion, 'played with' as with a bird, and serving for the sport of maidens. Herodotus is further quoted to show that in his time the Egyptians captured the crocodile with a hook (*ἄγκιστρον*), with which (*ἐξελεύσθη εἰς τὴν γῆν*) he was drawn ashore; and accounts are certainly given by modern travellers of the continuance of this practice (Maillet, *Descrip. d'Egypte*, tom. ii. p. 127, ed. Hag., 1740). But does not the *entire description* go upon the supposition of the *impossibility* of so treating *Leviathan*? Supposing the allusions to be correctly interpreted, is it not as much as to say, 'Canst thou treat *him* as thou canst treat the crocodile and other fierce creatures?' Dr. Lee has, indeed, given reasons which render it *doubtful*, at least, whether the *leviathan does* mean the crocodile in this passage; or whether it does not mean some species of *whale*, as was formerly supposed; the *Delphinus orca* communis, or common grampus, found in the Mediterranean, the Red Sea, and also in the Nile. (See his examination of Bochart's reasonings, &c. in *Translation and Notes on Job*, pp. 197 and 529-539, Lond. 1837) [LEVIATHAN]. Ezek. xxix. 4 (יִיחֶק) 'I will put my hooks in thy jaws,' &c. (*παγίδας εἰς τὰς σιαγόνας; frænum in maxillis tuis*); 'and I will cause thee to come up out of the midst of thy rivers,' where the prophet foretells the destruction of Pharaoh king of Egypt, by allusions to the destruction, possibly, of a crocodile, the symbol of Egypt. Thus Pliny (*Hist. Nat.* viii. 25) states, that the Tentyritæ (inhabitants of Egypt) followed the crocodile, swimming after it in the river, sprung upon its back, thrust a bar into its mouth, which being held by its two extremities, serves—*ut frænus in terram agant*—as a bit, enables them to force it on shore (comp. Ezek. xxix. 3, 4). Strabo relates that the Tentyritæ displayed their feats before the Romans (xvii. p. 560, ed. Casaub.). But see Dr. Lee on this passage, *ut supra*.

2. יִיחֶק. (Exod. xxvi. 32, 37; xxxviii. 19), 'hooks,' *αἱ κεφαλίδες, capita, capita columnarum*; where the Sept. and Jerome seem to have understood the *capitals of the pillars*; and it has been urged that this is more likely to be the meaning than *hooks*, especially as 1775 shekels of silver were used in making these יִיחֶק for the pillars, overlaying the chapters, and filleting them (ch. xxxviii. 28); and that the *hooks* are really the יִיחֶק, *taches* (Exod. xxvi. 6, 11, 33, 35,

xxxix. 33). Yet the Sept. also renders קִרְכִּי , *κρίκοι*, 'rings,' or 'clasps' (Exod. xxvii. 10, 11, and *ἀγκύλαι*, Exod. xxxviii. 17, 19); and from a comparison of these two latter passages it would seem that these hooks, or rather tenters, rose out of the chapters or heads of the pillars.

3. מִזְלוֹךְ (1 Sam. ii. 13, 14), 'flesh-hook,' *κρέα-γρα*, *fuscinula*, and the מִזְלוֹנוֹת , 'the flesh-hooks' (Exod. xxvii. 3, and elsewhere). This was evidently in the first passage, a trident 'of three teeth,' a kind of fork, &c. for turning the sacrifices on the fire, and for collecting fragments, &c. (3.) מִזְמוֹרוֹת (Is. ii. 4, and elsewhere) 'beat their spears into pruning-hooks' (*δρέπανα*, *falces*). The Roman poets have the same metaphor (Martial, xiv. 34, 'Falx ex ense'). In Mic. iv. 3, in *ligones*, weeding-hooks, or shovels, spades, &c. Joel reverses the metaphor 'pruning-hooks' into spears (iii. 10, *ligones*); and so Ovid (*Fasti*, i. 697, in *pila ligones*). (4.) מִשְׁתִּים (Ezek. xl. 43), 'hooks,' which Gesenius explains *stalls* in the courts of the Temple, where the sacrificial victims were fastened: our translators give in the margin 'endirons, or the two hearth-stones.' The Sept. seems equally at a loss, *καὶ παλαιστὴν ἔξουσι γείσους*; as also Jerome, who renders it *labia*. Schleuser pronounces *γείσους* to be a barbarous word formed from גִּי , and understands *epistylium*, a little pillar set on another, and *capitellum*, columned. The Chaldee renders עֲוֹנֵקְלִין , short posts in the house of the slaughterers on which to suspend the sacrifices. Dr. Lightfoot, in his chapter 'on the altar, the rings, and the laver,' observes, 'On the north side of the altar were six orders of rings, each of which contained six, at which they killed the sacrifices. Near by were *low pillars* set up, upon which were laid overthwart beams of cedar; on these were fastened rows of *hooks*, on which the sacrifices were hung; and they were flayed on marble tables, which were between these pillars' (See vers. 41, 42; *Works*, vol. 11, ch. xxxiv., Lond. 1684-5-6.) צִנָּה (Amos iv. 2), 'take you away with hooks,' *ἄπολις*, *contis*, 'poles' or 'spears.' In the same verse, מִיֵּרוֹת רִוְנָה , 'fish-hooks,' *εἰς λέβητας ὑποκαίμενους ἐμβαλοῦσιν, ἐμπροσὶ λαίμοι, ἐτ̄ ὑλίκιας vestras in ollis ferventibus*, where both Sept. and Vulg. seem to have taken צִנָּה in the sense of a pot or caldron instead of a fish-hook.—J. F. D.

HOPHNI AND PHINEHAS, the sons of Eli, whose misconduct in the priesthood (as described in 1 Sam. ii. 12-17) brought down that doom of ruin and degradation upon the house of Eli which formed the first divine communication through the young Samuel (1 Sam. iii.). Hophni and Phinehas were slain in the battle in which the ark of God was taken by the Philistines, B.C. 1141 (1 Sam. iv. 11). [E.L.]

HOPHRA (הֹפְרָא ; Sept. *Ὀυαφρῆ*, or *ΡΗΑΡΩΗ-ΗΟΦΡΑ*), king of Egypt in the time of Zedekiah king of Judah, and of Nebuchadnezzar king of Babylon. He formed alliance with the former against the latter, and his advance with an Egyptian army constrained the Chaldeans to raise the siege of Jerusalem (Jer. xxxvii. 5); but they soon returned and took and destroyed the city. This momentary aid, and the danger of placing reliance on the protection of Hophra, led Ezekiel to compare the Egyptians to

a broken reed, which was to pierce the hand of him that leaned upon it (Ezek. xxix. 6, 7). This alliance was, however, disapproved by God; and Jeremiah was authorized to deliver the prophecy contained in his 4th chapter, which concludes with a prediction of Hophra's death and the subjugation of his country by the Chaldeans [comp. *Egypt*].

This Pharaoh-hophra is identified with the Apries or Vaphres of ancient authors, and he may be the Psamatik III. of the monuments. Under this identification we may conclude that his wars with the Syrians and Cyrenæans prevented him from affording any great assistance to Zedekiah. Apries is described by Herodotus (ii. 169) as a monarch who, in the zenith of his glory, felt persuaded that it was not in the power even of a deity to dispossess him of his kingdom, or to shake the stability of his sway; and this account of his arrogance fully accords with that contained in the Bible. Ezekiel (xxix. 3) speaks of this king as 'the great dragon that lieth in the midst of the rivers, which hath said, my river is mine own, and I have made it for myself.' His overthrow and subsequent captivity and death are foretold with remarkable precision by Jeremiah (xlv. 30); 'I will give Pharaoh-hophra, king of Egypt, into the hands of his enemies, and into the hands of them that seek his life.' This was brought about by a revolt of the troops, who placed Amasis at their head, and after various conflicts took Apries prisoner. He was for a time kept in easy captivity by Amasis, who wished to spare his life; but he was at length constrained to give him up to the vengeance of his enemies, by whom he was strangled (Herod. ii. 169; Wilkinson, *Anc. Egyptians*, i. 168-182).

HOR (הֹר , *הֹר*; Sept. *Ὀρ*), a mountain of Arabia Petrea, on the confines of Idumæa, and forming part of the mountain of Seir or Edom. It is only mentioned in Scripture in connection with the circumstances recorded in Num. xx. 22-29. The Israelites were encamped before it, when Aaron was summoned to its top to die there, in the presence of his brother and son, who alone witnessed his final departure [AARON].

The mountain now identified with Mount Hor is the most conspicuous in the whole range of Mount Seir, and at this day bears the name of Mount Aaron (Jebel Haroun). It is in N. lat. 30° 18' E. long. 35° 33' about mid-way between the Dead Sea and the Ælanitic Gulf. It may be open to question if this is really the Mount Hor on which Aaron died, seeing that the whole range of Seir was anciently called by that name; yet, from its height and the conspicuous manner in which it rises among the surrounding rocks, it seems not unlikely to have been the chosen scene of the high-priest's death (Kinnear, p. 127). To this may be added that Josephus affirms Mount Hor to have been near Petra; and near that place there is certainly no mountain which can contest the distinction with the one now in view. The base of the highest pinnacle of this mountain is in fact but a little removed from the skirts of the city to the westward. The account of it given twenty years since by Captains Irby and Mangles, in their then unpublished volume of *Travels*, is the best we yet possess, and we therefore present the substance of their description in their own words.

'We engaged an Arab shepherd as our guide, and leaving Abou Raschid with our servants and horses where the steepness of the ascent commences, we began to mount the track, which is extremely steep and toilsome, and affords but an indifferent footing. In some parts the pilgrim must pick his way as he can, and frequently on his hands and knees. Where by nature it would have been impassable there are flights of rude steps or inclined planes, constructed of stones laid together, and here and there are niches to receive the footsteps, cut in the live rock: the impressions of pilgrims' feet are scratched in the rock in many places, but without inscriptions. Much juniper grows on the mountain, almost to the very summit, and many flowering plants which we had not observed elsewhere; some of these are very beautiful; most of them are thorny.

On the top there is an overhanging shelf in the rock which forms a sort of cavern: here we found a skin of extremely bad water suspended for drinking, and a pallet of straw, with the pitcher and other poor utensils of the sheikh who resides here. He is a decrepit old man, who has lived here during the space of forty years, and occasionally endured the fatigue of descending and re-ascending the mountain. The tomb itself is enclosed in a small building, differing not at all in external form and appearance from those of Mahomedan saints common throughout every province of Turkey. It has probably been rebuilt at no remote period: some small columns are bedded in the walls, and some fragments of granite and slabs of white marble are lying about. The door is near the south-west angle, within which a constructed tomb, with a pall

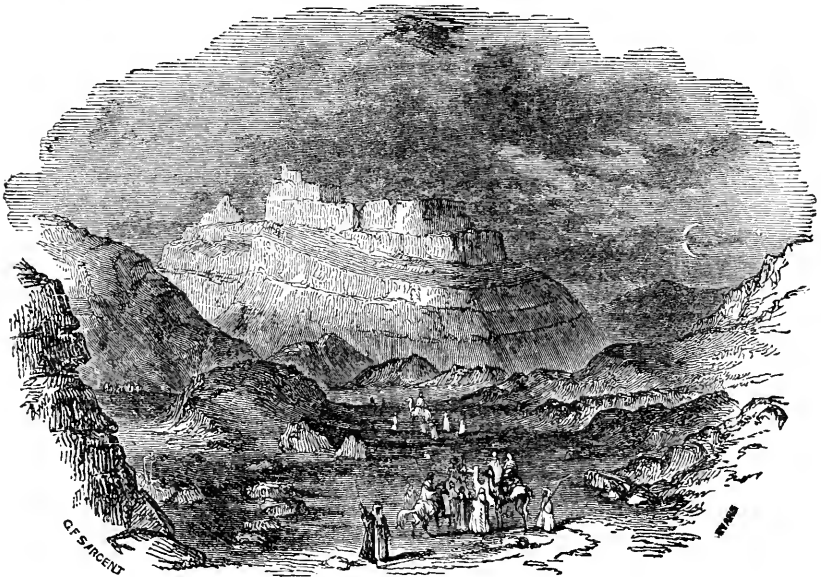

342. [Mount Hor.]

thrown over it, presents itself immediately upon entering: it is patched together out of fragments of stone and marble that have made part of other fabrics. Upon one of these are several short lines in the Hebrew character, cut in a slovenly manner: we had them interpreted at Acre, and they proved to be merely the names of a Jew and his family who had scratched this record. It is not probable that any professed Jew has visited the spot for ages past, probably not since the period of the Mahomedan conquest; it may lay claim, therefore, to some antiquity, and in any case is a curious appendage to the testimony of Josephus on the subject. There are rags and shreds of yarn, with glass heads and paras, left as votive offerings by the Arabs.

'Not far from the north-west angle is a passage, descending by steps to a vault or grotto beneath, for we were uncertain which of the two to call it, being covered with so thick a coat of whitewash that it is difficult to distinguish whether it is built

or hollowed out. It appeared, in great part at least, a grotto; the roof is covered, but the whole is rude, ill-fashioned, and quite dark. The sheikh, who was not informed that we were Christians, furnished us with a lump of butter. Towards the further end of this dark vault lie the two corresponding leaves of an iron grating, which formerly prevented all nearer approach to the tomb; they have, however, been thrown down, and we advanced so as to touch it; it was covered by a ragged pall. We were obliged to descend barefoot, and were not without some apprehension of treading on scorpions or other reptiles in such a place.'

It is highly interesting to know what view it was which last greeted the eyes of the dying high-priest from this lofty eminence; and it is the more so from the fact that the regions over which the view extends is that in which the Israelites wandered for forty years. Our travellers supply this information:—

'The view from the summit of the edifice is extremely extensive in every direction, and the eye rests on few objects which it can clearly distinguish to give a name to, although an excellent idea is obtained of the general face and features of the country. The chain of Idumæan mountains, which form the western shore of the Dead Sea, seem to run on to the southward, though losing considerably in their height. They appear in this point of view barren and desolate. Below them is spread out a white sandy plain, seamed with the beds of occasional torrents, and presenting much the same features as the most desert parts of the Ghor. Where this desert expanse approaches the foot of Mount Hor, there arise out of it, like islands, several lower peaks and ridges, of a purple colour, probably composed of the same kind of sandstone as that of Mount Hor itself, which, variegated as it is in its hues, pre-sets in the distance one uniform mass of dark purple. Towards the Egyptian side there is an expanse of country without features or limit, and lost in the distance. The lofty district which we had quitted in our descent to Wady Mousa shuts up the prospect on the south-east side; but there is no part of the landscape which the eye wanders over with more curiosity and delight than the crags of Mount Hor itself, which stand up on every side in the most rugged and fantastic forms, sometimes strangely piled one on the other, and sometimes as strangely yawning in cliffs of a frightful depth. . . . An artist who would study rock-scenery in all its wildest and most extravagant forms would find himself rewarded should he resort to Mount Hor for that sole purpose.'

MOREB. [SINAI.]

HOR-HAGIDGAD, an encampment of the Israelites during their wandering (Num. xxxiii. 32, 33) [WANDERING].

HORTES, or HORIM, the people who inhabited Mount Seir before the Edomites [ΙΡΟΥΜÆΑ].

HORN (קַרְנֹת; Gr. κέρας; Lat. cornu), from its primary use for defence in the case of horned animals (whence Anacreon's *Φύσις κέρατα ταύρους*), came to acquire several derivative meanings, some of which are connected with the illustration and right understanding of holy writ. As horns are hollow and easily polished, they have in ancient and modern times been used for drinking-vessels and for military purposes; and as they are the chief source of strength for attack and defence with the animals to which God has given them, they serve in Scripture as emblems of power, dominion, glory, and fierceness (Dan. viii. 5, 9; 1 Sam. xvi. 1, 13; 1 Kings i. 39; Josh. vi. 4, 5; 1 Sam. ii. 1; Ps. lxxv. 5, 10; Jer. xlviii. 25; Ezek. xxix. 21; Amos vi. 13). Hence to defile the horn in the dust (Job xvi. 2), is to lower and degrade oneself, and, on the contrary, to lift up, to exalt the horn (Ps. lxxv. 4; lxxix. 17; cxlviii. 14), is poetically to raise oneself to eminent honour or prosperity, to bear oneself proudly. Something like this is found in classic authors; thus Horace (*Carm.* iii. 21, 18) says,

'Tu spem reducis mentibus anxii
Viresque, et addis cornua pauperi.'

In the East, at present, horns are used as an ornament for the head, and as a token of eminent rank

Rosenmüller, *Morg.* iv. 85). The women among the Druses on Mount Lebanon wear on their heads silver horns of native make, 'which are the distinguishing badge of wifehood' (Bowling's *Report on Syria*, p. 8).



343.

By an easy transition, horn came to denote an elevation or hill (Isa. v. 1); in Switzerland mountains still bear this name, thus, Schreckhorn, Buchhorn. The altar of burnt-offerings (Exod. xxvii. 2) and the altar of incense (Exod. xxx. 2), had each at the four corners four horns of shittim-wood, the first being overlaid with brass, the second with gold (Exod. xxxvii. 25; xxxviii. 2; Jer. xvii. 1; Amos iii. 14). Upon the horns of the altar of burnt-offerings was to be smeared with the finger the blood of the slain bullock (Exod. xxix. 12; Lev. iv. 7-18; viii. 15; ix. 9; xvi. 18; Ezek. xlili. 20). By laying hold of these horns of the altar of burnt-offering the criminal found an asylum and safety (1 Kings i. 50; ii. 28). These horns are said to have served as a means for binding the animal destined for sacrifice (Ps. cxvii. 27); but this use Winer (*Handwörterb.*) denies, asserting that they did not and could not answer for such a purpose.

The old painters represented the head of Moses as having two horns proceeding from his temples, one on either side. This practice arose from a mis-translation on the part of the Vulgate of the words found in Exod. xxxiv. 29—*cornuta esset facies sua*, where it is said in the Common Version 'the skin of his face shone.' The Septuagint seems to have given a good rendering—*δεδοξασται ἡ ὄψις τοῦ χρωμάτων*, 'the appearance of his face wore a glory,' or 'nimbus,' that is, rays parting from his head as from a centre, as the Saviour, and, in the Roman Catholic Church, the saints, are often painted—an appearance derived from Moses' interview with God, and designed to convince the Israelites (Rosenmüller, *in loc.*). In a somewhat similar manner the Deity is said (Habak. iii. 4) to have 'had horns coming out of his hands,' that is to say, he was made manifest by lightning and thunder (fulmina).—J. R. B.

HORNET, WASP. (ΚΡΑΒΡΟΝ, Exod. xxiii. 28, Deut. vii. 20; Sept. τὰς σφηκίας; Vulg. *crabrones*; Josh. xxiv. 12, τὴν σφηκίαν, *crabronem*; Wisd. Sol. xii. 8, σφηκίας, *vespas*, 'wasps'). The Greek words *ἀσθήνη* and *σφήξ* are given in the lexicons as signifying both 'hornet' and 'wasp,' especially the former of them (Stephens, Scapula,

s. v.), and the Latin *vespa* as denoting the 'wasp,' and *crabro* the 'hornet' (Faccioliati, *Lex. s. v.*) But Harduin contends that that which is *vespa* with the Latins is properly with the Greeks *ἀνθήρη* (Gallicé, *une guêpe*), and not *σφήξ*, as was thought by Gaza and Scaliger; and urges that on this point so learned a Latin author as Pliny ought to be considered sufficient evidence; that he ascribes to the *vespæ* those things which Aristotle (*Hist. Anim.* v. 19. 617; ix. 65. 66) ascribes to the *ἀνθήρηαι*; and, further, that he also ascribes to the *crabrones* those things which Aristotle ascribes to the *σφήκες* (comp. Arist. *ut supra*; Pliny, *Hist. Nat.* xi. 24. ed. Harduin, ii. p. 1741). The word *crabrones* Harduin accordingly explains, 'Græcis, *σφήκες*; Gallis, *des frelons*, hornets.' If this criticism be just, it vindicates both Jerome's translation of the three first words, and the English also. Our confidence in the definiteness of the Sept. rendering becomes increased when it is remembered that the Pentateuch, the most accurate portion of the whole version, was translated probably within fifty years after the death of Aristotle. Certainly the known characteristics of the hornet agree with the descriptions given of the *σφήξ* by Aristotle, and of the *crabro* by Pliny. 'The *ἀνθήρηαι* do not live by the nutriment collected from flowers, as the bees, but prey upon many kinds of flesh; whence also they frequent manure, for they pursue the great flies, and when they have caught them, having removed the head, they fly away, carrying the rest of the body' (*Hist. Anim.* ix.). Again:—*αἱ μὲν ἀνθήρηαι, ἐπὶ μετεώρου τινός· οἱ δὲ σφήκες, ἐν τρώγλῃ (ποιούσι κηρία)*, 'The *ἀνθήρηαι* build their nests in some elevated place, but the *σφήκες* in a hole or cavity' (v. 19). The description of Pliny is nearly a translation of the above:—'*Vespe* in sublimi nidus faciunt, crabrones in cavernis, aut sub terra;' on which Cuvier remarks, 'Sæpe sub tectis, aliquando sub terra vespæ; in *cavis arboribus* crabrones, ædificant' (Plin. *Libri de Animal.* curante J. B. Fr. S. Ajasson De Grandsagne, cum notis a Cuvier, Paris, 1838, p. 424, n. 2).

Still it must be noticed that, as Harduin remarks, with wonder, Pliny, when speaking of the *ichneumones*, a lesser species of hornet, calls them *vespæ*, while Aristotle, in the corresponding description, calls them *σφήκες* (N. 10). It would hence seem probable that the word *vespa* was sometimes used in an analogical and more comprehensive sense by Pliny; which may account for a similar variation in Jerome's rendering, '*vespas*' (*Wisdom* xii. 8). Even the Greek word had already undergone great abuse, for Hesychius, 150 years before Jerome, explains *ἀνθήρη* by *εἶδος μέλισσας*, 'a species of bee'; and Suidas, in the eleventh century, explains it as a species of wasp, and observes that the poets misapplied the word to the *bee* (see also *Hom. Il.* xiii. 167). It being upon the whole most probable, therefore, that 'the hornet' is the true rendering in these passages of Scripture, the only further question which remains is, whether the word is to be taken as literally meaning this well-known and terrific insect, or whether it is to be understood in a metaphorical and figurative sense for diseases, supernatural terror, &c. by which Jehovah 'drove out the Hivites, Canaanites and Hittites from before Israel.' Among the moderns, Michaelis has defended the figurative sense. In addition to other reasons for it, he doubts whether the

expulsion of the Canaanites *could* be effected by swarms of *σφήκίαι*, and proposes to derive the Hebrew from a root signifying 'scourges,' 'plagues,' *scutica*, *plaga*, &c. (*Suppl. ad Lexic. Hebr.* vi. 2154); but his reasons are ably refuted by Rosenmüller, apud Bochart (*Hieroz.* Lips. 1796, iii. ch. 13, p. 402, &c.). In favour of the possibility of such an event it is observed, that Elihu relates that the Phaselitæ were actually driven from their locality by such means (*φασηλίτας δὲ σφήκες κ. τ. λ.* *Hist. Anim.* ix. 28), and Bochart has shown that these Phaselitæ were a Phœnician people (ut supra, p. 412). Even Rosenmüller himself adopts the figurative sense in his *Scholia* on Exod. xxiii. 28; but on Josh. xxiv. 12 he retracts that opinion, and amply refutes it. His reasonings and refutations have been adopted by numerous writers (among others, see Paxton's *Illustrations of Scripture*, i. 303, &c.; Edin. 1819). Michaelis's doubt of the abstract possibility seems very unreasonable, when the irresistible power of bees and wasps, &c., attested by numerous modern occurrences, and the thin and partial clothing of the Canaanites, are considered. It is observable that the event is represented by the author of the book of Wisdom as a merciful dispensation, by which the Almighty, he says, 'spared as men, the old inhabitants of his holy land,' and 'gave them place for repentance.' If the hornet, considered as a *fly*, was in any way connected with their idolatry, the visitation would convey a practical refutation of their error [see Baalzebub, under *BAAL*]. It may be remarked, that the hornet, no less than the whole species of wasps, renders an essential service, in checking the multiplication of flies and other insects, which would otherwise become intolerable to man; and that in regard to their architecture, and especially their *instincts* and *habits*, they do not yield to their more popular congener, the bee, but even, in several respects, greatly excel it (Kirby and Spence, *Introduction to Entomology*, Svo. Lond. 1828, i. 273, 274; Réaumur, *Mémoire pour servir à l'Histoire des Insectes*, vol. vi. Mem. 6, *pour des Guespes*, 4to. Par. 1734-42).—

J. F. D.

HORSE (סוּס *sus*; Gr. ἵππος; Turkish *sukh*; Gen. xlvii. 17; xlix. 17; Exod. xiv. 9, 23, and in many other places; James iii. 3; Rev. vi. 2, &c. Other names and epithets occur in the Hebrew, as פָּרָשׁ *parash*, a 'saddle and chariot horse,' Isa. xxi. 7, 9; פָּרָשִׁים *parashim*, 'Persians' or 'horsemen;' רֶחֶשׁ *rechesh*, the 'swift,' Mic. i. 13; רַחָב *rachab*, 'cavalry,' or 'a group of war chariots,' Gen. i. 9; 2 Sam. viii. 4; רָמָךְ *ramach*, 'a mare'?) (Esth. viii. 10; and אַבְּרִים *abbirim*, 'mighty or strong ones,' Judg. v. 22; Jer. viii. 16). In the present writer's remarks upon the Hebrew names of the horse, contained in Sir W. Jardine's *Naturalist's Library* (vol. xii., Introduction, pp. 78-81), several are pointed out as of foreign origin. By the subsequent observations in the same work, it appears to be substantiated, that the horse was derived from High Asia, and was not indigenous in Arabia, Syria, or Egypt. They are not mentioned among the presents which Pharaoh bestowed upon Abraham, and occur in Scripture for the first time when the patriarch Joseph receives them from the Egyptians in exchange for bread (Gen. xlvii. 17)—evidently as valuable animals, disposed of singly, and not in

droves or flocks, like cattle and asses. They were still sufficiently important to be expressly mentioned in the funeral procession which accompanied the body of Jacob to his sepulchre in Canaan (Gen. l. 9); and, for centuries after, it does not

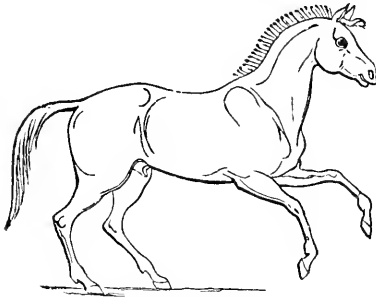

344. [Egyptian Horse.]

appear that, under the domestic management of the Egyptians, unless the murrain had greatly reduced them, horses had multiplied as they would have done in a land more congenial to their habits, since only six hundred chariots appear to have pursued Israel (Exod. xiv. 7);—even admitting that there were other chariots and horsemen not included in that number. In the sculptured battle-scenes, which are believed to represent victories of Sesostris, or of Thothmes II. and III., over nations of Central Asia, it is evident that the enemy's armies, as well as the foreign allies of Egypt, are abundantly supplied with horses, both for chariots and for riders; and in triumphal processions they are shown as presents or tribute—proving that they were portions of the national wealth of conquered states sufficiently valuable to be prized in Egypt. At a later period, the books of Deuteronomy (xvii. 16, for the future kings of Israel are forbidden to possess many)

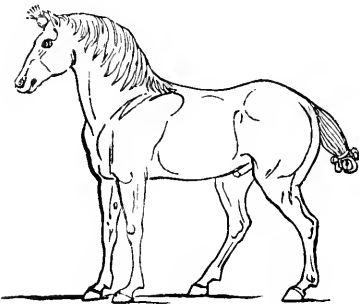

345 [Persian Horse.]

and Joshua (xi. 4) furnish similar evidence of abundance of horses in the plains of Syria; and in Job occurs a description of a perfect war-horse couched in the bold figurative language of inspiration, such as remains unequalled by any other poet, ancient or modern. Though the Israelites had chariots and horsemen opposed to them in the plain country from their first entrance into the land of promise; as in Judges iv. 15, where we find Sisera with his chariots of war defeated at the foot of Mount Tabor; yet not being

intended to make military conquests beyond the mountain basin and the adjacent territory assigned them, they long remained without cavalry or chariots themselves (Deut. xvii. 16; 2 Sam. viii. 4): they obeyed the divine injunction to abstain from possessing horses, and, to the time of David, ham-strung such as they captured from their enemies. It appears, however, that a small cavalry force was raised by him; and as, in all the military operations of Western Asia, there was a tendency to increase the mounted force and neglect the infantry, on the full establishment of royalty, when the Hebrew government acquired a more political structure, the reign of Solomon displayed a military system which embraced a regular body of horse and of chariots, evidently become the more necessary, since the limits of his sway were extended to the shores of the Arabian Gulf, and far into the Syrian desert (1 Kings x. 26). Solomon likewise acted with commercial views in the monopolizing spirit which Eastern sovereigns have been prone to exercise in all ages.

He bought chariots and teams of horses in Egypt, and probably in Armenia, 'in all lands,' and had them brought into his dominions in strings, in the same manner as horses are still conducted to and from fairs: for this interpretation, as offered by Professor Paxton, appears to convey the natural and true meaning of the text; and not 'strings of linen yarn,' which here seem to be out of place (2 Chron. i. 16, 17; ix. 25, 28).

The Tyrians purchased these objects from Solomon, and, in the time of Ezekiel, imported horses themselves from Togarmah or Armenia. On returning from the Babylonish captivity, the common possession of horses in Palestine was no longer opposed; for Nehemiah numbers seven hundred and thirty-six belonging to the liberated Hebrews (Neh. vii. 68).

All the great original varieties or races of horses were then known in Western Asia, and the Hebrew prophets themselves have not unfrequently distinguished the nations they had in view, by means of the predominant colours of their horses—and that more correctly than commentators have surmised. Taking Bochart's application of the Hebrew names, the bay race, אָדוֹם *adom*, emphatically belonged to Egypt and Arabia Felix; the white, לְבָנִים *lebanim*, to the regions above the Euxine Sea, Asia Minor, and northern High Asia; the dun, or cream-coloured, שְׂרָקִים *serukim*, to the Medes; the spotted piebald, or skewbald, בְּרָדִים *berudim*, to the Macedonians, the Parthians, and later Tahtars; and the black, שְׁחֹרִים *shachorim*, to the Romans; but the chestnuts, אֲמוֹץ *amutz*, do not belong to any known historical race (Zech. i. 8; vi. 2).

Bay or red horses occur most frequently on Egyptian painted monuments, this being the primitive colour of the Arabian stock; but white horses are also common, and, in a few instances, black—the last probably only to relieve the paler colour of the one beside it in the picture. There is also, we understand, an instance of a spotted pair, tending to show that the valley of the Nile was originally supplied with horses from foreign sources, and distinct regions, as indeed the tribute pictures further attest. The spotted, if not real, but painted horses, indicate the antiquity of a practice still in vogue; for staining the hair of riding animals with spots of various colours, and

dyeing their limbs and tails crimson, is a practice of common occurrence in the East, and was exemplified in London when the late Shah of Persia presented the Prince Regent with several white and grey horses, all of which were ridden to Carlton Palace with their tails dyed crimson, as we ourselves witnessed [Ass].

On the natural history of the horse there is no occasion to enter in this place; but it may be proper to notice that the riding bridle was long a mere slip-knot, passed round the under jaw into the mouth, thus furnishing only one rein; and that a rod was commonly added to guide the animal with more facility. The bridle, however, and the reins of chariot-horses were, at a very early age, exceedingly perfect; as the monuments of Egypt, Etruria, and Greece, amply prove. Saddles were not used, the rider sitting on the bare back, or using a cloth or mat girded on the animal. The Romans, no doubt copying the Persian Cataphractæ, first used pad saddles, and from the northern nations adopted stimuli or spurs. Stirrups were unknown. Avicenna first mentions the *rikiah*, or Arabian stirrup, perhaps the most ancient; although in the tumuli of Central Asia, Tahtar horse skeletons, bridles, and stirrup saddles, have been found along with idols; which proves the tombs to be more ancient than the introduction of Islam. With regard to horse-shoeing, Bishop Lowth and Bracy Clark were mistaken in believing that the Roman horse or mule shoe was fastened on without nails driven through the horny part of the hoof, as at present. A contrary conclusion may be inferred from several passages in the poets; and the figure of a horse in the Pompeii battle mosaic, shod in the same manner as is now the practice, leaves little doubt on the question. The preceding cuts represent ancient Persian and Egyptian horses, both taken from antique bas-reliefs.—C. H. S.

HORSE-LEECH. [ALUKAH.]

HOSANNA (הוֹשִׁיעָה נָא); New Test. Ὡσαννά), a form of acclamatory blessing or wishing well, which signifies, Save now! Succour now! Be now propitious! It occurs in Matt. xxi. 9 (also Mark xi. 9, 10; John xii. 13)—‘Hosanna to the Son of David; Blessed is he that cometh in the name of the Lord; Hosanna in the highest.’ This was on the occasion of our Saviour’s public entry into Jerusalem, and fairly construed, would mean, ‘Lord, preserve this Son of David; heap favours and blessings on him!’ It is further to be observed that Hosanna was a customary form of acclamation at the Feast of Tabernacles. This feast was celebrated in September, just before the commencement of the civil year; on which occasion the people carried in their hands bundles of boughs of palms, myrtles, &c. (Joseph. *Antiq.* xiii. 13. 6; iii. 10. 4). They then repeated the 25th and 26th verses of Ps. cxviii., which commence with the word Hosanna; and from this circumstance they gave the boughs, and the prayers, and the feast itself, the name of Hosanna. They observed the same forms also at the Encenia (1 Macc. x. 6, 7; 2 Macc. cxiii. 51; Rev. vii. 9) and the Passover. And as they celebrated the Feast of Tabernacles with great joy and gladness, in like manner, on this occasion, did they hail the coming of the Messiah, whose advent they believed to be represented in all the feasts.

HOSEA (הוֹשֵׁעַ), the first in order of the minor prophets in the common editions of the Hebrew Scriptures, as well as of the Alexandrian and Vulgate translations. The arrangement of the other writers, in the *Δωδεκαπρόφητων* of the Greek version, differs considerably from that of the Hebrew copies. Jerome (*Pref. in XII. Prophetas*) says, ‘Non idem est ordo duodecim prophetarum apud Hebræos qui est apud nos.’ Both, however, place Hosea first in the catalogue; yet the reasons often assigned for the priority of place which this prophet enjoys are by no means satisfactory. They are founded on a misinterpretation of the first clause of the second verse of his oracles, תְּהַלֵּל דְּבַר יְהוָה, ‘the beginning of the word of the Lord.’ Hengstenberg (*Christology*, Keith’s translation, vol. ii. p. 23), denying, against Winer and Gesenius, that דְּבַר is a noun, and taking it to be the præter of הִלֵּל, renders the clause, ‘the beginning of the Lord hath spoken;’ the status constructus of תְּהַלֵּל, according to him, being explained by the fact ‘that the whole following proposition is treated as one substantive idea.’ But this phraseology has reference not to priority of time in Hosea’s commission as compared with other prophets, but to the early period of the predictions to which it is the introduction. It is merely an intimation that they were the first divine communications which the son of Beeri enjoyed. Neither did Hosea flourish earlier than all the other minor prophets: the very early era assigned to him by the Jewish writers and other expositors of former times are altogether extravagant. By the best computation he seems to have been preceded by Joel, Amos, and Jonah. The prophets are thus arranged by De Wette (*Einleitung*, § 225):—

Hebrew Text.	Greek Text.
1. Hosea.	1. Hosea.
2. Joel.	2. Amos.
3. Amos.	3. Micah.
4. Obadiah.	4. Joel.

Chronological Order.

1. Joel, about 810 B.C.
2. Jonah „ 810 B.C.
3. Amos „ 790 B.C.
4. Hosea „ 785 B.C.

The table given by Rosenmüller (*Scholia in Min. Proph.* p. 7) differs from this only in placing Jonah before Joel in chronological order. Compare Newcome (*Preface to Minor Prophets*, p. 45). The probable causes of this location of Hosea may be the thoroughly national character of his oracles, their length, their earnest tone and vivid representations: because he discharged the duties of his office for a longer period than any of his prophetic associates, is the less natural conjecture which has been hazarded by Rosenmüller. The contour of Hosea’s book has a closer resemblance to the greater prophets than any of the eleven productions by which it is succeeded.

The name of this prophet has been variously interpreted. Jerome erroneously renders it ‘Salvator.’ It may be either the infinitive absolute, ‘Salvando,’ or the imperative, ‘Salva’ (O Deus). It is ordinarily written in Greek, Ὡσηέ, and once with the initial aspirate, Ὡσηέ (Rom. ix. 25). The figments of Jewish writers regarding Hosea’s parentage need scarcely be mentioned. His father, יְהוֹאָחָז, has been confounded with בְּאָרָה, a prince

of the Reubenites, 1 Chron. v. 6. So, too, Beerl has been reckoned a prophet himself, according to the rabbinical notion that the mention of a prophet's father in the introduction to his prophecies is a proof that sire as well as son was endowed with the oracular spirit.

Whether Hosea was a citizen of Israel or Judah has been disputed. The pseudo-Epiphanius and Dorotheus of Tyre speak of him as being born at Belemoth, in the tribe of Issachar (Epiph. *De Vitis Prophet.* cap. xi.; Doroth. *De Proph.* cap. i.). Drusius (*Critici Sacri*, in loc., tom. v.) prefers the reading 'Beth-semes,' and quotes Jerome, who says, 'Osee de tribu Issachar fuit ortus in Beth-semes.' But Maurer contends strenuously that he belonged to the kingdom of Judah (*Comment. Theol.*, ed. Rosenmüller, vol. ii. p. 391); while Jahn supposes that he exercised his office, not, as Amos did, in Israel, but in the principality of Judah. Maurer appeals to the superscription in Amos as a proof that prophets of Jewish origin were sometimes commissioned to labour in the kingdom of Israel (against the appeal to Amos, vide Credner, *Joel*, p. 66, and Hitzig, *Handb. Kurze. exeget. zum A. T.* p. 72). But with the exception of the case recorded in 1 Kings xiii. 1 (a case altogether too singular and mysterious to serve as an argument), the instance of Amos is a solitary one, and seems to have been regarded as anomalous by his contemporaries (Amos vii. 12). Neither can we assent to the other hypothesis of Maurer, that the mention of the Jewish kings Uzziah, Jotham, Ahaz, and Hezekiah, by Hosea in his superscription, is a proof that the seer regarded them as his rightful sovereigns, as monarchs of that territory which gave him birth. Hengstenberg has well replied, that Maurer forgets 'the relation in which the pious in Israel generally, and the prophets in particular, stood to the kingdom of Judah. They considered the whole separation, not only the religious, but also the civil, as an apostasy from God. The dominion of the theocracy was promised to be the throne of David.' The lofty Elijah, on a memorable occasion, when a direct and solemn appeal was made to the head of the theocracy, took *twelve* stones, one for each tribe—a proof that he regarded the nation as one in religious confederation. It was also necessary, for correct chronology, that the kings of both nations should be noted. Jeroboam of Israel is mentioned as a means of ascertaining at what period in the long reign of Uzziah Hosea began to prophesy, and Uzziah's successors are named in particular, because the confusion and anarchy of the several interregna in the kingdom of Israel rendered computation by the names of Jeroboam's successors very awkward, difficult, and uncertain. The other argument of Maurer for Hosea's being a Jew, viz. because his own people are so severely threatened in his reproofs and denunciations, implies a predominance of national prepossession or antipathy in the inspired breast which is inconsistent with our notions of the piety and patriotism of the prophetic commission (Knobel, *Der Prophetismus der Hebräer*, vol. i. p. 263). So that we accede to the opinion of De Wette, Rosenmüller, Hengstenberg, Eichhorn, Manger, Uhland, and Kuinoel, that Hosea was an Israelite, a native of that kingdom with whose sins and fates his book is specially and primarily occupied.

There is no reason, with De Wette, Maurer, and Hitzig, to doubt the genuineness of the present superscription, or, with Rosenmüller and Jahn, to suppose that it may have been added by a later hand—though the two last writers uphold its authenticity. The first and second verses of the prophecy are so closely connected in the structure of the language and style of the narration, that the second verse itself would become suspicious, if the first were reckoned a spurious addition. The superscription determines the length of time during which Hosea prophesied. That period was both long and eventful, commencing in the days of Jeroboam, the son of Joash, extending through the lives of Uzziah, Jotham, Ahaz, and concluding in the reign of Hezekiah. Uzziah and Jeroboam were contemporary sovereigns for a certain length of time. If we compute from the first year of Uzziah to the last of Hezekiah, we find a period of 113 years. Such a period appears evidently to be too long, and the most probable calculation is to reckon from the last years of Jeroboam to the first of Hezekiah.

We have then at least of Uzziah's reign 26 years.

"	"	Jotham	"	16	"
"	"	Ahaz	"	16	"
"	"	Hezekiah	"	2	"
				—	
				60*	

This calculation is as close an approximation as it is now possible to obtain. At some point within the last fourteen years of Jeroboam Hosea began to prophesy. From the death of Jeroboam to the beginning of Hezekiah, at an ordinary calculation, are fifty-seven or fifty-eight years. Bishop Horsley extends the period considerably longer (*Commentary on Hosea: Works*, vol. iii. p. 234). We do not understand the principle of Rosenmüller's computation, which reduces the time between Jeroboam's death and Hezekiah's accession to a period of almost forty years. We agree with Maurer's remark (*Comment. Gram. Hist. Crit. in Prophetas Minores*, Lipsiæ, 1840), 'Alii annos quadraginta numerant nescio quem computandi modum secuti.' This long duration of office is not improbable, and the book itself furnishes strong presumptive evidence in support of this chronology. The first prophecy of Hosea foretells the overthrow of Jehu's house; and the menace was fulfilled on the death of Jeroboam, his great-grandson. 'This was the word of the Lord which he spake unto Jehu, saying, Thy sons shall sit on the throne of Israel unto the fourth generation; and so it came to pass' (2 Kings xv. 12). A prediction of the ruin which was to overthrow Jehu's house at Jeroboam's death, must have been uttered during Jeroboam's life. This fact defines the period of Hosea's commencement of his labours, and verifies the inscription, which states that the word of the Lord came to him in the reign of Jeroboam, the son of Joash, king of Israel. Again, in ch. x. 14, allusion is made to an expedition of Shalmanezar against Israel; and if it was the first inroad against king Hoshea, who began to reign in the twelfth year of Ahaz, the event referred to by the prophet as past must have happened close upon the beginning of the govern-

* Maurer, in the *Comment. Theol.* p. 284, and more lately in his *Comment. Gram. Hist. Crit. in Proph. Min.*, Lipsiæ, 1840.

ment of Hezekiah (2 Kings xvii. 5). Data are thus in like manner afforded to corroborate the statement that Hezekiah had ascended the throne ere the long-lived servant of Jehovah was released from his toils. The extended duration indicated in the superscription is thus borne out by the contents of the prophecy.

The years of Hosea's life were melancholy and tragic. The vials of the wrath of heaven were poured out on his apostate people. The nation suffered under the evils of that schism which was effected by the craft of him who has been branded with the indelible stigma—'Jeroboam, who made Israel to sin.' The obligations of law had been relaxed, and the claims of religion disregarded; Baal became the rival of Jehovah, and in the dark recesses of the groves were practised the impure and murderous rites of heathen deities; peace and prosperity fled the land, which was harassed by foreign invasion and domestic broils; might and murder became the twin sentinels of the throne; alliances were formed with other nations, which brought with them seductions to paganism; captivity and insult were heaped upon Israel by the uncircumcised; the nation was thoroughly debased, and but a fraction of its population maintained its spiritual allegiance (2 Kings xix. 18). The death of Jeroboam II. was followed by an interregnum of ten years. At the expiry of this period, his son Zechariah assumed the sovereignty, and was slain by Shallum, after the short space of six months (2 Kings xv. 10). In four weeks Shallum was assassinated by Menahem. The assassin, during a disturbed reign of ten years, became tributary to the Assyrian Pul. His successor, Pekahiah, wore the crown but two years, when he was murdered by Pekah. Pekah, after swaying his bloody sceptre for twenty years, met a similar fate in the conspiracy of Hoshea; Hoshea, the last of the usurpers, after another interregnum of eight years, ascended the throne, and his administration of nine years ended in the overthrow of his kingdom and the expatriation of his people. The Lord was very angry with Israel, and removed them out of his sight. So was Israel carried out of their own land to Assyria unto this day' (2 Kings xvii. 18, 23).

The prophecies of Hosea were directed especially against the country whose sin had brought upon it such disasters—prolonged anarchy and final captivity. Israel, or Ephraim, is the people especially addressed. Their homicides and fornications, their perjury and theft, their idolatry and impiety are censured and satirised with a faithful severity. Judah is sometimes, indeed, introduced, warned and admonished. Bishop Horsley (*Works*, iii. 236) reckons it a mistake to suppose 'that Hosea's prophecies are almost wholly directed against the kingdom of Israel.' The bishop describes what he thinks the correct extent of Hosea's commission, but has adduced no proof of his assertion. Any one reading Hosea will at once discover that the oracles having relation to Israel are primary, while the references to Judah are only incidental. In ch. i. 7, Judah is mentioned in contrast with Israel, to whose condition the symbolic name of the prophet's son is specially applicable. In ver. 11 the future union of the two nations is predicted. The long oracle in ch. ii. has no relation to Judah, nor the symbolic representation in ch. iii. Ch. iv. is severe upon

Ephraim, and ends with a very brief exhortation to Judah not to follow his example. In the succeeding chapters allusions to Judah do indeed occasionally occur, when similar sins can be predicated of both branches of the nation. The prophet's mind was intensely interested in the destinies of his own people. The nations around him are unheeded; his prophetic eye beholds the crisis approaching his country, and sees its cantons ravaged, its tribes murdered or enslaved. No wonder that his rebukes were so terrible, his menaces so alarming, that his soul poured forth its strength in an ecstasy of grief and affection. In vitations, replete with tenderness and pathos, are interspersed with his warnings and expostulations. Now we are startled with a vision of the throne, at first shrouded in darkness, and sending forth lightnings, thunders, and voices; but while we gaze, it becomes encircled with a rainbow, which gradually expands till it is lost in that universal brilliancy which itself had originated (ch. xi. and xiv.).

The peculiar mode of instruction which the prophet details in the first and third chapters of his oracles has given rise to many disputed theories. We refer to the command expressed in ch. i. 2—'And the Lord said unto Hosea, Go, take unto thee a wife of whoredoms and children of whoredoms,' &c.; ch. iii. 1, 'Then said the Lord unto me, Go yet, love a woman beloved of her friend, yet an adulteress,' &c. What was the precise nature of the transactions here recorded? Were they real events, the result of divine injunctions literally understood, and as literally fulfilled? or were these intimations to the prophet only intended to be pictorial illustrations of the apostasy and spiritual folly and unfaithfulness of Israel? The former view, viz. that the prophet actually and literally entered into this impure connubial alliance, was advocated in ancient times by Cyril, Theodoret, Basil, and Augustine; and more recently has been maintained by Mercer, Grotius, Houbigant, Manger, Horsley, and Stuck. Fanciful theories are also rife on this subject. Luther supposed the prophet to perform a kind of drama in view of the people, giving his lawful wife and children these mystical appellations. Newcome (*Min. Prophets*) thinks that a wife of fornication means merely an Israelite, a woman of apostate and adulterous Israel. So Jac. Capellus (*In Hoseam; Opera*, p. 683). Hengstenberg supposes the prophet to relate actions which happened, indeed, actually, but not outwardly. Some, with Maimonides (*Moreh Nevochim*, part ii.), imagine it to be a nocturnal vision; while others make it wholly an allegory, as the Chaldee Paraphrast, Jerome, Drusius, Bauer, Rosenmüller, Kuinoel, and Lowth. The view of Hengstenberg, and such as have held his theory (Markii *Diatribæ de uxore fornicationum accipiendæ*, &c. Lugd. Batav. 1696), is not materially different from the last to which we have referred. Both agree in condemning the first opinion, which the fast and forward mind of Horsley so strenuously maintained. Hengstenberg, at great length and with much force, has refuted this strange hypothesis (*Christology*, ii. 11-22). Besides other arguments resting on the impurity and loathsomeness of the supposed nuptial contract, it may be argued against the external reality of the event, that it must have required several years

for its completion, and that the impressiveness of the symbol would therefore be weakened and obliterated. Other prophetic transactions of a similar nature might be referred to. Jerome (*Comment. in loc.*) has referred to Ezek. iv. 4. It is not to be supposed, as has sometimes been argued, that the prophet was commanded to commit fornication. The divine injunction was to marry—'Scortum aliquis ducere potest sine peccato, scortari non item.' Drusius (*Comm. in loc. in Critici Sacri*, tom. v.). Whichever way this question may be solved; whether these occurrences be regarded as a real and external transaction, or as a piece of spiritual scenery, or only, as is most probable (*Witsii Miscell. Sac.* p. 90), an allegorical description, it is agreed on all hands that the actions are typical; that they are, as Jerome calls them, *sacramenta futurorum*.

Expositors are not at all agreed as to the meaning of the phrase 'wife of whoredoms,' אִשֶׁת זְנוּנִים; whether the phrase refers to harlotry before marriage, or unfaithfulness after it. It may afford an easy solution of the difficulty, if we look at the antitype in its history and character. Adultery is the appellation of idolatrous apostasy. The Jewish nation were espoused to God. The contract was formed on Sinai; but the Jewish people had prior to this period gone a-whoring. Josh. xxiv. 2-14, 'Your fathers dwelt on the other side of the flood in old time, and they served other gods.' Comp. Lev. xvii. 7, in which it is implied that idolatrous propensities had also developed themselves during the abode in Egypt: so that אִשֶׁת זְנוּנִים may signify one devoted to lasciviousness prior to her marriage. The marriage must be supposed a real contract, or its significance would be lost. Jer. ii. 2, 'I remember thee, the kindness of thy youth, the love of thine espousals, when thou wentest after me in the wilderness, in a land that was not sown.' יְלֵדֵי זְנוּנִים, *children of whoredoms*, refer most naturally to the two sons and daughter afterwards to be born. They were not the prophet's own, as is intimated in the allegory, and they followed the pernicious example of the mother. Spiritual adultery was the debasing sin of Israel. 'Non dicitur,' observes Manger, 'cognovit uxorem, sed simpliciter concepit et peperit.' The children are not his. It is said, indeed, in verse 3, 'She bare him a son.' The word לוֹ is wanting in some MSS. and in some copies of the Septuagint. If genuine it only shows the effrontery of the adulteress, and the patience of the husband in receiving and educating as his own a spurious brood. The Israelites, who had been taken into covenant, very soon fell from their first love, and were characterized by insatiable spiritual wantonness: yet their Maker, their husband, did not at once divorce them, but exhibited a marvellous long-suffering.

The names of the children being symbolical, the name of the mother has probably a similar signification. נֹמֵר בְּתַדְבָּלִים may have the symbolic sense of 'one thoroughly abandoned to sensual delights': נֹמֵר signifies completion (*Ewald, Gram.* 228); בְּתַדְבָּלִים, 'daughter of grape-cakes,' the dual form being expressive of the mode in which these dainties were baked in double layers. The Greek form, *παλῶθη*,

is apparently a corruption of the Hebrew דְּבַלָה. The names of the children are יְזֵרְעֵל, Jezreel, לֹא רַחֲמָה, Lo-ruhamah, and לֹא עַמִּי, Lo-ammi. The prophet explains the meaning of the appellations. It is generally supposed that the names refer to three successive generations of the Israelitish people. Hengstenberg, on the other hand, argues that 'wife and children both are the people of Israel: the three names must not be considered separately, but taken together.' But as the marriage is first mentioned, and the births of the children are detailed in order, some time elapsing between the events, we rather adhere to the ordinary exposition. Nor is it without reason that the second child is described as a female.

The first child, Jezreel, may refer to the first dynasty of Jeroboam I. and his successors, which was terminated in the blood of Ahab's house which Jehu shed at Jezreel. The name suggests also the cruel and fraudulent possession of the vineyard of Naboth, 'which was in Jezreel,' where, too, the woman Jezebel was slain so ignominiously (1 Kings xvi. 1; 2 Kings ix. 21). But as Jehu and his family had become as corrupt as their predecessors, the scenes of Jezreel were again to be enacted, and Jehu's race must perish. Jezreel, the spot referred to by the prophet, is also, according to Jerome, the place where the Assyrian army routed the Israelites. The name of this child associates the past and future, symbolizes past sins, intermediate punishments, and final overthrow. The name of the second child, Lo-ruhamah, 'not-pitied,' the appellation of a degraded daughter, may refer to the feeble, effeminate period which followed the overthrow of the first dynasty, when Israel became weak and helpless as well as sunk and abandoned. The favour of God was not exhibited to the nation: they were as abject as impious. But the reign of Jeroboam II. was prosperous; new energy was infused into the kingdom; gleams of its former prosperity shone upon it. This revival of strength in that generation may be typified by the birth of a third child, a son, Lo-ammi, 'not-my-people' (2 Kings xiv. 25). Yet prosperity did not bring with it a revival of piety; still, although their vigour was recruited, they were not God's people (*Lectures on the Jewish Antiquities and Scriptures*, by J. G. Palfrey, vol. ii. 422, Boston, N.A., 1841). The space we have already occupied precludes more minute criticism; but the general principles we have indicated may be applied to the second and third chapters.

Recent writers, such as Bertholdt, Eichhorn, De Wette, Stuck, Maurer, and Hitzig, have laboured much, but in vain, to divide the book of Hosea into separate portions, assigning to each the period at which it was written; but from the want of sufficient data the attempt must rest principally on taste and fancy. A sufficient proof of the correctness of this opinion may be found in the contradictory sections and allotments of the various writers who have engaged in the task. Chapters i. ii. and iii. evidently form one division: it is next to impossible to separate and distinguish the other chapters. The form and style are very similar throughout all the second portion.

The peculiarities of Hosea's style have been often remarked. Jerome says of him, 'Com-

maticus est, et quasi per sententias loquens' (*Præf. ad XII. Proph.*). His style, says De Wette, 'is abrupt, unrounded, and ebullient; his rhythm hard, leaping, and violent. The language is peculiar and difficult' (*Einleitung*, § 228). Lowth (*Prælect.* 21) speaks of him as the most difficult and perplexed of the prophets. Bishop Horsley has remarked his peculiar idioms,—his change of person, anomalies of gender and number, and use of the nominative absolute (*Works*, vol. iii.). Eichhorn's description of his style was probably at the same time meant as an imitation of it (*Einleitung*, § 555):—'His discourse is like a garland woven of a multiplicity of flowers: images are woven upon images, comparison wound upon comparison, metaphor strung upon metaphor. He plucks one flower, and throws it down that he may directly break off another. Like a bee he flies from one flower-bed to another, that he may suck his honey from the most varied pieces. It is a natural consequence that his figures sometimes form strings of pearls. Often is he prone to approach to allegory—often he sinks down in obscurity' (comp. ch. v. 9; vi. 3; vii. 8; xiii. 3, 7, 8, 16). Unusual words and forms of connection sometimes occur (*De Wette*, § 228). Of the former, examples are to be found in ch. viii. 13, *הכהבים*; xiii. 5, *תלאובות*; x. 2, *ערף*; xi. 7, *תלוא*; v. 13; x. 6, *מלך ירב*; of the latter, in ch. vii. 16, *לֹא עַל*; ix. 8, *צפה עם*; xiv. 3, *נשלמה פרים שפתינו*. Many examples occur of the *comparatio decurtata*, arising from the peculiar abruptness of the style; and the particles of connection, causal, adversative, transitive, &c. being frequently omitted.

Hosea, as a prophet, is expressly quoted by Matthew (ii. 15). The citation is from the first verse of ch. xi. Hosea vi. 6 is quoted twice by the same evangelist (ix. 13; xii. 7). Quotations from his prophecies are also to be found in Rom. ix. 25, 26. References to them occur in 1 Cor. xv. 55, and in 1 Pet. ii. 10. Messianic references are not clearly and prominently developed (*Gramberg, Religionsid.* ii. 298). This book, however, is not without them; but they lie more in the spirit of its allusions than in the letter. Hosea's Christology appears written not with ink, but with the spirit of the living God, on the fleshy tables of his heart. The future conversion of his people to the Lord their God, and David their king, their glorious privilege in becoming sons of the living God, the faithfulness of the original promise to Abraham, that the number of his spiritual seed should be as the sand of the sea, are among the oracles whose fulfilment will take place only under the new dispensation.

Hengstenberg (vol. ii. 1) gives a long commentary on the introductory chapters. In his *Die authentie des Pentateuches, Ersten Band*, s. 49-82, occur also many important remarks on this book of prophecy, especially proving how much its style and form are based on the language and peculiar idioms of the Pentateuch. The argument is triumphant and conclusive.

Of commentaries on Hosea, distinct from those on the minor prophets generally, may be mentioned Burrough's *Exposition of Hosea*, Lond. 1643; Seb. Schmidt, *Comment. in Hoseam*, Francf. 1687; Ed. Pocock, *Comment. on Hosea*,

Oxf. 1685; Manger, *Commentarius in Hoseam Campis*, 1782; Chr. Fr. Kuinoel, *Hosæ Oracula, Hebr. et Lat. perpetua annotatione illustravit*, Lipsiæ, 1792; J. Jos. Uhlund, *Annotationes in Hoseam*, Tüb. 1785-1797; Horsley, *Hosea, translated from the Hebrew, with Notes, explanatory and critical*, Lond. 1801-4; Stuck, *Hosæas Propheta*, Lipsiæ, 1828; Schröder, *Hosæa, Joel, und Amos, uebersetzt und erläutert*, Leipz. 1829; De Wette, *Ueber die geschichtliche Beziehung der prophetischen Reden des Hoseas, in Theol. Stud. und Crit.* 1831, s. 807; Rückert, *Die Hebräischen Propheten uebersetzt, &c.*, 1831; Hitzig, *Die 12 kleinen Proph. erklärt*, 1838.—

J. E.

HOSEA, son of Elah, and last king of Israel. He conspired against and slew his predecessor Pekah, and seized his dominions. 'He did evil in the sight of the Lord,' but not in the same degree as his predecessors: and this, by the Jewish commentators, is understood to mean that he did not, like former kings of Israel (2 Kings xv. 30), restrain his subjects from going up to Jerusalem to worship. The intelligence that Hosea had entered into a confederacy with So, king of Egypt, with the view of shaking off the Assyrian yoke, caused Shalmaneser, the king of Assyria, to march an army into the land of Israel; and after a three year's siege Samaria was taken and destroyed, and the ten tribes were sent into the countries beyond the Euphrates, B.C. 720 (2 Kings xv. 30; xvii. 1-6; xviii. 9-12). The chronology of this reign is much perplexed [see CHRONOLOGY, ISRAEL].

HOSPITALITY. The practice of receiving strangers into one's house and giving them suitable entertainment, may be traced back to the early origin of human society. It is not, however, confined to any age or to any country, but has been observed in all parts of the globe wherever circumstances have been such as to render it desirable—thus affording one among many instances of the readiness with which human nature, in its moral as well as in its physical properties, adapts itself to every varying condition. Hospitality is therefore not a peculiarly Oriental virtue. It was practised, as it still is, among the least cultivated nations (Diod. Sic. v. 28, 34; Cæs. Bell. Gall. vi. 23; Tac. Germ. 21). It was not less observed, in the early periods of their history, among the Greeks and Romans. With the Greeks, hospitality (*ξενία*) was under the immediate protection of religion. Jupiter bore a name (*ξένιος*) signifying that its rights were under his guardianship. In the *Odyssey* (vi. 206) we are told expressly that all guests and poor people are special objects of care to the gods. There were both in Greece and Italy two kinds of hospitality, the one private, the other public. The first existed between individuals, the second was cultivated by one state towards another. Hence arose a new kind of social relation: between those who had exercised and partaken of the rites of hospitality an intimate friendship ensued,—a species of freemasonry, which was called into play wherever the individuals might afterwards chance to meet, and the right, duties, and advantages of which passed from father to son, and were deservedly held in the highest estimation.

But though not peculiarly Oriental, hospitality has nowhere been more early or more fully prac-

tised than in the East. It is still honourably observed among the Arabs, especially at the present day. An Arab, on arriving at a village, dismounts at the house of some one who is known to him, saying to the master, 'I am your guest.' On this the host receives the traveller, and performs his duties, that is, he sets before his guest his supper, consisting of bread, milk, and borgul, and, if he is rich and generous, he also takes the necessary care of his horse or beast of burden. Should the traveller be unacquainted with any person, he alights at any house, as it may happen, fastens his horse to the same, and proceeds to smoke his pipe until the master bids him welcome, and offers him his evening meal. In the morning the traveller pursues his journey, making no other return than 'God be with you' (good bye) (Niebuhr, *Reis.* ii. 431, 462; D'Arvieux, iii. 152; Burekhardt, i. 69; Rosenmüller, *Morgenl.* vi. 82, 257). The early existence and long continuance of this amiable practice in Oriental countries, are owing to the fact of their presenting that condition of things which necessitates and calls forth hospitality. When population is thinly scattered over a great extent of country, and travelling is comparatively infrequent, inns or places of public accommodation are not found: yet the traveller needs shelter, perhaps succour and support. Pity prompts the dweller in a house or tent to open his door to the tired wayfarer, the rather because its master has had, and is likely again to have, need of similar kindness. The duty has its immediate pleasures and advantages; for the traveller comes full of news—false, true, wonderful; and it is by no means onerous, since visits from wayfarers are not very frequent, nor are the needful hospitalities costly. In later periods, when population had greatly increased, the establishment of inns (caravanserais) diminished, but did by no means abolish the practice (Joseph, *Antiq.* v. 1. 2; Luke x. 34).

Accordingly we find hospitality practised and held in the highest estimation at the earliest periods in which the Bible speaks of human society (Gen. xviii. 3; xix. 2; xxiv. 25; Exod. ii. 20; Judg. xix. 16). Express provision for its exercise is made in the Mosaic law (Lev. xix. 33; Deut. xiv. 29). In the New Testament also its observance is enjoined, though in the period to which its books refer the nature and extent of hospitality would be changed with the change that society had undergone (1 Pet. iv. 9; 1 Tim. iii. 2; Tit. i. 8; 1 Tim. v. 10; Rom. xii. 13; Heb. xiii. 2). The reason assigned in this last passage, 'for thereby some have entertained angels unawares,' is not without a parallel in classical literature; for the religious feeling which in Greece was connected with the exercise of hospitality, was strengthened by the belief that the traveller might be some god in disguise (Hom. *Odyss.* xvii. 484). The disposition which generally prevailed in favour of the practice was enhanced by the fear lest those who neglected its rites should, after the example of impious men, be subjected by the divine wrath to frightful punishments (Ælian, *Anim.* xi. 19). Even the Jews, in 'the latter days,' laid very great stress on the obligation; the rewards of Paradise, their doctors declared, were his who spontaneously exercised hospitality (Schöttgen, *Hor. Heb.* i. 220; Kypke, *Observ. Sacr.* i. 129).

The guest, whoever he might be, was on his

appearing invited into the house or tent (Gen. xix. 2; Exod. ii. 20; Judg. xiii. 15; xix. 21). Courtesy dictated that no improper questions should be put to him, and some days elapsed before the name of the stranger was asked, or what object he had in view in his journey (Gen. xxiv. 33; *Odyss.* i. 123; iii. 69; *Iliad.* vi. 175; ix. 222; Dio. Sic. v. 28). As soon as he arrived he was furnished with water to wash his feet (Gen. xviii. 4; xix. 2; 1 Tim. v. 10; *Odyss.* iv. 49; xvii. 88; vi. 215); received a supply of needful food for himself and beast (Gen. xviii. 5; xix. 3; xxiv. 25; Exod. ii. 20; Judg. xix. 20; *Odyss.* iii. 464); and enjoyed courtesy and protection from his host (Gen. xix. 5; Josh. ii. 2; Judg. xix. 23). The case of Sisera, decoyed and slain by Jael (Judg. iv. 18, sq.), was a gross infraction of the rights and duties of hospitality. On his departure the traveller was not allowed to go alone or empty-handed (Judg. xix. 5; Waginseil, *ad Sot.* pp. 1020, 1030; Zorn, *ad Hecat.* Abder. 22; *Iliad.* vi. 217). As the free practice of hospitality was held right and honourable, so the neglect of it was considered discreditably (Job xxxi. 32; *Odyss.* xiv. 56); and any interference with the comfort and protection which the host afforded, was treated as a wicked outrage (Gen. xix. 4, sq.). Though the practice of hospitality was general, and its rites rarely violated, yet national or local enmities did not fail sometimes to interfere; and accordingly travellers avoided those places in which they had reason to expect an unfriendly reception. So in Judg. xix. 12, the 'certain Levite' spoken of said, 'We will not turn aside hither into the city of a stranger, that is not of the children of Israel.' The quarrel which arose between the Jews and Samaritans after the Babylonish captivity destroyed the relations of hospitality between them. Regarding each other as heretics, they sacrificed every better feeling. It was only in the greatest extremity that the Jews would partake of Samaritan food (Lightfoot, p. 993), and they were accustomed, in consequence of their religious and political hatred, to avoid passing through Samaria in journeying from one extremity of the land to the other. The animosity of the Samaritans towards the Jews appears to have been somewhat less bitter; but they showed an adverse feeling towards those persons who, in going up to the annual feast at Jerusalem, had to pass through their country (Luke ix. 53). At the great national festivals hospitality was liberally practised so long as the state retained its identity. On these festive occasions no inhabitant of Jerusalem considered his house his own; every home swarmed with strangers; yet this unbounded hospitality could not find accommodation in the houses for all who stood in need of it, and a large proportion of visitors had to be content with such shelter as tents could afford (Helen, *Pilgrim.* i. 228, sq. On the general subject, see Unger, *de ξενοδοκία ejusque ritu antiquo*; Stuck, *Antiq. Conviv.* i. 27; De Wette, *Lehrb. der Archäologie*; and Scholz, *Handb. der Bibl. Archäologie*.—J. R. B.

HOURS. The ancient Hebrews, like the Greeks (Homer, *Il.* xxi. 3), were unacquainted with any other means of distinguishing the times of day than the natural divisions of morning, mid-day or noon, twilight, and night (Gen. xv. 12; xviii. 1; xix. 1, 15, 23). The earliest

mention of hours occurs in Daniel (iii. 15; iv. 19; v. 5); and even in the Septuagint *ῥα* invariably signifies a season of the year, as in Homer and Hesiod. As the Chaldeans claimed the honour of inventing this system of notation (Herod. ii. 119.), it is most probable that it was during their residence in Babylon that the Jews became familiar with their artificial distribution of the day. At all events no trace of it occurs before the captivity of that people; while, subsequently to their return to their own land, we find the practice adopted, and, in the time of Christ, universally established, of dividing the day and night respectively into twelve equal portions (Matt. xx. 3-5; John xi. 9; Acts v. 7; xix. 34). The Jewish horology, however, in common with that of other Eastern nations, had this inherent defect, that the hours, though always equal to one another, were unequal in regard to the seasons, and that as their day was reckoned from sunrise to sunset, and not from the fixed period of noon, as with us, the twelve hours into which it was divided varied, of course, in duration according to the fluctuations of summer and winter. The mid-day, which with us is the twelfth hour, the Jews counted their sixth, while their twelfth hour did not arrive till sunset. At the equinoxes, their hours were exactly of the same length with ours, and the time from which they began to reckon their day at those seasons corresponded precisely with our six o'clock A.M.; their first hour being our seven o'clock, their third (Acts ii. 15), our nine, their ninth (Acts iii. 1), our three o'clock P.M., and their eleventh (Matt. xx. 6), our five. This equality, however, in the duration of their hours, as well as in their correspondence to ours, was disturbed as the season approached towards the summer or winter solstice. In midsummer, when sunrise in Judæa takes place at five o'clock A.M., and sunset at seven P.M., the Jewish hours were a little longer than ours; and the only one of their hours which answered exactly to ours was the sixth, or twelve o'clock, while in all the rest there was a considerable difference. Their third hour was shortly before our nine, and their ninth a little after our three. In like manner, in winter, when the sun rises at seven and sets at five, the Jewish hour was proportionally shorter than ours, their third hour not occurring till a little after our nine, and their ninth a little before our three. Hence it is evident that in order to determine exactly the duration of Daniel's silence, for instance ('he was astonished one hour,' Dan. iv. 19), or the exact time when the darkness at Christ's crucifixion ended, it is necessary to ascertain the particular seasons when these incidents occurred.

In ancient times the only way of reckoning the progress of the day was by the length of the shadow—a mode of reckoning which was both contingent on the sunshine, and served only for the guidance of individuals. By what means the Jews calculated the length of their hours—whether by dialling, by the clepsydra or water-clock, or by some horological contrivance, like what was used anciently in Persia (Joseph. *Antiq.* xi. 6), and by the Romans (Martial, viii. *Epiq.* 67; Juv. *Sat.* x. 215), and which is still used in India (*Asiat. Resear.* v. 88), a servant notifying the intervals, it is now impossible to discover. The Chaldee word *שעה* (Dan. iv. 16), which signifies *announcer*, seems to countenance the latter (as it

seems to refer to the mode employed by the Persians, Romans, and Indians) supposition.

Besides these smaller hours, there was another division of the day into larger hours, with reference to the stated periods of prayer, viz. the third, sixth, and ninth hours of the day (Ps. xlv. 17; Joseph. *Antiq.* iv. 4. 3).

The night was divided into twelve equal portions or hours, in precisely the same manner as the day. The most ancient division, however, was into three watches (*Antiq.* lxiii. 6; xc. 4); the first, or beginning of the watches, as it is called (Lament. ii. 19); the middle-watch (Judg. vii. 19); and the morning-watch (Exod. xiv. 24). When Judæa became a province of Rome, the Roman distribution of the night into four watches was introduced [see *COCK-CROWING* and *DAY*]; to which division frequent allusions occur in the New Testament (Luke xii. 38; Matt. xiv. 25; xiii. 35), as well as to that of hours (Matt. xxv. 13; xxvi. 40; Mark xiv. 37; Luke xvii. 59; Acts xxiii. 23; Rev. iii. 3).

It remains only to notice that the word *hour* is sometimes used in Scripture to denote some determinate season, as 'mine *hour* is not yet come,' 'this is your *hour*, and the power of darkness,' 'the *hour* is coming,' &c.—R. J.

HOUSE. Houses are often mentioned in Scripture, several important passages of which cannot be well understood without a clearer notion of the houses in which the Hebrews dwelt, than can be realized by such comparisons as we naturally make with those in which we ourselves live. But things so different afford no grounds for instructive comparison. We must therefore bring together such facts as can be collected from the Scripture and from ancient writers, with such details from modern travellers and our own observations, as may tend to illustrate these statements; for there is every reason to conclude that little substantial difference exists between the ancient houses and those which are at this day found in south-western Asia.

The agricultural and pastoral forms of life are described in Scripture as of equally ancient origin. Cain was a husbandman, and Abel a keeper of sheep. The former is a settled, the latter an unsettled mode of life. Hence we find that Cain, when the murder of his brother constrained him to wander abroad, built a town in the land where he settled. At the same time, doubtless, those who followed the same mode of life as Abel, dwelt in tents, capable of being taken from one place to another, when the want of fresh pastures constrained those removals which are so frequent among people of pastoral habits. We are not required to suppose that Cain's town was more than a collection of huts.

Our information respecting the abodes of men in the ages before the Deluge is, however, too scanty to afford much ground for notice. The enterprise at Babel, to say nothing of Egypt, shows that the constructive arts had made considerable progress during that obscure but interesting period; for we are bound in reason to conclude that the arts possessed by man in the ages immediately following the Deluge, existed before that great catastrophe [ANTE-DILUVIANS].

We may, however, leave this early period, and proceed at once to the later times in which the Hebrews flourished.

The observations offered under ARCHITECTURE will preclude the expectation of finding among this Eastern people that accomplished style of building which Vitruvius requires, or that refined taste by which the Greeks and Romans excited the admiration of foreign nations. The reason of this is plain. Their ancestors had roved through the country as nomade shepherds, dwelling in tents; and if ever they built huts they were of so light a fabric as easily to be taken down when a change of station became necessary. In this mode of life solidity in the structure of any dwelling was by no means required; much less were regular arrangement and the other requisites of a well-ordered dwelling matters of consideration. Under such circumstances as these, no improvement in the habitation takes place. The tents in which the Arabs now dwell are in all probability the same as those in which the Hebrew patriarchs spent their lives. It is not likely that what the Hebrews observed in Egypt, during their long sojourn in that country, had in *this respect* any direct influence upon their own subsequent practice in Palestine. The reasons for this have been given under ARCHITECTURE.



346.

Nevertheless, the information which may be derived from the figures of houses and parts of houses in the Egyptian tombs, is not to be overlooked or slighted. We have in them the *only* representations of ancient houses in that part of the world which now exist: and however different may have been the *state* architecture of Egypt and Palestine, we have every reason to conclude that there was considerable resemblance in the private dwellings of these neighbouring countries. Such a resemblance now exists, and the causes which produce it equally existed in ancient times: and, which is more to the purpose, the representations to which we refer have almost the same amount of agreement and of difference with the present houses of Syria as with those of modern Egypt. On these and other grounds we shall not decline to avail ourselves of this interesting source of illustration; but before turning to its details, we shall give a general statement, which may render them more intelligible.

On entering Palestine, the Israelites occupied the dwellings of the dispossessed inhabitants; and for a long time no new buildings would be needed. The generation which began to build new houses must have been born and bred in the country, and would naturally erect buildings like those which already existed in the land. Their mode of building was therefore that of the Canaanites whom they had dispossessed. Of *their* style of building we are not required to form any exalted notions. In all the history of the conquest of the country by the Israelites, there is no account of any large

or conspicuous building being taken or destroyed by them. It would seem also as if there had been no temples; for we read not that any were destroyed by the conquerors; and the command that the monuments of idolatry should be overthrown, specifies only altars, groves, and high places—which seems to lead to the same conclusion; since, if there had been temples existing in the land of Canaan, they would doubtless have been included. It is also manifest from the history that the towns which the Hebrews found in Palestine were mostly small, and that the largest were distinguished rather by their number than by the size or magnificence of their buildings.

It is impossible to say to what extent Solomon's improvements in state architecture operated to the advancement of domestic architecture. He built different palaces, and it is reasonable to conclude that his nobles and great officers followed more or less the models which these palaces presented. In the East, however, the domestic architecture of the bulk of the people is little affected by the improvements in state buildings. Men go on building from age to age as their forefathers built; and in all probability the houses which we now see in Palestine are such as those in which the Jews, and the Canaanites before them, dwelt—the mosques, the Christian churches, and the monasteries being the only new features in the scene.

There is no reason to suppose that many houses in Palestine were constructed with wood. A great part of that country was always very poor in timber, and the middle part of it had scarcely any wood at all. But of stone there was no want; and it was consequently much used in the building of houses. The law of Moses respecting leprosy in houses (Lev. xiv. 33-40) seems to prove this, as the characteristics there enumerated could only occur in the case of stone walls. Still, when the Hebrews intended to build a house in the most splendid style and in accordance with the taste of the age, as much wood as possible was used. Having premised this, the principal building materials mentioned in Scripture may be enumerated with reference to their place in the three kingdoms of nature.

1. VEGETABLE SUBSTANCES :—

1. *Shittim*, or the timber of the acacia tree, which grows abundantly in the valleys of Arabia Petraea, and was therefore employed in the construction of the tabernacle. Not being, however, a tree of Palestine, the wood was not subsequently used in building.

2. *Shakemim*; that is, the wood of the sycamore fig-tree, mentioned in Isa. ix. 10, as a building timber in more common use than cedar, or perhaps than any other wood known in Palestine.

3. *Eres*, or cedar. As this was a wood imported from Lebanon, it would only be used in the higher class of buildings. For its quality as a building timber, and respecting the question of its being really what we call the cedar, see *ERES*.

4. *Algum-wood*, which, being imported from the Eastern seas, must have been valued at a high price. It was used by Solomon for pillars for his own palace, and for the temple (1 Kings x. 11, 12).

5. *Berosh*, or cypress-wood. Boards of this were used for the floor of the Temple, which may suggest the use to which it was ordinarily applied (1 Kings vi. 15; 2 Chron. iii. 5).

Particular accounts of all these woods, and of the trees which afforded them, may be seen under the respective words.

II. MINERAL SUBSTANCES:—

1. *Marble*. We find the court of the king of Persia's palace covered with marble of various colours (Esth. i. 6). David is recorded to have possessed abundance of marble (1 Chron. xxx. [xxix.] 2; comp. Cant. v. 13), and it was used by Solomon for his palace, as well as for the Temple.

2. *Porphyry and Granite* are supposed to be 'the glistening stones, and stones of divers colours' named in 1 Chron. xxix. 2. If so, the mountains of Arabia Petraea furnished the nearest source of supply, as these stones do not exist in Palestine or Lebanon.

3. *Bricks*. Bricks hardened by fire were employed in the construction of the tower of Babel (Gen. xi. 3), and the hard bondage of the Israelites in Egypt consisted in the manufacture of sun-dried bricks (Exod. v. 7, 10-13). This important building-material has been noticed under another head [BRICKS]; and it only remains to remark that no subsequent notice of bricks as being used by the Hebrews occurs after they had entered Palestine. Yet, judging from existing analogies, it is more than probable that bricks were to a considerable extent employed in their buildings. From the expense and labour of quarrying and conveying stone, bricks are often extensively used in Eastern countries even where stone is abundant; and it is not unusual to see the foundations and lower parts of the house of stone, while the superstructure is of brick.

3. *Chalk and Gypsum*, which the Hebrews appear to have comprehended under the general name of *ἄψιδ*. That the Hebrews were acquainted with these materials appears from Deut. xxvii. 2; and from Dan. v. 5; Acts xxiii. 3, it further appears that walls were covered with them. A highly instructive and curious account of the plasters used in the East may be seen in tome iv. of Laugle's edition of Chardin's *Voyages*.

4. *Mortar*, a cement made of lime, ashes, and chopped straw, or of gypsum and chopped straw. This is probably meant in Jer. xliii. 9; Ezek. xliii. 10, 11, 20.

5. *Asphaltum, or Bitumen*, which is mentioned as being used for a cement by the builders of Babel. This must have been in the want of lime-mortar, the country being a stoneless plain. But the Israelites, who had no lack of the usual cements, did not employ asphaltum [BITUMEN].

6. The metals also must be, to a certain extent, regarded as building materials: lead, iron, and copper are mentioned; and even silver and gold were used in combination with wood, for various kinds of solid, plated, and inlaid work (Exod. xxxvi. 34, 38).

III. ANIMAL SUBSTANCES:—

Such substances can be but in a small degree applicable to building. *Ivory* houses are mentioned in 1 Kings xxii. 39; Amos iii. 14; most likely from certain parts of the wood-work, probably about the doors and windows, being inlaid with this valuable substance. Solomon obtained ivory in great quantities from Tyre (1 Kings x. 22; 2 Chron. ix. 21). [IVORY.]

In describing the houses of ancient Palestine, there is no way of arriving at distinct notions but

by taking the texts of Scripture and illustrating them by the existing houses of those parts of Western Asia which have been the least exposed to the changes of time, and in which the manners of ancient days have been the best preserved. Writers on the subject have seen this, and have brought together the descriptions of travellers bearing on the subject; but these descriptions have generally been applied with very little judgment, from the want of that distinct knowledge of the matter which only actual observation can give. Travellers have seldom been students of Scripture, and students of Scripture have seldom been travellers. The present writer, having resided for a considerable time in Turkish Arabia, where the type of Scriptural usages has been better preserved than in Egypt, or even in Palestine itself, is enabled to speak on this matter with somewhat more precision. Of four houses in which he there resided, two were first-rate, and two were second-rate. One of the latter has always seemed to him to suggest a more satisfactory idea of a Scriptural house than any of the others, or than any that he ever saw in other Eastern countries. That one has therefore formed the basis of all his ideas on this subject; and where it seemed to fail, the others have usually supplied the illustration he required. This course he has found so beneficial, that he will endeavour to impart a clear view of the subject to the reader by giving a general notion of the house referred to, explaining any points in which the others differed from it, and producing the passages of Scripture which seem to be illustrated in the process.

We may premise that the houses present little more than a dead wall to the street. The privacy of Oriental domestic habits would render our plan of throwing the front of the houses towards the street most repulsive. On coming to a house, one finds a lofty wall, which would be blank but for the low door of entrance [GATE]; over which is

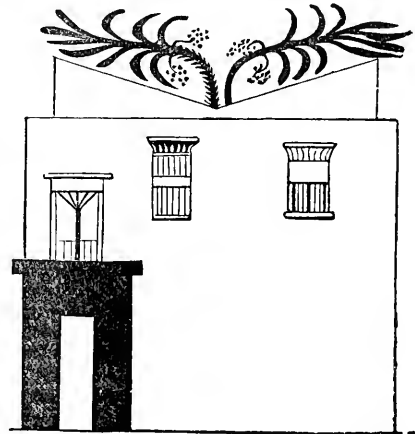

347.

usually the kiosk, or latticed window (sometimes projecting like the huge bay windows of Elizabethan houses), or screened balcony of the 'summer parlour.' Besides this, there may be a small latticed window or two high up the wall, giving

light and air to upper chambers. This seems, from the annexed engraving (No. 347), to have been the character of the fronts of ancient Egyptian houses.

The buildings which form the house front towards an inner square or court. Small houses have one of these courts, but superior houses have two, and first-rate houses three, communicating with each other; for the Orientals dislike ascending stairs or steps, and prefer to gain room rather by the extent than height of their habitations. It is only when the building-ground is confined by nature or by fortifications, that they build high houses. None of our four houses had more than one story; but, from the loftiness of the rooms, they were as high as houses of three stories among ourselves. If there are three or more courts, all except the outer one are much alike in size and appearance; but the outer one, being devoted to the more public life of the occupant, and to his intercourse with society, is materially different from all the others. If there are more than two, the second is devoted chiefly to the use of the master, who is there attended only by his eunuchs, children, and females, and sees only such persons as he calls from the third or interior court in which they reside. In the history of Esther, she incurs danger by going from her interior court to that of the king, to invite him to visit her part of the palace; but she would not on any account have gone to the outermost court, in which the king held his public audiences. When there are only two courts, the innermost is the barem, in which the women and children live, and which is the true domicile of the master, to which he withdraws when the claims of business, of society, and of friends have been satisfied, and where no man but himself ever enters, or could be induced to enter, even by strong persuasions.

Entering at the street-door, a passage, usually sloping downward, conducts to the outer court; the opening from the passage to this is not opposite the gate of entrance, but by a side turn, to preclude any view from the street into the court when the gate is opened. On entering the outer court through this passage, we find opposite to us the public room, in which the master receives and gives audience to his friends and clients. This is entirely open in front, and, being richly fitted up, has a splendid appearance when the first view of it is obtained. A refreshing coolness is sometimes given to this apartment by a fountain throwing up a jet of water in front of it. Some idea of the apartment may be formed from the annexed cut (No. 348). This is the 'guest-chamber' of Luke xxii. 11. A large portion of the other side of the court is occupied with a frontage of lattice-work filled with coloured glass, belonging to a room as large as the guest-chamber, and which in winter is used for the same purpose, or serves as the apartment of any visitor of distinction, who cannot of course be admitted into the interior parts of the house. The other apartments in this outer court are comparatively small, and are used for the accommodation of visitors, retainers, and servants. These various apartments are usually upon what we should call the first floor, or at least upon an elevated terrace. The ground floor is in that case occupied by various store-rooms and servants' offices. In all

cases the upper floor, containing the principal rooms, is fronted by a gallery or terrace, protected from the sun by a sort of penthouse roof supported by pillars of wood.

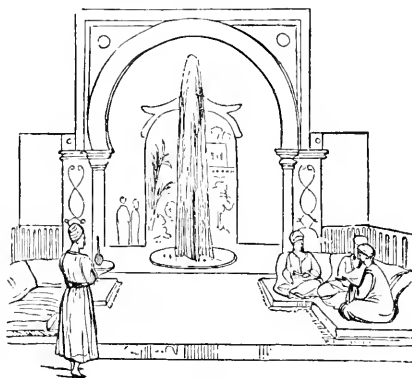

348.

In houses having but one court, the reception-room is on the ground floor, and the domestic establishment in the upper part of the house. This arrangement is shown in the annexed engraving (No. 349), which is also interesting from its showing the use of the 'pillars' so often men-

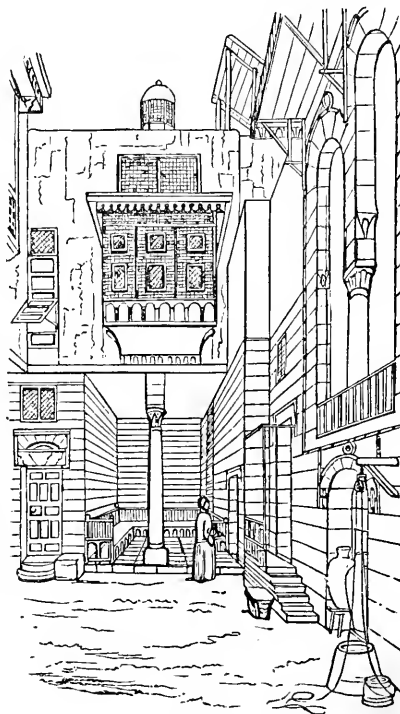

349.

tioned in Scripture, particularly 'the pillars on which the house stood, and by which it was borne

up' (Judg. xvi. 29). Some other of the cuts which we introduce will exhibit pillars of similar importance to the support of the house.

The kiosk, which has been mentioned above as fronting the street, over the gateway, is connected with one of the larger rooms already described, or forms a separate apartment, which is the summer parlour of Scripture. Here, in the heat of the afternoon, the master lounges or dozes listlessly, refreshed by the air which circulates between the openings of the lattice-work; and here he can, if he pleases, notice unobserved what passes in the street. In this we are to seek the summer parlour in which Ehud smote the king of Moab (Judg. iii. 20), and the 'chamber on the wall,' which the Shunamite prepared for the prophet (2 Kings iv. 10). The projecting construction over the reception chamber in No. 349 is, like the kiosk, towards the street of a summer parlour; but there it belongs to the women's apartments, and looks into the court, and not the street.

It is now time to proceed to the inner court, which we enter by a passage and door similar to those by which we entered from the street. This passage and door are usually at one of the innermost corners of the outer court. Here a much more extended prospect opens to us, the inner court being generally much larger than the former. The annexed cut (No. 350) will convey some notion of it; but being a Persian house, it somewhat differs from that which we have more particularly in view. It is lower, the principal apartments standing upon a terrace or bank of earth, and not upon a basement story of offices; and it also wants the veranda or covered gallery in front, which we find in Syro-Arabian houses. The court is for the most part paved, excepting a portion in the middle, which is planted with trees (usually two) and shrubs, with a basin of water in the midst. In our Arabian house the two trees were palm-trees, in which a number of wild doves built their nests. In the second cut (No. 347), showing an ancient Egyptian house, we see the same arrangement: two palm-trees growing in the court extend their tops above, and, as it were, out of the house—a curious effect frequently no-

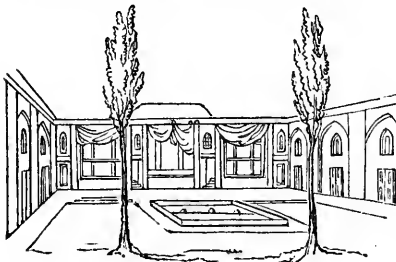

350.

ticed in the towns of South-western Asia. That the Jews had the like arrangement of trees in the courts of their houses, and that the birds nested in them, appears from Psa. lxxxiv. 2, 3. They had also the basin of water in the inner court, or haram; and among them it was used for bathing, as is shown by David's discovering Bathsheba bathing as he walked on the roof of his palace. This use of the reservoir has now been superseded

by the establishment of public warm baths in every town, and in private mansions. Cold bathing has all but ceased in Western Asia.

The arrangement of the inner court is very similar to that of the outer; but the whole is more open and airy. The buildings usually

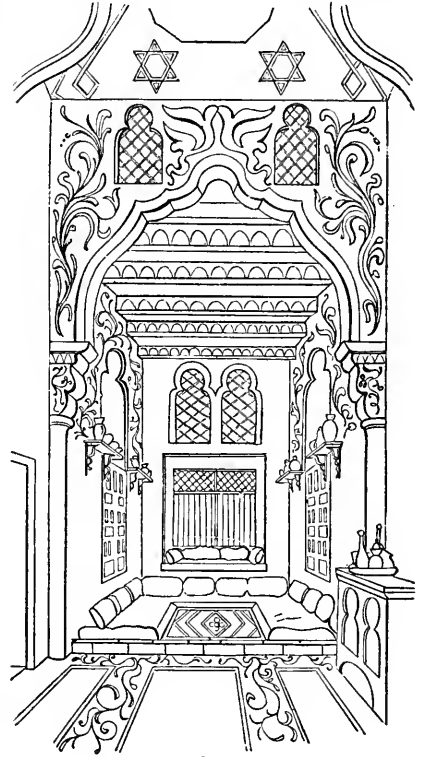

351.

occupy two sides of the square, of which the one opposite the entrance contains the principal apartments. They are upon what we should call the first floor, and open into a wide gallery or veranda, which in good houses is nine or ten feet deep, and covered by a wooden penthouse supported by a row of wooden columns. This terrace, or gallery, is furnished with a strong wooden balustrade, and is usually paved with squared stones, or else floored with boards. In the centre of the principal front is the usual open drawing-room, on which the best art of the Eastern decorator is expended (No. 351). Much of one of the sides of the court front is usually occupied by the large sitting-room, with the latticed front covered with coloured glass, similar to that in the outer court. The other rooms, of smaller size, are the more private apartments of the mansion. The interior of one of these is shown in the annexed cut (No. 352). There are usually no doors to the sitting or drawing-rooms of Eastern houses: they are closed by curtains, at least in summer, the opening and shutting of doors being odious to most Orientals. The same seems to have been the case among the Hebrews, as far as we may judge from the curtains which served instead of doors to the

tabernacle, and which separated the inner and outer chambers of the temple. The curtained entrances to our Westminster courts of law supply a familiar example of the same practice.



352.

Some ideas respecting the arrangements and architecture of the interior parts of the dwelling may be formed from the annexed cut (No. 353), although the house in this case, being modern Egyptian, differs in some points of arrangement from those on which our description is chiefly based.

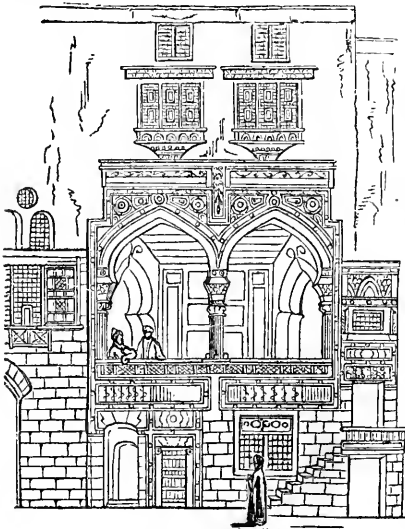

353.

These observations apply to the principal story. The basement is occupied by various offices, stores of corn and fuel, places for the water-jars

to stand in, places for grinding corn, baths, kitchens, &c. The kitchens are always in this inner court, as the cooking is performed by women, and the ladies of the family superintend or actually assist in the process. The kitchen, open in front, is on the same side as the entrance from the outer court; and the top of it forms a terrace, which affords a communication between the first floor of both courts by a private door, seldom used but by the master of the house and attendant eunuchs.

The kitchen, of which the annexed cut (No. 354) is the only existing representation, is surrounded by a brick terrace, on the top of which are the fireplaces formed in compartments, and separated by little walls of fire-brick or tile. In these different compartments the various dishes of an Eastern feast may be at once prepared at charcoal fires. This place being wholly open in front, the half-tame doves, which have their nests in the trees of the court, often visit it, in the absence of the servants, in search of crumbs, &c. As they sometimes blacken themselves, this perhaps explains the obscure passage in Ps. lxxviii. 13, 'Though ye have lien among the pots, ye shall be as the wings of a dove covered with silver,' &c. In Turkish Arabia most of the houses have underground cellars or vaults, to which the inhabitants retreat during the mid-day heat of summer, and there enjoy a refreshing coolness. We do not discover any notice of this usage in Scripture. But at Acre the substructions of very ancient houses were some years ago discovered, having such cellars, which were very probably subservient to this use. In the rest of the year these cellars, or *serdaubs*, as they are called, are abandoned to the bats, which swarm in them in scarcely credible numbers (Isa. ii. 20).

From the court a flight of stone steps, usually at the corner, conducts to the gallery, from which a plainer stair leads to the house-top. If the house be large, there are two or three sets of steps to the different sides of the quadrangle, but seldom more than one flight from the terrace to the house-top of any one court. There is, however, a separate stair from the outer court to the roof, and it is usually near the entrance. This will bring to mind the case of the paralytic, whose friends, finding they could not get access to Jesus through the people who crowded the court of the house in which he was preaching, took him up to the roof, and let him down in his bed through the tiling, to the place where Jesus stood (Luke v. 17-26). If the house in which our Lord then was had more than one court, he and the auditors were certainly in the outer one; and it is reasonable to conclude that he stood in the veranda addressing the crowd below. The men bearing the paralytic therefore, perhaps went up the steps near the door; and finding they could not even then get near the person of Jesus, the gallery being also crowded, continued their course to the roof of the house, and removing the boards over the covering of the gallery, at the place where Jesus stood, lowered the sick man to his feet. But if they could not get access to the steps near the door, as is likely, from the door being much crowded, their alternative was to take him to the roof of the next house, and there hoist him over the parapet to the roof of the house which they desired to enter.

The roof of the house is, of course, flat. It is

formed by layers of branches, twigs, matting, and earth, laid over the rafters and trodden down;

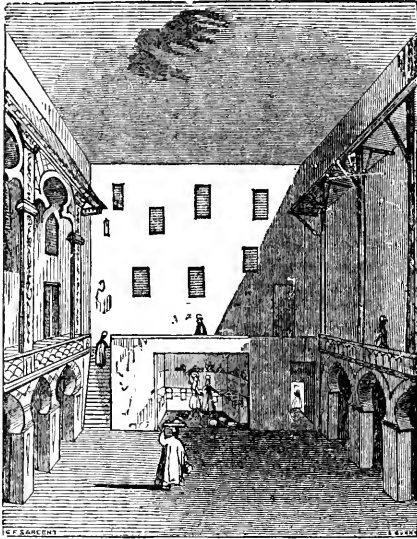

354.

after which it is covered with a compost which acquires considerable hardness when dry. Such roofs would not, however, endure the heavy and continuous rains of our climate; and in those parts of Asia where the climate is more than usually moist, a stone roller is usually kept on every roof, and after a shower a great part of the population is engaged in drawing these rollers over the roofs. It is now very common, in countries where timber is scarce, to have domed roofs; but in that case, the flat roof, which is indispensable to Eastern habits, is obtained by filling up the hollow intervals between the several domes, so as to form a flat surface at the top. These flat roofs are often alluded to in Scripture; and the allusions show that they were made to serve the same uses as at present. In fine weather the inhabitants resorted much to them to breathe the fresh air, to enjoy a fine prospect, or to witness any event that occurred in the neighbourhood (2 Sam. xi. 2; Isa. xxii. 1; Matt. xxiv. 17; Mark xiii. 15). The dryness of the summer atmosphere enabled them, without injury to health, to enjoy the bracing coolness of the night-air by sleeping on the house-tops; and in order to have the benefit of the air and prospect in the daytime, without inconvenience from the sun, sheds, booths, and tents, were sometimes erected on the house-tops (2 Sam. xvi. 22).

The roofs of the houses are well protected by walls and parapets. Towards the street and neighbouring houses is a high wall, and towards the interior court-yard usually a parapet or wooden rail. ' Battlements ' of this kind, for the prevention of accidents, are strictly enjoined in the Law (Deut. xxii. 8); and the form of the battlements of the Egyptian houses, as shown in the annexed engravings, suggest some interesting analogies, when we consider how recently the Israelites had quitted Egypt when that law was

delivered. These cuts, with the one before given (No. 347), are highly interesting, not only with reference to this particular point, but as elevations of different styles of houses, existing in a neighbouring country in the early ages of the Hebrew history. One of them (Nos. 355, 356) exhibits different forms of a peculiarity which we have not observed in any modern example. The top of the house is covered with a roof or awning, supported by columns, whereby the sun was excluded, and a refreshing stream of air passed through. Other Egyptian houses had merely a parapet wall, sometimes surmounted with a row of battlements, as in the cut here given (No. 357).

Of the inferior kinds of Oriental dwellings, such as are met with in villages and very small towns, the subjoined is not an unfavourable specimen. In these there is no central court, but there is generally a yard attached, either on one side or at the rear. The shaded platform in front is such as is usually seen attached to coffee-houses, which is, in fact, the character of the house represented in No. 357. Here the customers sit and smoke their pipes, and sip their coffee. The village cabins and abodes of the peasantry are, of course, of a still inferior description; and, being the abodes of people who live much in the open air, will not bear comparison with the houses of the same class in Northern Europe, where the cottage is the *home* of the owner.

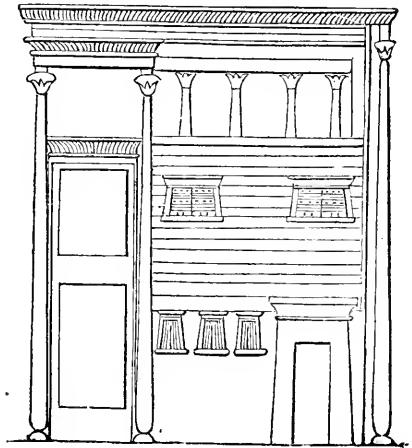

355.

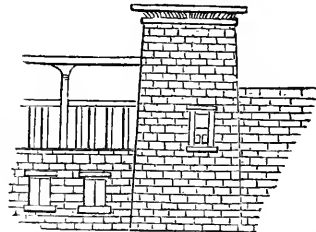

356.

No ancient houses had chimneys. The word so translated in Hos. xiii. 3, means a hole through which the smoke escaped; and this existed only

in the lower class of dwellings, where raw wood was employed for fuel or cooking, and where there was an opening immediately over the hearth to let out the smoke. In the better sort of houses the rooms were warmed in winter by charcoal in braziers, as is still the practice (Jer. xxxvi. 22; Mark xiv. 54; John xviii. 18).

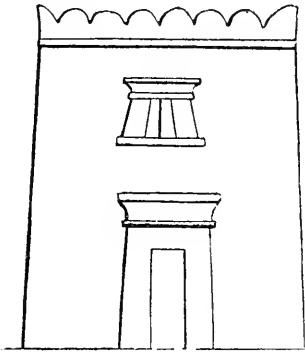

357.

The windows had no glass. They were only latticed, and thus gave free passage to the air and admitted light, while birds and bats were excluded. In winter the cold air was kept out by veils over the windows (see cut 352), or by shutters with holes in them sufficient to admit light (1 Kings vii. 17; Cant. ii. 9).

In the East, where the climate allows the people to spend so much of their time out of doors, the articles of furniture and the domestic utensils

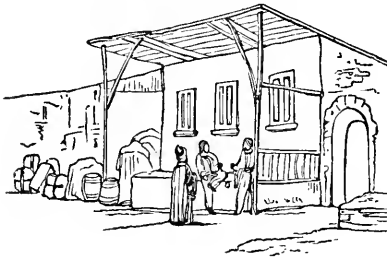

358.

have always been few and simple. They are in this work noticed under separate heads [BED; LAMPS; POTTERY; SEATS; TABLES]. The rooms, however, although comparatively vacant of moveables, are far from having a naked or unfurnished appearance. This is owing to the high ornament given to the walls and ceilings. The walls are broken up into various recesses, and the ceiling into compartments. The ceiling, if of wood and flat, is of curious and complicated joinery; or, if vaulted, is wrought into numerous coves, and enriched with fret-work in stucco; and the walls are adorned with arabesques, mosaics, mirrors, painting, and gold; which, as set off by the marble-like whiteness of the stucco, has a truly brilliant and rich effect. There is much in this to remind one of such descriptions of splendid interiors as that in Isa. liv. 11, 12.

HULDAH or rather **CHULDAH** (חֻלְדָּה; Sept. Ὀλδα), wife of Shallum, a prophetess, who, in the reign of Josiah, abode in that part of Jerusalem called the Mishneh, where the book of the Law was discovered by the high-priest Hilkiah. This prophetess was consulted respecting the denunciations which it contained. She then delivered an oracular response of mingled judgment and mercy; declaring the not remote destruction of Jerusalem, but promising Josiah that he should be taken from the world before these evil days came; B.C. 623 (2 Kings xxii. 14-20; 2 Chron. xxxiv. 22-28). Huldah is only known for this circumstance. She was probably at this time the widow of Shallum, a name too common to suggest any information; but he is said to have been grandson of one Harbas, 'keeper of the wardrobe,' but whether the priestly or the royal wardrobe is uncertain. If the former, he must have been a Levite, if not a priest. As to her residence **בְּמִשְׁנֵה**, in the Mishneh, which the Auth. Vers. renders 'in the college,' there is no ground to conclude that any school or college of the prophets is to be understood. The name means 'second' or 'double;' and many of the Jews themselves (as Jarchi states) understood it as the name of the suburb lying between the inner and outer wall of Jerusalem. It is safest to regard it as a proper name denoting some quarter of Jerusalem about which we are not certain, and, accordingly, to translate 'in the Mishneh;' for which we have the precedent of the Septuagint which has ἐν τῇ **Μασεῖᾳ**. The place of her residence is mentioned probably to show why she, being at hand, was resorted to on this urgent occasion, and not Jeremiah, who was then probably away at his native town Anathoth, or at some more distant place. There were gates of the temple called 'the gates of Huldah' (Mishn. tit. Middoth, i. 3); but this name had probably no connection with the prophetess.

HUNTING. The pursuit and capture of beasts of the field, was the first means of sustenance which the human race had recourse to, this mode of gaining a livelihood having naturally preceded the engagements of agriculture, as it presented food already provided, requiring only to be taken and slaughtered; whereas tillage must have been an afterthought, and a later resource, since it implies accumulated knowledge, skill, and such provision beforehand of subsistence as would enable a clan or a family to wait till the fruits of the earth were matured. Hunting was, therefore, a business long ere it was a sport. And originally, before man had established his empire on the earth, it must have been not only a serious but a dangerous pursuit. In process of time, however, when civilization had made some progress, when cities were built and lands cultivated, hunting was carried on not so much for the food which it brought as for the recreation it gave and its conduciveness to health.

The East—the cradle of civilization—presents us with hunting in both the characters now spoken of, originally as a means of support, then as a manly amusement. In the early records of history we find hunting held in high repute, partly, no doubt, from its costliness, its dangers, its similitude to war, its capability of combining the energies of many, and also from the relief which

it afforded to the stagnant monotony of a court, in the high and bounding spirits that it called forth. Hunting has always borne somewhat of a regal character, and down to the present hour has worn an aristocratic air. In Babylon and Persia this attribute is presented in bold relief. Immense parks (παρδείσας) were enclosed for nurturing and preserving beasts of the chase. The monarch himself led the way to the sport, not only in these preserves, but also over the wide surface of the country, being attended by his nobles, especially by the younger aspirants to fame and warlike renown (Xen. *Cyr.* viii. 1. 38).

In the Bible—our chief storehouse of primitive history and customs—we find hunting connected with royalty so early as in Gen. x. The great founder of Babel was in general reputed as 'a mighty hunter before the Lord.' The patriarchs, however, are to be regarded rather as herdsmen than hunters, if respect is had to their habitual mode of life. The condition of the herdsman ensues next to that of the hunter in the early stages of civilization; and so we find that even Cain was a keeper of sheep. This and the fact that Abel is designated 'a tiller of the ground,' would seem to indicate a very rapid progress in the arts and pursuits of social life. The same contrast and similar hostility we find somewhat later, in the case of Jacob and Esau; the first, 'a plain man dwelling in tents,' the second, 'a cunning hunter, a man of the field' (Gen. xxv. sq.). The account given of Esau in connection with his father seems to show that hunting was, conjointly with tillage, pursued at that time as a means of subsistence, and that hunting had not then passed into its secondary state, and become an amusement.

In Egypt the children of Israel would be spectators of hunting carried on extensively and pursued in different manners, but chiefly, as appears probable, with a view rather to recreation than subsistence (Wilkinson's *Anc. Egypt.* vol. iii.). That the land of promise into which the Hebrews were conducted on leaving Egypt was plentifully supplied with beasts of the chase, appears clear from Exod. xxiii. 29, 'I will not drive them out in one year, lest the land become desolate and the beast of the field multiply against thee' (comp. Dent. iii. 22). And from the regulation given in Lev. xvii. 15, it is manifest that hunting was practised after the settlement in Canaan, and was pursued with the view of obtaining food. Prov. xii. 27 proves that hunting animals for their flesh was an established custom among the Hebrews, though the turn of the passage may serve to show that at the time it was penned sport was the chief aim. If hunting was not forbidden in the 'year of rest,' special provision was made that not only the cattle, but 'the beast of the field' should be allowed to enjoy and flourish on the uncropped spontaneous produce of the land (Exod. xxiii. 11; Lev. xxv. 7). Harmer (iv. 357) says 'there are various sorts of creatures in the Holy Land proper for hunting; wild boars, antelopes, hares, &c. are in considerable numbers there, and one of the Christian kings of Jerusalem lost his life (*Gesta Dei*, p. 887) in pursuing a hare.' That the lion and other ravenous beasts of prey were not wanting in Palestine, many passages of the Bible make obvious (1 Sam. xvii. 34; 2 Sam. xxiii. 20; 1 Kings

xiii. 24; Harris, *Natural History of the Bible*, Kitto's *Pictorial Palestine*). The lion was even made use of to catch other animals (Ezek. xix. 3), and Harmer long ago remarked that as in the vicinity of Gaza, so also in Judæa, leopards were trained and used for the same purpose (Harmer, iv. 358; Hab. i. 8). That lions were taken by pitfalls as well as by nets appears from Ezek. xix. 4, 8 (Shaw, p. 172). In the latter verse the words of the prophet, 'and spread their net over him,' allude to the custom of enclosing a wide extent of country with nets, into which the animals were driven by hunters (Wilkinson, *Anc. Egypt.* iii. 4). The spots thus enclosed were usually in a hilly country and in the vicinity of water brooks; whence the propriety and force of the language of Ps. xlii. 1, 'As the (hunted) hart panteth after the water brooks.' These places were selected because they were those to which the animals were in the habit of repairing in the morning and evening. Scenes like the one now supposed are found portrayed in the Egyptian paintings (Wilkinson). Hounds were used for hunting in Egypt, and, if the passage in Josephus (*Antiq.* iv. 8. 9) may be considered decisive, in Palestine as well. From Gen. xxvii. 3, 'Now take thy weapons, thy quiver and thy bow,' we learn what arms were employed at least in capturing game. Bulls, after being taken, were kept at least for a time in a net (Is. li. 20). Various missiles, pitfalls, snares, and gins were made use of in hunting (Ps. xci. 3; Amos iii. 5; 2 Sam. xxiii. 20). That hunting continued to be followed till towards the end of the Jewish state appears from Josephus (*De Bell. Jud.* i. 20. 13), where the historian speaks of Herod as 'ever a most excellent hunter, for in one day he caught forty wild beasts.' The same passage makes it clear that horses were employed in the pursuits of the chase (comp. Joseph. *Antiq.* xv. 7. 7; xvi. 10. 3).—

J. R. B.

HUSKS. [CERATIA.]

HYACINTH. [LESHEM.]

HYÆNA (יָבֵזָא, *Tzeboā*; in Syro-Hexapl. of Aquila, *Tzaba*; in Arabic, *Tzuba* (Russell's *Aleppo*); *Dubba* (Shaw's *Travels*); *Tzabuon* (Bochart); "ῥαυα, Eccl. xiii. 18). Excepting in Ecclesiasticus just noted, the word does not occur in the English Bible, although there are several passages in the Hebrew canonical books, where *Tzeboā*, 'streaked' or 'variegated,' is as-

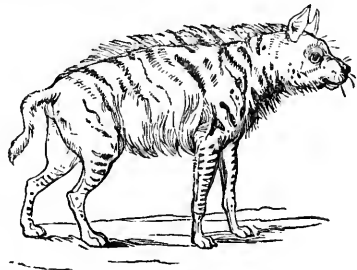

359.

sumed to designate the hyæna. In a work on the *Camide*, the present writer formerly questioned the presence of this animal in Egypt and Western Asia before the Macedonian conquest, and main-

tained that it was scarcely known by name even in the time of Pliny. This opinion was grounded on the total silence of some of the writers of antiquity, and the absurd tales of others; although there were among them natives of Asia Minor; although others had resided in Egypt or in Palestine; and although the whole region in question had been under the successive sway of the Greeks and Romans for above three centuries and a half—the former spreading their language, and the latter maintaining garrisons, in every quarter. Indeed the ancient notices respecting the hyæna are either totally fabulous, or so confused that the moderns, up to a very late period, failed to detect the real animal in the classic authors, and both Belon and Gesner, with others, referred the name to a baboon; while the last-mentioned figured the striped species under the appellation of *lupus marinus*. "Γαῖνα, therefore, in Ecclesiasticus xiii. 18, did not bring commentators to a right understanding of the word; although it is there placed in opposition to the dog, and is much more appropriate when taken for the true hyæna than when applied to a baboon. In the Romaic or modern Greek, *krokatos* and *glanos* are substituted for the ancient denomination hyæna; and hence, when the Sept. rendered עֵיט צְבֹיָה in Jer. xii. 9, by σπηλαίου ἰάλνης, 'the cave of the hyæna,' modern commentators, up to a recent period, were at a loss for the meaning, and preferred to translate the Hebrew *oith tzeboa* 'a speckled bird,' as it stands in our version. But Bochart and the continuator of Calmet vindicate what we take to be the true reading, *oith tzeboa*, 'the striped rasher,' i. e. the hyæna, turning round upon his lair—introduced after an allusion in the previous verse to the lion calling to the beasts of the field (other hyænas and jackals) to come and devour. This allusion, followed up, as it is, by a natural association of ideas, with a description of the pastor, feeder, or rather consumer or devourer of the vineyard, treading down and destroying the vines, renders the natural and poetical picture complete: for the hyæna seeks burrows and caverns for a lair; like the dog it turns round to lie down; howls, and occasionally acts in concert; is loathsome, savage, insatiable in appetite, offensive in smell; and will, in the season, like canines, devour grapes, as the writer has himself ascertained by actual experiment.

Tzeboa, therefore, we consider proved to be, generically, the hyæna; more specifically, the *canis hyæna* of Linn., the *hyæna vulgaris* of more recent naturalists, the *foodh* of Barbary, the *zib*, *drubbah*, *dabah*, *zabah*, and *kaftaar* of modern Semitic nations: and, if the ancients understood anything by the word, it was also their *trochus*. The striped species is one of three or four—all, it seems, originally African, and, by following armies and caravans, gradually spread over Southern Asia to beyond the Ganges, though not as yet to the east of the Bramapootra. It is now not uncommon in Asia Minor, and has extended into Southern Tahtary; but this progress is comparatively so recent that no other than Semitic names are well known to belong to it. The head and jaws of all the species are broad and strong; the muzzle truncated; the tongue like a rasp; the teeth 34 instead of 42, as in the *canidæ*, but robust, large, and eminently formed for biting, lacerating, and reducing the very bone; the neck stiff;

the body short and compact; the limbs tall, with only four toes on each foot; the fur coarse, forming a kind of semi-erectile mane along the back; the tail rather short, with an imperfect brush, and with a fetid pouch beneath it. In stature the species varies from that of a large wolf to much less. Hyænas are not bold in comparison with wolves, or in proportion to their powers. They do not, in general, act collectively; they prowl chiefly in the night; attack asses, dogs, and weaker animals; feed most willingly on corrupt animal offal, dead camels, &c.; and dig into human graves that are not well protected with stakes and brambles. The striped species is of a dirty ashy buff, with some oblique black streaks across the shoulders and body, and numerous cross-bars on the legs; the muzzle and throat are black, and the tip of the tail white.

There is reason to believe that the *deeb*, or Scriptural wolf, when represented as carrying off a lamb, is no other than the hyæna—unless the real wolf has been extirpated; for zoologists have not found the wolf in Syria, and the vague reports of travellers respecting it may apply to wild dogs, whose manners are different, or to *canis anthus* or *thoes anthus*, whose powers are totally inadequate to inspire fear [WOLF.]—C. H. S.

HYMENÆUS (Ἰμηναιος), a professor of Christianity at Ephesus, who, with Alexander (1 Tim. i. 20) and Philetus (2 Tim. ii. 18), had departed from the truth both in principle and practice, and led others into apostacy. The chief doctrinal error of these persons consisted in maintaining that 'the resurrection was past already.' The precise meaning of this expression is by no means clearly ascertained: the most general and perhaps best founded opinion is, that they understood the resurrection in a figurative sense of the great change produced by the Gospel dispensation. Some have suggested, that they attempted to support their views by the Apostle's language in his Epistle to the Ephesians (νεκροὺς—συνεζωπολήσεν—συνήγειρεν, &c. ii. 1-5): but this is very improbable; for if such misconception of his language had arisen, it might easily have been corrected; not to say that one of them appears to have been personally inimical to St. Paul (2 Tim. iv. 14), and would scarcely have appealed to him as an authority. Most critics suppose that the same person is referred to in both the epistles to Timothy by the name of Hymenæus. Dr. Mosheim, however, contends that there were two. He seems to lay great stress on the Apostle's declaration in 1 Tim. i. 20, 'whom I have delivered unto Satan that they may learn not to blaspheme.' But whatever may be the meaning of this expression, the infliction was evidently designed for the benefit and restoration of the parties (comp. 1 Cor. v. 5), and was therefore far from indicating their hopeless and abandoned wickedness. Nor do the terms employed in the second Epistle import a less flagrant violation of the Christian profession than those in the first. If in the one the individuals alluded to are charged with having 'discarded a good conscience' and 'made shipwreck of faith,' in the other they are described as indulging 'in vain and profane babblings, which would increase to more ungodliness,' as 'having erred concerning the truth,' and 'overthrowing the faith' of others. These can hardly be said to be 'two distinct characters having nothing in common but the name' (Mosheim's Commentaries, i. 304-306).

For other interpretations of 2 Tim. ii. 18, see Gill's *Commentary*, in loc., and Walchii *Miscellanea Sacra*, i. 4; *de Hymenæo Phileto*, Amstel. 1744.—J. E. R.

HYMN (ὑμνος). In the only places of the New Testament where this word occurs, it is connected with ψαλμοί, others of very similar import. 'Speaking to yourselves in psalms (ψαλμοῖς), and hymns (ὑμνοῖς), and spiritual songs (ᾠδαίς), singing and making melody in your heart to the Lord' (Eph. v. 19; Col. iii. 16). It has been conjectured, that by 'psalms and hymns' the poetical compositions of the Old Testament are chiefly to be understood, and that the epithet 'spiritual,' here applied to 'songs,' is intended to mark those devout effusions which resulted from the spiritual gifts granted to the primitive church; yet in 1 Cor. xiv. 26 a production of the latter class is called 'a psalm.' Josephus, it may be remarked, uses the terms ὑμνοὶ and ᾠδαί in reference to the Psalms of David (*Antiq.* vii. 12. 3). Our information respecting the hymnology of the first Christians is extremely scanty: the most distinct notice we possess of it is that contained in Pliny's celebrated Epistle (*Ep.* x. 97): '*Carmen Christo quasi deo, dicere secum invicem*' (Augusti, *Handbuch der Christlichen Archæologie*, B. V. *Gebet und Gesang*, ii. 1-160; Walchii *Miscellanea Sacra*, i. 2; *De hymnis ecclesiæ Apostolicæ*, Amstel. 1744).

The hymn which our Lord sung with his disciples at the Last Supper is generally supposed to have been the latter part of the *Hallel*, or series of psalms which were sung by the Jews on the night of the Passover, comprehending Ps. cxiii.-cxviii.; Ps. cxlii. and cxiv being sung before, and the rest after the Passover (Buxtorfii *Lex. Talm.* s. v. הלל, quoted by Kuinoel, on Matt. xxvi. 30; Lightfoot's *Heb. and Talm. Exercitations*, on Mark xiv. 26; *Works*, xi. 435).—J. E. R.

HYPERBOLE. Any one who carefully examines the Bible must be surprised at the very few hyperbolic expressions which it contains, considering that it is an oriental book. Some of these few have occasioned so much difficulty to sincere men, that we have reason to bless God that the scene of those great events which comprise the history of man's salvation, was laid in Western, and not in Eastern Asia, where the genius of hyperbole reigns without limit or control. In Eastern Asia the tone of composition is pitched so high as to be scarcely intelligible to the sober intellect of Europe; while in Western Asia a medium seems to have been struck between the ultra-extravagance of the far east, and the frigid exactness of the far west.

But even regarded as a book of Western Asia, the Bible is, as compared with almost any other Western Asiatic book, so singularly free from hyperbolic expressions as might well excite our surprise, did not our knowledge of its divine origin permit us to suppose that even the style and mode of expression of the writers were so far controlled, as to exclude from their writings what, in other ages and countries, might excite pain and offence, and prove an obstacle to the reception of divine truth. Nor is it to be said that the usage of hyperbole is of modern growth. We find it in the oldest eastern writings which now exist; and the earlier rabbinical writings

attest that, in times approaching near to those in which the writers of the New Testament flourished, the Jewish imagination had run riot in this direction, and has left hyperboles as frequent and outrageous as any which Persia or India can produce.

These things being considered, we shall certainly have more cause to admire the rarity of hyperbolic expressions in the Bible than to marvel at those which do occur:

The strongest hyperbole in all Scripture is that with which the Gospel of St. John concludes:—'There are also many other things which Jesus did, the which, if they should be written every one, I suppose that the world itself could not contain all the books that should be written.' This has so much pained many commentators, that they have been disposed to regard it as an unauthorized addition to the sacred text, and to reject it accordingly. Now this is always a dangerous process, and not to be adopted but on such overwhelming authority of collated manuscripts as does not exist in the present case. How much more natural and becoming is it to regard the verse simply as a hyperbole, so perfectly conformable to Oriental modes of expression, and to some other hyperboles which may be found interspersed in the sacred books, that the sole wonder really is that this one should be rare enough to afford ground for objection and remark.

This view of the matter might be illustrated by many examples, in which we find sacred and profane authors using hyperboles of the like kind and signification. In Num. xii. 33, the spies who had returned from searching the land of Canaan, say, that they saw 'giants there, of such a prodigious size, that they were in their own sight as grasshoppers.' In Deut. i. 28, cities with high walls about them are said to be 'walled up to heaven.' In Dan. iv. 7, mention is made of a tree whereof 'the height reached unto heaven, and the sight thereof unto the end of all the earth:' and the author of Ecclesiasticus (xlvii. 15), speaking of Solomon's wisdom, says, 'Thy soul covered the whole earth, and thou fillest it with parables.' As the world is here said to be filled with Solomon's parables; so in John xxi. 25, by one degree more of hyperbole, it is said that the world could not contain all the books that should be written concerning Jesus's miracles, if a particular account of every one of them were given. In Josephus (*Antiq.* xiv. 22) God is mentioned as promising to Jacob that he would give the land of Canaan to him and his seed; and then it is added 'they shall fill the whole sea and land which the sun shines upon.' Wetstein, in his note on the text in John, and Basnage, in his *Histoire des Juifs* (iii. 1-9; v. 7), have cited from the ancient rabbinical writers such passages as the following:—'If all the seas were ink, and every reed was a pen, and the whole heaven and earth were parchment, and all the sons of men were writers, they would not be sufficient to write all the lessons which Juchanan composed;' and concerning one Eliezer it is said, that 'if the heavens were parchment, and all the sons of men writers, and all the trees of the forest pens, they would not be sufficient for writing all the wisdom which he was possessed of.'

Hyperboles not less strong than that under review find their way into our own poetry, with-

out shocking our judgment or offending our taste, thus :—

‘And I as rich in having such a jewel

As fifty seas, if all their sands were pearl,

Their rivers nectar, and their rocks pure gold.’

Homer, who if not born in Asia Minor, had undoubtedly lived there, has sometimes followed the hyperbolic manner of speaking which prevailed so much in the East: thus, in *Iliad* xx. 246, 247, he makes Æneas say to Achilles, ‘Let us have done with reproaching one another; for we may throw out so many reproachful words on one another, that a ship of a hundred oars would not be able to carry the load.’ Few instances of this are to be found in Occidental writers; yet it is observed that Cicero (*Phil.* ii. 41) has ‘præsertim quum illi eam gloriam consecuti sint, quæ vix cœlo capi posse videatur,’ and that Livy (vii. 25) says, ‘hæ vires populi Romani, quas vix terrarum capit orbis.’ See Bishop Pearce’s *Commentary on the Four Evangelists*, 1777, &c.

HYSSOP (עֲשׂוֹבִי *esobh*; Gr. ὑσσώπος). A great variety of opinions have been entertained respecting the plant called *esobh*, translated ‘hyssop’ in the Authorized Version both of the Old and the New Testament; but as yet no satisfactory investigation has been made, so as to enable us to fix with certainty on the plant intended. The difficulty appears to have arisen from the similarity of the Greek name ὑσσώπος to the Hebrew *esobh*, whence the former seems, from an early period, to have been considered synonymous with the latter, and used for it in referring to the passages of the Old Testament where it is mentioned. As the ὑσσώπος of Greek authors is generally acknowledged to be the common hyssop (*Hyssopus officinalis* of botanists), it has been inferred that it must also be the plant of the Old Testament, as well as that referred to in the New Testament. This inference has not, however, been universally acquiesced in; for Celsus enumerates, under no less than eighteen heads, the different plants which have been adduced by various authors as the hyssop of Scripture. Before mentioning these, it is desirable to refer to the passages of the Old and New Testament where the plant is mentioned. The first notice of it occurs in Exod. xii. 22, where a bunch of hyssop is directed to be dipped in blood and struck on the lintels and the two side-posts of the doors of the houses in which the Israelites resided. It is next mentioned in Lev. xiv. 4, 6, 52, in the ceremony for declaring lepers to be cleansed; and again, in Num. xix. 6, 18, in preparing the water of separation. To these passages the apostle alludes in Heb. ix. 19:—‘For when Moses had spoken every precept to all the people, according to the law, he took the blood of calves, and of goats, with water, and scarlet wool, and hyssop, and sprinkled both the book and all the people.’ From this text we find that the Greek name ὑσσώπος was considered synonymous with the Hebrew *esobh*; and from the preceding that the plant must have been leafy, and large enough to serve for the purposes of sprinkling, and that it must have been found in Lower Egypt, as well as in the country towards Mount Sinai, and onwards to Palestine. From the following passages we get some information respecting the habits and the supposed properties of the plant. Thus, in 1 Kings

iv. 33, it is said, ‘Solomon spoke of trees, from the cedar-tree that is in Lebanon, even unto the hyssop that springeth out of the wall;’ and in the penitential psalm of David (li. 7), ‘Purge me with hyssop, and I shall be clean: wash me, and I shall be whiter than snow.’ In this passage it is, no doubt, considered by some commentators that hyssop is used in a figurative sense; but still it is possible that the plant may have possessed some general cleansing properties, and thus come to be employed in preference to other plants in the ceremonies of purification. It ought, at all events, to be found growing upon walls, and in Palestine. In the account of the crucifixion of our Saviour, the Apostle John says (John xix. 29), ‘Now there was set a vessel full of vinegar, and they filled a sponge with vinegar, and put it upon hyssop, and put it to his mouth.’ In the parallel passages of Matthew (xxvii. 48) and Mark (xv. 36), it is stated that the sponge filled with vinegar was put upon a reed or stick. To reconcile these statements, some commentators have supposed that both the sponge and the hyssop were tied to a stick, and that one apostle mentions only the hyssop, because he considered it as the most important; while, for the same reason, the other two mention only the stick; but the simplest mode of explaining the apparent discrepancy is to consider the hyssop and the stick to be the same thing—in other words, that the sponge was affixed to a stick of hyssop.

A great variety of plants have been adduced by different authors as that alluded to in the above passages, though some do not seem to think it necessary to reconcile the plant which they prefer to more than one or two of the passages, and seldom take the trouble of proving that it is found in the localities where the hyssop is stated to have been employed.

Celsus enumerates the several plants which have been adduced, under eighteen different heads. Of these some belong to the class of ferns, as *Capillus Veneris*, maiden-hair, and *Ruta Muraria*, or wall-roe, because they will grow upon walls; so also do the *Polytrichum*, or hair-moss, the *Kloster hyssops*, or pearlwort, and *Sagina procumbens* are suggested by others, because from their growing on rocks or walls, they will answer to the passage in 1 Kings iv. 33, and from their smallness contrast well with the cedar of Lebanon, and are a proof of the minute knowledge of Solomon. Some again contend for species of wormwood, as being, from their bitterness, most likely to have been added to the vinegar in the sponge, that it might be more distasteful to our Saviour. The majority, however, have selected different kinds of fragrant plants belonging to the natural family of *Labiata*, several of which are found in dry and barren situations in Palestine, and also in some parts of the Desert. Of these may be mentioned the rosemary, species of lavender, of mint, of marjoram, of thyme, of savory, of thymbra, and others of the same tribe, resembling each other much in characters as well as in properties: but it does not appear that any of them grow on walls, or are possessed of cleansing properties; and, with the exception of the rosemary, they are not capable of yielding a stick, nor are they found in all the required situations. If we look to the most recent authors, we find some other plants adduced, though the generality adhere to the common hyssop. Sprengel (*Hist. Rei Herb.*

i. 14) seems to entertain no doubt that the *Thymbra spicata* found by Hasselquist, on the ruins about Jerusalem, is the hyssop of Solomon; though Hasselquist himself thought that the moss called *Gymnostomum truncatum* was the plant. Lady Calcott asks, 'Whether the hyssop upon which St. John says the sponge steeped in vinegar was put, to be held to the lips of Christ upon the cross, might not be the hyssop attached to its staff of cedar-wood, for the purposes of sprinkling the people, lest they should contract defilement on the eve of the Sabbath, which was a high-day, by being in the field of execution' (*Scripture Herbal*, p. 205). Rosenmüller, again, thinks that the Hebrew word *Esobh* does not denote our hyssop, but an aromatic plant resembling it, the wild marjoram, which the Germans call *Dosten*, or *Wohlgemuth*, the Arabs *Zatar*, and the Greeks *Origanum*. In the *Pictorial Bible* (i. 161), Mr. Kitto observes 'that the hyssop of the sacred Scriptures has opened a wide field for conjecture, but in no instance has any plant been suggested that, at the same time, has a sufficient length of

stem to answer the purpose of a wand or pole, and such detergent or cleansing properties as to render it a fit emblem for purification; and he suggests it as probable, that 'the hyssop was a species of *Phytolacca*, as combining length of stem with cleansing properties, from the quantity of potash which is yielded by the ashes of the American species, *P. decandra*, of this genus.' *P. Abyssinica* grows to the size of a shrub in Abyssinia. Winer (*Bibl. Realwörterbuch*, ii. 819, s. v. *Ysop*) gives a description of the common hyssop, but says that it must not be concealed that the Talmudists distinguish the hyssop of the Greeks and Romans from that mentioned in the law. He then adduces the *Origanum*, mentioned in the quotation from Rosenmüller, as the *Esobh* of the Hebrews; but concludes by observing that a more accurate examination is required of the hyssops and *Origana* of that part of Asia, before the meaning of the Hebrew *Esobh* can be considered as satisfactorily determined. For any new information we may be able to communicate, see *Ysop*.—J. F. R.

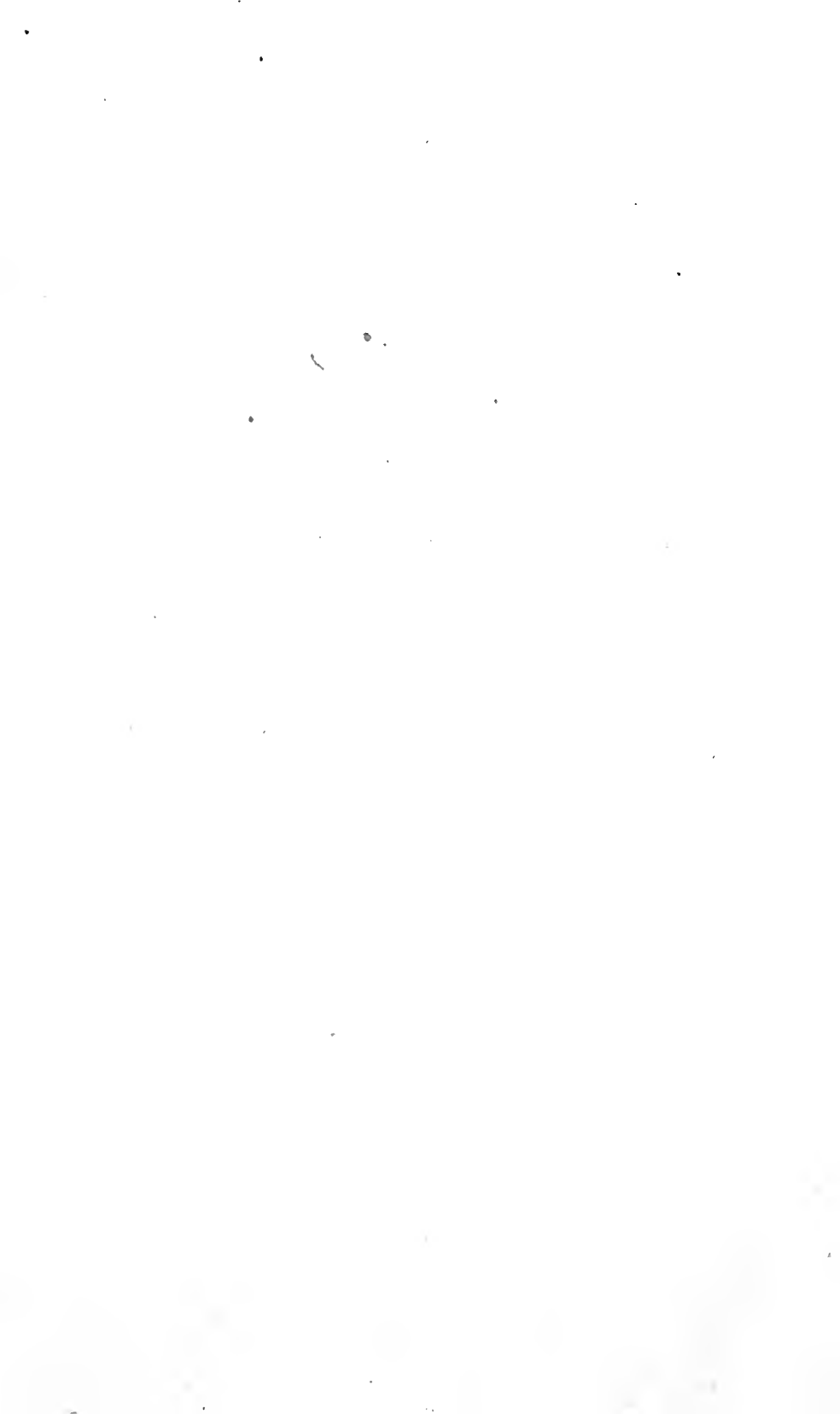

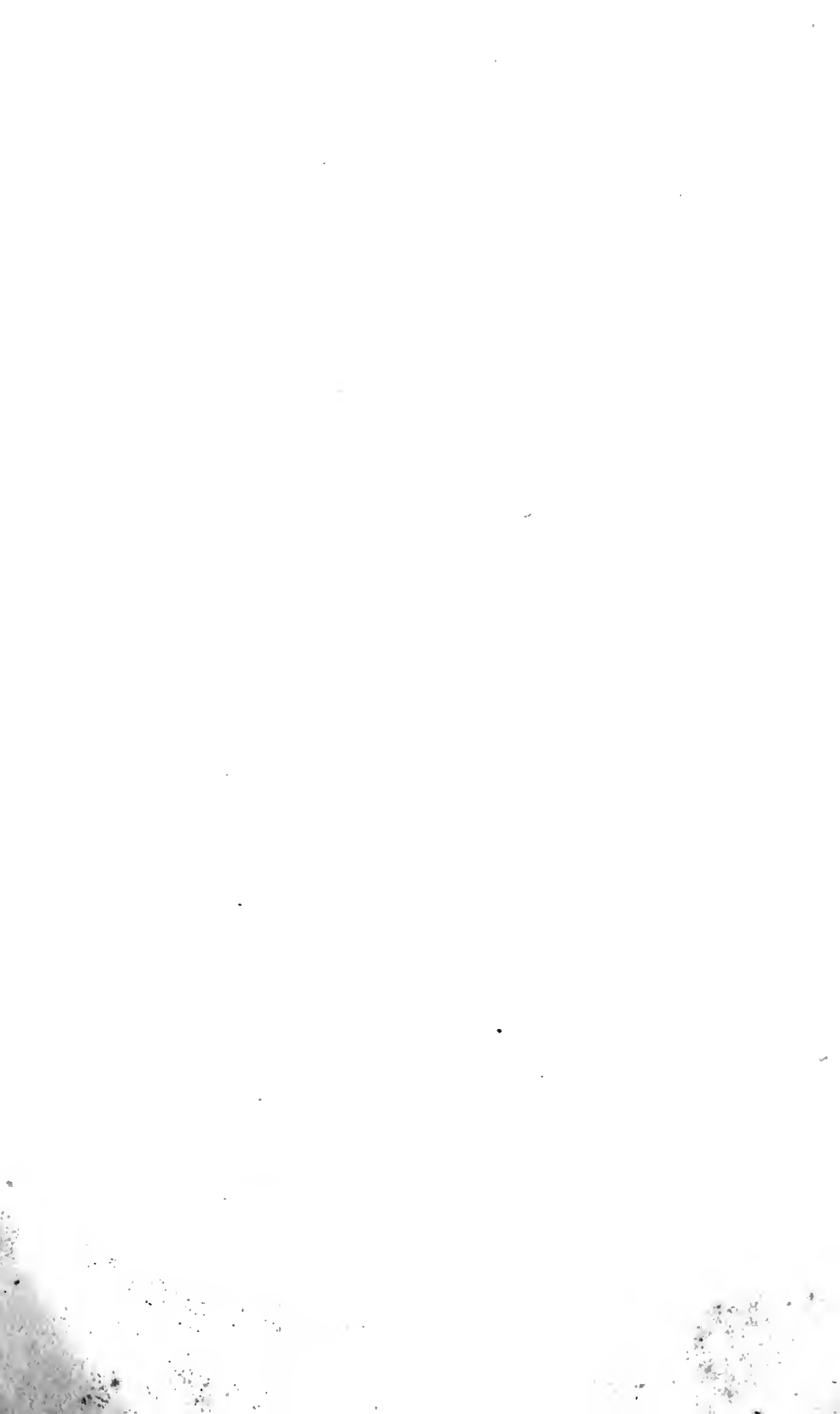

Princeton Theological Seminary-Speer Library



1 1012 01124 4136

