

DEFENSE

101
CIRCULATING





Digitized by the Internet Archive
in 2011 with funding from
CARLI: Consortium of Academic and Research Libraries in Illinois

<http://www.archive.org/details/dentos1939unse>

DENTOS

1

9

3

9

Co-Editors

LAWRENCE SCHEFF

FRANK JERBI

Business Managers

ARTHUR ADAMS

MAX SHAPIRO

The



80925

THE UNIVERSITY OF CHICAGO LIBRARY
CLASSICAL ARCHITECTURE

DENTOS

for 1939

Published by the
Senior Class of the
CHICAGO COLLEGE
OF DENTAL SURGERY
Dental Department of
Loyola University

FOREWORD

Four years of our lives—years that have permitted us to snatch a fragment of knowledge and given us the opportunity to acquire the open eyes and clear head that are so essential if we are to go forward on our path surrounded by a world of turmoil—have come to a happy completion. It is our purpose to perpetuate the spirit and events of these vital years.





CONTENTS

F A C U L T Y

S E N I O R S

U N D E R C L A S S M E N

P U B L I C A T I O N S

F R A T E R N I T I E S

A T H L E T I C S

DR. HENRY GLUPKER





DEDICATION

To Dr. Henry Glupker—an incomparable teacher, a sympathetic adviser, and a true friend—this volume is respectfully dedicated.



Charles Nelson Johnson

1860-1938

In Memoriam

In him we had a great and distinguished man, one who rendered a signal service to dentistry and whose achievements were surpassed only by his devotion to his students.

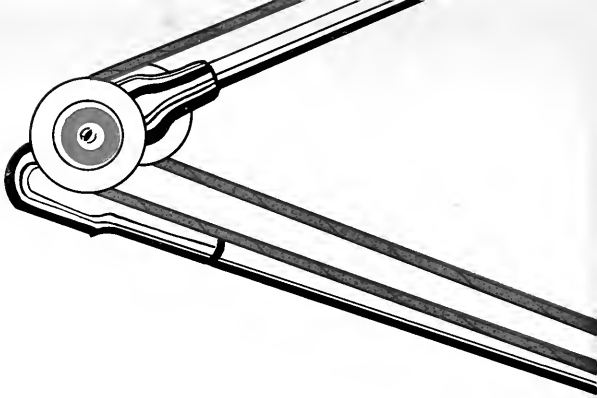

It matters much whether we make good dentists in our college course, but it matters more that we make of them good men and good citizens of the world.

W. H. G. Logan

FACULTY

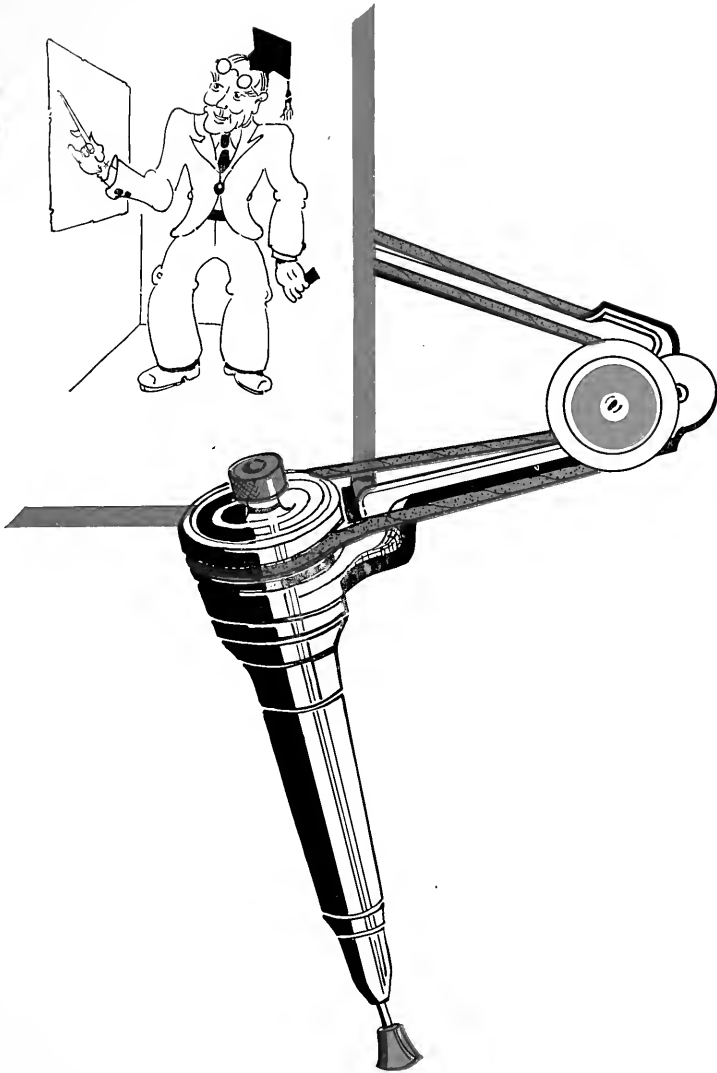

ADMINISTRATION

An institution of learning is no greater than the body of men who direct it. Under the guidance of capable men our college and university have attained a standing second to none. For fifty-two years they have taught and inspired students of dentistry—for fifty-two years dental education has progressed by their untiring efforts to improve technique and their constant search for scientific truth. Men of knowledge and understanding alike they have endeared themselves forever in the hearts of their students. The administration has built through the years a school and faculty with these purposes ever foremost — to teach a profession and to make men.



SAMUEL KNOX WILSON, S.J.
President

WILLIAM H. G. LOGAN

Dean of the Faculty; Professor of Oral Surgery and Oral Pathology; D. D. S., Chicago College of Dental Surgery; M. D., Chicago College of Medicine and Surgery; F. A. C. S.; LL.D.; Delta Sigma Delta.

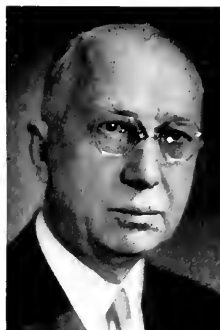

ROBERT W. McNULTY

Assistant Dean; Assistant Professor of Ethics, Economics, and Dental Anatomy; A. B., Hanover College; D. D. S., Chicago College of Dental Surgery; M. A. Loyola University; Delta Sigma Delta.



PLINY G. PUTERBAUGH

Secretary of the Faculty; Professor of Principles of Medicine; Associate Professor of Oral Surgery; M. D., Chicago College of Medicine and Surgery; D. D. S., Chicago College of Dental Surgery; Delta Sigma Delta.





WILLIAM D. ZOETHOUT

Professor of Physiology and Pharmacology; A. B., Hope College; Ph.D., University of Chicago; Sigma Xi.

JOHN L. KENDALL

Professor of Chemistry and Metallurgy; B. S., Valparaiso University; Ph.G., Valparaiso University; M.D., University of Kentucky; Psi Omega.

RUDOLF KRONFELD

Professor of Dental Histology and Dental Pathology; Director of the Department of Research; M. D., University of Vienna; D. D. S., Chicago College of Dental Surgery; B. S., Loyola University; Delta Sigma Delta.

OSCAR KANNER

Professor of Bacteriology and Pathology; M. D., University of Vienna; B. S., Sorbonne University, Paris.



LOZIER D. WARNER

Assistant Professor of Bacteriology and Pathology; Assistant in the Department of Research; B.A., Manchester College.

RALPH H. FOUSER

Associate Professor of Anatomy; F. A. C. S.; D. D. S., Northwestern University; B. S., Lewis; M. D., Rush Medical College of the University of Chicago; B. S. M., Loyola University; Phi Beta Pi; Alpha Omega Alpha; Xi Psi Phi.





EDGAR D. COOLIDGE

Professor of Therapeutics, Preventive Dentistry and Oral Hygiene; D. D. S., Chicago College of Dental Surgery; M. S., Xi Psi Phi.

JOHN P. BUCKLEY

Professor Emeritus of Materia Medica and Therapeutics; Ph.G., Valparaiso University; D. D. S., Chicago College of Dental Surgery; Delta Sigma Delta.



THOMAS L. GRISAMORE

Professor of Orthodontia; Ph.G., Valparaiso University; D. D. S., Chicago College of Dental Surgery; Delta Sigma Delta.

RALPH G. LARSEN

Instructor in Therapeutics; D. D. S., Chicago College of Dental Surgery; Delta Sigma Delta.

JEROME J. VIK

Instructor in Orthodontia; Junior Lecturer in Orthodontia; D. D. S., Chicago College of Dental Surgery; M. D. S., Loyola University; Xi Psi Phi.

HOWARD MICHENER

Assistant Professor of Orthodontia; D. D. S., Chicago College of Dental Surgery; Delta Sigma Delta.





WILLIAM I. McNEIL

Professor of Prosthetic Dentistry; D. D. S., Chicago College of Dental Surgery; Delta Sigma Delta.

HENRY GLUPKER

Associate Professor of Prosthetic Dentistry; D. D. S., Chicago College of Dental Surgery; B. S., Loyola University; Delta Sigma Delta.

ELBERT C. PENDLETON

Associate Professor of Diagnosis and Full Denture Research; D. D. S., Chicago College of Dental Surgery; M. D. S., Loyola University; Xi Psi Phi.

EARL L. RICHEY

Assistant Professor of Prosthetic Dentistry; D. D. S., University of Iowa; M. D. S., Northwestern University; Xi Psi Phi.



WILLIAM N. HOLMES

Instructor in Dental Anatomy and Prosthetic Dentistry; D. D. S., Chicago College of Dental Surgery; Delta Sigma Delta.

WALTER A. WYKHIUS

Instructor in Prosthetic Dentistry; D. D. S., Chicago College of Dental Surgery; A. B., Calvin College; Delta Sigma Delta.

AUGUSTUS H. MUELLER

Assistant Professor of Operative Dentistry; D. D. S., Chicago College of Dental Surgery; M. S., Loyola University; Delta Sigma Delta.

WARREN WILLMAN

Associate Professor of Operative Dentistry; D. D. S., Chicago College of Dental Surgery; M. S., Loyola University; Delta Sigma Delta.



EARL P. BOULGER

Assistant Professor of Radiology; Instructor in Operative Dentistry; D. D. S., Chicago College of Dental Surgery; L. D. S.; Delta Sigma Delta.

JOSEPH S. RZESZOTARSKI

Instructor in Children's Dentistry; Lecturer in Oral Hygiene and Preventive Dentistry; D. D. S., Chicago College of Dental Surgery; Forsyth Infirmary; University of Iowa; Delta Sigma Delta.

PAUL W. DAWSON

Instructor in Operative Dentistry; D. D. S., Chicago College of Dental Surgery; Delta Sigma Delta.

FRANK W. HYDE

Instructor in Operative Dentistry and Crown and Bridge Technology; D. D. S., Chicago College of Dental Surgery; Delta Sigma Delta.

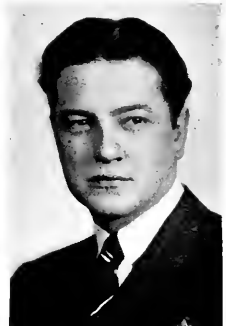



ROBERT E. MAC BOYLE

Professor of Crown and Bridge Work; D. D. S., Chicago College of Dental Surgery.

HAROLD W. OPPICE

Assistant Professor of Crown and Bridge Work; D. D. S., Chicago College of Dental Surgery; Xi Psi Phi.

FRANK P. LINDNER

Assistant Professor of Crown and Bridge Work; D. D. S., Chicago College of Dental Surgery; Delta Sigma Delta.

GEORGE C. PIKE

Assistant Professor of Crown and Bridge Work; D. D. S., Chicago College of Dental Surgery; Delta Sigma Delta.



JOHN R. WATT

Associate Professor Emeritus of Crown and Bridge Work; D. D. S., Chicago College of Dental Surgery; Delta Sigma Delta.

R. HAROLD JOHNSON

Assistant Professor of Crown and Bridge Work and Prosthetic Technology; D. D. S., Chicago College of Dental Surgery; Delta Sigma Delta.





KARL A. MEYER

Associate Professor of Surgery; M. D., Illinois College of Medicine; Psi Omega.

JOHN F. SVOBODA

Instructor of Exodontia; D. D. S., Chicago College of Dental Surgery; B. S., Loyola University; Delta Sigma Delta.



ARNO LESHIN

Instructor in Anatomy; M. D., University of Wisconsin; B. A., University of Wisconsin; Alpha Omega.

WALLACE N. KIRBY

Instructor in Technical Composition; B. S., University of Illinois; D. D. S., Chicago College of Dental Surgery; Delta Sigma Delta.

HENRY L. BORIS

Instructor in Physics; B. S., University of Illinois; D. D. S., Chicago College of Dental Surgery; Delta Sigma Delta.

DWIGHT C. ATKINSON

Instructor in Radiography; D. D. S., Marquette University School of Dentistry; Delta Sigma Delta.





HAROLD HILLENBRAND

Instructor in Economics; B. S. D., Loyola University;
D. D. S., Chicago College of Dental Surgery; Delta
Sigma Delta.

LOIS E. CONGER

Instructor in Exodontia; R. N.

CAROLYN HAMMOND

Research Technician; M. A.

MAURINE WILLMAN

Research Technician; B. A.



RUTH WALSH

Librarian

THELMA CLINE

Department of Therapeutics; R. N.

FLORENCE MACDONALD

Cashier.

MARGARET KNIGHT

Clerk of Infirmary.



HAZEL L. JOHNSON

Information Clerk.

HAZEL TONKINS

Clerk of Infirmary.



GLADYS M. KNOERNSCHILD

Fiscal Secretary.

LAURA S. DICKISON

Secretary to the Assistant Deon.



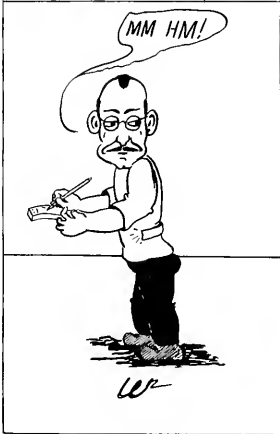
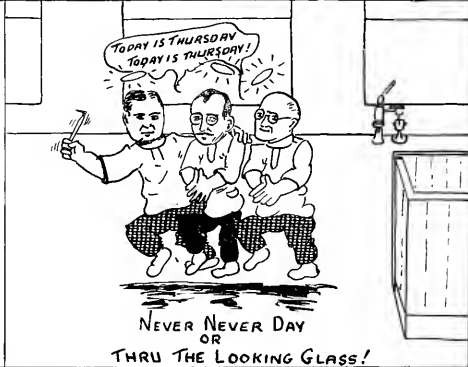
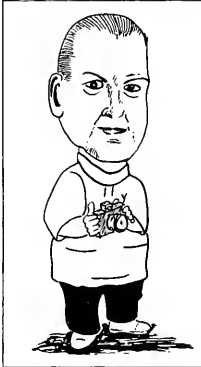
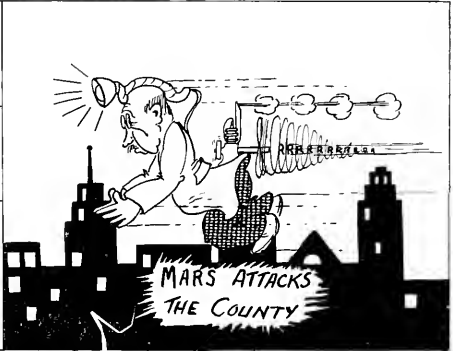
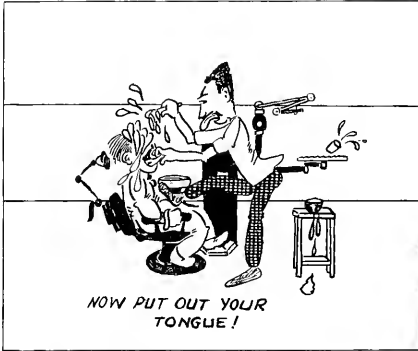



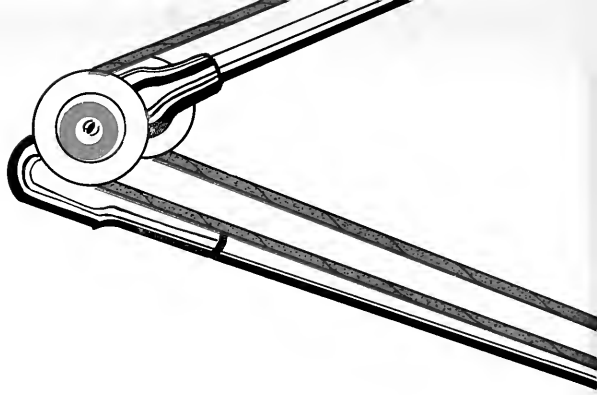

Four years of devotion to a single cause has demonstrated their steadfastness of purpose and ability to achieve success. May their courage never falter.

P. G. PUTERBAUGH

SENIORS

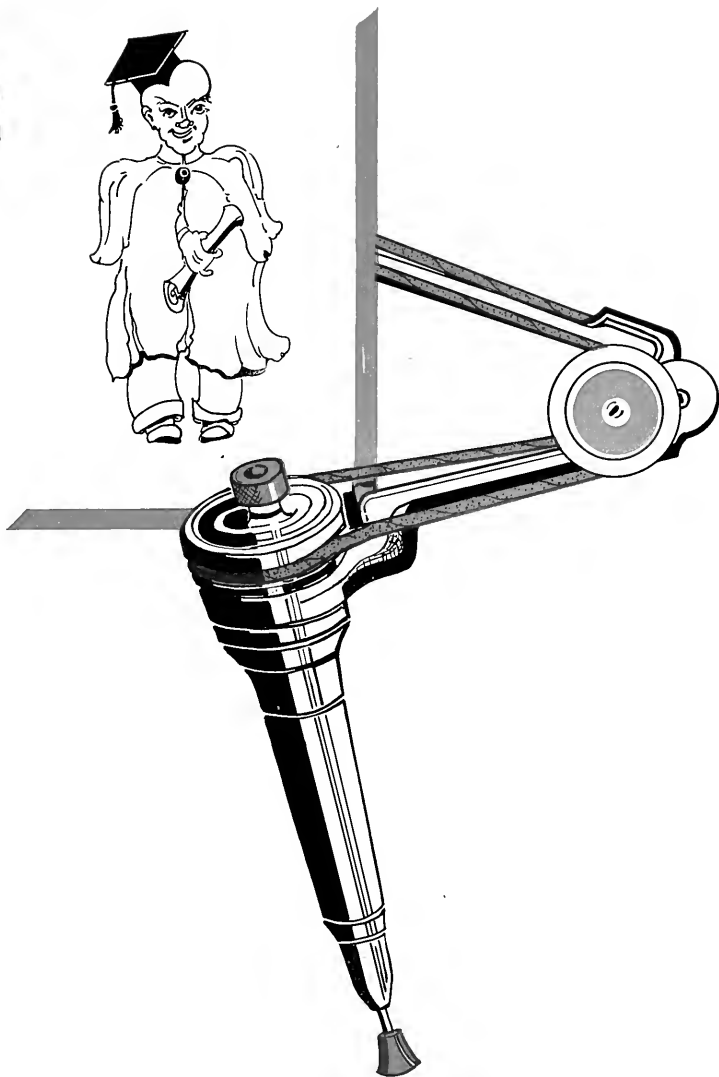

The SENIOR Class

KELLY
DeWITT
BASSAK



JENKINS
SMEBY
DAVIDSON



It would be quite impossible to set down all laughs, heartaches, triumphs, and despairs, that have occurred during our five years of existence here, but we will try to chronicle the more important of these events.

Those who received their pre-dental education here will remember the days when we rushed back and forth from the Downtown College to the Dental building to attend our classes, and the efforts of Mr. Lodeski to cram some knowledge into our thick crania. Jerbi, McKee, and Paone were elected to the class officers that year.

The memories of Dr. McNulty's machine-gun lectures, Dr. Kendall's philosophies, and Dr. Fouser's ensembles bring back our freshman days. Most of us will never forget the rope jumping contest in anatomy with the small intestine as the rope, and the time we planted a finger in one of our classmates pockets.

Our annual political maneuvering resulted in the election of McKee, Moses, Jerbi, and Paone as our officers. The skill shown in arranging the election beforehand put the Tammany and Kelly-Nash machines to shame. The big social event of the year, a dinner dance, was

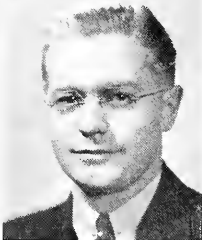



held at the Silver Room of the Knickerbocker Hotel, and those who remained sober throughout the evening, reported the affair to be a huge success.

We returned to school as Sophomores with a feeling of assurance that we had succeeded in mastering such subjects as Anatomy, Chemistry, Prosthetics, and Histology. Operative Dentistry was the course we all eagerly awaited. Here was a chance to practice real Dentistry, and on a patient who felt no pain, and whose oral cavity received a brilliant illumination from the region of the throat.

The pre-election caucuses ended with Adams, Paone, Epstein, and Kelly being chosen as class officers. The annual class dance was held at the Graemere Hotel and the affair was marred only by the factor that we ran into debt.

The first days we spent in the clinic will long be a fond remembrance. Raynes' electromagnetic broach remover and Politis' feat of setting a bridge with a mixture of petrolatum and cement powder were examples of our ingenuity at devising new methods for performing our clinical duties. The master strategists met that year and elected Singler, Shapiro,

Rossa, and Kurtz to the class offices.

An event that will long be inscribed upon our memories was our Junior-Senior Prom—an affair that has since been pronounced the most successful and most "celebrated" prom in the history of the college. The scene of this momentous occasion was the beautiful grand ballroom of the Lake Shore Athletic Club. The success of this dance was due to the work of the committee composed of Limacher, chairman; Moses, McKee, Jerbi, Jenkins, DeWitt and Bassak.

Then came the realization of our ambitions—we were Seniors. The mad chase for points had worn us down somewhat, but at last we were approaching the end of our trail. After the usual subterfuge, the following men were elected as class officers: Kelly, President; Jenkins, Vice-President; Smeby, Secretary; DeWitt, Treasurer; Bassak, Sargent-at-Arms; Jerbi and Scheff, Co-editors of the *Dentos*; Adams and Shapiro, Business managers of the *Dentos*; Paone, Class Artist.

The memories of the struggles and joys of this year will forever be with us. We hope that the following pages will help enhance them.



ARTHUR G. ADAMS

Villa Park, Illinois; Loyola University.
Class president '37; Loyola News; Bur Staff '35;
Dentos, Co-Business Manager '39; Xi Psi Phi;
Blue Key; Intramural Athletics.



THEODORE C. AHNGER

Chicago, Illinois; Loyola University.
Class sergeant-at-arms '37; Delta Sigma Delta;
Varsity Swimming '38.



WILLIAM E. ALLEN

Oak Park, Illinois; Loyola University.



SEYMOURE H. APPELL, B.S.

Chicago, Illinois; City College of New York.
Loyola News; Alpha Omega; Intramural Athletics.



MARION D. APPLE

Hutsonville, Illinois; Loyola University.



JOEL D. ARNOLD

Chicago, Illinois; North Park College.
Loyola News; Intramural Athletics.



CURTIS J. BABCOCK

Bensenville, Illinois; Loyola University.
Intramural Athletics.



CASIMIR A. BASSAK

Chicago, Illinois; Loyola University.
Class sergeant-at-arms '39; Junior-Senior Prom
Committee; Psi Omega; Intramural Athletics.

LEONARD H. BECKER

Chicago, Illinois; University of Chicago.
Alpha Omega.

EVO J. BINOTTI

Chicago, Illinois; Loyola University.
Psi Omega; Intramural Athletics.

EUGENE C. BLATTER

Chicago, Illinois; University of Chicago.
Central Y. M. C. A. College.

WILLIAM B. BURKE

Chicago, Illinois; University of Chicago; Loyola University; Delta Sigma Delta; Intramural Athletics

M. A. BUTLER

Washburn, Illinois; Eureka College.
Delta Sigma Delta.

JOSEPH J. CIBULKA

Cicero, Illinois; Loyola University.
Delta Sigma Delta.

ALBERT DAVIDSON

Chicago, Illinois; Loyola University.
Chairman of Executive Committee '39.

TRUMAN G. DE WITT

Green City, Missouri; University of Illinois.
Class treasurer '39; Dentos Staff '37; Junior-Senior Prom Committee; Student Instructor of Ceramics; Delta Sigma Delta; Alpha Sigma Nu.



RUDOLPH F. DOBRY, B.S.

Algoma, Wisconsin; Marquette University.
Xi Psi Phi; Intramural Athletics.

HAROLD EPSTEIN

Chicago, Illinois; Peoples Junior College.
Class secretary '37; Alpha Omega; Intramural Athletics.

MAURICE FEIN

Chicago, Illinois; Crane Junior College, Lewis Institute; Central Y. M. C. A. College.
Alpha Omega; Intramural Athletics.

HOWARD M. FISHER

Berwyn, Illinois; J. S. Morton Junior College.
Delta Sigma Delta.

HOWARD H. GAULT

Chicago, Illinois; University of Illinois.
Loyola News '38, '39; Dentos Staff '39; Intramural Athletic Director '39; Intramural Athletics.

AUGUST A. GIRALDI

Chicago, Illinois; Wright Junior College; Crane College.
Delta Sigma Delta; Intramural Athletics.

HENRY O. GOLD

Chicago, Illinois; Loyola University.
Alpha Omega; Intramural Athletics.

LAWRENCE L. GOLDEN

Chicago, Illinois; North Park Junior College;
University of Illinois.
Intramural Athletics.

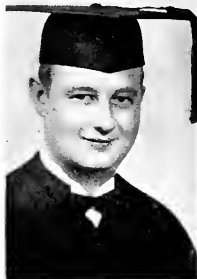

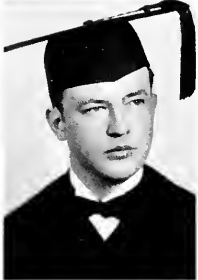

ROBERT M. GORDON

Avon, Illinois; Western Illinois State Teacher's College.

SIDNEY GOREN

Chicago, Illinois; University of Illinois; Loyola University.
Intramural Athletics.

BEN H. GORSKY

Chicago, Illinois; Central Y. M. C. A. College; Crone College.
Intramural Athletics.

THOMAS J. GRISAMORE, JR., B.A., M.D.

Wilmette, Illinois; Colgate University; Rush Medical College.
Bur Staff '37, '38; Student Instructor in Anatomy, Histology, Chemistry, and Physiology; Delta Sigma Delta.

STEPHEN A. HAJDUK

Chicago, Illinois; Loyola University.
Xi Psi Phi; Intramural Athletics.

LUTHER H. HALE

Tyler, Texas; Sam Houston College.
Delta Sigma Delta.

DALE S. JENKINS

Chicago, Illinois; Blackburn University.
Class vice-president '39; Junior-Senior Prom Committee; Xi Psi Phi.

FRANK C. JERBI

South Wilmington, Illinois; Loyola University.
Class treasurer '36; Bur Staff '36, '37, '38, '39; Dentos, Co-Editor '39; Junior-Senior Prom Committee; Student Instructor of Ceramics; Alpha Sigma Nu; Intramural Athletics.



KENNETH G. JOHNSON

Rock Island, Illinois; Augustana College.
Dentos Staff '32.



JOHN J. JUREWICZ, B. S.

Paterson, New Jersey; Catholic University.
Xi Psi Phi; Intramural Athletics.



WILLIAM J. KAISER

Chicago, Illinois, Loyola University.



GEORGE K. KELLY

Chicago, Illinois; Crane Junior College.
Class president '39; Class treasurer '37; Class
secretary '30; Loyola News '38; Delta Sigma
Delta; Intramural Athletics.



ALBERT M. KIRCH

St. Paul, Minnesota; St. Thomas Military Acad-
emy; University of Minnesota.



DAVID J. KLAPMAN

Chicago, Illinois; Peoples Junior College.
Alpha Omega; Intramural Athletics.



EDWARD F. KOSIOR, B.S.

Whiting, Indiana; University of Illinois.



EDWARD J. KOZAK

Chicago, Illinois; Morton Junior College; Lewis
Institute.
Delta Sigma Delta.

STANLEY B. KRISS

Chicago, Illinois; Crane Junior College.
Delta Sigma Delta.

WILLIAM H. KURTZ

Chicago, Illinois; Loyola University.
Class treasurer '38; Alpha Omega; Intramural Athletics.

M. M. LAND

Utrecht, Holland; State University, Utrecht,
Holland.
Delta Sigma Delta.

WILLIAM C. LIMACHER

Joliet, Illinois; Joliet Junior College.
Dentos Staff '36, '38; Junior-Senior Prom Committee,
chairman; Delta Sigma Delta; Varsity Golf '37, '38,
'39; Blue Key; Intramural Athletics.

HAROLD J. LINK

Chicago, Illinois; Loyola University.
Intramural Athletics.

RAYMOND E. LIPSEY

Chicago, Illinois; Crane College.

JOSEPH M. MAGGIO

Chicago, Illinois; Lewis Institute.
Class sergeant-at-arms '36; Intramural Athletics.

JOHN F. MCCARTHY

Chicago, Illinois; Loyola University.



80925

E. M. COUNTY MEMORIAL LIBRARY
LOYOLA UNIVERSITY

VICTOR J. McKEE

Salina, Kansas; Wesleyan University; Loyola University.

Class president—'36; Loyola News; Junior-Senior Prom Committee; Delta Sigma Delta; Blue Key.

EDWARD W. MIKULA, JR.

Chicago, Illinois; Loyola University.
Dentos, Cartoonist '39; Delta Sigma Delta; Intramural Athletics.

NORMAN L. MOSES

Chicago, Illinois; Loyola University.
Class vice-president '36; Junior-Senior Prom Committee; Alpha Omega; Intramural Athletics.

PAUL MULLER, D.M.D.

Davos, Switzerland; University of Zurich, Basel and Fribourg.
Delta Sigma Delta.

FRANK A. MURIN

Chicago, Illinois; Loyola University; Central Y. M. C. A. College; St. Mary's University.
Loyola Union.

ALFONSO W. NICASTRO

Montgomery, West Virginia; New River State College; West Virginia University.
Delta Sigma Delta.

FELICE J. PAONE

Chicago, Illinois; Loyola University.
Class secretary '36; Class vice-president '37; Dentos Art Staff '36, '37, '39; Delta Sigma Delta; Student Roentgenologist.

LUCAS C. POLITIS

Chicago, Illinois; Loyola University.
Delta Sigma Delta.





DAVID J. RAYNES
Chicago, Illinois; Crane College; Lewis Institute.
Loyola News; Alpha Omega; Intramural Athletics.

HARVEY C. ROBB
Regina, Saskatchewan Canada; University of
Saskatchewan.

ROBERT J. ROCK
Chicago, Illinois; Loyola University; De Paul
University.
Delta Sigma Delta; Intramural Athletics.

JEROME B. ROSENBLUM
Chicago, Illinois; North Park Junior College.
Intramural Athletics.

JOSEPH J. ROSSA
Chicago, Illinois; Loyola University.
Class secretary '38; Pi Delta Sigma; Intramural
Athletics.

FREDERICK W. SALISBURY, B.A.
Elgin, Illinois; University of Illinois.
Class president, '36; Class sergeant-at-Arms, '38;
Delta Sigma Delta; Intramural Athletics.

CLARON C. SCHAFER
Vermillion, Kansas; Loyola University.

LAWRENCE SCHEFF
Fort Wayne, Indiana; Loyola University.
Dentos, Co-Editor '39; Loyola News; Inter-Fra-
ternity Council '37, '38; Alpha Omega; Intramural
Athletics.



EDWARD M. SCOTT

Los Angeles, California; University of California at Los Angeles.
Delta Sigma Delta.



EDWIN H. SCHULTZ

Lomira, Wisconsin; Ripon College, Valparaiso University; Lewis Institute.
Delta Sigma Delta.



MAX SHAPIRO

Chicago, Illinois, Loyola University.
Class vice-president '38; Dentos, Co-Business Manager '39; Loyola News; Alpha Omega; Intramural Athletic Director '38, '39; Varsity Swimming '36, '37, '38, '39; Monogram Club.



LEONARD T. SHIMANDLE

Riverside, Illinois; Loyola University.



JOHN M. SINGLER

South Bend, Indiana; University of Notre Dame; University of Michigan.
Class president '38, Burr Staff '34, '35; Delta Sigma Delta.



GLENN V. SMEBY

Oberon, North Dakota; University of North Dakota.
Class secretary '39; Delta Sigma Delta.

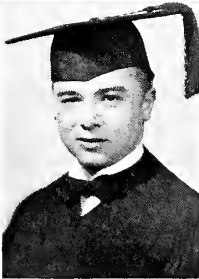

BRUCE A. SPOONER

Chicago, Illinois; Chicago Christian College.
Dentos Staff '36, '39; Delta Sigma Delta; Intramural Athletics.



CARMAN H. SUTLEY, B.A.

Fort Pierre, South Dakota; Yankton College.
Class vice-president '37; Xi Psi Phi.

MARVIN TOPPER

Chicago, Illinois; Loyola University.
Intramural Athletics.

IZAAK VERHOEVEN

Rotterdam, Holland; Stote University, Utrecht,
Holland.
Delta Sigma Delta.

ADALBERT L. VLAZNY

Chicago, Illinois; Loyola University.
Intramural Athletics.

WILLIAM R. WALTERS

Chicago, Illinois; Loyola University.
Intramural Athletics.

DAVID H. WEINSTEIN

Hartford, Connecticut; American International
College; Connecticut State College; Loyola
University.
Alpha Omega.

DORUS L. WINQUIST

Vermillion, Kansas; Loyola University; North-
western University.
Psi Omega.

TAKEO K. YOSHINA

Laupahoehoe, Hawaii; Loyola University.
Dentos Photography Editor '39; Delta Sigma Delta.

LOUIS R. ZANILLO

Chicago, Illinois; Loyola University.
Intramural Athletics.



SENIOR SKETCHES

"One-Beer" Adams—the politician. Golfing and other things went to his head at the Junior Outing. Most attentive during operative lectures.

"Bubbles" Ahnger—graceful as a ballet dancer. His presence on the swimming team was good for a foot more of water in any tank.

"Bill" Allen—the only man known to find carries on the palate. Was late joining the Ranch Boys, but caught up.

"Si" Appell — graduate of the Riding Academy. He claimed the cavemen had the right idea—and proved it.

"Two-ton" Apple—one of the boys from the old school. Believed in making auxiliary dentures—seven for one patient.

"Joe" Arnold—one of our married men. Constructs bridges for interproximal spaces.

"Happy" Babcock smiled once and dislocated his jaw. Was a good boy until he started to keep company with Jenkins.

"Cass" Bassak frictionizes with Lipsey. Even a blizzard couldn't keep him away from exams. Believes in getting things done.

"Len" Becker says its dangerous to live at the Crest. Anything might happen to you there.

"Buck" Binotti—his biggest mistake was selecting a seat in front of Robb, Jerbi, and Yoshina. One of our notorious hand-shakers.

"Gene" Blatter could serve as a good double for one of our great churchmen. Can certainly wheel that big Buick around.

"Billie" Burke—no relation to Ziegfield's wife, but rivals Ziggy at picking them. Played a lot of basketball for the Delts.

"Buttles" Butler—an ardent student of the axilla. Not enough variety at Eureka for his social aspirations. Likes bridge department.

"Mitts" Cibulka spends a lot of time drinking coffee. Thinks the fauces ore a couple of beer taps. Prefers denture work.

"John" Davidson—rather a reserved chap. Always spent his lunch hour arguing with Gorsky.

"T. G." DeWitt—Gunner supreme! Juniors always thought he was playing tag with the instructors. Has a good sense of humor.

"Ruby" Dobry—the big boy from Wisconsin. Something in Kenosha made him buy a pass on the North Shore. Likes to bowl.

"Eppy" "Esquire" Epstein—Dr. Fouser's chief rival. Hasn't worn the same suit twice in four years.

"Luke" Fein—the Rosco Ates of the dental school. Took him two hours and forty minutes to say polymorphonuclear leucocyte.

"Howie" Fisher, the red faced boy from Berwin whose Ford was a parking lot feature. Received a big scare during chemistry.

"Joe E." Gault expects to conduct spring and fall sales of dentures. Will have the largest and most elaborate neon in Chicago.

"Gus" Giraldi. Mussolini is still looking for this fugitive from the barbers. Hasn't proved that he doesn't come from Sicily.

"Hank" Gold—God's gift to the nurses says, "My main trouble is that they always fall in love with me."



"Larry" Golden believes in extracting the right tooth and only that tooth. Tried to get in every picture for the Dentos.

"Bob" Gordon—the Avon Kid. Packs a lot of dentures for his daddy. Sold us our crown and bridge text book.

"Sid" Goren—formed the third member of the Gorsky-Davidson lunchtime Forensic League.

"Bennie" Gorsky—a very generous fellow. Ardent believer in the axiom, "It is better to give than to receive."

"Tom" Grisamore gave a year's course in diagnosis in an hour's lecture. At least his prescription's didn't do us serious harm.

"Steve" Hajduk. His use of words, over two syllables, was something. Just didn't feel like coming to school after the sophomore dance.

"Texas" Hale still holds it against the boys for never fixing him up. To him Texas is the heart of the Union.

"Maacher" Jenkins likes O. P. Cigarettes. Took a blind date to the Prom and went home the same way. Prefers fail.

"Jerbo" Jerbi—the song bird from the Garden Spot of America. Famed for his rendition of "Pennies from Heaven" at the sophomore dance.

"Ken" Johnson is from out Moline way. Just a son of Ol' Man River. Trades a bottle of Calor-Bak for Hair-bak.

"Eral" Flynn Jurewicz, the Casanova of the Crest, is overjoyed when his motion picture double appears on the screen. Spends hours in front of a mirror afterwards.

"Kay" Kaiser—the speed merchant. Gets around like a snail on crutches. Procrastinator supreme. Takes pride in his upper lip.

"Red" Kelly looked too much like our assistant dean for comfort. Raced Ewart up the stairs before every eight o'clock class.

"Al" Kirch is president of the Pappy Club. Thinks a lot of army life. Going back to the Gopher State.



"Gano" Klapman, alias Sleeping Beauty, alias Sir Galahad, says water is poison. Is cursed with Roman Hands.

"Ed" Kasior—the man of the upsweep hat-brim. Thinks the styloid is a fashion magazine. Prefers blondes.

"Clark" Kozak is the pride of Wolf Road. His anatomical drawings are in demand. Petty looks to him as a successor.

"Stan" Kriss was the noisiest fellow in class. Duggan led him astray. Worrying about little things ended in loss of weight.

"Bill" Kurtz is saving 200 "harps" for a wedding license. He is a "dead pidgeon."

"Johnny" Land, an all around good fellow from the land of wooden shoes. Spends his evenings playing bridge at the Y. M. C. A.

"George" Limacher put a water filled balloon in Dr. Vlk's pocket (so Dr. Vlk said) but still denies it. Goes around school like a floor-walker.

"Hep" Link—impersonator of instructors. With white hair and a long laboratory coat the effect would have been fool proof.

"Colonel" Lipsey believes in making the patient fit the restoration. Assumed role of first assistant to seniors on Thursdays. Goes for foils.

"Joe" Maggio—the only C. C. D. S. undergraduate ever to become a member of the Shirley Temple Club. Noted for his dramatic apologies.

"Charlie" McCarthy will be the up-to-date practitioner if pneumatic mallets and rubber operating aprons are indications. Most nonchalant.

"Curley" McKee hangs around anything nice. Has given everything a try except toupe and hair transplantations. Likes jockets.

"Scratch" Mikula—the class cartoonist. His masterpiece, depicting the direct and indirect methods of investing, should be in every dentist's office.

"Norm" Moses—quite a coincidence, but every night he worked we froze the following day.

"Putzi" Muller—an amiable Swiss lad. Has made a name for himself in international hockey. Warns Hitler to keep out of the Alps.

"Frankie" Murin could smile in the face of a soft foil. Liked to sit on the bench. Bets on anything.

"Ferdinand" Nicastro—the worst rider in the class. Can't stay on a car, motorcycle, horse, or even a hayrack.

"Pup" Paone—radiologist, artist, and pencil pointer. Invaluable source of information for any lecturer.

"Luke" Politis—one fellow that does have trouble with hair getting in his eyes. First on the floor to make gastric inlays.

"Rhino" Roynes—the "anse", Staunch advocate of the broach retriever. Believes the scope of its application is boundless. Has the most dignified sneeze.

"Bronco" Robb. Canadian life may be different from that on the Boulevard, but he showed the boys a few tricks. Likes the Dean's lectures.



"Cowboy" Rock developed an apparatus known as a "Duplicator", which simplifies denture rebasing. Likes Dr. Vik's horses.

"Jerry" Rosenblum had a hard time keeping the boys away from his locker album of glamour girls. Played center for the Burs.

"Henry" Rossa spent half the night getting home from school and the other half trying to make an eight o'clock class.

"Sorg" Salisbury liked walking back so much he joined the cavalry. We'd like a picture of him in riding boots and spurs.

"Turkey" Schafer—the Kansas Casonovo put the Ranch on a paying basis. Kept a good line of fillies going for the boys.

"Larry" Scheff—another alumnus of the Riding Academy or the hotel that is a home (for whom?) is the only man in school who puts in temporary stopping with an angulated plugger.

"Gas" Schultz intends to enlist in the army chemical corps. With his natural ability he could be a whole unit. Likes orthodontia.

"Ed" Scott—most reserved fellow in class, but with plenty on the ball. Forsook the mountains of California for the canyons of Chicago.

"Max" Shapiro, the man with the unprintable nicknames, is racing Kurtz to the altar. Was a varsity swimmer for 4 years.

"Lenny" Shimandle went in for making expensive partials. His league of nations "feed" left the members beltless. Likes long pipes.

"Pappy" Singler—home address is corner of Van Buren and Wood. Likes Notre Dame, oral surgery, and a good dish of spaghetti:

"Whitey" Smeby—a three year man with a four year man's points. Going to keep the Minnesota cows in good cud chewers.

"Short-pants" Spooner. "Caries on the distal, Mr. Spooner." Had an uncanny knack of getting Jenkins up in the air—especially during class.

"Jughead" Sutley—best juggler of a partial denture that we have known. The girls from "Pres" come through with his foil points.

"Marv" Topper always uses a 24 pound test line when he goes fishing. Pity the poor fish.

"Big Stoop" Verhoeven certainly showed the lads that foreign boys have plenty of speed when it comes to dentistry and social contacts.

"Emily" Vlazny has made his mark in the literary world. Any man that can get us to wear ties must be good.

"Bill" Walters could always be found on the children's clinic side of the infirmary. Drove a Ford. Likes operative.

"Dave" Weinstein uses Lovorin, Listerine, soap and Lysol as mouth washes—kissing is dangerous.

"Windy" Winquist had the best line in school. Should write a book on solesmanship. Perfected the Vossburg root canal technique.

"Murphy" Yoshino—sometimes called "Flash-light". Was accused of photographing the bosemont munitions plant. One M.O.D. inlay, six recasts, eight points.

"Lou" Zanello—the quietest fellow in school: so much so that Ewart never knew he was in class.

CLASS WILL

We, the graduating class of 1939, of the Chicago College of Dental Surgery, being still of sound mind and body after four years in this institution, do hereby declare and promulgate this, our last will and testament. We do hereby bequeath:

To Dean Logan: A potent on his "Buck Rogers" head lamp.

To Dr. Puterbaugh: A rocking chair and a box of cigars, to be installed in the small amphitheatre.

To Dr. McNulty: An automatic mallet, made over into a machine gun, to shoot down dumb freshmen.

To Dr. Glupker: All our flasks, nuts, and bolts for a picture of himself in a bathing suit.

To Dr. MacBoyle: A gold-plated pair of Goslee pliers and a Little Giant post-puller.

To Dr. Willman: A phonograph record which keeps repeating—Um-hum, um-hmmm-----.

To Dr. Pike: A class that can solder Richmond Crowns—the first time.

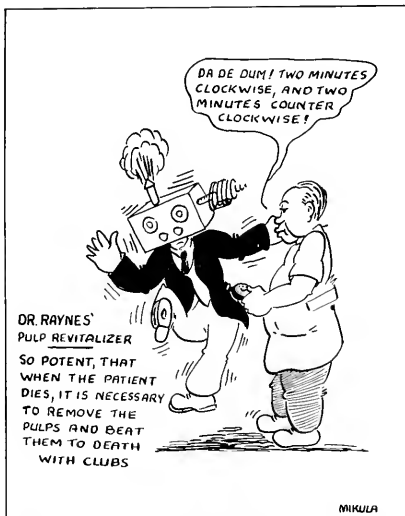

To Dr. Zoethout: Two trained frogs to pith the brains of sophomores who don't quite get the right idea.

To Dr. Pendleton: One bottle of Vitalis and a phonograph record of the song "My Buddy".

To Dr. Coolidge: A corkscrew for torturous root canals.

To Dr. Kanner: An electric razor.

To Dr. Fouser: A subscription to Vogue.

To Mr. Warner: A big red pencil.

To Dr. Hyde: A bottle of stain remover for upper third molars.

To Dr. Kendall: A 400 foot Eucalyptus tree for his front lawn.

To Dr. Dawson: One diamond pointed Crenshaw scaler for testing foils.

To Dr. Kronfeld: Half interest in the bottle of Vitalis we are leaving Dr. Pendleton.

To Dr. R. H. Johnson: One volume of "1001 New Jokes."

To Dr. Boulger: A rubber tipped explorer for testing prophylaxes.

To Dr. Lindner: A job as deputy bridge inspector of Chicago.

To Dr. Mueller—A handbook of foreign languages.

To Dr. Grisamore: An orthodontia patient with ten lower anterior teeth and four deciduous bicuspids.

To Dr. Vlk: A cowboy suit, a season pass to the Merry-Go-Round at Riverview and a shovel.

To Dr. Meyer: A ticket to the motion picture "Four Girls in White".

To Dr. Kirby: The unused set of "Black's Index to Dental Periodical Literature," in the library.

To Dr. Holmes: A flower pot of gladiolas.

To Dr. Rzeszotarski: One nursing bottle and a pacifier.

To Dr. Michener: A Bottle of plaster glue to be used for the sophomore technic course.

To Dr. Svoboda: A fishing hook for retrieving roots which students push into the maxillary sinus.

To Dr. Larsen: An automatic bite-opener.

To Dr. Richey: A normal bite denture case.

To Dr. Boris: One copy of "How to Win Friends and Influence People"

To Dr. Atkinson: A simplified index system for radiographs.

To Ewart: A watch that always remains fifteen minutes slow.

To Dudley: (The human microtome): A magnifying glass to be served with each sandwich.

Lipsey: "I haven't come to any ham in this sandwich yet."

Mr. Dudley: "Try another bite."

Lipsey: (taking huge mouthful)—"Nope, none yet."

Mr. Dudley: "Dog-gone it! You must have gone right past it."







T H E J U N I O R

From the first bar of music on the evening of Friday, February seventeenth, to the last bar on Rush Street during the following morning it was a big occasion. The "stiff-fronts" started out as such and ended much more so; and the corsages, every one of them, remained pleasantly fresh.

It all happened when the Juniors played hosts to the Seniors at the annual Junior-Senior Prom in the Crystal Ball Room of the Edgewater Beach Hotel. The setting was a fitting one for the affair when this dignified and famous hotel so willingly masqueraded as the home of merriment.

One hundred twenty couples and Ernie Draper passed beneath the impressive entrance, wormed their way through a shining and colorful display of new gas-buggies, and found themselves on a perfect floor for dancing. On the stage Roman George's orchestra did itself proud in providing the music throughout the evening. The musicians were conducted by none other than Roman Ziolkowski of our own junior class.

The grand march was the highlight of the evening for those who were physically able to take part in it. Led by the officers of the junior and senior classes the dancers presented a display of near perfect formation that rivaled

the efforts of any of the good drill teams. This lasted but a few minutes until the photographers began their work and pandemonium broke loose as everyone jockeyed for a good position before the camera.

At first glance one would think that the Juniors were presenting a style show for men. Gault waltzed in with white tie, tails, and "stove-pipe" hat. Gibson said that Bolbat was to carry a gold-headed walking stick which would have been a big help to some fellows. Fein had a hat that popped out from a pancake position. Scarcely recognizable was Wilber Gordon without clashing colors or plaids. Everyone thought that McKee would come attired in his familiar blue shirt, red tie, brown jacket, and grey trousers, but he wore a neat looking outfit with a neat looking number on his arm.

Some side-line glances of the dance may bring back memories. George Madden was there, then he was gone, and then he appeared again but his spirit was dampened . . . Limacher was the most disappointed person at the Prom when with all his hair pulling he could not find a single toupee—not even on Raynes, Gast, or Haas . . . Gold presented an interesting subject and we do mean interesting . . . "Pretty Boy" did some mean back scratching



SENIOR PROM

Jenkins tried hard to find a corsage . . . Adams didn't know he was like that when a Photograph was taken of the grand march . . . In the wee hours an absent instructor just missed answering a phone call that "Hep" Link was anxious to put through . . . Sothras could be found at the bar . . . one Junior became so self-centered his eyes were kept busy looking at each other . . . Shapiro trimmed his mustache especially for the occasion . . . Dedekind was all puffed up about the whole thing . . . The Seniors attending the Prom with expectations of receiving a souvenir to present to their companions of the evening did not leave empty handed.

The evening entertainment did not end when the site of the Prom was left behind. Both the junior and senior classes were well represented in a number of the favorite bright spots until the early part of the morning. Many a mother's daughter, attired in a glittering formal and with metallic shaded dancing shoes in her hands, carried the morning papers and coffee cream in to daddy.

After such a prolonged and strenuous period of activity it was surprising how many appointments were kept at the clinic on the following day. The majority of the Juniors were even able to attend the early morning lecture. Yet, let it be known that Jerbi was late for an

eleven-thirty appointment and Dudley thought he was having his lunch when in reality it was his breakfast.

The faculty was represented by Drs. Pike, Svoboda, Rzeszotarski, and Lorsen. They acted as chaperones and their presence was more or less instrumental in maintaining the milder form of disorder that prevailed throughout the night. The sincere interest these men took in the prom was deeply appreciated.

The committee in charge of the Prom deserved hearty congratulations for having presented such a memorable farewell for the seniors. The members of the group were:

Co-Chairmen

Roman Ziolkowski
Nicholas Sothras

Ballroom and Orchestra

Kenneth Dedekind
Richard Burke

Finances

Elmer Kouba
Joseph Pearlman

These men promoted an affair that was a financial success as well as a criterion for future proms.

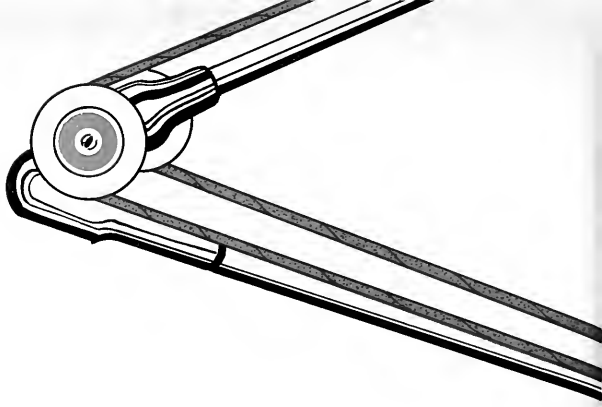

The zealous student will be rewarded. Continuous growth, devotion to your work and reliability measure your progress and bespeak your future success much more than high grades on examination day.

J. L. Kendall

UNDERCLASSMEN

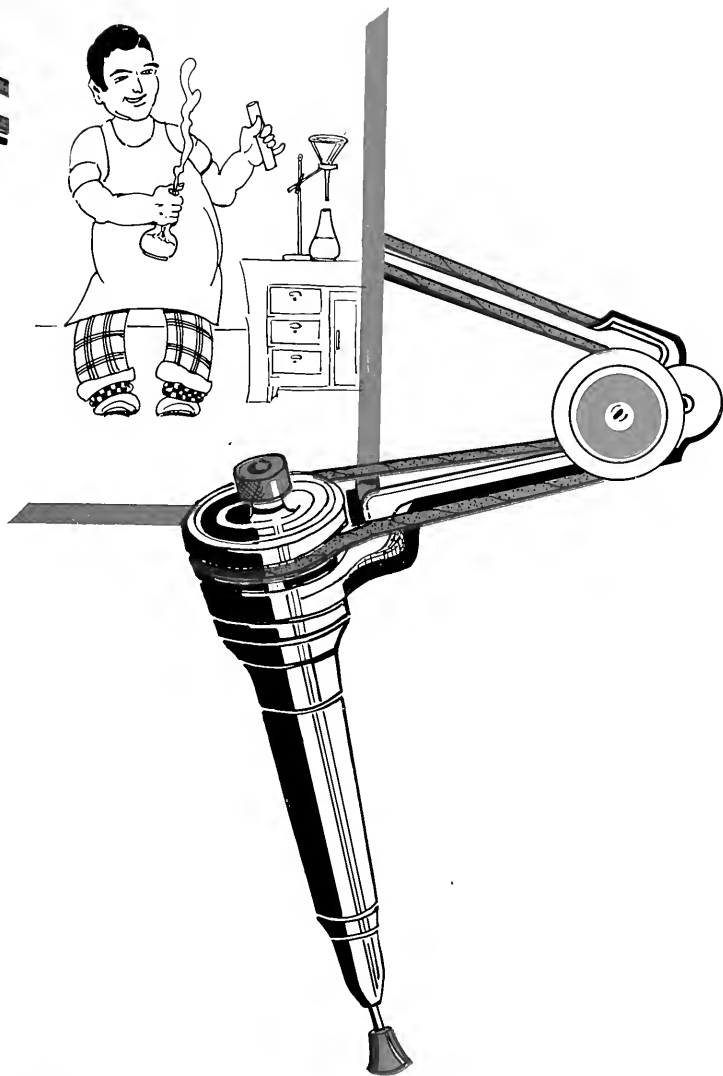

The JUNIOR Class

HAAS
DEDEKIND
ZIOLKOWSKI

HOFMAN
ZULLO
GRIFFO

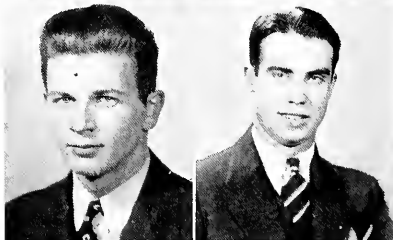
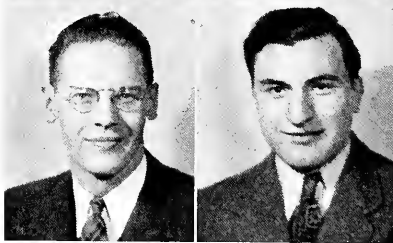
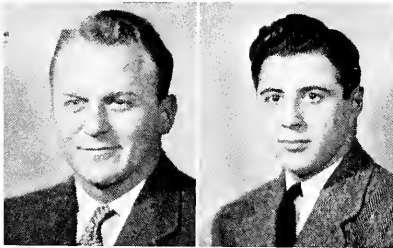

"The Baron" says, "Romance went out of my life when Wanda left". Oh, well, we can't have everything.

Ed Belofsky thinks curly hair gets the women. Deep down in his heart though, he wishes it would keep from getting caught in the engine belt.

"Bender" knows Standard Laboratory can't be beaten. Doctor Vlk will back him up but isn't quite so enthusiastic.

Steve Bobalek dominates the girls he brings to our "shindigs". Try and talk to any one of 'em and see where it gets you.

A true patriot is Wally Bolbat. Paid for his Prom bid but didn't use it. Where'd it go to, Wally?

"Love is a very wonderful thing". "Don Juan" Bro ought to know—he's got that dying calf look.

We just had to put in the full name of Thaddeus E. Brzdenkiewicz. (You should've heard the printer cuss).

"Jockey" Joe thinks nothing can beat a certain blonde filly.

Dick Burke is about ready to have a certain Greek deported, unless the aforesaid Greek changes his Greekish ways.

"Heh Ah is" won't give us any more free ones. "Take your trade elsewhere", say we.

Ask the "Mudcat" how he got that new scar on his visage. He'll tell a different story every time.

"Milk makes teeth sparkle". After all, Chmiel sells the stuff so what can you expect.

"God's gift to Wisconsin" has Doctor Oppice



thinking his last name is Paul. Just an old smoothie from the farm.

They grow 'em pretty out in Oak Park. Curtin is biased about the whole thing, so don't believe a word he says.

The proudest man at the Prom was Dedekind even his cheek puffed out especially for the occasion.

"Tight-wad" Duggan still won't bring in any samples from the place he works. Nuts to you, Ed, we'll make our own.

"It's the real thing this time," says the Weasel. The only trouble is, he's got a new one every other week.

Fireman and Fishman were both kicked by the same horse twenty years ago and haven't come out of it yet.

L. V. F., Jr., argues that Northwestern Sorority houses are nice places to spend the long winter evenings.

Francis and the other two Musketeers were quite the thing at the Prom. Only the brave deserve the fair—or do they?

"My, deah, you really should move up on the drive. It's so swanky, don'tcha know", avers Gast, the Porter County Flash.

"Mike de Pike" says he'll give \$10.00 to anyone proving he hasn't worn shoes at least twenty-five years.

Ever since Dr. Kronfeld noticed Gewartowski's missing laterals, this student thinks he's a celebrity—or something.

Joe and Ken both threaten mayhem to the next person who pulls off that "Are you brothers?" business.

"Kelly" just won't stand for insults on the honor of the South, suh.

"By" Goldstein doesn't know about drawing upper molars, but when it comes to "doodling" during lectures, he'll beat Dr. MacBoyle any day.

Joe Gomborg won't admit it, but he's got a "past" just the same.

Goodman's only reason for living is to get even with Strom and Vinikour.

"Flash" says he's trying to reduce, hence the overcoat-suit he's been wearing all winter.

"Hotfoot" Griffo better watch his step from now on—inlay magnets just aint.

"Pretty Boy" and Gwen sure made a nice couple at the Prom. Back scratching is the latest thing, or didn't you know.

"The Claw" lays claim to being Orthodontist-in-Chief of the Class of '40. (Throw the big bum out).

Herthneck's wife hollers, "No more ties for Christmas—Bob gets Vitalis from now on."

Did you see Les in "tails"? Just an old Society Hound from 'way back.

Holmes says, "If massage don't bring it back, nothing will". Keep on trying, Harry.

Wonder what "Pop" Hull does with all his money? Spill it, Fred.

Lenny helps "Jockey Joe" "improve the breed". We haven't seen any bank rolls flashed around yet, though.

Joe Josh is generally acknowledged as the champ when it comes to St. Apollonia and stuff. Doctor McNulty thinks he's "aces", too, don't you, Doctor?

"It's got me beat", says King. "They never fit at the gingival".

Knicks wonders who invented eight o'clock classes. Go easy, Ash, they still hang for murder here in Illinois.

"There's no place like home", drowsily mumbles Elmer, "Especially the morning after."

Kowalski thinks foil should be used for optional points. Why not throw some our way Jahn?

"Little Caesar" Kryda will tell you muscles come from doing hard work. After working everybody in the basement for a smoke, he ought to know.

"Hit 'em with a wood, he can't flew," is Krzyzowski's slogan.

Treat Ed Kula nice, boys. His Uncle was elected Judge last November. (Being a Democrat helps).

LaMothe says, "Give 'em some time, France always pays her debts". When will it be through, Pierre?

Wonder who Glenn Landstrom would heckle if Bro walked out on him?

Link has the championship for being on time at eight o'clock classes. Oh, yeah? Ask Ewart.

For a change, the large ice-box was warm for eight o'clock class. Reason? Madden wasn't on duty the night before.

"Heinie" still thinks it's easier to extract 'em than it is to fix 'em up.

Mac would rather be a jitter-bug than a dentist any day. He claims you just can't get rhythm with a foil plugger.

See Melze if you want a piece of plaster shined up. He's got a "secrut" formula, or something.

The "Quiet Man from Crystal Lake" doesn't talk much, but have you seen those points roll out?

Nick attributes his success to the white enameled trimmings on his operative case.

Passarelli thinks nothing can beat his job at the mortuary. You don't get a leg talked off, anyhow.

Joe Pearlman has an artist's temperament all right. He won't work unless inspiration comes at the right time. (See Joe if you want to know what's "inspiring").

"White hats are in style on election day, anyhow," says Alderman Perlman.

Pogirski has all his patients believing that gold foil is the only filling they'll let you put in at C.C.D.S. Watch out for the instructors, Henry.

Charley Pomernacki tells his wife he's a Judge 'cause he's been on the bench now for almost half a year.

Quinn thinks nine o'clock's early enough for any class. Better slip Ewart some of the green stuff, Ernie.

Rajca wants to trade bridges for dentures. Better hold on to 'em, Henry, the diplomas won't be out 'til 1940.

Riley, the Scourge the Second Floor, has a couple of trick centrals through which water flows with the greatest of ease. A word to the wise—.

Rosey went Democratic for the primaries, but for another \$5.00 will be a Republican in April. How do you expect to be President thataway?

"The Head" wants to make sure Vitalis does something for Herthneck and Holmes before he puts out any shekels.

"Butts" quit smoking cigars ever since Dr. Johnson's course made him tooth conscious. Remember that smile, boys?

Simon says, "Sleep sure soothes students' souls". How do you keep from falling out of your seat though, Nick?

If worse comes to worse, Sitar can always get into the "pen" at Joliet. Can you get out just as easily, Karl?

The eldest of the Smith Brothers knows the younger one hasn't got a chance. After all, Frank's our No 1 apple-polisher.

For over fifty years they've been throwing it around down in the basement. From the looks of things though, our Greek is the undefeated champ.

Joe Stewart gets the prize for having the biggest collection of borrowed pens, pencils, and brass checks.

Moe Strom is an artist of no mean ability. He and Vainikour go to the Rialto to develop their aesthetic sense.

Hans Sussman knows more about English than we do. Just try and stump him on grammar. For lessons in chalk-talking see Charley Thiel, our ace screwball.

The champion of the chain stores is our boy, Bernie. He's for the drug racket 100%. Says which?

Van thinks the College ought to have some coeds. This way, it'd be official and on the up-and-up.

For any more "info" on Ben, see Strom and Goodman.

Little Joe has his hunting grounds down at Billings. The only trouble is, they see him first, so he's still hunting.

Al Wadas bids fair to out-Gosley our doctor Gosley if he keeps turning out bridges by the bucketful.

Prom Promoter Extraordinary is "Rome". If Dentistry doesn't treat him nice, he claims there's always Hollywood.

"Slug" Zullo has an idea he's a "copper" ever since being appointed on the Anti-Thieving Committee. Did you see "Cam" make him behave at the Prom, though?



Baranowski
Buda
Dedekind
Gast
Gomberg
Hofman

Belofsky
Burke
Duggan
Gaudio
Goodman
Holmes

Bendersky
Casciato
Ferington
Gewartowski
Gordon
Hull

Bobalek
Cathcart
Fireman
J. Gibson
Griffo
Jaracz

Bolbat
Chmiel
Fishman
K. Gibson
Haas
Josh

Bro
Cobb
Foley
Goldberg
Henkin
King

Brzdenkiewicz
Curtin
Francis
Goldstein
Herhneck



Knickels
Landstrom
Nikiforuk
Rajca
Smith
VanKley

Kouba
Link
Pasarelli
Riley
Sothras
Vinikour

Kowalski
Madden
Pearlman
Razanski
Stewart
Vocat

Kryda
Mathfs
Perlman
Shallman
Strom
Wadas

Krzyzowski
McIntyre
Pagirski
Shechtman
Sussman
Zialkowski

Kula
Melze
Pomernacki
Simon
Thiel
Zullo

LaMothe
Newman
Quinn
Sitar
Thomas

"JUNIORS"



JUST ONE 'BUD' - AFTER ANOTHER



"THE HEIGHT OF ANTICIPATION"

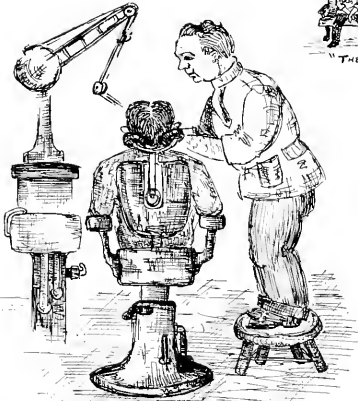

CLINICAL ACCESSORIES
(FOR FELLOWS LIKE VOGAT)

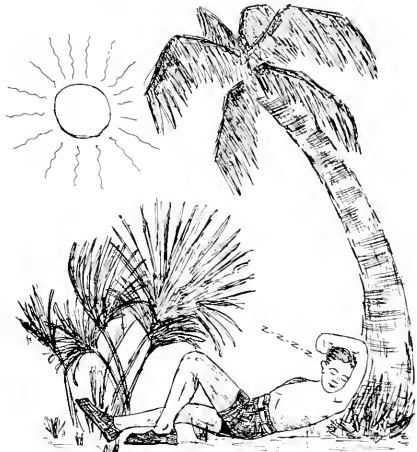

"FOLEY THE FLORIDIAN"

Howe
2/6/21

The SOPHOMORE Class

HOCKING
HATTENDORF
GARGIULO

BROWN
BARTKOWIAK
NEWELL

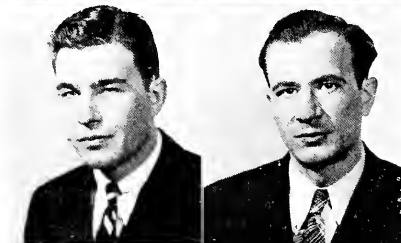
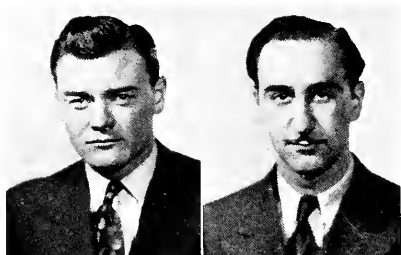

Our class entered the Chicago College of Dental Surgery in October 1937 under the brilliant guidance of the well loved and distinguished scholar, Dr. C. N. Johnson. With a few well chosen words of wisdom and understanding, Dr. Johnson oriented the thoughts of the bewildered neophytes. Our class now bears the proud heritage and distinction of having been the last class to be so honored upon entering the Chicago College of Dental Surgery. With pride and reverence, we recall our Dr. Johnson as a true gentleman and a great scholar.

Our freshman year unfurled the wide field of dentistry before us and under the splendid leadership of Drs. Kendall, McNulty, Fouser, Glupker, Kanner, and Holmes, we were skillfully guided to a clear and basic understanding of our future careers.

We can never forget those long hours in the anatomy laboratory with all the "other students" strolling along the walks, with the gentle touch of spring in the air, with long golden beams of sunshine streaming through the windows and you with the head and neck dissection to be learned for tomorrow's practical examination.

How many hours we spent carefully carving those precious wax models, with Roach or Swainson carver, or better with your faithful penknife, always, to be disconcerted by that devastating Boley gauge checking and re-checking those few spare millimeters.

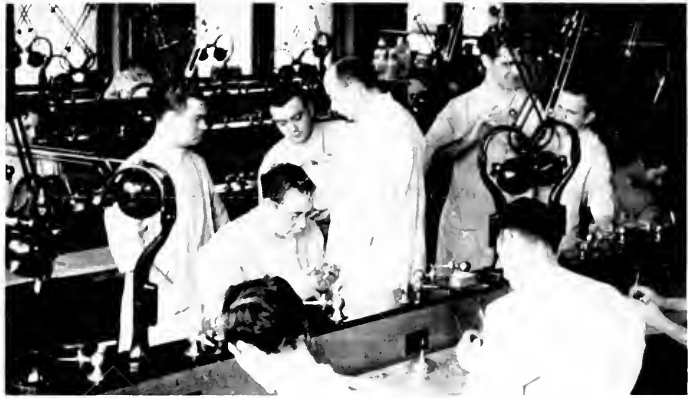

Try to rotate the cuspid to the mesial, draw to the distal; elevate the buccal cusps on that lower molar; line and reline the posteriors along the arch of ridge; wax and rewax; polish and festoon; these were but a few of our tribulations in full denture construction.

Organic chemistry, histology, dental histology, physiological chemistry, and physics were some of the strange lands we traveled but with our knowledge of them always increasing, and ever more filled with interest, we turned toward the second lap of our goal.

A great deal of water has since swiftly traveled beneath the bridge and those difficult fundamentals no longer frighten us. No longer are we all thumbs and already many of our class have secretly chosen a special field for their future careers.

In our sophomore year with Dr. Kendall, whose popularity and great teaching ability is ever increasing, we separated those fine threads of knowledge from that mixed bedlam of substances in *Materia Medica*. Those intricate concoctions were carefully interpreted and various drugs and their uses became our common knowledge. Thus prepared we approach our future course in therapeutics.

Bacteriology and pathology were very strange and difficult subjects to master. Slowly the underlying classifications became visible; with careful teaching we began to understand that varied mass of tissues which our slides presented. All this seemingly hopeless situa-

tion was dissolved by Dr. Kanner and Dr. Kronfeld with the priceless assistance of our good friend and confidant, Mr. Warner.

"Dr. Zoethouts' Physiology"—three little words, but what a difference they made to all of us. Here we met our Waterloo or Verdun depending upon which side we took part in. Here also we had to be ever alert to escape unscathed the withering and piquant sorocosm of that gentle little man. Those little quizzes would invariably catch us napping and play havoc with those overages. Now we more fully appreciate the careful reading and deeper insight of physiology, but ah that kymograph and frog which refused to produce that needed graph and response.

Our grand finale for the sophomore year was operative dentistry. Under the skillful guidance of Dr. Willman, we mastered the art of cavity preparation and filling; we more fully appreciated our crown and bridge course; and we had instilled into us a burning desire to do work and to do it well. We proudly recall those "W2's" which stamped us clearly as if the words, "good work, well done" were printed on them.

That bitter political feud which had its origin in our first freshman class election has been softened, not by the promise of future candidates to office, but by the added maturity of our two years in school. We now possess a closely integrated group which shows great promise in scholarship and extracurricular activities.

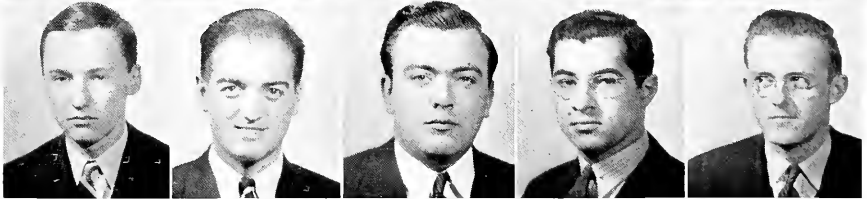
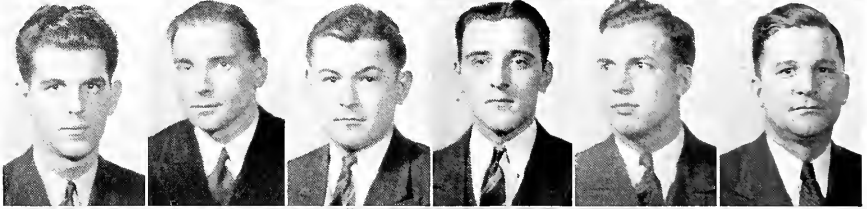
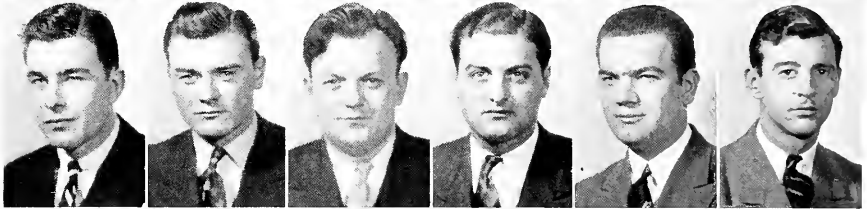
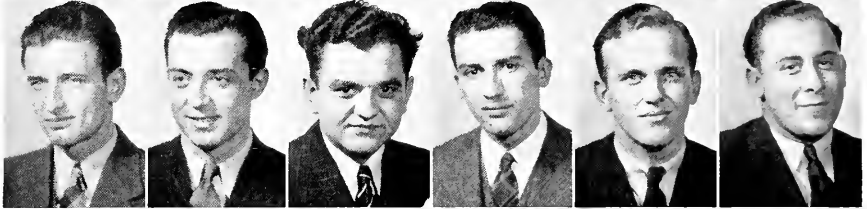
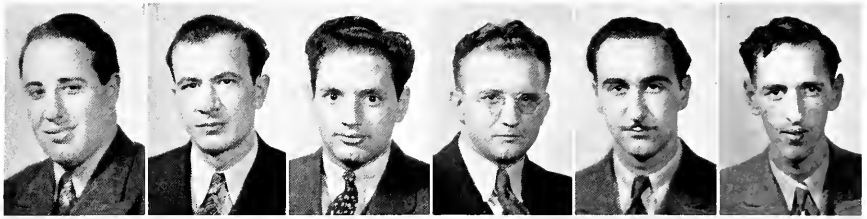

Amaturo
Filip
Hottendorf
Mistretta
Robb

Bartkowiak
Gargiulo
Hocking
Newell
Roira

Block
Gekas
Humphreys
Podrozo
Schell

Bronch
Gregoline
Impellitteri
Paronsky
Shrago

Brown
Gutowski
Kopczynski
Readel
Sorensen

Cowan
Harris
Luallen
Reihsen



The FRESHMAN Class

MOSS ANDERSON
 SAUER WEBBER
 SHOR MATOUSEK KALIN

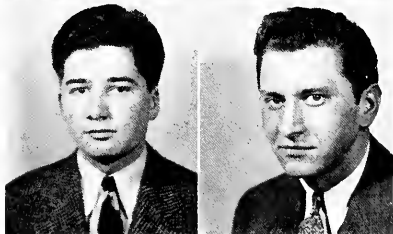
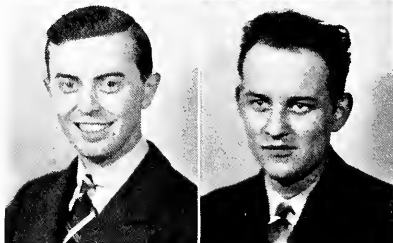
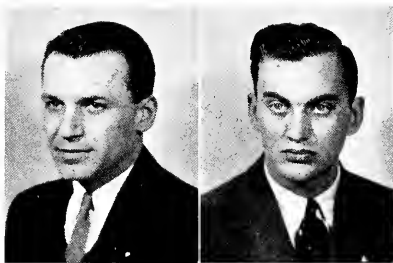

THE LIFE OF A FRESHMAN THROUGH THE EYES OF HIS CADAVER

John Q. Corpse (otherwise known as No. 2116, County Morgue) lay, still as death itself, on his slab in the dissecting laboratories of Loyola Medical school,—breathlessly awaiting the onslaught of the freshmen dental students.

John had been dead now for two months and he was getting just a wee bit restless. He really didn't look as handsome as was necessary for this auspicious occasion: i.e., the meeting of fifty-four prospective A-1 dentists. He was in dire need of: 1. a shave; 2. a pair of pants; 3. a dash of "Christmas Night". In all other respects, however, he was a veritable Tyrone Power.

The freshmen were late in arriving. They just couldn't get used to this "half hour for lunch" business. "Ah! Here they are," John said, half aloud, as he heard the approaching sounds of teeth chattering and knees knocking together. "They're scared stiff", he thought.



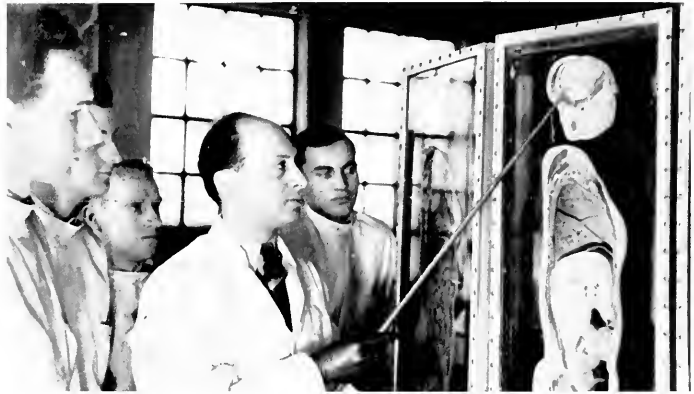

Finally, those dictators of dissectors, those masters of things macroscopic, Doctors Fouser and Leschin arrived upon the scene. The covers of the bins were promptly rolled up and at last John could see his future violators.

There they were, spic and span (or should it be "sick and wan") in their clean white, ill-fitting surgical gowns. "Oh, those gowns", thought John with a sardonic smile playing about his oral opening, ("mouth", for the benefit of upper classmen who forgot their anatomy), "Oh, those virgin cassocks—soon to acquire such tints and odors as to rival the very stables of Augeas".

The freshmen were soon assigned to tables and cadavers and it wasn't long before John Q. was formally introduced to the four men who were to figure so largely in his "life" for the next eight months. The students first listened to an introductory lecture by Dr. Leschin in which the honorable doctor made a nasty crack (making our John blush clear through to the hypodermis) concerning the powerful odor which would begin to emanate from the bodies along about May.

Then John's four greenhorns began cutting up. Over the clink of the scalpels John could hear the voiced reflections of the freshmen of the important happenings of the past few days: how fearful and timid they had been when listening, wide-eyed, to the summary opening addresses of Dean Logan and Dr. Mueller rendered in the large "amp" Tuesday eve; how, at the first meeting of the Dental Anatomy class, they amazedly witnessed Dr. McNulty carve an upper central incisor in six minutes flat; how narrow they had been at first when they had snickered at Dr. Kanner's pronunciation

of "teese in the mouse", before realizing that it isn't how one says a thing, but what one says that really makes the man. These were the reactions that our alert John observed this first day of dissection.

Much later, (to be specific: thirteen bones and twenty-seven muscles later), John began to notice many changes occurring in this Freshman class, which by now had progressed from the embryonal to the fetal stage. One fact that was really puzzling was that practically everyone in the class had the same first name. In reality, twenty-six of the students suddenly adopted the monicker of Max. "Hey, Max!" seemed to be the "Open Sesame" for the entire class. This surprising development was undoubtedly the work of a clique including: Fred (Max) Grohowiak; Andy (Max) Sauer; Vic (Mac) Seitz; Gene (Max) Stegmaier; Ross (Max) Neglia; and others, (Maxes).

After much discouragement, three intramural volleyball teams were organized, with the inestimable help of managers Jason, Shor, and Trace. Of the three teams, one, (Captain Marty Killoren and Co.), is now sporting a gold watch charm as a result of its fine efforts expended in winning the school-wide tournament.

Approximately one week before the Christmas let-up, John Q. overheard the boys discussing the recent class election. It seems that John Moss had been the logical candidate for presidency and he did achieve this office practically uncontested. The position of vice-president was won by Don Anderson. The other offices filled included: treasurer—Andy Sauer; secretary—Don (Armand) Webber; and last, but certainly not least, sergeant-at-arms rollicking Roy Lambert.

The Christmas vacation began at last—giving John a much-needed rest—and a chance to take stock of himself.

In January when the boys were back at it again, John learned of the little celebration held over at Lefty's after the last exam. It seems they nearly burned that noble establishment to the ground, by making a little bonfire of the calcification crib-sheets. "Well, boys will be boys", sighed our John.

The first business of the month discussed around the dissecting tables after the vacation, was the proposal of a class dance. This met with instantaneous approval and Andy Sauer was appointed dance chairman. However, things did not proceed as smoothly as planned. Many problems arose—such as: the date of the dance; the name of the affair (should it be "Cuspid Copers" or "Dent Debut Swingaroo"); and whether the girls should wear long dresses or short dresses (all in favor, signify!). The ultimate outcome was that the Freshman Class held their annual "Winter Informal" at the Medinah Club, the evening of February tenth.

Music was supplied by a swell band featuring classmate Steve Woynovitch as pianist; the girls wore short dresses; and everyone, including Andy Sauer, was happy.

The beginning of the next semester found the class engulfed in work much more pertinent to the specialized study of Dentistry and also brought the freshmen into contact with two men, one of whom Dr. Rudolf Kronfeld, a recognized authority in his field, left the boys with a lasting, memorable impression; the other, a man destined to act as a guiding influence for the students throughout the rest of their college and post-college days, Dr. Henry Glupker.

Dr. Kronfeld, in his course in Oral Histology, methodically, and with great patience, conveyed to the minds of the freshmen the intimate microscopic structure of the teeth and their surrounding tissues.

Dr. Glupker, in turn gave the students their first taste of the problems encountered in the construction of an artificial denture.

Throughout all this mutation Anatomy worries were omnipresent. In fact, John O. himself was getting a little worried as he was experiencing difficulty in thinking to himself since the students had removed his brain for neurological study. He was really in a bad way. His head was in bits: bisected, trisected, etc. They had already begun hacking at his abdomen, the ghouls! But Friday, June second, put an end to all that. It also put an end to John O. Corpse, for God Bless His Soul—on that day his story ends, (as does ours)—as he is slowly lowered into the boiling cauldron of caustic soda—to be reduced to nothing but bones—for the benefit of the Freshman class of 1943. Goodbye, John! Requiescat in Pace!

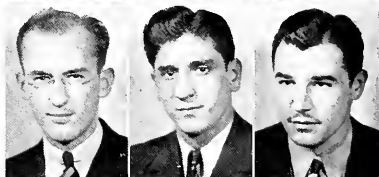
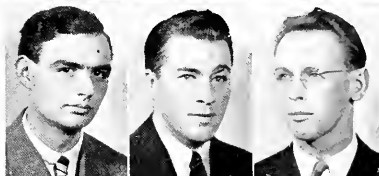

Abramski
Bennett
Bonaventura
Chedester
Fagt
Greblunas

Anderson
Berley
Brandt
Conrad
Gigante
Greenbaum

Bartz
Bloom
Brehm
Faber
Gordon
Gresik



Grigal
Jastromb
Lukaszewski
Mueller
Sauer
Tilka

Grahawick
Kalin
Lutton
Neglio
Seitz
Trace

Guenieri
Killaren
Matousek
Onak
Shar
Valkenaar

Vlk
Harunaga
Kosel
Maya
Perrone
Smejkal

Webber
Hopkins
Kotecki
Metzgar
Piekos
Stegmaier
Williams

Woynovitch
Ireland
Lambert
Maskal
Rennie
Swantek

Ziolkowski
Jan
Lehman
Moss
Resnik
Tener

Freshman interpretations of
STUDYING ORIENTATION
according to,

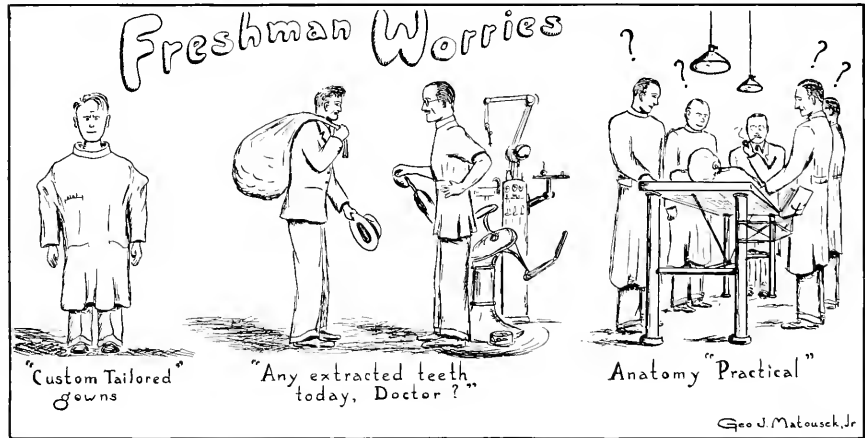
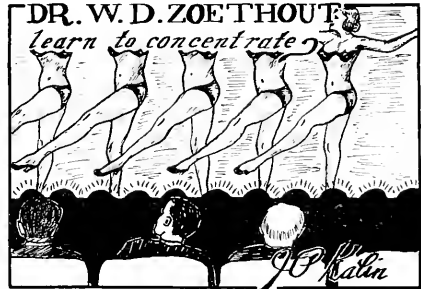
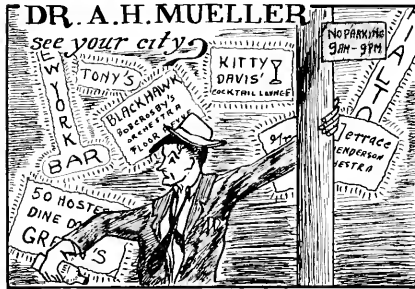
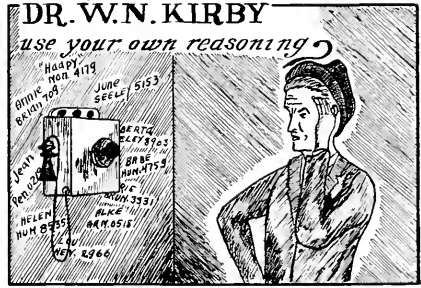
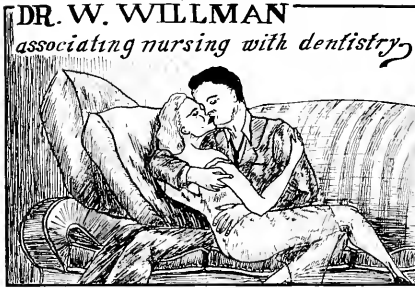

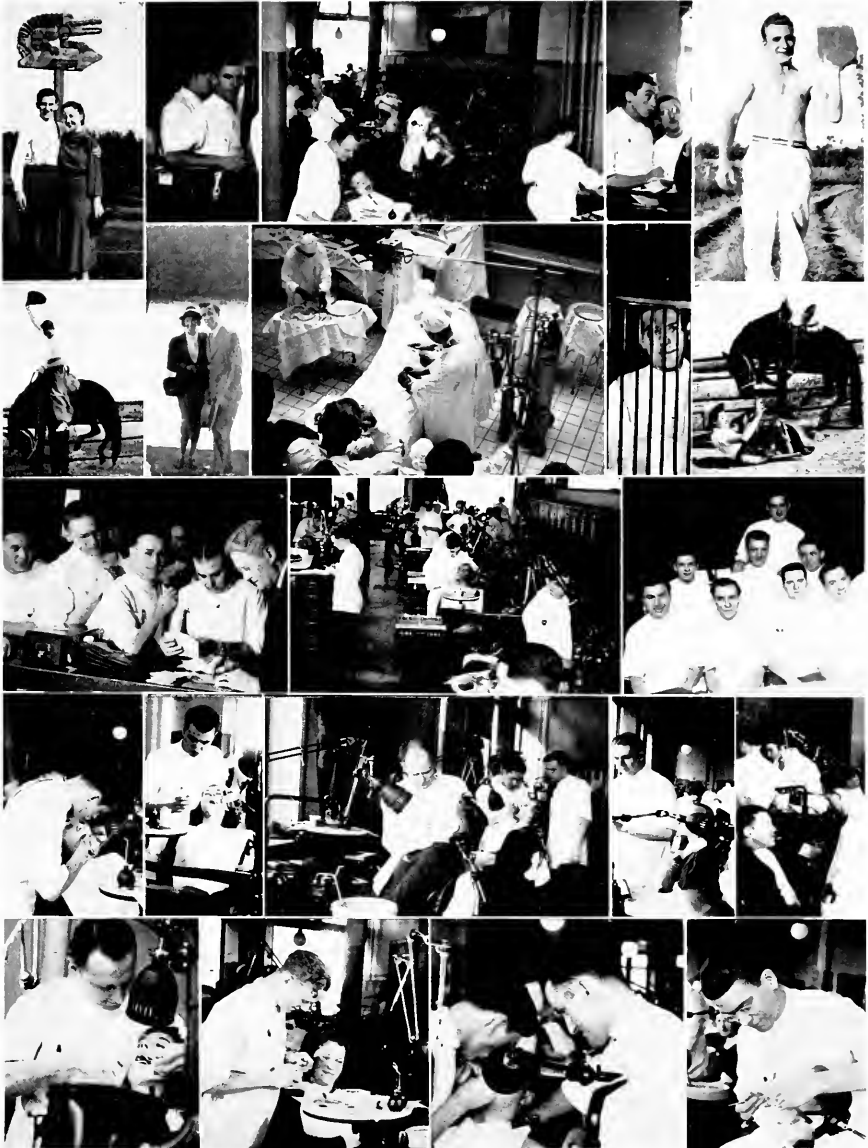



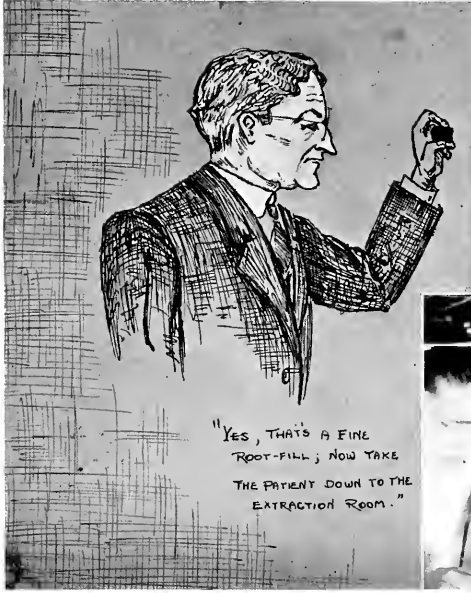
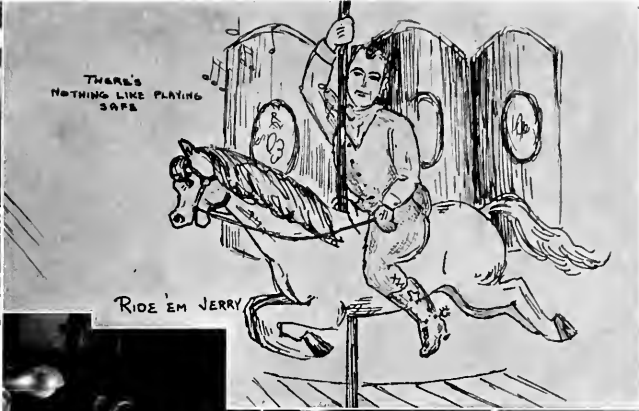

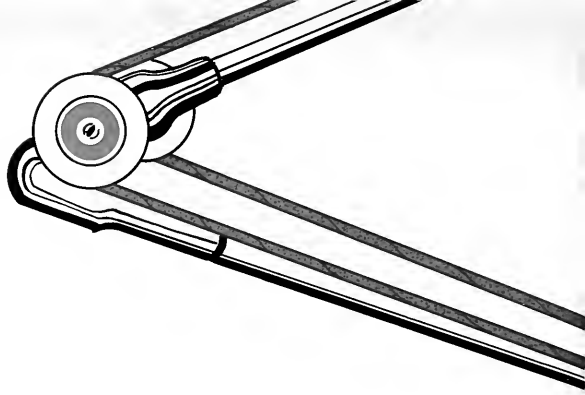

The publications of any organization,
like the pulse-beat of an organism,
indicate to those without what manner
of health prevails within.

Warren Willman.

PUBLICATIONS

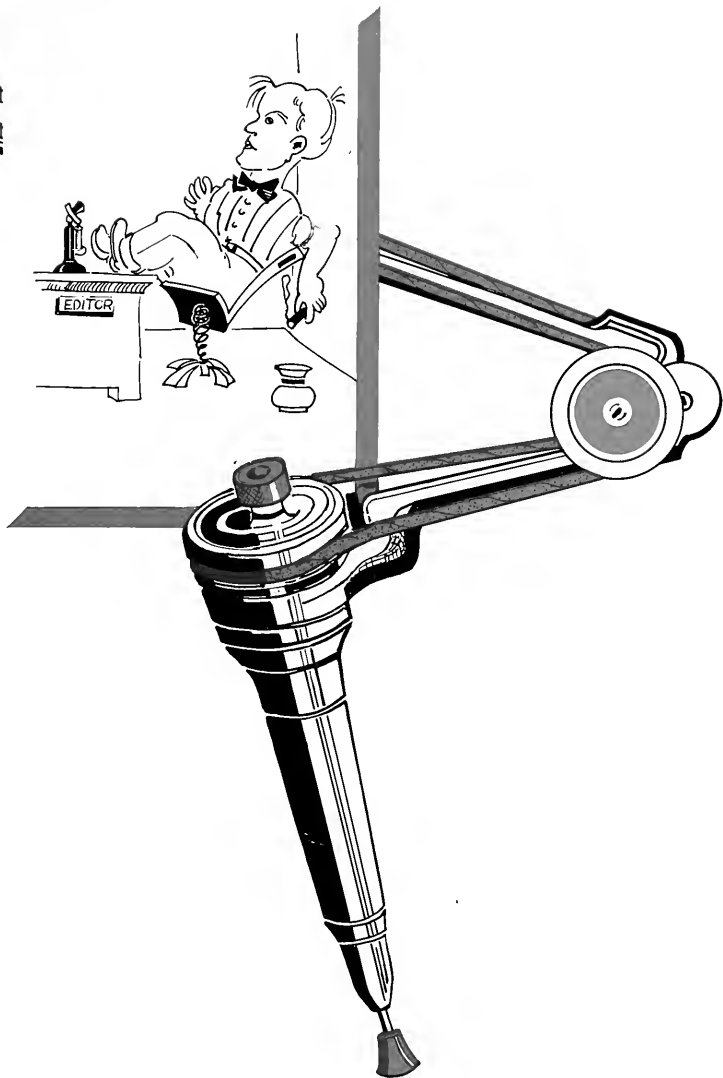

THE 1939

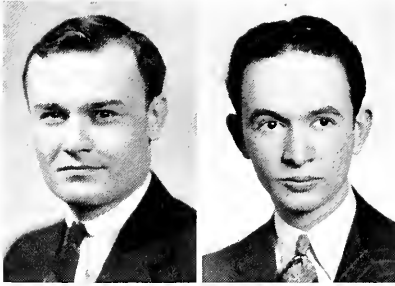

FRANK JERBI LAWRENCE SCHEFF
Co-Editors

The year 1939 marks the return of the Dentos as an all-college book. The privilege of publishing this volume was missed by us as Juniors when the class of 1938 published a Senior Dentos. This year the Senior class took matters into their own hands and elected a Dentos staff.

Immediately after the elected men had been approved by Dr. Logan and Dr. McNulty, the remainder of the staff was selected and work was begun. The seniors chosen were Felice Poone, class artist; Edward Mikula, cartoonist; and Takeo Yoshina and Bruce Spooner, photographers. An editor, artist, and circulation manager were appointed to represent each

class. The under class men were: Juniors—Dedekind, Ziolkowski, Belofsky, and Stewart; Sophomores—Garguilo, Newell, and Readell; and Freshmen—Shor, Kalin, Matousek, and Fogt.

The staff has worked hard to prepare an annual such as the graduating senior deserves, and one of which the school may be proud. Each member has given untiringly of his service, and each student his support. Without this fine cooperation on every hand the book would have been an impossibility.

In the 1939 Dentos the staff has tried to assemble the happenings of the year. Between its two covers they have sought to cramp a

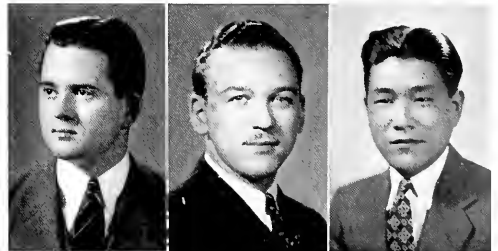

Adams

Shapiro

Yoshina

DENTOS

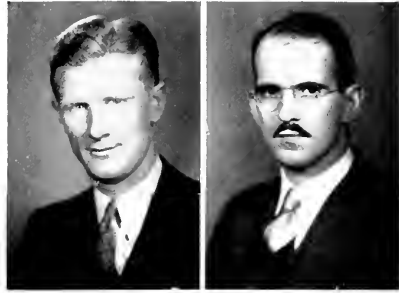

DR. ROBT. E. McNULTY DR. WARREN WILLMAN
Financial Advisor Faculty Advisor

space of time that it may ever recall these months spent at work and play with friends.

In spite of a limited budget they have tried to produce a book of quality rather than size—a book distinctive in its very simplicity. Symmetry and balance have at all times been the key-words. To make a unified whole of the mass of conglomerated material has been their aim.

It is hoped that the novel division pages in two colors lend a bit of pleasing informality as well as humor to the book. The handpiece theme and arrangement of photographs are examples of the originality of design.

The snapshots, most of which were taken by Takeo Yashina are as varied and humorous as life—they are in truth snaps of life—snaps of life's irony, wit and flattery. For that very reason these sections are always exceedingly popular and interesting.

Unlimited credit is due Dr. Robert McNulty and Dr. Warren Willman, financial and faculty advisers, for their wise counsel and unstinted assistance in making this Dentos possible.

Acknowledgement is expressed to Mr. James Oldham of the Jahn and Ollier Engraving Company and Mr. Oliver Rogers of the Rogers Printing Company for their technical assistance.

Paane

Mikula

Spooner





The Bur

VOLUME XXXIX

NUMBER ONE

MARCH 1939

T H E B U R

The BUR, the official publication of the alumni association, is in its forty-third year, having been first edited by the late Dr. C. N. Johnson in 1896. In recent years it has been very successfully supervised by Dr. Robert W. McNulty, who was maintained consistently the high standards set by its first editor. It is published three times each year, and its circulation includes all students and alumni of the school.

The purpose of the BUR is not to instruct along highly scientific lines, but rather to entertain with news and notes concerning college and alumni affairs. There are, however contained in each copy of the magazine, articles of value and interest, by graduates of the college, on dentistry. Results of research, news of conventions and meetings, and notes on the happenings in the undergraduate classes fill the pages. The success of the

Chicago College of Dental Surgery Alumni Association owes much to this publication.

The December 1938 issue of the BUR was devoted entirely to the life of our late beloved Dr. C. N. Johnson. In it were many of his writings and also many tributes paid to him by other authors.

The sections devoted to each of the classes have made the BUR very popular during the past few years. It has made students feel as though they were a part of the alumni Association. Editors representing each class are appointed at the beginning of the school year. Frank Jerbi, representing the senior class, has done a good job of reporting the activities of his classmates. Medford Riley reported the doings of the junior class. Forrest Branch took care of the sophomore pages and did it well. John Moss was the editor that reported the outstanding events of the freshmen class, and his articles were enjoyed by the members of all classes.

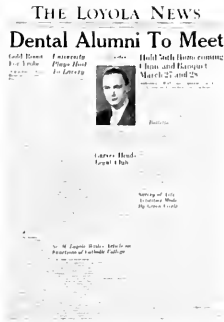

THE LOYOLA NEWS

Ever since the founding of The Loyola News more than thirteen years ago by a small group of liberal arts students among whom were our own Doctors Harold Hillenbrand and William Schoen, it has grown to be one of the most important publications of the University. Through its pages, the dental student has the opportunity for broadening his outlook beyond his professional boundaries. Through its columns he may become infiltrated with some of the school spirit which dominates a large university. Through the News we are brought face to face with personalities and events of the other campuses. The spirit of the founders is strictly adhered to, so that today the news is yet the torch-bearer of Loyola traditions.

The tabloid form of the paper which was inaugurated in 1934 was maintained this year with increasing popularity. The Collegiate Digest proved to be one of the most popular sections. Its recording, by striking and unique pictures of the activities of other universities gives us a medium of exchange of ideas that is eagerly sought. Among the most popular of

the columns during the past year were "Marty at the Mike", and "Ho-Hum."

This year almost every issue had at least one or two articles of dental interest. Most of these articles gave last-minute reports of the sports and fraternity events of the dental school. In this manner, the News staff has endeavored to relate interesting events happening at our campus and to give a cross-section of our fraternity and sport life.

The staff for the past year, under the direction of Max Shapiro, Campus Representative, was Howard Gault, Joe Arnold, D. J. Raynes, and Seymoure Appell. These men were all assigned certain activities to cover and write up. Feature articles were written by the campus representative. All material before being published was approved by Dr. R. W. McNulty, dental news faculty moderator.

For next year the News staff will be Kenneth Dedekind '40, Campus Representative, Daniel La Mathe '40, Salvatore Impelliteri '41, and John Kalin '42. These men were picked because of their willingness to cooperate and their ability.

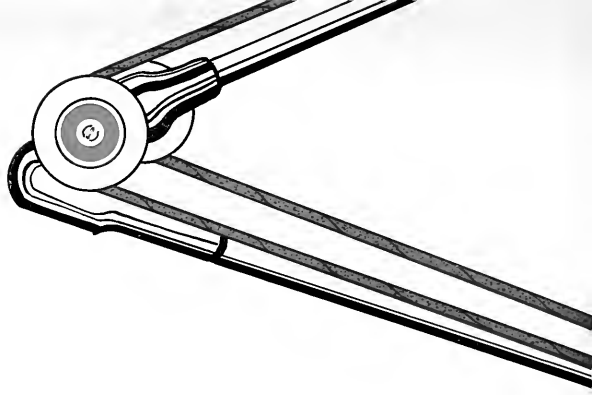

"I shall pass this way but once; any good thing, therefore, that I can do or any kindness that I can show to any human being, let me do it now. Let me not defer it or neglect it, for I shall not pass this way again." Earl of Devonshire. This should be the motto of every fraternity man.

Earl P. Boulger

FRATERNITIES

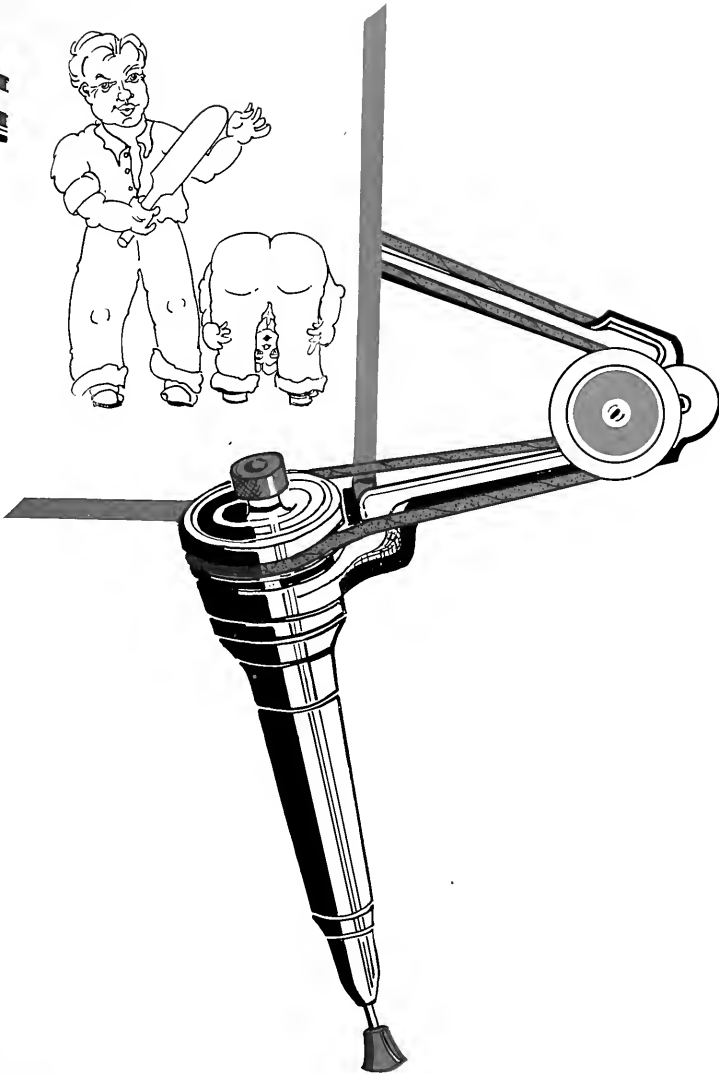

DELTA SIGMA DELTA

At the University of Michigan College of Dental Surgery, in 1882, the first dental fraternity was organized by nine men, who desired to increase professional fraternal association and to impress upon the members that a spirit of fraternal cooperation toward scientific, ethical, and professional progress was of paramount importance for dentistry. A few years later, on March 24, 1885, Beta Chapter was founded at the Chicago College of Dental Surgery.

The fraternity consists of a Supreme Chapter; a Supreme Council to conduct the business of the fraternity between the annual meeting of the Supreme Chapter; a Council of Deputies to govern the activities of the thirty-two subordinate chapters in the dental schools over the

country; many Continental Chapters; and fifty Auxiliary Chapters in the United States and Canada.

The *Desmos*, issued quarterly, is the official publication of the fraternity. Each issue usually contains an item submitted by each of the subordinate chapters, and articles by graduate members prominent in some specialized work.

Beta Chapter held dinner meetings during the past year usually at the Professional Schools Y. M. C. A., every second week. All of the meetings were organized by the members, under the supervision of Deputy Supreme Grand Master, Earl P. Boulger. During the year twenty-five new members were initiated, bringing the total active membership to sixty-seven.



Boulger	Buckley	Dawson	Glupker	Grisamore	Hillenbrand	Holmes	Hooper
Hyde	C. Johnson	R. Johnson	Kirby	Lindner	Logan	McNeil	McNulty
Michener	Mueller	Pike	Puterbaugh	Schoen	Swanson	Watt	Willman

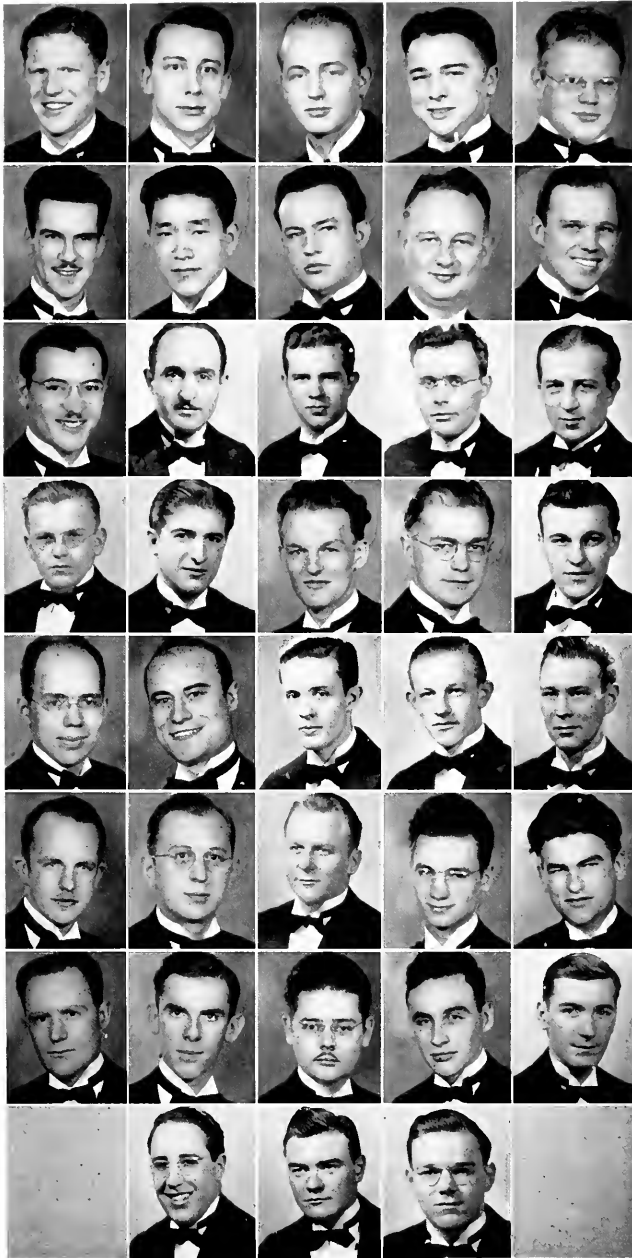

FRATRES IN
COLLEGIO

Kelly
DeWitt
Singler
Spooner
Ahnger

Scott
Yoshina
Hale
Fischer
McKee

Nicastro
Paone
Limacher
Kosak
Mikula

Kriss
Politis
W. Burke
Smeby
Rock

Grisamore
Giroldi
Butler
Land
Verhoeven

Herthneck
Gost
Haas
VanKley
R. Burke

Holmes
J. Gibson
Landstrom
Smith
Sitar

Amaturo
Hocking
McIntyre

ALPHA OMEGA

Alpha Omega, organized in 1907, has entered upon its fourth decade of service to the dental profession. Founded at the Pennsylvania College of Dental Surgery by a small group of unorganized men, it has shown a growth and development far beyond the most sanguine expectation of its founders.

Today, Alpha Omega's domain extends throughout the United States and Canada, consisting of thirty-two chapters and approximately thirty-five hundred men.

The fraternity spirit is expressed in the three Latin words, "Harmonia, Amor et Veritas", meaning "Harmony, love, and truth"; in life, good scholarship, clean sportsmanship, and the honor of a gentleman.

Alpha Lambda chapter, founded in 1932 at this school, has completed the most successful year of its brief history. Our meetings, held semi-monthly at the Congress Hotel, have been made extremely interesting by the presentation of clinics and lectures by men prominent in the profession.

The social life of our chapter was very bright, centering about smokers, parties, dances, and buffet suppers. The first of these, a smoker in honor of the freshmen, was held in the Florentine

Room of the Congress Hotel. A few interesting films were shown and several alumni and guests gave short speeches.

After the Christmas holidays the newly-elected officers of the chapter were installed at ceremonies held at the Morrison Hotel. A buffet supper and dancing followed.

In the spring, the Congress Hotel was the site of another buffet social. Music for the occasion was supplied by Benny Goodman, Hal Kemp, Tommy Dorsey and other famous recording orchestras, and the affair was one of the most popular of the year.

On May fifth, the highlight of the social year, the Senior Dinner Dance, was held at the Gold Coast Room of the Drake Hotel. There, to the soothing strains of Ted Weems and his ever-popular orchestra, the members and alumni feted the ten departing seniors upon the completion of their scholastic careers. The Chancellor's key was presented to Harold Epstein and the Junior Scholarship award to Max Shapiro.

Several days later, on May tenth, the Illinois alumni chapter of Alpha Omega presented a Tri-Chapter initiation at the Skyline Athletic Club. In an impressive ceremony, the neophytes



Dr. Leshin



Dr. Siegel

of the Illinois, Northwestern, and Chicago undergraduate chapters were inducted as members.

Prospects for the future are bright, due to the enthusiasm of the fraters and the efficiency of the officers. The officers for the following year are:

Maurice Henken—Chancellor
Joseph Perlman—Vice-Chancellor
Paul Brown—Quaestor

Wilbert Gordon—Scribe
Charles Shectman—Macer
Morton Fireman—Editor

Active fraters of the past year were: Appell, Becker, Epstein, Fein, Gold, Klapman, Kurtz, Moses, Raynes, Scheff, Shapiro, Weinstein, Belofsky, Bendersky, Fireman, Fishman, Goldstein, Goodman, Gordon, Henken, Hoffman, Pearlman, Perlman, Shectman, Vinickour, Brown, Cowan, Harris and Shrago.

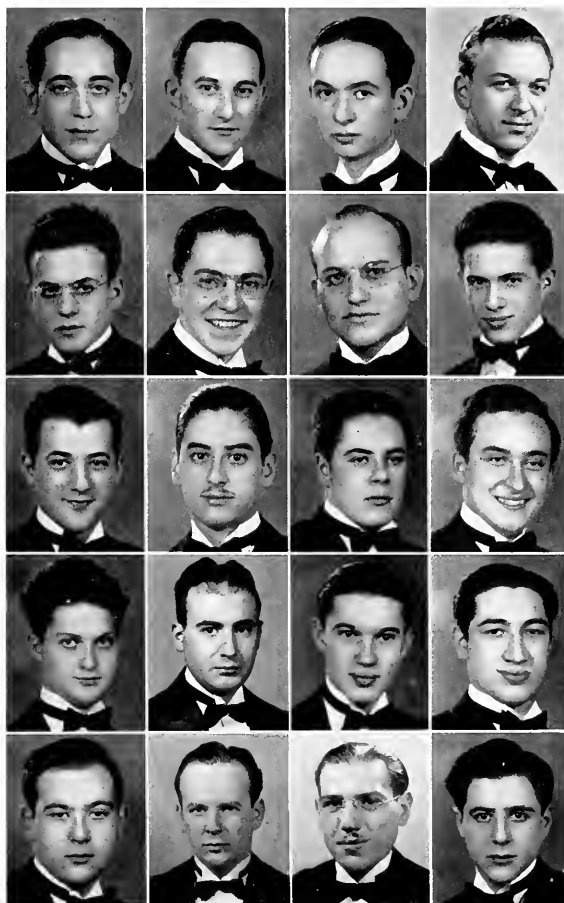

FRATRES IN COLLEGIO

Epstein
Moses
Scheff
Shapiro

Gold
Fein
Raynes
Klapman

Kurtz
Appell
Belofsky
Becker

Vinickour
Henkin
Fireman
Goodman

Bendersky
Perlman
Gordon
Hofman

XI PSI PHI

Xi Psi Phi was founded at the University of Michigan Feb. 8, 1889.

It was the second dental fraternity organized.

It was the first dental fraternity to become international in its scope, with the establishment of Omicron chapter at the University of Toronto in 1899.

During its existence it has established forty-six active college chapters, but approximately one-half of these have gone out of existence, many because of the discontinuance of the dental schools of which they were part. We have today twenty-five active chapters.

It has initiated 16,000 members. It was first dental fraternity to adopt a Life Insurance Plan.

It is the only dental fraternity having a Life Membership Plan, whereby every initiate

becomes a Life Member upon graduation.

The objectives of Xi Psi Phi fraternity are to promote social unity among dental students generally and to render mutual assistance among them; to inspire intellectual advancement, and to broaden their appreciation of friendships while they are pursuing their course of study; to establish a fraternal feeling and brotherhood among them while they are in their respective schools and colleges; and to promote fellowship, sociability, moral rectitude, intellectual advantage and opportunity to its members after they have entered the profession of dentistry.

Lambda chapter has endeavored to maintain the brilliant standards of Xi Psi Phi. Its graduates have achieved fame and distinction in all fields of dentistry.



Dr. Coolidge



Dr. Oppice



Dr. Pendleton



Dr. Pinney



Dr. Stine



Dr. Richey



FRATRES IN COLLEGIO

Adams
Jenkins



Hadjuk
Jurewicz



Dobry
Sutley



Kouba
LaMothe



Stewart
Ziolkowski



Ferington
Chmiel



Zullo

The finest aid to a local undergraduate chapter is the alumni of the chapter, and the Lambda chapter has an alumni that is active, an alumni that is enthusiastic and guiding. We are proud of our brothers and the individuals who govern the affairs of the Xi Psi Phi.

Lambda meets twice monthly. Here students make valuable contacts and clinical observations. Social events have had their place on Lambda's calendar to round out the activities. Early last fall a "Hard Times" Dance was held at the West End Women's Club. The affair was attended by members of the other fraternities and non-fraternity men as well as well as the "Zips". Those who came well dressed, soon found their clothes reduced to a state quite becoming to a Depression Ball. Music for the occasion was furnished by Roman George's Orchestra. The leader, is none other than our own Roman Ziolkowski. Faculty members attending the affair were Drs. Vlk and Rzeszotarski.

This year has been especially great and important to Xi Psi Phi—February 8, 1939 marked the founding and we celebrated the Golden Anniversary at the birthplace of our fraternity, Ann Arbor, Michigan.

The official magazine of the Xi Psi Phi fraternity is the "Xi Psi Phi Quarterly", a publication intended to keep the members informed of fraternity matters.

The incoming officers are:

Elmer Kouba, president
Daniel LaMothe, vice-president
Joseph Stewart, secretary
Harold Readel, treasurer.

Graduate officers are:

Dr. E. A. Prugh, Deputy Supreme President.
Dr. E. D. Coolidge, Assistant Deputy Supreme President.
Dr. J. J. Vlk, Assistant Deputy Supreme President.

PSI OMEGA



Winquist

Bassak

Binotti

Link

Dedekind

Knuckles

Baranowski

Forty men banded together and called themselves Psi Omegas. This was the formation of Alpha Chapter of Psi Omega Fraternity at the Baltimore College of Dental Surgery in 1892. From this small group of staunch men arose a great fraternity, boasting of approximately nineteen thousand in membership and embracing fifty-five active Chartered Chapters. A group of men, desiring the benefits of such a great fraternal organization, grouped together and formed the Kappa Chapter in 1898 at the Chicago College of Dental Surgery.

Successful Psi Omegas may be found over the entire world and in every branch of Dentistry. The alumni and active members have done much to earn the respect of their fellow men. They have followed the teachings of Psi Omega and have been prominent in advancing and improving the standards of Dentistry.

Active members keep in touch with the alumni members through a quarterly publication

known as The Frater, the official bulletin of the Psi Omega Fraternity.

Kappa Chapter convenes twice a month at the Psi Omega House. Here the able assistance of Dr. Frank Biedka, Deputy Councilor, is utilized, and much work is accomplished towards the continuation of a grand group of students and alumni.

Well attended Freshmen smokers and successful parties were held in the Psi Omega House, where most of the social functions of this Chapter are held.

Every year finds a new installation of officers and this year was no exception. Julian A. Link followed Dorus L. Winquist as Grand Master, Ashton E. Knuckles succeeded Julian A. Link in the position of Treasurer, Adolf Baranowski took over the position of Secretary from Eyo Binotti, Kenneth L. Dedekind was elected Editor, and August C. King retained the position of Chaplain.

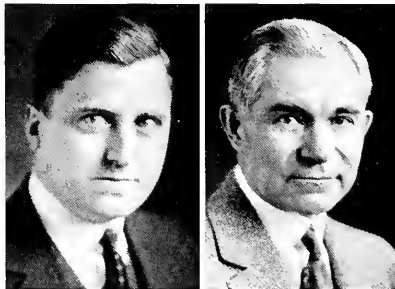

Dr. Meyer

Dr. Kendall

OMICRON KAPPA UPSILON



Upon the culmination of each school year, and on the eve of graduation, a small group of the graduating class is honored with membership in Omicron Kappa Upsilon. This honor is considered a final tribute paid by the college in recognition of the conclusion of the school careers of those men worthy of special commendation.

Requirements for nomination to this society are a splendid character and citizenship as well as the possession of such grades earned during the entire course that places the student in the upper twelve per cent of his class. To be presented with the distinguished gold key, emblematic of membership, is the highest honorary award offered at the Chicago College of Dental Surgery.

In addition to selection of its members from the graduating classes practitioners may become eligible. Those who "through excellence of professional attainments and citizenship, have distinguished themselves in their profession, and in respective communities" may have membership conferred upon them.

This, the Graduate Honor Society of the Profession, was organized in 1914 at the

Northwestern University Dental School. The founders were Drs. Thomas L. Gilmer, Arthur D. Black, and C. R. E. Koch, who felt that a fraternity was needed "to encourage and develop a spirit of emulation among students in Dentistry and to recognize in an appropriate manner those who have distinguished themselves by a high grade of scholarship."

In 1925 the Chicago College of Dental Surgery was granted a charter to establish a chapter designated as Pi, which has since honored approximately three hundred men, practitioners and graduates. Pi chapter is guided by such men as Dr. W. H. G. Logan, president; Dr. R. W. McNulty, vice-president; and Dr. P. G. Puterbaugh, secretary-treasurer. These men and practically all of the faculty of this school have been honored with membership for their distinctive accomplishments.

From the graduating class of 1938 five men, by reason of their brilliant records as students, were given the signal honor of wearing the key of this worthy fraternal organization. Those men were, Marvin E. Chopin, William J. Charm, Ralph G. Lorsen, A. Albert-Moser, and Joseph Schneider.

BLUE KEY



Founded at University of Florida, 1924

Established at Loyola University, 1926

Blue Key National Honor Fraternity is a fraternity which has as its objects high scholastic rating, participation in school activities, and popularity among one's fellow students. Thus a man is elected to Blue Key only when he meets with the highest standards in his class.

The organization is not secretive in nature, but has as its ideals the creation of a feeling of good fellowship among non-members. This one point alone could not be possible if it were governed as most fraternal organizations are. It has no national installation teams, fees, or dues, but the local conditions at the universities in which the chapters exist govern the formation of its constitution and by-laws.

In October of 1924 Blue Key was founded at the University of Florida, and since then has spread over the entire country. In 1926 Loyola Chapter was admitted as the nineteenth, there being today over fifty chapters which are active in some of the largest universities in the country.

The Blue Key men on one campus act as host to the Blue Key members and their friends on the other campuses of the University. In 1937 the dental campus was host to the University, and the other campuses were invited to look behind the scenes of scientific research in the dental profession by inspecting the newly created Foundation for Dental Research of the Chicago College of Dental Surgery.

Faculty members in the dental school are: Drs. W. H. G. Logan, Dean; Earl P. Baulger, Harald A. Hillenbrand, Frank W. Hyde, Wallace N. Kirby, Rudolf Kronfeld, Paul T. Dawson, Henry L. Boris, John F. Svobada, William P. Schoen, Ralph G. Larsen, and Joseph S. Rzesortarski.

Undergraduate members in the dental school are:

Seniors:

Arthur G. Adams
Victor J. McKee
William C. Limacher

Juniors:

Medfred S. Riley
Peter Griffo

ALPHA SIGMA NU



Since its foundation twenty-four years ago as an honorary Jesuit society, Alpha Sigma Nu has been a leading undergraduate organization in every university in which it has been established. It has gained such prominence that mention has been made of recognizing it as the official honorary society in all catholic colleges and universities throughout the country.

The purposes of Alpha Sigma Nu are to honor students who have distinguished themselves in service and loyalty to the University as well as in scholarship; to lend support to and promote such activities of a character which will tend to elevate the intellectual and cultural level of the students in their respective universities; and to help strengthen the bonds between faculty and students.

Established at Loyola in the spring months of 1938 the chapter has, with the aid of the Rev. Thomas A. Egan S. J., carefully built a foundation upon which future members will be able to act with confidence and authority. The members, selected while in their junior year by the deans of their respective schools, meet every month at the Downtown College to discuss under-

graduate problems. Contact is maintained with the other chapters through the "Newsletter", the official publication of the society.

With the deans of the various schools present as honor guests the formal initiation of new members was conducted on April 23, 1939 in the Town Room of the Knickerbocker Hotel. A number of alumni were present at the banquet that preceded the initiation ritual.

The coming year will be an active one for Alpha Sigma Nu. The year 1940 marks the silver jubilee of the society and plans are in progress to conduct a memorable national convention at Marquette University of Milwaukee, Wisconsin, the home of the mother chapter.

Undergraduate members in the dental school are:

Seniors:

Truman G. DeWitt
Frank C. Jerbi

Juniors

Kenneth L. Dedekind
Robert G. Herthneck

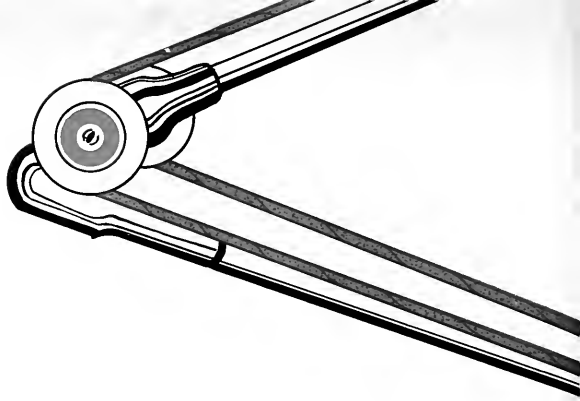

"Good enough" is not sufficient. The
game is either won or lost.

G. C. Pike

ATHLETICS

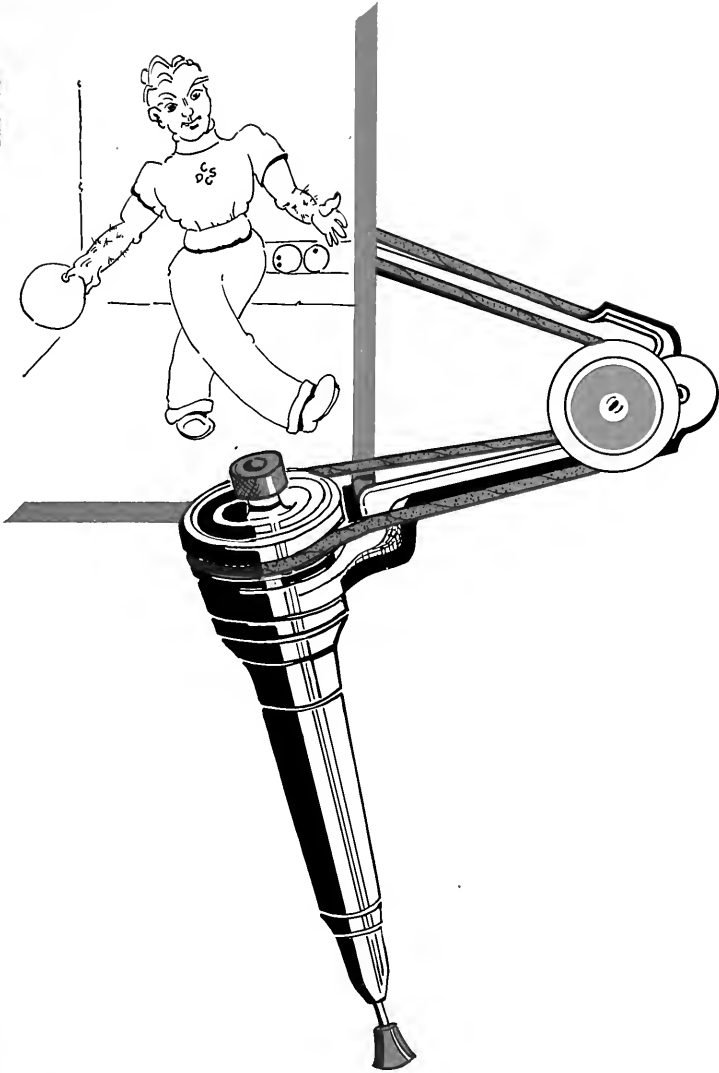

INTRAMURAL SPORTS

The Intramural Athletics of the Dental School are supervised and their schedules planned by Dr. Ralph Larsen, Howard Gault, Max Shcpiro, and a board of intramural managers selected from the various classes. Edwin Belofsky represents the Junior Class and also serves in the capacity of Assistant Intramural Director. He will be Intramural Director for the coming year. Edward Garguilo and Salvatore Impelliteri represent the Sophomore Class, and Paul Jason, Lester Trace, and Joseph Shor, the Freshman Class. The board of class managers plays a very important part in dental school athletics. These men are present at each game of every tournament, and the success of a tournament depends upon the work and judgement of the class managers. At the end of the intramural year, various awards are given out. The Freshman Managers receive bronze awards, the Sophomore Managers, silver awards, the Junior Manager, a gold medallion, and the Director, a sweater and letter from the University.

This year was one of the most successful, so far as athletics were concerned, in a great many years. There were more different tournaments than ever before in the history of the Chicago College of Dental Surgery. The first innovation was a volley-ball tournament, which proved to be very successful. Nine teams were entered and competition was very fast and very close. At the start of the

tournament, the Delts 1 team was picked as the probable winner. Led by the redoubtable Joe Haas, they seemed to be prime favorites to emerge on top at the close of the tournament. However, a dark horse, in the person of the Freshman 1 team entered the picture. Matching the Delts, win for win, the end of the season found these two teams undefeated, with but one game left to play, and that game to be played against each other. Class partisanship ran high, for most of the Delts were Sophomores, Game time found the Delts still favorites to win, due mainly to the fact that the Freshmen were not very well known. The Delts were confident and piled up a good lead in the opening minutes of play, but Captain Marty Killoren rallied his green-clads and they came back with renewed vigor in the last part of the game to win both the contest and the tournament.

Members of the victorious Freshman 1 Team are as follows:

Grigal	Gordon
Conrad	Faber
Jastramb	Abramski
Killoren(c)	Tener

The final standing of the teams is as follows:

Team	Won	Lost
Freshmon I	8	0
Delts I	7	1
Freshman II	6	2

Gault

Belofsky

Impellitteri

Shor

Trace

Jason

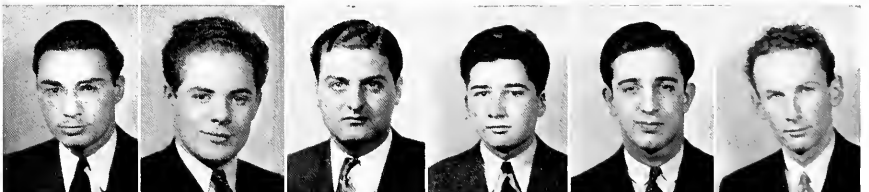



Zips	4	4
Alpha Omega	3	5
Burs	2	6
Freshman III	2	6
Juniors	0	8
Delts	0	8

The next tournament on hand was the annual basketball tournament. This, as in other years, turned out to be the most popular tournament of the season. Unlike volley-ball, the entries in this tourney were restricted to one team from each fraternity and one independent team from each class. A total of six teams was entered. The tournament was run off in two rounds with the provision that the winner of the first round would play the winner of the second round for the championship. All games were played at the Professional Schools Y. M. C. A. with the various class intramural managers acting as officials. The Delts, who were last year's champions, came up with a host of new stars and were considered prime favorites to take this year's classic. Last year's luminaries, Charm, Blevins, and Ortman, who had been lost through graduation were more than easily replaced by Bartz, McIntyre and Anderson. The only other team considered able to give the Delts a battle was the Zips, a strong, but erratic team. Bolstered considerably by the addition of brilliant "Red" Brzdenkiewicz, the Zips were picked either to finish next to the Delts, or possibly upset them for title.

most disappointing team of the tournament was the Burs, an independent team composed mainly of seniors. In the previous year's tournament, this team was outstanding and in the playoff for the championship, lost to the Delts in the last few seconds of play and then only by one basket. However, this year told another story and for some unknown reason, the Burs slumped badly and finished in the cellar.

The Delts won the first round and won it rather easily. However the second round was a little different. Paced by fast-stepping "Red" Brzdenkiewicz and "Pete" Zulla, the Zips matched the Delts' unblemished record and the result was that these two teams played each other for the championship of the second round. As the Delts had already won the first round, they needed only this one game to capture the championship. Both teams played excellent basketball, but the confident Delts turned back a fighting Zip team to win the game and tournament by a margin of three baskets. The members of the Champion Delt Team are as follows:

- | | |
|----------|----------|
| Burke | Anderson |
| Haas (c) | Faber |
| McIntyre | Neglia |
| Bartz | Amatura |

On the eleventh of April, the Delts met the Hoplites, Champions of the Loyola Medical School Tourney, for the championship of the west side departments of Loyola University.





William Limacher

The game was played at the Professional Schools Y. M. C. A. The Delts lost a hard fought and hotly contested game by a score of 27 to 25. Markiewicz and Meier starred for the visitors, while Joe Haas and Ray Bartz were outstanding for the home team. Incidentally, last year, the same two teams met for the west-side championship, and the Hoplites won . . . by two points.

The final placement of the teams is as follows:

Delts	Alpha Omega
Zips	Terrors
Freshmen	Burs

All of the members of the winning Delt basketball team were awarded little gold basketballs.

The Annual Intramural Bowling Tournament was run off at the Schuenemann-Flynn Bowling Alleys. A total of fifty-five men entered the tournament. Rudolph Dobry of the Senior Class and Joseph Buda of the Junior Class were favored to win. The close of the tournament

found the following five men at the top of the heap.

Name	Score (average)
Dobry	180
Amaturo	158
Buda	153
Wadas	148
Adams	146

These five men were given small watch charms, in the form of gold bowling balls, for awards. As a word of caution, the winners of these awards are advised not to use them for casting gold inlays.

This year found members of the Dental School rather active in University athletics. Bill Limacher of the Senior Class was on the varsity golf team, and was awarded a minor letter and sweater. Max Shapiro, the stellar merman, completed four years of varsity competition with the University swimming team. Max was high point man of the team during the preceding year, and this year finished in third place in point standing. He was awarded a major letter and sweater for his efforts. In addition to being a member of the swimming team, Max was also active in Dental Intramural athletics, serving as Intramural Director in 1938 and as Intramural Co-Director in 1939. The beginning of the year found both Ted Ahnger and Eddie Ferrington out for the swimming team, but both boys felt that they had to devote more time to studying and points, so dropped out before the season had gotten well under way.

As yet, the annual Ping-Pong Tournament is not finished, while Baseball and Horseshoes (singles and doubles) have not started . . . due to the inclemency of the weather.

With a great future on the horizon for the Intramural Sports of the Chicago College of Dental Surgery, Co-Directors Howard Gault and Max Shapiro turn over the helm to Edwin Belofsky and his staff of assistants and wish him the best of luck for the coming year . . . 1940.

Max Shapiro



ADVERTISEMENTS

OUR SERVICE TO THE PROFESSION

has extended over a period of about Ninety-five Years and we are proud of our record.

We employ a staff of Equipment Specialists who are anxious to be of service to you in planning your future office, suggesting a suitable location, assisting in the selection of curtains, drapes, floor coverings and color schemes.

They will also supply accurate blueprints of your office which can be turned over to contractors for construction work.

These blueprints show plumbing details, electrical outlets, also partitions, etc.

We invite you to confer with one of our qualified representatives before completing details for your office. Many times they will offer suggestions that will minimize expense and make your office more efficient.

Our interest in your welfare does not cease when you have purchased your Equipment requirements as we are anxious to continue to serve you with daily needs of Merchandise, Gold & Teeth.

Come in and get acquainted and inspect our modern depot and methods for serving you.

THE S. S. WHITE DENTAL MFG. CO.

PITTSFIELD BUILDING
55 East Washington Street
CHICAGO

STYLE * BEAUTY * SIMPLICITY * CONVENIENCE *
FLEXIBILITY * ECONOMY

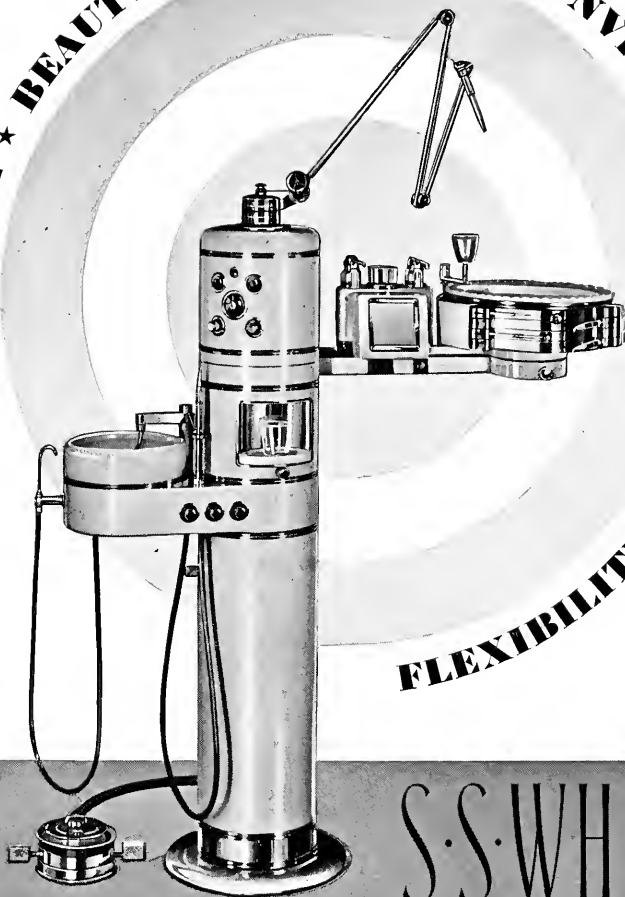

Ask your dealer about the S. S. White Easy Payment Plan and Free Office Planning Service, or write direct.

THE S. S. WHITE DENTAL MFG. CO.
211 S. 12th Street, Philadelphia, Pa.

S.S. WHITE
MASTER

The unit that has everything

1919-1939

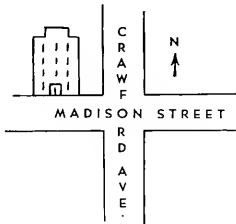

...*Illinois*...

DENTAL LABORATORY

4010 WEST MADISON STREET

NEVADA 0088

Great Lakes Linen Supply Co.

•
*Complete Rental
Service on*

TOWELS, COATS AND GOWNS

*for the
Dental Profession*

•
Plant: 36th and Parnell Avenue
Telephone: Boulevard 6300

Manufacturers of
Surgical and Dental
Specialties

•
FARA MFG. CO.

6773 Talcott Avenue
CHICAGO

•
PHONE NEWCASTLE 3820

GOOD

LUCK

TO

THE

CLASS OF 1939

Alexander Cassriel Co.

207 SOUTH WABASH AVE.

HAR. 5128

CHICAGO, ILL.



PROFESSIONAL SUCCESS



A well planned successful professional future calls for a thorough knowledge of the appliances that one must work and live with in the practice of dentistry in the years to come.

We can counsel you no more sincerely than to recommend that you investigate and thoroughly study the merits and values of the new WEBER line of dental equipment. There has been no finer dental equipment ever built than is offered you in the Weber line of today. It is sold by reputable dealers everywhere on very liberal terms and is fully guaranteed to meet every modern electrical and mechanical scientific development, and is prepared in design and priced to suit the most discriminating buyer.

All types of helpful services are yours for the asking.

The Weber Dental Manufacturing Co.

Crystal Park

CANTON, OHIO

Makers of Fine Dental Equipment and Cabinets

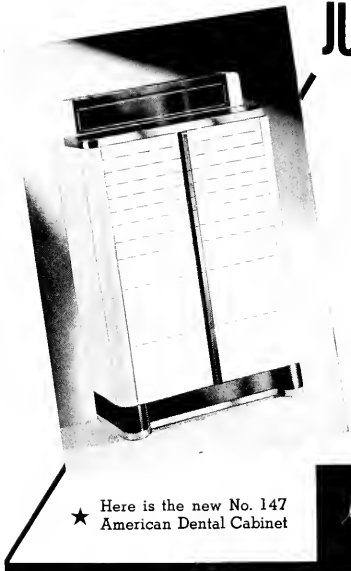

JUST ANOTHER OFFICE?

YOUR FIRST OFFICE . . . how will it look to your patients? Will it be in keeping with the modern, progressive dental techniques you have just successfully mastered . . . or will it be "just another office"? For an office that is different, new, and up-to-date, equip with AMERICAN. The new models, marvels of sanitation and efficiency, are available in any color you prefer . . . any one of them will be the "heart" of a fine, modern, different office.

THE AMERICAN CABINET CO.
TWO RIVERS WISCONSIN

★ Here is the new No. 147
American Dental Cabinet

American
DENTAL CABINETS

Headquarters for All Dental and Medical Books

used in

Chicago College of Dental Surgery

We have the largest and most complete Stock to be found anywhere.

Wide assortments of Notebooks, Blankbooks, Loose-leaf Covers, and Fillers, Drawing Supplies, Fountain Pens, and Inks, Brief Cases, Dissecting Sets, Laboratory Supplies
Prices Right

SPEAKMAN'S BOOK STORE

CONGRESS AND HONORE STREETS

(Next to Y. M. C. A. Hotel)

— USEFUL! —

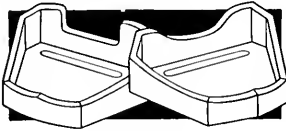

Columbia Rubber Model Formers

THE *easy* way to make *real* study models. Just pour plaster into model former and mount anatomical cast. The soft, pliable rubber permits easy removal of model, which comes out perfectly smooth and finished, with indented panel for patient's name and other data.

Upper and lower models made in these formers occlude automatically.

PRICE per set—1 upper and 1 lower
rubber model former—\$2.75.

COLUMBIA DENTOFORM CORP.
"The House of a Thousand Models"
131 EAST 23RD ST. NEW YORK, N. Y.

SCHNEIDER

Offers a Complete
Dental Laboratory
Service

Telephone
Central 1680

M. W. SCHNEIDER

Complete Dental Laboratory
55 E. Washington St. Chicago, Ill.

THE CONGRESS BARBER and BEAUTY PARLOR

Successfully Catering to the Doctors
and Students of this vicinity for the
past seven years.

In the Professional "Y" Building
"Just Inside the Door"

CHARLES E. RICHARDSON, Prop.

5 + 5 = No
Barbers Chairs Waiting

IT SPEAKS FOR ITSELF

I'M A PROVED
PRACTICE-BUILDER
— A FINE INVEST-
MENT, I'M EASY TO
OPERATE—EASY
TO OWN



● You'll profit from this sound advice: Get the full CDX story; it's backed with facts and figures based on its 16-year record in thousands of practices. Designed and built to produce the finest results, the CDX is a dependable, economical, practice-building aid to the successful practice of dentistry, especially to the young dentist establishing his practice.

**GENERAL ELECTRIC
X-RAY CORPORATION**

2017 JACKSON BLVD. CHICAGO 111, U. S. A.

BUILDING A SUCCESSFUL PRACTICE

Far seeing dental graduates appreciate that quality equipment means a satisfactory income. Ritter equipment is quality equipment—and a well chosen investment. Then too the Ritter Company is the only organization with a well organized plan to help you to quickly build a successful practice.



1. Graduate selects Ritter equipment . . . is surprised at small monthly payments.

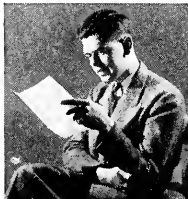

2. Ritter's Statistical Department recommends best locality for greatest opportunity.



3. Ritter representative personally gives the young dentist sound advice on specific problems.



4. Ritter's Architectural Service lays out his attractive and efficient office.



5. Ritter's Practice Building Service . . . Every two weeks, for a year and a half, this Service brings him the solutions of problems that are tried and proven methods of successful dentists.



6. Personal problems of Practice Building answered by competent practitioners associated with the Ritter Practice Building Service.

7. Ritter's Educational Division helps him build a profitable children's practice by advising him how to win them to his office.



8. THE RESULT: A profitable practice in but a fraction of the time required by "trial and error" methods—equipment quickly paid for out of the income that Ritter helped him make. The Ritter Dental Manufacturing Company, Inc., Ritter Park, Rochester, N. Y.

Start Right with Ritter



THIRTY YEARS OF FRIENDLY SERVICE

Thirty years ago our Company was founded by Dr. C. L. Frame, then a practicing dentist. Having been through the mill of practical experience he knew the economic and professional problems confronting the young graduate.

It was his ambition to build an organization capable of serving you and your colleagues with a helpful and sympathetic understanding as well as to merchandise the finest materials and appliances available.

During the past three decades a great many graduates of your school have honored our Company by selecting us as their dealer. We believe that, almost without exception, they will tell you that two things determined their choice. Quality merchandise of course but, more important still, they appreciated doing business with people who had a thorough understanding and sympathetic approach to the solution of their economic and supply problems.

We solicit your future patronage on the basis of quality merchandise and friendly cooperation.

C. L. FRAME DENTAL SUPPLY CO.

25 East Washington Street

Chicago, Illinois

DISTRIBUTORS OF ALL WELL KNOWN MAKES OF DENTAL SUPPLIES

INCLUDING

Ritter
Equipment

Caulk & S. S. White
Plastics

Dee & Ney
Golds

Trubyte Teeth
Steele's Facings

Cutwell & Bond
Burs

NO ONE EVER

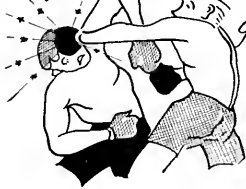

*got a black eye
using Gold!*

Your patient can never question your judgment when you plan and supply a gold restoration.

DEE Gold enjoys an enviable reputation based on years of highly dependable service. Say DEE to your laboratory and dealer.

Specify DEE Gold and when you have Old Gold to dispose of, send it to DEE & CO.

T H O M A S J.
DEE & CO.
Precious Metals
C H I C A G O

GENERAL OFFICES
PLANT & REFINERY
1900 W. KINZIE ST.
DOWNTOWN OFFICE
FIFTY FIVE EAST
WASHINGTON ST.

Our Best Means of Obtaining Business

WILL CONTINUE TO BE

THE RECOMMENDATION OF SATISFIED CUSTOMERS

GALLAGHER SERVICE INCLUDES

COOPERATION IN SECURING A GOOD LOCATION
PLANNING MODERN ARRANGEMENT OF OFFICE

NEW WEBER DENTAL EQUIPMENT

COMPLETELY RECONDITIONED EQUIPMENT—ALL MAKES
A CONVENIENT PLAN OF PAYMENT

HARRY U. GALLAGHER

Dental Equipment

37 So. Wabash Avenue
Phones: Central 3562-3563
CHICAGO

28 Years of Satisfactory Equipment Service



Heat Merchants
for
48 Years

"ONE TON OR A CARLOAD"

HAVE YOU TRIED



IN YOUR HOME?



Good Will

is the one and only asset that competition cannot under-sell or destroy. It is the reward of years of hard work and careful management. Fair dealings both with the customer and the employee plays an important part. **Quality** in materials and service must never be lost sight of. In short it is the net result of carefully following the **Golden Rule.**

Webster defines Good Will—The advantage in custom which a business has acquired beyond the mere value of what it sells

AMERICAN DENTAL COMPANY

Established 1900

LABORATORIES

Phone STATE 1642

5 South Wabash Avenue — Chicago, Illinois

AN IDEAL LABORATORY SERVICE

The aim of the Standard Dental Laboratories has always been:

To be first with the best prosthetic laboratory service.

That is why we pioneered Vitallium. We felt that it was to the best interest of the members of the profession whom we serve. Our judgment has been vindicated by the performance of Vitallium in over one million mouths.

That's why we have equipped our laboratory to process Austenal All Porcelain Dentures and Austenal Teeth by the Micromold Process. We sincerely believe that these dentures and teeth have an unprecedented future in dentistry.

That's why we offer to the dental profession one of the most complete laboratory services in Chicago including, Vitallium, Austenal Teeth, Austenal All Porcelain Dentures, plate work, gold dentures of all kinds, fixed bridges, porcelain jacket crowns, pontics, acrylic resin and condensate restorations of all types.

You can have confidence that you will obtain the very best prosthetic materials and the very finest craftsmanship at Standard.

• •

Standard Dental Laboratories, Inc.

185 North Wabash Avenue

CHICAGO, ILLINOIS

Dearbor 6721

IDENTIFY YOURSELF WITH A
YOUNG MEN'S CHRISTIAN AS-
SOCIATION. IT IS A WORLD-
WIDE MOVEMENT DEDI-
CATED TO THE CHRISTIAN
WAY OF LIVING.

PROFESSIONAL SCHOOLS

Y. M. C. A.

1804 Congress Street
CHICAGO, ILLINOIS
Seeley 7360

Compliments

of

LOGIN BROTHERS

DENTAL AND MEDICAL
BOOKS

SURGICAL INSTRUMENTS

1814 W. Harrison St.
Opposite Cook County Hospital
CHICAGO

COMPLIMENTS

OF

**DUDLEY'S
CAFETERIA**

BASEMENT
CHICAGO COLLEGE OF DENTAL
SURGERY

**FOSTER DENTAL FILMS
and
DENTAL FILM MOUNTS**

used exclusively by
Chicago College of Dental Surgery

N. W. FOSTER & SON
Morton Grove, Illinois

CHICAGO COLLEGE OF DENTAL SURGERY DENTAL SCHOOL OF LOYOLA UNIVERSITY

1757 West Harrison Street
CHICAGO

The Fifty-Seventh Annual Session Opens October 3, 1939

REQUIREMENTS FOR MATRICULATION

To meet the advanced requirements of dental education students entering the dental school must present entrance credits amounting to fifteen acceptable units, representing four years of high school work, and in addition thereto, two years, sixty semester hours of approved college credit which must include:

Chemistry	6 semester hours
Biology	6 semester hours
English	6 semester hours

The remainder of the requirement should include elective subjects intended to broaden the intellectual background of the student, an important essential in professional life. Recommended elective subjects are advanced courses in English, history, foreign language, economics, philosophy and social and political sciences.

Graduate Courses Offered in Selected Subjects

Address Registrar

CHICAGO COLLEGE OF DENTAL SURGERY DENTAL SCHOOL OF LOYOLA UNIVERSITY



Individuality the Mark of the
Successful Dentist

Your Patients Will Appreciate the
Individual Touch and Sanitation

Lily-Tulip Cup & Specialty Co.

317 No. Wells St.

Sup. 347g

PHONE STATE 2706

MASTER DENTAL COMPANY

- *We specialize in the construction of practical restorations.*
- *Thermotrol Castings Electrically Controlled.*
- *Full information, literature and price list upon request.*

162 NORTH STATE STREET
CHICAGO, ILLINOIS

ROOT STUDIOS

Est. 1889

185 No. Wabash Avenue



OFFICIAL PHOTOGRAPHERS

1936 DENTOS

1937 DENTOS

1938 DENTOS

1939 DENTOS

Special Rates to C. C. D. S. Students at All Times

**You will probably make
36,000 local anesthetic
injections during your
practicing years . . .**

When you consider the vast amount of local anesthetic injections you will make during your practicing years, it becomes obvious that even a slight variation in efficiency affects a large number of cases.

That's why we urge you to use Novol—the local anesthetic generally accepted as closest to the ideal.

Only Novol provides these advantages—

1. Solutions with pH above the critical acid value of the blood.
2. Cartridge container that permit a complete chain of sterile precautions from containers to the tissues.
3. Cartridges that reach you in vacuum packed tins to insure freshness.

NOVOCOL CHEMICAL MANUFACTURING CO., INC.

2921-23 Atlantic Ave.

TORONTO

— LONDON

— BUENOS AIRES

BROOKLYN, N. Y.

— RIO DE JANEIRO

Novol is the world's most extensively used local anesthetic!

COMPLIMENTS

OF

A FRIEND

A F R I E N D

Compliments of

MIKE BAUER
DENTAL LABORATORY

NEW ADDRESS

30 W. Washington

Telephones: Dearborn 8403—8404

"JAHN AND OLLIER AGAIN"

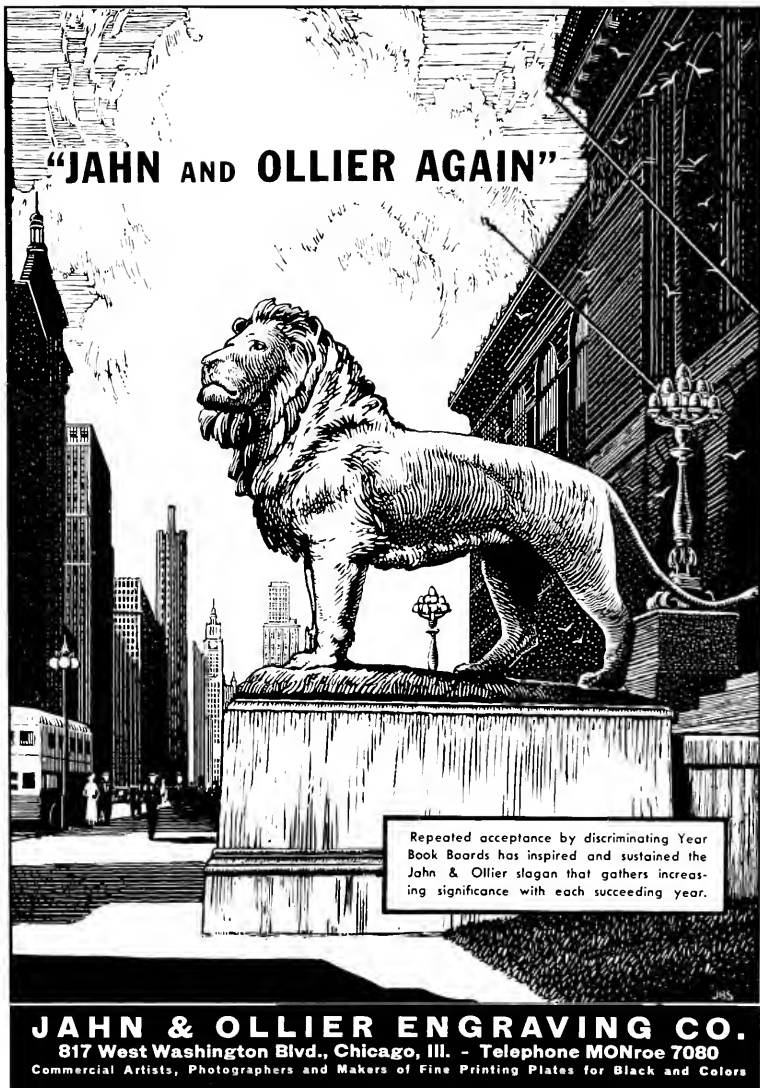

Repeated acceptance by discriminating Year Book Boards has inspired and sustained the Jahn & Ollier slogan that gathers increasing significance with each succeeding year.

JAHN & OLLIER ENGRAVING CO.
817 West Washington Blvd., Chicago, Ill. - Telephone MONroe 7080
Commercial Artists, Photographers and Makers of Fine Printing Plates for Black and Colors

ON MAINTAINING LEADERSHIP . . .

- To win and consistently hold a place as the recognized leader of school annual printing, has been the record of Rogers Printing Company since its beginning in 1908.
- That we have, during a period of 31 years, successfully produced over 700 annuals for schools throughout the country, attests our ability to completely satisfy the most discriminating Year Book Staff.
- New ideas, coupled with the knowledge and experience gained through a quarter of a century's service, insure the school which chooses a Rogers' printed book, of ideal pages "From Start to Finish".
- We are proud that the staff of this book entrusted its printing to our organization and we herewith present it as an example of our work.

ROGERS PRINTING COMPANY

307-309 First Street
DIXON, ILLINOIS

228 N. LaSalle Street
CHICAGO, ILLINOIS



NON
C

