

UC-NRLF



5B 18 184

GIFT OF  
DALILDA COTNEY



EX LIBRIS

MANE LIBRIS

PUBLIC  
HEALTH  
LIBRARY



Digitized by the Internet Archive  
in 2007 with funding from  
Microsoft Corporation

Dalinda Coley,

Logan, Utah.

1896

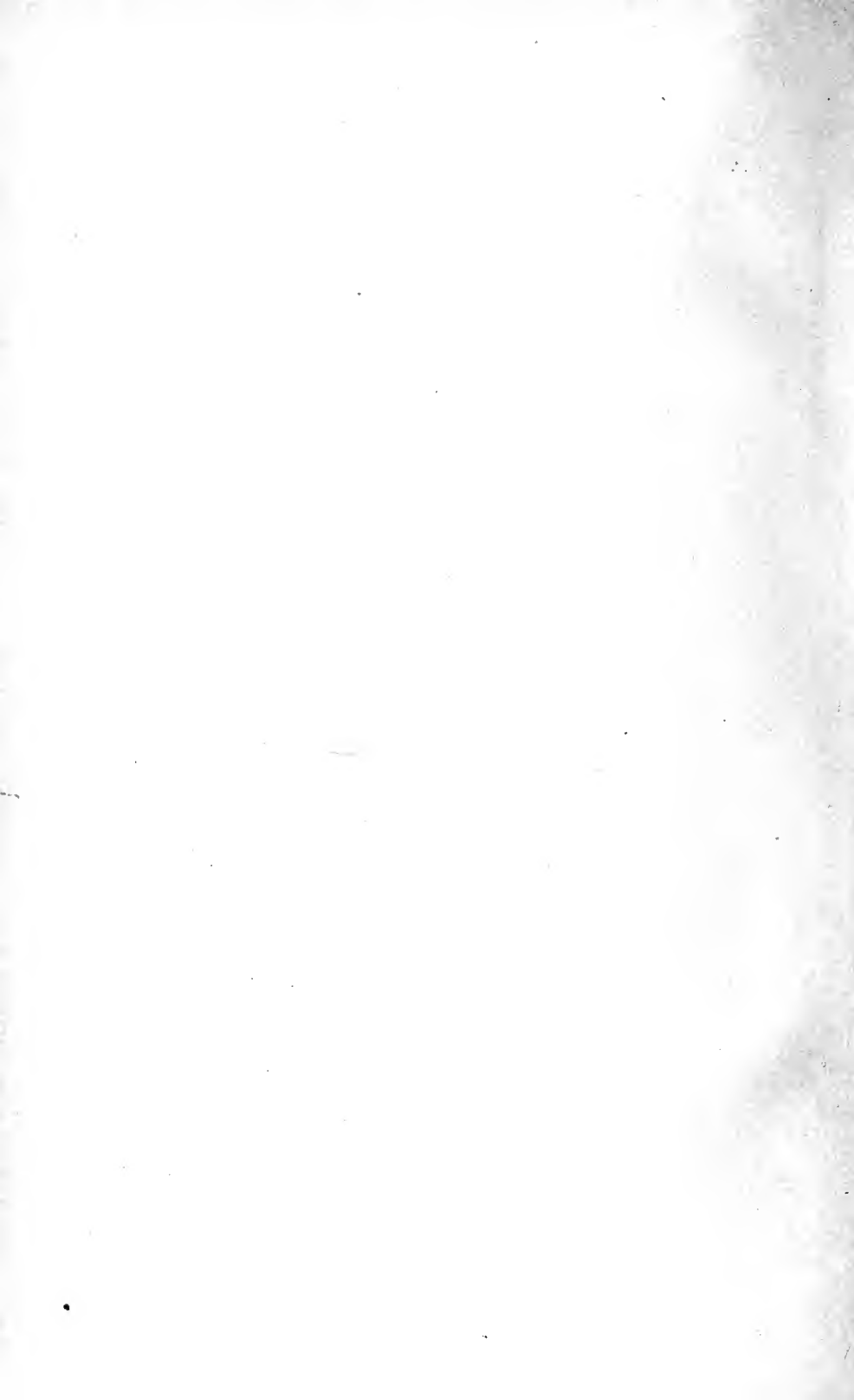

# DISINFECTION AND DISINFECTANTS:

THEIR APPLICATION AND USE

IN THE

## PREVENTION AND TREATMENT OF DISEASE,

AND IN

## PUBLIC AND PRIVATE SANITATION.

BY THE

COMMITTEE ON DISINFECTANTS,

APPOINTED BY

THE AMERICAN PUBLIC HEALTH ASSOCIATION.

11

LIBRARY OF  
COLUMBIA

Concord, N. H.

REPUBLICAN PRESS ASSOCIATION, 22 NORTH MAIN STREET.

1888.

117101

AS-

ZOOLOGY  
LIBRARY

PUBLIC  
HEALTH  
LIBRARY

PUBLIC  
HEALTH  
LIBRARY

Copyright, 1888.

By IRVING A. WATSON, SECRETARY AMERICAN PUBLIC HEALTH ASSOCIATION.

TO THE  
ASSOCIATION



NOTE.

---

This volume is the result of the labors of the COMMITTEE ON DISINFECTANTS, appointed by the American Public Health Association in October, 1884. The committee continued its researches, investigations, and experiments for three years, and made its final report in November, 1887.

Only by a careful study of this volume itself will the amount of work this committee performed, and its great value to the interests of health, be appreciated. The ability of the committee, composed of men all eminent in their professions, is a sufficient guaranty of the high character of this work. The original experimental investigations made by the committee are of the greatest importance and value, and render this the most complete and practical volume upon disinfection and disinfectants yet published.

This work was presented in three annual parts: hence the entire discussion of a given subject may not always be found in one place. A copious index has been prepared, by which all the matter pertaining to a specific topic may readily be found.

I. A. W.

REPORT  
OF THE  
COMMITTEE ON DISINFECTANTS.

1885.

---

COMMITTEE.

GEORGE M. STERNBERG, M. D.,  
Surgeon U. S. A.; Fellow by Courtesy in Johns Hopkins University.

JOSEPH H. RAYMOND, M. D.,  
Commissioner of Health of the city of Brooklyn, N. Y.

CHARLES SMART, M. D.,  
Surgeon U. S. A.; Member National Board of Health.

VICTOR C. VAUGHAN, M. D., PH. D.,  
Member Michigan State Board of Health.

A. R. LEEDS, M. D.,  
Member New Jersey State Board of Health.

W. H. WATKINS, M. D.,  
Medical Director of the Auxiliary Sanitary Association of New Orleans.

GEORGE H. ROHÉ, M. D.,  
Baltimore.

## INTRODUCTORY.

---

### GENERAL REPORT OF THE SECRETARY.

At the last annual meeting of the American Public Health Association, held in St. Louis, Mo., October 14-17, 1884, the following resolution was offered by Dr. James F. Hibberd, of Indiana, referred to the Executive Committee, and, after a favorable report by that committee, unanimously adopted by the Association :

WHEREAS, It is important, equally for practitioners of medicine, for boards of health, and for the general public, that the highest attainments of science in this department of sanitation should be formulated for easy reference by all who need it for practical application, and especially is this desirable in view of the probable visitation of cholera in the near future;—therefore be it

*Resolved*, by the American Public Health Association, That a committee be appointed to examine the subject of disinfectants, antiseptics, and germicides, in their relations to preventive medicine and sanitation, and that said committee formulate a table of these agents for the information of those interested, the agents to be classified, so far as may be deemed advisable, according to their specific virtues, facility of application, and economy of use.

In accordance with this resolution, the following committee was appointed by the president of the association :

Major George M. Sternberg, Surgeon U. S. Army, Fellow by Courtesy in the Johns Hopkins University, Baltimore ; Dr. Joseph H. Raymond, Professor of Physiology and Sanitary Science in Long Island College Hospital, and health commissioner of the city of Brooklyn ; Dr. Victor C. Vaughan, Professor of Physiological Chemistry in the University of Michigan, and member of the Michigan State Board of Health ; Major Charles Smart, Surgeon U. S. Army, and member of the National Board of Health ; Dr. W. H. Watkins, Medical Director of the Auxiliary Sanitary Association of New Orleans ; Dr. Albert R. Leeds, Professor of Chemistry in Stevens Institute of Technology, and member of the New Jersey State Board of Health ; and Dr. George H. Rohé, Professor of Hygiene in the College of Physicians and Surgeons, Baltimore.

The committee met immediately after appointment, and organized by the election of Dr. Sternberg as chairman and Dr. Rohé as secretary.

In order to be enabled to make an extended experimental research, the committee, after consultation, decided to appeal to municipal and state boards of health, and to other sanitary organizations, for financial aid. Responses to this appeal were encouraging ; and a statement of receipts and disbursements on account of this work is appended to this report.

At a meeting held in Baltimore on November 20, 1884, the committee

was divided into two sub-committees,—one, consisting of Drs. Sternberg, Smart, and Rohé, to examine the literature of disinfectants, and abstract and tabulate the results, and to investigate in an exact manner in the laboratory the relative germicidal value of the various substances used as disinfectants. The latter part of the inquiry was exclusively under the direction of Dr. Sternberg, the chairman of the committee, who was granted exceptional facilities for carrying on this work in the biological laboratory of the Johns Hopkins University. The committee would here take occasion to express to the trustees of the university its high appreciation of the courtesy and aid extended by them while these investigations were in progress.

The second sub-committee, consisting of Professors Raymond, Vaughan, and Leeds, and Dr. Watkins, was appointed especially to investigate the practical application of such disinfectants as are found efficient, upon a large scale, their cost, methods of use, chemical relations, effects upon furniture or fabrics, or their possibly poisonous effects upon human beings or animals.

Reports and papers from members of both of these committees will be found under the heading "Experimental Data" in the body of this report.

The therapeutic value of the various substances investigated does not properly come within the purview of the committee, and has consequently received no attention.

At the conference of state boards of health, which was held in Washington, December 11 and 12, 1884, a preliminary statement of the work then accomplished and contemplated was made; and in accordance with authority received from the executive committee of the American Public Health Association, a series of *preliminary reports* has been published during the present year, in a medical journal of wide circulation—the *Medical News*, of Philadelphia. To Messrs. Lea Bros. & Co., the publishers of the journal mentioned, the committee is indebted for substantial aid afforded in rendering the results of the committee's work promptly available to sanitarians and the public.

The compensation received for the papers published in the *Medical News* was kept as a separate fund to cover the cost of printing the report herewith submitted. A considerable deficiency has resulted, responsibility for which has been assumed by individual members of the committee.

GEORGE H. ROHÉ, *Secretary*.

#### FINANCIAL STATEMENT.

##### RECEIPTS.

From American Public Health Association, . . . . .	\$50.00
" H. Lomb, Esq., . . . . .	50.00
" W. G. Little, Esq., . . . . .	50.00
" Connecticut State Board of Health, . . . . .	50.00
" Illinois " " . . . . .	50.00
" Iowa " " . . . . .	50.00
" Louisiana " " . . . . .	25.00
" Massachusetts " " . . . . .	50.00

From Michigan State Board of Health, . . . . .	\$50.00
" New York " " . . . . .	50.00
" South Carolina " " . . . . .	25.00
" Wisconsin " " . . . . .	25.00
" Provincial Board of Health, Canada, . . . . .	25.00
" Boston " " . . . . .	25.00
" Brooklyn " " . . . . .	100.00
" Charleston " " . . . . .	25.00
" Pittsburgh " " . . . . .	25.00
" Sanitary Protection Association, Newport, R. I., . . . . .	10.00
" Members of the committee, . . . . .	12.15
Total, . . . . .	<u>\$747.15</u>

EXPENDITURES.

Laboratory expenses, . . . . .	\$264.18
Salary of assistants, . . . . .	400.00
Printing, binding, and mailing Preliminary Report, stationery, postage, express charges, and incidental expenses, . . . . .	<u>82.97</u>
Total, . . . . .	<u>\$747.15</u>

PRELIMINARY REMARKS BY THE CHAIRMAN OF THE COMMITTEE.

A complete investigation of both disinfectants and antiseptics being impracticable in the time and with the resources at command, the committee decided upon so far departing from the letter of the resolution under which it was appointed as to limit its investigations to the subject of disinfectants, properly so called, that is, to *those agents which are capable of destroying the infecting power of infectious material.*

In the experimental investigations made by the writer in the biological laboratory of Johns Hopkins University, the biological test of disinfecting power has been the only one employed. In applying this test a variety of micro-organisms have been subjected to the action of the various agents under trial, and the object in view has been to determine, within sufficiently narrow limits for practical purposes, the percentage in which these agents are capable of destroying the vitality of the test-organisms in a given time. This is determined by a series of experiments in which the agent being tested is used in a greater or less amount, according as it is found to fail, or to be effective. Failure is shown by the fact that the test-organisms grow in a suitable culture medium after having been exposed to the action of the disinfectant; on the other hand, failure to multiply in such a solution is evidence that the test-organisms have been killed. Further details with reference to the method will be found in the paper on "Commercial Disinfectants," and also in my paper published in the *American Journal of Medical Science*, April, 1883, in which I give the results of an extended series of experiments of a similar nature.

Experiments of this kind require a certain amount of technical skill, and a very great expenditure of time. Results which are recorded in a

single paragraph have often been reached only after making numerous experiments extending through days or even weeks.

It would of course be desirable to test each disinfecting agent upon a variety of pathogenic organisms; and there is no doubt that, within certain limits, differences in resisting power would be found. But this would be a task involving a still greater expenditure of time and money, and one which should follow the more general study which we have made.

The work already done is sufficient to justify the general statement, that *in the absence of spores, an agent which destroys the vitality of one micro-organism of the class to which known disease germs belong will destroy all other organisms of the same class, although not necessarily in the same amount, or in the same time.*

The fact that a certain agent destroys micrococci and bacilli without spores cannot, however, be taken as evidence that the same agent will destroy spores, for these reproductive bodies have a far greater resisting power; and certain chemical agents—*e. g.*, carbolic acid, sulphur dioxide—which are germicides, in comparatively small amounts, so far as micro-organisms in active growth are concerned, are quite impotent for the destruction of spores.

It has not been possible to make an exhaustive study of disinfectants, and the agents selected for experimental work have been chosen from a practical point of view, the object having been to fix as nearly as possible the value of those agents most relied upon by sanitarians for disinfecting purposes, and the conditions of successful disinfection with them.

GEORGE M. STERNBERG, *Chairman.*

---

## EXPERIMENTAL DATA.

### COMMERCIAL DISINFECTANTS. NO. I.

BY GEORGE M. STERNBERG.

In conducting the experimental investigations of the committee on disinfectants, the writer determined at the outset, in the interest of health officials and of the public, to ascertain the comparative values of the various commercial disinfectants in the market. In a recent paper by Wynter Blyth, medical officer of health for Marylebone, in which the commercial disinfectants, exhibited at the London Health Exhibition, are intelligently discussed, we find the following:

Rampant rides the quack in the fields both of preventive and remedial art. Quackery takes a well known common powder, labels it with a grand mystic name, selling bright copper at the price of gold. Quackery finds a stink outstinking feebler stinks, and gives it forth as a disinfectant. Of all the substances gathered together under the name of disinfectants—solids, vapors, gases, and odors—a small percentage alone possess any value.<sup>1</sup>

<sup>1</sup>*Med. Times and Gaz.*, London, Oct. 11, 1884.

This statement applies as well to many of the articles advertised as "disinfectants" in this country. But in justice to the manufacturers of these so-called disinfectants, we must say that many of them, which are of no use in the sense in which we use the term, are valuable as antiseptics or as deodorizers; and that there is good authority for calling a substance which will prevent putrefactive decomposition, or which will destroy bad odors, a disinfectant. Many chemists and physicians use the word in this sense; and this is the popular acceptance of the term both in this country and in Europe. We therefore cannot find fault with those manufacturers who see fit to use the word as synonymous with deodorizer or antiseptic; but we must caution the public that a disinfectant from this point of view does not necessarily destroy infectious material, and that the word is used by this committee in accordance with the definition given in the introduction to this report.

It has been proved that certain kinds of infectious material owe their infecting power to living micro-organisms, which in a general way are often spoken of as "germs." A disinfectant, therefore, which destroys this kind of infectious material may be called a *germicide*. If all infectious material owes its specific infecting power to the presence of living organisms, then, from our point of view, disinfectant and germicide are synonymous terms. But in the absence of satisfactory proof that such is the fact, we must consider the former term one of general application, while the latter is only applicable in those cases in which the infecting agent has been proved to be a germ. But in our tests of disinfectants we are obliged, for the most part, to depend upon experiments which determine germicide power, and in the experiments reported below, only biological tests have been used. As a matter of fact, those agents which by laboratory experiments have been proved to be the most potent germicides, have, by the experience of sanitarians, by tests upon vaccine virus, septicæmic blood, etc., been shown to be the most reliable disinfectants.

Evidently there can be no partial disinfection;—either the infecting power of the material to be disinfected is destroyed, or it is not. Where the object is to destroy disease germs in the sputum of patients with diphtheria, in the discharges of patients with typhoid fever, etc., so that no development shall occur when these germs find a proper nidus, incomplete destruction will be a waste of ammunition, for so rapid is the multiplication of these low organisms that the question of numbers is of secondary importance. It is therefore essential, in an experimental inquiry of this kind, that the most rigid tests may be applied, and that we keep on the safe side in the practical application of those agents which withstand these tests.

In our experiments below reported, the material which has served to test the germicide power of the agents named is "broken-down" beef tea, exposed in the laboratory for several days, and containing a variety of putrefactive bacteria and their spores. The spores of *Bacillus subtilis* are also invariably present in this stock; and when a certain agent is suc-

cessful in destroying all other micro-organisms, we frequently have in our culture-solutions a pure culture of this bacillus, which is noted for its abundant and wide distribution, and for the great resisting power of its spores. In order to meet the objection of those who are likely to cavil because no "disease germs" are present in the material mentioned, a culture of *Bacillus anthracis* containing spores is added to this stock solution. It is well known that anthrax spores constitute one of the most difficult tests of germicide power,—not more difficult, however, than the spores of *B. subtilis*. We may safely assume, then, that an agent which will destroy these spores will also destroy all known disease germs, and probably all organisms of this class, known or unknown. The micrococci and bacilli, not containing spores, are far more easily destroyed.

The time of exposure to the disinfecting agent in all of these experiments has been two hours. And the amount of material to be disinfected has, in every case, been made equal to the amount of the solution of the disinfecting agent under trial. Thus, to test an agent in the proportion of fifty per cent., a certain quantity—10 cc.—of the agent undiluted (100 per cent.) is added to an equal quantity of the broken-down beef stock described. If we wish to test the agent in the proportion of four per cent., an eight per cent. solution is made, and this is added to an equal quantity of the stock, etc. The mixture is placed in a wide-mouthed bottle containing 25 cc., and is set aside for two hours. A minute quantity of the material is then introduced into two little culture-flasks<sup>1</sup> (all experiments are made in duplicate) containing sterilized beef tea, and these are placed in the oven, which is kept constantly at a temperature of 36° to 38° C. (96.8° to 100.4° F.) My method has been explained in detail in a paper relating to an extended series of experiments of a similar nature, published in the *American Journal of the Medical Sciences*, for April, 1883.

These experiments on commercial disinfectants have been very carefully made, under my direction, by Dr. Duggan. The samples were, for the most part, obtained for me by Dr. Raymond, health commissioner of Brooklyn, and a member of the committee, in the cities of New York and Brooklyn. As the experiments are made in the interests of the public, special pains have been taken to secure samples such as are placed in the market; and the rule was adopted at the outset not to test samples sent to us by the manufacturers, but to purchase ourselves such packages as are offered for sale by druggists and other dealers.

Numerous experiments were made, but only those are recorded here which fix the limits between success and failure. In four instances, a failure occurred in the proportion of 50 per cent., *i. e.*, when the undiluted solution was added to an equal quantity of the test material. These agents were at once dropped without further trial. In the table, the agents are arranged with reference to their relative efficiency.

<sup>1</sup>The flasks used are all made in the laboratory, and are of the form described in the chapter on technology in my book, "Bacteria."



## LIST OF COMMERCIAL DISINFECTANTS TESTED.

Name upon Label.	Per cent. in which active.	Per cent. in which failed.
Little's Soluble Phenyle (Morris, Little & Co., Brooklyn), . . .	2	1
Labarraque's Solution ( <i>Liq. soda chlorinata</i> ); name of manufacturer not given, . . . . .	7	5
Liquor Zinci Chloridi (Squibb's), . . . . .	10	7
Feuchtwanger's Disinfectant (L. Feuchtwanger & Co., New York), . . . . .	10	8
Labarraque's Solution (From Fréré, Paris), . . . . .	15	10
Phenol Sodique (Hance Bros. & White, Philadelphia), . . . . .	15	10
Platt's Chlorides (Henry B. Platt, New York), . . . . .	20	15
Girardin Disinfectant (James Meyer, Jr., New York), . . . . .	25	15
Williamson's Sanitary Fluid (D. D. Williamson, New York), . . . . .	25	20
Bromo-chloralum (Bromo-Chemical Co., New York), . . . . .	25	20
Blackman Disinfectant (Blackman Disinfectant Co., New York), . . . . .	30	20
Squibb's Solution of Impure Carbolic Acid (about 2 per cent.), . . . . .		50
Burchardt's Disinfectant (J. H. Harty & Co., New York), . . . . .		50
Phenol Sodique (7 Rue Coq. Héron, Paris), . . . . .		50
Listerine (Lambert & Co., St. Louis), . . . . .		50

I append to this list the report made by Wynter Blyth (*loc. cit.*) upon certain commercial disinfectants exhibited at the London Health Exhibition :

*Various Tar-Acid Disinfectants.* Jeyes's perfect purifier, the concentrated carbolated creosote of Messrs. D. & W. Gibb, the kresylene described by Messrs. Mackay & Co. as a preparation of coal-tar creosote, pixene, and the thymo-cresol exhibited by Messrs. Ness & Co., have all the property of emulsifying with water. Jeyes's purifier was for some time tried in St. Marylebone urinals and drains, but the deposit left on the surface with which it had been in contact was found difficult to cleanse, and inconvenient. I have made some experiments on anthrax in the spore state with the "perfect purifier." The solutions used were 5 to 10 per cent.; the "fluff" had to be freed from the tenacious fawn-colored deposit by alcohol. The result was very similar to what might have been predicted from results of experiments on the pure tar-acids, viz., growth was a little delayed, but never destroyed.

Mr. James Wheeler's pixene I was, on the whole, favorably impressed with. He claims to have condensed the whole of the volatile constituents of pure tar, and to have presented them in a form readily miscible with water. \* \* \* Anthrax spores soaked in a ten per cent. solution did not grow for some time.

*Carbolic Acid Powders.* I have experimented on anthrax with Calvert's, Jeyes's, and McDougall's powders; but, even when a paste was made with the several powders, and the infected "fluff" allowed to remain therein twenty-four hours, no sterilization resulted.

Similar powders were obtained by our committee in New York and Brooklyn, but I have not thought it worth while to make any experiments with them, as sawdust or other material, saturated with impure carbolic acid or with the volatile constituents of tar, can have no great value in view of the low disinfecting power of these agents minus the sawdust. An agent which has gained considerable reputation in England is referred to as follows by Blyth :

*Sanitas.* Of all the substances introduced under the name of disinfectant, this is the most pleasant. Sanitas is chiefly in the form of sanitas oil and sanitas fluid: peroxide of

hydrogen, thymol, camphoric acid, and terebene enter into their composition. Of the numerous sanitas preparations, liquid and solid, the oil seems to be the most active. Nothing replaces or destroys so rapidly the unpleasant odor which tenaciously adheres to hands contaminated by offensive animal matters. It is also to be commended for use in stables, and as a corrective for dung-heaps, and of the sickly smell at times rising from the metropolitan wood pavement. I made many experiments with sanitas on anthrax. Spores soaked in sanitas fluid for twenty-four hours grew afterwards very freely. Spores placed in the undiluted emulsion, and afterwards removed, seemed at first to have their growth delayed; but in forty-eight hours growth commenced, and ultimately became luxuriant. The oil itself gave similar results. Sanitas powder was also tried, but with no better success.

Returning to the disinfectants in our list, it will be seen that all but the four last named are efficient in various amounts, ranging from 30 to 2 per cent. But the relative value of the agents as here given does not establish their comparative practical value as disinfectants. Questions of cost, physical and chemical properties, etc., come into the account, which it is the province of other members of our committee to consider.

We have nothing to say against the use of any of the agents in our lists as antiseptics or as deodorizers. No doubt all of them are more or less useful for this purpose, and we have no desire to restrict their use. But the exaggerated claims made in relation to the germicide or disinfectant power of certain of these agents, may do immense harm. Thus, one agent advertised as a "germicide" *par excellence*, "Pasteur's marvellous disinfectant," which failed *after two hours' exposure* to kill the organisms in our test solution in the proportion of 20 per cent. Yet this fluid is, by some contrivance, to be thrown into the water-closet of every germ-fearing citizen when he pulls the handle, so that it may catch the germs on the fly, and extinguish their power for mischief before they reach the sewers. On the whole, the proprietary disinfectants have turned out better than I anticipated; and any one of the eleven first named may be used in conformity with the conditions imposed by the experimental test for disinfecting sputum or excreta. For fecal matter, however, it will be best to employ an agent which is successful in the proportion of ten per cent.,—for example, in at least twice this strength, and in quantity considerably in excess of the material to be disinfected. It must be remembered, that in our experiments the germs are suspended in a fluid, and this is thoroughly mixed with the disinfectant.

The second agent in our list is the well known *liquor sodæ chlorinatae*.

Our experiments lead me to think that this time-honored disinfectant is worthy of more attention than it receives to-day, when so many other agents of inferior value are being pushed by enterprising manufacturers. Our two samples differ greatly in their disinfecting power, which depends upon the amount of sodium hypochlorite present. Dr. Duggan has prepared and experimented with a solution containing six per cent. of available chlorine, which proves to be efficient in the proportion of one per cent. I am informed that a solution containing two per cent. of available chlorine could be put in the market for less than forty cents per gallon. Whether this is to be the disinfectant with which we shall fight

cholera must be determined by my colleagues, who take up the question from a practical standpoint. But whatever agents are determined to be the best, must be so cheap that they may be obtained by the gallon, and used without stint. The time has passed when *pater familias* can complacently congratulate himself upon having disinfected his house with a bottle of carbolic acid, which he has brought in his vest pocket from the corner drug store.

In view of the efficiency and cheapness of the hypochlorites, I have requested Dr. Duggan to give special attention to these agents, and to prepare a report, embodying the results of his biological tests, and such information relating to the *modus operandi*, chemical characters, and available tests of strength, as may be useful to health officers and to the public.

---

### GERMICIDE POWER OF THE HYPOCHLORITES.

BY J. R. DUGGAN, M. D., PH. D.

In my previous work on commercial disinfectants, I found that the specimens of Labarraque's solution of sodium hypochlorite, although containing only a small quantity of this salt, were among the most effective in their action. On looking over the literature of the subject, I found that although this solution and that of the corresponding calcium salt (chloride of lime) were among the first used disinfectants, very little had been done to fix accurately their value. In order to determine this, I prepared standard solutions of sodium and calcium hypochlorites for use in the following experiments. The available chlorine, that is, the chlorine which enters into the constitution of the hypochlorites, was determined in these solutions by its oxidizing action on a standard solution of arsenious acid,—papers saturated with starch paste and potassium iodide being used to show an excess of the hypochlorite. The well known method of Dr. Sternberg was used throughout the investigation to determine germicidal value. The following solutions were prepared:

*Solution A.* Sodium hypochlorite made by passing chlorine gas into a solution of sodium hydroxide. Available chlorine = 6 per cent.

*Solution B.* Calcium hypochlorite made by passing chlorine gas into milk of lime. Available chlorine = 6 per cent.

*Solution C.* Calcium hypochlorite made by dissolving 100 grammes of bleaching powder (chloride of lime) in 1 litre of water, and filtering. Available chlorine = 2.4 per cent.

*Solution D.* Potassium hypochlorite made by passing chlorine gas into a solution of potassium hydroxide, and diluting until the available chlorine = 1 per cent.

The action of Solution A on spores of *Bacillus anthracis* was tried with the following result: 2 per cent. was effective in 30 minutes, 1 hour, and 2 hours; 1 per cent. failed in 1 hour, effective in 2 hours.

Solution B in 2 per cent. gave similar results. In 1 per cent. it was effective in both 1 and 2 hours.

Solutions A and B were both found to be effective in 5 per cent. and 1 minute's time on the organisms of broken-down beef tea. One half per cent. of these solutions failed to destroy in 2 hours organisms in broken-down beef tea, but 1 per cent. of Solution A was effective in the same time. One of the bulbs from a 1 per cent. solution of Solution B broke down, but the other remained clear. These solutions were also tried in 2 and 3 per cent. for 2 hours, and found effective.

Solution C was effective in 3 per cent., but failed in 1 and 2 per cent. in 2 hours.

Solution D was effective in 7 per cent., but failed in 5 and 6 per cent. in 2 hours.

In addition to these, we may mention a dilute solution of bleaching-powder of unknown manufacture. This contained .4 per cent. available chlorine, and was effective in 15 per cent., failed in 10 per cent.; time, 2 hours. The commercial specimens of Labarraque's solution, reported among the commercial disinfectants, showed about the same value in proportion to the available chlorine they contained. These latter experiments were all made on broken-down beef tea. That this contained spores as well as organisms was shown by the fact that tubes inoculated from the solution while boiling developed various bacilli. Of course, spores must have been present to resist this temperature.

While it has been thought well to use a pathogenic organism in some of these experiments, I am convinced, from recent works on the subject, that any agent that will destroy *Bacillus subtilis* will also destroy *B. anthracis*, and probably any other pathogenic organism.

The foregoing experiments show that a solution containing .25 of 1 per cent. (1 part to 400) of chlorine, as hypochlorite, is an effective germicide, even when allowed to act for only one or two minutes, while .06 of 1 per cent. (6 parts to 10,000) will kill spores of *B. anthracis* and *B. subtilis* in two hours. A simple calculation will show that all the solutions used were effective when diluted to about this strength, and failed a little below it. No better evidence could be had of the reliability of the excellent method of Dr. Sternberg for testing agents of this kind. These experiments were all made in duplicate, and they show a concordance which I am satisfied can be obtained by no other method with which I am acquainted.

The value of the various commercial preparations, such as Labarraque's solution and bleaching-powder (chloride of lime), of course depends on the amount of available chlorine they contain, since the chlorides and chlorates are of very little value as disinfectants. Bleaching-powder usually contains from 25 to 40 per cent. of available chlorine. For most purposes a solution containing 1 part of this preparation to 100 of water is strong enough, for this will contain from .25 to .40 of 1 per cent. of chlorine as hypochlorite. As is stated above, the smaller of these quantities is sufficient to destroy spores almost instantly. There

are very few purposes to which disinfectants are applied that are not fulfilled by this solution of 1 to 100 of bleaching-powder. It is not poisonous, does not injure clothing, bedding, etc., and is almost without cost, since bleaching-powder is worth only about five cents per pound. The sodium salt furnishes in some respects a more elegant preparation, since it leaves on evaporation sodium chloride, instead of the hygroscopic calcium chloride. If prepared according to the U. S. P., it does not keep very well; but when made by passing chlorine gas into a solution of an excess of caustic soda, it shows very little tendency to undergo decomposition.

Solution A, although rather concentrated, and frequently exposed to the light and air, has kept for a month without any appreciable change. A solution like this might be put on the market at a very reasonable price, and as it should be diluted with 20 parts of water, it would be far cheaper and more effective than any of the proprietary disinfectants. The odor of the hypochlorites is a slight objection to their use, but in dilute solution this is scarcely disagreeable. Where the odor is not to be regarded, the hypochlorous acid may be liberated by the addition of any common acid, thus increasing the oxidizing power, and liberating a most effective gaseous disinfectant. I hope to make further experiments on this point at an early day.

To fix the value of solutions of the hypochlorites, the following method is sufficiently accurate for ordinary purposes: A standard solution of potassium arsenite may be made by diluting seven parts of Fowler's solution with one and a half parts of water. This corresponds to a  $\frac{1}{2}$  per cent. solution of available chlorine. To apply the method, a given volume of the hypochlorite solution is measured out, and the arsenite solution added in small quantities. Between each addition the mixture is well stirred, and a drop taken out on a glass rod, and tested on a strip of paper saturated with iodide of potassium and starch paste, and dried. So long as any hypochlorite is present, the blue iodide of starch is formed; but when it has all been used up in converting the arsenite into an arseniate, the paper will remain colorless. As each volume of the potassium arsenite solution required for this corresponds to  $\frac{1}{2}$  per cent. of available chlorine, the calculation is very simple; *e. g.*, if one volume of the hypochlorite solution = 4.6 volumes of the arsenite solution, the amount of available chlorine present would correspond to 2.3 per cent. Since the preparations now on the market vary so much in the amount of chlorine they contain, this test should always be used to determine their value, and the amount of dilution required. Where the disinfectant is further diluted in use by being added to liquids or semi-solids, the original dilution should not be so great.

The hypochlorites possess the advantage over many of the metallic salts of not forming a coating of insoluble albuminoid matter around the solid or semi-solid masses, and thus protecting them from further action. On the contrary, when used in moderately strong solution they oxidize and disintegrate these materials. They are at the same time destroyed

themselves in the reaction, so that we are rid of germs, organic matter, and disinfectant all at the same time.

NOTE. The fact that the oxidizing disinfectants are destroyed in the reaction to which their disinfecting power is due, makes it necessary to use them in excess of the amount of organic material to be destroyed, otherwise germs included in masses of material not acted upon would be left intact in a fluid which is no longer of any value for their destruction; and as a few germs may be as potent for mischief as a large number, there would be a complete failure to accomplish the object in view. For this reason, the metallic salts, such as mercuric chloride, which are not destroyed by contact with organic material, have a superior value for the disinfection of masses of material left *in situ*, such as the contents of privy vaults and cesspools. In this case, even if germs enclosed in an envelope of the albuminate of mercury escape destruction, they will be prevented from doing mischief so long as they are included in such an envelope, and the wonderful anti-septic power of the agent used will prevent any development, probably for a sufficient length of time to insure the complete loss of vitality of any pathogenic organisms present.

GEORGE M. STERNBERG.

### COMMERCIAL DISINFECTANTS. No. 2.

BY GEORGE M. STERNBERG.

The following named "disinfectants" have been tested, under my direction, by my efficient laboratory assistant, Dr. A. C. Abbott, of Baltimore. The test in every case has been made upon "broken-down" beef tea, by the method heretofore described in detail.

Several of the disinfectants which stand at the head of the list contain the potent germicide, mercuric chloride, as shown by the simple test of introducing a polished piece of copper into the solution. A deposit of metallic mercury upon the surface of the copper shows at once the presence of a soluble salt of this metal. Those who have occasion to use disinfectants, the exact composition of which is not made public, will do well to bear this in mind, and to remember, also, that the germicide power of such solutions is neutralized by contact with lead, copper, or tin, and that lead pipes are injured by passing through them solutions of corrosive sublimate in any considerable quantity.

Name upon label.	Per cent. in which active.	Per cent. in which failed.
Dr. Martin's "Disinfectant No. 1" (contains mercuric chloride) . . . . .	2	1
"Thymo-cresol," English preparation, name of proprietor not given . . . . .	2	1
"Withers's Antizymotic Solution" (contains mercuric chloride) . . . . .	4	2
"Pasteur's Marvellous Disinfectant," <sup>1</sup> Blackman Disinfectant Co., of New York (contains mercuric chloride) . . . . .	4	2
"Purity," Egyptian Chemical Co., Boston . . . . .	40	20
"King Disinfectant," Humiston Manufacturing Co., New Haven, Conn. . . . .		50
"Sanguantræ," P. W. Manning, Stoneham, Mass., . . . . .		50
"Phenoline," Hance Bros. & White, Philadelphia . . . . .		50
"Golden Purifier," Thomas & Thompson, Baltimore . . . . .		50

<sup>1</sup> A preparation bearing the same name, reported upon in previous report upon commercial disinfectants, did not contain mercuric chloride, and failed at 20 per cent.

Name upon label.	Per cent. in which active.	Per cent. in which failed.
"Smith's Odorless Disinfectant," the Louis Smith Co., New York . . . . .		50
"Disinfecting Powder," G. L. Kidwell, Georgetown, D. C. . . . .		50
"Thymo-cresol Powder," English preparation, name of proprietor not given . . . . .		50
"Chloridium," Chemical Vaporizer and Deodorizer Co., of New York . . . . .		50
"Carbolcrystal Disinfectant," H. H. Childs, proprietor . . . . .		50

Dr. Abbott has also tested for me the different preparations of chloride of lime, and of Labarraque's solution, which we have been able to obtain in the Baltimore market, with the following result :

CHLORIDE OF LIME.	Per cent. of available chlorine.
Brookman Manufacturing Co., Chicago . . . . .	33.50
Risley & Co., New York . . . . .	28.40
Rock Hill Alkali Co., Liverpool . . . . .	28.00
Clagett Bros. . . . .	24.10

LABARRAQUE'S SOLUTION (LIQUOR SODÆ CHLORINATÆ).

Reed & Carnrick, New York . . . . .	3.80
Parke, Davis & Co., Detroit, Mich. . . . .	2.75
Powers & Weightman, Philadelphia . . . . .	2.62
Hance Bros. & White, Philadelphia . . . . .	0.35
Alonzo L. Thompson, Baltimore . . . . .	0.013

NOTES.<sup>1</sup>

BY THE CHAIRMAN OF THE COMMITTEE.

My attention has just been called to an advertisement of "Withers's Antizymotic Solution," in which it is stated that it is endorsed as the best by George M. Sternberg, M. D., Surgeon U. S. A.

I have never authorized the use of my name in connection with this or any other proprietary disinfectant. The only reference I have ever made to "Withers's Antizymotic Solution" is in the report on "Commercial Disinfectants," No. 2,<sup>2</sup> published in the *Medical News* of June 13th, where this has the *third* place in a list of fourteen commercial disinfectants, tested under my direction by Dr. Abbott. The remark is made, "Contains mercuric chloride." As a simple solution of mercuric chloride of 1 : 500 would be quite as efficient as a 4 per cent. solution of this disinfectant, the extravagant claims made for it are without foundation. The assertion that it is endorsed by me "as the best" is untrue.

*Labarraque's Solution.* I have received the following letter from a well known and reputable firm of manufacturing chemists :

<sup>1</sup> *Medical News*, Sept. 5, 1885.

<sup>2</sup> See ante, p. 16.

In the *Medical News* (Philadelphia) for June 13th we find a continuation of the Preliminary Report of the Committee on Disinfectants, including a report on the relative percentage of available chlorine in samples of different manufacturers of Labarraque's Solution. As you are doubtless aware, Labarraque's Solution is a very unstable preparation; and, although made with every possible care, will surely deteriorate by age. With such an article it is manifestly unfair to institute comparisons between different makers, without regard to the freshness, or otherwise, of the samples. To the unthinking reader, the bald statement that one preparation contains 3.8 per cent., and another only .013 per cent., is calculated to convey the impression that the preparation which contained so small a percentage has been improperly made (while really, when fresh, its percentage might have been greater than the highest named); and such an impression would naturally create a prejudice against the manufacturer, and, unfortunately, not be limited to the particular article mentioned.

I recognize the fact that the unthinking reader might make an inference unfair to the manufacturer, from the perusal of a "bald statement" such as is published in the table on page 659 of the *News*. I regret this, and will in future gladly give the date of manufacture, if the manufacturers will stamp it upon the bottle. As I propose to obtain new samples from time to time, and to publish the results of tests as to available chlorine, it may happen that the aggrieved manufacturers in this instance will come out at the head of the list next time. But these tests are made especially in the interests of the public, which, from my point of view, are superior to those of the manufacturers; and it is evident that great harm might result from reliance upon the disinfecting power of a liquid labelled "Labarraque's Solution," which contained only .013 per cent. of available chlorine. The fact that it was of full strength when first manufactured does not add to its value as a disinfectant for the excreta of a patient with cholera or typhoid fever. If the manufacturers will stamp the date of manufacture upon the label attached to each bottle, I will publish it, in future, in connection with the result of the tests to determine available chlorine present in the solution.

---

#### POTASSIUM PERMANGANATE.

BY GEORGE M. STERNBERG.

In my experiments made in Baltimore in 1881<sup>1</sup> it was found that a 2 per cent. solution of potassium permanganate was required to destroy the virulence of septicæmic blood, the test of disinfection being inoculation into healthy rabbits. In experiments made in San Francisco in 1882<sup>2</sup> it was found that .12 per cent. (=1:833) destroyed the micrococcus of pus in culture solutions. As the virulence of the blood in the first experiments was demonstrated to be due to the presence of a micrococcus which has, as a rule, less resisting power for chemical agents than has the micrococcus used in the second series of experiments, it

<sup>1</sup>"Bulletin National Board of Health," July 23, 1881; also, "Studies from Biological Laboratory of Johns Hopkins University," vol. ii, No. 2.

<sup>2</sup>*Am. Journal of the Medical Sciences*, April, 1883.



may be thought that these results are contradictory. This is not, however, the case, and the wide difference as to the quantity of the disinfecting agent required in the two series of experiments depends upon an essential difference in the nature of the fluid in which the germs to be destroyed were contained. The large amount of organic material present in the blood as compared with that in the culture fluid used in the second series of experiments fully accounts for the difference, for the disinfecting agent is itself quickly destroyed by contact with organic matter; and, indeed, its disinfecting power depends upon this instability of composition, and upon the oxidation of organic material with which it comes in contact.

This difference in the result, due to a difference in the amount of organic matter present in the material to be disinfected, is further exemplified in the following experiments:

November 26, 1884, a single drop of a pure culture of micrococcus of pus was subjected to the action of potassium permanganate for two hours, in the proportion of 1 part to 500, and in the proportion of 1 part to 1,000. Four culture-tubes containing a sterilized solution of beef-peptone were inoculated with the micrococci thus exposed (it is my practice to make every experiment in duplicate), and were placed in a culture-oven maintained at 38° C. (100.4° F.) for forty-eight hours. No development occurred in either of the tubes.

On the 29th of November a similar experiment was made with a culture solution containing both micrococci and bacilli. In this experiment there was no development of the micrococci, but the bacilli developed abundantly after exposure to the 1:1000 solution. No development of bacilli (*B. subtilis*) occurred, however, after exposure to 1 part in 250. In these experiments the permanganate, although in dilute solution, was not neutralized by the small amount of organic material contained in the drop of the culture fluid exposed to the action of the germicide agent. In the following experiments the conditions were varied, and a larger proportion of the permanganate failed to exert any germicide power.

November 24 equal parts of a .4 per cent. solution (1:250) of potassium permanganate and of "broken-down" beef tea were mixed in a germ-proof receptacle, and allowed to stand for two hours. Two culture-tubes were then inoculated with a minute drop of the mixture, and were placed in the oven. At the end of twenty-four hours an abundant development of putrefactive bacteria had taken place. In this experiment, then, we have a failure in the proportion of 1:500, but the experiment does not in the least invalidate those previously reported. The truth is, that in making the above mixture the permanganate is almost instantly decomposed by the excess of organic matter, while in the experiments in which a single drop of culture-fluid containing micrococci was introduced into a more dilute solution, there was still an excess of the permanganate, as shown by the color of the solution at the end of two hours. Having determined the germicide power of the permanganate

for micrococci, at least for one species of *micrococcus*, I desired to know whether the oxidizing power of this reagent, when present in excess, would destroy the spores of anthrax, which are recognized as furnishing one of the most difficult tests of germicide power. The following experiments have been recently made :

November 24 a drop of culture fluid containing an abundance of anthrax spores, a pure culture, was added to a considerable quantity of a .4 per cent. (1 : 250) solution of potassium permanganate. After two hours two culture-tubes were inoculated with a minute quantity of this material. These tubes were placed in the culture-oven, and the following morning contained an abundance of anthrax bacilli.

November 27 the above experiment was repeated, except that the time of exposure was extended to four hours. Again there was an abundant development of anthrax bacilli in the culture-tubes, showing that the spores had resisted ; but in one tube the development was delayed, and it was only on the morning of the second day that flocculi of *bacillus anthracis* commenced to appear.

December 2 the experiment was repeated, with the exception that the time of exposure was extended to four days. The bacillus now failed entirely to develop in the culture-tubes, showing that the spores had been killed by this long exposure.

It is probable that in experiments in which the permanganate is present in excess, the amount present is of less importance than the time of exposure, and that a stronger solution would fail to destroy anthrax spores in a considerably shorter time. The resisting power of anthrax spores to this reagent is shown by these experiments to be greater than that of the spores of *B. subtilis*. This is true also of chloride of zinc, and no doubt of certain other chemical agents. On the other hand, the spores of *B. subtilis* have a greater resisting power for heat. These differences in resisting power show that it will be necessary to exercise due caution in applying the data obtained in experiments upon one pathogenic organism in our practical efforts to disinfect material containing a different organism.

According to Arloing, Cornevin, and Thomas, a 5 per cent. solution destroys the fresh virus of symptomatic anthrax, but has no effect upon the dried virus.

One per cent. was found by Koch not to destroy the spores of anthrax, but in the proportion of 1 : 3000 the development of these spores was retarded.

The experiments of De la Croix, like those of Miquel, have reference especially to the antiseptic power of the agents tested by him. He makes the statement, however, that one part of potassium permanganate in thirty-five kills the bacteria of broken-down beef tea. This statement is no doubt true under the conditions of his experiment ; but, as I have shown, the result depends upon the time of exposure and the amount of organic matter present quite as much as upon the proportionate amount of permanganate with reference to the quantity of fluid operated upon.

If we add one gramme of permanganate to a litre of broked-down beef stock, it is quickly decomposed, and no germicide effect is produced; but if we add one drop of putrid beef tea to a litre of distilled water containing one gramme of permanganate, the organic matter, and the germs as well, contained in this drop of fluid are quickly destroyed by oxidation.

Several English investigators—Notter,<sup>1</sup> Calvert,<sup>2</sup> and Tripe<sup>3</sup>—have attempted to determine the value of potassium permanganate as a “disinfectant;” but the methods employed have not been such as could give satisfactory and definite results, although these earlier experiments demonstrated the value of this agent as an antiseptic and deodorizer.

Other English investigators—Baxter,<sup>4</sup> Braidwood, and Vacher<sup>5</sup>—have adopted a different test, and their results are interesting and valuable.

These gentlemen operated upon vaccine lymph, and the test of disinfection was the failure of this lymph to produce characteristic vesicles upon the arms of children not previously vaccinated. Comparative experiments were made in each case with lymph not subjected to the action of the disinfectant.

In Baxter's experiments 1 part in 200 was successful in destroying the specific virulence of vaccine lymph; and in those of Braidwood and Vacher a like result was obtained by adding two drops of a solution of 1 : 120 to “a tube of lymph.”

From what has been said, it is evident that while potassium permanganate has decided germicide and antiseptic power, it is not generally applicable for purposes of disinfection, because of the readiness with which it is decomposed by organic matter. It is, however, a prompt and valuable deodorizer.

---

## HYDROGEN PEROXIDE.

BY GEORGE M. STERNBERG.

Since Angus Smith, in 1869, proclaimed his belief that peroxide of hydrogen was to be the disinfectant of the future, sanitarians have been waiting for chemists to devise some method by which this agent may be manufactured at a sufficiently low price to bring it into general use. The absence of any corrosive or poisonous properties, or of any objectionable odor, and the promptness with which this agent destroys volatile putrefactive products and arrests putrefactive decomposition, seemed to make it the disinfectant *par excellence*. But we no longer accept the arrest of putrefactive decomposition or the destruction of bad odors as

<sup>1</sup> Dr. J. Lane Notter, “Dublin Journal of Medical Sciences,” vol. lxxviii (1879), p. 196.

<sup>2</sup> Dr. Grace Calvert, “Chemical News,” London, vol. xxii (1870), p. 281.

<sup>3</sup> Dr. John W. Tripe, “Sanitary Record,” London, vol. ii (1881), p. 201.

<sup>4</sup> Dr. E. B. Baxter, “Report on the Experimental Study of Certain Disinfectants.” “Report Medical Officer Privy Council,” etc., N. S. No. vi (1875), p. 216.

<sup>5</sup> “British Medical Journal,” London, vol. ii (1876).

evidence of disinfecting power, and the question which here concerns us relates to the power of this agent to destroy germs.

The following experiments have been made by Dr. Duggan and myself with a solution of hydrogen peroxide prepared under the direction of Prof. Albert R. Leeds, a member of the Committee on Disinfectants. When first received from Dr. Leeds this solution contained 4.8 per cent. of  $H_2O_2$ , and 5 per cent. of sulphuric acid. At the expiration of a month the amount of hydrogen peroxide was again estimated by Dr. Duggan, and was found to be 3.98 per cent. Five weeks later the proportion was reduced to 2.4 per cent. The constant escape of oxygen at the temperature of the laboratory is shown by a continuous flow of minute bubbles from the interior of the liquid to its surface. Tested upon broken-down beef tea, when the proportion of  $H_2O_2$  was 3.98 per cent. (say 4 per cent.), the solution was found to be active in the proportion of 30 per cent., while it failed in the proportion of 20 per cent.; that is to say, 1.2 per cent. of  $H_2O_2$  in two hours' time destroyed all the organisms present in the broken-down beef stock, and .8 per cent. failed to do so. Tested upon a pure culture of *B. anthracis* containing spores, the same solution was effective in 20 per cent. (.8 per cent.  $H_2O_2 = 1 : 125$ ), and failed in 10 per cent. Tested upon a pure culture of a micrococcus, obtained from a drop of blood drawn from the inflamed area in a case of vaccinal erysipelas, the same solution was effective in the proportion of 10 per cent. (.4 per cent. of  $H_2O_2 = 1 : 250$ ), and failed at 5 per cent. In experiments made at a later date (March 28), when the strength of the solution was reduced to 2.4 per cent., *micrococcus tetragenus* was destroyed by 10 per cent. (.24 per cent.  $H_2O_2 = 1 : 400$ ), while the same amount failed to destroy the vitality of the micrococcus of pus,—pure culture obtained from an acute abscess,—showing a difference in the resisting power of these two organisms.

As the solution used in these experiments contained 5 per cent. of sulphuric acid, which in a previous series of experiments<sup>1</sup> has been shown by the writer to be fatal to the micrococcus of pus in the proportion of 1 : 200, it is evident that a failure to destroy the vitality of the same micrococcus in 1 : 400 does not give this solution any very notable advantage over a simple aqueous solution of sulphuric acid. The germicide power of the solution used, as tested by its action upon spores, is, however, considerably above that of sulphuric acid alone. Dr. Duggan has ascertained that to destroy all of the organisms in broken-down beef tea requires 8 per cent. of  $H_2SO_4$ , whereas 30 per cent. of our solution of  $H_2O_2$ , containing 5 per cent. of sulphuric acid ( $= 1.5$  per cent. of  $H_2SO_4$ ), is effective.

These experiments indicate that unless chemists can furnish us solutions which are more concentrated and which will keep better, we are not likely to derive any great practical benefit from the use of hydrogen peroxide as a disinfectant.

As an antiseptic, our solution was found by Dr. Duggan to be effective

<sup>1</sup> *American Journal of the Medical Sciences*, April, 1883.

in the proportion of 1 : 5000 (of  $H_2O_2$ , not of the dilute solution), and to fail in the proportion of 1 : 10,000. This does not correspond with the results reported by Miquel, who places hydrogen peroxide—*eau oxygenee*—above mercuric chloride as an antiseptic. In his table of the minimum amount of different antiseptic agents which will prevent the putrefaction of one litre of neutralized beef tea, the quantity of  $H_2O_2$  required is stated to be .05 gramme (1 : 20,000), while the amount of mercuric chloride required to accomplish the same results is given as .07 gramme (= 1 : 14,285).

---

## CHLORINE, BROMINE, AND IODINE.

BY GEORGE H. ROHÉ.

*Chlorine.*—The most thorough and exact research into the disinfectant powers of chlorine on record is that made by Fischer and Proskauer, and published in the second volume of *Mittheilungen aus dem Kaiserlichen Gesundheitsamte*. The material tested consisted of the spores of bacillus anthracis, spores of the various forms of bacilli found in ordinary garden soil, micrococcus tetragenus, micrococcus prodigiosus, bacillus of septicæmia of mice, bacillus of septicæmia of rabbits, aspergillus nigriscens and aspergillus ruber, micrococcus of erysipelas, sputum of tuberculosis, bacillus anthracis, bacterium of fowl cholera, and various other non-pathogenic micro-organisms.

The observations were made both in dry air and in air artificially moistened, and the objects to be disinfected were sometimes exposed in a dry, sometimes in a moist, condition. The concentration of the gas varied from 1 part in 25,000 to 1 part in 2½. The time of exposure in the different experiments varied from one to twenty-four hours.

Anthrax spores, when thoroughly desiccated and exposed to the action of a dry chlorine atmosphere containing 44.7 parts of chlorine in 100, resisted the disinfectant action of the agent completely for one hour. After three hours' exposure, germination was still free, but somewhat retarded. After twenty-four hours' exposure, disinfection was complete, the vitality of the organism being entirely destroyed.

When the air in the experimental chamber and the spores were moistened, one hour's exposure to an atmosphere containing 4 per cent. of chlorine was sufficient to produce complete disinfection. If the exposure was continued for three hours, 1 per cent. of chlorine was an efficient disinfectant; and if the spores were exposed for twenty-four hours, the effective proportion of chlorine could be still further reduced if the air and objects to be disinfected were first rendered moist.

Bacillus anthracis itself was killed in moist air, if chlorine was present, in the proportion of 1 part in 2,500 after twenty-four hours' exposure. Even with such a minute proportion of chlorine as 1 part in 25,000, the development of the organism was scanty and retarded.

Spores of the various forms of bacilli found in ordinary garden soil proved a little more resistant to the action of the chlorine. When the air in the experimental chamber was very moist, however, the presence of 1 per cent. of chlorine, and upward, rendered the spores incapable of development after three hours' exposure. When the chlorine strength was 4 per cent., one hour's exposure was sufficient to destroy the germinative power of these spores.

*Micrococcus tetragenus* was killed in moist air by the presence of so small a proportion of chlorine as 1 in 25,000, if the exposure was prolonged to twenty-four hours. Exposure for less than three hours was not sufficient to destroy the life of the organisms in all cases.

*Micrococcus prodigiosus*, and several other varieties of pigment-forming micrococci, showed themselves generally more resistant to the disinfectant than *micrococcus tetragenus*. In other respects they behaved similarly, exposure for upward of three hours being sufficient to destroy them in the presence of over 4 per cent. of chlorine.

*Aspergillus nigrescens* and *aspergillus ruber* were rendered incapable of further growth by exposure for one hour to moist air containing 1 part of chlorine in 25,000.

*Micrococcus* of erysipelas was killed by three hours' exposure to moist air containing 1 part of chlorine in 2,500, or twenty-four hours' exposure to air containing 1 in 25,000.

*Bacillus* of septicæmia of mice was killed by exposure to an atmosphere containing from 3 to 40 parts of chlorine in 1,000. The presence of 5 parts in 1,000 was effective after one hour's exposure in a moist atmosphere.

*Bacillus* of septicæmia of rabbits was killed by an exposure of twenty-four hours to 5 parts in 1,000, and after one hour's exposure to 40 parts in 1,000, but retained its infective properties after one hour's exposure to 5 parts in 1,000.

Tuberculous sputum was disinfected after one hour's exposure to an atmosphere containing 5 parts of chlorine in 1,000.

Bacterium of fowl cholera was destroyed after exposure for twenty-four hours to a moist atmosphere containing 1 part of chlorine in 25,000.

Dr. G. M. Sternberg (*Report National Board of Health*, 1880, p. 320) tested the effect of chlorine upon dried vaccine lymph and the microorganisms of putrid urine. Six hours' exposure of vaccine lymph, dried upon ivory points, to an atmosphere containing 1 part of chlorine in 200 was sufficient to destroy the infective property of the lymph, as tested by subsequent inoculation. In one experiment five points were exposed to an atmosphere containing 1 per cent. of chlorine. Of these, four were disinfected, while the fifth furnished a satisfactory vaccine vesicle. The failure in this case is explained by Dr. Sternberg by the assumption of an unusually thick coating of dried lymph. In these experiments control-inoculations with non-disinfected virus from the same packages were made in all cases.

The bacteria of putrid urine were destroyed after six hours' exposure to an atmosphere containing 1 part of chlorine in 400.

Braidwood and Vacher ("Report of Life-History of Contagium," *British Medical Journal*, 1876, vol. ii) mixed liquid vaccine virus with equal parts of liquor chlori (B. P.), and completely destroyed the infectivity of the vaccine. The time of exposure is not stated.

Dr. E. B. Baxter (*Report of Medical Officer Privy Council*, 1875), tested the effect of chlorine on liquid and dry vaccine, and on the "virus of infective inflammation." The infectivity of the latter was destroyed by the presence of 8 to 15 parts of chlorine in 10,000. The time of exposure to the action of the disinfectant is not stated. The experiments of Dr. Baxter on vaccine lymph are not detailed with sufficient exactness to allow trustworthy conclusions to be drawn. He states, however, that "unless the chlorine was present in sufficient quantity to render the lymph acid, it had no effect."

Koch (*Mittheilungen a. d. Kais. Gesundheitsamte*, Bd. I, p. 263) found that anthrax spores lost their power of development when immersed for twenty-four hours in chlorine water.

Fischer and Proskauer, in addition to testing the influence of chlorine on micro-life, also exposed a number of fabrics, colored leather, and wearing apparel to the action of this agent. All the colored articles were either bleached or much altered in color. They conclude their elaborate memoir with the following observation:

*Disinfection with chlorine is attended by great inconvenience on account of the rapid evolution of the gas from the chlorinated lime and hydrochloric acid when mixed, and the very irritant action of the gas upon the mucous membrane of the larynx and of the eyes. Clothing is also liable to be discolored by the action of this disinfectant.*

*Bromine.*—Fischer and Proskauer (*ibid.*) also studied the effect of the vapor of bromine upon spores of bacillus anthracis, spores of garden soil bacilli, tuberculous sputum, bacillus anthracis, micrococcus prodigiosus, micrococcus tetragenus, micrococcus of erysipelas, aspergillus nigrescens, aspergillus ruber, and several other non-pathogenic organisms.

After an exposure of three hours in a dry atmosphere containing 3 parts of bromine vapor in 100, the anthrax bacillus, tuberculous sputum, and both aspergillus species were entirely disinfected. The spore-bearing organisms and the non-pathogenic micrococci retained their power of development, although generally in a diminished degree. After moistening the air in the experimental chamber to the greatest attainable degree, three hours' exposure to an atmosphere containing 1 part of bromine in 500 acted as a thorough disinfectant; if the exposure was prolonged to twenty-four hours, 1 part in 3,500 was efficient. When the proportion of bromine was reduced to 1 part in 16,000, exposure for twenty-four hours failed to disinfect spore-bearing organisms.

Upon the whole, bromine did not prove as prompt a disinfectant as chlorine, besides being very difficult and dangerous to handle.

Koch<sup>1</sup> found a 2 per cent. aqueous solution of bromine effective against anthrax spores after twenty-four hours' exposure.

<sup>1</sup> Loco cit.

*Iodine.*—The disinfecting power of iodine has been determined by Dr. G. M. Sternberg (*American Journal of the Medical Sciences*, April, 1883). He experimented upon the micrococci of pus and of septicæmia, bacterium termo, and the organisms found in broken-down beef tea. An exposure of two hours to the disinfectant in solution, in the proportion of 1 in 500, was effective in destroying the vitality of all of these organisms.

Salmon (*Report of United States Department of Agriculture*, 1883) experimented on the micrococcus of fowl cholera, and found iodine an efficient disinfectant in the proportion of 1 part in 1,000.

A solution of iodine in water (strength not given) was found by Koch<sup>1</sup> to destroy the spores of *B. anthracis* after twenty-four hours' exposure.

Summing up briefly our knowledge upon this subject, the following conclusions seem to be justified :

1. Chlorine is an efficient disinfectant when present in the proportion of 1 part in 100, provided the air and the objects to be disinfected are in a moist state, and the exposure continues for upwards of one hour.
2. Chlorine, when used in sufficient concentration to act as a trustworthy disinfectant, injures colored fabrics and wearing apparel.
3. Bromine is an efficient disinfectant in the proportion of 1 part in 500, provided the air be in a moist state, and the exposure continues for upwards of three hours.
4. Iodine, in solution, is an efficient disinfectant in the proportion of 1 part in 500, the exposure continuing for two hours.
5. The use of chlorine, and in a greater degree of bromine, requires considerable experience in management. When carelessly handled they may cause inconvenient or even dangerous symptoms in persons using them. For these reasons they are not suitable as disinfectants for popular use.

---

#### CARBOLIC ACID.

BY CHARLES SMART.

Carbolic acid may be said to have been recognized as an antiseptic from the time of its discovery by Runge, in 1834, in the distillate from coal-tar. This is sufficiently attested by the analogies which led to the use of the name *coal-tar creosote*, and the well known preservative action of the product from wood. In Watt's *Chemical Dictionary* we are informed, concerning the properties of carbolic acid, that "fish and leeches die when immersed in the aqueous solution, and their bodies subsequently dry up on exposure to the air without putrefying." The deodorant action of the acid was recognized as due not to a destruction of the offensive products of putrefaction, as in the case of some chemicals, but to an influence on the process which gave rise to them. When this process was shown to be dependent on the development, growth, and multiplication of certain bacterial forms, a destruction of their germs,

<sup>1</sup> Loc. cit.



or at least an interference with the conditions congenial to their growth, was of necessity assumed.

On this, Prof. Lister, in 1867, based the use of the acid in antiseptic surgery. The success attending his method of treatment spread the fame of carbolic acid, and its known and well proved antiseptic properties led to its investiture with disinfectant properties which were by no means proved. It was used largely as a disinfectant in Europe, and for several years was held in a similar high repute in this country.

The first experiments to test its value failed to distinguish between the antiseptic and the disinfectant properties. As late as 1870, Grace Calvert's experiments<sup>1</sup> had a reference only to the delay in the exhalation of putrefactive odors from organic substances. Albumen and flour paste, which became offensive in five and seven days respectively when exposed to the air, were preserved for eleven and twenty-five days when mixed with five per cent. of the acid. Even the experiments of Shroeter,<sup>2</sup> in 1878, seem mainly directed to define an antiseptic value. A liquid, characterized only as teeming with bacteria, had its contained organisms rendered motionless and precipitated by the addition of .05 per cent. of the acid—a dilution of 1 : 2000. Raw flesh in a dilution of 1 : 10,000=.01 per cent., began to putrefy at the end of six days; in 1 : 2000=.05 per cent., the liquid, notwithstanding the presence of the flesh, remained clear and without odor for four weeks; in 1 : 1000=.1 per cent., the preservation was prolonged from six to eight weeks; while in 1 : 500=.2 per cent. the liquid remained clear and free from all organisms for many months. Hence, he considered that a solution containing .1 per cent. of the acid is one in which no low organisms can exist, and that a dilution of .01 per cent. will retard their development for some time.

The acid was recognized as being specially destructive to the moulds, a much smaller quantity sufficing to destroy them than was requisite to insure protection from the bacteria of putrefaction. Thus, Baxter<sup>3</sup> quotes Manassein as authority for the statement that one sixteenth of one per cent. deprived the spores of penicillium of their germinating power; and Schroeter found that the vapor of the acid arrested the development of penicillium and mucor, and destroyed their spores. One thorough fumigation of a mould-infected chamber acted so radically that for six weeks afterwards no trace of the fungi was discovered.

It became evident, however, to the experimenters having this matter in view, that the acid might interfere with the development of the bacteria of putrefaction without destroying their power of multiplication when transferred to a more congenial environment. Hence, culture experiments were instituted on the bacteria that had been subjected to the influence of the acid. Moreover, it was recognized that experiments on the bacteria of putrefaction were by no means satisfactory as argu-

<sup>1</sup>*Chemical News*, London, 1870, vol. xxiii, p. 281.

<sup>2</sup>"Beitrag zur Biologie der Pflanzen," Breslau, 1878, 3 Heft, S. 30 *et seq.*

<sup>3</sup>"Report of the Medical Officers of the Privy Council and Local Gov't Board." London, 1875. P. 216, *et seq.*

ments on the vitality of the disease germs which were concerned in the process of disinfection. Hence were instituted experiments on certain infective matters.

Braidwood and Vacher investigated the action of the acid on vaccine lymph in 1870, and verified their results in 1876.<sup>1</sup> On four children vaccinated with lymph containing 2.5 per cent. of acid, six vesicles were obtained at ten points of insertion. In these instances the lymph was removed from the arm, mixed in a watch-glass with the acid, and applied at once. A second group of children, five in number, were vaccinated in a similar way; but the mixtures used had been preserved in Husband's capillary tubes for seventeen days, three weeks, four weeks, and six weeks respectively. These inoculations all failed, and the children afterwards underwent a successful normal vaccination. Similar results were obtained by trying the carbolated lymph on a heifer.

Meanwhile, Dougall, in 1873, operated on vaccine lymph, making use of subsequent vaccination as the test of the action of the carbolic acid on the virus. He exposed the lymph in a bell jar of one cubic foot capacity for thirty-six hours, and after mixing it with glycerine and water, sealed it up in capillary tubes until used for vaccination. The lymph thus treated produced satisfactory vesicles. Led by this result, he then treated fresh vaccine with one per cent. of pure carbolic acid, and found its infective property undiminished. But about the same time Hoppe Seyler<sup>2</sup> determined that two per cent. of the acid destroyed the activity of vaccine virus; and two years later, Baxter, in his careful work for the British health authorities, was also successful in destroying the virus, as proved by subsequent inoculation with the disinfected matter. He exposed dry vaccine to carbolic acid vapor in a bottle one third filled with the acid, and found that when the period of exposure was less than thirty minutes the infection was but slightly if at all impaired. When the exposure extended to thirty minutes, disinfection was effected in one specimen, while another produced two vesicles for three insertions. In two instances, in which the exposure was prolonged for sixty minutes, the virus proved inefficient when subsequently used. He also found that while the presence of one per cent. of carbolic acid in liquid vaccine exerted no influence on its activity, two per cent. destroyed its infective power with certainty.

Dougall, returning to this subject in 1879,<sup>3</sup> concluded from some of his experiments that if the vaccine were used immediately after its exposure to the carbolic acid, or if hermetically sealed in the meantime, the virus would fail, but that if exposed to the air after being carbolized it would recover its activity. Thus sixty parts of vaccine and forty of acid, when used immediately after mixture, gave no results, but when used after a free exposure to the air during fourteen days, it was found to have recovered its active properties. He therefore concluded that the infected

<sup>1</sup>"British Med. Association. Scientific Reports." London, 1876.

<sup>2</sup>*Arch. Gen.*, May, 1863, p. 633.

<sup>3</sup>*British Med. Jour.*, 1879, vol. ii, p. 726.

particles of the lymph became covered with coagulated albumen of the vaccine liquid, and that in vaccination the free acid coagulated the contents of the dermal capillaries and rendered absorption impossible. But these experiments of Dr. Dougall did not succeed in the hands of J. W. Miller, of Dundee.<sup>1</sup>

He prepared four specimens, each containing two parts of carbolic acid and three of vaccine. The mixtures were exposed to the air for fourteen days before use; and in each of the four experiments the lymph was barren. Two experiments were made with vaccine which had been exposed to the air for fourteen days after its admixture with five per cent. of the acid; in one of these the lymph was barren, in the other an imperfect vesicle was obtained. One experiment, however, appeared to verify Dr. Dougall's results: equal parts of vaccine and glycerine of carbolic acid, after exposure to the air during fourteen days, yielded a good vesicle. But Miller was inclined to view this result with suspicion, and attributed it to pure lymph rubbed off by inadvertence from some of the other points of insertion on the child's arm.

But other liquids containing germs or infective matter were used by the investigators. Rosenbach,<sup>2</sup> in 1873, injected dogs and rabbits with unhealthy pus, to which five per cent. of the acid had been added, the general tenor of his results showing that disinfection had been accomplished. Baxter, two years later, experimented with the virus derived from the peritoneal cavity of guinea-pigs that had succumbed to infective peritonitis. The length of time during which the virus was exposed to the action of the acid varied from thirty minutes to three hours, thorough admixture having been effected in the meantime. In one set of experiments, two per cent. and one per cent. of the acid destroyed the infection, as the animals inoculated with the mixture did not suffer. In a second series of experiments, one per cent. was efficient for protection, but with a virus containing only .5 per cent. the animal died in forty hours from acute cellulitis. In a third series, one per cent. was efficient, but death occurred with .5 per cent. in eighteen hours. In the fourth series, one per cent. proved again protective against the infective material. Similar inoculation experiments with the virus of glanders showed that two per cent. of carbolic acid destroyed its infection, while .5 per cent. failed to act as a disinfectant.

By culture experiments, Sternberg, in 1883,<sup>3</sup> showed that the micrococcus of pus has its vitality destroyed so that it fails to develop when introduced into a sterilized bouillon after an admixture of two hours with .8 per cent. of the acid, while with .5 per cent. its subsequent cultivation was successful; and that the micrococcus of septicaemia is destroyed by .5, but not by .25 per cent. This defines the germicide limits of the acid in respect to these organisms. On the other hand, when carbolic acid was added to the sterilized culture-liquid, a much smaller per-

<sup>1</sup>*Med. Record*, Sept., 1873, p. 427.

<sup>2</sup>*Practitioner*, Sept., 1884, p. 146.

<sup>3</sup>*Amer. Jour. Med. Sciences*, April, 1883.

centage than was needful for a germicidal action sufficed to prevent the development of the micrococci of pus and of septicæmia when implanted for cultivation. Thus, .2 per cent. prevented the development of the organisms, while .1 per cent. failed to protect the culture-liquid from its attack. Similar results were obtained with the micrococcus of septicæmia. This defines the antiseptic limits of the acid in respect to these organisms.

Baxter was of opinion that the length of time during which the acid was permitted to act upon the infective material was of no importance, provided that thorough mixture was insured. This implies a belief in the instantaneous action of the acid on the active principle of the virus. Some experiments by Koch<sup>1</sup> in 1881, Salmon<sup>2</sup> in 1883, and Schill and Fischer<sup>3</sup> in 1884, indicate that time of exposure, as well as strength of solution, enters as an element into the question of disinfection. Thus, the last mentioned investigators, operating on fresh tubercular sputa, found that disinfection was accomplished by treatment with three, two, or even one per cent. of acid for twenty hours; but that five per cent. failed to disinfect when the period of digestion was limited to two hours. Post-mortem examinations discovered sound organs in the animals inoculated with the former mixtures, and tubercular disease in those of the specimens treated with the latter and stronger mixture. Salmon, operating on the micrococcus of fowl cholera, obtained the destruction of the virus by one per cent. of the acid, the test being inoculation. In some experiments, in which the test was cultivation, one per cent. succeeded, and .5 per cent. failed to destroy the power of germination when the digestion with the acid was continued for one and a half hours; but .5 per cent. was successful when the digestion was prolonged for twenty-four hours.

The bacilli and spores of anthrax have been subjected to a number of experiments, of which those of Davaine<sup>4</sup> are the earliest. The blood of an infected animal, diluted with one hundred parts of water, was used. This was found to be speedily fatal to guinea-pigs when injected under the skin, but its virulence was destroyed on treatment for an hour with one per cent. of carbolic acid. Koch found that the *spores* of anthrax had their vitality destroyed by immersion for twenty-four hours in a five per cent. aqueous solution of the acid. A two per cent. solution was not efficacious; but after five days' digestion in this solution the development of the spores was somewhat retarded. Further experiments showed entire failure of disinfection with a one and two per cent. solution; success after seven days with three per cent.; after three days with four per cent. and after two days with a five per cent. solution. Culture in gelatine was the test employed in these instances. On the other hand, the *bacilli* were destroyed by exposure of from two to twenty-five minutes in aqueous solutions containing from five to one per cent. of the acid, the

<sup>1</sup> "Mitt. a. d. Kais. Gesundheitsamte," 1881, vol. i.

<sup>2</sup> "Report Dept. Agriculture, U. S." 1883.

<sup>3</sup> "Mitt. a. d. Kais. Gesundheitsamte," 1883, vol. ii.

<sup>4</sup> *Comptes Rendus*, Oct. 13, 1873.

test being culture in solidified blood-serum. The culture in gelatine of the anthrax spores was not prevented by their antecedent immersion for one hundred and ten days in oil containing five per cent. of the acid, nor by seventy days in alcohol of the same carbolic strength. An oleaginous five per cent. solution diminished the development of the bacilli in three or four days, and accomplished disinfection on the sixth day, as shown by the failure of subsequent efforts at cultivation. Even a one per cent. solution in oil destroyed their power of development on the sixth day, but it is to be observed that a similar result followed the use of pure olive oil. Arloing, Cornevin, and Thomas<sup>1</sup> found that the virulence of anthrax spores persisted after an immersion of forty-eight hours in alcohol containing two per cent. of the acid, while it was destroyed by the action of the same percentage in water. Blyth<sup>2</sup> also experimented with these spores. He showed the inefficiency of the carbolic acid powders—Calvert's, Jeyes's, and McDougall's. The spores invariably developed notwithstanding contact with the powder for twenty-four hours. A one per cent. carbolic solution had no effect on their development; five per cent. retarded their growth; twenty-five per cent. in alcohol rendered them incapable of germinating in broth.

While these investigators were testing the power of carbolic acid on certain disease-producing substances, many series of experiments were performed on the bacteria of putrefaction, with a view of determining the germicidal as well as the antiseptic powers of the acid on the organisms, the latter being expressed by the quantity of acid required to be added to a nutritive liquid in order to restrain their growth, and the former to prevent them from multiplying when subsequently transferred to a suitable culture-liquid.

Baxter's experiments showed that .5 and .1 per cent. were required for the germicidal action, the larger percentage being requisite when the liquid was albuminous. Hamlet,<sup>3</sup> operating on Pasteur's liquid containing *B. punctum*, *B. termo*, and *M. crepusculum*, found a slight diminution in the number of moving bacteria after standing five days mixed with one per cent. of carbolic acid, while with five per cent. few of the bacteria showed signs of movement. Nevertheless, in this last experiment their vitality persisted, for when a little of the solution was transferred to a large quantity of Pasteur's liquid, the whole was in two days teeming with bacteria. Notter's<sup>4</sup> results were to the effect that 3.3, 5, and 6 per cent. of carbolic acid did not destroy the movements of the bacteria in a putrid infusion of beef, even after the lapse of seven days. Jalan de la Croix<sup>5</sup> found that when two drops of a liquid teeming with bacteria are added to a sterilized meat-juice, the acid must be present in the proportion 1 : 669 to prevent development; but to produce a germi-

<sup>1</sup>*Comptes Rendus Soc. de Biolog.* Septieme serie, t. iv.

<sup>2</sup>*Medical Times and Gazette*, Oct. 11, 1884, p. 498.

<sup>3</sup>*Jour. Chem. Soc.*, London, 1881, xxxix, p. 326.

<sup>4</sup>*Dublin Jour. Med. Sciences*, 1879, vol. 68, p. 196.

<sup>5</sup>"Arch. fuer Experimentelle Pathologie." Leipzig, 1881, p. 175, et. seq.

cidal effect in this weak bacterial liquid, acid in the proportion 1 : 22 had to be added. The bacteria in broken-down meat infusion were killed by immersion for twenty-four hours in a solution of 1 : 22, although not in 1 : 42; but to prevent the development of germs when this liquid was introduced into a sterilized infusion, it was necessary to give them a preparatory soaking for twenty-four hours in an acid of the strength 1 : 2.66, for a solution of 1 : 4 did not deprive them of their fecundity. To prevent the decomposition of boiled meat-juice by germs falling into it from the air, 1 : 402 was required; but for an unboiled infusion 1 : 502 sufficed; and to prevent the development of the germs in the former when transferred to a sterilized liquid, 1 : 22 was required, while those in the latter were not deprived of their germinating power by 1 : 10. Vallin<sup>1</sup> justly remarks of De la Croix's experiments, that they must be accepted with some reserve, since it is contrary to the general experience that a boiled liquid should require more of an antiseptic to preserve it than one which had not been boiled. Sternberg found that .2 per cent. was antiseptic in view of *B. termo*, but one per cent. was required for action as a germicide. He further found that the bacteria in broken-down beef tea retained their vitality after an exposure of two hours to a four per cent. solution.

Turning from these experiments in which the carbolic acid was used in the form of liquid to those in which its vapor was employed, we find the following, in addition to those already mentioned in connection with antiseptics, the destruction of moulds, and of the vaccine efficiency.

Perrin and Marty<sup>2</sup> failed to prevent the decomposition of barley-water, milk, blood, urine, etc., by the atomization of a five per cent. carbolic liquid. Schotte and Gartner<sup>3</sup> volatilized carbolic acid by heat in a closed chamber in which were exposed to the action of the vapor liquids containing bacteria and woollen cloths that had been dipped in these liquids, determining at the close of the exposure whether the fecundity of the bacteria had survived by transferring them to a sterilized culture-liquid. For efficient disinfection, rapid evolution of the carbolic vapors was required. The bacteria in the exposed liquids were destroyed by the diffusion of 7.5 grammes of carbolic acid per cubic metre, but those in the impregnated cloths required a stronger diffusion, 12.5 grammes, when the fabrics were damp, and 15 grammes when they were dry.

From a survey of these experiments on carbolic acid, performed since the introduction of methods of precision in testing germicidal or disinfectant properties, the value of the acid in these respects may be determined.

One per cent. in an aqueous solution has destroyed with certainty the virulence of septic and purulent matters, of the tubercle bacillus, and of the micrococci of fowl cholera; some of the organisms related to putrefaction have also been destroyed by solutions of this strength. But to

<sup>1</sup> "Traité des Désinfectants et de la Désinfection." Paris, 1882, p. 163.

<sup>2</sup> "Bulletin de la Soc. de Chir.," 1879, t. v., p. 153.

<sup>3</sup> "Deutscher Verein für Oeffentliche Gesundheitspflege," 1880, t. xii, p. 337, *et seq.*

produce these results, in some instances, the contact with the disinfectant had to be continued for many hours. Two per cent. of the acid in an aqueous solution was required to destroy the infection of vaccine and glanders; but some of the experiments on the former seem to indicate that no destruction of the virus was effected, but merely a suspension of its powers, which were recovered on the dissipation of the acid by subsequent prolonged exposure to the air. The spores of anthrax did not lose their ability to germinate unless treated with a five per cent. solution for twenty-four hours, or with a weaker solution for a longer time. Lastly, as showing how little reliance can be placed on carbolic acid as a disinfectant, except in special instances, as in those above mentioned where its effects have been determined, the organisms in broken-down beef tea were not deprived of their reproductive powers by treatment with four per cent. acid, Sternberg, nor with six per cent., Notter, nor with ten per cent., De la Croix;—the last observer, indeed, asserts that about thirty per cent. (1 : 2.66) was needful to effect this object.

The large percentage of the acid required for disinfectant or germicidal action when applied directly in the liquid form, prepares us for its failure when used in the form of vapor. Douglas and Baxter, from the results of their experiments on vaccine, concluded that aërial disinfection by carbolic acid vapor was practically impossible. The atomizer, however, offered better facilities for the diffusion of the vapor; and Strott<sup>1</sup> in 1876, and Wernich<sup>2</sup> in 1883, recommended the use of the spray as protective against albuminoid contagious principles. But the experiments of Perrin and Marty, and of Schotte and Gartner, demonstrated its inutility as against bacterial life.

The valuable antiseptic properties of the acid do not come within the scope of this article, although they have been in a measure indicated incidentally.

---

#### DISINFECTION WITH MINERAL ACIDS.

BY VICTOR C. VAUGHAN.

Disinfection with mineral acids in one form or another has long been practised. Sulphurous acid was used by the ancient Greeks in the purification of their temples after sacrificial offerings had been made. In 1773 Morveau recommended the vapor of hydrochloric acid, produced by the action of sulphuric acid on sodium chloride. In 1780 Smyth began the use of nitrous acid vapor as a disinfectant. During the present century, many experiments have been made for the purpose of determining the value of the mineral acids as disinfectants, both in liquid and in vapor form. It is the purpose of this paper to review briefly these reports, and to ascertain what conclusions may be drawn therefrom. Since sulphu-

<sup>1</sup> "Ventilation und Desinfection der Wohnraume," Hoitzminden, 1876, p. 19.

<sup>2</sup> "Real-Encyclopadie der Gesammten," Heilkunde, 1883, B. 15, S. 170, *et seq.*

rous acid will be discussed in another paper, no further mention will be made of it here.<sup>1</sup>

*Hydrochloric Acid.* Dougall<sup>2</sup> found that vaccine virus, exposed under a bell-jar of a cubic foot capacity, for twenty-four hours, to the vapor of the acid, became inert. After exposure, the lymph was mixed with glycerine and water, and the reaction of the mixture (acid) was noted. The mixture was then hermetically sealed in tubes, and so kept until used. Dr. Dougall believed that the effectiveness of the vapor was due to its rendering the virus acid. In proof of this he gives the following tabular statement of the reaction of the lymph and glycerine mixture used in his successful and unsuccessful vaccinations after exposure to different agents :

Successful vaccination. Virus not destroyed.	Reaction of the lymph and glycerine mixture.	Vaccination not successful. Virus destroyed.	Reaction of the lymph and glycerine mixture.
Carbolic acid vapor.	Neutral.	Chloride of lime.	Acid.
Carbolic acid.	"	Sulphurous acid.	"
Chloroform.	Alkaline.	Nitrous acid.	"
Camphor.	"	Glacial acetic acid.	"
Sulphuric ether.	"	Hydrochloric acid.	"
Iodine.	Neutral.		

Commenting upon the above table, Dr. Dougall states,—“These results *per se* are singularly and suggestively explicit. They show that the mixture of lymph and glycerine of the successful vaccinations was either neutral or alkaline; while that of the unsuccessful was, without exception, acid. Hence, volatile acids, or a volatile body causing acidity by chemical affinity, as the chlorine from the chloride of lime, which produces hypochloric acid and free oxygen, are the best destructives of the active properties of vaccine lymph, and therefore *a priori* of variolous matter and other zymotica.<sup>3</sup> The same theory is insisted upon by Dr. Dougall in a later paper.<sup>4</sup> Results with hydrochloric acid vapor, similar to those obtained by Dougall, were reached by Braidwood and Vacher in eight experiments.<sup>5</sup>

Koch<sup>6</sup> ascertained by cultivation that anthrax spores were destroyed

<sup>1</sup>See papers by Drs. Sternberg and Raymond in this series of reports.

<sup>2</sup>“Glasgow Medical Journal,” vol. 5, p. 166.

<sup>3</sup>Loc. cit., p. 168.

<sup>4</sup>“British Med. Journ.,” vol. ii, p. 726, 1879.

<sup>5</sup>Life History of Contagium.

<sup>6</sup>Mittheilungen a. d. Kais. Gesundheitsamte, B. I. S. 263.



after ten days' exposure to a 2 per cent. solution of the acid; but that exposure from one to five days failed to destroy the spores.

Dr. Sternberg, in some experiments made for this report, found hydrochloric acid to fail as a disinfectant when used in 10 per cent. solution, and to be successful when the strength was increased to 15 per cent. Each c. c. of the acid used by Dr. Sternberg contained .395 gramme of HCl.

*Sulphuric Acid.* Koch<sup>1</sup> noticed diminished development of anthrax spores after exposure to a 1 per cent. solution of sulphuric acid for twenty days. The test was by cultivation. Salmon,<sup>2</sup> experimenting upon the micrococcus of fowl cholera, found one half per cent. solution of sulphuric acid successful as a disinfectant, tested by inoculation; but one fourth and one eighth per cent. solutions unsuccessful, tested by cultivation. Sternberg<sup>3</sup> states that "sulphuric acid destroys *B. termo* and the two species of micrococcus experimented upon in the proportion of 1 : 200; but a 4 per cent. solution failed to destroy the bacteria in broken-down beef tea (old stock), doubtless because of the presence of reproductive spores. The multiplication of the bacteria mentioned was prevented by the presence of this acid in a culture solution of 1 : 800. Dr. Sternberg has given the per cent. of sulphuric acid necessary to insure disinfection at 8. Each c. c. of the acid used contained 1.480 gramme H<sub>2</sub>SO<sub>4</sub>.

*Nitrous Acid.* Dougall<sup>4</sup> found that vaccine lymph, exposed to nitrous acid under a bell-jar of one cubic foot capacity for twenty-four hours, was rendered inert. The lymph was treated as given under hypochloric acid, and the action was supposed to be due to rendering the lymph acid.

Notter<sup>5</sup> has experimented upon nitrous acid as an aerial disinfectant. However, his conclusions are not wholly trustworthy, as he considered the bacteria destroyed, when their motion was only arrested. He says,— "I believe the full effect of the agent to be produced when there is arrest of motion, with complete precipitation and disorganization of the bacteria, and I have endeavored in each case to look for this result. One hundred c. c. of putrid beef infusion in saucers were placed in a chamber, of a cubic capacity of fifty-three feet, with two ounces of copper wire, and fifty c. c. of concentrated nitric acid, yielding .35 per cent. of nitrous acid. Soon the bacteria became less active, and in forty-eight hours the activity was still further diminished, and a heavy precipitation of the organisms was noticed. The infusion was free from odor. On the third day there was no tendency to the further development of the bacteria, and the liquid was quite inodorous. At the end of a week there was no further decomposition, and the infusion was found to be strongly acid.

Sternberg<sup>6</sup> found that exposure of vaccine virus for six hours to an atmosphere containing 1 per cent. of nitrous acid vapor destroyed the

<sup>1</sup> Loc. cit., p. 264.

<sup>2</sup> Report Dept. Agriculture, 1883.

<sup>3</sup> Bacteria, p. 223.

<sup>4</sup> Loc. cit.

<sup>5</sup> "Dublin Journal Med. Sciences," vol. 71, p. 508.

<sup>6</sup> National Board of Health Bulletin, p. 287.

germs; also, that the bacteria of putrid urine was destroyed when exposed on filter paper for six hours to an atmosphere containing one half per cent. of nitrous acid gas.

*Nitric Acid.* Dr. Sternberg has ascertained that nitric acid fails as a disinfectant in solutions of 5 per cent., but is effectual in solutions of 8 per cent. Each c. c. of the acid used contained .819 gramme of  $\text{HNO}_3$ .

*Chromic Acid.* Koch<sup>1</sup> ascertained that anthrax spores were destroyed by exposure to 1 per cent. solutions of chromic acid after from one to two days.

*Osmic Acid.* Koch<sup>2</sup> found, by cultivation, that anthrax spores were destroyed by exposure for twenty-four hours to 1 per cent. of osmic acid.

*Practical Considerations of the Use of the Mineral Acids as Disinfectants.* The action of 10 and 5 per cent. solutions of sulphuric, nitric, and hydrochloric acids upon lead pipes was tried, with the results given in the accompanying table. Weighed pieces of lead pipe were placed in the dilute acids, and the loss was determined by subsequent weighings. This represents a more powerful action than would result simply from the rapid passage of the disinfectant through the pipes; but the table gives results which would be obtained by the solution standing in a trap. At the time of each weighing, the dilute acid was replaced by a fresh portion.

The experiments were continued until the nitric acid had completely destroyed the pipe; but as the results are sufficiently shown by the following figures, it is unnecessary to give the table in full. After a number of days there was a slight increase in the weight of the pipes placed in the sulphuric acid solutions. All the acids used were of the commercial grade. We also have figures showing the action of the dilute acids upon iron pipes; but, as this action is rapidly destructive with all the acids, it is unnecessary to give the figures. In order of disintegrating effects upon iron pipes, sulphuric acid acts with most vigor; while there is not much difference in the effects produced by the same strength solutions of nitric and hydrochloric acids. The action upon zinc is in the same order as that given for iron; while the solvent action of nitric acid on tin was found to be greater than that of either sulphuric or hydrochloric acid.

<sup>1</sup> Loc. cit., S. 264.

<sup>2</sup> Loc. cit.

## ACTION OF MINERAL ACIDS UPON LEAD PIPES.

Date of weighing and changing solution.	No. of days in the solution.	10 per cent. $H_2SO_4$		5 per cent. $H_2SO_4$		10 per cent. $HNO_3$		5 per cent. $HNO_3$		10 per cent. $HCl$		5 per cent. $HCl$	
		Weight of pipe.	Loss.	Weight of pipe.	Loss.	Weight of pipe.	Loss.	Weight of pipe.	Loss.	Weight of pipe.	Loss.	Weight of pipe.	Loss.
Jan. 30, 1885.	0	53.120	..	52.990	..	53.000	.....	53.000	.....	53.000	.....	53.000	.....
Feb. 2, "	3	53.120	00	52.990	00	48.500	4.500	51.300	1.700	52.930	0.070	52.990	0.010
Feb. 3, "	1	53.120	00	52.990	00	44.220	4.280	49.350	1.880	52.900	0.030	52.970	0.020
Feb. 4, "	1	53.120	00	52.990	00	41.130	3.090	47.365	1.985	52.860	0.040	52.925	0.045
Feb. 6, "	2	52.120	00	52.990	00	34.520	6.610	44.400	2.965	52.845	0.015	52.920	0.005

## THE METALLIC SULPHATES.

BY GEORGE M. STERNBERG.

The metallic sulphates have been largely recommended as "disinfectants," and directions for their use are to be found in the printed circulars of health authorities in this country and in Europe. In France the sulphate of copper is a favorite disinfectant, and, as I shall shortly show, is a reliable agent for the destruction of germs in the absence of spores. It is very much superior to ferric sulphate or zinc sulphate, which have been more extensively used in our own country.

The value of all these agents as antiseptics is beyond question; and when the object in view is to prevent the development of germs in privy-vaults, cess-pools, etc., a solution of "copperas," on account of its cheapness and efficiency, is especially to be recommended. But the directions often given for the use of dilute solutions of ferric sulphate or zinc sulphate, for the disinfection of the sputa of patients with diphtheria, the excreta of patients with cholera, typhoid fever, etc., are founded upon a mistaken estimate of the germicide power of these salts.

The metallic sulphates have all a certain value for the prevention of putrefactive fermentation, and for neutralization of the volatile products of putrefaction. They are therefore "disinfectants" in the popular acceptance of the term. Thus Vallin says,—

*Metallic Sulphates in general.*—These agents are disinfectants in the vulgar sense of the word. They diminish or cause to disappear bad odors, their action being limited to the neutralization of ammonia and the decomposition of sulphuretted hydrogen, or of the sulph-hydrate of ammonia.

In this group are the soluble salts of iron, of zinc, of copper, of manganese, and of lead. The oxides of these metals, which are quite cheap, have also been recommended for this purpose, but the salts have the advantage over the oxides of being able to saturate ammonia already formed, or that which results from the decomposition of the sulph-hydrate of ammonia. The oxide of iron, for example, can only fix sulphuretted hydrogen by forming the sulphuret of iron. The sulphate of iron produces in addition the sulphate of ammonia.

These salts, then, cannot neutralize all bad odors, and therefore they do not entirely merit the title of deodorants. Bad odors, indeed, owe their infection to a great quantity of diverse substances which have not been completely determined by chemistry, and of which scatol is one of the most recently discovered. It is, then, almost entirely the two badly smelling compounds which have been longest known, which are neutralized by these metallic salts.<sup>1</sup>

Virchow has pointed out one of the objections to the use of the sulphate of iron for disinfecting feces. The volatile fat acids, butyric, valerianic, etc., which have a disgusting odor and are highly toxic, are ordinarily combined with ammonia. When we throw sulphate of iron upon fecal matter, the sulphuric acid combines with the ammonia, and fetid products are given off, which are very volatile.

The immediate effect, therefore, of throwing sulphate of iron into latrines is frequently to augment the bad odor, which, however, soon diminishes, but ordinarily reappears after some time.<sup>2</sup>

In what follows we shall endeavor to fix the value of the metallic sulphates as *disinfectants*, in accordance with the definition of the term

<sup>1</sup> *Traité des Désinfectants*, p. 57.

<sup>2</sup> *Op. cit.*, p. 63.

heretofore given by the Committee on Disinfectants, *i. e.*, the germicide value as fixed by biological tests.

*Ferric Sulphate.*—In the writer's experiments, published in the *American Journal of the Medical Sciences* (April, 1883), it was found that a saturated solution of ferric sulphate failed to destroy the growing power of any of the test organisms, the time of exposure being two hours. A recent experiment upon a micrococcus obtained from the pus of an acute abscess gave a similar result. The organism grew freely in culture solutions after exposure for two hours to a 10 per cent. solution.

According to Arloing, Cornevin, and Thomas, exposure to a 20 per cent. solution for forty-eight hours does not destroy the virus of symptomatic anthrax. The vitality of anthrax spores is not destroyed by exposure for six days in a 5 per cent. solution (Koch).<sup>1</sup>

*Zinc Sulphate.*—In the writer's experiments, reported in the *American Journal of the Medical Sciences* (l. c.), a solution of 20 per cent. of this salt failed to destroy the micrococcus of pus. In experiments recently made, the same micrococcus grew after exposure to a 10 per cent. solution for the same time (two hours), but development was somewhat retarded. Another micrococcus (*M. tetragenus*) was destroyed by a 10 per cent. solution in the same time. Broken-down beef tea, mixed in equal quantities with a 40 per cent. solution, was not sterilized at the end of two hours, as shown by culture experiments made in the usual way.

Koch found (l. c.) that a 5 per cent. solution had not destroyed the growing power of anthrax spores at the end of ten days, although their development was somewhat retarded.

*Cupric Sulphate.*—I have recently made experiments with this salt upon pure cultures of *B. anthracis* and of *B. subtilis*, and find that in a 20 per cent. solution (equal parts of a 40 per cent. solution and of the culture) it fails to destroy the vitality of the spores of these bacilli in two hours' time.

Arloing, Cornevin, and Thomas found that the dried virus of symptomatic anthrax is destroyed in forty-eight hours by a solution of this strength (20 per cent.). Koch found (l. c.) that a 5 per cent. solution did not destroy the vitality of anthrax spores at the end of ten days, although the rapidity of development was somewhat retarded.

The germicide power of this salt is, however, decidedly superior to that of the corresponding salt of iron or of zinc. I have demonstrated by recent experiments that it destroys micrococci in the proportion of .5 per cent. (= 1 : 200). The experiments were made upon a micrococcus derived from the pus of an acute abscess, and upon the micrococcus of swine plague. In one half the amount named (1 : 400) it failed to destroy the vitality of these micrococci.

This agent, then, is a valuable germicide, and may be safely recommended for the disinfection of material not containing spores. But none

<sup>1</sup>See table on p. 264 of the first volume of the "Mittheilungen aus dem Kaiserlichen Gesundheitsamte."

of the metallic sulphates can be relied upon for the destruction of spore-bearing pathogenic organisms, and the germicidal power of ferric and zinc sulphate is too feeble to make these salts available for disinfecting purposes, even in the absence of spores.

---

### ZINC CHLORIDE.

BY GEORGE H. ROHÉ.

In his classical essay on disinfection,<sup>1</sup> Koch expresses astonishment that an agent, which proved almost entirely inefficient as a germicide in his experiments, should have obtained the widespread reputation as a disinfectant which chloride of zinc enjoys. He shows that anthrax spores, exposed to the action of a five per cent. solution (1 : 20) of this salt for thirty days, germinated as freely upon a suitable culture medium as similar material not so exposed. The development of micrococcus prodigiosus was only slightly retarded by exposure for upwards of sixteen hours to a one per cent. (1 : 100) solution. Anthrax spores developed freely in a one tenth per cent. (1 : 1000) solution of this salt.

Mr. A. W. Blyth<sup>2</sup> says a one per cent. (1 : 100) solution seemed to stimulate the growth of anthrax spores; five per cent. (1 : 20) failed to destroy their vitality; while twenty-five per cent. (1 : 4) seemed to arrest the life of the spores.

Dr. Sternberg<sup>3</sup> found two per cent. (1 : 50) destructive to the micrococcus of gonorrhœal pus, while one half per cent. (1 : 200) destroyed the power of development of the septic micrococcus. In Sternberg's later experiments<sup>4</sup> ten per cent. of Squibb's liquor zinci chloridi (said to contain fifty per cent. of anhydrous chloride of zinc) was found effective in destroying the organisms of broken-down beef tea. Numerous experiments have shown that these organisms are fully as resistant to most germicides as are the spores of *B. anthracis*. In order to clear up the apparent discrepancy between these observations of Koch and Sternberg, an additional series of experiments has recently been made by the latter, assisted by Dr. A. C. Abbott. These experiments showed that the spores of *B. anthracis* are not killed by an exposure for two hours to a ten per cent. (1 : 10) solution of this salt. A five per cent. (1 : 20) solution, acting for the same period, was, however, effective in destroying the spores of *B. subtilis*, and upon broken-down beef-peptone solution, which had been freely exposed to the air, and consequently contained a variety of micro-organisms. A two and a half per cent. solution (1 : 40) failed to sterilize putrid beef-peptone solution.

<sup>1</sup>Ueber Desinfection: Mittheilungen a. d. Kais. Gesundheitsamte. Bd. I. S. 261.

<sup>2</sup>Medical Times and Gazette, Oct. 11, 1883.

<sup>3</sup>Am. Journ. Med. Sciences, April, 1883, p. 331.

<sup>4</sup>The Medical News, Feb. 7, 1885.

The above experiments indicate that zinc chloride, in the proportion of five per cent. added to the material to be disinfected, can be relied upon for the destruction of micro-organisms in the absence of spores. To destroy the vitality of anthrax spores, however, a twenty per cent. solution is necessary.

---

### MERCURIC CHLORIDE.

BY GEORGE M. STERNBERG.

The use of corrosive sublimate as a parasiticide and as an antiseptic agent for the preservation of animal tissues, etc., has long been known, but the résearches which have established its value as a disinfectant are of comparatively recent date. These résearches, made during the past four or five years, have demonstrated that bi-chloride of mercury occupies a leading place among known germicide agents. Miquel places mercuric iodide above the chloride as an antiseptic, and it may be that it has a correspondingly greater germicide value. But from a practical point of view the chloride must still be accorded the first place on account of its cheapness and solubility.

My own observations are in accord with those of Koch, of Jalan de la Croix and others, as to the power of this agent in dilute solutions (1 : 1,000 to 1 : 10,000) to destroy the spores of bacilli,—*B. anthracis* and *B. subtilis*,—and this constitutes the most difficult biological test known. Micrococci and bacilli in active growth, without spores, are killed by much weaker solutions (1 : 20,000 to 1 : 40,000).

Klein, of London, is, so far as I know, the only author who has reported results in conflict with these. In his recent work on *Micro-organisms and Disease*,<sup>1</sup> he says,—

By sowing any micro-organism in a nourishing medium, to which has been added a certain substance (*e. g.*, carbolic acid to the amount of one per cent.), and exposing this medium to the conditions of temperature, moisture, etc., otherwise favorable to the growth of the organism, if we find after the lapse of a due period the growth is retarded or altogether inhibited, the conclusion is drawn that this substance (*viz.*, the carbolic acid of 1 per cent.) is an antiseptic. There is nothing more fallacious than this mode of reasoning. A great many micro-organisms can be exposed to a 1 per cent. solution of carbolic acid for hours without in the least being affected, for on being transferred to a suitable nourishing medium they grow and thrive well. Similarly, by placing the spores of *B. anthracis* in a proteid medium containing perchloride of mercury of the strength of 1 in 300,000, it is found (as Koch has shown) that the spores are absolutely incapable of germinating. But if from this the conclusion is drawn that perchloride of mercury of the strength of 1 in 300,000 is a germicide, I should most strongly dissent,—for perchloride of mercury, even of the strength of 1 per cent., is not a germicide any more than vinegar; for on placing the spores of *B. anthracis* in a proteid medium, to which so much vinegar or any other acid has been added as makes it decidedly acid, it will be found that the spores do not germinate.

<sup>1</sup>*The Practitioner*, Lond., Oct., 1884, p. 251.

I have recently had occasion to object to the use of the terms antiseptic and germicide as synonymous, and the confusion resulting from such a misuse of the term *antiseptic* is exemplified in the above quotation. No one familiar with the present state of knowledge upon the subject would think of inferring that mercuric chloride is a germicide in the proportion of 1 : 300,000, because anthrax spores do not germinate in culture-fluids containing this amount. But an agent which prevents the development of putrefactive bacilli is an antiseptic, for putrefactive decomposition is prevented by such an agent as well as by one which kills germs. A germicide is necessarily an antiseptic, but an antiseptic is not necessarily a germicide. Thus alcohol, chloride of sodium, borax, sulphate of iron, and many other agents constantly used as antiseptics, do not in the most concentrated solutions destroy the vitality of the spores of bacilli, and consequently are not germicides.

The statement made by Klein, that "perchloride of mercury even of the strength of 1 per cent. is not a germicide any more than vinegar," is opposed by the experimental evidence reported *in detail* by Koch, and by my own extended experiments with this agent. I am convinced that there must have been some defect in Klein's method of working, and that the spores which killed his guinea-pigs had not been fairly exposed to the action of the disinfecting agent. He says,—

I have tried the action of a number of substances in common use as antiseptics (*e. g.*, Calvert's fluid, pure terebene, phenol 10 per cent., perchloride of mercury 1 per cent.), on the spores of *B. anthracis*, exposing these in comparatively large quantities to the above fluids (the two being well mixed) for twenty-four hours, and then inoculating guinea-pigs with them (spores and antiseptic). The animal died with symptoms of typical anthrax, the blood teeming with the *B. anthracis*.<sup>1</sup>

The very definite evidence from various sources, a portion of which will be given below, as to the power of mercuric chloride to destroy the spores of anthrax in much weaker solutions than that used by Klein, and in a much shorter time, justifies the suspicion that these guinea-pigs died from accidental inoculation with spores not subjected to the action of the disinfectant. This suspicion is further justified by Klein's account of the frequent accidents of this kind which have occurred in his laboratory. Among other examples of this, given in the work already referred to, is the following :

Another gentleman working in the laboratory of the Brown Institution intended to inoculate several guinea-pigs with human tubercles. For this end he mashed up in a saline solution, in a clean mortar, a bit of human lung studded with tubercles. He did this in my room on the same table on which I was working with anthrax. One of these guinea-pigs, inoculated with human tubercle, died before the second day was over of typical anthrax. Its blood was teeming with the *B. anthracis*. Such an accidental anthrax in guinea-pigs inoculated with tubercle occurred several times. \* \* \* I myself had the following accidental contaminations : \* \* \*

<sup>1</sup> Op. cit., p. 253.

<sup>2</sup> Micro-organisms and Disease. *The Practitioner*, London, Aug., 1884, p. 110.



We are not here directly concerned with the restraining influence of mercuric chloride upon the development of anthrax spores, but having made some recent experiments in this direction which fully confirm the results previously reported by Koch, I may be excused for referring to the matter, especially in view of the therapeutic and sanitary possibilities which suggest themselves in connection with this inhibiting action of corrosive sublimate in very dilute solutions. From a sanitary point of view, it is evident that an agent which is capable of preventing the development of disease germs in cesspools and privy-vaults in the proportion of 1 : 300,000 (*i. e.*, one pound costing fifty cents would inhibit the development of anthrax spores in 300,000 pounds of a suitable culture-fluid) has an interest for health officers quite independent of the interest which attaches to it as a potent gemicide in stronger solutions.

*Experiment, December 22, 1884.* Mercuric chloride was added to a sterilized culture-fluid in the proportion of 1 : 100,000, 1 : 200,000, and 1 : 400,000, and two culture-flasks were filled from each solution. These flasks were then inoculated with anthrax spores from a pure culture, and another flask, not containing the mercuric chloride, was inoculated to test the stock. At the end of twenty-four hours the last mentioned flask contained an abundance of anthrax filaments: the others remained clear. At the end of forty-eight hours the two flasks containing the bichloride in the proportion of 1 : 400,000 contained flocculi of anthrax filaments, and the others remained clear.

Davaine found that the virulence of serum containing anthrax bacilli, obtained from the subcutaneous cellular tissue of an animal recently dead, is destroyed by adding to it corrosive sublimate in the proportion of 1 : 150,000.<sup>1</sup> In this case no spores are present in the material.

The restraining power of this agent is not so great for the spores of *B. subtilis* as for those of anthrax. This was shown by an experiment made upon the same date as that above reported. At the end of twenty-four hours after inoculation with spores, a mycoderma of *B. subtilis* had formed in solutions containing 1 : 100,000; and in forty-eight hours the same results had occurred in two flasks containing 1 : 50,000.

The inhibiting power of this agent is still less for micro-organisms in active multiplication. Thus, in my experiments reported in the *Am. Journal of the Med. Sciences*, April, 1883, the development of micrococci was prevented by 1 : 30,000 to 1 : 40,000. I have recently repeated these experiments with a similar result. To destroy the vitality of the same micrococci, as proved by their failure to grow in culture-fluids, required 1 : 20,000, while the bacteria in broken-down beef tea containing spores were destroyed by 1 : 10,000. According to Koch, mercuric chloride, in the proportion of 1 : 1,000, destroys all spores in a few minutes; and in weaker solutions, up to 1 : 10,000, he has shown by culture and inoculation experiments that this agent destroys the vitality of anthrax spores.

<sup>1</sup> "Recherches sur le traitement des maladies charbonneuses chez l'homme." Bulletin de l'Acad. de Med., 17 Juillet, 1880, p. 557.

The results of his culture and inoculation experiments are not, however, entirely in accord; and it seems probable that failure to develop upon the surface of a solid culture-medium, after ten minutes' exposure to 1 : 20,000, may have been due to the restraining influence of a small amount of bichloride not removed by the washing in alcohol, which was resorted to for the purpose of getting rid of this complication. Fluid-cultures possess an evident superiority for such experiments as this; for when a very small quantity of spore-containing material is introduced into flasks containing a large quantity of culture-fluid, the disinfecting agent is diluted beyond any possibility of interfering with the success of the experiment. Moreover, when spores fail to develop in such fluid-cultures it is easy to prove that the failure relates to loss of vitality on the part of the spores, and not to the presence of an inhibiting agent. This I am in the habit of doing by inoculating the same culture-fluid with other spores not disinfected; and the rapid development of these is satisfactory evidence that in the first experiment failure to develop was not due to the small amount of mercuric chloride introduced in the inoculation with disinfected spores.

The view, that in Koch's surface-cultures the inhibiting influence of the bichloride came into play, is sustained by his own inoculation experiments, and by my culture experiments reported below. Thus we are informed<sup>1</sup> that three mice were inoculated with anthrax spores, attached to strands of silk thread which had been exposed for ten minutes to solutions of the strength of 1 : 10,000, 1 : 20,000, and 1 : 50,000. All of the mice died of anthrax; but while the one inoculated with the strand exposed to 1 : 50,000 died in the usual time,—on the second day,—the one inoculated with 1 : 20,000 did not die until the fourth day, and the one with 1 : 10,000 not until the fifth day.

That anthrax spores may survive exposure to a solution of 1 : 10,000 for a longer period than ten minutes is also shown by the following experiments.

*December 18, 1884.* A small quantity of a culture-fluid containing anthrax spores was exposed for *one hour* to mercuric chloride in the proportion of 1 : 10,000. No development of anthrax bacilli occurred in a culture-flask inoculated with these spores; but in another experiment, made at the same time, in which the proportion of the disinfectant and the time of exposure remained the same, and in which a *much larger quantity* of the spore-containing culture-fluid was used, there was an abundant development of anthrax bacilli in the inoculated culture-flask.

It is evident that in this experiment a material change in the conditions was made, although the time of exposure and the amount of the disinfecting agent present were the same in both cases, and that in experiments of this kind the amount of material to be disinfected must also be taken into consideration. In other words, a few germs may be destroyed by a comparatively dilute solution of the disinfecting agent, while stronger solutions will be required for the destruction of a large number of germs

<sup>1</sup> *Mitth. a. d. k. Gesundheitsamte*, I, p. 277.

contained in the same amount of material. Again: It is true of mercuric chloride as well as of oxidizing disinfectants, such as potassium permanganate and the hypo-chlorites, that the quantity of non-living organic material present will also materially influence the result. This is illustrated by my experiments reported below, in which semi-solid feces was the material subjected to the action of the disinfectant.

The spores of *B. subtilis* are destroyed by about the same proportion of mercuric chloride as is required to kill anthrax spores.

*Experiment, December 22, 1884.* A small amount of a culture-fluid containing the spores of *B. subtilis* was exposed to the action of a solution of corrosive sublimate of the strength of 1 : 10,000 for thirty minutes. A like amount was exposed for one hour, and a third portion for two hours. Two culture-flasks were inoculated with spores from each. At the end of twenty-four hours those inoculated with the material exposed for thirty minutes showed an abundant development of *B. subtilis*, and the others remained clear.

The importance of the time of exposure to the action of the disinfecting agent, which is clearly brought out in the above experiment, is very well illustrated by the experiments on vaccine virus reported by Dr. W. J. Miller, of Dundee :

I have made fourteen observations with this agent on vaccine. In one of these it was tested in the following manner: I placed half the contents of a well filled tube on a glass slide, and after it dried covered it with some perchloride solution (1 in 1,000), and after allowing it to lie for ten minutes washed off the perchloride gently with water, so that the film of vaccine remained. This was then rubbed up with water, and put in a tube for use. The product entirely failed to take, while the other half of the same specimen of lymph produced a good result. Another specimen was mixed with an equal quantity of the same solution (1 in 1,000), and was used an hour thereafter, disinfection being complete. Two trials were made with the same mixture prepared immediately before use, two after an interval of three minutes, and one after fifteen minutes, and in all five the lymph was uninjured. Five experiments were made with a solution of 1 in 500 and vaccine in equal proportions (= 1 : 1,000.—G.M.S.), mixed respectively, immediately before use, a few minutes, three minutes, three minutes, and five minutes, and in all the lymph was in no way affected. Two observations with lymph and a still stronger solution (1 in 250), in equal proportions, mixed immediately before use, gave the same negative result.<sup>1</sup>

According to Arloing, Cornevin, and Thomas, the activity of dried virus of symptomatic anthrax is destroyed by mercuric chloride in the proportion of 1 : 5,000.

Jalan de la Croix found that the bacteria in beef *bouillon* were destroyed by 1 : 6,500, but that the proportion required to destroy bacteria in a beef infusion made without heat was 1 : 2,525.

It is evident, that in the absence of precise information as to the time of exposure and other essential conditions, these results cannot be compared directly with those reported by other observers, in which the material tested or the conditions of the experiment were different.

In the writer's experiments, reported in the *American Journal of the Medical Sciences* for April, 1883, the bacteria in broken-down beef tea

<sup>1</sup> *The Practitioner*, London, October, 1884, p. 265.

(old stock exposed in the laboratory for a long time) were destroyed by two hours' exposure to mercuric chloride in the proportion of 1 : 10,000, the amount of material exposed to the action of the disinfecting agent being comparatively small.

Extended experiments upon the disinfection of tuberculous sputum have been made by Schill and Fischer, and are reported in their paper published in the second volume of the *Mittheilungen aus dem Kaiserlichen Gesundheitsamte*. In these experiments the test of disinfection was failure of the material to produce tuberculosis when inoculated into susceptible animals.

In a first series of experiments with *dried* sputum, which had been kept for several months, a negative result was obtained in every case from the following inoculations: Two guinea-pigs inoculated with material exposed for twenty-four hours to 1 : 1,000; three with material exposed for twenty hours to 1 : 2,500; and three with material exposed for twenty hours to 1 : 5,000.

In another series of experiments with *fresh* sputum, in which the sublimate solution and the material to be disinfected were used in *equal amounts*, tuberculosis resulted in all of the test animals. Three of these were inoculated with material exposed for twenty-four hours to 1 : 2,000 (*i. e.*, equal parts of sputum and of a 1 : 1,000 solution), and three to material exposed for twenty-four hours to 1 : 1,000.

The failure to disinfect in these experiments was probably due to the fact that the viscid mass of sputum was not penetrated throughout by the disinfecting agent. In the successful experiment with dried sputum, the amount of material used was no doubt much smaller, and its physical condition (pulverized?) such as to insure the action of the disinfectant upon every portion of it.

In a previous paper<sup>1</sup> the writer has recommended the use of a solution containing 1 : 500 of mercuric chloride and 1 : 500 of potassium permanganate as an efficient disinfectant for sputum, and for the discharges of patients with typhoid fever and cholera. The experiments of Schill and Fischer, which I had not read when this recommendation was made, indicate that it will be necessary to use some other agent when the object in view is to destroy the infective virulence of tuberculous sputum; and in general it will no doubt be better to use an oxidizing disinfectant, such as the hypochlorite of soda, when the germs to be destroyed are imbedded in masses of albuminous material, for such masses are disintegrated and destroyed by oxidizing agents, whereas corrosive sublimate has the opposite effect, in consequence of its power of combining with and coagulating albuminous material. For liquid fecal discharges, however, our recommendation is sustained by the experimental evidence.

The following experiments have been recently made. The standard solution above referred to—mercuric chloride and potassium permanganate, of each 1 : 500—was diluted one half, and mixed with an equal quantity of broken-down beef tea (= 1 : 2,000). After exposure for two hours,

<sup>1</sup>*The Medical News*, January 10, 1885, p. 34.

the contained germs had lost their vitality, as proved by culture experiments.

A more difficult test was the following: The standard solution was diluted one half, and mixed with semi-solid feces in equal quantity, well mixed by stirring. Two culture-flasks were inoculated from this at the end of thirty minutes, two more at the end of one hour, and two more at the expiration of two hours. One of the flasks, inoculated at the end of an hour, broke down; the others remained clear. In the case of the flask which broke down, it is probable that some little mass of material was introduced, which had not been thoroughly penetrated by the disinfecting agent. When the standard solution was diluted with three parts (=1 : 4,000), two hours' exposure failed to prevent the subsequent development of the contained spores in a sterilized culture-fluid.

The experimental data herein recorded seem to justify the following conclusions:

Mercuric chloride, in aqueous solution, in the proportion of 1 : 10,000, is a reliable agent for the destruction of micrococci and bacilli in active growth not containing spores; and in the proportion of 1 : 1,000 it destroys the spores of bacilli, provided that the micro-organisms to be destroyed are fairly exposed to its action for a sufficient length of time.

A standard solution of 1 : 1,000 may be safely recommended for the disinfection of bedding and clothing which can be washed; for washing the floors and walls of infected apartments; for disinfecting the hands and instruments of surgeons and gynecologists; and as a disinfecting wash for superficial wounds or mucous surfaces. For continuous application to wounds, etc., a solution of 1 : 10,000, or less, should be effective.

A standard solution of 1 : 500, with the same quantity of potassium permanganate, may be safely recommended for the disinfection of liquid fecal discharges, and other fluid material supposed to contain "disease germs," provided the time of exposure is not less than two hours, and the quantity of material to be disinfected is not in excess of that of the standard solution used.

---

#### CONSIDERATIONS CONCERNING THE PRACTICAL USE OF MERCURIC CHLORIDE AS A DISINFECTANT.

BY VICTOR C. VAUGHAN.

Since mercuric chloride has been put forward as one of the most reliable disinfectants, its practical use has been largely discussed, and some supposed dangers in its general employment have been brought forward. It was for the purpose of ascertaining how much truth there may be in these statements that the following experiments were undertaken.

Is there danger of the passage of this highly poisonous salt, from cess-pools and privy vaults in which its use has been recommended, through

the soil into wells? Sanitarians have had so much to say about well-water being poisoned by the filtration of organic matter through the soil from privy vaults and cesspools, that it is not surprising that the above question should be asked. In order to answer it, the following experiments were made :

*Experiment 1.* A large glass funnel, carrying a filter-paper, was filled with gravel taken from a distance of about four feet beneath the surface. The weight of the gravel was eleven and three fourths pounds, and, when placed in the funnel, it formed an inverted cone, with a base of ten inches diameter and an altitude of eight inches. On this was poured one pint of standard solution No. 2 (corrosive sublimate and permanganate of potash, two drachms of each to the gallon of water), recommended for the disinfection of excreta. After a few minutes a pint of distilled water was also filtered through the soil. This was done in order to wash through any mercury that might be held mechanically in the gravel. The filtrate was collected, concentrated to one fluid ounce, and tested for mercury. The result was negative. The soil retained all of the poison.

*Experiment 2.* This was similar to the above, but black loam was used instead of the gravel. The weight of the soil used was seven pounds. The result was the same as with the gravel.

*Experiment 3.* In this instance clay was used. The weight of the clay was nine and one fourth pounds. As the soil in this case was very dry, it was thoroughly moistened with water before the solution of mercuric chloride was poured on.

These experiments show that the quantities of the different soils, as given above, will remove from solution and retain all the mercury contained in one pint of standard solution No. 2, fifteen grains of mercuric chloride. That a much smaller amount of soil would accomplish the same result was shown by the following :

*Experiment 4.* One and one half pounds of gravel were placed on the filter, and one pint of standard solution No. 2, one ounce at a time, was filtered through the gravel. The filtrate contained no mercury. From these experiments it will be seen that the fear that mercuric chloride may filter through the soil, when used as a disinfectant in privy vaults and cesspools, into wells, and thus poison the water, is groundless. Of course, where there is open connection between the cesspool and wells by the formation of small subterranean rivulets, there would be danger. The fixation of mercury in the soil is doubtless largely, if not wholly, due to the presence of certain inorganic salts, such as carbonates and phosphates, which form insoluble compounds of mercury.

At the recent cholera conference at Rome, Dr. Koch gave, as one of his reasons for not recommending mercuric chloride as a disinfectant, the belief that its disinfecting action was interfered with by the fact that it entered into combination with albuminous material, and thus failed to come in contact with germs enclosed in albuminous masses.<sup>1</sup> That a

<sup>1</sup> *The Medical News*, June 20, 1885, p. 707.

combination between the mercury and albumen does occur may be shown by the following very simple test:

*Experiment 5.* Suspend some recently precipitated mercuric oxide in distilled water, add some egg-albumen, agitate thoroughly, and filter. The filtrate is clear and colorless. Boil this filtrate with potassium chlorate and hydrochloric acid until all the organic matter is destroyed. Then test for mercury with hydrogen sulphide or stannous chloride. The mercury will be found to be present, and all that which was used as mercuric oxide can be recovered.

Albumen dissolves the oxide, forming, probably, mercuric albuminate; but there is no reason for believing that the mercuric albuminate does not diffuse through organic matter. As shown in the experiments, it is freely soluble, and readily passes through the filter-paper. It is altogether probable that it is this mercuric albuminate which forms such a powerful germicide. In this compound we have the mercury in the shape in which it would most likely be taken up by those lower forms of life which feed upon albuminous material.

Medical men have for a long time regarded "yellow wash" as the most successful application that could be made to syphilitic sores. Is it not likely that its great value is due to the formation of mercuric albuminate, which has a local action on the virus, and penetrates the tissue as well? A substance which is not absorbed by living organisms is not poisonous to them, and if by the formation of this mercuric albuminate the most readily absorbable form of mercury is secured, its poisonous properties are intensified.

Further considerations concerning the use of mercuric chloride will be presented as soon as some additional experiments are made. The writer is indebted to two of his students, Messrs. Wagner and Bobb, for aid in the experimental work.

#### ACTION OF MERCURIC CHLORIDE ON LEAD PIPES.

When a solution of mercuric chloride comes in contact with lead, there is an immediate deposit of mercury with the formation of lead chloride. That this action rapidly destroys lead pipe is shown by the following:

*Experiment.* One foot of one half inch lead pipe was placed in a tall beaker, and 1,000 c. c. of a two per cent. solution of mercuric chloride poured into the beaker. Instantaneously a white cloud of lead chloride formed around the pipe, and gradually subsided to the bottom. Each day the solution of mercuric chloride was changed, and the pipe washed with water. After 4,000 c. c. of the mercuric chloride solution had been used, the pipe had worn away to such an extent that on bending it the pipe would break.

Since the reaction is instantaneous, the result would practically be the same, though a little slower, with the solution of mercuric chloride flowing through the pipe.

Notes by Dr. G. M. Sternberg, chairman of committee:

I have recently made some experiments to determine the antiseptic power of mercuric oxide. In the proportion of 1:1,000 it has prevented any development of micro-organisms in veal broth, inoculated with two or three drops of broken-down beef tea. In

the proportion of 1 : 2,000 and 1 : 4,000, it restrained development for a time, but at the end of forty-eight hours the broth became clouded near the surface, and at the end of seventy-two hours had broken down completely. (The same culture-fluid broke down in twenty-four hours when not treated with an antiseptic.) This very decided antiseptic power shows that mercuric oxide is far from being "inert" from a biological point of view.

*Disinfecting and Antiseptic Powder.* The powder under this name, for which a formula was given in the Preliminary Report of the Committee on Disinfectants, was withdrawn in a letter published in the *Medical News* of May 2d.

The writer was responsible for this powder, and withdrew it because of the fact that mercuric chloride is decomposed by the hypochlorites in the presence of moisture. In the powder, made as directed, this reaction does not occur, and the keeping properties of the powder are all that could be desired. But when water is added to it the reaction occurs, and the yellow oxide of mercury is precipitated. This fact having been brought to my attention, I hastened to withdraw my recommendation of the powder, although I had been much pleased with it in practical tests upon feces. Since my return from Europe I have made some additional experiments, which show that, notwithstanding the destruction of the bichloride, the powder is an excellent disinfectant and antiseptic. A sample which I have recently examined contained 2.6 per cent. of available chlorine after the precipitation of the yellow oxide by the addition of water. This same sample, after standing in an open box in the laboratory for about three weeks, still contained 1.5 per cent. of available chlorine at the bottom of the box, and 1 per cent. at the surface of the powder, which had been exposed to the air during this time. I have demonstrated, by recent experiments, that mercuric oxide is a valuable antiseptic. In the proportion of 1 : 2,000 it retards the development of micro-organisms in beef tea inoculated with two or three drops of broken-down stock; and in the proportion of 1 : 1,000 it entirely prevented development for a week, the duration of the experiment, while in the comparative test the beef tea broke down in less than twenty-four hours. Nevertheless, I do not endorse the formula which I first recommended, for the reason that mercuric oxide has an antiseptic power inferior to that of the bichloride, and it is a waste of material to use the bichloride of mercury in the same formula with the hypochlorites. I would therefore recommend that the powder be made without the addition of mercuric chloride.

My object is to dilute the chloride of lime so that it may be used more economically, especially upon the surface of fecal matter in privy-vaults. Such a powder is especially needed in country places, where the old-fashioned open privy-vaults are in use, and in garrisons and military encampments.

Chloride of lime, as received from the manufacturers, is more or less lumpy, and cannot be readily scattered about in a uniform manner. It is also much stronger in chlorine than is necessary. I have therefore endeavored to find an inert substance suitable for diluting it.

Plaster of Paris has the advantage of retaining the chlorine better than anything else I have tried, and makes a powder which can be readily scattered about in a thin layer. Its property of setting with water is no objection to its use in privy vaults, cess-pools, etc., but would be an objection to its use in chamber vessels, the contents of which were to be thrown into water-closets.

To test the keeping properties of a mixture of chloride of lime and sulphate of lime, mixed together in equal quantities, by weight, I exposed a layer having a thickness of about one and a half inch in a shallow vessel, and for comparison, a mixture of equal parts of chloride of lime and sand in a similar vessel. At the outset of the experiment the available chlorine in each specimen was found by Dr. Abbott to be 15 per cent. At the end of a week the mixture with plaster contained 12.9 per cent. of available chlorine, and the mixture with sand 6.8 per cent. At the same time two fruit jars were filled about one third full with the two mixtures, and the metal covers were screwed on. In these closed jars the mixture with sulphate of lime contained 13.5 per cent. of available chlorine at the end of two weeks, and the mixture with sand 11.8 per cent.



THE COMPARATIVE ANTISEPTIC VALUE OF THE SALTS AND OXIDES OF MERCURY.

BY GEORGE M. STERNBERG.

In the introduction of this report the statement is made that "a complete investigation of both disinfectants and antiseptics being impracticable in the time and with the resources at command, the committee decided upon so far departing from the letter of the resolutions of Dr. Hibberd as to limit its inquiry altogether to disinfectants, and to omit all investigations into the action of antiseptics."

The present article is the result of a departure from this rule which the writer has made with reference to the salts and oxides of mercury, because of the special interest which they have from a therapeutical point of view, and because of the important indications which seem to be furnished by their antiseptic power for restricting the development of pathogenic organisms in the alimentary canal, as well as in masses of decomposing organic material which might serve as pabulum for disease germs external to the body.

With the assistance of Dr. Abbott, I have recently made a series of experiments, the results of which are given in the following table:

	Active.	Failed.
Biniiodide of mercury, . . . . .	1 : 20,000	1 : 40,000
Bichloride, . . . . .	1 : 15,000	1 : 20,000
Protiodide, . . . . .	1 : 10,000	1 : 20,000
Yellow oxide, . . . . .	1 : 1,000	1 : 2,000
Black oxide, . . . . .	1 : 500	1 : 1,000
Calomel, . . . . .		1 : 100
Blue mass, . . . . .		1 : 100

In every case the antiseptic was carefully weighed and added to 100 c. c. of beef-peptone solution, or of veal broth. A similar quantity of the culture-fluid was put up as a *temoin* without the addition of the antiseptic. As the oxides and iodides of mercury are insoluble in water, the bottle was repeatedly shaken in order to dissolve in the albuminous culture-fluid as much of the antiseptic as possible. An undissolved remnant could, however, be recognized at the bottom of the bottle after this repeated shaking. Two drops of broken-down beef stock were added to each bottle to cause speedy putrefaction of the culture-fluid in the absence of a sufficiently potent inhibition of the developing power of the bacteria of putrefaction. In every case in the comparative experiment the culture-fluid became clouded, and had a putrefactive odor at the end of twenty-four hours.

The first column in our table shows the proportion in which the culture-fluid was preserved from any appearance of decomposition for at least a week, the duration of the experiment. In the proportion given in the second column a decided inhibiting power was shown, except in the case of calomel and blue mass, which, in the proportion given (1 : 100), gave no evidence of antiseptic power. The other salts and

oxides in the list prevented decomposition for twenty-four hours in the proportion given in the second column; and it was not until the second day that the bacteria of putrefaction commenced to form a cloud at the upper surface of the fluid, which gradually extended until the fluid had entirely broken down, usually by the third or fourth day. The bottles containing the biniodide (1 : 20,000), and the bichloride (1 : 15,000) have now been standing in the laboratory for three weeks, and are as transparent and free from odor as the day they were put up. These results agree with those reported by Miquel.

So far as I know, the antiseptic value of the protiodide and of the oxides of mercury has not heretofore been determined. I shall refrain at present from making any remarks upon the therapeutic possibilities which these figures suggest, or upon the possible explanation of the *modus operandi* of the protiodide, given daily for many months in the cure of syphilis, or of the use of yellow oxide as a remedy for septic fermentation in the alimentary canal. The still greater inhibiting power of mercuric chloride for the spores of *B. anthracis* has already been referred to in the paper published on page 41 of this report.

---

#### SULPHUR DIOXIDE.

BY GEORGE M. STERNBERG.

Vallin, to whom we are indebted for the best practical "treatise upon disinfectants and disinfection"<sup>1</sup> which has yet been published, says,—

"Sulphurous acid, obtained by the combustion of sulphur in free air, occupies almost the first place among the veritable disinfectants."<sup>2</sup>

This is the deliberate judgment of one who had carefully considered the experimental evidence accessible at the time this opinion was formulated (1882).

The use of sulphurous acid gas as a disinfecting agent has come down to us from remote antiquity, and it is safe to say that no gaseous disinfectant known is more extensively used, or has a higher place in the confidence of leading sanitary authorities at the present day. So well established is the belief that the fumes of burning sulphur will destroy the infection of small-pox, scarlet fever, yellow fever, etc., that it is probable that many believers in the germ theory of disease would be disposed to abandon this belief rather than to give up their faith in the disinfecting power of sulphurous acid gas, in case the experimental evidence relating to the germicide power of this agent should be in conflict with the results of their experience.

It is the object of the present paper to present the experimental evidence for the consideration of sanitarians, and, as the subject is one of

<sup>1</sup> E. Vallin, Médecin Principal de 1re Classe de l'Armée, Professeur d'Hygiène à l'école de Méd. Militaire du Val-de-Grace, etc. *Traité des Désinfectants et de la Désinfection*, Paris, 1882.

<sup>2</sup> Op. cit., p. 243.

great practical importance, the paper will necessarily be one of considerable length.

Before the modern methods of isolating and cultivating pathogenic micro-organisms had been perfected, various efforts had been made to determine by experiment the disinfecting power of sulphurous acid gas. One of the first of these experiments upon record is that which the Russian physicians are said to have made at the time of the pest in Moscow, in 1771. According to Dr. A. Wolff, ten cloaks (*pelisses*) which had been worn by soldiers seized with the plague, during their sickness, were exposed to fumigation (*une forte fumigation*) with sulphur and saltpetre. Ten criminals, condemned to death, were then required to wear these garments, and not one of them contracted the malady. In the absence of any control-experiment in which similar garments not disinfected were proved to communicate the disease, we cannot admit that disinfection was accomplished in this instance, as claimed by the Russian physicians, by the fumigation resorted to. The same criticism may be made with reference to most of the evidence relied upon at the present day, which is supposed to establish the value of the agent in question. It is negative in character, and we have no control-experiments. Moreover, accompanying or following the fumigation, other measures are commonly adopted, such as free ventilation and cleansing of apartments, exposure of clothing and bedding to an abundance of fresh air, etc. As in clinical experiments a fictitious value is often assigned to remedies by reason of the failure of the experimenter to recognize the influence of the *vis medicatrix naturæ*, so there is reason to believe a "disinfectant" may often establish a temporary reputation at least, upon the real virtues of an abundance of fresh air, together with a free use of hot water and scrubbing brushes, with perhaps a judicious use of the whitewash brush in addition. These remarks are made, not to throw discredit in advance upon the agent under consideration, but with a view to showing that a careful survey of the experimental evidence is necessary, and that a spirit of scientific conservatism is required when the attempt is made to estimate the value of negative evidence in a case of this kind.

In vaccine virus we have an infectious material which seems especially well adapted as a test of disinfecting power, and the inference seems justified that an agent which will destroy the specific virulence of this material may also be relied upon for the destruction of the small-pox infection. The writer applied this test in a series of experiments made in 1880 and 1881, and published in the *Bulletin* of the National Board of Health. The results obtained have been summarized by Vallin, and, as his work is before me, I quote from it as follows :

Dougal and Baxter have shown the neutralizing power of sulphurous acid upon different kinds of inoculable virus. Both exposed for ten minutes, in an atmosphere saturated with sulphurous fumes, ivory points charged with dry vaccine virus. At the end of this time the neutralized virus was inoculated by three punctures in the arm of a non-vaccinated infant, while in the other arm, at the same time, three punctures were made with ivory points charged with the same virus, but not exposed to sulphurous acid. The last-

mentioned punctures were all followed by perfectly developed vesicles; the punctures upon the other arm gave no result. Unfortunately the quantity of the acid, or of sulphur burned, is not mentioned. This time, by exception, Baxter leaves us in doubt.

Dr. Sternberg, surgeon in the United States Army, has taken up these experiments in an ingenious manner, and with greater precision. This author burned a determined quantity of sulphur in a wooden box having a capacity of ten litres. He submitted to the vapors thus produced liquid vaccine virus, placed in a watch-glass, for a period of twelve hours. The following day unvaccinated infants were inoculated in one arm with the disinfected virus, and in the other with a portion of the same virus not exposed to the disinfectant.

Liquid virus thus exposed for twelve hours to the action of the fumes from 3 centigrammes of sulphur burned in the air-chamber—that is, 24 cubic centimetres of gas to 10 litres of air, or a little more than two parts in a thousand—produced but a single vesicle, while the non-disinfected virus in the other arm gave a successful result in every instance. Upon doubling the amount of sulphur,—that is, 6 centigrammes to 10 litres, or 6 grammes per cubic metre, or 5 volumes of sulphurous acid to 1,000 volumes of air,—and reducing the time of exposure to four hours, the vaccine still remained inactive after exposure.

It suffices, then, to burn 5 grammes of sulphur in a cubic metre of air, in order to neutralize liquid vaccine, but this vaccine coagulates almost immediately upon contact with sulphurous acid gas; and this contributes, perhaps, to destroy, or to modify, its inoculability. We shall see, further on, that experiment made in spaces of such small dimensions may lead to grave errors.

In order to disinfect dry vaccine, Sternberg found that a considerably larger quantity of sulphur was required, viz., 16 grammes per cubic metre, which corresponds with the classical proportion of 1 volume of sulphurous acid gas to 100 volumes of air. In this regard the experiments of Sternberg confirm those which have been obtained by many other authors.

Baxter has also tested the power of an aqueous solution of sulphur dioxide to disinfect the virus of glanders, and an infectious form of septicæmia—induced—in guinea-pigs. Four parts of  $\text{SO}_2$  by weight, added to 1,000 parts of the diluted virus of glanders, neutralized its infective properties, as determined by inoculation experiments. The septic virus was destroyed by 3 parts by weight in 100, while 6 in 1,000 failed. The time of exposure to the disinfectant in these experiments is said to have been from thirty minutes to three hours; but this is considered by Baxter to be a matter of secondary importance, and, according to him, disinfection is complete at the end of five minutes, when the virus has been intimately mixed with the disinfecting solution.

The wide limits (3 : 100 and 6 : 1,000) between success and failure in these experiments of Baxter, and an evident want of precision in the conditions, especially as to time, induced Vallin, from whom we have quoted the above results, to undertake additional experiments with the virus of glanders. He says,—

I had, in January, 1881, an opportunity to repeat these experiments. A patient in the service of our colleague, M. Gaujat, at Val de Grace, was attacked with glanders,—*absces farcineux multiples*,—and furnished an inoculable pus, with which Dr. Kiener produced in several animals—guinea-pigs, cats, etc.—the characteristic lesions of glanders. A small quantity of this pus obtained directly from the patient, and placed in a watch-glass, was exposed for twelve hours in a wooden box having a capacity of exactly 100 litres. Two grammes of sulphur were burned in this box,—an amount which corresponds with 20 grammes per cubic metre. The following day a guinea-pig was inoculated with the disin-

fecting virus. At the end of three months this animal remained in perfect health. Another guinea-pig, inoculated the same day with a second portion of the same virus preserved between two watch-glasses, and not disinfected, died at the end of two months with the characteristic lesions of glanders.

Additional experiments were made with the same virulent pus dried in the open air upon little squares of flannel. Inoculation with this material failed after exposure to sulphur dioxide generated by burning sulphur in the proportion of 15 grammes per cubic metre. But inoculation with the desiccated virus not exposed to a disinfecting agent also failed, and Vallin remarks that desiccation alone had perhaps sufficed to destroy the virus, as in the experiments of Galtier. Experiments were also made with pus obtained from a tuberculous abscess in a case of Pott's disease. This material was divided into two portions, and placed in watch-glasses. One portion was subjected for twelve hours to the action of sulphur dioxide generated by burning sulphur in the proportion of 20 grammes per cubic metre. This pus, injected subcutaneously into a guinea-pig, produced no result. At the end of four months the animal remained in good health. The non-disinfected pus injected into another guinea-pig caused its death on the forty-eighth day. Its liver, spleen, lungs, and peritoneum were filled with tubercle granules. Other experiments were made with pus obtained from two chancres "of doubtful nature." Inoculation with this material, after exposure to  $\text{SO}_2$  (15 grammes of sulphur per cubic metre of space), gave no result, while the non-disinfected pus produced "characteristic pustules."

In the experiments thus far recorded, the disinfecting power of the agent under consideration is fully established for certain kinds of material, and especially for vaccine virus. In my own experiments upon this material the results were extremely definite, and the conditions observed were such as to render them unimpeachable. Experiments upon original virus from various sources are especially valuable from a practical point of view, inasmuch as the results obtained are evidently reliable guides with reference to the destruction of infective virulence in the several kinds of material experimented upon, and this without regard to any theory as to the nature of the morbid agent. We know, however, that in several infectious diseases at least, this agent is a living organism or germ. It is therefore a matter of importance to determine the exact germicide power of this and other agents which have been proved to be useful disinfectants, and numerous experiments have been made with this object in view. If the germ theory of disease is correct, as applied to all infectious diseases, there should be a correspondence between the results obtained in experiments with original virus and those made upon pure cultures of the pathogenic organism to which such virus owes its infecting power. This is an interesting question in connection with the agent under consideration, inasmuch as Wernitz has shown that sulphurous acid promptly neutralizes the action of non-living ferments in comparatively small amounts, and there is therefore ground for the supposition that the specific disease poisons destroyed by this agent in the disinfection experiments above recorded were of this nature.

According to Wernitz,<sup>1</sup> the action of pepsine, of ptyaline, of invertine, and of diastase, is prevented by the presence of an aqueous solution of  $\text{SO}_2$  of 1 : 1317 to 1 : 860 (by weight); while the action of myrosine and of emulsine is neutralized by 1 : 21,000.

Wernich, of Breslau, experimenting in the Pathological Institute of Berlin, 1877, saturated strips of woollen or cotton goods with putrid liquids, and exposed them under a bell-jar containing a definite proportion of sulphurous acid gas. Then, with proper precautions, these strips were introduced into tubes containing Pasteur's culture solution, thoroughly sterilized. The development of bacteria in this fluid was taken as evidence that disinfection was not complete. The results obtained are summarized by Vallin<sup>2</sup> as follows :

When the strips of material were suspended for several hours under a bell-jar containing 3.3 volumes of sulphurous acid per 100 volumes of air, they were not disinfected. When the proportion of gas was increased to 7 per cent., or even to 4 per cent., the time of exposure being six hours, the strips of goods no longer fertilized culture liquids.

Schotte and Gärtner,<sup>3</sup> in 1880, experimented also upon the bacteria of putrefaction. In a chamber having a capacity of 40 cubic metres they placed, at various levels, shallow dishes containing culture liquids, into which putrefactive bacteria were introduced. Sulphur was burned in earthen vessels, placed about four feet above the level of the floor. When the amount burned was in the proportion of 15 grammes per cubic metre of space—an amount which gives one volume of  $\text{SO}_2$  to 100 volumes of air—it was found that at the end of six hours the gas had escaped to such an extent that it was possible to enter and remain in the room, although during the entire time the doors and windows had been carefully closed. The result of the experiment was, that the culture liquids exposed in the upper part of the chamber remained clear, while those placed upon the floor broke down at the end of from twenty-four to thirty-six hours. When the amount of sulphur burned was increased to 28 grammes per cubic metre (about two volumes per cent. of  $\text{SO}_2$ ), disinfection was complete. When the culture fluids were placed upon the shelves of a cupboard, "half closed," and situated in the corner of the chamber, disinfection was only obtained by burning 92 grammes of sulphur per cubic metre of space.

We remark that the test of disinfection was not satisfactory in these experiments. A certain amount of  $\text{SO}_2$  was, no doubt, absorbed by the exposed culture liquids; and these, in successful experiments, failed to break down, because of the antiseptic or restraining influence of this agent. But, to prove that the germs of putrefaction in these culture liquids were killed, it would have been necessary to inoculate fresh cultures with a small amount of this material which had been exposed to the action of a disinfectant.

<sup>1</sup> I. Wernitz, *Ueber die Wirkung der Antiseptica auf ungeformte Fermente*, Dorpat, 1881.

<sup>2</sup> Op. cit., p. 234.

<sup>3</sup> Viertelj. f. Oeff. Gesund., 1880, t. xii, pp. 337-376.

Other experiments were made by the authors named, which we shall quote in the language of Vallin :<sup>1</sup>

Strips of very thick woollen goods were soaked in culture liquids containing bacteria. These were dried, a proceeding which did not destroy the vitality of the bacteria, as proved by culture experiments. These strips were suspended from a cord stretched across the middle of the chamber at a level of about five feet above the floor. Half of the strips were left dry; the other half, after having been dried, were again moistened, so that they might be exposed in a moist condition to the sulphurous vapors. Our authors arrived at the following unexpected results: Even after having been exposed to the action of sulphur dioxide, produced by the combustion of 92 grammes of sulphur per cubic metre, the moistened strips caused culture liquids, in which they were placed, to break down at the end of three or four days. The dry strips exposed in the same way produced the same results somewhat sooner—*dans le 3e jour*. Gärtner and Schotte have concluded from this that the germs, or proto-organisms, hidden in the deeper portions of the very thick woollen goods, resist strong fumigations with sulphurous acid gas, or with other disinfectants. They arrive almost to the point of doubting the possibility of a certain and absolute disinfection, at least by the gases or vapors.

The limits of this paper admit only of a brief abstract of the elaborate experimental researches relating to the value of sulphur dioxide as a disinfectant, made by Koch<sup>2</sup> and by Wolffhügel,<sup>3</sup> under the auspices of the Imperial Board of Health of Germany, and published in the first volume of the *Mittheilungen aus dem Kaiserlichen Gesundheitsamte*.

The experiments of Wolffhügel relate to questions concerning the practical use of SO<sub>2</sub>, the best methods of producing it, etc., while those of Koch are designed to fix its exact germicide value. In Koch's first experiments sulphur dioxide was generated by burning sulphur in a box having a capacity of 290 litres. Other experiments were made in a closed chamber. The amount of SO<sub>2</sub> present was estimated at the outset and at various intervals. Thus in his third experiment, in which the disinfection box was used, the amount of SO<sub>2</sub> was,—

At first,	. . . . .	6.13 vol. per cent.
At the end of 24 hours,	. . . . .	4.88 “ “
At the end of 72 hours,	. . . . .	4.47 “ “
At the end of 96 hours,	. . . . .	3.3 “ “

In this experiment only spore-containing material was exposed in the disinfection box. This consisted of old dried milzbrand (anthrax) blood, anthrax spores dried upon silk threads, spore-containing earth, and hay bacillus spores dried upon blotting paper. The result was entirely negative: the developing power of the spores was not in any instance destroyed, even after ninety-six hours' exposure, and a mouse inoculated with the dried blood, exposed for this length of time, died promptly of anthrax.

The results obtained with material not containing spores were more satisfactory, but still not of a nature to give confidence in this agent as a reliable disinfectant for the purposes and in the manner in which it is commonly applied. The experiments show, in the first place, that it is not safe to apply the data obtained by burning sulphur under a bell-jar, or in a tight box of small dimensions, to disinfection on a large scale,

<sup>1</sup> Op. cit., p. 253.

<sup>2</sup> Op. cit., pp. 252-261.

<sup>3</sup> Ibid., pp. 188-233.

owing principally to the rapid loss of gas which occurs in an ordinary apartment, with all apertures carefully closed. Thus in Koch's fifth experiment in a closed chamber, the rapid loss of  $\text{SO}_2$  is shown by the following figures :

At the end of half an hour,	. . . . .	3.12 vol. per cent.
At the end of 2 hours,	. . . . .	1.25 " "
At the end of 22 hours,	. . . . .	.015 " "

In Experiment No. 2, made in a box having a capacity of 290 litres, anthrax bacilli, without spores, from the spleen of a mouse recently dead, and dried upon silk thread, were destroyed by exposure for thirty minutes to  $\text{SO}_2$  in the proportion of 1 vol. per cent.

In Experiment No. 7, also made in the box, the amount of  $\text{SO}_2$  at the outset was .84; at the end of twenty-four hours, .55. An exposure of one hour in this experiment destroyed anthrax bacilli (still moist) upon silk thread. Four hours' exposure failed to destroy the vitality of *Micrococcus prodigiosus* growing upon potato, but twenty-four hours' exposure was successful. The same result was obtained with the bacteria of blue pus.

In Experiment No. 8, it was found that an aqueous solution of  $\text{SO}_2$  of 11.436 per cent., by weight, did not destroy anthrax spores in twenty-four hours, but was successful in forty-eight hours. When the proportion of  $\text{SO}_2$  was reduced to 5.718 per cent., disinfection was only accomplished after five days' immersion in the aqueous solution.

According to Arloing, Cornevin, and Thomas, sulphurous acid does not destroy the bacteria of symptomatic anthrax, which contain spores.

The experimental results thus far recorded will perhaps prepare those who have heretofore had implicit faith in the disinfecting power of sulphurous acid, to accept, without too much incredulity, the following results obtained by the writer in recent experiments with this agent :

At the request of Dr William M Smith, health officer of the port of New York, I visited that city on the 9th of January, 1885, for the purpose of applying biological tests in an experiment designed to ascertain whether it is practicable to disinfect rags in the bale. A manufacturing chemist of New York proposed to accomplish this by injecting sulphur dioxide into the interior of the bales through hollow tubes. The  $\text{SO}_2$  had been compressed to the liquid form in copper cylinders, and being under a pressure of six atmospheres was expected to permeate the bale thoroughly when the valve was opened leading to the hollow and perforated screws introduced into it. The bale was to be placed in a closed chest of moderate dimensions, and disinfection was to be accomplished within a few minutes.

The experiment was made at the Baltic stores, Brooklyn, in the presence of Dr. Smith, health officer of New York; Dr. Raymond, commissioner of health of the city of Brooklyn; and several other gentlemen belonging to the health departments of New York and of Massachusetts.

The following material, which I had brought in sterilized tubes from the biological laboratory of Johns Hopkins University, Baltimore, was



introduced into the bale through openings made with a pocket knife. The depth of these openings was from two to four inches. The material to be disinfected was upon pledgets of cotton previously sterilized, which had been saturated with pure cultures of the various test-organisms. Some of these pledgets had been subsequently dried at low temperatures, others remained moist. The apertures in the bale were closed, after introducing these bits of cotton, by tamping in strips of old muslin. When these preparations had been made, the bale of rags was placed in the disinfection chamber, and the gas turned on. The time during which the gas was allowed to flow was three minutes and a half. The pressure, as shown by a gauge in connection with the copper cylinder, was eighty pounds at the commencement and seventy-five at the close of the experiment. The disinfection chamber was not tight, and all those in the vicinity were obliged to retire to a respectful distance to windward while the gas was flowing, and for a considerable time afterward, owing to the abundant escape and stifling effect of the  $\text{SO}_2$ . It was only after an interval of twenty or thirty minutes that the disinfection chamber could be approached to withdraw the bale; and after it had remained in the open air for some time, I was almost suffocated while removing the pledgets of cotton containing the test-organisms. These were at once placed, with sterilized forceps, in sterilized glass tubes, and each tube was at once plugged with sterilized cotton. In this way they were taken back to the laboratory in Baltimore, where the test of disinfection was completed by culture and inoculation experiments. The nature of the material and the results of the experiment are given in the following table:

Number of tube containing cotton pledget.	Nature of material.	Test by cultivation.	Result.	Test by inoculation.	Result.
No. 1.	<i>Bacillus anthracis</i> containing spores (dry).	One culture tube.	Abundant development of anthrax filaments in twenty-four hours.	One rabbit inoculated subcutaneously.	Died of anthrax on third day.
No. 2.	<i>Bacillus anthracis</i> containing spores (dry).	One culture tube.	Abundant development of anthrax filaments in twenty-four hours.	One rabbit inoculated subcutaneously.	Died of anthrax on third day.
No. 3.	<i>Bacillus anthracis</i> containing spores (moist).	Two culture tubes.	Abundant development in both.	One rabbit inoculated.	Survived the inoculation.
No. 4.	<i>Bacillus subtilis</i> spores (dry).	Two culture tubes.	Abundant development of <i>Bacillus subtilis</i> in both.		
No. 5.	<i>Bacillus subtilis</i> spores (moist).	Three culture tubes.	Abundant development of <i>Bacillus subtilis</i> in each.		

Other pledgets of cotton had been exposed in the bale, which had been saturated with tuberculous sputum ; but this part of the experiment was not followed up, owing to the scarcity of rabbits for inoculation.

Soon after my return to Baltimore, I received from the manufacturer, in New York, a copper cylinder, containing a liberal supply of  $\text{SO}_2$  in liquid form. With this the following experiment was made, January 25, in a closet having a capacity of eight cubic yards. This closet, in the basement of the biological laboratory, had been constructed under the stairway as a refrigerating chamber. The walls were double, and filled in with asbestos ; and the door, made in the same way, was fitted to close as accurately as possible, and held closed by a strong clamp.

A sufficient quantity of the liquid  $\text{SO}_2$  to produce ten volumes per cent., when volatilized in the closet described, was drawn from the copper cylinder into a large beaker, quickly placed upon the floor of the disinfection chamber, and the door closed. At the end of twelve hours the door was thrown open, and the gas permitted to escape. The test-organisms were exposed upon little pledgets of absorbent cotton, which had been saturated culture-fluids, containing the various micro-organisms employed. Some of these pledgets of cotton had been dried at a low temperature in advance of the experiment, and others were exposed moist.

Some of the prepared bits of absorbent cotton were placed in glass tubes, open at one end and sealed at the other. Other pledgets were loosely folded in a single thickness of heavy muslin, which had been sterilized by heat. The ends of these little packages were left open, so that the  $\text{SO}_2$  might have free access to the interior. These packages, properly labelled, were placed in the inside pockets of a coat, and this was suspended in the closed chamber used for the experiment. The glass tubes were placed in an open pasteboard box upon the floor of the disinfection chamber. Other pledgets of cotton, similarly prepared, were wrapped up in little bundles of cotton, weighing half an ounce each, and enveloped in a single layer of sterilized muslin. Still other pledgets were wrapped up in a woollen blanket in such manner that they were in the centre of a compact bundle, eighteen inches long and ten inches in diameter. The result, as determined by cultivation experiments, was as follows :

*Cotton pledgets exposed in glass tubes.*

*Micrococci* from case of vaccinal erysipelas, moist and dry. No development from the moist material ; abundant development of micrococci from dry material.

*Bacillus subtilis* (spores), moist and dry. Abundant development of *B. subtilis* at end of twenty-four hours from both moist and dry material.

*Bacillus anthracis* (spores), dry. Abundant development of anthrax bacilli within twenty-four hours.

*Cotton pledgets placed in coat pocket.*

*Micrococci* from case of vaccinal erysipelas, moist and dry. Two culture-tubes inoculated from each. Abundant development of same micrococci within twenty-four hours.

*Bacillus anthracis* (spores), moist and dry. Two tubes inoculated from each. Pure cultures of *B. anthracis* obtained in each within twenty-four hours.

*Bacillus subtilis* (spores), moist and dry. Two tubes inoculated from each. At the end of twenty-four hours a mycoderma of *B. subtilis* was found upon the surface of the culture-liquid in each of these tubes.

The complete failure thus far made it useless to open the bundles of cotton and the rolled blanket, which were put aside for further experiments.

On the 1st of February a second experiment was made in the same disinfection chamber upon test-organisms prepared as before. In this experiment the conditions were changed by the introduction of steam into the chamber through a tube connected with a retort outside. Two litres of water were evaporated, and the steam passed into the chamber during the first four hours of the experiment. The amount of  $\text{SO}_2$  in this experiment was increased to twenty volumes per cent.; the time of exposure was twelve hours; the result as follows:

*Organisms exposed in coat pocket.*

Coat suspended from wall, and pledgets of cotton loosely folded in filter paper, with ends of packages open for free admission of gas.

*B. subtilis* (spores), moist and dry. Abundant development in twenty-four hours in culture-fluids inoculated with the exposed spores.

*B. Anthracis* (spores), moist and dry. Abundant development of anthrax filaments in culture-tubes inoculated with this material.

*Micrococci*—pure culture—from blood drawn from inflamed area in a case of erysipelas. One moist and two dry pledgets. Pure cultures of this micrococcus were obtained from all of these after exposure in coat pocket as described.

*Organisms exposed on pledgets of cotton in open tubes placed upon the floor of disinfection chamber.*

*B. subtilis* (spores), dry and moist. Abundant development in culture-fluids.

*B. anthracis* (spores), dry and moist. Pure cultures obtained from exposed material.

*Micrococci*, from erysipelas (same stock as above), two pledgets, dry. Pure cultures obtained from both.

The complete failure to destroy the test-organisms under the conditions mentioned induced me to try the following experiment:

February 2.—Pure  $\text{SO}_2$  in liquid form was poured into a tube (experiment in duplicate) containing spores of *B. subtilis* on dry cotton. The rapid volatilization of the liquid produced, of course, intense cold. As the tube was long and narrow, and volatilization was restrained by the low temperature, the time of contact with the  $\text{SO}_2$  was at least ten minutes. The vitality of the spores thus brought in contact with the liquid  $\text{SO}_2$  was not impaired, as shown by culture experiments.

The experiment was repeated February 5 with anthrax spores upon *moist cotton*. The result was the same. Anthrax filaments appeared in cultures inoculated with these spores at the end of forty-eight hours.

It was evidently useless to extend these experiments so far as spores are concerned; but the question remained as to the practicability of destroying pathogenic micrococci and bacilli without spores. As Koch has shown that the loss of sulphur dioxide is very rapid from a room which is carefully closed to prevent its escape, the following experiments were made in a gas-tight receptacle:

*February 2.*—The following named test-organisms were placed under a bell-jar, having a capacity of one gallon. The jar was sealed below by resting in a trough containing mercury. Enough liquid  $\text{SO}_2$  to make twenty volumes per cent. was introduced into this jar, and was, of course, quickly volatilized. The time of exposure was eighteen hours; results as follows:

*Micrococci* (pure culture) obtained from a case of vaccinal erysipelas (culture started from drop of blood drawn from inflamed area). One moist and two dry pledgets of sterilized cotton, previously saturated with this culture, were exposed in glass tubes open at one end; also a few drops of the culture-fluid poured into a similar tube. Result negative; disinfection was complete, as proved by attempt to start cultures from the exposed organisms.

*Micrococci* (pure culture) from blood of woman with puerperal septicæmia (fatal case). Exposed one pledget of cotton, moist, in glass tube, and a few drops of culture-fluid in the bottom of two other glass tubes; disinfection complete.

*Micrococci* (pure culture) from vaccine vesicle. Exposed two pledgets of cotton, moist, and one tube containing a few drops of pure culture; disinfection complete.

*Micrococcus ureæ* (pure culture in beef tea). Exposed one pledget of cotton, moist, and one tube containing a few drops of culture; disinfection complete.

Having determined by this experiment that  $\text{SO}_2$ , even in the absence of moisture, may kill micrococci, a second experiment was made to ascertain whether the quantity of the disinfecting agent could be reduced so as to bring it more nearly within practical limits.

*February 7.*— $\text{SO}_2$  was introduced under the bell-jar, as above described, and the following test-organisms exposed to its action for twenty hours:

*Micrococci* from vaccinal erysipelas.<sup>1</sup> Exposed two pledgets of cotton, dry, in glass tubes. From one of these, cultures of this micrococcus were obtained; cultures inoculated from the other remained sterile. Two pledgets of cotton moistened with a recent culture were also exposed. Cultures from these remained sterile. A few drops of a fresh

<sup>1</sup> The writer does not commit himself to the view that the micrococci from the various sources mentioned are specifically different, and the cause of the morbid phenomena in the individuals from whose blood the cultures were started, inasmuch as he has not been able to obtain any definite proof that such is the case. On the other hand, he admits that it is extremely probable that they are concerned in the development of these morbid phenomena, and are, in fact, pathogenic organisms.

culture placed in the bottom of a glass tube subsequently fertilized—sterilized culture-fluids—failed to disinfect.

*M. ureæ*, exposed upon two pledgets of cotton, moist; disinfection complete.

In the above experiment, the material to be disinfected was placed near the bottom of the jar. In the following experiment a taller jar, having a capacity of five litres, was used, and the test-organisms were exposed upon a shelf near the centre of the jar. As before, liquid  $\text{SO}_2$  was introduced in an open beaker in a proper quantity to make four volumes per cent. The time of exposure was twenty-four hours.

*Micrococci* (pure culture) from vaccine vesicle, on cotton, moist; disinfection complete.

*Micrococci*, puerperal septicæmia, pure culture on cotton, moist; disinfection complete.

*Micrococci*, vaccinal erysipelas, pure culture on cotton, moist; failure to disinfect.

*Micrococci*, from vaccine vesicle, on cotton, dry, in duplicate; disinfection complete in one, failure in the other.

I have also tested the germicide power of an aqueous solution of  $\text{SO}_2$  on the above-mentioned micrococci, with the following results:

*February 5.*—Equal parts of a recent culture of micrococci from vaccine vesicle, micrococci from case of puerperal septicæmia, and *M. ureæ*, were added to a standard solution of  $\text{SO}_2$  containing five per cent. by weight. The time of contact was two hours, after which two culture-tubes were inoculated from each; no development occurred; disinfection complete.

*February 7.*—The standard solution of  $\text{SO}_2$  (five per cent.) diluted to 1 : 50 was added, in equal portions, to a pure culture of the micrococcus from vaccinal erysipelas (making the dilution 1 : 100 = .05 per cent. of  $\text{SO}_2$  by weight, or 1 : 2,000). Cultures inoculated after two hours' contact remained sterile. At the same time a solution of 1 : 100 was added to a culture of the micrococcus from a vaccine vesicle (*i. e.*, 1 : 4,000 by weight); in this case disinfection failed.

*February 10.*—The above experiment was repeated with the last-mentioned micrococcus with solutions containing 1 : 1,000, 1 : 2,000, and 1 : 4,000 of  $\text{SO}_2$  by weight (after admixture with the culture-fluid).

The result corresponded with that previously obtained. Disinfection was accomplished by the solution of 1 : 1,000 and 1 : 2,000, but failed when the amount was reduced to 1 : 4,000.

*February 11.*—The same result was obtained with a recent culture of the micrococcus from case of puerperal septicæmia, *i. e.*, the standard solution of five per cent., when diluted with forty-nine parts (1 : 50) of distilled water, in two hours' time destroyed the developing power of this micrococcus, while the same solution diluted to 1 : 100 (1 : 4,000 of  $\text{SO}_2$  by weight) failed to disinfect.

These results correspond with those reported by Jalan de la Croix, who found that one grain of  $\text{SO}_2$  in 2,000 of bouillon filled with growing

bacteria causes development to cease, and destroys the vitality of these bacteria. When spores were present, however, it was necessary to increase the amount to 1 : 135 (in how long a time?).

I may add, as a matter of interest, although not directly relating to our present object, that the same standard solution of five per cent. by weight, when added to culture-fluids in the proportion of 1 : 250 (= 1 : 5,000 of SO<sub>2</sub> by weight), prevents the development of all the above-mentioned micrococci, while 1 : 500 (1 : 10,000 of SO<sub>2</sub>) fails to prevent the development of the bacteria of putrefaction, or of the micrococcus from a vaccine vesicle, upon which organisms alone I have thus far tested the antiseptic power of this agent. These results also correspond closely with those of de la Croix, and show that sulphur dioxide ranks very high as an antiseptic.

In view of the experimental data recorded, it is evident that the use of sulphur dioxide for the disinfection of spore-containing material must be abandoned. This is the conclusion of Wolffhügel<sup>1</sup> on the basis of Koch's biological tests, and his own experiments. He is therefore inclined to abandon entirely the use of this agent for disinfecting purposes. He says, with reference to the question of its use for material not containing spores, that the answer to this question has very little interest from a practical point of view, as it is impossible to say in the present state of knowledge whether we have to deal with material free from spores or otherwise. Under the circumstances Wolffhügel thinks that we shall do well to abandon sulphur dioxide, and to use only such methods of disinfection as will be effective without reference to the presence or absence of spores.

I am not ready to go to this length, and to recommend the abandonment of an agent which enjoys the confidence of practical sanitarians for the destruction of the infection of small-pox, of scarlet fever, of diphtheria, of cholera, and of yellow fever, upon the ground that it fails to destroy the spores of the anthrax bacillus, or of *B. subtilis*; for the truth of the germ theory has not yet been definitely established for any one of the diseases named, and Wernitz has shown the power of this agent to neutralize non-living ferments. Admitting, however, as I do, the great probability that the infectious agent in these diseases is a living germ, we have good reason for believing that spores are not formed in any one of these diseases. We must not then be too exacting with reference to this agent until we are able to recommend something better in its place for the purposes to which it is commonly applied, viz., for the disinfection of apartments and ships.

My experiments show most conclusively that it does destroy the specific infecting power of vaccine virus dried upon ivory points when present in the air of a disinfecting chamber in the proportion one volume per cent., and that in aqueous solution it destroys the vitality of various micrococci in comparatively small amounts. It is even practicable to destroy these organisms dried upon pledgets of cotton by long

<sup>1</sup>Op. cit., vol. 1, p. 232.

exposure in gas-tight receptacles. But the conditions of success are such that it appears almost impracticable to conform with them in practice on a large scale, and it is evident that much of the so-called "disinfection" with this agent is a farce.

I am convinced that the percentage of  $\text{SO}_2$  present in the disinfection chamber, above a certain limit, is of less moment than certain conditions relating to the material to be disinfected. Thus, Koch succeeded in destroying the vitality of anthrax bacilli, still moist from the spleen of a mouse, and attached to silk threads, by exposure for one hour to .48 volume per cent. of  $\text{SO}_2$ , in a disinfection chamber the atmosphere of which was loaded with moisture. In my own experiments with vaccine virus upon ivory points a still smaller amount (5 volumes per 1,000) was effective in four hours' time. Here the favorable conditions are without doubt the very thin stratum of material to be disinfected, and the fact that it is thoroughly moistened.

Admitting that, in the absence of spores, micro-organisms suspended in the atmosphere, or attached to the surface of objects, may be destroyed by sulphur dioxide when generated in a sufficient quantity in a well-closed apartment and in the presence of moisture, the question remains whether the same object may not be as well accomplished by thorough ventilation, and by washing all surfaces—walls, ceilings, floors, furniture, etc.—with a 1 : 1,000 solution of mercuric chloride, which we know to be promptly destructive of germs of all kinds.

---

#### EXPERIMENTS WITH SULPHUROUS ACID GAS.

BY J. H. RAYMOND.

The following experiment was made in Brooklyn, at the request of the commissioner of health, with the object of determining the germicide value of sulphurous acid gas, produced by the burning of sulphur in the manner recommended by boards of health generally. Dr. George M. Sternberg, U. S. A, kindly proffered his services, and conducted the inoculation with the material prepared by him at Johns Hopkins University. The methods employed were the same as he has employed in similar experiments, and which he has repeatedly described. Dr. W. E. Griffiths, of Brooklyn, and the reporter assisted in the experiment.

The room selected was on the second floor of a private residence, and connected with it was a small clothes-closet. Two doors opened out from it,—one into the hall, the other into an adjoining room. The experimental room had a single window. All cracks and crevices by which fumes could escape were carefully closed by cotton. In the room were the following articles: A carpet on the floor; a wooden bedstead with springs, on which were two mattresses in close contact; a chair, over which was spread a bed-quilt; a sofa; an empty stand of drawers, on the top of which was placed a large book; the closet was empty. The

room and closet together contained, as nearly as could be ascertained, 1,850 cubic feet of air space, and were in free communication.

On the 18th of April pieces of blanket, about four inches square, soaked with blood from a rabbit killed while affected with septicæmia, and other similar pieces soaked with blood from another rabbit affected with anthrax, were exposed in different parts of the room, as hereafter described. Some of these pieces were folded double, with the blood inside the fold; others were left unfolded.

Piece No. 1, soaked with septicæmic blood, unfolded, was placed on the floor of the closet.

No. 2, septicæmic blood, unfolded, was pinned to the upper part of the window frame, eight feet from the floor.

No. 3, septicæmic blood, folded, was attached to frame of closet door, seven feet from the floor.

No. 4, septicæmic blood, unfolded, was placed between the mattresses, which were in close contact.

No. 5, septicæmic blood, unfolded, pinned to the under side of the bed-quilt, which was spread over the chair.

No. 6, anthrax blood, unfolded, placed on the closet floor.

No. 7, anthrax blood, folded, attached to frame of closet door, seven feet from the floor.

No. 8, anthrax blood, unfolded, placed between the lower mattress and springs.

No. 9, anthrax blood, unfolded, attached to frame of the door leading into the adjoining room, six feet from the floor.

No. 10, anthrax blood, unfolded, placed between the mattresses.

No. 11, anthrax blood, unfolded, placed under the carpet, eight inches from the edge, the carpet again laid down, but not tacked.

No. 12, anthrax blood, unfolded, placed in the middle of the book, between the leaves, the book being closed.

No. 13 was a piece of blanket soaked with anthrax blood, which was not exposed in the room, but was prepared for purposes of comparison.

No. 14 was another piece soaked with septicæmic blood, and also not exposed.

Two half-quills of fresh bovine vaccine virus were placed on the stand of drawers, and one half-quill on the top of the frame of the door leading into the adjoining room. The corresponding halves, similarly marked, were placed in a tight preserve jar, which was at once put in a refrigerator in another part of the house.

In the middle of the room was placed a large coal scuttle nearly filled with wet ashes, and in this an iron pot holding four pounds of broken sulphur and two pounds of flowers of sulphur. This was then well moistened with alcohol, and a lighted match applied. When the sulphur was well burning the door of the room was closed, which was at 1:25 P. M. At 11:25 P. M. the hall door and window were opened for one hour, and the room thoroughly aired. At the end of this time the odor of sulphur was distinctly perceived, but there was no difficulty of



breathing in any part of the room. The sulphur in the pot was completely consumed. At the end of the hour the door and window were again closed, and kept so until 10 A. M. the following day, the 19th. When the door was again opened the air of the room was so impregnated with sulphur that respiration was impossible, and an airing of ten minutes was necessary before it could be entered.

At the end of this time the pieces of blanket were collected, and at 12 M. healthy rabbits were inoculated by Dr. Sternberg with the blood soaked out from the pieces of blanket in sterilized beef tea. The rabbits, so fast as inoculated, were put in a cage, each in a separate compartment, and given the same numbers as those of the pieces of blanket, with the blood of which they had been inoculated. The inoculation was complete within an hour.

The vaccine which had been exposed to the fumes was put into the jar containing the non-fumigated virus, and the jar replaced in the refrigerator, where it was kept until the material was used in vaccination.

#### RESULTS.

Rabbit No. 3, inoculated with septicæmic blood from folded piece, which had been fumigated, was found dead in the cage at 7 A. M., April 21st, forty-three hours after inoculation. He was apparently well the night before; the exact time of death is not known.

Rabbit No. 14, inoculated with non-fumigated septicæmic blood, died at 2 P. M., April 21st, fifty hours after inoculation.

Rabbit No. 7, inoculated with anthrax blood from folded piece which had been fumigated, was found dead at 7 A. M., April 23d, ninety-one hours after inoculation, being apparently well the night before.

April 20th a child, 7 months old, previously unvaccinated, was vaccinated by Dr. Griffiths in two places upon the same arm, one with virus from the fumigated half, and the other with virus from the non-fumigated half, of the same quill. The latter was successful; the former failed utterly.

The same was practised upon a young lady, 20 years of age, showing no vaccine cicatrix, and stating that she had never been vaccinated, with a fumigated and a non-fumigated half of a quill with the same result, namely, failure from the fumigated and success from the non-fumigated slip.

A calf was vaccinated in the same way, on the inner sides of the two thighs, with the same result.

*Interpretation of Results.* There seems to be no doubt that sulphurous acid gas, produced from burning sulphur, destroys the vitality of vaccine virus: This has been heretofore demonstrated by Dr. Sternberg, and this experiment confirms it.

It will be noticed that the rabbit inoculated with non-fumigated septicæmic blood, No. 14, died, as did also No. 3, the one inoculated from the folded piece of blanket; while all the other rabbits, inoculated with

septicæmic blood, were apparently unaffected, and survived—even No 4, which was inoculated with blood from the blanket placed between the two mattresses in close contact. I cannot understand how the gas could more readily have found its way between the mattress, and destroyed the germs there placed, than between the folds of a small piece of blanket hung up in the room.

As the rabbit inoculated with non-fumigated anthrax was apparently unaffected, while one inoculated with fumigated anthrax died, I think no conclusions of any value can be drawn from this part of the experiment.

Finally, after a careful review of the experiments and its results, I am led to regard the vaccine experiment as a success, and confirming what has already been well settled—the experiment with septicæmia as unsatisfactory, and the one with anthrax as a failure.

As a matter of precaution, the rabbits were kept for one month after inoculation, at the end of which time all were well, save the three already referred to.

NOTE.—The experiment with the septic virus seems to me to have been quite satisfactory and definite. The *temoin* died at the proper time, showing the potency of the virus. This potency was destroyed by the action of the sulphur dioxide in every case except in that in which the piece of blanket was folded, while the septic blood was still moist. This was the most difficult test, as the layer of dried blood to be penetrated was twice as thick as in the unfolded pieces of blanket, and it was necessary that the gas should penetrate an entire thickness of blanket saturated with dried blood, in order to reach the germs included in the material on the inside which cemented the folds of blanket together. The failure of the *temoin* in the anthrax experiment is a sufficient reason for excluding this part of the experiment. This failure was no doubt due to the fact that my anthrax stock is very much “attenuated” in virulence by having been cultivated in fluid media through many successive generations, and exposed often for weeks to the action of oxygen in the hermetically sealed flasks in which I keep my pure cultures. I have found that this same stock fails completely to kill white rats, but it commonly kills rabbits. Possibly the *temoin* in this experiment did not receive as large an amount of material as was injected into the rabbit, which died from the inoculation with anthrax blood taken from the folded blanket. The fact that this rabbit did die shows the virulence of the material, and it is extremely probable that this virulence was destroyed by the disinfectant in the unfolded pieces of blanket, although, as stated, this cannot be accepted as demonstrated, owing to the fact that the *temoin* did not die.

G. M. STERNBERG.

---

#### EXPERIMENTS ON BURNING SULPHUR IN CLOSED ROOMS, UNDER DIRECTION OF J. H. RAYMOND.<sup>1</sup>

In these experiments the following points have been considered: The action of sulphur fumes on various ordinary insects and different kinds of cloth, the amount of sulphur which may be burned in a given volume of air, the volume of gases resulting, and the nature and extent of the decomposition of sulphurous acid in the presence of moisture after the combustion of the sulphur in the process of disinfection.

As being closely connected with these subjects, we also include in this report the following statement of the physical changes which sulphur

<sup>1</sup> By W. H. Kent, Ph. D., chemist to the the Brooklyn Health Department.

undergoes in the process of combustion. This we quote from Lunge's standard work on the "Manufacture of Sulphuric Acid:"

Sulphur melts at  $111.5^{\circ}$  C. ( $232.7^{\circ}$  F.), and forms a thin light yellow liquid, which, on being more strongly heated, becomes darker and thicker; at  $250^{\circ}$  to  $260^{\circ}$  C. ( $480^{\circ}$  to  $500^{\circ}$  F.), it is nearly black, and so viscid that it does not run out when the vessel is upset; at a still higher temperature it becomes thinner again, keeping its brown color; and at  $440^{\circ}$  C. ( $824^{\circ}$  F.) it boils, forming a brownish red vapor; but it begins to volatilize before boiling.

This is by heating out of contact with the air. When heated in the air, the same changes take place until the temperature of combustion is reached, which, according to Lunge, is  $260^{\circ}$  C. ( $482^{\circ}$  F.). It then takes fire and burns with a purplish blue flame, forming  $\text{SO}_2$ , and giving out 2,221 metrical units of heat.

In consulting the literature of the subject, we find a very important article on the "Value of Sulphurous Acid as a Disinfecting Agent," by Dr. G. Wolffhügel, which in this connection should be noticed. Dr. Wolffhügel<sup>1</sup> gives experimental work on the following questions:

1. How may the requisite amount of sulphurous acid be with safety produced by means of burning sulphur in closed rooms?

2. What method is best adapted to determine the amount of sulphurous acid in the air, and the amount of gas taken up by the disinfected articles?

3. To what extent does the sulphurous acid in the air deviate from the amount calculated from the sulphur burned? What are the causes of this deviation, and how is the loss to be limited?

4. Does the gas formed distribute itself uniformly through the room, and do the articles in the room take up a large amount of the gas formed?

5. Does the gas leave the disinfected articles uninjured, or are they depreciated in value by treatment with sulphur?

6. What concentration of the gas suffices for the purposes, and what arrangement of the experiment is necessary to guarantee the results of disinfection?

Following this article in the same publication (pp. 234-282) is also one by Dr. R. Koch, in which, in connection with other disinfectants, he considers the amount of sulphurous acid, and time necessary to kill certain microscopic organisms.

With this mere notice of the nature of these papers, we pass to a description of our own experiments.

For a confined space in which to burn the sulphur, a room entirely enclosed by wood was at first used. The pine boards forming the walls, ceiling, and floor were generally matched, but in spite of continued calking with rags, its condition, as to tightness, remained unsatisfactory; however, three experiments with burning sulphur were performed, and a part of the desired results obtained. It was then abandoned, with the idea that the results, with regard to the amount of sulphur which it is possible to burn in a given space, would be of no value. We will call

<sup>1</sup> *Mittheilungen aus dem Kaiserlichen Gesundheitsamte*, vol. 1, pp. 188-233. Berlin, 1883.

this room *Room A*, and the small bed-room, with plastered walls, which was afterwards used, *Room B*. *Room A* was sixteen and one half feet long, eight and one third feet wide, and eleven feet high, and contained therefore 1,512.5 cubic feet (42,831.8 litres or 42.8318 cubic metres). In one side was a window about two by two and one half feet; in the adjacent side nearer the floor was also a single pane of glass about eight by ten inches.

*Experiment No. 1, Room A.*—In a large tin pan holding about twelve quarts (ordinarily known as a dish-pan) was placed an iron kettle holding five and one half quarts, and supported in the pan by an earthen plate; in the kettle were placed six pounds of broken brimstone and flowers of sulphur, and surrounding it, in the pan, were 8 litres (about 8 quarts) of water. The kettle stood in the water therefore to the extent of about half its height. In the water was placed a maximum and minimum thermometer. Before the larger window was suspended in the room one wire fly-trap with about a dozen flies, another with six or eight ants, and another with half a dozen croton bugs (*Ectobia Germanica*). The fly-traps used in these experiments were made of tinned wire,—those painted with Paris green being in all cases avoided. There was also a thermometer so hung inside the room by the window as to show the temperature of the room from outside. Suspended on a line in about the centre of the room were one hundred and sixteen samples of various kinds of cloth, the coloring matters of which had been determined by Dr. O. Grothe. The samples consisted of,—

Eighteen samples of all wool dress goods (Sicilian cord) dyed with various combinations of logwood black, logwood brown, picric acid, indigo carmine, and Bordeaux.

Eight samples of silk dress goods (silk cord), which were also variously dyed with Bismarck brown, nigrosine, alkali blue 2 B, Bordeaux, tropæline 3 O No. 2, and roacelline.

Eleven samples of domestic calicoes printed in many figures with catechu brown, logwood black, logwood blue, alizarine red, aniline yellow, and aniline blue.

Twelve samples of French satins also printed with aniline black, aniline yellow, alizarine red, indigo, logwood black, fiset wood, eosine, nigrosine, Bordeaux, and alkali blue.

Twenty-four samples of Scotch gingham colored with different combinations of Bismarck brown, logwood black, logwood blue, logwood brown, indigo, aniline blue, aniline yellow, alizarine red, alizarine rosa (tin salts), catechu brown, tropæline O (chrysoine), turmeric, tropæline O 4, fiset wood, and vesuvine.

Twenty-four samples of domestic cambrics variously printed with aniline blue, aniline yellow, logwood black, logwood blue, logwood brown, alizarine red, catechu brown, indigo, indigo carmine, naphthaline yellow, induline, and wood blue with chromine.

Three samples of oriental flannels dyed with induline, malachite green, and Bordeaux.

Sixteen samples domestic flannels dyed with Bordeaux, Victoria yellow, fuchsine, methyl violet, logwood black, alizarine red, induline, and brilliant blue (alkali blue 5 B). Duplicate samples of each of these were retained for comparison afterward. Those exposed to the sulphur fumes were numbered the same as the original, and with the additional mark of the letter *x*.

The sulphur was ignited with burning alcohol, and the room closed as soon as possible.

The time necessary for killing the insects, as observed from the window outside, was as follows :

All flies were dead in 22 minutes; all ants were dead in 24 minutes; all croton bugs were dead in 25 minutes.

The temperature of the room as noted each half hour was as follows :

10:35 A. M.,	73° F.	—at beginning.
11:05 "	85° "	
11:35 "	91° "	
12:05 P. M.	94° "	} The room became cloudy with smoke so that the burning sulphur could not at all times be seen.
12:35 "	96° "	
1:05 "	97° "	
1:35 "	95° "	—Saw the flame for the last time.
2:05 "	93° "	
2:35 "	90° "	
3:05 "	89° "	
3:35 "	89° "	
4:05 "	88° "	
4:35 "	88° "	
5:05 "	87° "	
5:35 "	86° "	
6:20 "	85° "	

At 8:30 P. M. the room was opened.

Of the 6 lbs. of sulphur introduced, 5 lbs. and 9 oz. were burned; the remaining 7 oz. consisted of sulphur, sulphide of iron, and impurities. Owing to the reduction of temperature, it would not in any case be expected that the sulphur would be completely consumed.

Of the 8 litres of water introduced in the pan, 6.39 litres remained; 1.61 litre was, therefore, evaporated. The temperature of the water, which at the beginning was 71° F., had risen to 158° F.

The samples of cloth were then arranged in series by the side of the original, and exhibited to a number of persons, some of whom were experienced dry goods salesmen, and were really experts in judging the qualities of fabrics. The general opinion was that as to strength of fibre, no change in any case could be discerned; that as to color, one sample of Sicilian cord, colored with indigo and induline, and one sample of domestic flannel, colored with brilliant blue (alkali blue 5 B), were very slightly faded; that one sample of oriental flannel, colored with malachite green, was not quite so bright; that one sample of oriental flannel and one sample of domestic flannel, each colored with induline, were somewhat faded; that with the remaining one hundred and eleven samples there was no perceptible change. It is also observed that among the flannels

only two were colored with induline, and that these, as above expressed, were the most affected, and that the only piece of woollen dress goods which contained induline was the one which was very slightly faded.

*Experiment No. 2, Room A.*—In this experiment an attempt was made to reach the limit of sulphur which might be burned in the room. Thirty-two lbs. 5 oz. of sulphur were placed in two kettles;—one kettle, with 16 lbs. 4 oz. placed in the tin pan as before, was surrounded with 8 litres of water; the other, with 16 lbs. 1 oz., was placed in a wooden tub, and around it were 25 litres of water. In each case fully one half of the kettle stood below the surface of the water. There was also suspended in the room, the same as before, a set of samples of the same fabrics from which those before used were taken, numbered the same, and for distinction marked with the letter Y. The thermometer was also hung before the window, the sulphur ignited with alcohol, and the room closed as before. The temperature was as follows :

1:00 P. M.,	122° F.
1:30 "	124° "
2:00 "	124° "
2:30 "	126° "
3:00 "	129° "
3:30 "	131° "
4:00 "	131° "—Maximum = 55° C.
4:30 "	130° "
5:00 "	128° "
5:30 "	121° "
6:00 "	115° "
6:30 "	109° "

At 9 P. M. the sulphur ceased burning.

On the following day the room was opened. The sulphur fumes had escaped so that it could be entered immediately. Of the 16 lbs. 4 oz. sulphur placed in one kettle, 6 oz. remained, and of the 16 lbs. 1 oz. placed in the other, 9 oz. remained, or of the 32 lbs. 5 oz., 31 lbs. 6 oz. were burned; the remaining 15 oz. consisted of sulphide of iron, sulphur, and impurities.

Since the room contained about 1,500 cubic feet, the amount burned was nearly 21 lbs. per 1,000 feet.

The water surrounding the kettle was found to contain much sulphuric acid. From the following calculation it is concluded that the amount burned was largely in excess of what was necessary to consume the oxygen of the air, and as the sulphur was practically all consumed, the room must be considered as not sufficiently tight for the experiment.

*The Amount of Sulphur Necessary to Completely Consume the Oxygen in 1,000 Cubic Feet of Air.*—Since the atomic weight of S is 32, and that of O is 16 (one half that of S), and since by burning sulphur  $\text{SO}_2$  is formed, a compound with one atom of S and two of O, the weight of sulphur in  $\text{SO}_2$  is just equal to the weight of oxygen; so the amount of sulphur necessary to completely burn the oxygen of the air is equal to the weight of the oxygen in the air.

One litre of air at 0°C weighs 14.43 criths (Cooke), or as one crith=.0896 gramme, one litre of air weighs 1.2929 gramme. At 55°C., the temperature to which the air was heated by the burning sulphur, one litre =  $\frac{1.2929}{1 + \frac{0.000866 \times 55}{55}} = 1.0762$  gramme. One cubic foot = 28.318 litres, or 1,000 cubic feet = 28,318 litres. In 1,000 cubic feet there are therefore 30,475.8 grammes, or 67.186 pounds of air. As 23.185 per cent. of the air is oxygen, the amount of oxygen in 1,000 cubic feet is  $67.186 \times 23.185 = 15.577$  lbs.; or, in accordance with the above, 1,000 cubic feet of air would need for the complete burning of the oxygen 15.577 lbs. of sulphur. Of course the low temperature and the highly diluted form the oxygen attains would both tend in practice greatly to reduce this amount.

Vallin<sup>1</sup> states that, experimentally, M. Marty was able to burn only 68 grammes per cubic metre, or about 4.2 lbs. per 1,000 cubic feet, and that Czernicki was able to burn in a large room 300 grammes per cubic metre, or 18.7 lbs. per 1,000 cubic feet. The room in the latter case was undoubtedly not tightly closed, as a comparison of his results with the theoretical amount will show. As to the effects on the fabrics in this experiment, no difference could be noticed from that of the experiment before given. The samples of cloth in both experiments are arranged in convenient form with those of the original, and may be examined at the office of the Department of Health in Brooklyn.

*Experiment No. 3, Room A.*—It having been asserted that burning sulphur is not always effective in killing insects, and especially flies on the ceiling, another experiment was made to ascertain with more certainty whether flies are killed uniformly throughout the room where the usual amount of 3 lbs. of sulphur per 1,000 cubic feet is burned. To this end a window was placed next the ceiling by the upper front left corner of the room, and another by the diagonal corner of the left side next the floor. A fly-trap with a number of flies was placed by each window next the ceiling and floor. Flies in traps were also placed at the upper back right corner and on the floor by the diagonal corner of the right side; one was also placed on the centre of the floor, and another on the centre of the ceiling, and one by the window in the centre of the left side. There were also a number of flies, perhaps fifty, confined loose in the room, going where they chose. An iron kettle, with 4 lbs. and 9 oz. of sulphur, was placed in water in the large pan, the sulphur ignited, and the room closed as before. The flies next the ceiling, as observed from the window at the upper front left hand corner, were all dead in twenty-three minutes; those by the large window on the left side also in twenty-three minutes; those on the floor at the back left hand corner were dead in fifty minutes; while some of the flies loose in the room, that had collected mostly by the small window in front, near the floor, lived for one hour and forty-five minutes.

The sulphur fumes, being heated, evidently rose at first to the upper part of the room. The room was then immediately opened, the sulphur

<sup>1</sup>"Traité des Désinfectants," p. 243.

extinguished, and as soon as the room could be entered it was found that in all portions of the room which could not be seen from the windows all flies were dead. It would seem, therefore, that when the flies are simply confined in a room not especially tight, they were able by the greater liberty afforded them to withstand the action of the sulphur fumes much longer than when confined to a particular locality in traps. By weighing the kettle and the remaining sulphur, it was found that four pounds of sulphur were burned.

*Experiment No. 4, Room B.*—This room, provided with an ordinary window and door, measured as follows: 8 ft. 2 in. long, 6 ft. 2 in. wide, and 7 ft. 7 in. high, containing, therefore, 375 cubic feet. All crevices were thoroughly calked. In an iron pot was placed 16 lbs. 3 oz. sulphur. This was placed in the above described tin pan, and surrounded by nearly 10 litres of water. A maximum and minimum thermometer was hung on the wall, showing a temperature at the beginning of 76° F. In order to ascertain whether sulphuric acid would be formed, and whether the cloud of smoke arising from burning sulphur was due to the formation of this acid, or to sublimed sulphur, or both, a pane of glass 7 by 12 inches was thoroughly cleaned, wiped dry with a clean cloth, and supported horizontally in the middle of the room by a clean glass support. The sulphur was ignited, the door thoroughly calked, and, it being Saturday P. M., it was left to take its course. The sulphur continued to burn for about twelve hours. When opened on Monday the atmosphere was not endurable. The temperature of the room had risen to 122° F. (50° C.), as shown by the maximum thermometer. Of the 16 lbs. 3 oz. sulphur introduced, 2 lbs. 2 oz. had been burned, or at the rate of 5 $\frac{2}{3}$  lbs. per 1,000 cubic feet. The pane of glass was found to be covered with a fine, dew-like deposit, and its extremely sour taste indicated that it must contain sulphuric acid. This was carefully washed with distilled water into a clean flask. The washings unmistakably held sulphur in suspension. The amount of sulphur deposited on the pane of glass was determined after filtering from the H<sub>2</sub>SO<sub>4</sub> solution by oxidizing with nitric acid, precipitating and weighing as BaSO<sub>4</sub>. From this the amount of sulphur deposited on the glass plate was found to be .0014 gramme. Since the surface of both sides of the glass pane was 168 square inches, and the surface of the ceiling and floor 14,504 square inches, the amount of sulphur deposited on the ceiling and floor would be .1208 gramme. Assuming that it would be deposited on the walls at the same rate, which may not be entirely the case, there would be deposited on the walls, ceiling, and floor .3817 gramme, or 5.88 grains of sulphur. This amount, though not large, is sufficient to account for the slightly dingy appearance of a room immediately after fumigation, and in part also for the cloud of smoke that arises from the burning sulphur. The sulphuric acid in the filtrate, as above obtained, was precipitated as BaSO<sub>4</sub> after the addition of HCl and the BaSO<sub>4</sub> filtered and weighed. The H<sub>2</sub>SO<sub>4</sub> calculated therefrom was .0848 gramme. The amount deposited on ceiling and floor, as calculated from this amount



deposited on the pane of glass, is 7.3210 grammes, and assuming as above that it would be deposited at the same rate on the walls of the room, there would have been formed 15.2 grammes or about 234 grains of sulphuric acid.

*Experiment No. 5, Room B.*—It being sometimes the practice to place the pot of sulphur on dry ashes instead of in water, the question now arises as to whether by so doing there is the same amount of sulphur burned, and also whether the same amount and relative proportion of sulphuric acid and sulphur are set free, as found in the preceding experiment. In order to ascertain these points the following experiment was arranged :

The large tin pan heretofore used was nearly filled with ashes, and placed near the middle of the room. On the ashes was placed an iron kettle with 8 lbs. of sulphur. An ordinary pane of glass, 9 by 12 inches, was thoroughly cleaned, and horizontally supported about  $1\frac{1}{2}$  foot from the floor with a clean glass support. On the wall was also a maximum and minimum thermometer showing a temperature at the beginning of the experiment of  $80^{\circ}$  F. The sulphur was ignited with burning alcohol, and the room thoroughly closed. On opening the room the following day all smoke had subsided, but sulphur fumes were so strong that it could not be immediately entered. By weighing the pot of remaining sulphur it was found that 2 lbs. 7 oz. had been consumed, or at the rate of  $6\frac{1}{2}$  lbs. per 1,000 cubic feet, which, as will be noticed, is  $\frac{1}{8}$  lb. per 1,000 cubic feet more than was burned when the kettle was placed in water. Of course this is due to the fact that the water takes some heat from the kettle and its contents, and thereby reduces its temperature. The thermometer on the wall showed a minimum temperature of  $73^{\circ}$  F., and a maximum temperature of  $113^{\circ}$  F. On the glass plate was the same dew-like deposit as before, but showing the presence of sulphur much more distinctly. The deposit was carefully removed with distilled water to a glass receptacle, the sulphur filtered therefrom, oxidized with nitric acid, and precipitated with barium chloride. By weighing the precipitate of  $\text{BaSO}_4$  and calculating the sulphur, it was found that .0228 gramme of sulphur had been deposited on the glass plate. Calculating from this, the amount deposited on the ceiling and floor would be 1.5310 gramme. If deposited on the walls at the same rate the entire amount formed in the room would be 4.8352 grammes (74.5 grains). The sulphuric acid in the filtrate from the sulphur thus obtained was precipitated and weighed as  $\text{BaSO}_4$ , from which it was ascertained that .1209 gramme  $\text{H}_2\text{SO}_4$  had been deposited on the plate, or 8.1145 grammes on the ceiling and floor. Calculating as before, the total amount deposited in the room would be 25.6397 grammes, or 394.85 grains.

The presence of sulphur and sulphuric acid as found in these experiments is in accordance with the statements of Vallin (pp. 243 and 245). He terms the sulphur thus formed, however, sublimed sulphur, or sulphur vaporized from the original mass, and escaping the flame without being burned. From the following it will hardly appear that it is sub-

limed sulphur. According to Richter sulphurous acid in aqueous solution gradually undergoes the following reaction,— $3\text{SO}_2 + 2\text{H}_2\text{O} = 2\text{H}_2\text{SO}_4 + \text{S}$ ,—from which we would see that sulphur and sulphuric acid are formed by the action of sulphurous acid on water, and in the proportion of 196 parts of sulphuric acid to 32 parts of sulphur. The conditions in the case of burning sulphur for disinfecting purposes differ from these only in this, that the sulphurous acid and water are in the gaseous form. The relation of the amount of sulphuric acid and sulphur deposited on the glass plates in these experiments may be taken as approximately expressing the relation of the total amounts formed, and this relation is sufficiently near that of 196 to 32 to make it probable that it is formed, mostly at least, from the decomposition of sulphurous acid.

Another point of chemical interest, and which may have some practical bearing in this connection, is the fact that much more sulphur and sulphuric acid are formed when ashes are used than when the receptacle for the burning sulphur stands in water. In all those cases where the burning sulphur was surrounded by water, it has been observed that a considerable amount of water is evaporated. The atmosphere of the room must therefore be charged with moisture.

It is known in the ordinary method of making sulphuric acid that an excess of water or steam interferes with the oxidation of the sulphurous acid; and, although the conditions are not the same in the two cases, the results above obtained show a resemblance in this respect.

As to the amount of water present when ashes are used, we know there is always a small amount of moisture in ordinary air, and that when alcohol is used to ignite the sulphur as in these cases, some water is formed by the combustion of alcohol; so it is apparent that there is a considerable amount of water present to carry out the decomposition of the sulphurous acid. A fact of ordinary observation in a chemical laboratory is that a solution of sulphurous acid in water only very gradually undergoes decomposition, and that even in the presence of strong light some weeks may be necessary to make much change. This would corroborate the conclusion we would draw, that an excess of water interferes with the decomposition of sulphurous acid; that if the presence of sulphuric acid is necessary to kill the organisms, the amount may be increased by avoiding the presence of too much water; and that if the formation of sulphuric acid is to be avoided, placing the receptacle for the sulphur in water is very effective to that end.

*The Effect of Burning Sulphur on the Volume of Air Confined.*—By burning sulphur in hermetically closed places, the question as to whether the volume will become changed so as to cause an injury to the walls, or possibly an explosion, is considered as follows:

Since by the consumption of the  $\text{O}_2$  of the air  $\text{SO}_2$  is formed, and since to form one molecule of  $\text{SO}_2$  one molecule of  $\text{O}_2$  is necessary, we have formed according to the equation,  $\text{S}_2 + 2\text{O}_2 = 2\text{SO}_2$ , as many molecules of  $\text{SO}_2$  as is consumed of  $\text{O}_2$ , and so, according to Avogadro's law, the volume of  $\text{SO}_2$  formed is equal to the volume of  $\text{O}_2$  consumed, or, in

other words, there is no increase or decrease in the volume of the air except that which comes as expansion by heat.

It being very seldom that perfectly tight compartments are found, and as gases in general are so very elastic, the amount of pressure exerted on the walls by such expansion would in most cases be insufficient to do any damage.

---

### SULPHITES.

BY GEORGE M. STERNBERG.

*Sodium Sulphite and Sodium Hyposulphite.*—My experiments made at San Francisco<sup>1</sup> show that these salts in concentrated solution have no germicide power. The micrococcus of pus was not killed by exposure for two hours to a 32 per cent. solution, and a saturated solution failed to destroy the bacteria in broken-down beef tea. Arloing, Cornevin, and Thomas found that exposure for forty-eight hours to a 50 per cent. solution of sodium hyposulphite does not destroy the virus of symptomatic anthrax. It is evident, from the experimental evidence on record, that these salts have no value, either as germicides or as antiseptics, *except in the presence of some chemical agent which will liberate the sulphurous acid.*

*Bisulphite of Lime, Bisulphite of Zinc, Bisulphite of Soda, Tersulphite of Aluminium.*—A manufacturing chemist of New York sent me, last spring, samples of the above mentioned salts in solution, and I made a number of tests to determine their comparative germicide power. The results obtained indicate that their value as disinfectants depends upon the amount of sulphurous acid which they contain. All of the solutions gave off sulphurous acid gas constantly when not kept in tightly corked bottles; and, in adding them to broken-down beef stock, an abundant liberation of this gas occurred.

The solution of bisulphite of lime gave the best results. In the proportion of 5 per cent. this destroyed the vitality of *M. tetragenus*, the test organism employed. The solution of bisulphite of zinc and tersulphite of aluminium failed to destroy the same micrococcus in the proportion of 5 per cent., but were successful in 10 per cent. The solution of bisulphite of soda failed upon the same organism in 10 per cent. I have lost my memorandum giving the specific gravity of these solutions, but believe them to have been saturated solutions of the salts named.

---

### DRY HEAT.

BY GEORGE H. ROHÉ.

The first accurate observations on the disinfecting power of dry heat were made by Henry, of Manchester, in 1831.<sup>2</sup> Henry exposed (fresh?)

<sup>1</sup>"American Journal of the Medical Sciences," April, 1883.

<sup>2</sup>E. Vallin: "Traite des Désinfectants," Paris, 1882, p. 226.

vaccine virus to temperatures varying from 50° to 82° Cent. (122°-180° Fahr.) for two, three, and four hours, and secured complete disinfection, none of the specimens of vaccine thus exposed producing vaccinia when subsequently inoculated. Exposure for three hours to a temperature of 49° C. (120° F.) failed to disinfect. No control experiments with non-disinfected virus were made by this observer.

E. B. Baxter<sup>1</sup> exposed dry vaccine to a temperature of from 90°-95° C. (194°-203° F.) for thirty minutes. Disinfection was complete. Vaccination with disinfected virus was unsuccessful. Control inoculations with non-disinfected virus were successful.

Carstens and Coert reported to the International Hygienic Congress of 1879 (quoted by Vallin in the above-mentioned work) the following conclusions :

Fresh animal vaccine heated to 64.5° C. (148° F.) for thirty minutes loses its virulence. Fresh animal vaccine heated to 52° C. (125° F.) for thirty minutes does not lose its virulence. The maximum degree of heat to which fresh vaccine can be exposed without losing its infectivity probably varies between 52° and 54° C. (125°-129° F.).

Davaine, in 1873, destroyed the virulence of fresh anthrax blood<sup>2</sup> by exposing it to temperatures of 55° C. (131° F.) for five minutes, 50° C. (122° F.) for ten minutes, and 48° C. (118° F.) for fifteen minutes.

Werner, in 1879, exposed putrefactive bacteria on pledgets of cotton, and then enveloped in dry cotton to a temperature of 125° C. (257° F.) for one hour, and secured complete disinfection.

Wernich<sup>3</sup> exposed putrid material (containing bacteria of putrefaction) to temperatures of from 125°-150° C. (257°-302° F.) for five minutes with like success.

Schill and Fischer<sup>4</sup> found that exposure for one hour to a temperature of from 100°-130° C. (212°-266° F.) destroyed the virulence of tuberculous sputum, as tested by the inoculation of rabbits and other animals.

Koch and Wolffhügel<sup>5</sup> experimented with a large number of pathogenic and non-pathogenic organisms. A temperature varying from 78°-123° C. (172°-253° F.) maintained for one hour and a half (over 212° F. for an hour) sufficed to kill micrococcus prodigiosus and the bacilli of septicæmia of mice and rabbits, but failed to destroy the spores of bacillus anthracis, and of various non-pathogenic bacteria and fungi.

Micrococci and bacilli containing no spores, and spores of mould fungi, were completely killed by one and a half hour's exposure to a temperature of from 120°-128° C. (248°-262° F.) ; but spores of *B. subtilis*, *B. anthracis*, and of a bacillus growing upon potato, resisted a second heating to the same temperature for a similar length of time.

These authors further experimented upon a number of organisms disposed in various ways in the disinfecting chamber so as to approach in

<sup>1</sup> "Report Medical Officer of Privy Council," etc., N. S., No. vi, p. 216.

<sup>2</sup> Containing bacilli, but no spores.

<sup>3</sup> "Deutsche Med. Wochenschr.," 1880, p. 498.

<sup>4</sup> Mitt. a. d. Kais. Gesundheitsamte, Bd. II, S. 134.

<sup>5</sup> Mitt. a. d. Kais. Gesundheitsamte, Bd. I.

a measure the conditions of practical disinfection. Some of the articles were placed in coat pockets, others rolled up in balls of cotton, oakum, blankets, or soiled clothing, making packages of different thickness and density. The organisms consisted of micrococcus prodigiosus, micrococcus of blue pus, *B. anthracis*, and bacilli found in garden soil. With each package was placed a registering thermometer to indicate the highest temperature reached during the experiment. The temperature in the chamber varied from 133° to 156° C. (271°–313° F.), and the exposure was continued for three hours and ten minutes. The temperature in the different packages varied from 74.5° C. (167° F.) to 121.5° C. (251° F.). In none of the packages were the spore-bearing organisms destroyed. In a small iron vessel hanging free in the chamber, and containing specimens of the same organisms, a temperature of 139.5° C. (283° F.) was indicated by the thermometer. Here complete disinfection had taken place.

Another series of observations, with the temperature in the chamber varying from 131°–140° C. (267°–284° F.), and exposure continuing for three hours, resulted as follows: The organisms (micrococcus prodigiosus, spores of *B. anthracis*, and of bacilli of garden soil) and registering thermometers were enclosed in packages of clothing, bedding, and rolls of blankets. Complete destruction of the spore-bearing organisms did not follow unless the temperature of 139° C. (282° F.) had been reached. In one large package consisting of nineteen blankets, thoroughly dried and rolled up, the heat did not penetrate to the interior in a sufficiently high degree to destroy the vitality of micrococcus prodigiosus even.

These experiments were still further varied, but the results did not differ materially from those already given. They all showed the great difficulty of penetration of thick packages of fabrics of various kinds by a sufficiently high temperature to produce disinfection.

A large number of fabrics (linen, silk, cotton, wool, feathers, paper, and leather) were exposed for five hours to a temperature of from 150°–160° C. (302°–320° F.) with the result of producing such changes in color and texture of most of them as to render them useless.

In a similar series of experiments, Ransom<sup>1</sup> found that exposure to a temperature of from 240°–250° F. would be borne by clothing materials without injury. Vallin<sup>2</sup> states that cotton and wool fabrics do not change color at a lower temperature than 125° C. (253° F.), which corresponds closely with the observations of Ransom.

Koch and Wolffhügel<sup>3</sup> submit the following conclusions, which seem to the writer to be fully justified by the results of their own and other observations here collected :

1. A temperature of 100° C. (212° F., dry heat), maintained for one hour and a half, will destroy bacteria which do not contain spores.

<sup>1</sup> *Practitioner*, 1878, p. 67.

<sup>2</sup> *Op. cit.*

<sup>3</sup> *Op. cit.*, p. 231.

2. Spores of mould-fungi require for their destruction in hot air a temperature of from  $110^{\circ}$ – $115^{\circ}$  C. ( $230^{\circ}$ – $239^{\circ}$  F.) maintained for one hour and a half.
3. Bacillus spores require for their destruction in hot air a temperature of  $140^{\circ}$  C. ( $284^{\circ}$  F.) maintained for three hours.
4. In dry air the heat penetrates objects so slowly that small packages, such as a pillow or small bundle of clothing, are not disinfected after an exposure of from three to four hours to a temperature of  $140^{\circ}$  C. ( $284^{\circ}$  F.).
5. Exposure to a temperature of  $140^{\circ}$  C. ( $284^{\circ}$  F.) in dry air for a period of three hours injures most objects requiring disinfection (clothing, bedding, etc.) to a greater or less degree.

---

### MOIST HEAT.

BY GEORGE M. STERNBERG.

Whenever infectious material can be consumed by fire, there can be no question as to the efficiency of this mode of disposing of it. But from the experimental data given in the preceding paper, it will be seen that the destruction of desiccated spores by dry heat requires a temperature which injures textile fabrics.

It is quite different with moist heat, and in steam, at a temperature of from  $105^{\circ}$  to  $110^{\circ}$  C. ( $221^{\circ}$  to  $230^{\circ}$  F.), we have an agent which quickly destroys all living organisms, including the most refractory spores.

In the absence of spores, all known micro-organisms are quickly destroyed when immersed in boiling water. Indeed, a temperature much below the boiling-point destroys micrococci and bacilli in active growth. Thus I have fixed the thermal death-point of the micrococcus of septicæmia in the rabbit, and of the micrococcus of pus (from an acute abscess), at  $140^{\circ}$  F. ( $60^{\circ}$  C.), the time of exposure being ten minutes. This temperature is also fatal to the micrococcus of swine plague. The micrococcus of fowl cholera is destroyed by exposure for fifteen minutes to a temperature of  $132^{\circ}$  F. (Salmon). Nine or ten minutes' exposure to a temperature of  $54^{\circ}$  C. ( $129.2^{\circ}$  F.) is sufficient to destroy the vitality of anthrax bacilli in blood (Chauveau). Davaine has shown, that, owing to the low thermal death-point of this bacillus, it may be destroyed in an inoculation wound by application of heated metal to the surface—hammer of Mayor. May it not be that the *rationale* of the effect of poultices applied "as hot as can be borne" to furuncles, acute abscesses, etc., is to be explained in the same way? Or, at least, if a temperature sufficient to destroy the vitality of micrococci which have invaded the tissues cannot be borne, is it not probable that their multiplication may be prevented by the continued application of a bearable temperature?

The resisting power of spores is very much greater, and it is well known that the spores of *B. subtilis* and of other species of the genus *Bacillus* withstand a boiling temperature for a considerable time. My culture-fluids have frequently "broken down," on account of the presence of the spores of *B. subtilis* after two hours' boiling, and to insure sterilization I am in the habit of resorting to a second boiling after an interval

of twelve hours, or of sterilizing in a bath containing some salt, by which a higher temperature than that of boiling water can be secured.

A temperature of five degrees Centigrade ( $9^{\circ}$  F.) above the boiling point quickly destroys the most refractory spores. I have recently made numerous experiments upon the spores of *B. anthracis* and *B. subtilis*, which show that the former has less resisting power than the latter, but that both are destroyed with a temperature of  $105^{\circ}$  C. maintained for ten minutes. The same temperature failed to destroy the developing power of the spores of *B. subtilis* in five minutes, while two minutes' exposure destroyed the vitality of anthrax spores.

These results are in accord with those of Koch, Gaffky, and Loeffler,<sup>1</sup> who found, as the result of numerous experiments, that when a temperature of  $105^{\circ}$  and upward was maintained for ten minutes, all spores were destroyed, as shown by their failure to develop in culture-solutions. Where a temperature of  $110^{\circ}$  C. was reached, the experiment could be stopped, as no spores were capable of germinating after exposure to this temperature. Exposure to a temperature of  $100^{\circ}$  to  $105^{\circ}$  C. for twenty or thirty minutes was fatal to anthrax spores, but those of a certain short and thick bacillus found in garden soil were only killed when the temperature was maintained at  $105^{\circ}$  for twenty minutes.

The question as to the practicability of destroying spores in the interior of packages,—rolls of blankets, etc.,—has received the attention of the experimenters last mentioned, and will doubtless be considered by my colleagues of the Committee on Disinfectants, whose province it is to take account of the various points which may arise relating to the practical use of approved disinfecting agents.

From the experimental evidence presented, it is safe to say that the temperature of boiling water will quickly destroy the vitality of all microorganisms of the class to which known disease germs belong, in the absence of spores.

Steam at a temperature of  $110^{\circ}$  C. ( $230^{\circ}$  F.) maintained for one or two minutes, or of  $105^{\circ}$  C. ( $221^{\circ}$  F.) maintained for ten minutes, will infallibly destroy the spores of bacilli, which constitute the most difficult test of disinfecting power known.

NOTE.—I desire to call attention to the close correspondence between the thermal death-point of micrococci as fixed by my experiments, viz.,  $140^{\circ}$  F. for ten minutes, and the results obtained by the authors quoted by Dr. Rohé in the preceding paper, in the disinfection—*i. e.*, destruction of specific infecting power—of fresh vaccine virus by similar low temperatures. Certainly this correspondence gives some support to the supposition that infective virulence is due to the presence of the micrococcus found in vaccine lymph, although the etiological role of this micrococcus has never been demonstrated by successful inoculations with pure cultures.

<sup>1</sup>“Mitt. a. d. Kaiserlichen Gesundheitsamte,” vol. 1, pp. 322-340.

## ON THE DISINFECTANT PROPERTIES OF PUTREFACTIVE PRODUCTS.

BY CHARLES SMART.

It is well known that when a saccharine liquid undergoing fermentation has attained a certain alcoholic strength, the further growth of the yeast plant is prevented by the action of its alcoholic product. It is, perhaps, equally well known, that an inhibition of the acetous fermentation takes place when the liquid has reached a certain percentage of acetic acidity. But it is not so generally known that the bacteria of putrefaction elaborate, as products of their vital action, organic substances that are destructive to the organisms which determined their formation. The ultimate products in the retrogression of albuminous matters by bacterial or putrefactive agency are ammonia and carbonic acid; but a vast number of complex organic substances, concerning which our knowledge is meagre, constitute intermediate steps in the process. One of these, phenol, or carbolic acid, was at the time of its discovery as a product of putrefaction already well known as an antiseptic and probable disinfectant. Recently E. and H. Salkowski separated from these intermediate products two aromatic acids of the acetic series, hydrocinnamic or phenyl-propionic and phenyl-acetic acid.

Wernich<sup>1</sup> submitted these to experiment, and found that as antiseptics they were superior to carbolic acid, the phenyl-propionic acid being the more active of the two. Klein<sup>2</sup> followed up these researches by an inquiry into their germicidal value. Some of his experiments bear with greater interest on the life history of the organisms subjected to the influence of the acids than on the germicidal value of the latter; but, to complete this series of papers, it has been deemed advisable to submit a summary of his results.

This able experimenter recognized the difference between antiseptics and disinfection that has been insisted upon in the reports of this committee. He exposed the organisms that were the subject of the experiment to the action of the acids, and then introduced them into a suitable culture-medium; or, if they were of a pathogenic nature, inoculated animals with them,—a failure to cultivate, or a failure to reproduce the disease being respectively in each case the test of a germicidal or truly disinfectant action.

The non-specific organisms subjected to experiment were a small micrococcus derived from the blood of rabbits, a large micrococcus of similar derivation, bacterium termo and *Bacillus subtilis*. An exposure of twenty or twenty-five minutes in a solution of either acid of the strength 1 : 200, failed to destroy the vitality of any of these specimens; the last mentioned, indeed, was not destroyed by an exposure of twenty-four hours.

The pathogenic matters treated were the spores and bacilli of anthrax, the virus of swine-plague, and that of tuberculosis.

<sup>1</sup>"Virchow's Archiv," vol. 78, p. 51.

<sup>2</sup>"Supplement to Thirteenth Annual Report of Local Government Board," London, 1884, p. 111.



Anthrax spores, exposed for two or more days in either acid of the strength 1 : 400, were found to have retained their virulence when subsequently injected into guinea-pigs, and to be susceptible of cultivation in culture-liquids, with the retention of virulence in their progeny. But, although the spores withstood the influence of the acids, the bacilli of anthrax were killed immediately, or as soon as they were thoroughly mixed with this strength of either of the acids. The phenyl-propionic acid, however, was manifestly more efficient, for a dilution of 1 : 800 destroyed the bacilli in ten minutes, while the phenyl-acetic acid under similar conditions failed to accomplish disinfection. Greater dilutions required a longer period to effect the destruction of the bacilli, and in all instances the phenyl-propionic acid showed the greater potency. Thus, while this acid, in the strength 1 : 3,200, required from twenty-five to thirty-five minutes to be effective, the phenyl-acetic acid of the same strength required fully thirty-five minutes.

Several other points of interest were developed. It was noted that in greater dilutions than 1 : 400 of either acid, a stronger solution or a longer exposure was required to kill bacilli grown from a previous culture containing spores than those from a culture started from blood bacilli. It was observed further that bacilli cultivated from bacilli of the blood have a greater resistance than the latter, so far as these acids are concerned, for the first week or ten days of the cultivation, but that after this their power of resistance decreases, so that ultimately it becomes even less than that of the original blood bacillus. The fact was also shown that bacilli in the blood of a guinea-pig dead from inoculation with spores have a greater resistance to the influence of the acid than those from an animal dead from inoculation with bacilli.

The virulence of swine-plague, taken directly from an animal dead of the disease, and also that of the artificially cultivated microbe, were destroyed by an exposure of twenty or twenty-five minutes to a phenyl-propionic solution of the strength 1 : 800; weaker solutions were not efficient, and the disinfectant action of the phenyl-acetic acid of this strength was not certain.

The tubercular virus, like the spores of anthrax, resisted the influence of these acids. An exposure of ninety-six hours to a strength 1 : 200 did not prevent the caseous matter of pulmonary tuberculosis from producing its characteristic effects when injected into a guinea-pig. But considerably stronger solutions showed the exercise of an inhibitory power. Bovine virus manifested a greater resistance against the influence of the acids than the tuberculous virus of man.

---

#### PRACTICAL EXPERIMENTS ON THE STERILIZATION OF FECES.

BY GEORGE M. STERNBERG.

In the experimental researches heretofore recorded in this series of papers, the germicidal value of various chemical reagents has been estab-

lished by biological tests made with pure cultures of various micro-organisms, or with "broken-down" beef tea. The latter test I consider the most difficult, as the putrid beef tea, after having been exposed in the laboratory for several days, contains a variety of micro-organisms, including several species of bacilli, especially *B. subtilis*, the spores of which have an extreme resistance. The results obtained in these experiments may therefore be safely used as a basis for determining the quantity of the chemical agents tested which will be necessary to sterilize fluids containing micro-organisms, when these fluids can be fairly compared with the putrid beef solution used in our experiments—due allowance being made on the side of safety when practical recommendations are to be made. The liquid discharges from the bowels of patients with cholera, typhoid fever, advanced tuberculosis, septic diarrhœa, etc., may be fairly compared with our broken-down beef tea, as regards physical and biological characters; and I should say, in general, that it would be within the limits of safety to prescribe twice the quantity of a given agent, for the disinfection of such material, that has been found necessary to sterilize the same amount of putrid beef stock.

But when we have to deal with formed or semi-solid fecal matter, the conditions are very different, and the data obtained in our experiments upon fluid material cannot be applied without making proper allowance for the larger amount of organic material associated with the germs which are to be destroyed, and for the fact that germs enclosed in masses of albuminous material may be protected from the action of the disinfecting agent. Especial care will be required in the practical use of the oxidizing disinfectants, such as potassium permanganate and the hypochlorites of lime and of soda. These agents owe their power to the fact that they are promptly decomposed by contact with organic matter, but this decomposition is entirely a chemical reaction, and only a given amount of organic material can be oxidized by a given quantity of the oxidizing agent; on the other hand, the disinfecting power of such agents is neutralized by a given quantity of organic material, whether this is in the form of living micro-organisms, or of dead animal or vegetable matter. If, then, the organic material is in excess, germs embedded in it will escape destruction, and the only safe rule in the practical use of oxidizing disinfectants is to *use such a quantity of the disinfecting agent that it shall be in excess after the reaction has taken place.*

The following experiments have been made for the purpose of determining within the limits necessary for practical purposes the quantity of the disinfecting solutions heretofore recommended by the Committee on Disinfectants required to sterilize a given quantity of feces (normal).

*Standard Solution of Chloride of Lime.*<sup>1</sup>

*August 25.*—Four ounces of semi-solid feces added to *one pint* of this solution, available chlorine 0.65 per cent. At the end of twenty-four hours no chlorine remained in the mixture, and two culture-flasks inoculated with the material broke down—failure to sterilize.

<sup>1</sup> Containing four ounces of chloride of lime in one gallon of water.

August 28—Four ounces of semi-solid feces added to *one quart* of the standard solution containing 0.85 per cent. of available chlorine. At the end of twenty-four hours a trace of chlorine (0.01 per cent.) remained; there was no appearance or odor of feces in the mixture—no cultures were made in this experiment.

August 31.—Seven ounces of semi-solid feces added to *two quarts* of the standard solution, available chlorine 0.83 per cent. At the end of one hour there was a trace of chlorine in the mixture. Two culture-flasks inoculated remained sterile.

September 5.—Two and one half ounces of semi-solid feces added to *one quart* of the standard solution, available chlorine 0.9 per cent. At the end of one hour the mixture was found to contain 0.1 per cent. of available chlorine. Two culture-flasks were inoculated at the end of one hour; both broke down after remaining twenty-four hours in the oven. As both flasks contained a pure culture of *B. subtilis*, it was evident that this was the most resistant organism present in the material, and that all other organisms were destroyed.

September 7.—Six and one half ounces of semi-solid feces added to *two quarts* of the standard solution containing 0.9 per cent. of available chlorine. At the end of three hours the available chlorine present in the mixture was found to be 0.11 per cent., and at the end of twenty-four hours 0.1 per cent. Two tubes inoculated at the end of three hours remained sterile.

I conclude from these experiments that in practice it will be safe to use one quart of this standard solution for every two ounces of feces to be sterilized. Vallin estimates a complete (daily) evacuation of the bowels at from 150 to 200 grammes—say six to eight ounces. Let us keep on the safe side and allow one gallon of this solution, containing four ounces of chloride of lime of the best quality, for the sterilization of a normal alvine evacuation. The daily cost *per capita* for sterilizing feces would then be less than one cent, for chloride of lime can be bought by the quantity for three and a half cents per pound.

#### *Solution of Mercuric Chloride and Potassium Permanganate.*<sup>1</sup>

August 30.—Two and one half ounces of semi-solid feces added to *one pint* of this solution. The material was very completely deodorized by the potassium permanganate in the solution. A thorough admixture and breaking up of the fecal matter was effected in this and in the following experiments by stirring with a glass rod. Two culture-flasks were inoculated at the end of two hours; both remained sterile.

September 6.—Seven and one half ounces of semi-solid feces added to *one quart* of this solution. There was a decided fecal odor at the end of twenty-four hours. Two culture-flasks inoculated at the end of twenty-four hours broke down with *B. termo*

September 8.—Seven ounces of semi-solid feces added to *two quarts* of this solution. Only a slight fecal odor at the end of twenty-four hours.

<sup>1</sup> Containing two drachms of each salt in a gallon of water.

A copper wire dipped into the mixture showed the presence of a salt of mercury in solution—deposit of metallic mercury on wire. Two culture-tubes inoculated in twenty-four hours remained sterile.

Making a liberal allowance on the side of safety, we may say that one gallon of this solution, containing two drachms each of mercuric chloride and potassium permanganate, may be relied upon for sterilization and deodorization of a normal alvine evacuation. The cost would be about two cents, if the materials were purchased by the quantity, and the solution made (without expense for transportation) as required.

The following experiments have been made with a solution containing four ounces of mercuric chloride and one pound of cupric sulphate to the gallon of water (concentrated solution). For use, this solution is diluted by adding eight fluid-ounces to the gallon of water.

*August 29.*—Eight ounces of semi-solid feces added to *one quart* of above solution. Fecal odor not destroyed as well as by the solution containing potassium permanganate. Two culture-flasks inoculated at the end of twenty-four hours remained sterile.

*September 2.*—Three ounces of formed feces added to one quart of the above mentioned solution. Two culture-flasks inoculated at the end of twenty-four hours remained sterile.

The following experiment has been made with solution of carbolic acid:

*2d.*—One and one half ounces of formed feces added to *one quart* of a 5 per cent. solution of carbolic acid. Two culture-flasks inoculated at the end of twenty-four hours broke down with *B. subtilis*, a *pure culture*, showing that the spores of this bacillus had not been killed, but that the material had been sterilized so far as *B. termo*, and other putrefactive organisms present, were concerned.

## REPORT OF THE COMMITTEE ON DISINFECTANTS FOR 1886.

It will be remembered that in the report for 1885 the Committee on Disinfectants recommended as the most efficient non-destructive disinfectants the following :

Steam under pressure at 110° C. (230° F.) for ten minutes.

Dry heat at 110° C. (230° F.) for two hours (in the absence of spores<sup>1</sup>).

Boiling in water for one half to one hour.

These conclusions as then announced, which were largely based upon the committee's experimental work, have been generally accepted by sanitarians. The experimental researches of others, published since those of this committee, have corroborated the latter in all essential particulars.<sup>2</sup>

Apparatus for disinfection by heat may be divided into three classes :

1. Those in which dry hot air is employed ;
2. Those in which moist hot air is used ; and,
3. Those in which steam is the disinfecting agent.

As stated in the committee's report for last year,<sup>3</sup> dry hot air cannot be relied upon for disinfection when great penetrating power is required, as in disinfecting mattresses, feather beds, and thick bundles of clothing, or of cotton and woollen goods. Besides, dry hot air, of a sufficiently high temperature to act as an efficient disinfectant, often permanently injures textile fabrics and other objects requiring disinfection. The very recent investigations of Dr. Parsons and Prof. Max. Wolff fully attest the conclusions of the committee upon this point. Notwithstanding these objections, dry hot air may probably often be used as a disinfectant with good results if the above mentioned limitations be borne in mind. In no event, however, can dry heat be expected to prove an efficient disinfectant unless a temperature above 110° C. (230° F.) has been maintained for upward of two hours.

Dr. Parsons<sup>4</sup> formulates clearly the requisites of a good disinfection apparatus. They are as follows :

- "1. A uniform distribution of heat in all parts of the chamber ;
- "2. The maintenance of the heat with constancy at any required degree ;
- "3. A trustworthy index to the actual temperature of the interior at the time being ;

<sup>1</sup>Vide Report of the Committee on Disinfectants for 1885, p. 123.

<sup>2</sup>See Parsons : Supplement to the 14th Report of the Local Gov't Board. Max. Wolff : Virchow's Archiv. Bd., 102, p. 81 *et seq.* Grancher : Revue d'Hygiène, 1886.

<sup>3</sup>Page 110.

<sup>4</sup>L. c., p. 244.

“4. Rapidity of action, both in the first getting up of heat and in effecting disinfection; and,

“5. Economy of first cost and of working.”

In none of the various apparatus designed for disinfection with dry hot air has a uniform distribution of the heat in the chamber been attained. In order to obviate this difficulty, some inventors and experimenters have rendered the hot air humid either by evaporating water in the disinfecting chamber, or by injecting steam into the same. By this means the distribution of heat is rendered more even, and its penetrating power is said to be increased.

In using hot-air apparatus, the fuel employed is of some importance. By the use of gas the heat can be maintained more equably than when coal, coke, or wood is used. The feeding of the furnace, when the latter forms of fuel are employed, allows a certain amount of cooling off, and hence a corresponding loss of heating time. When the heat is furnished by a current of steam circulating through a steam pipe properly disposed in the disinfecting chamber, the greatest degree of uniformity in the temperature can be maintained.

Apparatuses for disinfection by steam are of two sorts,—those in which the steam passes through the disinfecting chamber without compression, and those in which it is confined by pressure. In the former, the vapor is sometimes superheated by a secondary heating apparatus, and thus is probably equally efficient as the steam under pressure.

The committee desires to express its conviction, based upon the practical experience of some of its members, that the use of steam, and especially when superheated or under pressure, is the most efficient agent for the destruction of all sorts of infectious material.

The experiments of Prof. M. Wolff<sup>1</sup> show that with an apparatus of the former sort, an exposure of at least one hour was requisite for thorough disinfection.

The committee regrets that on account of want of means no practical study of the various apparatuses for heat disinfection could be undertaken during the past year. A trustworthy judgment upon the comparative merits of the different machines cannot therefore be expected or given. It is hoped, however, that the full collection of disinfecting machines illustrated in the appendices to this report will enable health officers and others interested to decide upon those most suitable for their use.

GEORGE M. STERNBERG,  
*Chairman.*

J. H. RAYMOND.

V. C. VAUGHAN.

CHARLES SMART.

S. H. DURGIN.

JOS. HOLT.

GEORGE H. ROHÉ.

<sup>1</sup> Virchow's Archiv. Bd., 102.

## APPENDIX "A."

## APPARATUS FOR THE APPLICATION OF DRY AND MOIST HEAT IN DISINFECTION.

BY GEORGE H. ROHÉ, M. D., PROFESSOR OF HYGIENE IN THE COLLEGE OF PHYSICIANS AND SURGEONS, BALTIMORE; SECRETARY OF THE COMMITTEE.

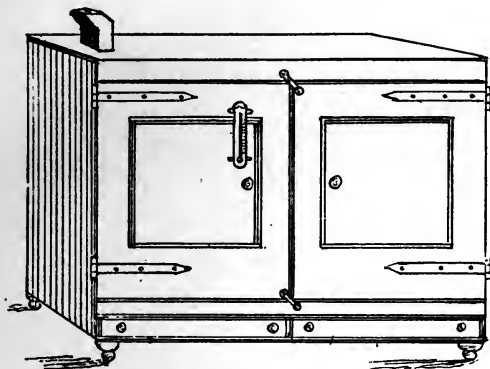

Fig. 1.—Large size.

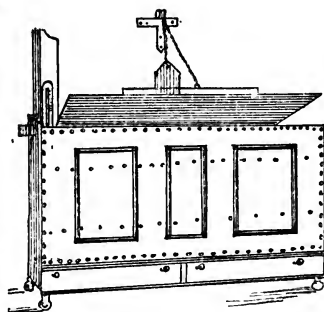

Fig. 2.—Small size.

## I. NELSON'S PATENT DISINFECTING APPARATUS.

[From Dr. Parsons's report on Disinfection by Heat, Fourteenth Annual Report of the Local Government Board, p. 253.]

This apparatus consists of a rectangular iron chest with double side walls. The smaller sizes have a hinged and counterpoised lid; the larger ones, two doors opening in front. Underneath the bottom, which is of a single plate, is a series of luminous gas jets; the heated air from these plays upon the bottom, and, passing up between the outer and inner walls, is carried off by a flue without entering the interior of the chamber. The chamber is furnished with two openings for ventilation, an inlet at the bottom and an outlet at the top at the opposite end, communicating with the flue. These openings are furnished with slides by which they can be closed or opened. A thermometer is fixed near the outlet flue with the bulb in the space between the walls. This furnishes a guide to the temperature within the chamber. The manufacturers state that a temperature of  $60^{\circ}$  C. ( $140^{\circ}$  F.), as shown by the thermometer, corresponds to one of  $93.5^{\circ}$  C. ( $200^{\circ}$  F.) within the chamber. The external thermometer should never be allowed to exceed  $82.5^{\circ}$  C. ( $180^{\circ}$  F.). The apparatus was heated to a temperature sufficient for disinfection in ten minutes.

## 2. FRASER'S PATENT DISINFECTING APPARATUS.

[Dr. Parsons's Report, p. 255.]

This is made in two forms, stationary and portable. The first consists of a brick oven, the heat being supplied by coke. In the largest apparatus there are doors at either end, the bottom of the oven being level with the ground. The clothing to be disinfected is placed in latticed trays upon an iron truck, which is wheeled into the oven at one end. After exposure for a sufficient length of time to a proper temperature, the truck is withdrawn through the doors at the other end of the oven. (See accompanying plans.)

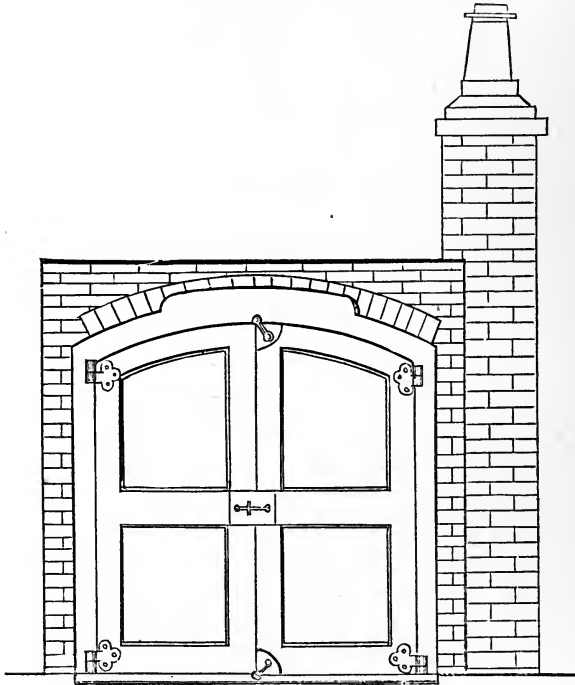

FRONT ELEVATION

Fig. 3.

In a smaller form of apparatus, suitable for hospitals, etc., there are doors at one end only, and the articles to be disinfected are placed on wooden trays in the chamber. Above the furnace is the door of a small fire-place, in which sulphur can be burnt to aid in the disinfection. The fumes enter the chamber through the iron grating which forms its floor. [This would seem to be unnecessary. If the temperature is sufficiently high, the sulphur dioxide is needless: if the heat is not high enough to disinfect the articles, the apparatus should be rejected. Dr. Parsons's experiments with the apparatus were not very satisfactory. It is, however



used by many public sanitary authorities in England.] In the roof of the oven is an opening by which, when the damper is pulled out, a communication is established with the ash-pit of the furnace. This forms an outlet for ventilation, the sulphur stove acting as an inlet. The fumes given off from the materials subjected to disinfection are thus made to pass through the fire.

The portable apparatus is in the form of a van, being placed on four iron wheels. The chamber is seven feet long, four feet and six inches

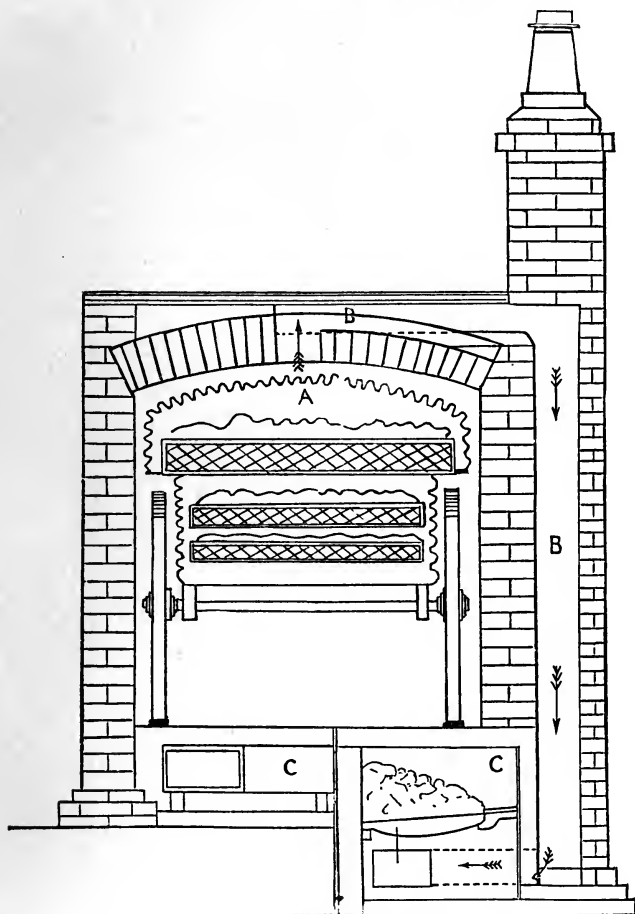

Fig. 4. Transverse section.

- A.*—Carriage in which infected articles are conveyed.  
*B.*—Flue to draw vapors from inside of chamber through the fire.  
*C.*—Furnace and smoke flues.

wide, and three feet high, internally. It is made of iron covered with felt, and cased externally with wood. Shafts can be attached, and the machine moved from place to place as required. The apparatus weighs about four tons.

In the larger apparatus coke is used as fuel, and the time required to raise the temperature to the proper height varies from an hour and a half to five hours and a half. In the portable machine the fuel used is coal.

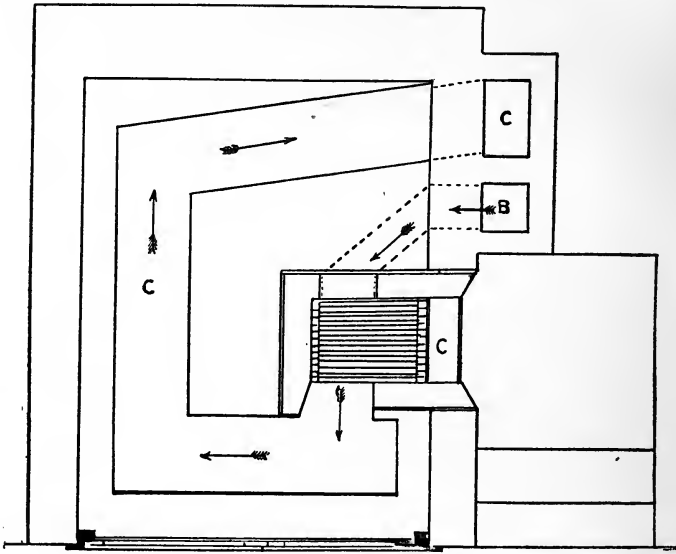

Fig. 5.

*B.*—Flue to draw vapor from inside of chamber through the fire.  
*C.*—Furnace and smoke-flues.

In an experiment lasting an hour and a half, and with the expenditure of twenty-four pounds of coal, the temperature was raised to  $149^{\circ}$  C. ( $300^{\circ}$  F.). In six hours fifty-six pounds of coal were consumed.

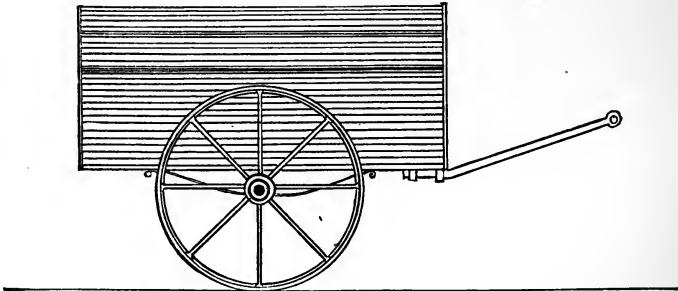

Fig. 6.

Carriage in which infected articles are conveyed.

## BRADFORD'S PATENT "SAFETY" DISINFECTING APPARATUS.

[Dr. Parsons's report, p. 269.]

This consists of two parts, the base and the container. (See Fig. 7.

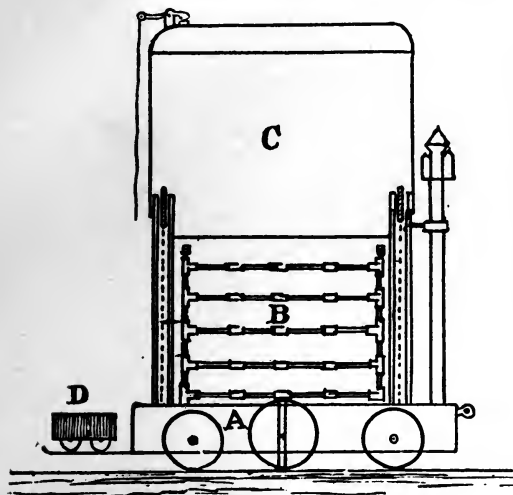

Fig. 7.

- A.—Base.  
 B.—Rack on which infected articles are placed.  
 C.—Container.  
 D.—Movable fire-basket.

for the purpose of affording a large heating surface. The remainder of the base is covered with a layer of sand upon which the container rests. The container is a large rectangular iron box, covered with non-conducting composition, open below, and suspended by chains and counterpoises from pillars at each corner of the base, after the manner of a gas-holder. There is a valve in the roof for ventilation.

The articles to be disinfected are placed on a galvanized iron rack which stands on the base over the fire-chamber, and when in position the container is let down over them and rests on the base, forming with the sand a sufficiently close joint. The base is made to run on wheels, so that the apparatus may be moved from place to place.

The rack is made of tubes to serve for the admission of steam into the container, and evaporating dishes containing water are placed at the bottom over the fire chamber. A fixed form of the apparatus on a large scale is shown in the accompanying plans, (Figs. 8-12).

The base is divided longitudinally into three compartments, of which the central one is the heating chamber, and the side ones are for ventilation, communicating with the fire-chamber by slide-valves. The fire-chamber has a door at one end and a flue at the other. The fire is contained in a wagon running on wheels, which can be drawn out for convenience of stoking. Peat, coal, coke, or charcoal may be used as fuel. The roof of the fire-chamber is formed of hollow iron bars, triangular in section, and open at the ends,

## BRADFORD'S "SAFETY" DISINFECTING APPARATUS.

ANOTHER FORM OF THIS APPARATUS.

[Parsons, p. 272.]

In this form the base is fixed. The furnace is of brick, with a fire-brick bridge, and occupies the greater part of the base, the cellular bars projecting beyond it so as to cover nearly the whole area. Above these

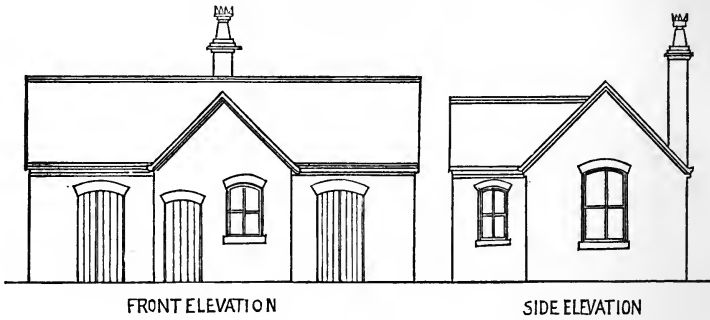

Fig. 8.

are two large, flat, iron evaporating vessels, with inflexed edges to prevent boiling over. The water in these is maintained at a constant level by a pipe communicating with a feeding cistern outside. Above the evaporating dishes is an iron plate covered with asbestos to cut off direct radiation from the heated base.

The container, which measures 8 ft. long, 8 ft. wide, and 4 ft. 6 in. high, is raised by a crab with worm-wheel instead of being counterpoised.

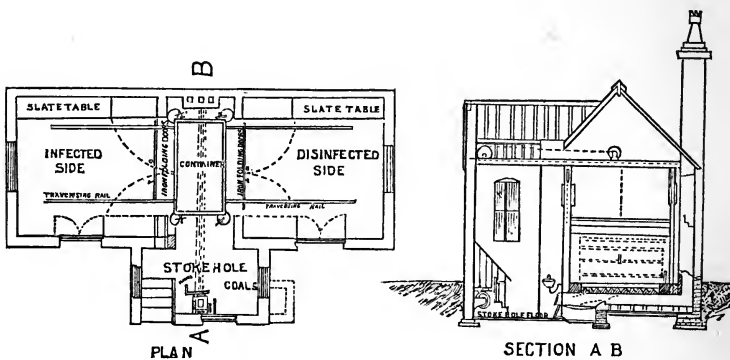

Fig. 9.

Fig. 10.

It fits, as in the other, on a sand-joint. The iron horse, on which clothes, etc., are placed, slides out at the side on wheels running in iron grooves.

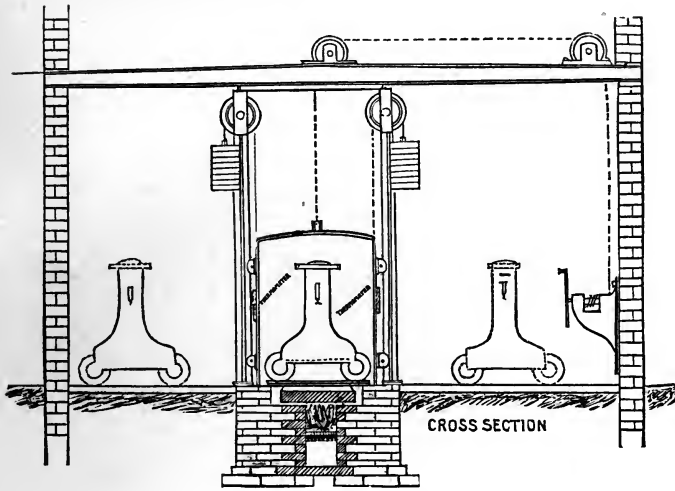

Fig. 11.

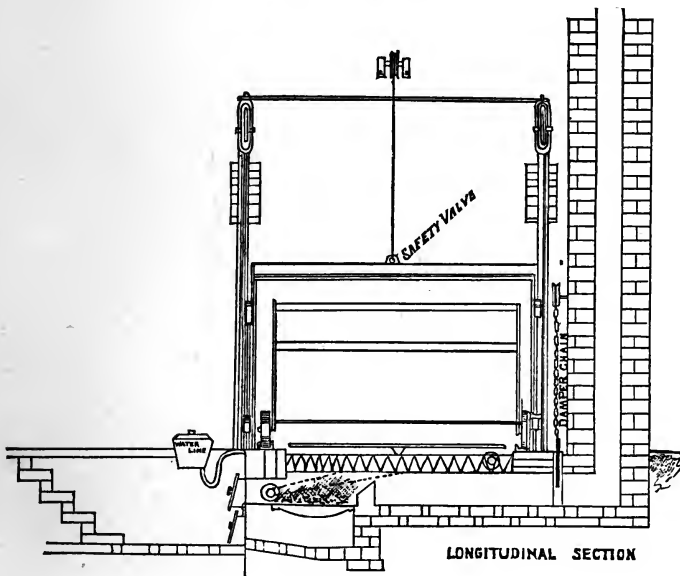

Fig. 12.

MERKE'S DISINFECTING APPARATUS.

This apparatus was first constructed in 1873 for the use of the Municipal hospital at Moabit in the suburbs of Berlin. The first form of the machine was defective in some of the technical details; and in 1879 a new apparatus was constructed according to the plans of the superintendent of the hospital, Mr. H. Merke. The following description is given by the inventor: <sup>1</sup>

<sup>1</sup> Virchow's Archiv. Bd., '77, 4tes Heft., Sept., 1879.

The apparatus consists of an outer wall of 5 inches thick, an inner wall of 10 inches, and a space of  $2\frac{3}{4}$  inches between the two. This space is filled with sawdust, and is intended to prevent the rapid conduction of heat from the interior of the chamber. The floor is of cement, and is likewise isolated by a layer of sawdust from the masonry base. In one of the walls is an iron door 5 feet high and 26 inches wide, which can be tightly closed against a felt rim by means of a screw. In the inner wall is an iron sliding door. In the slightly arched roof is an opening 8 inches square leading into the chimney, which extends 8 feet above the roof of the chamber. Two feet above the roof the chimney is furnished with an iron damper, which can be raised by means of a chain working over a pulley. The isolating layer

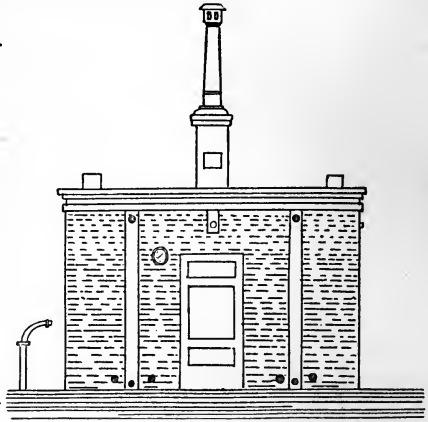

Fig. 13.—Front elevation.

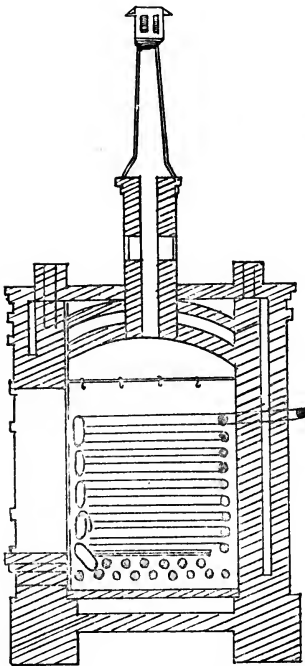

Fig. 14.—Longitudinal section.

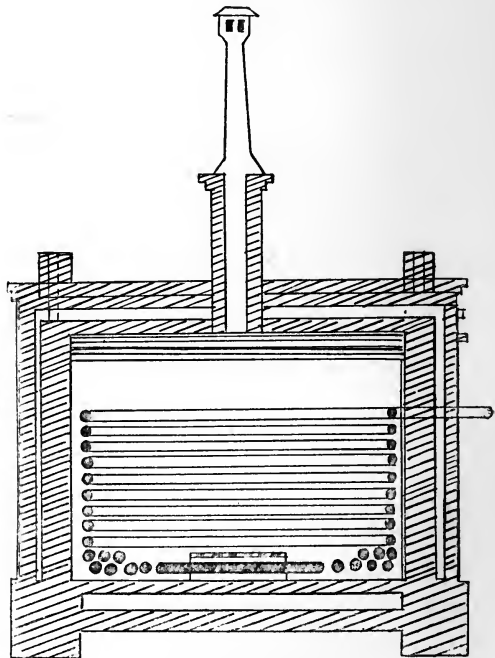

Fig. 15.—Transverse section.

of sawdust is ventilated by ventilators extending above the roof. The interior of the chamber is 7 feet 4 inches high, 9 feet 10 inches long, and

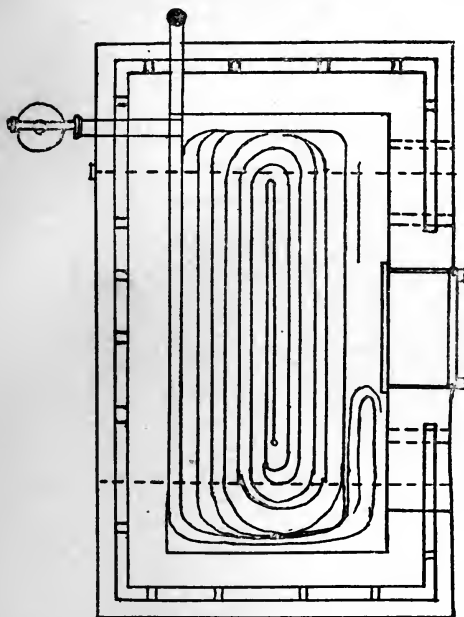

Fig. 16.—Plan showing arrangement of heating pipes.

5 feet wide. At an elevation of 5 feet 8 inches above the floor a strong copper steam pipe, 3 inches in diameter, enters the chamber, and is continued in spirals around the interior of the inner wall, and in a double layer upon the floor. The pipe terminates externally in a condenser. Two tubes,  $2\frac{1}{2}$  inches in diameter, admit air into the chamber about 2 inches above the floor. Near the upper right-hand corner is a pyrometer, which indicates the temperature in the interior.

In order to use the apparatus, the articles to be disinfected are hung up on hooks in the chamber. The doors are closed, and the steam turned into

the copper steam pipe. The damper in the chimney and the valves of the air tubes are opened for half an hour to allow all moisture to be driven off. They are then closed. The steam is passed through the pipe until the temperature of the chamber, as indicated by the pyrometer, is raised to  $125^{\circ}$  C. ( $257^{\circ}$  F.). This is usually reached in half an hour, and is then maintained about an hour longer. During the last half hour the air tubes and chimney damper are again opened to permit ventilation. In fifteen minutes after opening the doors the temperature has fallen to  $35^{\circ}$ – $40^{\circ}$  C. ( $95^{\circ}$ – $104^{\circ}$  F.), allowing the removal of the disinfected articles.

The entire cost of erection of this apparatus was 2,035 marks (about \$500). This does not include the steam boiler.

The distribution of heat in the interior is fairly equable. The experiments of Wolffhügel<sup>1</sup> showed a difference of  $11.8^{\circ}$  C. ( $21^{\circ}$  F.).

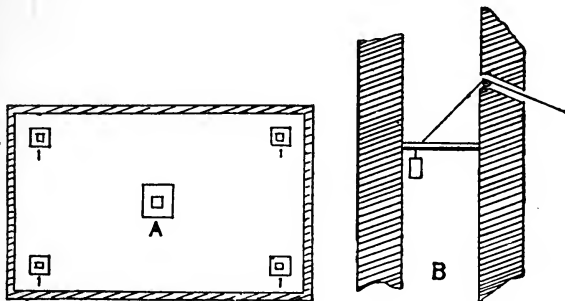

Fig. 17.

A.—Plan of roof of chamber. *IIII*.—Ventilators of isolating spaces. B.—Section of chimney showing damper.

<sup>1</sup> Mittheilungen a. d. Kais. Gesdhtsamte, Bd. I.

## DR. HERON ROGERS'S PORTABLE DISINFECTING CHEST.

[Dr. Parsons's report, p. 264.]

This is a rectangular chest [Fig. 18] 3 ft. 6 in. long, 2 ft. 6 in. wide, and 2 ft. 9 in. high, mounted on four iron wheels, and with a handle at one end. The sides, ends, and bottom are double; and in the bottom there is at one end an opening in the outer casing, under which a fire-box is slid. The products of combustion ascend in the interspace between the casings, and find an exit by a flue at the end opposite the fire-box. The lid is a sliding plate of iron. A box (*a*) with a sliding lid is provided for the conveyance of infected articles. This box is intended to be inverted over the mouth of the chest, when, the lid being withdrawn, the articles within are allowed to fall upon brackets in the interior of the chest. In the top of the chest, at the end above the fire-box, a thermometer is fixed, the bulb encased in an iron tube extending downward six inches into the interior of the chest. The thermometer does not indicate accurately the temperature in the chamber. Coal is used as fuel. It takes about an hour after the fire is lighted to reach the temperature required.

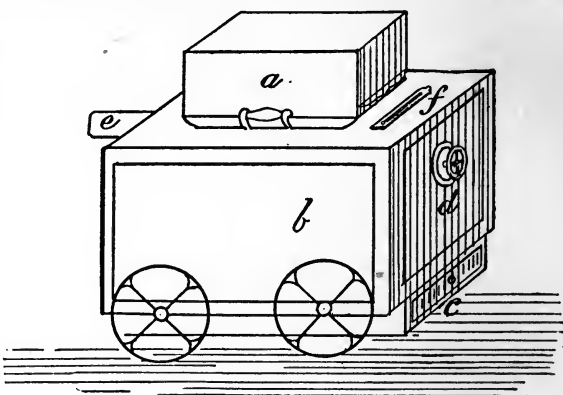

Fig. 18.

- A.*—A loose wooden box, by which clothing, &c., is brought from the sick-room without danger of infection.  
*B.*—Hot-air disinfecting chest.  
*C.*—Fire or other heating agent.  
*D.*—Fresh-air valve, by which noxious vapors, &c., are forced into chimney, *E*, which is connected with an ordinary flue or pipe.  
*E.*—Thermometer.

## DR. RANSOM'S SELF-REGULATING DISINFECTING APPARATUS.

[Dr. Parsons's report, p. 277.]

This consists of a cubical iron chamber, cased in wood, with an intervening layer of felt, access to the interior being obtained by double doors. As manufactured for municipal disinfecting stations, the chamber has doors on opposite sides, and is placed in the partition wall which divides the establishment into two sides,—an “infected” and a “clean” side,—infected articles being carried into the apparatus on one side, and removed, when disinfected, on the other.

The furnace is placed at the side of the chamber, and at a lower level. It consists of a ring of atmospheric gas-burners enclosed in an iron tube.



The heated air containing the products of combustion passes along a horizontal flue, and enters the chamber at the bottom, which is perforated by a number of holes for its equable distribution. In the horizontal flue are fixed the bulbs of a thermometer (*H*, Fig. 19) and of a self-acting mercurial regulator. Through the latter the gas-supply to the burners can be made to pass; and it is so constructed that as the temperature of the apparatus rises, the mercury expanding encroaches upon a slit (*A*, Fig. 19), through which the gas passes, and thus gradually cuts off the supply.

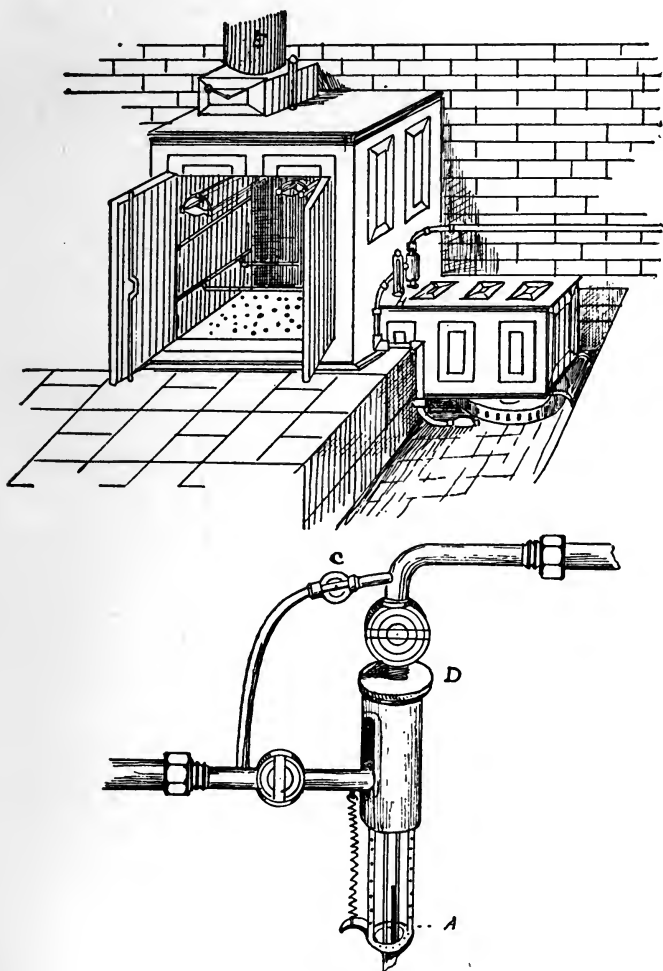

Fig. 19.

At the top of the chamber there is an outlet flue controlled by a valve, and furnished with a thermometer (*E*, Fig. 19). In connection with the outlet is an arrangement designed for the extinction of fire. When the temperature at the outlet exceeds  $149^{\circ}$  C. ( $300^{\circ}$  F.), a link of fusible

metal melts, closing a damper, and shutting off the supply of gas. The chamber is fitted with bars and hooks for suspending clothing and other articles to be disinfected.

When the stove is first lighted, the gas is admitted to the burners direct through a short circuit pipe (*C*, Fig. 19) without passing through the regulator; but when the mercury in the latter has risen high enough to reach the slit, this pipe is closed by a tap so as to compel the gas to pass through the regulator. The regulator is furnished with an adjusting screw (*D*, Fig. 19), so that it can be set to work at a higher or lower temperature as required. It takes from three to four hours to raise the temperature to 121° C. (250° F.).

The great merits of this apparatus are the even distribution of heat and the accuracy with which the temperature can be adjusted and kept constant without supervision. Hence it may be used for the disinfection of such articles as will bear a temperature of 121° C. (250° F.) with little risk of injury. The chief drawback to its use appears to be the long time which it takes, first, to raise the chamber to the required temperature, and, second, to accomplish the penetration of heat into bulky non-conducting articles (pillows, mattresses, etc.). Another inconvenience is that the gas flame is liable to "catch back," especially if the doors to the chamber be suddenly opened or shut,—*i. e.*, the gas burns before instead of after its admixture with air, with the result that little heat enters the chamber, but that the gas pipes get strongly heated. The occurrence of this accident is indicated by a slight explosion; and if it be found to have taken place, the gas must be extinguished and relighted.

## LEONI'S PATENT DISINFECTOR.

[Dr. Parsons's report, p. 280.]

This apparatus consists of a cylinder built of tiles set in an iron frame, and in shape and size somewhat resembling a diving-bell. The internal

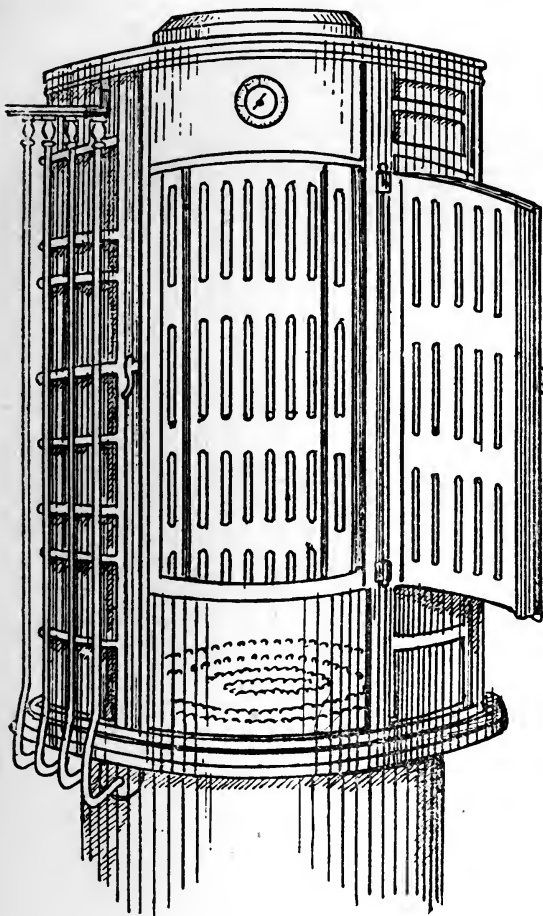

Fig. 20.

diameter is 4 ft. 8 in., and the height 9 ft., of which about 6 ft. are above the level of the floor. In front there is a door by which access to the interior is obtained. The door is not of the full height of the chamber. Three feet below the floor level are rings of atmospheric gas-burners, so arranged that one or more rings can be used at a time. At the floor level is a grating upon which articles to be disinfected can be placed; and in the walls and roof of the chamber are arrangements of bars and hooks upon which other articles can be suspended. The articles to be disinfected are thus 3 feet above the gas flames. In the centre of the roof is an outlet, which can be closed by a sliding valve. To prevent loss by radiation, the disin-

fectors are encased in brickwork except in front. The disinfected articles have to be taken out by the same way that infected articles are put in, thus apparently involving some risk of their being reinfected. The consumption of 70 cubic feet of gas and half an hour of time suffices to raise the temperature in the chamber to 149° C. (300° F.).

## SCOTT'S PATENT DISINFECTING APPARATUS.

[Dr. Parsons's report, p. 282.]

Two forms of this apparatus are made: in one the heat is furnished by gas, and in the other by coal. The former is the more desirable. The apparatus consists of a brick or iron oven enclosed in a brick building. A partition wall, level with one end of the oven, divides this building into two distinct compartments, the larger for infected and the smaller

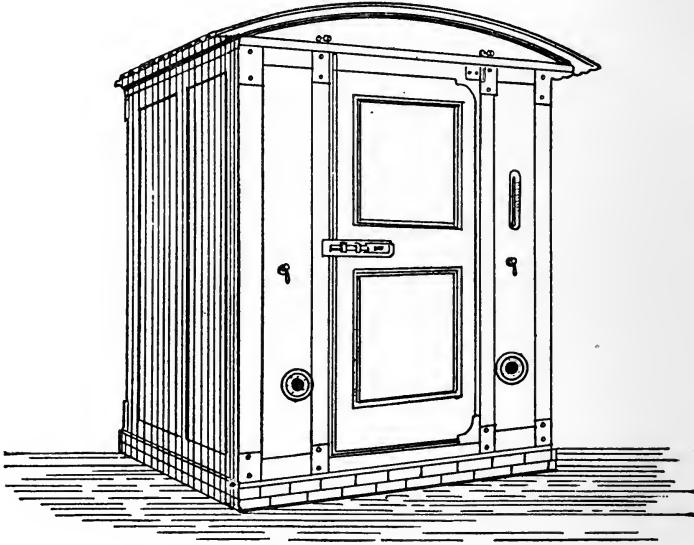

Fig. 21.

for disinfected articles. The supply of gas can be governed by an automatic gas regulator. The gas is burned by means of a double crown of burners covered by a plate of sheet iron, upon which a vessel of water may be placed to supply moisture to the air by evaporation. In a test the temperature was raised to above  $150^{\circ}$  C. ( $305^{\circ}$  F.) in an hour, with the consumption of 200 cubic feet of gas.

## JENNINGS'S DISINFECTING APPARATUS.

[Dr. Parsons's report, p. 287.]

This is a doubled-walled iron chamber, with a heavy iron lid. The iron plate of which the apparatus is made is  $\frac{1}{8}$ " thick. The space between the plates forming the walls is 3 inches at the bottom, diminishing to  $\frac{3}{8}$ " at the top. The bottom of the chamber is formed of a single iron plate. The sides and lid are coated externally with asbestos composition, with a view of economizing heat. Beneath the bottom, and at a distance of

$1\frac{1}{2}$ " from it, is a series of atmospheric gas-burners containing 500 jets. The space between the inner and outer shells is open at the bottom, and

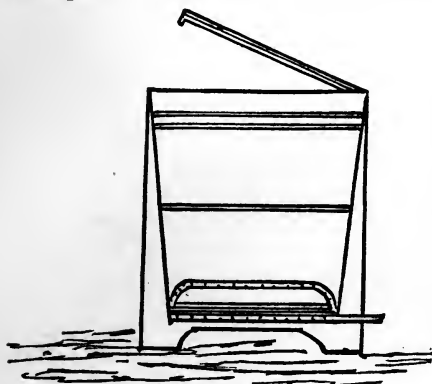

Fig. 22.

communicates above with the interior of the chamber by a double row of holes around the four sides. The interior of the chamber is connected by a flue at the side by an aperture opening in the centre of the bottom, and capable of being opened and shut from the outside by a sliding valve.

The heated air ascending from the burners impinges upon the bottom of the chamber, and ascending in the space between the two cells, enters the interior

through the holes, and is drawn off by the flue.

Eighty cubic feet of gas raised the temperature to a sufficient height in half an hour.

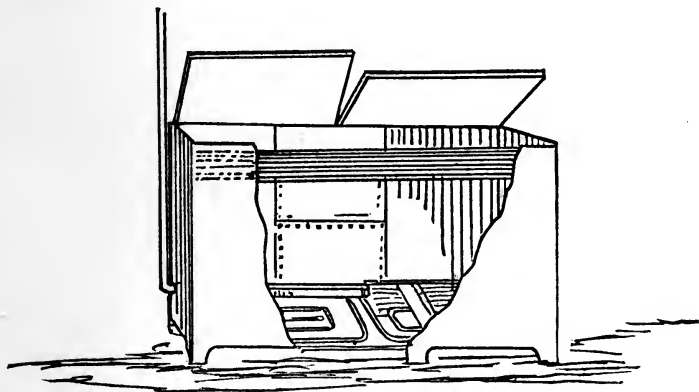

Fig. 23.

### TAYLOR'S DISINFECTING CLOSET.

[Dr. Parsons's report, p. 274.]

This is built of brick, its dimensions being  $7 \times 7 \times 7$  feet. The cut (Fig. 24) shows the external appearance without further description. The interior is divided into two compartments by a perforated brick wall, which does not, however, reach to the roof or to the back wall. In the right compartment is the body of the furnace, which is horizontal, and made of corrugated cast iron, with a chimney at the far end. There is a sliding door at the side of the chamber, through which, if desired, sulphur can be placed on the roof of the furnace. The left compartment contains two iron horses, which slide in and out on rails in the

floor. At the back of the chamber is a pipe communicating with a boiler. Through this pipe steam can be blown into the chamber. The

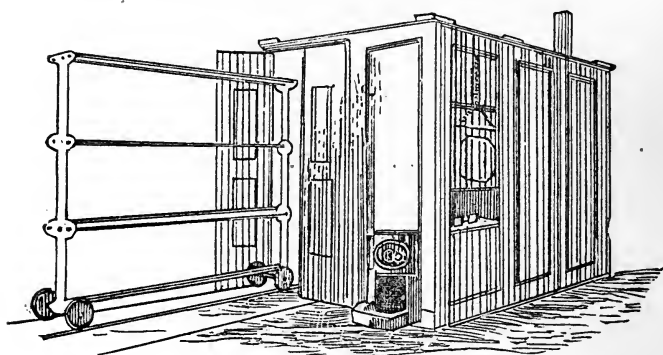

Fig. 24.

air from the chamber can be made to pass through the furnace. From 60 to 75 pounds of coke are consumed each time of using the apparatus.

#### RAETKE'S DISINFECTING OVEN.

This consists of a rectangular sheet-iron box 5 ft. long, 5 ft. high, and 3 ft. 3 in. broad. The chamber is divided by an iron partition, which divides the chamber into two compartments, the larger one for the reception of the articles to be disinfected, and the smaller, which contains a grate, and above it a reservoir for the heated air. A valve, which can be opened or closed from without, divides the hot-air reservoir from the disinfecting chamber. The fuel used is coke, or coke and coal. The temperature of the interior is indicated by a thermometer in the cover of the apparatus. The apparatus is portable. Experiments by Prof Max. Wolff<sup>1</sup> show that this machine is capable of producing all the disinfectant effects to be obtained from dry heat.

#### GENESTE, HERSCHER ET CIE'S DISINFECTING APPARATUS.

A model of this machine is in the Museum of Hygiene at Washington, D. C. It consists of a chamber heated by a coil of steam pipes at the bottom and around the sides. Some of the steam pipes are perforated to permit the escape of steam into the chamber during the disinfection. The apparatus is portable, but can only be used where steam can be obtained. There is a door at each end of the apparatus, and the articles to be disinfected are placed upon a framework running upon a track. A thermometer in the side of the apparatus is intended to indicate the internal temperature. The steam used is not under pressure.

<sup>1</sup> Virchow's Archiv. Bd., 102, p. 83.

## LYON'S PATENT STEAM DISINFECTOR.

[Dr. Parsons's report, p. 293.]

This consists of a large and strong iron chamber, with double walls of boiler plate, and provided with a tightly fitting door at one or both ends.

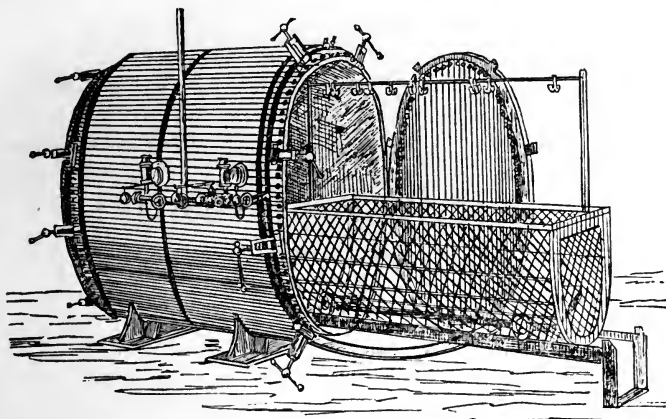

Fig. 25.

The chamber is usually made elliptical in section, the long diameter of the ellipse being vertical for the more convenient reception of bulky articles, as mattresses, sofas, etc. In its original form it had a door hung

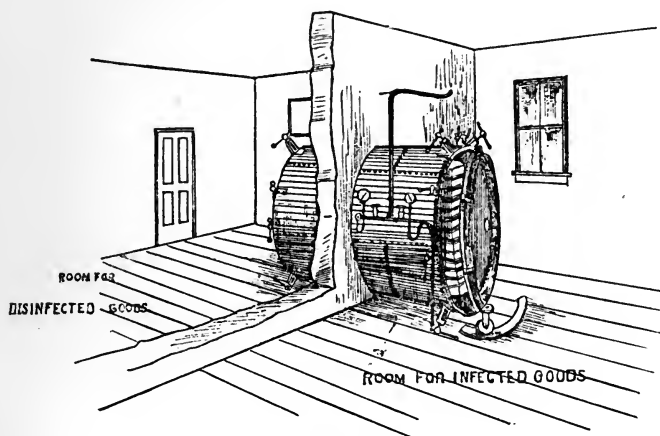

Fig. 26

on hinges at one end only, the back being steam jacketed like the circumference. This form was made to run on wheels for removal from place to place, if desired.

Another form, designed for a town disinfecting station, and intended to be placed in the partition wall dividing the building into two sides for infected and disinfected articles respectively, is cylindrical, and has a door at either end. The doors swing on hinges, their weight being borne by a castor running on a curved rail. The door shuts against an India-rubber collar, and is fastened with screws to make a steam-tight joint.

Steam from a boiler can be admitted into either the hollow casing or the interior of the chamber. A steam gauge registers the pressure. If a higher temperature is desired in the chamber, it may be secured by increasing the pressure of the steam in the casing. The latter procedure has an additional advantage, as it prevents the condensation of the steam in the chamber, thus keeping it in the condition of "dry steam."

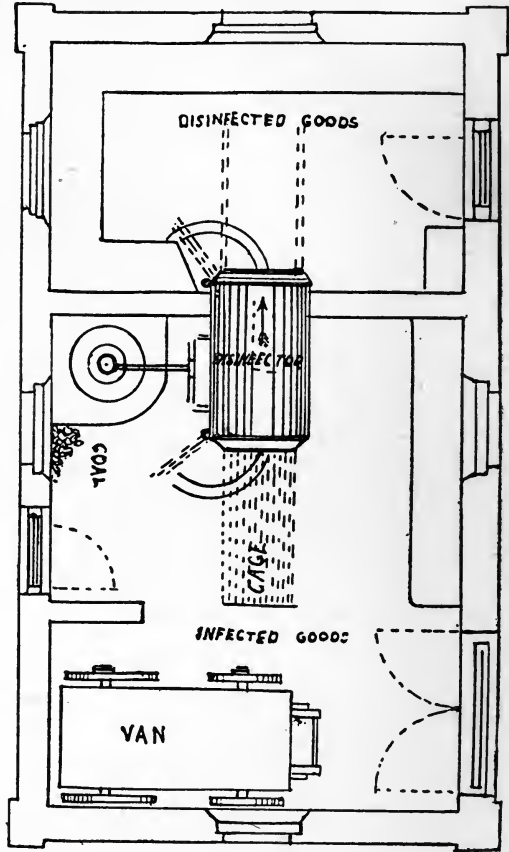

Fig. 27.

### BENHAM & SONS' STEAM DISINFECTOR.

[Dr. Parsons's report, p. 297.]

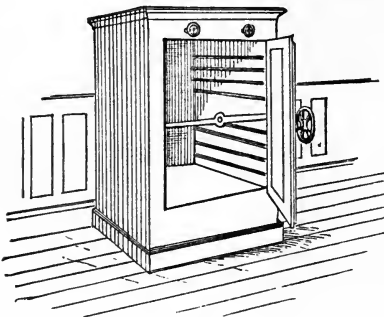

Fig. 28.

This consists of a rectangular iron chest resembling a fire-proof safe, the internal dimensions being 3 ft. long, 1 ft. 6 in. wide, and 3 ft. 6 in. high. It is surrounded by a steam jacket one inch thick, except on the side formed by the door, and for a space three inches in width surrounding it. The chest itself is of cast iron, the outer wall of the jacket being  $\frac{3}{8}$  in. boiler plate. Steam from a boiler can be



admitted both into the casing and into the interior of the chamber. The door is formed of a plate of cast iron strengthened by ribs and opening on hinges. The face against which it shuts is furnished with an India-rubber collar set into a groove. The door is secured by a single large screw in the centre, working into a female screw in a strong iron bar which lies across the mouth of the chamber, resting in a groove on either side, so that it can be removed to allow articles to be placed in the chamber. This form of fastening allows the door to be opened with great facility and expedition, but is not adapted to sustain a high pressure.

#### BRADFORD'S STEAM DISINFECTOR.

[Dr. Parsons's report, p. 300.]

This apparatus is a horizontal cylinder of boiler plate 7 ft. long and 4 ft. in diameter, supplied with steam from a boiler. It is covered with a non-conducting composition. It has not a complete steam jacket, but there is a square steam chamber applied to the bottom, into which steam can be let by a branch pipe in order to warm the cylinder. This chamber is furnished with a "steam trap" to run off condensed water. The cylinder has a door at either end. The doors are hung from wheels running on bars overhead. The two ends of the cylinder are isolated from each other by a partition wall dividing the apartment in which the machine is contained into two rooms, as in Lyon's apparatus.

#### GIBIER'S MOVABLE DISINFECTING STOVE.

[*Journal d'Hygiène*, July 22, 1886.]

M. Paul Gibier recently presented at the Academy of Medicine of Paris a design for a steam disinfecting stove, which has many novel features. The apparatus may be taken to pieces and easily transported. The inventor claims as one of its advantages that it can be taken into the sick-room, and disinfection of infected articles accomplished on the spot.

The base consists of a stove, the top of which is formed of a shallow basin constituting the boiler. From an outlet in the bottom of the boiler a pipe runs to one side of the stove-case, where it terminates in a stop-cock. By this means the boiler is emptied of water when the disinfection is completed. Over the boiler is a perforated plate, upon which the objects to be disinfected are placed. This forms the bottom of the disinfecting chamber, which is made of segments of sheet iron covered with felt to retard escape of heat. The different segments are easily and rapidly joined by means of the clamp-screws, as shown in the figure.

After the articles to be disinfected are placed in the chamber, the top, which is furnished with a thermometer projecting into the interior of the chamber, is put into its place and fastened by means of clamps. A steam pipe furnished with a stop-cock leads from the top of the chamber into

the stove pipe, which connects with the chimney. The fuel used is wood, coal, or coke.

In order to use the apparatus, the boiler is filled with water, and the fire lighted. The infected articles are placed in the chamber, the top clamped on, and the cock (*R E*) on the steam pipe turned off in order to raise the pressure in the chamber. This need not, indeed, cannot, be raised much above the ordinary pressure of the atmosphere. The steam given off from the open surface of the boiler penetrates the objects to be disinfected, and rapidly destroys all pathogenic organisms. By means

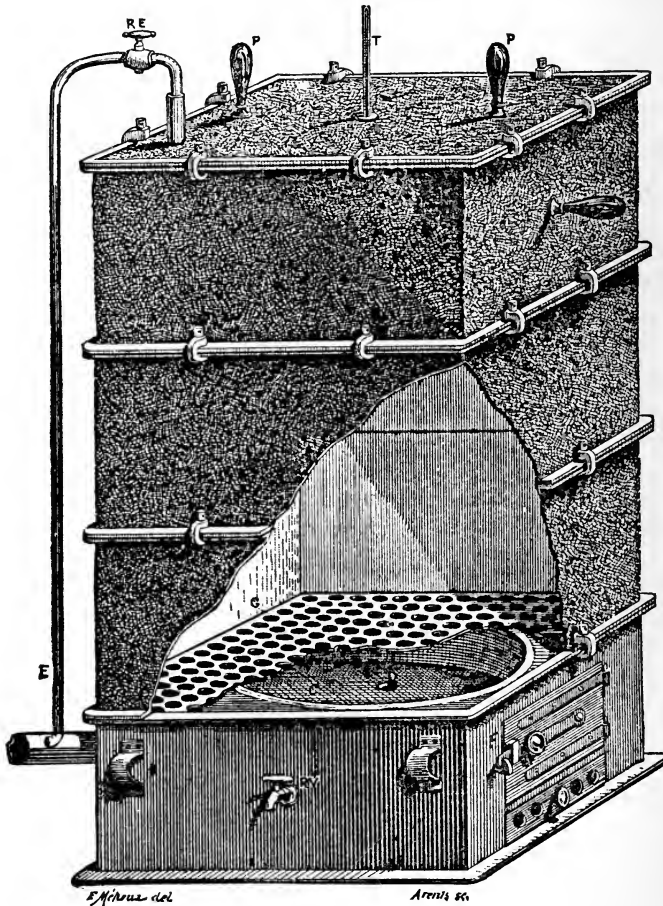

Fig. 29.

of this apparatus M. Gibier claims to have sterilized cultures of the microbes of cholera, typhoid fever, pneumonia, septicæmia, yeast, carbon, and aspergillus in the centre of a feather bed after exposure for two hours. This would be quite a satisfactory test, if the size (thickness) of the feather bed had been given.

M. Gibier does not aim at a higher temperature of the steam than 100° C. (212° F.).

RECK'S PATENT STEAM DISINFECTOR.

This is recommended by the royal Danish health authorities, and is constructed in two forms. The cylindrical form consists of an iron chamber 7 ft. long and 3 ft. in diameter, with a steam-tight door at each end. It is placed horizontally; and the building in which it is placed is divided by a partition into two apartments,—one for infected and the other for disinfected goods. The steam is generated in an iron boiler, and enters the chamber at the top (f), making its exit at the bottom (g). A layer of small stones (P) (fragments of granite) is put in the bottom

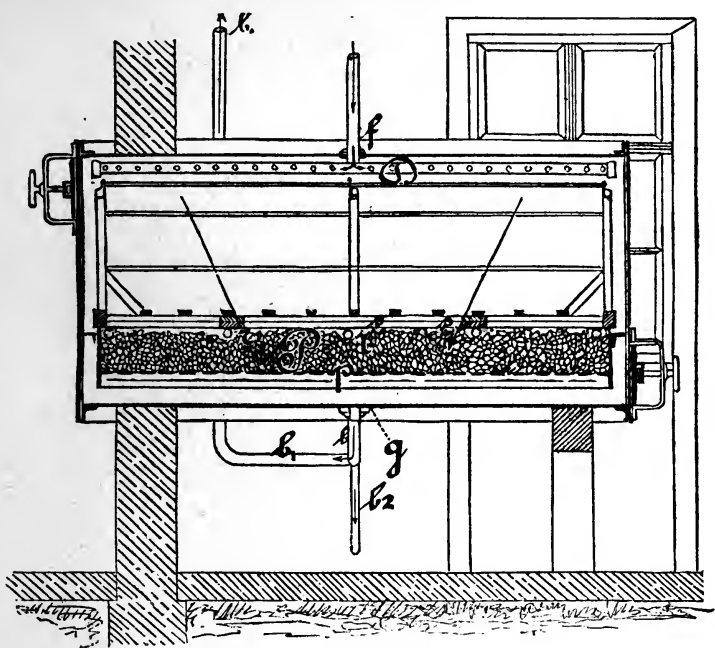

Fig. 30.

of the chamber, which, by becoming heated by the passage of the steam, assists in drying the air, which is admitted after turning off the steam, and drying the disinfected articles. The steam is not under pressure; hence the temperature in the chamber does not exceed 100° C. (212° F.). A thick layer of felt surrounds the chamber to prevent the rapid escape of heat. No record of experimental tests of disinfecting power could be found.

## GENESTE, HERSCHER ET CIE'S STEAM DISINFECTOR.

[*Scientific American*, August 28, 1886.]

Messrs. Geneste & Herscher's stove consists of a large, horizontal metallic cylinder, forming a purifying chamber in which the objects treated

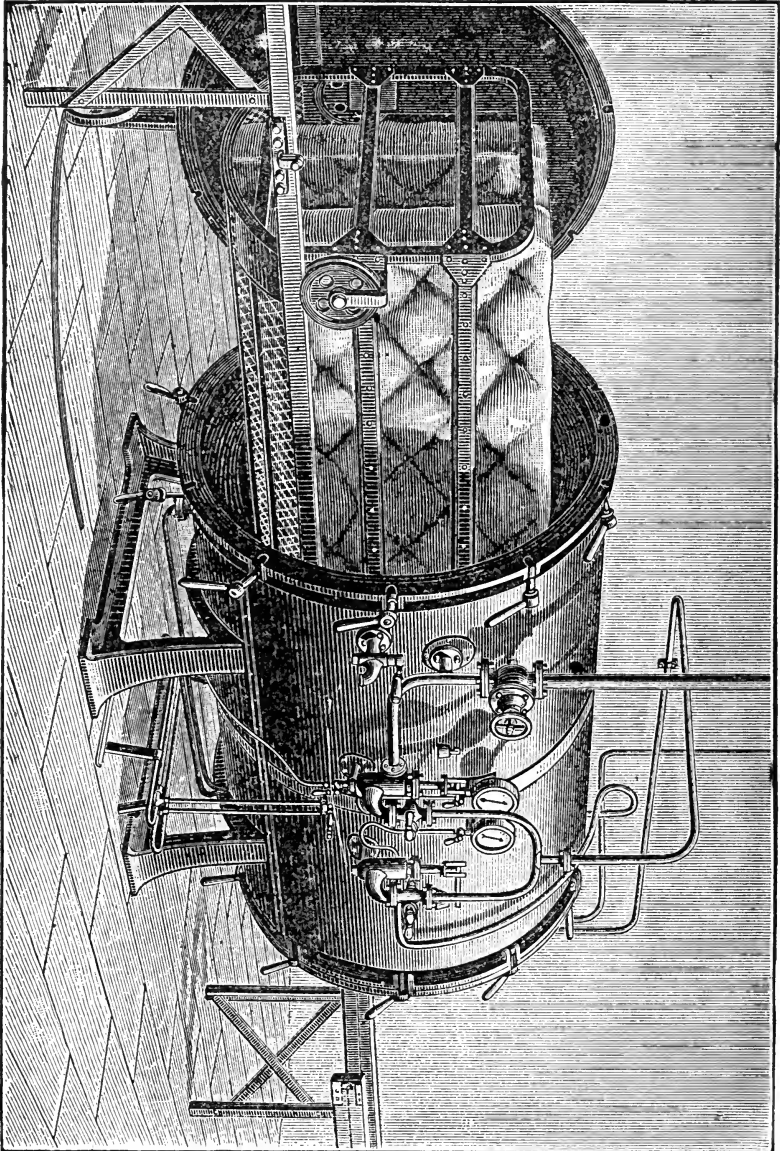

Fig. 31.

are directly exposed to the action of steam under pressure. Although the said pressure should normally correspond to  $+110^{\circ}$  C. (only about

half an atmosphere), and be regulated by a safety valve to a maximum of 115° (1½ lbs.), the body of the cylinder is constructed of iron plate of a resistance much above such a limit. The cylinder is surrounded by an isolating jacket, and provided with entrance and exit doors that are mounted upon pivots and move upon a roller. These are closed by means of bolts, the joint being formed of a circular groove containing an elastic and hermetical packing. The interior of the stove is provided at the right and left with a track upon which runs a carriage designed to receive the objects to be disinfected. In front of and behind the cylindrical body a double track permits the carriage to put itself in position to be loaded or unloaded, these two operations having to be performed in two separate parts of the disinfecting establishment in order to prevent disinfected objects from getting mixed with infected ones.

In the interior of the stove there are two sets of heaters, each consisting of a row of iron tubes of small diameter. One of these is at the top, is covered with a screen, and is designed to prevent spotting and wetting through the dropping of water of condensation from the inner surface of the stove. The other, which fills the space below the carriage, is so arranged as to effect a rapid drying of the objects after disinfection.

The objects to be disinfected, having been placed upon the carriage, are introduced into the stove. After the disinfection is completed, it will be necessary to partially open one of the doors in order to free the articles from the small amount of dampness that they possess.

#### DOBROSLAVINE'S "SELHYDIC" DISINFECTING STOVE.

[*Revue d'Hygiène*, June, 1886.]

This apparatus of novel construction consists of a double-walled cylindrical copper kettle imposed upon an iron stove. The latter is lined

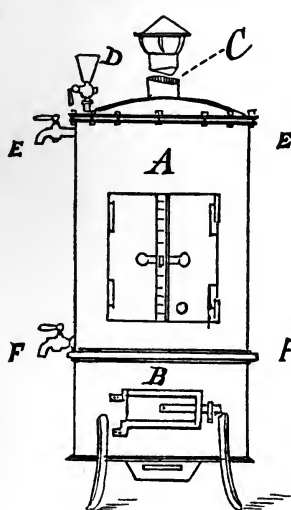

Fig. 32.—Elevation.

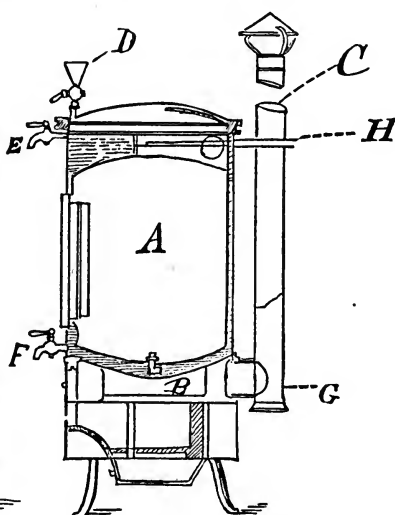

Fig. 33.—Longitudinal section.

with fire-brick. The space between the walls of the kettle, and between the roof of the stove and the bottom of the copper kettle, is occupied by a saline solution (usually solution of chloride of sodium, 40%). At one point (*H*, Fig. 33) is a little cistern communicating with the space between the perpendicular walls. The communication between this cistern and the annular space is made by means of a valve. Having filled the space with the saline solution until the latter overflows into the cistern, a valve with a float attached is automatically closed, cutting off

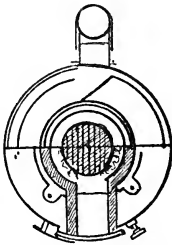

Fig. 34.—Plan at *G*, Fig. 33.

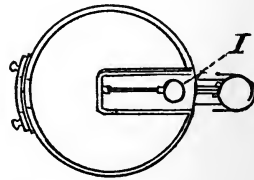

Fig. 35.—Plan at *H*, Fig. 33.

*A.*—Copper cylinder ; *B.*—Stove ; *C.*—Flue ; *D.*—Funnel for filling cistern ; *E.*—Cock for emptying cistern ; *F.*—Cock for emptying saline solution ; *I.*—Ball-valve in fresh-water cistern.

the communication between the cistern and the interparietal cavity. The cistern is then filled with pure water ; and when the level of the saline solution is depressed by its transformation into steam, the float opens the valve and allows the pure water to flow into the annular boiler, thus maintaining the saline solution at a uniform density.

A lead pipe runs from the under surface of the top of the kettle between the two walls of the kettle, and opens into the disinfecting chamber in the centre of the bottom. The steam disengaged from the surface of the solution passes down through this tube, and is superheated on its passage through the saline solution. It enters the disinfecting chamber at a temperature equivalent to the boiling point of the solution.

#### PARKER & BLACKMAN'S STEAM DISINFECTING APPARATUS FOR BALED RAGS, ETC.

This apparatus consists of an ordinary engine of sufficient power and boiler strength, with an attached superheater. To this is appended a series of iron boxes about the shape of and large enough to admit a bale of rags pushed in endwise. Each one of several boxes has penetrating through from the rear end five gimlet-bit screws nearly as long as a bale of rags, enlarged from a point to about two inches in diameter, and at such a distance apart as to about equally divide the end of a bale. These screws are hollow, and are perforated in their whole circumference and length ; and, moreover, each one is the terminus of a steam-escape cock.

The screws are rapidly revolved by the machinery. On pushing in a bale of rags, it no sooner comes in contact with the points of the screws than it is drawn with great rapidity. The box is now closed by a flap door, hinged at the top, and the steam turned on in through the screws and around the bale. In two or three minutes the temperature of the bale throughout, as thus exposed, can be raised to 330° F. (or more, if required), and sustained for any desired length of time. But they become so thoroughly penetrated with heat in ten min-

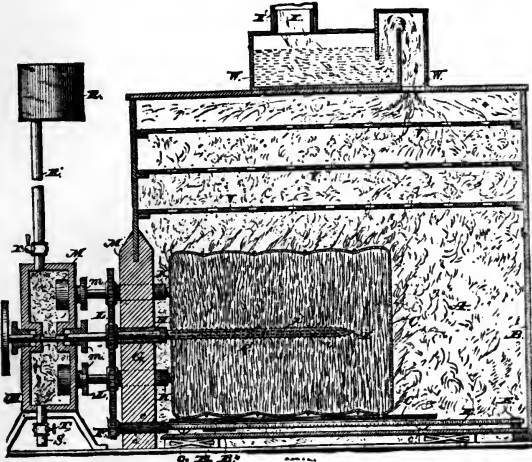

Fig. 36.

utes that a high temperature is kept up for several hours after they are removed. This is tested by pushing a thermometer into the screw holes. This apparatus is patented.

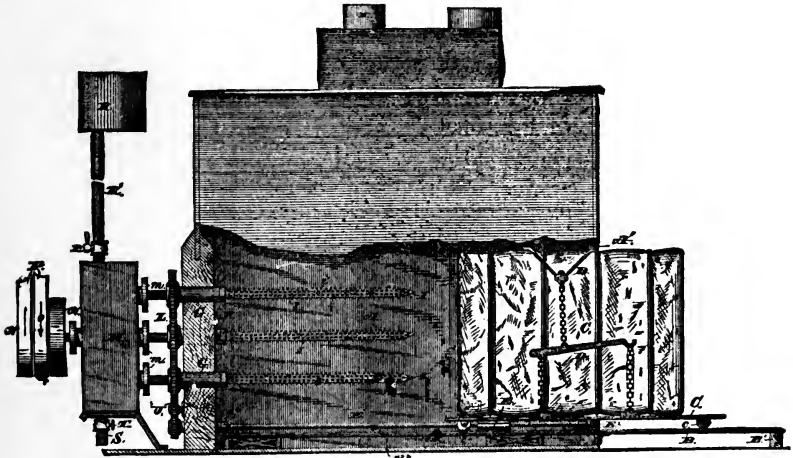

Fig. 37.

utes that a high temperature is kept up for several hours after they are removed. This is tested by pushing a thermometer into the screw holes. This apparatus is patented.

#### SCHIMMEL'S DISINFECTING APPARATUS (MERKE'S DESIGN).

This consists of a sheet-iron chamber with double walls, the space between the latter being filled with sawdust in order to retain the heat. In the interior of the chamber are two sets of steam pipes,—one for heating the air, and another, which is perforated, for the purpose of liberating steam. The objects to be disinfected are introduced into the disin-

fecting chamber, the steam is turned on in the pipes, and warms the contained air, while steam also escapes into the chamber, and, penetrating the articles undergoing disinfection, quickly raises the temperature to the necessary height to effectually destroy all pathogenic or innocent germs. This apparatus is also portable, but where no steam can be obtained at the place of use, a steam boiler is a necessary attachment.

This is the apparatus used in the public disinfecting station just erected in Berlin. By this apparatus, it is claimed that infected articles can be disinfected in about forty minutes. Of course it is understood that the time of heating up the chamber is not included. The waste steam of one of the public sewage-pumping stations is utilized as the disinfecting agent.

#### DÜSSELDORF DISINFECTING APPARATUS.

[Fleischhamer and Mittenzweig: *Vierteljahr, f. Gerichtl. Med. u. Off. Santsar*, Jan. 1886.]

This apparatus was constructed for a public disinfecting station in the city of Düsseldorf, Germany, by Messrs. Walz and Windscheid of that city. The disinfecting agent is superheated steam. The apparatus consists of a disinfecting chamber, with an internal measurement of 2.5 metres (8 feet) long, 1.5 metres (5 feet) high, and 1.2 metres (4 feet) broad. The infected articles are brought into the disinfector in an iron truck, and the space in the chamber filled with steam. This steam is introduced at the top of the chamber; it is not under pressure, an opening at the bottom of the chamber permitting the escape of the air as the temperature and expansion increase. The steam is superheated by a separate furnace, which heats the walls of the chamber.

The time required to heat the apparatus is from two to two hours and a half. The objects to be disinfected are then introduced, and the chamber filled with steam. The heating then continues for an hour and a half, when the objects can be removed. Experiments made with various pathogenic and non-pathogenic organisms placed in the interior of large bundles (20) of blankets, demonstrated that this time was sufficient for complete disinfection, even in the interior of the bundles. It is claimed that no injury to the materials treated resulted when the temperature in the interior of the chamber was raised to upward of 150° (302° F.).

#### THE STRASBURG DISINFECTING STATION.

(*Rev. d'Hygiène*, June, 1886.)

In the city of Strasburg a public disinfecting station has been erected, in connection with the municipal hospital for infectious diseases. The disinfecting apparatus is constructed of stout boiler-plate, with double walls, the interspace being filled with non-conducting material. The chamber has a door 3 feet 3 inches wide, and 6 feet 6 inches high at each end. The space between the two doors is 7 feet 6 inches. The disinfecting agent is steam under pressure. The steam boiler is six horse-power. The chamber is also heated by a coil of steam pipe, giving a



large amount of heating surface. The amount of pressure of the steam is regulated by passing the outlet pipe under water. The height of the column of water through which the escaping steam is obliged to pass determines the pressure. This makes an efficient safety-valve. It is estimated that during times of epidemic the bedding of 100 beds can be disinfected in the course of twenty-four hours, at this station.

#### DISINFECTING STATIONS AT BOSTON AND NEW ORLEANS QUARANTINES.

At the Boston quarantine station on Gallop's island, steam under pressure is used as the disinfecting agent. The apparatus is described in Appendix "B" by Dr. Samuel H. Durgin, president of the Boston Board of Health, and a member of the Committee on Disinfectants.

At the New Orleans Maritime Disinfecting Station at Port Eads, a disinfecting apparatus on a large scale is now being tested under the supervision of Dr. Joseph Holt, president of the Louisiana State Board of Health, and also a member of the Committee on Disinfectants. Dr. Holt has promised an extended report of the results of his observations with this apparatus at the next meeting of the Association. The agent used is steam under pressure.

In the foregoing pages an attempt has been made to give a succinct and comprehensive account of the various methods in which heat is applied for the purpose of destroying infectious material. It will be observed that in most of the later forms of apparatus proposed and in use, *steam under pressure or superheated* is the agent used for disinfection. This would indicate that the conclusion reached by the committee in its general report, that steam under pressure is the most efficient and trustworthy non-destructive disinfectant, is based upon practical experience and observation.

#### APPENDIX "B."

##### PRACTICAL EXPERIENCES WITH MOIST HEAT (STEAM UNDER PRESSURE) AS A DISINFECTANT.

BY S. H. DURGIN, M.D., CHAIRMAN OF THE BOARD OF HEALTH, OF BOSTON, MASS.

The part I have to contribute to the report of the Committee relates solely to the use of moist heat as a disinfectant in our city and in quarantine.

In the spring of 1885, having concluded to make use of moist heat, we fitted up a room near the end of the wharf at Gallop's island, in quarantine, and within ten feet of where our quarantine steamboat may lie alongside. This room is about ten feet by twelve feet on the floor, and seven feet in height. It is made fairly tight, and has one window, on the inside of which is a thermometer, so arranged as to permit the temperature of the room to be read from the outside.

A hole two inches in diameter is made in the door, into which is fitted a strong rubber hose leading from and connecting with the top of the boiler in the steamboat. Superheated steam is discharged through the hose into the room, and the temperature raised, in about six or seven minutes, to  $230^{\circ}$  F. It may easily be raised to  $250^{\circ}$  or more, but is generally raised to  $230^{\circ}$ , and held at that point for twenty minutes, for the disinfection of any kind of clothing or other infected articles which can be steamed without injury. The articles to be treated are hung about the room loosely, and when removed from the room, which takes place as soon as the heat will allow, are found to be perfectly dry, and not even the polish on the freshly laundered shirts is changed or damaged in the least. Boots, trunks, valises, and all other articles which are made of leather, are quickly destroyed by the high temperature, and should not, therefore, be subjected to this process. Wood-work and paint are also damaged, and all articles which are joined together by cement fall apart.

In any place which is accessible to the steamboat for the supply of steam heat, the process can be quickly applied, easily managed, is without appreciable cost, and its trustworthiness as a disinfectant, when the necessary conditions are complied with, has been well established by Dr. Sternberg and others.

In March, 1885, a company proposing to disinfect rags in the bale by the use of superheated steam, and having secured the confidence of the Board of Health, established a plant in the Charlestown district of our city, close to the Hoosac Tunnel docks, where the Board of Health permitted rags in bale to be sent for disinfection. The requisite furnaces, boilers, and steam pipes for making and delivering moist heat at a very high temperature were provided. Strong boxes, large enough to contain one bale each, with hollow perforated screws, four or five feet in length, passing within and fitted to one end of the box, were arranged. Everything being ready, the Board of Health was notified, and the following process witnessed: The screws were set in motion by steam power, when a moderate pressure of the bale of rags against them was sufficient to draw the bale into the box on the perforated hollow screw. This being done, the end of the box was closed tightly, and the steam discharged through the hollow screw into the centre of the bale. A pyrometer situated on the box and reaching within indicated the temperature of the steam after escaping from the bale of rags at  $300^{\circ}$  F. After three minutes the pressure was relieved by an exhaust, the box opened, and the bale removed, when the hot steam appeared to issue from every square inch of its surface. Not only did appearances favor the belief that this was a perfect disinfection of the whole bale of rags, but the experiments of eminent bacteriologists had already shown that disease germs of the greatest resisting power had been sterilized within the bale of rags which passed through this process. I then certified my belief that this process was effectual in its power to disinfect bales of rags. A few days later, in the month of April, I made another examination of the process by thrusting my fingers into various parts of the bale immediately on its removal from the steam-

box, when to my surprise I found bunches of rags perfectly cold, while rags within two inches of them were intensely hot. This fact was communicated to the management, when greater heat and longer time was ordered and used.

In the month of May, 1885, another examination was made, Dr. Smith, health officer of New York, Dr. Raymond, health commissioner of Brooklyn, Dr. Abbott, of the Massachusetts State Board of Health, Drs. Griffin and Cogswell, our port physicians, and the city Board of Health being present. At this time, the degree of the moist heat used was  $350^{\circ}$  F., and the time allowed to each bale was four minutes. When the bales were removed from the steam-box, they were immediately examined with the fingers squeezed into the bale through holes cut in the sacks. The fingers generally came in contact with heat too intense to be borne for a moment, but by persevering the cold places were found and examined by the gentlemen present. It was subsequently determined by the managers of the process to use a higher degree of moist heat, and to expose the rags to it for a longer time. Much unfavorable criticism of this method of disinfecting rags had then been provoked, and the question as to whether thorough disinfection could be accomplished in this way was being seriously discussed.

In August, 1886, I made another examination. I found at this time moist heat being injected into the bale at  $500^{\circ}$  F., as indicated by the pyrometer just before entering the bale, and the time given to each bale was eight minutes, a slight exhaust being allowed from the box all the time. I examined three bales as they were removed from the steam-box, and although with more difficulty than on previous occasions, yet the cold places were found by the use of the fingers within the bale, and witnessed by the overseer.

I was informed by the overseer that a large number of bales had been set on fire by this last method, and that water had been required to extinguish it.

The works were closed up in August, and have not since been operated. The conclusions to be drawn from these experiences seem to be that the moist heat passing from the centre to the surface of a bale of rags must encounter knots or bunches of rags varying in degrees of density and of resistance to the penetration of heat; that while the temperature of the principal part of the bale is raised to a degree far above what is required for disinfection, other parts of the bale are found to be wholly unaffected by the heat; that anthrax bacilli having been killed and metals melted at  $240^{\circ}$  F. within bales of rags subjected to this process, are facts not inconsistent with the experiences here given, and do not prove the disinfection of the whole bale. The degree of heat, the amount of pressure, and the time necessary for moist heat to penetrate and raise the temperature of *all* parts of a bale of rags to a degree necessary for disinfection without burning the rags, have not yet, so far as I am aware, been declared.

# COMMITTEE ON DISINFECTANTS, 1887.

## REPORT OF THE CHAIRMAN OF THE COMMITTEE.

### INTRODUCTION.

Various circumstances prevented the Committee on Disinfectants from undertaking any experimental work during the year intervening between the meeting in Washington (1885) and that in Toronto (1886). But having learned at the Toronto meeting that a small fund, contributed mainly by state boards of health, was subject to its orders, a continuance of the experimental work commenced in 1885 was determined upon, and by a vote of the committee was entrusted to the chairman.

In the report previously submitted, the committee, after considering the experimental evidence available, recommended for practical use, in the disinfection of clothing, excreta, dwellings, ships, hospitals, etc., a limited number of chemical agents, and the use of steam or boiling water in those cases in which disinfection by heat was practicable. Specific directions were given for the use of the various agents recommended (*vide* Vol. XI, Reports and Papers of the A. P. H. A., pp. 272-282). The following agents were recommended in the report referred to :

### CONCLUSIONS.

The experimental evidence recorded in this report seems to justify the following conclusions :

The most useful agents for the destruction of spore-containing infectious material are,—

1. *Fire.* Complete destruction by burning.
2. *Steam under pressure.* 110° C. (230° Fahr.) for ten minutes.
3. *Boiling in water for one hour.*
4. *Chloride of lime.* A 4 per cent. solution.
5. *Mercuric chloride.* A solution of 1 : 500.

For the destruction of infectious material which owes its infecting power to the presence of micro-organisms *not containing spores*, the committee recommends,—

1. *Fire.* Complete destruction by burning.
2. *Boiling in water* half an hour.
3. *Dry heat*, 110° C. (230° Fahr.) for two hours.
4. *Chloride of lime*, 1 to 4 per cent. solution.
5. *Solution of chlorinated soda*, 5 to 20 per cent. solution.
6. *Mercuric chloride.* A solution of 1 : 1,000 to 1 : 4,000.
7. *Sulphur dioxide.* Exposure for twelve hours to an atmosphere containing at least 4 volumes per cent. of this gas, preferably in presence of moisture.
8. *Carbolic acid*, 2 to 5 per cent. solution.
9. *Sulphate of copper*, 2 to 5 per cent. solution.
10. *Chloride of zinc*, 4 to 10 per cent. solution.

The agents named in this list are all comparatively cheap, and leave scarcely anything to be desired from a practical point of view, if they are efficient in the proportions named, and for the purposes specifically stated in the report referred to.

The immediate reason for appointing a Committee on Disinfectants was the prospect that our country might soon be invaded by cholera, and the general desire among sanitarians to have some reliable data upon which to base their practical efforts to restrict the progress of this and other infectious diseases. Keeping in view this object, and the fact that the funds at the disposal of the committee have been for the most part contributed by state boards of health, it has seemed advisable to make further tests of the agents heretofore recommended rather than to seek new and possibly expensive chemical agents, which might have equal or superior potency for the destruction of pathogenic organisms.

The object in view in our first series of experiments was to obtain as quickly as possible data which might serve to guide us in making practical recommendations in advance of the threatened epidemic of cholera. After making a very thorough search of the literature of the subject, and tabulating the experimental data from various sources, the experimental work recorded in our previous report was carried out. It will be seen, upon reference to the record of experiments made, that the test employed in a considerable proportion of these was the power of the agent to destroy the vitality of the bacteria of putrefaction, as found in "broken down beef tea." The writer was aware that this test was open to the criticism that the material to be disinfected did not contain any pathogenic organisms, and for this reason cultures of the anthrax bacillus were added to the putrefying beef infusion in a certain proportion of the experiments; and other experiments were made upon pure cultures of the anthrax bacillus, as well as upon cultures of micrococci from various sources, some no doubt pathogenic. But the writer's own previous experiments, and a consideration of the literature of the subject, had convinced him that all known pathogenic organisms have less resisting power to heat and to chemical agents than have the spores of various bacilli commonly found in putrefying beef tea, which has been freely exposed to the air. Among the pathogenic organisms known, the anthrax bacillus, in the spore-stage, has the greatest resistance to destructive agents. The test employed was therefore believed to be the most severe one available, and the data obtained to be applicable in a general way to all pathogenic organisms of the same class.

As the time and money at our disposal did not admit of an extended experimental inquiry as to the resisting power of each known pathogenic organism to each of the agents tested, the more general test referred to was employed. In resuming our experiments, however, it has seemed best to test our conclusions, based upon the data indicated, by experiments made with the same agents upon pure cultures of the various pathogenic and non-pathogenic bacteria available for such purpose.

It is a matter of general scientific interest, as well as of practical

importance, to know whether various organisms of this class differ greatly as to their resisting power to the same agent, or whether an agent which is fatal to one of these organisms, in a certain proportion, is capable of destroying all others in something near the same amount. The wide difference in the resisting power of spores, and of micro-organisms in the absence of spores, was fully brought out in our previous report. In recording the experimental work accomplished by myself and under my direction during the past year, I shall discuss in succession the data relating to the several agents named in the above quotation from the previous report of the committee, in the order therein given. My own time has been given chiefly to experiments relating to the thermal death-point of micro-organisms. Other duties have prevented me from giving as much time to laboratory work as I could have wished. But I have been fortunate in securing the services of a gentleman well qualified for carrying out that part of the work which it was impossible for me to do myself. The experiments upon chemical disinfectants have been made under my direction by Dr. Meade Bolton, who returned from Germany about the time that I was ready to commence these experiments. Dr. Bolton had spent a considerable time in the laboratories of Prof. Flügge in Göttingen, and of Prof. Koch in Berlin, and his special training and published papers are a sufficient guaranty as to the scientific accuracy of his work.

#### TEST ORGANISMS EMPLOYED.

Pure cultures of the various organisms which have served as a test of the germicide power of the agents tested have been obtained, for the most part, from the laboratories of Germany, and especially from that of Prof. Koch in Berlin. The purity of the cultures has been maintained, when necessary, by the plate method, and the identity of each species has been verified by a careful study of its morphological and biological characters, and a comparison of the same with those given in standard works upon bacteriology.<sup>1</sup>

As some of these organisms are scarcely known except to bacteriologists, a brief account of the characters by which they may be distinguished will be given here.

#### SPIRILLA.

1. *Spirillum of Asiatic cholera* ("comma bacillus," of Koch). This organism, discovered by Koch, in 1884, in the rice-water discharges of patients suffering from cholera, is now pretty generally believed to be the essential etiological factor in the causation of this disease. It must be admitted that the experimental proof that this is the case is not as satisfactory as could be desired, but the constant presence of the "comma bacillus" in the alvine discharges of cholera patients seems to be well established, and the weight of evidence is certainly in favor of the view that it bears a causal relation to the disease.

<sup>1</sup>Eisenberg, "Bakteriologische Diagnostik. Flügge, "Die Mikro-Organismen," 2d ed.

The stock which has served for our experiments upon this organism was brought by Dr. Bolton from Germany. Our experiments were made during the winter months, and every precaution was taken to prevent accident. The possibility of accident from the careless handling of such material is evident, and in one instance it is said to have occurred in the case of a student in one of the German laboratories, who suffered an attack of cholera while working with cultures of the spirillum under consideration. It is reported that the organism was found in abundance in his alvine discharges. The danger to the individual is, however, a small matter compared with the responsibility which rests upon the experimenter in view of the possible danger to the community. This responsibility I have had constantly in view; and having completed my experiments during the winter months, I have taken the precaution to destroy all of the cultures in my hands.

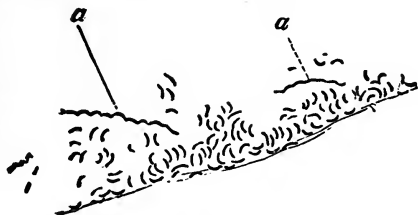

Fig. 1. From "Die Mikro-Organismen," p. 341.

The morphology of the cholera spirillum is shown in Fig. 1, which is taken from the recent work of Flügge.<sup>1</sup> The drawing is from a cover-glass preparation of a pure culture in beef-infusion (after Koch). The amplification is 600 diameters.

The cholera spirillum grows best at a temperature of 30-40° C. (86-104° Fahr.). At 16° C. (60.8° Fahr.) growth appears to cease

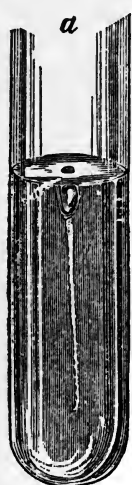

Fig. 2. "Die Mikro-Organismen," p. 346.

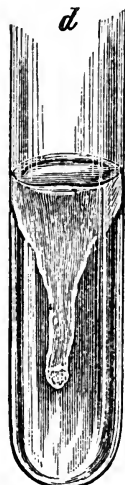

Fig. 3. "Die Mikro-Organismen," p. 383.

(Eisenberg). It is not destroyed by exposure for some hours to a temperature of -10° C. (-18° Fahr.). It grows readily in a variety of media, and is endowed with active movements. It liquefies solidified blood-serum and gelatine. It is distinguished from allied species—cheese

<sup>1</sup> "Die Mikro-Organismen," p. 341.

spirillum and Finkler-Prior spirillum—by its growth in gelatine and by the form of very young colonies in gelatine plate-cultures.

Figure 2 represents the growth of the cholera spirillum in flesh-peptone gelatine at the end of two and of four days. Fig. 3<sup>1</sup> represents the growth of the Finkler-Prior spirillum in the same medium at the end of the same time.

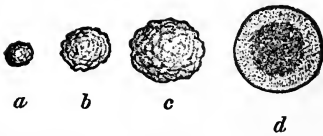

Fig. 4. "Die Mikro-Organismen," p. 345.

Figures 4, 5, and 6, also taken from Flüggé's recent work, represent the colonies as seen upon gelatine plates of the cholera spirillum (Fig. 4), the Finkler-Prior spirillum (Fig. 5), and the cheese spirillum of Deneke (Fig. 6).

In Fig. 4 we have at *a* the appearance of a colony at the end of 20 hours, at *b* of 30 hours, at *c* after 36 hours, at *d* after 48 hours. Liquefaction of the gelatine has already commenced at *c*, and at *d* the colony has sunken to the bottom of the funnel-shaped depression in the gelatine, caused by liquefaction about it.

In Fig. 5, *a* represents a colony at the end of 16 hours, *b* after 24 hours, *c* after 36 hours. It will be observed that not only is the appearance of the young colonies different, but growth is more rapid, and complete liquefaction around the colony has occurred at the end of 36 hours.



Fig. 5. "Die Mikro-Organismen," p. 383.

Figure 6 represents colonies of the cheese spirillum at the end of similar intervals of time—*a* 16 hours, *b* 24 hours, *c* 36 hours.

There is no evidence that the cholera spirillum, or the allied organisms referred to, form endogenous spores during any part of their life cycle. It has been claimed, however, by Hueppe, that reproductive bodies of another kind—the so-called arthrospores—are formed under certain circumstances. These are spherical bodies, which are developed from the spiral filaments, and not in their interior. It is still a question whether

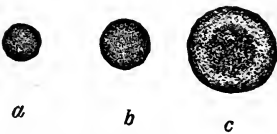

Fig. 6. "Die Mikro-Organismen," p. 387.

these spherical bodies are the result of retrograde changes in the spirilla, or whether they are reproductive elements, as Hueppe claims to have demonstrated by direct observation. The numerous experiments of Koch and his pupils show that the cholera spirillum is very promptly destroyed by desiccation, and this fact is opposed to the view that it forms spores. In a moist condition the spirillum may retain its vitality in culture media for many months (at least nine).

2. *Finkler-Prior spirillum*. This organism, obtained by Finkler and Prior from the dejections of patients suffering from sporadic cholera—*cholera nostras*,—was at first supposed by them to be identical with the "comma bacillus" of Koch. This has been shown not to be

<sup>1</sup> Figures 2 and 3 are taken from "Die Mikro-Organismen," pp. 346 and 383.



true, and the researches of Koch and his pupils have established the fact that there are constant differences in the mode of growth in gelatine, etc., which make it apparent that this is a distinct species, or, at all events, a well established variety.

3. *Cheese spirillum* of Deneke. This organism, which was obtained by one of Flügge's pupils in some old cheese which had been kept for some time in the laboratory, resembles the cholera spirillum even more closely than does the Finkler-Prior spirillum. There is, however, a very perceptible and constant difference to be distinguished in the appearance of the young colonies in gelatine plate-cultures. According to Flügge, this spirillum does not grow upon cooked potato either at the room temperature or in the incubating oven. Deneke, in a limited number of experiments upon Guinea-pigs, failed to obtain any evidence that this spirillum is a pathogenic organism. In a comparative experiment made upon six Guinea-pigs with pure cultures of the three species of spirillum referred to, by injection into the duodenum (Koch's method), Deneke obtained a negative result from the two animals inoculated with the Finkler-Prior and in the two inoculated with the cheese spirillum, while both of those inoculated with the cholera spirillum died.

## BACILLI.

1. *The bacillus of typhoid fever.* This bacillus, first described by Eberth in 1880, is constantly found in the spleen of typhoid fever cases, both post mortem and during life. The bacillus is also present in the liver, the mesenteric glands, and in a certain proportion of the cases in the kidney. The appearance of colonies in stained sections of the spleen is shown in Figs. 7 and 8.

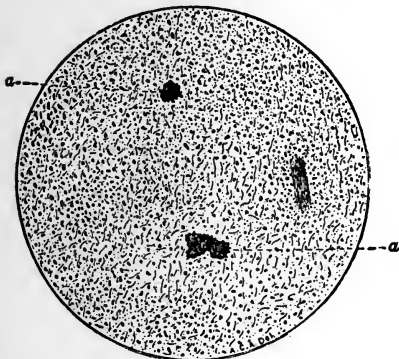

Fig. 7.

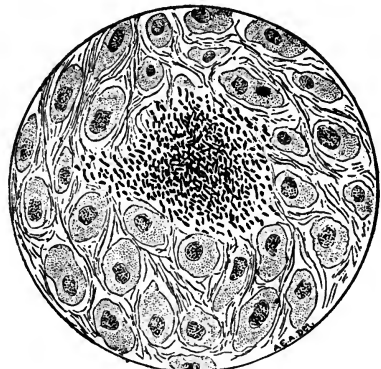

Fig. 8.

Two colonies are seen in Fig. 7 (at *a a*), as they appear under a low power—about 60 diameters. In Fig. 8 one of these colonies is seen more highly magnified—about 500 diameters.<sup>1</sup>

<sup>1</sup> These figures were drawn for the writer by Dr. A. C. Abbott to illustrate a paper read before the Association of American Physicians in June, 1886.

As in the case of the spirillum of Asiatic cholera, experiments upon the lower animals have not served to prove in a satisfactory manner the etiological relation of this bacillus to the disease with which it is associated. But the fact that the lower animals are not susceptible to certain specific infectious diseases to which man is subject, is in accord with our knowledge relating to infectious diseases in general. A failure to obtain experimental proof of the etiological relation of a micro-organism, by experiments upon animals which do not suffer the disease under investigation in a natural way, is by no means opposed to the view that such etiological relation exists. And, in the present state of science, it may be said that the probabilities are altogether in favor of such a relation when a specific organism is found to be constantly present in the tissues involved in a specific morbid process. The very extended researches made during the past two or three years justify the belief that the bacillus in question is the cause of typhoid fever, and on account of the wide prevalence of this disease in the United States, and the importance of measures of disinfection for its restriction, it has been largely

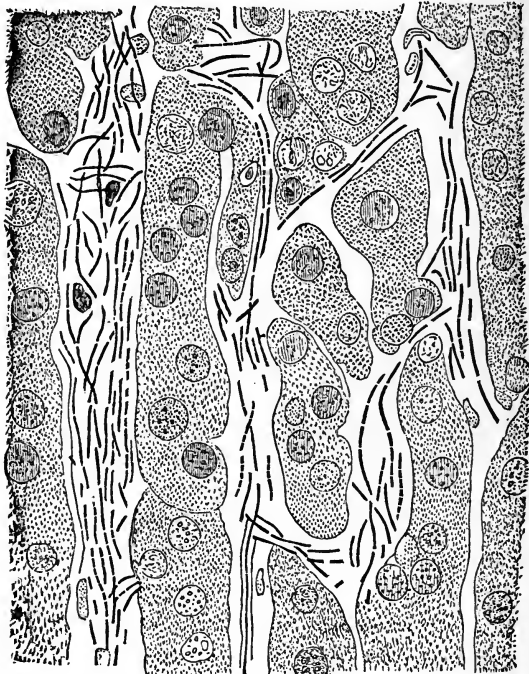

Fig. 9. From "Die Mikro-Organismen."

used as a test organism in the experimental research recorded in this report.

The characters by which this bacillus may be recognized are given by Eisenberg<sup>1</sup> as follows :

<sup>1</sup> Bakteriologische Diagnostik.

**MORPHOLOGY.**—Bacilli, three times as long as broad, with rounded ends, may grow to long threads—*scheinfäden*—and are also found as very short rods; are mobile, and probably possess flagella; take the aniline colors less intensely than most similar organisms.

**GROWTH.**—*Upon gelatine plates*: superficial grayish-white colonies with serrated margins; under a low power these resemble glass-wool, and have a brownish lustre. *Stick-cultures in gelatine*: growth, for the most part superficial, in the form of a grayish-white layer with serrated margins; but little growth along the track of the needle. *Upon agar-agar*: superficial growth of a whitish color. *Upon potato*: invisible growth; after forty-eight hours the pieces of potato have a moist appearance; when the surface is disturbed with a platinum needle, one receives the impression that it is covered with a cohering film; under the microscope this is found to consist of long spore-bearing threads of typhus bacilli. *Upon blood-serum*: grows only along the track of the needle as a milk-white layer; grows slowly.

**SPORE-FORMATION.**—At 32°–40° C. spores are formed in the course of three or four days; these are located at the ends of the rods. At 20° C. spores are formed after a longer period; at lower temperatures than this, spores are no longer formed.

2. *Bacillus anthracis*. This is an organism which is pathogenic for man as well as for many of the lower animals. It does not form spores within the body of an infected animal, but in artificial culture-media, in the presence of oxygen, it forms endogenous spores which have great resisting power to heat and to chemical agents.

Fig. 9, taken from Flügge's work, shows the anthrax bacillus in a thin section from the liver of an animal dead from the disease. The amplification is 700 diameters.

In Fig. 10<sup>1</sup> the formation of spores in an artificial culture medium is represented.

In Fig. 11 the appearance of a colony in a gelatine plate-culture is shown. At *a* a colony 24 hours old, and at *b* one at the end of 48 hours (from Flügge op. cit.).

3. *Bacillus of rouget* (Pasteur).

4. *Bacillus of schwincrothlauf* (Löffler, Shutz).

5. *Bacillus of mouse-septicæmia* (Koch).

*Schwincrothlauf* of the Germans, and *rouget* of the French, are no doubt identical diseases. My cultures, obtained in the first instance from Pasteur's laboratory in Paris and Koch's laboratory in Berlin, show no differences in the morphology or mode of growth of the organisms as obtained from the two sources. The bacillus of mouse-septicæmia, first

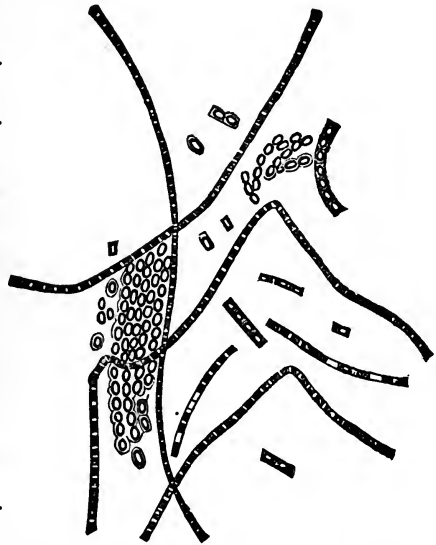

Fig. 10. Klein's "Micro-Organisms and Disease."

<sup>1</sup> From Klein's "Micro-Organisms and Disease."

described by Koch in 1878, is also apparently identical with the above. Eisenberg says, with reference to the bacillus of *schwimerothlauf*, that "in its form, as well as in its behavior to culture media, it is very similar to the bacillus of mouse-septicæmia, perhaps identical." Flügge also refers to the similarity in form and pathogenic properties, but describes the bacilli under different headings. I have not been able to discover any difference in the morphology of the bacillus in my pure cultures from Koch's laboratory under the two names, or in the mode of growth in gelatine.

Eisenberg describes the bacillus of mouse-septicæmia as follows: Very small rods—0.8 to 1.0  $\mu$  long, 0.1 to 0.2  $\mu$  thick—frequently united in pairs; motionless; growth in gelatine slow, in the form of white, delicately blending clouds, which are diffused through the gelatine (along

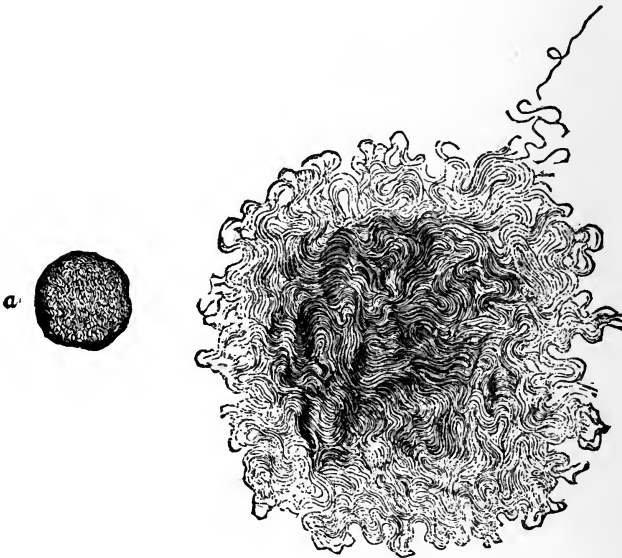

Fig. 11. From "Die Mikro-Organismen."

the line of puncture in stick-cultures). The gelatine is not liquefied, and the bacillus is said to form spores.

The bacillus of *schwimerothlauf* and mouse-septicæmia is pathogenic for swine, for field-mice, for pigeons, and in a less degree for rabbits. Sheep and young cattle are also said to be susceptible (to the rothlauf bacillus). Guinea-pigs and domestic fowls are insusceptible.

The bacillus of mouse-septicæmia is shown in Fig. 12, which has been copied from Koch's original memoir,<sup>1</sup> in which it is described as follows:

The bacilli lie singly or in small groups between the red blood corpuscles, and have a length of .8 to 1  $\mu$ . Their thickness, which cannot be measured accurately, but only approximately estimated, is about .1 to .2  $\mu$ . . . . One often sees the bacilli in septi-

<sup>1</sup> "Traumatic Infective Diseases," Sydenham Societies' Translation, 1880.

cæmic blood attached to each other in pairs, either in straight lines or forming an obtuse angle. Chains of three or four bacilli also occur, but they are rare. . . . Without the use of staining materials, the bacilli can only with extreme difficulty be recognized in fresh blood, even when one is familiar with their form; and I have not been able to obtain any certain evidence as to whether they move or not. Their relation to the white blood corpuscles is peculiar. They penetrate these, and multiply in their interior. One often finds that there is hardly a single white corpuscle in the interior of which bacilli cannot be seen. Many corpuscles contain isolated bacilli only; others have thick masses in their interior.

The appearance of the growth in a gelatine "stick-culture" is shown in Fig. 13, which is taken from Flügge's work, heretofore referred to.

In the figure, *a* represents a culture of the *schwinerothlauf* bacillus in gelatine, and *b* a colony of the same bacillus upon a gelatine plate.

6. *Emmerich's bacillus*. This is a pathogenic organism obtained by Emmerich from the blood and organs of individuals who died of cholera during the Naples epidemic of 1884, and supposed by him to be the cause of the disease. He has failed, however, to establish any etiological relation between this bacillus and cholera, and Koch and his pupils have

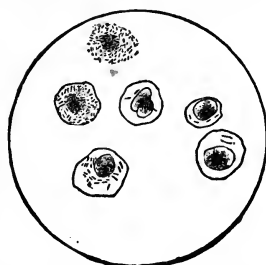

Fig. 12. White blood-corpuscles from one of the veins of the diaphragm of a septicæmic mouse.  $\times 700$ .

shown that the same bacillus may be obtained from the intestinal contents of individuals dying from various other diseases. When injected in considerable quantity into the sub-cutaneous connective tissue of Guinea-pigs, or into the cavity of the abdomen, death follows in from 30 to 48 hours.

7. *Brieger's bacillus*. This bacillus, obtained by Brieger from feces, is pathogenic for Guinea-pigs. The animals die within 72 hours after a sub-cutaneous injection, and the bacillus is found in the blood. The bacilli are short rods, about twice as long as broad.

8. *Bacillus of Friedlander*. The so-called "pneumococcus" of Friedlander is described by recent German authorities as a

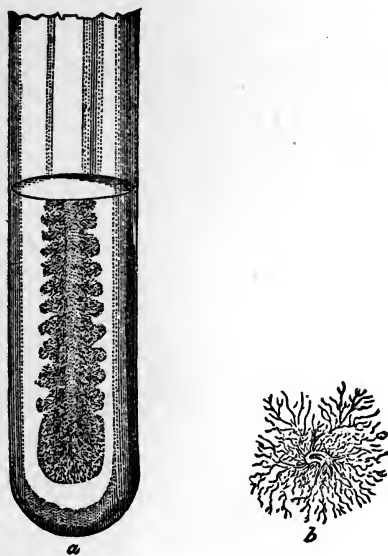

Fig. 13. From "Die Mikro-Organismen."

bacillus. The claim that it is the specific agent concerned in the etiology of croupous pneumonia is not sustained by Friedlander's experiments, or by the researches of subsequent investigators. The most that can be claimed for it is that it is one of several micro-organisms which are frequently found in the exudate into the alveoli

in cases of pneumonia, and which possibly bear a causal relation to the disease. This bacillus is pathogenic for mice and for Guinea-pigs, but not for rabbits. Stick-cultures in gelatine present the appearance of a nail, the body being formed by the growth along the line traversed by the platinum needle in making the puncture, and the head by a rounded mass which develops upon the surface of the gelatine around the point and where the needle entered. This mode of growth is not peculiar to the bacillus in question. The so-called capsule, which is seen especially in preparations (stained by Gram's method) of blood from an animal recently dead, is also not peculiar to this bacillus. Friedlander's bacillus grows readily in a variety of culture-media. The cultures, which have served for my own experiments and those of Dr. Bolton, came originally from Koch's laboratory.

9. *Bacillus crassus sputigenus*. This is a pathogenic bacillus obtained by Kreibohm from sputum. It grows readily in various media, and, in gelatine stick-cultures, presents the nail-like growth which Friedlander at first supposed to be a distinguishing character of his "pneumococcus." Small quantities injected sub-cutaneously kill mice within 48 hours. It is fatal to rabbits when injected into the circulation through a vein of the ear.

10. *Bacillus alvei*. This is a bacillus which Watson Cheyne has demonstrated to be the cause of "foul brood" in bees. The larvæ become infected, and die in the cells of the comb in which they are enclosed. The bacillus is also pathogenic for mice and for Guinea-pigs. It liquefies gelatine, and grows rapidly in a variety of culture-media. Very large oval spores are developed in the rods, which then have a spindle form.

11. *Tubercle bacillus*. This bacillus is now generally recognized as the cause of tuberculosis in man and in the lower animals. It is so well known that a description of its characters is scarcely necessary. On account of its slow growth and the difficulties attending its cultivation in artificial media, it has not been used in our disinfection experiments.

12. *Bacillus pyocyaneus* (B. of green pus). This bacillus is classed by Eisenberg with the pathogenic organisms, and the statement is made that it kills Guinea-pigs when injected into the abdominal cavity. It liquefies gelatine, and gives to it a fluorescent green color. The bacilli are slender rods of various lengths, resembling in form the bacillus of mouse-septicæmia, but somewhat thicker.

In addition to the pathogenic bacilli named, experiments have been made with the following non-pathogenic bacilli.

13. *Bacillus Indicus*. Obtained by Koch, while in India, from the stomach of a monkey. Forms a bright red pigment when it grows upon the surface of a culture-medium, freely exposed to oxygen.

14. *Bacillus prodigiosus*. Well known under the name of "micrococcus prodigiosus," but now classed by Flügge among the bacilli.

Forms a deep red pigment when freely exposed to the air; liquefies gelatine.

15. *Bacillus syncyanum* (B. of blue milk). This bacillus forms a grayish-blue pigment, which in cultures is diffused through the culture-medium. The rods are motile, and of varying length—from 1 to 4  $\mu$  long, and 0.3 to 0.5  $\mu$  broad. This bacillus is said by Eisenberg to form spores.

16. *Fluorescent bacillus*. Obtained from water. Forms a fluorescent greenish-yellow pigment. In gelatine cultures the pigment is absorbed by the gelatine. Growth occurs chiefly upon the surface, and very little along the track of the needle in stick-cultures. The bacilli are short and slender rods, with rounded ends; they are not motile, and so far as is known do not form spores.

17. *Bacillus acidi lactici*. This is the lactic acid ferment. The rods are short and comparatively thick—1 to 1.7  $\mu$  long, and 0.3 to 0.4  $\mu$  thick (Hüppe). They are usually united in pairs, and are motionless. This bacillus does not liquefy gelatine. According to Eisenberg, it forms spores, which are developed at the extremities of the rods and appear as highly refractive spherical bodies.

18. *Bacillus butyricus*. This is the butyric acid ferment (Pasteur). It quickly liquefies gelatine. The rods vary greatly in length, and often grow out into long filaments. Spores are formed at a temperature of 35° to 40° C.

19. *Wurtzel bacillus*. Obtained from earth. Short bacilli with rounded ends, about three times as long as broad; motile; liquefies gelatine; forms spores.

20. *Bacillus subtilis*. A widely distributed species. The rods are about three times as long as thick, and have rounded ends. They are often united in chains made up of several elements, or grow out into long filaments. They are motile, and have been shown by Koch to be provided with flagella. This bacillus forms spores which have great resistance to heat and chemical agents. It liquefies gelatine.

#### MICROCOCCI.

1. *Staphylococcus pyogenes aureus* (micrococcus of osteo-myelitis). This micrococcus is the species most commonly found in the pus of acute abscesses. It was first isolated in pure cultures and accurately described by Rosenbach in 1884. Becker had previously (1883) obtained the same coccus from the pus of osteo-myelitis, and cultures of the organism from this source have been kept separate in the bacteriological laboratories of Europe. Eisenberg describes the organism under the two headings given above, but makes the remark that they are probably identical. This is now generally admitted. In my experiments and those of Dr. Bolton the cultures have been kept separate, but I see no good reason for continuing to treat as two species an organism obtained from two different sources. Vignal, in a recent study of the organisms found in the mouth in healthy persons,<sup>1</sup> has in a certain number of cases obtained both the

<sup>1</sup>"Archives de Physiologie," Nov. 15, 1886.

*staphylococcus pyogenes aureus* and the *staphylococcus pyogenes albus* from this source. This fact is not at all in conflict with the view that these organisms are concerned in the production of the abscesses and phlegmons in which they are found.

The *staphylococcus aureus*, when injected into the abdominal cavity of rabbits, usually causes death within 24 hours. The cocci vary considerably in size; the average diameter is given by Eisenberg as 0.87  $\mu$ . They are commonly found in irregular masses, but are also found in pairs, in groups of four, and in short chains of three or four elements. Upon the surface of a solid culture-medium the colonies have an orange-yellow color. It liquefies gelatine, and grows readily at the room temperature. In the writer's previously recorded experiments,<sup>1</sup> most of which were made before Rosenbach had published the admirable memoir in which he has defined the characters of the pus micrococci, cultures obtained from the pus of an acute abscess are constantly spoken of as "pure cultures of the micrococcus of pus." These cultures were obtained by inoculating fluid media with a minuté quantity of pus from an acute abscess, at the moment of opening it, with antiseptic precautions. As a result of such inoculations I constantly obtained cultures containing only micrococci, and, like other investigators whose work was done prior to Rosenbach's demonstration of the fact that there are several pus micrococci, similar in form but differing in color and other particulars, I inferred that my cultures contained a single species of the genus micrococcus which I designated "the micrococcus of pus." These cultures may have contained the three species of staphylococcus—*aureus*, *albus*, and *citreus* (they did not contain the streptococcus of pus); and it is evident that, with our present knowledge, they are no longer entitled to be called "pure cultures." But so far as my experiments were concerned they served the purpose of a pure culture, for they contained only micrococci, and micrococci obtained from the source mentioned. As my object was to determine the resisting power of micrococci, as compared with that of bacilli and spores, for the various chemical agents tested, the cultures employed were a perfectly satisfactory test. In the experiments recorded in the present report, the object in view has been to ascertain the resisting power of various *species* of micrococci and bacilli, for the same agents, with a view to ascertaining whether this resisting power varies greatly in different species. In other words, my previous experiments related to the comparative resisting power of micrococci, and bacilli, and spores, in a general way, while the experiments herein recorded are designed to fix the exact resisting power of various species of micrococci, and bacilli, and spirilla, and of the spores of several species of the genus *bacillus*.

2. *Staphylococcus pyogenes citreus*. This is similar to the *staph. pyog. aureus* in its morphology and in its biological characters, but is distinguished by the fact that it forms a citron-yellow color. As this character is constant, it must be considered a distinct species.

<sup>1</sup>"Am. Jour. of the Med. Sci.," Philadelphia, April, 1883. Report of Committee on Disinfectants of the A. P. H. A., Vol. XI, 1885.



3. *Staphylococcus pyogenes albus*. This also resembles the two preceding species, with which it is frequently associated in the pus of acute abscesses, but it is distinguished from them by the absence of pigment.

4. *Streptococcus erysipelatos*. Obtained by Fehleisen from the skin in cases of erysipelas, and demonstrated by him to be the cause of this disease. This coccus is distinguished from the preceding species by the fact that it divides in one direction only, and often forms long chains, especially in cultures in liquid media. It does not liquefy gelatine, and in gelatine plate-cultures it forms small, round, finely granular colonies. According to Flügge this coccus resembles very closely the streptococcus of pus, which is present in a considerable proportion of the cases in the pus of acute abscesses; but differences are to be observed in its growth in gelatine "stick-cultures," and in its pathogenic properties as tested by experiments upon animals.

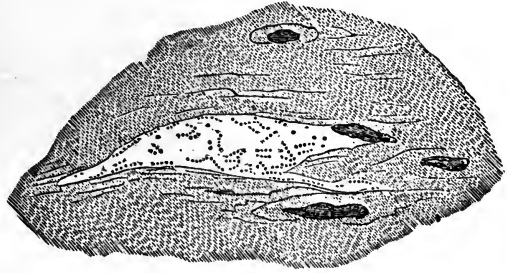

Fig. 14. From "Die Mikro-Organismen," p. 151.

Fig. 14 is copied from Flügge's recent work, and represents a section of skin from a case of erysipelas, in which the lymph-vessels are invaded by the streptococcus in question. The amplification is 700 diameters.

5. *Micrococcus tetragenus*. This is a coccus which divides in two directions, forming groups of four elements. It is often found in the buccal secretions of healthy persons, and is quite common in the purulent expectoration of phthisical patients. The cocci are about  $1 \mu$  in diameter. In gelatine plate-cultures it forms small white colonies; it does not liquefy gelatine. Koch and Gaffky have shown that this coccus is pathogenic for mice, which die within 3 to 10 days after subcutaneous inoculation with the smallest quantity of a pure culture. The cocci in groups of four are found in the blood and tissues.

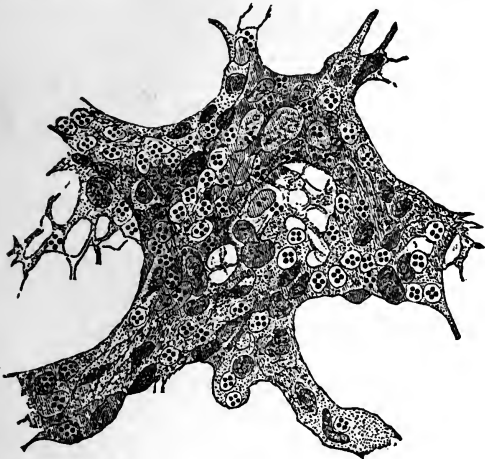

Fig. 15. From "Die Mikro-Organismen," p. 163.

Fig. 15 represents this coccus in a section of the lung of a mouse ( $\times 800$ , after Flügge).

6. *Micrococcus gonorrhææ*. This coccus, discovered by Neisser in

the pus of specific urethritis, is now generally recognized by bacteriologists as the cause of gonorrhœa. The researches of Bumm, especially, have made this to appear almost certain. In the second edition of the memoir of this author the statement is made that a characteristic urethral inflammation and discharge resulted, in a female, from an experimental inoculation with material from a 20th culture.

Bumm has shown that the "gonococcus" does not grow in the liquid and solid culture media usually employed in laboratory work, which furnish a favorable soil for the various species of micrococci above described. Those authors who had previously obtained cultures in *bouillon*, and upon flesh-peptone gelatine, by inoculating these media with gonorrhœal pus, were doubtless mistaken in the inference that the coccus obtained in their culture was identical with that in the pus cells. As a matter of fact, the researches of the author quoted have shown that several different species of micrococci may be obtained from this source.

According to Bumm, the true "gonococcus" grows very slowly upon blood-serum as a thin, often scarcely visible, layer, of a grayish-yellow color. He has been most successful in cultivating it upon human blood-serum.



Fig. 16. "Die Mikro-Organismen," p. 157.

Fig. 16 is copied from Bumm's work, published in 1885. The amplification is 800 diameters—*a*, free-lying cocci; *b*, cocci in pus cells; *c*, cocci in an epithelial cell.

7. *Micrococcus Pasteuri*. This is a pathogenic micrococcus found in the mouths of certain individuals, which was discovered by the writer, in 1880, in the blood of a rabbit which died as a result of a subcutaneous injection of a small quantity of saliva. At a temperature of 35–38° C. this coccus grows readily in blood-serum, or in *bouillon* made from the flesh of a rabbit. It may also be cultivated in agar-agar. The smallest quantity of such a culture, or of the blood of an animal recently dead from the infectious disease to which it gives rise, causes death within forty-eight hours when introduced beneath the skin of a rabbit. This coccus is present, in a large proportion of the cases at least, in the exudate into the alveoli of the lungs in

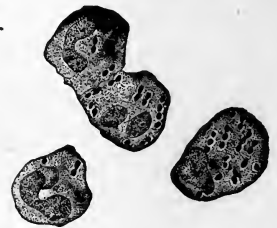

Fig. 17. From "Archive per le Scienze Mediche."

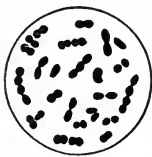

Fig. 18.

cases of croupous pneumonia; and there is good reason for believing that it is concerned in the etiology of this disease. Under certain circumstances it is surrounded by a transparent material, which has been described by some authors as a "capsule." This is well shown in Fig. 17, which is copied from a paper by Salvioli, published in the "Archive per le Scienze Mediche" (Vol. VIII).

Fig. 18 is from a drawing carefully made for the writer by Dr. A. C. Abbott, and represents *M. Pasteuri* as seen in the blood of a rabbit

which had been inoculated with fresh pneumonia sputum, obtained from a patient in the seventh day of the disease. The amplification is 1000 diameters.

## SARCINÆ.

Experiments have been made upon two species of the genus *Sarcina*, one of which is distinguished by a yellow color, while the other has a bright-orange color. These are not pathogenic. The sarcinæ are distinguished from the micrococci by the fact that division occurs in three directions forming groups of eight elements.

## METHODS OF RESEARCH.

In the experiments recorded in the report of the Committee on Disinfectants for 1885 liquid cultures were employed, the culture-fluids being enclosed in hermetically sealed glass flasks, such as the writer has been in the habit of using for a number of years. The manner of making and using these flasks is described as follows in "Bacteria:"<sup>1</sup>

The writer described, in a paper read at the meeting of the American Association for Advancement of Science, in August, 1881, a method of conducting culture experiments which he has found extremely satisfactory, and which has the advantage of assuring the greatest possible security from contamination by atmospheric germs. The culture-flasks employed contain from one to four fluid drachms. They are made from glass-tubing of three or four tenths inch diameter, and those which the writer has used in his numerous experiments have all been home-made. It is easier to make new flasks than to clean old ones, and they are thrown away after being once used. Bellows, operated by the foot, and a flame of considerable size—gas is preferable—will be required by one who proposes to construct these little flasks for himself. After a little practice, they are rapidly made; but as a large number are required, the time and labor expended in their preparation are no slight matter. . . . After blowing a bulb at the extremity of a long glass tube, of the diameter mentioned, this is provided with a slender neck, drawn out in the flame, and the end of this is hermetically sealed. (See Fig. 19.) Thus one little flask after another is made from the same piece of tubing, until this becomes too short for further use.



Fig. 19.

To introduce a culture-liquid into one of these little flasks, heat the bulb

slightly, break off the sealed extremity of the tube, and plunge it beneath the surface of the liquid. (See Fig. 20.) The quantity which enters will, of course, depend upon the heat employed, and the consequent rarefaction of the enclosed air. Ordinarily the bulb is filled to about one third of its capacity with the culture-liquid, leaving it two thirds full of air, for the use of the microscopic plants which are to be cultivated in it.

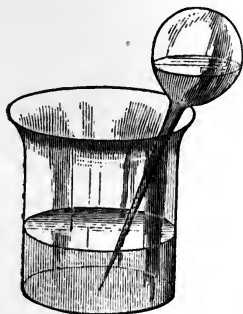

Fig. 20.

The culture-fluid in the flasks is next sterilized in a water-bath or a steam-sterilizer. Usually I am in the habit of placing a quantity of the little flasks in a water-bath, maintained at a boiling temperature for an hour or more, and, to ensure destruction of all spores, the boiling is repeated the following

<sup>1</sup> Wm. Wood & Co., N. Y., 1884.

day. The flasks are then placed in an incubating oven, at 38° C., for several days, to prove that the culture-fluid contained in them is sterile.

The test of disinfection is made by introducing into these flasks a small amount of material containing the test-organism, after having exposed this for two hours to the action of the disinfecting agent in a determined proportion. It has been my practice throughout to mix a given quantity—usually 5c.c.—of the culture containing the test organism with an equal quantity of an aqueous solution of the disinfecting agent. Dr. Bolton has been governed by the same rule in making his experiments.

In the mode of experimenting above described, a complete absence of growth in the sterile culture-medium will be evidence that all of the test-organisms introduced into the flask have been destroyed by the action of the disinfecting agent, when the experiments have been conducted with a due regard to the possible restraining influence of the germicide agent, which if introduced in sufficient amount might simply prevent growth by reason of its presence, and lead to the mistaken inference that the vitality of the test-organism had been destroyed. This error is to be avoided by diluting the germicide agent so largely with the sterilized culture-fluid into which it is introduced, along with the test-organisms which have been exposed to its action, that its restraining influence is rendered nil. Suppose, for example, that we mix with a culture of the anthrax bacillus containing spores an equal quantity of a solution of mercuric chloride of the strength of 1 to 1,000, making the proportion of the salt in the mixture 1 to 2,000: now, if we take one part of this mixture and add it to ten parts of sterilized *bouillon*, we shall have the mercuric chloride present in the proportion of 1 to 20,000. Experiments upon the restraining power of this salt show that anthrax spores will not grow in culture-solutions containing 1 to 300,000, and that their development is retarded by solutions of 1 to 600,000. Failure to develop in this case would therefore be no proof that the growing power of the anthrax spores had been destroyed. This proof is only to be attained by adding sufficient culture-fluid to dilute the mercuric chloride beyond its restraining power. The use of a comparatively large amount of the culture-fluid, and of an extremely small quantity of the material containing the test-organisms, permits us to exclude this source of error, for a few germs serve as well for the test as a large number.

For the reason stated, fluid-culture media are more suitable for experiments of this nature than solids. If we bring a little of our material containing mercuric chloride in the proportion of 1 to 2,000 upon the surface of a cooked potato, or introduce it with a needle into a gelatine-culture medium, the salt will not be diluted, and would exercise its restraining influence upon the germs if they had not already been destroyed by its action. On the other hand, if we add 1 part of the material to 100 parts of *bouillon* and mix thoroughly by shaking, the mercuric chloride will be diluted to 1 to 200,000: this being still within the limits of its restraining action, we may take one part of the mixture and add it to ten parts of the sterile *bouillon*. The mercuric chloride will now be

diluted to 1 to 2,000,000, a proportion quite beyond the limits of restraining action. But there will be a sufficient number of anthrax spores in the culture-medium to test the question as to whether the growing power of these particular "germs" is destroyed by mercuric chloride in the proportion named.

It is probable that this source of error has not been kept sufficiently in view in some of the experiments heretofore made. Again: It often happens that no development occurs for a time, but that after several days the germs which have been exposed to the action of a chemical agent commence to grow, and finally produce an abundant and vigorous progeny. In this case mistakes are likely to arise from terminating the experiment too soon. Anthrax spores, for example, develop, in a suitable culture-medium, at a temperature of 80° to 100° F. within twenty-four hours, and give rise to numerous characteristic flocculi, made up of long filaments, which are readily distinguished by the naked eye. But after exposure to a germicide agent in less amount than is necessary to completely destroy their vitality, they may fail to develop under the same circumstances in forty-eight or seventy-two hours, and yet finally produce an abundant crop of filaments.

When development occurs in the little flasks, it is evidence that some of the test-organisms, at least, have escaped destruction, but we have no way of determining whether few or many have escaped the germicide action of the disinfecting agent. From a practical point of view this is a matter of little importance. We wish to know what amount of the disinfectant will destroy *all* pathogenic germs, and in practice we will not fail to keep on the safe side, that is to say, the side of excess. But it is a matter of some scientific interest to ascertain, in a given experiment in which growth has occurred, whether few or many of the test-organisms have escaped the destructive action of the disinfectant. This may be done by the use of a gelatine culture-medium, and is very conveniently accomplished by means of Esmarch's method. In Dr. Bolton's experiments, recorded in the present report, and in my own experiments upon the thermal death-point of micro-organisms, this method has been largely employed. The details for disinfection experiments are as follows:

A pure-culture of the test-organism is made in 5 c. c. of *bouillon*, contained in an ordinary test-tube with a cotton stopper, or in a Miquel flask. To this is added an aqueous solution of the disinfectant in equal amount. The percentage of the disinfecting agent will of course be reduced one half. The mixture is allowed to stand for two hours, and a very small quantity is then introduced into a test-tube containing flesh-peptone-gelatine, which has been liquefied by heat (30° to 35° C.). A closely fitting rubber cap is then placed over the end of the test-tube, the cotton stopper being left *in situ*. The tube is now placed in a shallow vessel containing iced water, and is rotated, with its long axis in a horizontal plane, until the gelatine has become solid. The effect of this procedure is to spread the gelatine out in an even layer over the interior of the test-tube. When now it is placed aside in a room or incubating-

oven, maintained at a temperature a little below the melting point of gelatine, each micrococcus, or bacillus, or spore, which has retained its vitality, will form a colony, which after a time will be visible to the naked eye, and the characters of which may be studied under the microscope by the use of a low power objective, *e. g.*,  $\frac{1}{2}$  in.

The Esmarch tube is, in fact, a modification of Koch's plate-method, and for experiments of the kind referred to has decided advantages on account of the slight risk of accidental contamination, and of the great saving in time and space effected in using these tubes rather than flat plates of glass, in large glass jars, as in the well known plate-method of Koch.

We have also in our experiments had occasion to use potato-cultures, and have found a modification of the usual method, which has been devised by Dr. Bolton, to be very useful. This consists in cutting the potato into cylindrical pieces of about one inch in diameter, and three inches long; in slicing this obliquely in its long diameter, to make a plane surface upon which to cultivate the micro-organism; in placing these in large test-tubes of proper diameter and length (about six inches long), and stopped in the usual way with cotton plugs; and, finally, in sterilizing these in the steam-sterilizer.

#### TEMPERATURE EXPERIMENTS.

In my temperature experiments I have taken great pains to ensure the exposure of the test-organisms to a uniform temperature, and have adopted ten minutes as the standard of time of exposure. The method employed throughout has been as follows: From glass tubing having a diameter of about  $\frac{3}{8}$  of an inch I draw out in the flame of a Bunsen burner a number of capillary tubes, with an expanded extremity, which serves as an air-chamber. A little material from a pure-culture of the test-organism is drawn into each of these capillary tubes by immersing the open extremity in the culture, after having gently heated the expanded end. (See Figs. 19 and 20.) The end of the tube is then hermetically sealed by heat. These tubes are immersed in a water-bath, maintained at the desired temperature for the standard time. The bath is kept at a uniform temperature by personal supervision. At the bottom of the vessel is a thick glass plate, which prevents the thermometer bulb and capillary tubes, which rest upon it, from being exposed to heat transmitted directly from the bottom of the vessel. To further guard against this, I am in the habit of applying the flame to the sides of the vessel, and a uniform temperature throughout the bath is maintained by frequent stirring with a glass rod. It is impossible to avoid slight variations, but by keeping my eye upon the thermometer throughout the experiment, I have kept these within very narrow limits. A single thermometer, made by Schlay & Borend, of Berlin, and graduated in degrees of the centigrade scale, has been used throughout.

The experiments recorded in this report have been made through the courtesy of Prof. Wm. H. Welch, in the pathological laboratory of Johns Hopkins University.

SECTION I.—HEAT.<sup>1</sup>

The experiments, recorded in the Report of the Committee on Disinfectants for 1885, brought out in a very definite manner the great difference in the resisting power of the spores of bacilli, and of micro-organisms of the same class—micrococci, spirilla, bacilli—in the absence of spores. This difference was so great, both for heat and for chemical disinfectants, as to make it seem necessary to give specific directions separately for the disinfection of “spore-containing infectious material,” and “for the destruction of infectious material which owes its infecting power to the presence of micro-organisms not containing spores.”

The only objection which can be urged against this classification of means of disinfection, for practical purposes, is that the question of the presence or absence of spores has not been decided in the case of a number of pathogenic bacilli, and that for certain kinds of infectious material—*e. g.*, small-pox, yellow fever, pleuro-pneumonia of cattle—we have no exact knowledge of the nature of the infectious agent. It is evident that in the absence of such exact knowledge it will be safest to employ that group of disinfectants which stands the most difficult test, *viz.*, the destruction of spores. But, on the other hand, there are certain agents in the second list—*e. g.*, carbolic acid, sulphate of copper—which are extremely useful in those cases in which we can be sure that the infectious material to be destroyed does not contain spores. For this reason, and as a matter of general scientific interest, it is desirable that we should ascertain with reference to each of the pathogenic organisms known whether it forms spores, and if so what the resisting power of these spores is to heat and to various chemical agents.

Having ascertained that the spores of several well known species of bacillus require for their destruction a temperature of 100° C. (212° F.), it has been generally assumed that all spores have a resisting power much above that possessed by organisms which do not form spores. This assumption has led the writer to think that the question of the presence or absence of spores might be determined by experiments made to determine the temperature required to destroy vitality. If growth should occur after exposure to a temperature approaching 100° C., there could be no doubt that spores were present in the material, for all experiments are in accord as to the destruction of micro-organisms in the absence of spores at a much lower temperature than this—50°–65° C. But, on the other hand, it does not follow that because no growth occurs after exposure to 60° C. no spores were present. It is not safe to assume, however probable it may appear, that because the spores of various known species of bacillus require a temperature of 100° C. for their destruction, there are no spores which are killed at a lower temperature. As a matter of fact, there are differences in the resisting power of the

<sup>1</sup> The writer's experiments upon the thermal death-point of pathogenic organisms have, in part, been published in the “American Journal of the Medical Sciences” of July, 1887. Believing that the interest and value of the present report would be enhanced by publishing these experiments *in extenso*, I have introduced them here with the approval of the Executive Committee of the A. P. H. A.

spores heretofore tested in this regard, and there is no *a priori* reason for denying the possibility that there may be a wide range in the resisting power of these reproductive elements. In the experiments below recorded the writer has demonstrated that a number of species of bacilli which have been said by competent authorities to form spores, exhibit no growth after exposure to a temperature of 60° C. for ten minutes.

This question of spores has been kept in view throughout my experiments, and has seemed to me to be of special importance in the case of the typhoid bacillus. The frequent transmission of this disease by means of infected milk or water, and the importance of destroying the infecting agent in the discharges of the sick, have induced me to give this a prominent place as a test-organism in my own experiments and in those which Dr. Bolton has made under my direction.

It will be understood that all of the experiments included in this report relate to moist heat; that is to say, the test-organisms were in fluid cultures and in a moist condition. The effect of dry heat upon desiccated organisms is quite another question. This has been studied by Koch and Wolffhügel, and their results have been given by Dr. Rohé in his paper on "Dry Heat," in the report of the committee for 1885.

In recording my experiments I shall follow the order in which the test-organisms are described in the introduction to this report (p. 66 to 79).

#### SPIRRILLUM OF ASIATIC CHOLERA

(*comma bacillus* of Koch). My experiments have been made simultaneously upon the cholera spirillum and the two organism which most closely resemble it, viz., the cheese spirillum of Deneke, and the Finkler-Prior spirillum. These experiments are recorded in the following tables, in which the figures represent the temperature to which the test-organism was exposed. The figures in heavy type indicate that growth occurred after exposure to the temperature which they represent; those in light type indicate that no growth occurred; a star after the figures indicates that growth was retarded; Cont. is an abbreviation for control. In every case the control experiment was made with material from the same culture. Unless otherwise stated, the experiment was made by means of an Esmarch tube in the method detailed on page 81.

The cultures in this series of experiments were all made at the room temperature in flesh-peptone gelatine.

TABLE NO. I.

Date.	Organism.	Experiments.
December 30, 1886.	Cholera spirillum.	42°, 44°, 46°, 48°, * Cont.
	Cheese spirillum.	42°, 44°, 46°, 48°, * Cont.
	Finkler-Prior spirillum.	42°, 44°, 46°, 48°, * Cont.



In this first experiment no growth was observed in the Esmarch tubes containing the three organisms, after exposure to 48° for ten minutes, when these tubes were examined after an interval of four or five days, but subsequently a few colonies developed in each tube. This considerable retardation of growth led me to think that a slightly longer exposure would be fatal to all of these spirilla. I accordingly made the following experiment at the same temperature, but varying the time of exposure :

TABLE NO. II.

Date.	Organism.	Temp.	Time of exposure in minutes.
January 7, 1887.	Cholera spirillum.	48° C. = 118.4° F.	2, 4, 6, 8,* 10,* 12.*
	Cheese spirillum.		2, 4, 6, 8,* 10,* 12.*
	Finkler-Prior spirillum.		2, 4, 6, 8,* 10,* 12.*

This was followed by a similar experiment at 50° C.

TABLE NO. III.

Date.	Organism.	Temp.	Time of exposure in minutes.
January 10, 1887.	Cholera spirillum.	50° C. = 122° F.	2, 4, 6, 8,* 10,* Cont.
	Cheese spirillum.		2, 4, 6, 8,* 10,* Cont.
	Finkler-Prior spirillum.		2, 4,* 6, 8, 10, Cont.

In this experiment only a few colonies developed after exposure for eight and ten minutes in the case of the cholera and cheese spirillum, and none at all in the case of the Finkler-Prior spirillum. The following experiment was made at 52° C. :

TABLE NO. IV.

Date.	Organism.	Temp.	Time of exposure in minutes.
January 13, 1887.	Cholera spirillum.	52° C. = 125.6° F.	2,* 4, 6, 8, 10, Cont.
	Cheese spirillum.		2,* 4, 6, 8, 10, Cont.
	Finkler-Prior spirillum.		2, 4, 6, 8, 10, Cont.

This experiment enables us to fix the thermal death-point of these three species of spirillum at 52° C., the time of exposure being four minutes. It will be noticed that identical results were obtained as regards the cholera and cheese spirillum, while the Finkler-Prior spirillum proved to have not quite so much resisting power to heat.

The following experiment gives a result in accord with the above. It was made for the purpose of testing the question whether a difference would be shown in the resisting power of old and new cultures. We may remark here that the cholera spirillum retains its vitality for several months, at least, in cultures which are kept in a moist condition. On the other hand, Koch has shown that it is quickly destroyed by desiccation.

TABLE NO. V.

Date.	Cholera spirillum.	Temp.	Time of exposure in minutes.
January 17, 1887.	Fresh culture.	52° C. = 125.6° F.	2,* 4, 6, <b>Cont.</b>
	Culture 13 days old.		2,* 4, 6, <b>Cont.</b>

TABLE NO. VI.

TYPHOID BACILLUS.  
(Ten minutes' exposure.)

Date.	Culture medium.	Experiments.	Remarks.
1886.			
Nov. 10.	Veal broth.	50°, 60, 70, <b>Cont.</b>	In oven at 38° for 48 hours.
Nov. 15.	Veal broth.	50°, 52, 54, 56, 58, 60, <b>Cont.</b>	Fluid culture of Nov. 1st.
Nov. 30.	Potato culture.	50°, 55, 60, 70, 80, <b>Cont.</b>	Culture at room temperature.
Dec. 4.	Potato culture.	60°, <b>Cont.</b>	Culture in oven at 38° for 7 days.
Dec. 24.	Potato culture.	60°, 70, 80, <b>Cont.</b>	Culture in oven for 10 days, then kept at room temperature for 15 days.
1887.			
Jan. 15.	Potato culture.	55°, 60, 70, 80, <b>Cont.</b>	Culture in oven at 38° for 7 days.
Jan. 20.	Potato culture.	48°, 50, 52, 60, <b>Cont.</b>	In oven at 38° for 10 days.
Jan. 21.	Potato culture.	50°, 60, <b>Cont.</b>	Potato in oven for 7 days, then kept at room temperature 7 days.

An inspection of the table shows that no growth occurred in any instance after exposure to 56° C. and above. We may therefore fix the thermal death-point of the typhoid bacillus at 56°, and our experiments show that if spores are formed in potato cultures kept in the incubating oven at 38°, as asserted by Gaffky and others, these spores are also destroyed at this temperature.

## BACILLUS ANTHRACIS.

Davaine first made experiments (1873) to determine the temperature required to destroy the vitality of the anthrax bacillus as found in the blood of an animal just dead as the result of an experimental inoculation. Under these circumstances no spores are present. The destruction of vitality was tested by inoculation into susceptible animals. This method is open to the objection that at temperatures approaching that which destroys vitality the development of the bacillus is retarded, and the animal is likely to suffer a non-fatal attack of the disease which may escape observation, and the inference be drawn that the bacillus is killed. This is probably the explanation of the slight difference in the results obtained by Davaine and those of Chauveau made more recently.

## ANTHRAX BACILLUS.

TABLE NO. VII.

Authority.	Temperature.	Time of exposure in minutes.	Remarks.
.....	55°	5	In blood.
Davaine.....	50°	10	“ “
.....	48°	15	“ “
.....	50°	20	Cultures.
Chauveau.....	54°	10	“

According to Flügge anthrax spores are killed by exposure to 100° C. for two minutes. In a recent experiment by the writer a single colony developed after exposure to this temperature for two minutes, but there was no growth when the time was extended to four minutes. Keeping on the side of safety, we may place the thermal death-point of anthrax spores at 100° C. (= 212° F.), the time of exposure being five minutes. Chauveau has shown that exposure to a temperature slightly below that which completely destroys vitality causes an attenuation of virulence, and that this method may be adopted for procuring a virus suitable for use in protective inoculations. For *premier vaccin* Chauveau uses a culture which has been exposed for fifteen minutes to a temperature of 50° C. A stronger virus for the second inoculation is obtained by exposure to the same temperature for ten minutes.

*Bacillus of Glanders.* Löffler<sup>1</sup> has recently determined the thermal

<sup>1</sup> Arbeiten a. d. Kaiserlichen Gesundheitsamte, Bd. 1, Heft 5.

death-point of the *Rotz* bacillus. He finds it to be 55° C., the time of exposure being ten minutes.

*Bacillus of Swine Plague* (German, *schweine rothlauf*; French, *rouget*). *Bacillus of Mouse Septicæmia* (Koch). Pasteur's bacillus of *rouget* is, no doubt, identical with the bacillus of *schweine rothlauf* of the German bacteriologists. I have experimented upon cultures from both sources. The bacillus of mouse septicæmia is also supposed by some authors to be identical with the above. According to Eisenberg, the bacillus of mouse septicæmia forms spores. Flügge says of the bacillus of *schweine rothlauf*:

In bouillon cultures which have been kept for three days at the room temperature, or for twenty-four hours at 40°, one notices the formation of small spherical bodies, which probably represent spores, although, on account of their minuteness, the formation and development of these bodies have not, up to the present time, been exactly observed.<sup>1</sup>

My experiments upon the thermal death-point of these organisms are included in the following tables:

TABLE NO. VIII.  
CULTURES IN FLESH-PEPTONE-GELATINE.

Date.	Organism.	Temperature to which exposed.
January 20, 1887 . .	Mouse septicæmia.	50°, 60, <b>Cont.</b>
January 26, 1887 . .	Mouse septicæmia. Schweine rothlauf.	52°, 54, 56,* 58, <b>Cont.</b> 52°, 54, 56, <b>Cont.</b>
February 7, 1887 . .	Mouse septicæmia. Schweine rothlauf.	60°, <b>Cont.</b> 60°, <b>Cont.</b>
February 8, 1887 . .	Mouse septicæmia. Rouget.	54°, 56,* 58, <b>Cont.</b> 52°, 54, 56,* 58, <b>Cont.</b>

TABLE NO. IX.  
CULTURES IN BOUILLON.

Date.	Organism.	Temperature to which exposed.
March 17, 1887 . . .	Rothlauf.	60°, 65, <b>Cont.</b>
	Mouse septicæmia.	60°, 65, <b>Cont.</b>

These bouillon cultures were kept in the incubating oven at 38° for three days, and afterward at the room temperature for eight days. The bacilli were found to have grown out into slender filaments, which presented the appearance of having vacant places in their protoplasm, which possibly represented spores. As will be seen by reference to the table, no growth occurred after exposure to a temperature of 60 C. for ten min-

<sup>1</sup>Die Mikro-Organismen, p. 246.

utes. We must, therefore, admit either that this bacillus does not form spores under the circumstances stated by Flügge, or that the spores are destroyed at the comparatively low temperature named.

In the following table I include several species of pathogenic and non-pathogenic bacilli in which the question of spore-formation has not been definitely settled. In regard to the first named (Emmerich's bacillus), Eisenberg remarks "spore-formation not yet observed." According to Flügge, *B. sputig. crassus* "appears to form spores at a temperature of 35°." The bacillus of blue milk is said by Eisenberg to form spores in gelatine cultures after the third day. The lactic acid ferment is said by the same author to form spores at the ends of the rods, which appear as spherical, shining, highly refractive bodies. In my own examinations of stained cover-glass preparations from the cultures used in the following experiments, I have in no instance been able to satisfy myself of the presence of spores.

TABLE NO. X.

## RECENT CULTURES IN FLESH-PEPTONE-GELATINE.

Organism.	Date.	Temperature to which exposed 10 minutes.
Emmerich's bacillus . .	January 24.	60°, Cont.
	January 28.	70°, 80, 90, 100, Cont.
	February 1.	60°, 62, 64, Cont.
Brieger's bacillus . . .	January 24.	60°, Cont.
	February 1.	58*, 60*, 62°, Cont.
Friedländer's bacillus (So called "pneumo-coccus.")	December 24.	50°, 52,* 54,* Cont.
	January 8.	58°, 60, 62, 64, Cont.
	January 11.	54°, 56,* 58, Cont.
	January 20.	56°, 58, Cont.
Bacillus sputig. crassus . (Kreibohm.)	January 24.	60° Cont.
	January 28.	50°, Cont.
	January 31.	54°, 56, 58, Cont.
Bacillus pyocyaneus . . . (Green pus.)	December 24.	70°, 80, Cont.
	December 31.	46°, 48, 50, Cont.
	January 8.	58°, 60, 62, 64, Cont.
	January 17.	52°, 54,* Cont.
Bacillus indicus . . . .	February 2.	54°, 56, 58, Cont.
	January 21.	56°* 60, Cont.
	January 25.	56°, 58, Cont.
Bacillus prodigiosus . . (Commonly called micro-coccus prodigiosus.)	January 26.	52°* 54,* 56, Cont.
	January 26.	54°* 56, 58, Cont.
	February 2.	54°* 56, 58, Cont.
	February 2.	54°* 56, 58, Cont.
Bacillus cyanogenus . . (Bacillus of blue milk.)	January 21.	56°, 60, Cont.
	January 25.	56°, 58, Cont.
Bacillus fluorescens . . .	January 26.	52°* 54,* 56,* Cont.
	February 2.	54°* 56, 58, Cont.
Bacillus cyanogenus . . (Bacillus of blue milk.)	January 28.	50°, 60, Cont.
	January 31.	54°, 56, 58, Cont.
Bacillus fluorescens . . .	January 28.	50°, 60, Cont.
	January 31.	54°, 56, 58, Cont.
Bacillus acidi lactici . . .	January 24.	60°* Cont.
	January 26.	52°, 54, 56, Cont.
	February 1.	60°, 62, 64, Cont.
	February 8.	54°, 56, 58, Cont.

TABLE NO. XI.

POTATO CULTURES IN INCUBATING OVEN FOR THREE DAYS AT 38° TO TEST FOR SPORES.

(No spores seen on microscopic examination of stained cover-glass preparations.)

Organism.	Date.	Temperature to which exposed.
Bacillus pyocyaneus . .	March 1, 1887.	60°, 65, <b>Cont.</b>
Emmerich's bacillus . .	" "	60°, 65, <b>Cont.</b>
Brieger's bacillus . .	" "	60°, 65, <b>Cont.</b>
Bacillus acidi lactici . .	" "	<b>60°, 65, Cont.</b>

TABLE NO. XII.

OLD CULTURES IN FLESH-PEPTONE-GELATINE TO TEST FOR SPORES.

(March 7, 1887.)

Organism.	Age of culture.	Temperature to which exposed.
Brieger's bacillus . .	36 days.	60°, 65, <b>Cont.</b>
Emmerich's bacillus . .	43 "	60°, 65, <b>Cont.</b>
Bacillus pyocyaneus . .	46 "	60°, 65, <b>Cont.</b>
Bacillus fluorescens . .	42 "	60°, 65, <b>Cont.</b>
Bacillus cyanogenus . .	33 "	60°, 55, <b>Cont.</b>
Bacillus acidi lactici . .	42 "	<b>60°, 65, Cont.</b>

It will be seen that in all of these experiments the lactic acid ferment is the only one which resisted a temperature of 60° C. ; and if the presence of spores could be determined by this test, this is the only organism in the list in which there is any evidence of spore formation. I am not, however, disposed to accept this test, and think it not improbable that some of the bacilli in the list form reproductive spores, which differ from those of the anthrax bacillus and certain other spore-forming bacilli, in the fact that they are destroyed at a comparatively low temperature. The only way to settle this question will be by the method of direct observation. If the refractive spherical bodies, supposed to be spores, which may be seen in potato cultures of the typhoid bacillus, in bouillon cultures of the bacillus of swine plague, etc., are observed to develop into bacilli, they will be demonstrated to be reproductive elements, or spores, notwithstanding the fact that they are destroyed by so low a temperature as 60° C.

The following experiments have been made with pathogenic and non-pathogenic bacilli which are known to form spores :

TABLE NO. XIII.

Organism.	Date.	Temperature to which exposed, ten minutes.
Bacillus alvei (foul brood of bees) {	December 8, December 30,	80°, Cont. 90°, 100, Cont.
Wurtzel bacillus . . . . . {	January 24, January 28,	60°, Cont. 70°, 80, 90, Cont.
Bacillus butrycus . . . . . {	December 28, December 31,	80°, Cont. 90°, 100, Cont.

The following experiments have been made upon these spore-forming bacilli at a temperature of 100° C. (212° F.), the time of exposure being varied :

TABLE NO. XIV.

Organism.	Date.	Time of exposure in minutes.
Anthrax bacillus. . . . .	February 9,	2,* 4, 6, 8, 10, Cont. * A single colony.
Bacillus alvei . . . . .	February 9,	2,* 4, 6, 8, 10, Cont. * A few colonies.
Bacillus butrycus . . . . .	February 9,	2, 4, 6, 8, 10, Cont.
Wurtzel bacillus . . . . .	March 4,	2,* 4, 6, 8, 10, Cont. * A single colony.

My experiments upon micrococci are recorded in the following table :

TABLE NO. XV.

RECENT CULTURES OF MICROCOCCI IN FLESH-PEPTONE-GELATINE.

Organism.	Date.	Temperature to which exposed ten minutes.
Micrococcus of osteomyelitis. {	December 8, 1886. December 20, February 8, 1887.	50°, 52, 54, 56, 58, Cont. 52°, 54, 56,* Cont. 54°, 56,* 58, Cont.
Staphylococcus pyog. aureus .	January 11, 1887.	54°, 56,* 58, 60, Cont.
Staphylococcus pyog. citreus. {	January 8, 1887. January 11, January 20,	58°, 60,* 62, 64, Cont. 54°, 56, 58,* 60.* 56°, 58,* 60, Cont.
Staphylococcus pyog. albus . {	December 26, 1886. January 11, 1887.	52°, 54, 56,* Cont. 54,° 56, 58,* 60.*
Streptococcus erysipelatus . {	December 28, 1886. January 20, 1887. January 25,	48°, 50, 52, Cont. 50°, 52, 58, Cont. 54°, 56, Cont.
Micrococcus tetragenus . . .	January 25, 1887.	54°, 56,* 58, Cont.
Micrococcus Pasteuri . . . . {	March 29, 1887. April 7,	50°, 52, 54, 56, 58, Cont. 46°, 48, 50,* 52, Cont.

TABLE NO. XVI.

## FRESH CULTURES OF SARCINÆ IN FLESH-PEPTONE-GELATINE.

Organism.	Date.	Temperature to which exposed.
Sarcina aurantiaca . . . . .	December 24, 1886.	56°, 58,* 60,* Cont.
	January 11, 1887.	54°, 56, 58,* 60.
	January 18,	58°, 60, Cont.
Sarcina lutea . . . . .	December 29, 1886.	56°, 58,* 60,* Cont.
	January 7, 1887.	58°, 60,* 62,* 64, Cont.
	January 11,	56°, 58, 60,* Cont.
	January 18,	60°, * 62, 64, Cont.

*Gonococcus of Neisser.* Believing, as I now do, that this organism is the cause of the infectious virulence of gonorrhœal secretions (see *The Medical News* of Feb. 26, 1887), I have made the following experiment with reference to its thermal death-point. Some gonorrhœal pus from a recent case which had not undergone treatment, was collected for me by my friend, Dr. George H. Rohé, in the capillary tubes heretofore described. A microscopical examination of stained cover-glass preparations showed that this pus contained numerous "gonococci" in the interior of the cells. Two of the capillary tubes were placed in a water bath maintained at 60° C. for ten minutes. The pus was then forced out upon two pledgets of sterilized cotton wet with distilled water. Two healthy men had consented to submit to the experiment, and one of these bits of cotton was introduced into the urethra of each, and left *in situ* for half an hour. As anticipated, the result was entirely negative. For obvious reasons no control experiment was made, and no attempt was made to fix the thermal death-point within narrower limits.

In connection with these experiments upon the thermal death-point of known pathogenic organisms, it is of interest to inquire whether the virulence of infectious material, in which it has not yet been demonstrated that this virulence is due to a micro-organism, is destroyed by a correspondently low temperature. Evidently, if this proves to be the case, it will be a strong argument in favor of the view that we have to deal with a micro-organism in these diseases also. We have experimental proof that a large number of pathogenic organisms are killed by exposure for ten minutes to a temperature of from 55° to 60° C. But, so far as I am aware, this low temperature would not be likely to destroy any of the poisonous chemical products which might be supposed to be the cause of infective virulence, leaving aside the fact that such chemical products have no power of self-multiplication, and, therefore, could not be the independent cause of an infectious disease.

*Vaccine Virus.* Carstens and Coert have experimented upon the temperature required to destroy the potency of vaccine virus. In a paper read at the meeting of the International Medical Congress, in



1879, they report as the result of their experiments that the maximum degree of heat to which fresh vaccine can be exposed without losing its virulence probably varies between  $52^{\circ}$  and  $54^{\circ}$  C. Fresh animal vaccine heated to  $52^{\circ}$  C. for thirty minutes does not lose its virulence. Fresh animal vaccine heated to  $54.5^{\circ}$  C. for thirty minutes loses its virulence.

*Rinderpest.* According to Semmer and Raupach,<sup>1</sup> exposure for ten minutes to a temperature of  $55^{\circ}$  C. destroys the virulence of the infectious material in this disease.

*Sheep-pox.* The authors last mentioned<sup>2</sup> have also found that the same temperature— $55^{\circ}$  C. for ten minutes—destroys the virulence of the blood of an animal dead from sheep-pox.

*Hydrophobia.* Desiring to fix the thermal death-point of the virus of hydrophobia, I obtained, through the kindness of Dr. H. C. Ernst, a rabbit which had been inoculated, by the method of trephining, with material which came originally from Pasteur's laboratory (see Dr. Ernst's paper in the April number of the *Sanitarium*). The rabbit sent me showed the first symptoms of paralytic rabies on the eighth day after inoculation. It died on the eleventh day (March 2, 1887), and I at once proceeded to make the following experiment:

A portion of the medulla was removed, and thoroughly mixed with sterilized water. The milky emulsion was introduced into four capillary tubes, such as had been used in my experiments heretofore recorded. Two of these tubes were then placed for ten minutes in a water bath, the temperature of which was maintained at  $60^{\circ}$  C. Four rabbits were now inoculated by trephining, two with the material exposed to  $60^{\circ}$  C. for ten minutes, and two with the same material from the capillary tubes not so exposed. The result was as definite and satisfactory as possible. The two control rabbits were taken sick, one on March 10, and one on the 11th; both died with the characteristic symptoms of paralytic rabies on the third day. The two rabbits inoculated with material exposed to  $60^{\circ}$  C. remained in perfect health. On the 26th of March one of these rabbits was again inoculated by trephining with material from the medulla of a rabbit just dead from hydrophobia. This rabbit died from paralytic rabies on the 8th of April. Its companion remains in perfect health.

A second experiment was made in the same way on the 14th of March. Two rabbits were inoculated with material exposed for ten minutes to a temperature of  $50^{\circ}$  C.; two with material exposed for the same time to a temperature of  $55^{\circ}$  C.; and two control rabbits with material not so exposed. One of the rabbits inoculated with material exposed to  $50^{\circ}$  C. and one of the control rabbits died on the 25th; the other rabbit inoculated with the material exposed to  $50^{\circ}$ , the other control, and one inoculated with material exposed to  $55^{\circ}$ , on the 26th. The second rabbit inoculated with material exposed to  $55^{\circ}$  died five days later with the characteristic symptoms of the disease.

<sup>1</sup> Deutsche Zeitschrift für Thier med., vii, p. 347.

<sup>2</sup> Ibid.

These experiments show, then, that the virus of hydrophobia is destroyed by a temperature of 60° C., and that 55° C. fails to destroy it, the time of exposure being ten minutes.

*Bacillus Tuberculosis.* Schill and Fischer (1884), assuming that the tubercle bacillus forms spores, made quite a number of experiments to determine its thermal death-point. Using fresh sputum as the material, and testing the destruction of the vitality of the bacilli contained in this material by inoculations into guinea-pigs, they found that exposure to a temperature of 100° C., in steam, was efficient when the time of exposure was five minutes. When the time was reduced to two minutes a negative result was obtained in two out of three guinea-pigs inoculated, but in one death from tuberculosis occurred.

As this one guinea-pig furnishes the only evidence offered by these experimenters that the tubercle bacillus requires a temperature of 100° for its destruction, I have made a single experiment at lower temperatures. On the 8th of March I obtained, through the courtesy of Dr. Wm. T. Councilman, some perfectly fresh tuberculous sputum from a patient in the Bay View hospital. A cover-glass preparation stained by Ehrlich's method showed an abundance of tubercle bacilli. The sputum, mixed with sterilized bouillon, was drawn into the small glass tubes used in my experiments as heretofore described. Two tubes were prepared for each animal, the contents of one being injected into the cavity of the abdomen, and of the other into the sub-cutaneous connective tissue in the vicinity of the axilla. One guinea-pig was injected with sputum which had been exposed for ten minutes to a temperature of 50° C. (No. 1); one to sputum exposed for the same time to 60° C. (No. 2); one at 70° C. (No. 3); one at 80° C. (No. 4); one at 90° C. (No. 5); and one (No. 6) with material not heated, to serve as a control. The control guinea-pig died of septicaemia a week after the inoculation. No. 3 (70° C.) died on the 5th of April, cause of death uncertain; no evidence of tuberculosis was found upon post-mortem examination. No. 1 (50° C.) died April 24, and was found to be tuberculous. No. 2 (60° C.) and No. 4 (80° C.) remained in good health up to April 26, when they were killed, and no evidence of tuberculosis found. No. 5 (90° C.) died on April 26; it was not tuberculous. In view of these results it is evident that further experiments are required to determine the exact thermal death-point of the tubercle bacillus, which there is reason to believe may be found not to be so high as has been commonly supposed, possibly not higher than that of the typhoid bacillus (56° C. = 132.8° F.).

Having fixed the thermal death-point of various micro-organisms for a standard time of exposure, the question arises as to the influence of this element—time of exposure—in destroying the same organisms at a given temperature. To determine this, I have selected two test organisms,—the bacillus of typhoid fever, and the staphylococcus pyogenes albus. My experiments are recorded in the following table :

TABLE NO. XVII.

Organism.	Date.	Temperature.	Time of exposure in minutes.
	1887.		
Typhoid bacillus . . .	} April 23.	50° C. }	60, 80, 100, 120, 140.
Staph. pyog. albus . . .			60, 80, 100, 120, 140.
Typhoid bacillus . . .	} April 27.	52° C. }	20, 30, 40, 50, 60, 70, 80, 90.
Staph. pyog. albus . . .			20, 30, 40, 50, 60, 70, 80, 90.

My departure for Brazil prevented me from completing the experiment. but the results recorded in the table show that at 52° C. these organisms are not destroyed even at the end of an hour and a half.

In connection with the question of the degree of heat which is fatal to pathogenic bacteria, it is of interest to know whether they are destroyed by freezing. Numerous experiments have been made with reference to this question, and all agree in showing that most bacteria have a very great resisting power to cold. Thus, Cohn found that a temperature of -18° C. was not fatal to certain species of bacteria.

Frisch (1877) by the evaporation of liquefied carbonic acid produced as low a temperature as -87° C., and exposed liquids containing bacteria to this temperature, which failed to destroy the vitality both of micrococci and of bacilli.

Recently Dr. T. M. Prudden,<sup>1</sup> of New York, has made extended experiments upon the influence of repeated freezing upon the vitality of bacteria. According to this author, certain bacteria resist protracted freezing, while others fail to grow when they have been subjected to a freezing temperature for a certain time. Thus *bacillus prodigiosus* was destroyed by being frozen for 51 days; *proteus vulgaris*, in the same time; a *slender fluidifying bacillus* from Croton water, in 7 days. On the other hand, *staphylococcus pyogenes aureus* was not destroyed by exposure to a freezing temperature for 66 days; a "*fluorescent bacillus* from Hudson river ice" survived the freezing temperature for 77 days; the *bacillus of typhoid fever* survived after 103 days. In the case of all of these organisms, however, a diminution in the number of bacilli was noted, corresponding with the length of time during which they were exposed to a freezing temperature. This is shown in the following table, which we copy from Prudden's paper:

<sup>1</sup> The *Medical Record*, New York, March 26 and April 2, 1887.

TABLE NO. VI. (*Prudden.*)

## THE BACILLUS OF TYPHOID FEVER.

Time.	Number of bacteria in 1 c. c. of water.
Before freezing . . . . .	innumerable.
Frozen 11 days . . . . .	1,019,403
Frozen 27 days . . . . .	336,457
Frozen 42 days . . . . .	89,796
Frozen 69 days . . . . .	24,276
Frozen 77 days . . . . .	72,930
Frozen 103 days . . . . .	7,348

Repeated freezing and thawing were found by *Prudden* to be more fatal to the typhoid bacillus than continuous freezing. This is shown in the following table :

TABLE NO. VII. (*Prudden.*)

## RESULT OF ALTERNATE FREEZING AND THAWING ON THE TYPHOID BACILLI—FRESH, ACTIVE CULTURE.

Frozen solid, and remained so.		Frozen solid, but repeatedly thawed and immediately refrozen.	
Time.	Number of bacteria in 1 c. c. of water.	Number of times thawed and refrozen.	Number of bacteria in 1 c. c. of water.
Before freezing . .	40,896		40,896
Frozen 24 hours . .	29,780	3	90
Frozen 3 days . .	1,800	5	0
Frozen 4 days . .	950	6	0
Frozen 5 days . .	2,490	6	0

For convenience of reference the results obtained in my own experimental studies, and those of others referred to, are brought together in a single table. Where the determination has not been made by myself, the authority is given in parenthesis after the name of the organism. The time of exposure is ten minutes unless otherwise indicated by figures in parenthesis following those representing the temperature. The table includes those non-pathogenic organisms which have been tested as well as those which are recognized as pathogenic. In this table I have adopted the nomenclature used by *Flügge* in his recent work, *Die Micro-Organismen* :

TABLE NO. XVIII.

## THERMAL DEATH-POINT OF MICRO-ORGANISMS.

Name of Organism.	Centrigrade.	Fahrenheit.
Spirillum cholerae Asiaticae . . . . .	52°	125.6° (4 m.)
Spirillum tyrogenum <sup>1</sup> . . . . .	52	125.6 (4 m.)
Spirillum Finkler-Prior . . . . .	50	122
Bacillus anthracis (Chauveau) . . . . .	54	129.2
Bacillus typhi abdominalis . . . . .	56	138.8
Bacillus mallei <sup>2</sup> (Löffler) . . . . .	55	131
Bacillus of schweine-rothlauf (rouget of Pasteur) . . . . .	58	136.4
Bacillus murisepticus . . . . .	58	136.4
Bacillus Neapolitanus <sup>3</sup> . . . . .	62	143.6
Bacillus cavicida <sup>4</sup> . . . . .	62	143.6
Bacillus pneumoniae <sup>5</sup> . . . . .	56	132.8
Bacillus crassus sputigenus . . . . .	54	129.2
Bacillus pyocyanus . . . . .	56	132.8
Bacillus indicus . . . . .	58	136.4
Bacillus prodigiosus . . . . .	58	136.4
Bacillus cyanogenus . . . . .	54	129.2
Bacillus fluorescens <sup>5</sup> . . . . .	54	129.2
Bacillus gallinarum (Salmon) <sup>7</sup> . . . . .	56	132.5
Bacillus acidi lactici <sup>8</sup> . . . . .	56	132.8
Bacillus alvei; spores . . . . .	100	212 (4 m.)
Bacillus anthracis; spores . . . . .	100	212 (4 m.)
Bacillus butrycus; spores . . . . .	100	212 (4 m.)
Bacillus mycoides; spores . . . . .	100	212 (4 m.)
Bacillus tuberculosis (Schill and Fischer) . . . . .	100	212 (4 m.)
Staphylococcus pyogenes aureus . . . . .	58	136.4
Staphylococcus pyogenes citreus . . . . .	62	143.6
Staphylococcus pyogenes albus . . . . .	62	143.6
Streptococcus erysipelatos . . . . .	54	129.2
Micrococcus tetragenus . . . . .	58	136.4
Micrococcus Pasteuri . . . . .	52	125.6
Micrococcus gonorrhoea <sup>9</sup> . . . . .	60	140
Sarcina lutea . . . . .	64	147.2
Sarcina aurantiaca . . . . .	62	143.6
Vaccine virus (Carstens and Coert) . . . . .	54	129.2
Rinderpest virus (Semmer and Raupach) . . . . .	55	131
Sheep pox virus (Semmer and Raupach) . . . . .	55	131
Hydrophobia virus . . . . .	60	140

By reference to the various tables giving the experimental data in detail, it will be seen that the results are not absolutely uniform for the same organism. Thus, in the experiments upon the typhoid bacillus no

<sup>1</sup> Cheese spirillum.<sup>2</sup> Bacillus of glanders.<sup>3</sup> Emmerich's bacillus.<sup>4</sup> Brieger's bacillus.<sup>5</sup> Friedlander's.<sup>6</sup> From water.<sup>7</sup> Pasteur's "microbe du cholera des poules."<sup>8</sup> Old culture in flesh-peptone-gelatine not killed by 60°, probably owing to the presence of spores.<sup>9</sup> A single experiment. A lower temperature would probably be effective.

growth occurred after exposure to 55° in one experiment (January 15), while in another (November 30) colonies of the typhoid bacillus grew out after exposure to this temperature. In this case the thermal death-point is placed at 56°, no growth having occurred after exposure to this temperature. Similar differences, when the temperature approaches that which is uniformly successful in destroying vitality, may be observed with reference to several of the organisms tested. But these differences are within comparatively narrow limits. They are probably due partly to a difference in resisting power depending upon the age of the culture, and partly to unavoidable variations in the temperature during the experiments. By very careful supervision and frequent stirring of the water-bath, variations in the temperature have been kept within narrow limits, but it has been impossible to avoid them entirely. The same thermometer has been used throughout. (Made by Schlag and Berend, Berlin.)

No attempt has been made to fix the thermal death-point within narrower limits than 2° C., and in the above table the lowest temperature is given which has been found, in the experiments made, to destroy all of the organisms in the material subjected to the test. No doubt more extended experiments would result, in some instances, in a reduction of the temperature given as the thermal death-point for a degree or more. But the results as stated are sufficiently accurate for all practical purposes, and permit us to draw some general conclusions:

(a) The temperature required to destroy the vitality of pathogenic organisms varies for different organisms.

(b) In the absence of spores, the limits of variation are about 10° C. (18° F.).

(c) A temperature of 56° C. (132.8° F.) is fatal to the bacillus of anthrax, the bacillus of typhoid fever, the bacillus of glanders, the spirillum of Asiatic cholera, the erysipelas coccus, to the virus of vaccinia, of rinderpest, of sheep-pox, and probably of several other infectious diseases.

(d) A temperature of 62° C. (143.6° F.) is fatal to all of the pathogenic and non-pathogenic organisms tested, in the absence of spores (with the single exception of *sarcina lutea*, which, in one experiment, grew after exposure to this temperature).

(e) A temperature of 100° C. (212° F.) maintained for five minutes destroys the spores of all pathogenic organisms tested.

(f) It is probable that some of the bacilli which are destroyed by a temperature of 60° C. form endogenous spores which are also destroyed at this temperature.<sup>1</sup>

There are micro-organisms of the same class as those included in the above list, which have a far greater resisting power to heat than those which I have tested. Some are even able to develop in culture media kept at a temperature of from 60° to 70° C., and the spores of certain bacilli resist a temperature considerably above that of boiling water; but, in my opinion, it would be exacting too much to require, in our

<sup>1</sup> This question demands further experimental investigation.

practical attempts at disinfection, a temperature capable of destroying the most resistant of these spores, which are found in the earth, and, so far as we know, are in no way concerned with disease processes.

Miquel, in 1881, described a motionless bacillus, found in the waters of the Seine, which grew luxuriantly in *bouillon* at a temperature of from 69° to 70° C. Van Tieghem has also reported the fact that he has cultivated several different species of bacteria at a temperature of from 60° to 70° C. Quite recently, Globig, in a paper published in the *Zeitschrift für Hygiene*, reports that he has been able to cultivate at a temperature of from 50° to 70° C. several different species of bacteria, which are found in the superficial strata of the earth. The same author,<sup>1</sup> in a series of experiments upon the resisting power of spores obtained from this source, found certain ones which resisted a remarkably high temperature. He states that the spores of one species, which he designates the red potato-bacillus, were not killed by exposure for ninety minutes to a solution of 1 to 100 of corrosive sublimate, or by fourteen days' immersion in a five per cent. solution of carbolic acid. From five and a half to six hours was required to destroy these spores in a current of steam at 100°. They survived after exposure for three fourths of an hour in steam under pressure at a temperature of from 109° to 113° C. They were, however, destroyed in twenty-five minutes by exposure in steam at from 113° to 116°, in two minutes at 127°, and instantly at 130° C.

## SECTION II.—CHLORIDE OF LIME.

The comparative cheapness of chlorinated lime, and its efficiency as a disinfectant, as shown by extended experiments made under the writer's direction in 1885, induced the Committee on Disinfectants to give to this agent the first place among chemical disinfectants.

In the "Conclusions" given in the report of this committee for 1885, a four per cent. solution is recommended for the destruction of "spore-containing infectious material," and for excreta. In a foot note, the standard of strength in available chlorine is fixed at "at least twenty-five per cent."

In the same report (Reports and Papers, A. P. H. A., vol. xi, p. 202) the writer calls attention to the fact that an oxidizing disinfectant is itself destroyed in the reaction to which its disinfecting power is due, and that therefore it is necessary to use such disinfecting agents "in excess of the organic material to be destroyed, otherwise germs included in masses of material not acted upon would be left intact in a fluid which is no longer of any value for their destruction; and as a few germs may be as potent for mischief as a large number, there would be a complete failure to accomplish the object in view."

Keeping this fact in view, and guided by the experimental data given on pages 199-201 of the report referred to, and by the writer's experiments upon normal feces (p. 269), the committee recommended (p. 278)

<sup>1</sup> *Zeitschrift für Hygiene*, Bd. iii, Heft. 2, p. 322.

the use of one quart of a standard solution of chloride of lime containing four ounces to the gallon for the disinfection of each discharge in typhoid fever, cholera, etc.

In summing up the results obtained in his experiments for the Committee on Disinfectants, Dr. Duggan says,—

The foregoing experiments show that a solution containing .25 of 1 per cent. (1 part to 400) of chlorine, as hypochlorite, is an effective germicide, even when allowed to act only one or two minutes, while .06 of 1 per cent. (6 parts to 10,000) will kill spores of *B. anthracis* and *B. subtilis* in two hours. A simple calculation will show that all the solutions used were effective when diluted to about this strength, and failed a little below it. No better evidence could be had of the excellent method of Dr. Sternberg for testing agents of this kind. These experiments were all made in duplicate, and they showed a concordance which I am satisfied can be obtained by no other method with which I am acquainted.

Notwithstanding the very satisfactory nature of the experimental evidence above referred to; I have thought best, in view of the great importance of the subject, to have additional experiments made by an independent investigator and by a different method. This seemed the more desirable, as some foreign experimenters have reached results which seem not to be in accord with those above referred to. As, however, the amount of available chlorine in the samples of chloride of lime which these investigators have employed in their experiments has in no case been stated, it is impossible to compare their results with our own, or to attach any great scientific value to them.

In Koch's experiments, published in the first volume of the *Mittheilungen aus dem Kaiserlichen Gesundheitsamte*, the statement is made that a five per cent. solution of chloride of lime (value in available chlorine not given) failed in two days to destroy the vitality of anthrax spores, but was effective in five days.

Van Ermengem, in his work entitled "*Le Microbe du Choléra Asiatique* (1885), says,—

Dry chloride of lime, the mixtures of the hypochlorites known under the name of Labarraque's solution, Javelle water, and the sulphate of iron enjoy a reputation which is not sustained by laboratory experiments. A few tests have convinced me that these substances have only a doubtful efficacy for disinfecting the excreta of cholera patients.

*Experiment XXV.* I have added a notable quantity of a commercial product known under the name of liquid chloride of lime (hypochlorite of soda) to a culture *bouillon*, before obtaining a complete sterilization of this liquid. Mixtures in the proportion of 1:30 have been required to give sterile products.

Dry chloride of lime is scarcely more active when one adds it to a culture in *bouillon*.

Seitz, in an extended series of experiments upon the bacillus of typhoid fever<sup>1</sup> reports a few experiments with this agent. A five per cent. solution was found to destroy vitality in five minutes (p. 39) when a pure culture was used, but a solution of the same strength failed after three days to disinfect typhoid stools. Unfortunately, this author also fails to state the amount of available chlorine present in his solution.

Chloride of lime must be kept in air-tight receptacles, or it soon loses

<sup>1</sup> "Bakteriologischen Studien zur Typhus—Aetiologie." Munchen, 1886.



its value for disinfecting purposes. But, when properly packed, it keeps perfectly well, and as offered for sale in this country I have usually found it to exceed the standard of strength fixed by the Committee on Disinfectants—25 per cent. A sample bought a few days since at the nearest drug store was found to contain 34.5 per cent. of available chlorine. It was contained in a pasteboard box, lined with rosin (Rozengrantz patent), and bore the label of C. F. Risley & Co., New York. The package contained four ounces, and cost five cents.

Dr. Bolton's experiments have been made with chloride of lime put up for the medical department of the army in twenty-pound jars, which bear the label of Trubner, Whyland & Co., New York.

TABLE NO. XIX.

CHLORIDE OF LIME. RECENT CULTURES IN BOUILLON.<sup>1</sup>

Organism.	Date.	Amount of Chloride of Lime.	
Bacillus of typhoid fever.	Nov. 11.	1 : 100, 1 : 200, <b>Cont.</b>	The amount of available chlorine in a solution of 1 : 2000 is 0.015 per cent.
	Nov. 22.	<b>1 : 5,000, 1 : 10,000, Cont.</b>	
	Nov. 23.	1 : 2,000, <b>1 : 5,000, Cont.</b>	
	Jan. 25.	1 : 500, 1 : 1,000, 1 : 2,000.	
Spirillum of Asiatic Cholera.	1887. Jan. 4.	1 : 50, 1 : 100, 1 : 200, <b>Cont.</b>	Colonies in control numberless.
	Jan. 18.	<b>1 : 2,000, 1 : 5,000, Cont.</b>	
	Jan. 25.	1 : 500, 1 : 1,000, 1 : 2,000, <b>Cont.</b>	
Friedlander's bacillus, so-called pneumococcus.	1886. Dec. 14.	<b>1 : 1,000, 1 : 2,000, 1 : 5,000, Cont.</b>	
	1887. Feb. 2.	<b>1 : 1,000, 1 : 2,000, 1 : 5,000, Cont.</b>	Available chlorine 30 per cent.
Bacillus of mouse septicæmia.	March 10.	<b>1 : 50, 1 : 100, Cont.</b>	Available chlorine 23.75 per cent.
Bacillus of foul brood with spores.	March 10.	1 : 50, 1 : 100, <b>Cont.</b> 1 : 50, 1 : 100.	Available chlorine 23.75 per cent.
Anthrax bacillus, with spores.	1886. Dec. 12.	1 : 50, 1 : 100, <b>Cont.</b>	Available chlorine 30 per cent.
	Dec. 14.	1 : 100, <b>1 : 200, 1 : 500, Cont.</b>	Available chlorine 30 per cent.
	March 10.	1 : 50, 1 : 100, <b>Cont.</b> 1 : 50, 1 : 100.	Available chlorine 23.75 per cent.
Wurzel bacillus, with spores.	March 11.	1 : 50, <b>1 : 100, Cont.</b> 1 : 50, 1 : 100.	Available chlorine 23.75 per cent.

<sup>1</sup> The *bouillon* used in all of Dr. Bolton's experiments was prepared exactly as for Koch's flesh-peptone-gelatine—without the gelatine.

TABLE NO. XX.

CHLORIDE OF LIME (AVAILABLE CHLORINE 30 PER CENT.). RECENT CULTURES IN FLESH-PEPTONE-GELATINE, CONTAINING 10 PER CENT. OF GELATINE.

Organism.	Date.	Amount of Chloride of Lime.	Remarks.
Bacillus of typhoid fever.	1886. Dec. 29.	1:50, 1:100, 1:200.	There is a discrepancy in the results obtained in experiments of January 13, and in those of January 8 and January 19.
	1887. Jan. 8.	1:100, 1:200, 1:500, <b>Cont.</b>	
	Jan. 13.	<b>1:500, 1:1,000 Cont.</b>	
	Jan. 19. 1886.	1:200, 1:500, 1:1,000, <b>Cont.</b>	
Anthrax bacillus.	Dec. 15.	1:50, 1:100, 1:200, 1:500, 1:1,000, <b>Cont.</b>	
Friedlander's bacillus.	Dec. 15.	1:50, 1:100, <b>1:200</b> , 1:500, <b>Cont.</b>	
Staphylococcus pyog. aureus.	Dec. 30.	1:50, 1:100, 1:200, <b>Cont.</b>	
Staphylococcus pyog. citreus.	Dec. 30.	1:50, <b>1:100, 1:200</b> , <b>Cont.</b>	
Staphylococcus pyog. albus.	Dec. 30.	1:50, 1:100, 1:200, <b>Cont.</b>	

TABLE NO. XXI.

CHLORIDE OF LIME (AVAILABLE CHLORINE 30 PER CENT.). CULTURES IN *bouillon* WITH 10 per cent. of egg albumen ADDED.

Organism.	Date.	Amount of Chloride of Lime.	Remarks.
Bacillus of typhoid fever.	Dec. 29, 1886.	1:50, 1:100, 1:200, 1:500, <b>Cont.</b>	
	Jan. 6, 1887.	<b>1:1,000, 1:2,000, 1:5,000, Cont.</b>	
	April 6.	1:50, 1:50, 1:100, 1:100, 1:200, <b>1:200, Cont.</b>	

TABLE NO. XXII.

CHLORIDE OF LIME (AVAILABLE CHLORINE 28.5 PER CENT.).

Material Disinfected.	Date.	Amount of Chloride of Lime.	Remarks.
Typhoid feces (liquid) from a patient in the third week of the disease.	Nov., 1886.	1:100, 1:200, <b>Cont.</b>	<sup>1</sup> 20 colonies in Es-march tube containing 1:100, none in 1:200. <sup>2</sup> Five colonies. <sup>3</sup> Eight colonies. <sup>4</sup> Countless colonies in control.
	Nov.	<b>1:100,<sup>1</sup> 1:200, Cont.</b>	
	Nov. 11.	1:50, <b>1:100,<sup>2</sup> 1:200.<sup>3</sup></b> <b>1:700,<sup>4</sup> Cont.</b>	

In the above experiments on typhoid feces, as in all other experiments reported, the amount of material to be disinfected has been made equal to the amount of the solution of the disinfecting agent (5 cc. of each), and the time of exposure has been uniformly two hours. The small number of colonies which developed after the use of a solution of 1 : 100 and 1 : 200 was probably due to the survival of the spores of some common bacillus present in the feces.

In the experiment made Nov. 11th, it was noted that when a solution containing 2 per cent. of chloride of lime was used, the presence of a surplus of available chlorine was shown at the end of two hours by the usual test;<sup>1</sup> when a solution of 1 per cent. was used, there was a slight trace of chlorine at the end of two hours; when the proportion was reduced to 0.5 per cent., there was no trace of chlorine left. The writer made the following experiment on Dec. 4, 1886, by the method used in the experiments made in 1885. At the same time, Dr. Bolton made a similar experiment with Esmarch tubes.

TABLE NO. XXIII.

BROKEN DOWN BEEF INFUSION, OLD STOCK, AND CHLORIDE OF LIME  
(AVAILABLE CHLORINE 30 PER CENT.).

	Amount of Disinfectant.
Dr. Sternberg's culture tubes.	1 : 50, 1 : 100, 1 : 200, 1 : 50, 1 : 100, 1 : 200.
Esmarch tubes. . . . .	1 : 50, 1 : 100, 1 : 200, Cont.

The experimental data herein recorded, and the comparative cheapness of this agent, fully justify the recommendations made by the committee in their previous report. But the writer would suggest that *Standard Solution No. 1* be made by adding six ounces of chloride of lime to the gallon of water (about 4 per cent.) instead of four ounces, as heretofore recommended. This would be 40 grams to the litre.

### SECTION III.—MERCURIC CHLORIDE.

In the article on mercuric chloride in the report of the Committee on Disinfectants for 1885, the writer arrives at the following conclusion :

Mercuric chloride, in aqueous solution, in the proportion of 1 : 10,000, is a reliable agent for the destruction of micrococci and bacilli in active growth, not containing spores; and in the proportion of 1 : 1,000 it destroys the spores of bacilli, provided that the microorganisms to be destroyed are fairly exposed to its action for a sufficient length of time.

Evidently, if the organisms to be destroyed are enveloped in masses of material which cannot be penetrated by the disinfecting agent, or if the material to be disinfected contains some substance which neutralizes the action of the disinfectant, the object in view will not be attained. With

<sup>1</sup> See Report of Committee on Disinfectants for 1885, on p. 15 of this vol.

a view to determining whether such practical difficulties were to be encountered in the use of this agent for disinfecting excreta, the writer made the experiments upon the sterilization of normal feces reported on page 271 of the report of the Committee on Disinfectants.

Van Ermengem gives evidence as to the potency of this agent in the destruction of pathogenic organisms in *bouillon*, but asserts that in the presence of albumen a very much larger proportion of the mercurial salt is required to insure destruction. Thus, when cultures of the cholera spirillum in chicken *bouillon* were exposed for half an hour to the action of this salt in the proportion of 1 : 60,000, the vitality of the spirillum was destroyed; but in cultures of the same organism in blood-serum from 1 : 800 to 1 : 1000 was required to destroy all the bacilli in the same time (op. cit., p. 244).

This author considers carbolic acid preferable to mercuric chloride for the disinfection of cholera excreta, and in this opinion he is sustained by Koch, upon whose recommendation it was given the first place in the directions for disinfection adopted by the International Sanitary Conference of Rome (1885). The writer, who was associated with Dr. Koch on the Committee on Disinfectants of the Conference, urged the claims of chloride of lime, which was placed beside carbolic acid with the following directions :

Carbolic acid and chloride of lime are to be used in aqueous solution :

*Weak solutions*—Carbolic acid, 2 per cent.; chloride of lime, 1 per cent.

*Strong solutions*—Carbolic acid, 5 per cent.; chloride of lime, 4 per cent.

There was considerable difference of opinion among the members of the Committee on Disinfectants of the International Sanitary Conference, with reference to the practical value of mercuric chloride for disinfecting excreta, and some hesitation in recommending it for general use on account of the poisonous nature of the salt. For these reasons, and because the two agents named seemed sufficient, no mention was made of mercuric chloride in the recommendations of this committee, which were adopted unanimously by the Conference. Van Ermengem, in discussing the comparative value of mercuric chloride and carbolic acid, says,—“For sublimate it will be necessary to employ a solution containing at least 2 : 1000.”

This is exactly the proportion in which the Committee on Disinfectants directed its use for the disinfection of excreta; and in both of the standard solutions recommended, provision is made against accident by adding other salts which give a distinct color to the solution and at the same time add to its efficiency. (See Report for 1885.)

The author quoted says further,—“Practically, sublimate is then not the powerful antiseptic, the germicide *par excellence*, that it is generally believed to be. We should remark, also, that being easily decomposed, it may contract other chemical combinations which enfeeble its action. In dilute solution, for example, it will be rapidly decomposed by sulphurets, by alkalies, and even by organic material; the ammoniacal salts transform it into an inactive body. Now these conditions are found

united in a high degree in fecal matters. Carbolic acid, on the other hand, is scarcely modified by these matters, and does not enter into any inert combinations."

Dr. Bolton has made the following experiments with this agent :

TABLE NO. XXIV.

MERCURIC CHLORIDE IN AQUEOUS SOLUTION, WITH CULTURES IN BOUILLON.

Organism.	Date.	Amount of Disinfectant.
Cholera spirillum . . . .	Jan. 25, 1887.	1 : 5,000, 1 : 10,000, 1 : 20,000, Cont.
	Jan. 18, "	1 : 10,000, 1 : 20,000, 1 : 40,000, Cont.
Typhoid bacillus . . . .	Nov. 26, 1886.	1 : 10,000, 1 : 20,000, 1 : 40,000, Cont.
Bacillus of mouse septicæmia	Feb. 2, 1887.	1 : 5,000, 1 : 10,000, 1 : 20,000, Cont.

TABLE NO. XXV.

MERCURIC CHLORIDE IN AQUEOUS SOLUTION, WITH AN EQUAL QUANTITY OF A RECENT CULTURE IN *flesh-peptone-gelatine* CONTAINING 10 PER CENT. OF GELATINE.

Organism.	Date.	Amount of Disinfectant.
Bacillus of typhoid fever, .	Jan. 8.	1 : 2,000, 1 : 5,000, 1 : 10,000, Cont.
	Jan. 13.	1 : 10,000, 1 : 20,000, Cont.
	Jan. 19.	1 : 5,000, 1 : 10,000, 1 : 20,000, Cont.

TABLE NO. XXVI.

MERCURIC CHLORIDE IN AQUEOUS SOLUTION, WITH AN EQUAL QUANTITY OF A CULTURE IN BOUILLON, TO WHICH 10 per cent. of *egg albumen* HAD BEEN ADDED.

Organism.	Date.	Experiments.
Bacillus of typhoid fever . .	April 6, 1887.	1 : 50, 1 : 50, 1 : 100, 1 : 100, 1 : 200, 1 : 200, <sup>1</sup> Cont.

The results of this experiment are in accord with those of Van Ermen- gem, and make it evident that for the disinfection of highly albuminous material the amount of mercuric chloride required will exceed that present in the standard solutions (1 : 500) heretofore recommended by the

<sup>1</sup>A single colony.

Committee on Disinfectants for sterilizing excreta. But the liquid discharges of typhoid fever and cholera patients probably do not contain anything like this proportion of albuminous material, and there is good reason to believe that they would be effectually disinfected by the use of standard solution No. II, or of standard solution No. III as recommended in the report for 1885.

We would, however, give the preference to the chloride of lime solution for the disinfection of excreta not only on account of the neutralizing action of albuminous materials, but for the reasons given in the report referred to, viz., "The only advantage which this solution has over the chloride of lime solution consists in the fact that it is odorless, while the odor of chlorine in the sick-room is considered by some persons objectionable. The cost is a little more. It must be remembered that this solution is highly poisonous. It is proper, also, to call attention to the fact that it will injure lead pipes if passed through them in considerable quantities" (op. cit., p. 132).

It has been recently shown that the neutralizing effect of albuminous material is considerably diminished by the addition of an acid to the disinfecting solution of mercuric chloride. Dr. Ernest Laplace, of New Orleans, under the direction of Prof. Robert Koch, has made an interesting series of experiments in the Hygienic Institute in Berlin<sup>1</sup>, as a result of which he especially recommends tartaric acid for this purpose. We quote from his experiments as follows:

"Six test tubes, each of which contained 5 c c m. of sublimate solution received the addition of putrefying human blood and pus bacteria in the proportion of  $\frac{1}{8}$ ,  $\frac{1}{4}$ ,  $\frac{1}{2}$ , 1, 2, and 3 c c m. A considerable deposit occurred in all of the tubes, especially in that containing 1 c c m. To six other tubes, in which each 5 c c m. contained 1 : 1000 sublimate solution, and 5 : 1000 tartaric acid solution was added the same amounts of putrefying blood and pus organisms. No precipitate formed in any of these tubes. At the end of twenty minutes 5 *Platinösen* from each tube in the two series were transferred to gelatine in test tubes which were treated by Esmarch's method. At the end of five days numerous colonies of staphylococcus pyogenus aureus and of the bacillus of green pus had developed in all of the tubes which contained the sublimate alone. On the contrary five of the tubes containing tartaric acid also remained sterile; in the sixth three colonies of the bacillus pyocyaneus had developed.

#### SECTION IV.—CARBOLIC ACID.

Very numerous experiments have been made to determine the exact germicide value of carbolic acid, and in 1885 this seemed to the Committee on Disinfectants to be so definitely established that no additional experimental data were necessary in order that an opinion might be formed as to its utility.

<sup>1</sup> Saure Sublimat-Lösung als desinficirendes Mittel und ihre Verwendung in Verband stoffen. Deutsche Medicinische Wochenschrift No. 40, Oct. 6, 1887.

The principal object in view in making the experiments recorded below has been to determine whether there is a considerable range of resisting power to the same agent among pathogenic organisms, or whether the resisting power of all organisms of this class, in the absence of spores, is included within comparatively narrow limits. The latter supposition seems *a priori* to be the most probable, and it will be seen that it is sustained by the experimental evidence. If it had turned out that certain organisms have a special resisting power for certain chemical agents, and that they have an exceptional susceptibility to the action of others, we would not be able to make any generalizations from the experimental evidence on record, but would have to test each disinfecting agent with reference to its destructive action on every known pathogenic organism before the data would be at hand to guide us in the practical use of disinfectants under all circumstances.

In the case of the oxidizing disinfectants, such as chloride of lime and permanganate of potash, there can be no question of this kind, as these agents act by attacking and decomposing organic matter, whether living or dead, whether in the form of organized cells or devitalized protoplasmic material. In the case of agents which have a toxic action on the living cells, but which, so far as can be recognized, do not destroy their structure, it is not so safe to infer that the toxic action manifested as regards one or more organisms of a class is general for the whole class. Having this question in view, I selected carbolic acid and sulphate of copper as two agents, of very different chemical composition, which seemed suitable for the experimental determination of the point.

Dr. Bolton, at my request, has made the following experiments :

TABLE NO. XXVII.

## CARBOLIC ACID. FRESH CULTURES IN BOUILLON.

Organism.	Date.	Amount of Disinfectant.	Remarks.
Cholera spirillum	1887. Jan. 4.	1 : 50, 1 : 100, 1 : 200, Cont.	
	Jan. 18.	1 : 200, 1 : 500, 1 : 1,000, Cont.	
	Jan. 25.	1 : 100, 1 : 200, 1 : 500, Cont.	
Bacillus of typhoid fever.	Jan. 25.	1 : 100, 1 : 200, 1 : 500, Cont.	
Emmerich's bacillus.	Feb. 23.	1 : 100, 1 : 200, 1 : 500, Cont. 1 : 100, 1 : 200, 1 : 500.	
Bacillus of Schweine-rothlauf	Feb. 26.	1 : 100, 1 : 200, <sup>1</sup> 1 : 500, <sup>2</sup> Cont. . 1 : 100, 1 : 200, 1 : 500.	<sup>1</sup> 30 colonies. <sup>2</sup> 60 colonies.
Brieger's bacillus.	Feb. 25.	1 : 100, 1 : 200, 1 : 500, Cont. 1 : 100, 1 : 200, 1 : 500, Cont.	
Bacillus pyocyanus (green pus).	Feb. 19.	1 : 100, 1 : 200, <sup>3</sup> 1 : 500, Cont. 1 : 100, 1 : 200, <sup>4</sup> 1 : 500.	<sup>3</sup> 720 colonies. <sup>4</sup> 125 colonies.

TABLE NO. XXVII—continued.

Organism.	Date.	Amount of Disinfectant.	Remarks.
Bacillus syncyanum.	March	1 : 50, 1 : 100, 1 : 200, <b>Cont.</b> 1 : 50, 1 : 100, 1 : 200.	
Friedlander's bacillus.	Feb. 11.	1 : 100, 1 : 200, 1 : 500 <b>Cont.</b>	
Bacillus of mouse septicæmia.	Feb. 2.	1 : 100, 1 : 200, 1 : 500, <b>Cont.</b>	
Staphylococcus pyogenes aureus.	Feb. 15.	1 : 100, 1 : 200, 1 : 500, <b>Cont.</b> 1 : 100, 1 : 200, 1 : 500.	
Staphylococcus pyogenes albus.	Feb. 8.	1 : 100, 1 : 200, <sup>5</sup> 1 : 500, <sup>6</sup> <b>Cont.</b> 1 : 100, 1 : 200, 1 : 500.	<sup>5</sup> 1,800 colonies. <sup>6</sup> Countless.
Staphylococcus pyogenes citreus.	Feb. 8.	1 : 100, 1 : 200, <sup>7</sup> 1 : 500, <sup>8</sup> <b>Cont.</b> 1 : 100, 1 : 200, 1 : 500.	<sup>7</sup> 300 colonies. <sup>8</sup> 480 colonies.
Streptococcus erysipelatos.	March 2.	1 : 100, 1 : 200, <sup>9</sup> 1 : 500, <sup>9</sup> <b>Cont.</b> 1 : 100, 1 : 200, 1 : 500.	<sup>9</sup> Very few.

The results obtained by Dr. Bolton accord with those reported by the writer in 1883,<sup>1</sup> as will be seen by the following table, taken from Table III in my paper, in which these results were originally published.

CARBOLIC ACID; CULTURES IN BOUILLON; TEST IN HERMETICALLY SEALED FLASKS.

Organism.	Amount of Disinfectant.
Micrococci from pus of an acute abscess . . .	1 : 100, 1 : 125, 1 : 200, 1 : 200.
M. Pasteuri . . . . .	1 : 200, 1 : 200, 1 : 400, 1 : 400.
Bacterium termo, without spores . . . . .	1 : 100, 1 : 200, 1 : 100, 1 : 200.

The following experiment was made to determine the influence of 10 per cent. of gelatine in the culture-medium containing organisms to be destroyed.

TABLE NO. XXVIII.

CARBOLIC ACID; RECENT CULTURE OF *typhoid bacillus* IN FLESH-PEPTONE-GELATINE.

Date.	Amount of Disinfectant.
January 8, 1887 . . . . .	1 : 100, 1 : 200, 1 : 500, <b>Cont.</b>
January 13, 1887, . . . . .	1 : 100, 1 : 200. <b>Cont.</b>
January 19, 1887 . . . . .	1 : 100, 1 : 200, 1 : 500, <b>Cont.</b>

<sup>1</sup>See paper in "American Journal of the Medical Sciences," April, 1883.



TABLE NO. XXIX.

IN THE FOLLOWING EXPERIMENT *ten per cent. of dried egg albumen* WAS ADDED TO THE CULTURE MEDIUM, *bouillon*.

Organism.	Date.	Experiments.
Bacillus of typhoid fever.	April 6, 1887.	1:25, 1:25, 1:50, 1:50, 1:100, 1:100, Cont.

We have here no evidence that the disinfecting action of carbolic acid is influenced by the presence of a large amount of albumen.

TABLE NO. XXX.

## CARBOLIC ACID—SPORES.

Organism.	Date.	Experiments.	Remarks.
Bacillus anthraxis.	March 7, 1887.	1:50, <sup>1</sup> 1:100, <sup>1</sup> 1:200, 1:50, 1:100, 1:200.	<sup>1</sup> 1 colony only.
Bacillus alvei (foul brood).	March 11.	1:50, 1:100, Cont. 1:50, 1:100.	
Wurtzel bacillus.	March 23.	1:50, 1:100, Cont. 1:50, 1:100.	

It will be seen that in the proportion of 2 per cent. there was a failure to destroy spores, except in the case of anthrax. I am not, however, disposed to attach much importance to this single experiment, and think it probable that spores were not present, or that for some reason their vital resistance was very much diminished, for previous experiments are in accord as to the considerable resisting power of spores to this agent. Thus Koch found (1881) that the developing power of anthrax spores immersed in a 5 per cent. solution, was only destroyed at the end of two days, while a 1 per cent. solution destroyed the bacilli, in the absence of spores, in two minutes. In the writer's experiments (1883) a 4 per cent. solution failed to destroy the spores of bacilli present in broken-down beef-tea (old stock).

By reference to Table No. XXVIII, it will be seen that the germicide power of this agent is identical for a considerable number of the test-organisms, and that as a rule 1 per cent. is effective and 0.5 per cent. fails. In a single experiment upon the bacillus of mouse septicæmia 1 per cent. failed, and in the case of Emmerich's bacillus, *B. syncyanum*, and Friedlander's bacillus, 0.5 per cent. (1:200) was effective. This would indicate a certain difference in the resisting power of various organisms, but in a more extended series of experiments it is possible that this apparent difference would be eliminated, for 1:200 is near the line of germicide potency, and variations are likely to occur on both

sides of this line from various causes, *e. g.*, differences in age of cultures, slight differences in mixing the culture with disinfecting agent, etc. Thus we have in the three experiments upon the cholera spirillum in the proportion of 1 : 200 development in two, and no development in one. The presence of 10 per cent. of gelatine, or of ten per cent. of egg-albumen, in the material to be disinfected, has no marked influence upon the germicide power of this agent, and gives it therefore a decided advantage over mercuric chloride or sulphate of copper for the disinfection of albuminous material.

Recent experiments by Laplace<sup>1</sup> show that the addition of hydrochloric acid to a disinfecting solution containing carbolic acid greatly increases its disinfecting power for spores. Thus, it is stated that "2 per cent. of crude carbolic acid with 1 per cent. of pure hydrochloric acid destroyed anthrax spores in seven days, while 2 per cent. of carbolic acid, or 1 per cent. of hydrochloric acid alone, did not destroy these spores in thirty days. A 4 per cent. solution of crude carbolic acid, with 2 per cent. of hydrochloric acid, destroyed spores in less than one hour; 4 per cent. of carbolic acid solution alone did not destroy them in twelve days."

Finally, we may say that the experiments herein recorded justify the recommendations of the Committee on Disinfectants, for the use of this agent, in their report of 1885, *viz.*, a 2 to 5 per cent. solution "for the destruction of infectious material which owes its infecting power to the presence of micro-organisms *not containing spores.*"

Various compounds containing carbolic acid have from time to time been recommended as a substitute for the pure phenol. So far as experiments have been made, none of these possess any special advantage as germicides, and as a rule it may be said that the compounds are less potent than the pure acid. Thus Koch found that a 5 per cent. solution of zinc sulpho-carbolate required five days to destroy the developing power of anthrax spores; a 5 per cent. solution of sodium phenate failed to entirely destroy the growing power of the same spores in ten days, and the same was true of a like solution of sodium sulpho-carbolate. Recently it has been proposed by a Russian physician to combine chloride of lime and phenol for disinfecting purposes. The statement has been made<sup>1</sup> that trichlorphenol is twenty-five times more powerful than carbolic acid.<sup>2</sup> This is to be prepared extemporaneously by mixing one part of a  $\frac{1}{4}$  per cent. solution of carbolic acid with five parts of a saturated solution of chlorinated lime. The formula for trichlorphenol is  $C_6H_2Cl_3(OH)$ .<sup>3</sup>

At my request Dr. Bolton has made some experiments with this agent, prepared as above directed. He found that when freshly prepared the solution contained a considerable quantity of chlorine, either free in solution or as hypochlorite of lime (?). This was shown by the reaction with starch paper. In an experiment made with a freshly prepared

<sup>1</sup> Deutsche Med. Wochenschrift, Oct. 6, 1887, p. 867.

<sup>2</sup> The "Medical Record," New York, Nov. 20, 1886, p. 580.

<sup>3</sup> "Neues Handwörterbuch d. Chemie," von v. Fehling.

solution on the 25th of November the available chlorine was found to be 7 per cent., and naturally this solution showed a germicide power corresponding with this amount of chlorine. But after standing until the solution showed no further chlorine reaction, it failed to destroy the bacteria in broken-down beef tea in the proportion of 50 per cent., and anthrax spores grew after having been immersed in it, at full strength, for two hours.

A second solution, made according to the same formula, destroyed anthrax spores in the proportion of 6.25 per cent. when first made, at which time it had a strong chlorine reaction. I judge from these experiments that whatever germicide value this solution has depends upon the excess of chlorine it contains, and that the chlorine and phenol in combination as trichlorphenol are practically neutralized so far as their germicide power is concerned.

Dr. E. v. Esmarch, assistant in the Hygienic Institute in Berlin, has made an extended research upon a product of coal tar distillation called *creolin*. This is described as a syrupy dark brown fluid, which smells like tar, and forms a milky emulsion with water. This is perhaps the same material which was introduced in this country some years since under the name of "Little's Soluble Phenyle," and which was tested by the Committee on Disinfectants with favorable results.<sup>1</sup>

In a comparative test of the germicide power of creoline and of carbolic acid<sup>2</sup> the former agent had the advantage in the absence of spores. A  $\frac{1}{2}$  per cent. solution was fatal to the spirillum of Asiatic cholera in one minute, and a 1 : 1,000 solution in ten minutes, while the same solutions of carbolic acid failed. The typhoid bacillus was somewhat more resistant. A  $\frac{1}{2}$  per cent. solution failed after ten minutes' exposure, but sterilization was effected in four days. With the staphylococcus pyogenus aureus as a test organism, 1 per cent. failed after forty-eight hours' exposure, but was effective in four days. These experiments of Esmarch show a decided difference in the resisting power of the test organisms to the agents named, and are not in accord with those of Bolton in this respect.

In an experiment upon anthrax spores, Esmarch found that 5 per cent. of creolin failed at the end of twenty days to destroy vitality, while the same proportion of carbolic acid was effective after twenty days' exposure. These agents were also tested by Esmarch upon putrefying meat infusion, and other infusions containing decomposing organic material, excrement, etc. In this experiment the carbolic acid came out ahead. A solution of  $\frac{1}{2}$  per cent. was effective in nine to thirteen days, while creolin in the same proportion failed to sterilize such material in fifty-two days. The general result of these experiments is stated as follows :

"Creolin is decidedly more active for pure-cultures of micro-organisms in the absence of spores; but, on the other hand, carbol is more potent for masses of putrefying material," and retains its disinfecting

<sup>1</sup> See report on "Commercial Disinfectants," Vol. XI, p. 194.

<sup>2</sup> Centralblatt für Bacteriologie, Bd. III, Nos. 10 and 11 (1887).

power longer; it seems as if creolin in contact with putrid matter after some time undergoes changes which neutralize its disinfecting power.

The deodorizing power of creolin was found by Esmarch to be very remarkable. Putrid material, which gave off a very offensive odor, was deodorized almost instantly when shaken up with creolin in the proportion of 1 : 1,000. The addition of a like amount of carbol had no effect, and even 1 : 100 did not notably diminish the offensive odor. But when the material after the addition of these agents was allowed to stand for eight to ten days, a change occurred. In the flasks containing carbol in the proportion of  $\frac{1}{4}$  per cent., the putrid odor gradually disappeared and a faint odor of carbol was detected, while in the flasks containing creolin an odor was developed resembling that given off from an old cesspool. Two samples of "creolin powder" were also tested by Esmarch with results corresponding with those above given.

A consideration of the experimental data above given leads the writer to believe that carbolic acid possesses a decided advantage over mercuric chloride or over oxidizing disinfectants, for the disinfection of masses of material to be left *in situ*, *e. g.*, for human excreta in privy vaults. The fact that it is not decomposed or neutralized by putrefying material, and that it will exercise its antiseptic action throughout the mass, even if it does not destroy spores of pathogenic organisms present, gives it a decided advantage. The complete destruction of such masses of material by the use of oxidizing disinfectants, *e. g.*, chloride of lime, or complete sterilization by means of mercuric chloride, appears to be impracticable when we have large masses of material to deal with; and in this case treatment with a 5 per cent. solution of carbolic acid in such quantity as will ensure permeation of the entire mass would seem to be the safest practice.

The prompt deodorizing action of creolin and its decided germicide power make it a suitable agent for the disinfection of excreta in the sick-room, but we would still give the preference to our standard solution of chloride of lime (containing six ounces to the gallon), as this quickly destroys all pathogenic organisms, including the most resistant spores.

#### SECTION V.—SULPHATE OF COPPER.

Dr. Bolton has made the following experiments with sulphate of copper, by the method heretofore described—equal parts of disinfecting solution and culture of test organism; two hours' exposure; test in Esmarch's tubes.

TABLE NO. XXXI.

## RECENT CULTURES IN BOUILLON.

Organism.	Date.	Experiments.
Bacillus of typhoid fever . . .	Jan. 25, 1887.	1 : 200, 1 : 500, 1 : 1,000, Cont.
Spirillum of Asiatic cholera	Jan. 18.	1 : 200, 1 : 500, 1 : 1,000, Cont.
	Jan. 25.	1 : 200, 1 : 500, 1 : 1,000, Cont.
Bacillus of mouse septicæmia.	Feb. 2.	1 : 100, 1 : 200, Cont.
Bacillus of Schweine-rothlauf	Feb. 26.	1 : 100, 1 : 200, 1 : 500, Cont.
Brieger's bacillus . . . . .	Feb. 25.	1 : 100, 1 : 200, 1 : 500 Cont. 1 : 100, 1 : 200, 1 : 500.
Bacillus pyocyanus . . . . .	Feb. 19.	1 : 100, 1 : 200, 1 : 500, Cont. 1 : 100, 1 : 200, 1 : 500, Cont.
Friedlander's bacillus . . . . .	Feb. 11.	1 : 100, 1 : 200, 1 : 500, Cont.
Emmerich's bacillus . . . . .	Feb. 23.	1 : 100, 1 : 200, 1 : 500, Cont. 1 : 100, 1 : 200, 1 : 500, Cont.
Bacillus sycyanum . . . . .	March 23.	1 : 100, 1 : 200, Cont. 1 : 100, 1 : 200.
Bacillus alvei . . . . .	Feb. 19.	1 : 100, 1 : 200, 1 : 500, Cont. 1 : 100, 1 : 200, 1 : 500.
Wurtzel bacillus . . . . .	Feb. 12.	1 : 100, 1 : 200, 1 : 500, Cont. 1 : 100, 1 : 200, 1 : 500.
Staphylococcus pyog. aureus	Feb. 8.	1 : 100, 1 : 200, <sup>1</sup> 1 : 500, <sup>2</sup> Cont. 1 : 100, 1 : 200, <sup>1</sup> 1 : 500. <sup>2</sup>
Staphylococcus pyog. citreus	Feb. 8.	1 : 100, 1 : 200, <sup>2</sup> 1 : 500, Cont. 1 : 100, 1 : 200, <sup>2</sup> 1 : 500.
Staphylococcus pyog. albus .	Feb. 15.	1 : 100, 1 : 200, 1 : 500, <sup>2</sup> Cont. 1 : 100, 1 : 200, 1 : 500.
Streptococcus erysipelatosus	Feb. 15.	1 : 100, 1 : 200, 1 : 500, Cont. 1 : 100, 1 : 200, 1 : 500.

TABLE NO. XXXII.

## RECENT CULTURES IN FLESH-PEPTONE-GELATINE, CONTAINING 10 PER CENT. GELATINE.

Organism.	Date.	Experiments.
Bacillus of typhoid fever . . .	January 8, 1887.	1 : 100, 1 : 200, 1 : 500, Cont.
	January 13.	1 : 100, 1 : 200, Cont.
	January 19.	1 : 100, 1 : 200, 1 : 500, Cont.

<sup>1</sup>One colony in each tube. <sup>2</sup>A few colonies.

TABLE NO. XXXIII.

RECENT CULTURES IN BOUILLON, WITH 10 PER CENT. OF EGG-ALBUMEN.

Organism.	Date.	Experiments.
Bacillus of typhoid fever . . .	April 6, 1887.	1 : 10, 1 : 10, 1 : 20, <b>Cont.</b>

These results correspond with those previously reported by the writer. Thus in 1881 I found that the virulence of septicæmic blood containing *M. Pasteuri* is destroyed by 1 : 400; and in the report of the Committee on Disinfectants for 1885 I say,—“I have demonstrated by recent experiments that it destroys micrococci in the proportion of .5 per cent. (= 1 : 200).” By reference to table No. XXXI it will be seen that there is some evidence of a difference in resisting power in different organisms, but, as remarked in the case of carbolic acid, it is probable that in a more extended series of experiments these differences would be to a great extent neutralized. Thus we find that in the single experiment upon the bacillus of mouse septicæmia 1 : 200 failed, while in that upon the bacillus of schweine-rothlauf 1 : 500 was successful. Yet these bacilli are thought by many bacteriologists to be identical. It may be that growth in the one case was due to the presence of spores, and failure in the other to their absence.

In the report of the Committee on Disinfectants for 1885 this agent is recommended in a solution of 2 to 5 per cent. for the destruction of infectious material “not containing spores.” The experimental data above given show that this is a very liberal allowance, and that the proportion might be reduced to 1 per cent. and still be within the limits of safety, where the conditions resemble those of our experiments. But in the presence of a considerable amount of albumen, this agent, like mercuric chloride, must be used in a much larger proportion to insure disinfection.

Dr. Bolton has made the following experiments upon spores :

TABLE NO. XXXIV.

SULPHATE OF COPPER—SPORES.

Organism.	Date.	Experiments.
Anthrax spores . . . . .	March 7.	1 : 50, 1 : 100, 1 : 200, <b>Cont.</b> 1 : 50, 1 : 100, 1 : 200, <b>Cont.</b>
Bacillus alvei spores . . . . .	March 3.	1 : 50, 1 : 100, 1 : 200, <b>Cont.</b> 1 : 50, 1 : 100, 1 : 200.
Wurtzel bacillus spores . . . . .	March 23.	1 : 50, 1 : 100, 1 : 200 <b>Cont.</b> 1 : 50, 1 : 100, 1 : 200.

I judge that there is some mistake about the experiment of March 7 with anthrax. Probably no spores were present in the culture. In my own experiments with this agent I found that even in the proportion of 20 per cent. it failed to kill the spores of anthrax; and as Dr. Bolton's experiment shows that 2 per cent. did not kill the spores of the Wurtzel bacillus or of bacillus alvei, I cannot believe that anthrax spores were killed by 1 : 200

## SECTION VI.—CALCIUM OXIDE.

Recently slacked lime and lime-wash have long enjoyed a reputation as disinfectants, and have been extensively used by sanitarians in their efforts to restrict the extension of infectious diseases. But until recently no exact experiments have been made to determine the precise germicide value of caustic lime. Koch, in 1881, found that lime-water only had a slight restraining influence upon the development of anthrax spores which had been immersed in it for 15 to 20 days. My own experiments upon spores have given results in accord with this. But, inasmuch as we have only in exceptional cases to deal with spores, in our practical measures of disinfection it is well worth while to carry the investigation further, and inquire what value this agent may have for the destruction of pathogenic organisms which do not produce spores. This has recently been done by Dr. Paul Liborius, a medical officer of the Russian navy, whose researches have been made in the *Hygienischen Institut* of Berlin.<sup>1</sup>

In a first series of experiments putrid bouillon was mixed with lime water in the proportion of 2 : 1, 1 : 1, 3 : 5, and 1 : 5. These mixtures were allowed to stand for three weeks, and tests were made at intervals to ascertain whether the micro-organisms present were still capable of development. The result is stated by Liborius as follows :

“Of the various micro-organisms in the putrid bouillon, by far the greater part were destroyed within twenty-four hours, when the proportion of lime at the commencement of the experiment was about 0.09 per cent. The few germs which resisted were restricted in their development, and only multiplied again after a considerable time, when probably the amount of lime in solution was to a considerable extent diminished.”

As the result of extended experiments upon the bacillus of typhoid fever and the spirillum of Asiatic cholera, Liborius arrives at the following conclusions :

1. An aqueous solution of calcium oxide of the strength of 0.0074 per cent. in the course of a few hours destroys the typhoid bacillus, and a solution of 0.0246 per cent. destroys cholera bacilli.

2. Bouillon cultures of the cholera bacillus, containing albuminous precipitate (unfiltered bouillon), which offer at least as unfavorable con-

<sup>1</sup> Einige Untersuchungen über die desinificierende Wirkung des Kalkes, Zeitschrift für Hygiene, Bd. II. 1887.

ditions, on account of their physical characters, as natural cholera dejections, are perfectly disinfected in the course of a few hours by a 0.4 per cent. solution of pure caustic lime, = to 2 per cent. of crude burnt lime in fragments.

3. The most energetic action of lime was obtained, under more difficult circumstances, when it was used in the form of pure pulverized caustic lime, or as a milk of lime containing 20 per cent. of the same.

Liborius calculates that 12 grammes of pure caustic lime would suffice to disinfect the alvine discharges during 24 hours in a case of cholera. He says that pure calcium oxide costs from 50 to 70 pfennings per kilogram, or by the quantity from 40 to 50 marks per 100 kilograms (about \$5 to \$6 per 100 pounds).

“If, upon further researches, it is found necessary to add a certain proportion of magnesium chloride to prevent the development of ammonia, one tenth of the amount of lime will suffice. As the purest magnesium chloride is no dearer than caustic lime, and as the price of crude burnt lime, at the factory, is only  $1\frac{1}{2}$  marks per hektolitre, the disinfection of the daily dejections of a cholera patient would cost something less than one pfenning” (=about  $\frac{1}{4}$  cent).

In order to test the conclusions reached by Liborius, I have made the following experiments with calcium oxide obtained from the chemical laboratory of the Johns Hopkins University, *which is quite free from chlorine* (manufactured by Dr. Theo. Schuchardt, of Görlitz, Germany). I have not attempted to determine by chemical tests the exact amount of calcium oxide present in my standard solution of lime water, but have prepared a saturated solution by adding the caustic lime in large excess to distilled water. According to the National Dispensary, *liquor calcis* contains 0.15 per cent. of hydrate of calcium. The same authority states that calcium oxide is soluble in 750 parts of water at 15° C.

TABLE NO. XXXV.

CULTURES IN FLESH-PEPTONE GELATINE, MIXED WITH AN EQUAL QUANTITY OF LIME WATER. TEST IN ESMARCH'S TUBES.

Organism.	Time of exposure.	Proportion of lime water.		
Typhoid bacillus . . .	Two hours.	50 per cent., 50 per cent., Cont.		
Bacillus of Schweine-rothlauf .		50,	50,	Cont.
Bacillus pyocyanus . . .		50,	50,	Cont.
Bacillus acidi lactici . . .		50,	50,	Cont.
Finkler-Prior spirillum . . .		50,	50,	Cont.
Cheese spirillum . . .		50,	50,	Cont.
Staphylococcus pyog. aureus .		50,	50,	Cont.
Staphylococcus pyog. citreus .		50,	50,	Cont.



TABLE NO. XXXV—*continued.*

Organism.	Time of exposure.	Proportion of lime water.		
Staphylococcus pyog. albus .	Forty-eight hours' exposure.	50,	50,	Cont.
Typhoid bacillus . . .		50,	50.	
Bacillus pyocyanus . . .		50,	50.	
Bacillus acidi lactici . . .		50,	50.	
Finkler-Prior spirillum . .		50,	50.	
Staphylococcus pyog. albus .		50,	50.	
Staphylococcus pyog. aureus .		50,	50.	

TABLE NO. XXXVI.

CULTURES IN BOUILLON, MIXED WITH A SATURATED SOLUTION OF CALCIUM OXIDE.

Organism.	Time of exposure.	Proportion of lime water.
Typhoid bacillus . . .	Two hours.	1 : 1, 1 : 1, 5 : 1. 5 : 1. <sup>1</sup>
Staphylococcus pyog. albus .		1 : 1, 1 : 1, 5 : 1, 5 : 1.
Typhoid bacillus . . .	Three hours.	1 : 1, 1 : 1.
Staphylococcus pyog. albus .		1 : 1, 1 : 1.

TABLE NO. XXXVII.

EXPERIMENTS WITH SPORES.

Spores of	Date.	Time of exposure.	Proportion of calcium oxide.	Result.
Anthrax bacillus.	April 19.	2 hours.	Saturated solution.	Not killed.
Wurtzel bacillus.	"	"	"	"
Bacillus subtilis.	"	"	"	"
Bacillus alvei.	"	"	"	"
Anthrax bacillus.	April 20.	24 hours.	"	"
Wurtzel bacillus.	"	"	"	"
Bacillus subtilis.	"	"	"	"
Bacillus alvei.	"	"	"	"

<sup>1</sup> Development retarded to fourth day.

TABLE NO. XXXVII—continued.

Spores of	Date.	Time of exposure.	Proportion of calcium oxide.	Result.
Anthrax bacillus.	April 21.	48 hours.	"	"
Wurtzel bacillus.	"	"	"	"
Bacillus subtilis.	"	"	"	"
Bacillus alvei.	"	"	"	"
Anthrax bacillus.	April 23.	2 hours.	20 per cent. of pure calcium oxide suspended in a saturated solution of the same.	"
Wurtzel bacillus.	"	"		"
Bacillus subtilis.	"	"		"
Bacillus alvei.	"	"		"

TABLE NO. XXXVIII.

CALCIUM OXIDE SUSPENDED IN A SATURATED SOLUTION OF THE SAME (LIME-WASH).

Organism.	Date.	Proportion of calcium oxide by weight.
Typhoid bacillus . . .	April 26, 1887.	1 : 40, 1 : 40.
	April 27.	1 : 80, 1 : 80, 1 : 160, 1 : 160.
Staphylococcus pyog. albus.	April 20.	1 : 40, 1 : 40, 1 : 80, 1 : 80, 1 : 160, 1 : 160.

The above experiments suffice to demonstrate the fact that pure calcium oxide has no great value for disinfecting purposes, and show that the proposition of Liborius to give it the preference over chloride of lime on account of its comparative cheapness is based upon a misconception of the *practical* value of the two agents for disinfecting purposes. Inasmuch, however, as calcium oxide has considerable germicide power when used in the form of lime-wash, especially after prolonged contact, the general use of lime-wash for sanitary purposes is to be recommended wherever it can be applied to surfaces which are supposed to be infected by disease germs.

The following experiments have been made to determine the antiseptic value of pure calcium oxide in a saturated aqueous solution :

In these experiments bouillon in the proportion indicated was added to lime water, in test tubes, and a drop of a culture containing the test organism was added to this mixture. The test tubes were then set aside, and the time noted when the bouillon became clouded by the multiplication of the organisms with which it had been inoculated.

Mixtures were made in the proportion of 12 of bouillon to 1 of lime water ; 8 : 1, 4 : 1, 2 : 1, and 1 : 1. Such mixtures inoculated with the cheese spirillum had all broken down in 24 hours. Inoculated with the typhoid bacillus, 12 : 1 became clouded in 24 hours, 8 : 1 in 48 hours, 4 : 1 in 72 hours, 2 : 1 in 5 days, 1 : 1 in 6 days. With staphylococcus pyogenes albus the result was the same. These experiments show that lime water mixed with an equal quantity of a culture solution exercises a considerable restraining influence upon the development of the typhoid bacillus and upon the micrococcus tested, but that in the end these organisms are able to multiply in a culture solution to which it has been added in this proportion. It is somewhat remarkable that the cheese spirillum was not, apparently, restrained in its development by the same proportion of lime water. The writer's sudden departure for Brazil, to investigate the methods of inoculation against yellow fever practised in that country by Dr. Domingos Freire, has brought these experiments to a more speedy termination than he had intended.

#### SECTION VII.—VARIOUS DISINFECTING AGENTS.

In the present section we give, for convenience of reference, an abstract of some of the more important recent researches made in the laboratories of Europe.

It must be remembered, in comparing the results reported by different experimenters, that they cannot be expected to correspond unless the conditions under which their experiments have been made were identical. A small amount of material may be sterilized by a given percentage of a certain chemical agent, when the same proportion would fail to sterilize a larger amount. Thus, if we add a drop of material containing any test-organism to a considerable quantity of a disinfecting solution of a given strength, it will be a very different matter from adding the same proportion of the disinfecting agent to a considerable quantity of material containing the same test-organism. A gramme of chloride of lime, or of carbolic acid, is efficient for the sterilization of a certain amount of material containing the typhoid bacillus or the cholera spirillum ; and the exact amount will depend both upon the number of germs to be destroyed and upon the character of the material with which they are associated. The quantity of water used in making a solution of the disinfecting agent will, within certain limits, be a matter of no consequence. Thus, one hundred parts of a one per cent. solution of a disinfectant is equal to ten parts of a ten per cent. solution of the same agent. If, therefore, the statement is made that this agent is effective in the proportion of 1 : 100, it is evident that we must know the conditions under which it is effective in order to guide us in our practical measures of disinfection, or to enable us to compare the results of different experimenters. The apparent discrepancies in the results reported below are for the most part due to the different conditions under which the experiments were made.

In the *Revue Scientifique* of Nov. 22, 1884, is a report by Nicati and Rietsch upon the vitality of the spirillum of Asiatic cholera.

In these experiments a small quantity of a culture of the spirillum was added to a considerable quantity of the disinfecting solution :

*Sulphurous acid.* A saturated aqueous solution, diluted with nine parts of water, destroyed the cholera spirillum in fifteen minutes.

*Sulphuric acid* (of 66 degrees Baumé), 1 : 400 was effective in forty minutes.

*Hydrochloric acid* (1 gr.=0.3697 Hcl.), 1 : 2,000 in five minutes.

*Acetic acid*, 1 : 500 in ten minutes.

*Tartaric acid*, 1 : 1,000 in one hour.

*Carbolic acid*, 1 : 200 in ten minutes.

*Salicylic acid* (saturated solution at 17° C.), 1 : 1,000 in ten minutes.

*Sulphate of zinc*, 1 : 333 in ten minutes.

*Chloride of zinc*, 1 : 1,000 in ten minutes.

*Sulphate of copper*, 1 : 3,000 in ten minutes.

*Mercuric chloride*, 1 : 300,000 in ten minutes.

*Desiccation.* Nicati and Rietsch say,—“ Our experiments verify one of the assertions of M. Koch, which has perhaps met with the greatest incredulity, that is, that the cholera infection is surely killed by desiccation.” Exposure for an hour and a quarter, upon the surface of a glass plate, was found to kill the spirillum. Van Ermengem<sup>1</sup> has also verified this fact, but has found that the time required to effect desiccation and the death of the spirillum depends largely upon the nature of the material containing it, and the humidity of the atmosphere.

When a layer of nutritive gelatine or of agar-agar, having a thickness of to 3 m. m. was exposed upon glass plates, in an occupied apartment in which the temperature was about 13° C., and the air tolerably dry, sterilization was not effected in less than two or three days. In a chamber in which the temperature ranged from 5 to 12° C., and which was quite humid, desiccation required a longer time ; but after exposure in this chamber for six days, the vitality of the spirilla was destroyed.

Van Ermengem has also made extended experiments upon the disinfecting power of various chemical agents, as tested by the cholera microbe (op. cit.). We give a summary of his results :

*Sulphur dioxide.* The atmosphere of a chamber was almost saturated with sulphurous vapors. In the corners and under the furniture I placed morsels of a woollen carpet, of fragments of a folded blanket, and of various stuffs rolled in bundles. In the interior of each of these packets was a morsel of blotting paper folded four times, and surrounded by a fragment of sterilized woollen cloth so as to protect the blotting paper, which had been soaked with a liquid culture of the cholera microbe, against all contamination. Even after remaining for twenty-four hours in the chamber, the paper was never completely sterilized.

*Mercuric chloride.* In Van Ermengem's experiments the mercuric chloride was mixed with *bouillon* and added to cultures of the cholera spirillum in the proportion of one volume to five. It was found to be effective in the proportion of 1 : 60,000, the time of exposure being half an hour. When one volume of the culture-liquid was added to one hun-

<sup>1</sup> *Le Microbe du Cholera Asiatique*, Paris and Brussels, 1885, p. 219.

dred volumes of the disinfecting solution, sterilization was effected by 1 : 100,000.

*Carbolic acid.* Solutions containing 1 : 600 to 1 : 700 were found to destroy the spirilla in concentrated chicken *bouillon* in less than half an hour; in blood serum, 1 : 400 was effective in the same time.

*Copper Sulphate.* Solutions of 1 : 600 were found to kill all of the spirilla in a culture in *bouillon* in less than half an hour. In the proportion of 1 : 1,000 the same culture-liquid was sterilized in from three to four hours; cultures in blood serum required 1 : 200.

*Chloride of zinc* (chemically pure) produced a complete sterilization in half an hour, in the proportion of 1 : 500.

*Zinc sulphate.* 1 : 300 failed to sterilize (a single experiment).

*Sulphuric acid,* 1 : 1,000 effective in half an hour.

*Hydrochloric acid,* 1 : 2,000 effective in half an hour.

*Acetic acid* (glacial), 1 : 300 in half an hour.

*Citric acid,* 1 : 200.

*Tartaric acid,* 1 : 200.

*Sulphate of iron,* 1 : 20 in half an hour, probably due to presence of free sulphuric acid in the commercial sulphate of iron. "In several experiments made with a saturated solution of sulphate of iron added to an equal quantity of a culture in fluid blood serum, sterilization was not effected."

*Salicylic acid,* 1 : 300.

*Boric acid,* 1 : 300.

*Thymol,* 1 : 400.

Ramon and Cajal<sup>1</sup> report that the cholera spirillum is destroyed by *hydrochloric acid* in the proportion of 1 : 500, by *sulphuric acid* in 1 : 200, by *carbolic acid* in 1 : 50, by *sulphate of copper* in 1 : 100.

Leitz,<sup>2</sup> in his studies relating to the bacillus of typhoid fever, reports the following results :

The dejections of the typhoid patients, mixed in equal quantity with the disinfecting solution, were sterilized by *carbolic acid* in five per cent. solution in three days; by *sulphuric acid*, in five per cent. solution, in three days.

Pure cultures of the typhoid bacillus, mixed with an equal quantity of the disinfecting solution, were sterilized by *sulphate of iron*, 1 : 20, in three days; *sulphate of zinc*, 1 : 20, in three days; *sulphuric acid* 1 : 50, in fifteen minutes, 1 : 20 in five minutes; *carbolic acid*, 1 : 20 in fifteen minutes, 1 : 10 in ten minutes; *sulphate of copper*, 1 : 20, in ten minutes; *chloride of lime* 1 : 20, in five minutes.

In *Virchow's Archiv* of March 2, 1887, is a paper by Guttman and Merke, of the City Hospital Moabit, in Berlin, relating to the disinfection of inhabited apartments. In making their experiments, the authors had in view the necessity of effectually destroying infectious disease germs with an agent which should not injure the house or furniture, or

<sup>1</sup> Abst. Rev. d. sci. med. t. xxviii, p. 532.

<sup>2</sup> Bakteriologische Studien zur typhus Aetiologie, München, 1886.

be dangerous to the health of the persons who apply it. The anthrax bacillus attached to silk threads (dried) was taken as a test-organism. The disinfecting solutions were applied directly to walls, ceilings, and floors, or, in the form of spray, to rags, etc. The conclusion is reached that a solution of mercuric chloride of 1 : 1,000, applied as a wash or spray, is the most reliable and the cheapest disinfecting agent for use in inhabited rooms. This corresponds with the recommendations of the Committee on Disinfectants made in their report of 1885.

## PTOMAINES.

By VICTOR C. VAUGHAN, PH. D., M. D.,

*Ann Arbor, Mich.*

A ptomaine is a chemical compound, which is basic in its character, and which is formed during the putrefaction of organic matter. The name was suggested by Selmi, and is derived from the Greek word  $\pi\tau\tilde{\omega}\mu\alpha$  (*cadaver*). On account of their basic properties, in which they resemble the vegetable alkaloids, ptomaines may be called putrefactive alkaloids. They have been called animal alkaloids, but this is a misnomer, because some ptomaines are formed by the putrefaction of vegetable matter, as will be shown further on. While some of the ptomaines are highly poisonous, this is not an essential property, for others are wholly inert. Indeed, the greater number of those which have been isolated up to the present time are not poisonous. On the other hand, all poisonous substances formed during putrefaction are not ptomaines. Thus, phenol, some of the amido-acids, and hydrogen sulphide are poisonous products of putrefaction, but are not ptomaines.

All ptomaines contain nitrogen, as an essential part of their basic character. In this, also, they resemble the vegetable alkaloids. Some of them contain oxygen, while others do not. The latter correspond to the volatile vegetable alkaloids, nicotine and conine, and the former correspond to the fixed alkaloids.

Since all putrefaction is due to the action of bacteria, it follows that all ptomaines result from the growth of these micro-organisms. The kind of ptomaine formed will depend upon the individual bacterium engaged in its production, the nature of the material being acted upon by the bacterium, and the conditions under which the putrefaction goes on, such as the temperature, the amount of oxygen present, the electrical conditions existing, and the duration of the process. Only the bacillus of typhoid fever (Eberth's bacillus), so far as is known, at least, can produce the ptomaine typhotoxine, and the special bacterium of tetanus seems to be necessary in order to produce tetanine, a ptomaine which, when injected under the skin of an animal, causes tetanic convulsions.

Brieger found that although the typhoid bacillus grew well in solutions of peptone, it did not produce any ptomaine; while from cultures of the same bacillus in beef tea he obtained a poisonous alkaloid. Fitz found that whilst the bacillus butyricus produces by its action on carbohydrates butyric acid, in glycerin it produces propylic alcohol. Brown has shown that while the mycoderma aceti converts ethylic alcohol into acetic acid, it converts propylic alcohol into propionic acid, and is without effect upon methylic alcohol, primary isobutylic alcohol, and amylic alcohol. Some bacteria will not multiply below a given temperature.

Thus, the bacillus butyricus will not grow at a temperature below 24° C. The lower temperature does not destroy the organism, but it lies dormant until the conditions are more favorable for its growth.

Pasteur divided the bacteria into two classes, the aerobic and the anaerobic. As the name implies, the former grow and thrive in the presence of air, while the latter find their conditions of life improved by the exclusion of air. Therefore different ptomaines will be formed in decomposing matter freely exposed to the air, and in that which is buried beneath the soil or from which the air is largely excluded. Even when the same ferment is present the products of the putrefaction will vary within certain limits, according to the extent to which the putrefying material is supplied with air. The kind of ptomaine found in a given putrid substance will depend also upon the stage of the putrefaction. Ptomaines are transition products in the process of putrefaction. They are temporary forms through which matter passes, while it is being transformed, by the activity of bacterial life, from the organic to the inorganic state. Complex organic substances, as muscle and brain, are broken up into less complex molecules; and so the process of chemical division goes on, until the simple and well known final products, carbonic acid gas, ammonia, and water, result. But the variety of combinations into which an individual atom of carbon may enter during this long series of changes is almost unlimited, and with each change in combination there is more or less change in nature. In one combination the atom of carbon may exist as a constituent of a highly poisonous substance, while the next combination into which it enters may be wholly inert.

It was formerly supposed that putrefaction was simply oxidation, but the researches of Pasteur and others have demonstrated the fact that countless myriads of minute organisms are engaged constantly in transforming matter from the organic to the inorganic form.

*Historical Sketch.* It must have been known to primitive man that the eating of putrid flesh was liable to affect the health more or less seriously; and when he began his endeavors to preserve his food for future use, instances of poisoning from putrefaction must have multiplied. However, the distinguished physiologist, Albert von Haller, seems to have been the first to make any scientific experiments concerning the effects of putrid matter upon animals. He injected aqueous extracts of putrid material into the veins of animals, and found that death resulted. Later, in the eighteenth century, Morand gave an account of the symptoms induced by eating some poisonous meat. In the early part of the present century (1808 to 1814), Gaspard carried on similar experiments. He used as material the putrid flesh of both carnivorous and herbivorous animals. With these he induced marked nervous disturbances, as stiffness of the limbs, opisthotonos, and tetanus. Gaspard concluded from the symptoms that the poisonous effects were not due to carbonic acid gas or hydrogen sulphide, but thought it possible that ammonia might have part in their production. In 1820 Kerner published his first essay on poisonous sausage, which was followed by a second in



1822. At first he thought that the poisonous properties were due to a fatty acid similar to the sebacic of Thénard, and which originated during putrefaction. Later, he modified these views, and believed the poison to be a compound consisting of the sebacic acid and a volatile principle. This may be regarded as the first suggestion as to the probability of the development of a poisonous substance with basic properties in decomposing matter. In 1822 Dupré observed a peculiar disease among the soldiers under his care, who, during the very warm and dry summer of that year, were compelled to drink very foul water. Later, Magendie, induced by the investigations of Gaspard and the observations of Dupré, made many experiments, in which dogs and other animals were confined over vessels containing putrid animal matter, and compelled constantly to breathe the emanations therefrom. The effects varied markedly with the species of animal and the nature of the putrid material, but in some instances symptoms were induced which resembled closely those of typhoid fever in man. Leurent directed his attention to the chemical changes produced in blood by putrefaction, but accomplished nothing of special value. Dupuy injected putrid material into the jugular vein of a horse, and with Trosseau studied alterations produced in the blood by these injections.

In 1850 Prof. Schmidt, of Dorpat, made some investigations on the decomposition products and volatile substances found in cholera stools; and two years later Meyer, of Berlin, injected the blood and stools of cholera patients into lower animals. In 1853 Stich made an important contribution on the effects of acute poisoning with putrid material. He ascertained that when given in sufficient quantity, putrid matter produced an intestinal catarrh with choleraic stools. Nervous symptoms, trembling, unsteady gait, and finally convulsions were also observed. Stich made careful post-mortem examinations, and was unable to find any characteristic or important lesion. Theoretically, he concluded that the putrid material contained a ferment which produced rapid decomposition of the blood.

In 1856 Prof. Panum published a most important contribution to the knowledge of the nature of the poison present in putrid flesh. He first demonstrated positively the chemical character of the poison, inasmuch as he showed that the aqueous extract of the putrid material retained its poisonous properties after treatment which would insure the destruction of all organisms. His conclusions were as follows:

(1) "The putrid poison, contained in the decomposed flesh of the dog, and which is obtained by extraction with distilled water and repeated filtration, is not volatile, but fixed. It does not pass over on distillation, but remains in the retort."

(2) "The putrid poison is not destroyed by boiling, nor by evaporation. It preserves its poisonous properties even after the boiling has been continued for eleven hours, and after the evaporation has been carried to complete desiccation at 100°."

(3) "The putrid poison is insoluble in absolute alcohol, but is soluble

in water, and is contained in the aqueous extract which is formed by treating with distilled water the putrid material, which has previously been dried by heat and washed with alcohol."

(4) "The albuminoid substances, which frequently are found in putrid fluids, are not in themselves poisonous only so far as they contain the putrid poison fixed and condensed upon their surfaces, from which it can be removed by repeated and careful washing."

(5) "The intensity of the putrid poison is comparable to that of the venom of serpents, of curaré, and of certain vegetable alkaloids, inasmuch as .012 gramme of the poison, obtained by extracting with distilled water putrid material, which had been previously boiled for a long time, dried at 100°, and submitted to the action of absolute alcohol, was sufficient to almost kill a small dog."

Panum made intravenous injections with this poison and with ammonium carbonate, ammonium butyrate, ammonium valerianate, tyrosin, and leucin, and found that the symptoms induced by the putrid poison differed from those caused by the other agents. Moreover, he found the symptoms to differ from those of typhoid fever, cholera, pyæmia, anthrax, and sausage poisoning. He was in doubt as to whether the poison acted directly upon the nervous system, or whether it acted as a ferment upon the blood, causing a decomposition, the products of which affected the nerve-centres; but he was sure that it could not correspond to the ordinary ferments, inasmuch as it was not decomposed by prolonged boiling, nor by treatment with absolute alcohol. Certainly the putrid poison could not consist of a living organism.

The symptoms observed by Panum varied greatly with the quantity of the poison used and the strength of the animal. After the intravenous injection of large doses, death followed in a very short time. In these cases there were violent cramps, and involuntary evacuations of the urine and fæces; the respirations were labored; the pallor was marked, sometimes followed by cyanosis; the pulse feeble; the pupils widely dilated, and the eyes projecting. In these cases the autopsy did not reveal any lesion, save that the blood was dark, imperfectly coagulated, and slightly infiltrated through the tissue. Post-mortem putrefaction came on with extraordinary rapidity.

When smaller doses or more vigorous animals were used, the symptoms did not appear before from a quarter of an hour to two hours, and sometimes even later. In these cases the symptoms were less violent, and the animal generally recovered. In all instances, however, the disturbances were more or less marked.

In addition to the "putrid poison," Panum obtained a narcotic substance, the two being separated by the solubility of the narcotic in alcohol. The alcoholic extract was evaporated to dryness, the residue dissolved in water, and inserted into the jugular vein of a dog. The animal fell into a deep sleep, which remained unbroken for twenty-four hours, when he awoke apparently in perfect health.

Weber in 1864, and Hemmer and Scheweninger in 1866, confirmed

the results obtained by Panum, and Schwenninger announced that in the various stages of putrefaction different products are formed, and that these vary in their effects upon animals. In 1866, Bence Jones, and Dupré obtained from the liver a substance which in solutions of dilute sulphuric acid gives the blue fluorescence observed in similar solutions of quinine. To this substance they gave the name "animal chinoidin." Subsequently, the same investigators found this substance in all organs and tissues of the body, but most abundantly in the nerves. Its feebly acid solutions give precipitates with iodine, potassio-mercuric iodide, phosphomolybdic acid, gold chloride, and platinum chloride. From three pounds of sheep's liver they obtained three grams of a solution, in which after slight acidulation with sulphuric acid the intensity of the fluorescence was about the same as that of a similarly acidulated solution of quinine sulphate, which contained 0.2 gram of quinine per liter. Still later, this base was observed by Marino-Zuco.

In 1868 Bergmann and Schmiedeberg separated, first from putrid yeast and subsequently from decomposed blood, in the form of a sulphate, a poisonous substance which they named sepsin. The sulphate of sepsin forms in needle-shaped crystals. Small doses (0.01 gram) of this substance were dissolved in water, and injected into the veins of two dogs. In a short time it produced vomiting, and later diarrhœa, which in one of the animals after a time became bloody. Post-mortem examination showed in the stomach and intestines bloody ecchymoses. It was now believed that the "putrid poison" had been isolated, and that it was identical with sepsin; but further investigations showed that this was not true. There are marked differences in their effects upon animals, and sepsin has not been found to be generally present in putrid material. It is only rarely found in blood, and the closest search has failed to show its presence in pus. Bergmann, following the same method which he had used in extracting this poison from yeast, has been unable to obtain it from other putrid material. Moreover, he has not always been successful in obtaining the poison from yeast. Sepsin was not obtained in quantity sufficient to serve for an ultimate analysis, hence its composition remains unknown.

In 1869, Zeuler and Sonnenschein prepared, from decomposed meat extracts, a nitrogenous base, which in its chemical reactions and physiological effects resembles atropia and hyoscyamia. When injected under the skin of animals, it produced dilatation of the pupils, paralysis of the muscles of the intestines, and acceleration of the heart-beats; but it is uncertain and inconstant in its action. This probably results from rapid decomposition taking place in it, or to variations in its composition at different stages of putrefaction. This substance has also been obtained from the bodies of those who have died from typhoid fever; and it may be possible that the belladonna-like delirium which frequently characterizes the later stages of this disease is due to the ante-mortem generation of this poison within the body.

Since 1870 many chemists have been engaged in making investigations

on the products of putrefaction. First of all stands the Italian, Selmi, who suggested the name "ptomaine," and whose researches furnished us with much information of value, and, what is probably of more importance, gave an impetus to the study of the chemistry of putrefaction which has already been productive of much good, and gives promise of much more in the future. Selmi showed that ptomaines could be obtained (1) by extracting acidified solutions of putrid material with ether; (2) by extracting alkaline solutions with ether; (3) by extracting alkaline solutions with chloroform; (4) by extracting alkaline solutions with anhydrous alcohol; and (5) that there yet remained in the solutions of putrid matter ptomaines which were not extracted by any of the above mentioned reagents. In this way he gave some idea of the great number of alkaloidal bodies which might be formed among the products of putrefaction, and the promising field thus discovered and outlined was soon occupied by a busy host of chemists. In the second place, he demonstrated the fact that many of the ptomaines give reactions similar to those given by the vegetable alkaloids. This led the toxicologist into investigations, the results of some of which we will ascertain further on.

Rörsch and Fassbender, in a case of suspected poisoning, obtained by the Stas-Otto method a liquid, which could be extracted from acid as well as from alkaline solutions by ether, and which gave all the general alkaloidal reactions. They were unable to crystallize either extract by taking it up with alcohol and evaporating. The colorless aqueous solution was not at all bitter to the taste. The precipitate formed with phosphomolybdic acid dissolved on the application of heat, giving a green solution, which became blue on the addition of ammonia. They believed that this substance was derived from the liver, since fresh ox-liver treated in the same manner gave them an alkaloid, which could be extracted with ether from acid as well as from alkaline solutions. Gunning found this same alkaloid in liver sausage from which poisoning had occurred. Rörsch and Fassbender state that while in some of its reactions this substance resembles digitalin, it was distinguished from this vegetable alkaloid by the failure of the ptomaine to give the characteristic bitter taste.

Schwanert, whilst examining the decomposing intestines, liver, and spleen of a child which had died suddenly, perceived a peculiar odor, and obtained by the Stas-Otto method (ether extract from an alkaline solution) small quantities of a base, which was distinguished from nicotine and conine by its greater volatility and by its peculiar odor. He supposed that this substance was produced by decomposition; and in order to ascertain the truth of his supposition he took the organs of a cadaver that had lain for sixteen days at a temperature of 30°, and was well decomposed. These were treated with tartaric acid and alcohol. The acid solution was first extracted with ether, and yielded no result; it was then rendered alkaline, and extracted with ether. The latter extract gave on evaporation the same substance which he had found in the organs of the child. The residue was a yellowish oil, having an odor

somewhat similar to propylamine. It was repulsive, but not bitter, to the taste, and alkaline in reaction.

Selmi, in commenting upon the base studied by Rörsch and Fassbender, Schwanert, and himself, believing that all were dealing with the same body, states that it does not contain phosphorus, and that it is separated with extreme difficulty from the vegetable alkaloids.

Liebermann, in examining the somewhat decomposed stomach and intestines in a case of suspected poisoning, found an alkaloidal body, which was unlike that studied by the chemists mentioned above, inasmuch as it was not volatile. The Stas-Otto method was employed. The ether extract from alkaline solution left on evaporation a brownish, resinous mass, which dissolved in water to a turbid solution, the cloudiness increasing on heating. This reaction agrees with conine, but the odor differed from that of the vegetable alkaloid.

This substance is extracted by ether from acid, as well as from alkaline, solutions. The yellow, oily drops obtained after the evaporation of the ether are soluble in alcohol. The taste is slightly burning.

Selmi obtained from both putrefying and fresh intestines a substance which gave the general alkaloidal reactions with potassium iodide, gold chloride, platinum chloride, potassio-mercuric iodide, and phosphomolybdic acid. It has strong reducing power, and when warmed with sulphuric acid gives a violet coloration. These reactions are not due to leucin, tyrosin, kreatin, or kreatinin. This is the substance which, as has been stated, Selmi considered identical with that observed by Rörsch and Fassbender and Schwanert. The minor differences observed by the different chemists may have been due to the different degrees of purity in which the substance was obtained by them.

From human bodies which had been dead from one to ten months Selmi removed many alkaline bases. From an ether solution of a number of these, one was removed by treatment with carbonic acid gas. One base, which was insoluble in ether but readily soluble in amylic alcohol, was found to be a violent poison, producing in rabbits tetanus, marked dilatation of the pupils, paralysis, and death.

Parts of the human body preserved in alcohol were found by Selmi to yield an easily volatile, phosphorous-containing substance, which is soluble in ether and carbon bisulphide, and gives a brown precipitate with silver nitrate. It is not the phosphide of hydrogen. A similar substance is produced by the slow decomposition of the yolks of eggs. With potassium hydrate it gives off ammonia, and yields a substance having an intense conine odor. It is volatile, and reduces phosphomolybdic acid.

Selmi also obtained from decomposing egg-albumen a body whose chloride forms in needles, and which has a curare-like action on frogs. From one arsenical body which had been buried for fourteen days he obtained, by extracting from an alkaline (made alkaline with baryta) solution with ether, a substance which formed in needles, and which gave crystalline salts with acids. This substance did not contain any arsenic, but was highly poisonous. From the stomach of a hog, which had been

preserved in a solution of arsenious acid, Selmi separated an arsenical organic base. The fluid was distilled in a current of hydrogen. The distillate, which was found to be strongly alkaline, was neutralized with hydrochloric acid and evaporated to dryness, when cross-shaped crystals, giving an odor similar to that of trimethylamine, were obtained. This substance was found by Cicaccio to be highly poisonous, producing strychnia-like symptoms. From the liquid which remained in the retort a non-volatile arsenical ptomaine was extracted with ether. The physiological action of this substance, as demonstrated on frogs, was unlike that of the arsines, but consisted of torpor and paralysis.

Moriggia and Battistini experimented with alkaloids obtained from decomposing bodies upon Guinea-pigs and frogs, but did not attempt their isolation, because of the rapid decomposition which they undergo when exposed to the air and by which they lose their poisonous properties. These alkaloids they found to be easily soluble in amylic alcohol, less soluble in ether.

In 1871, Lombroso showed that the extract from mouldy corn meal produced tetanic convulsions in animals. This threw some light upon the cases of sporadic illness which had long been known to occur among the peasants of Lombardy, who eat fermented and mouldy corn meal. In 1876, Brugnattelli and Zenoni obtained by the Stas-Otto method from this mouldy meal an alkaloidal substance which was white, non-crystalline, unstable, and insoluble in water, but readily soluble in alcohol and ether. With sulphuric acid and bichromate of potassium it yields a color reaction very similar to that of strychnia.

The action of the ether extracts from decomposed brain resembles that of curare, but is less marked and more transitory. The beats of the frog's heart were decreased in number and strengthened in force; the nerves and muscles lost their irritability, and the animal passed into a condition of complete torpor. The pupils were dilated. Guareschi and Mosso, using the Stas-Otto method, obtained from human brains, which had been allowed to decompose at a temperature of from  $10^{\circ}$  to  $15^{\circ}$  for from one to two months, both volatile and non-volatile bases. Among the former only ammonia and trimethylamine were in sufficient quantity for identification. With these, however, were minute traces of ptomaines.

To Prof. L. Brieger, of Berlin, is due the credit of isolating and determining the composition of a number of ptomaines. From putrid flesh he obtained neuridin,  $C_5H_{14}N_3$ , and neurin,  $C_5H_{13}NO$ . The former is inert, while the later is poisonous. From decomposed fish he separated a poisonous base,  $C_2H_4(NH_2)_2$ , which is an isomeride of ethylenediamine, muscarine,  $C_5H_{15}NO_3$ , and an inert substance,  $C_6H_{17}NO_{21}$ , gadanine. Rotten cheese yielded neuridine and trimethylamine. Decomposed glue gave neuridine, dimethylamine, and a muscarine-like base. In the cadaver, he has found in different stages of decomposition choline, neuridine, trimethylamine, cadaverine,  $C_5H_{16}N_2$ , putrescine,  $C_4H_{12}N_2$ , and saprine, which is identical with cadaverine in composition, but unlike it in some of its chemical reactions. These are all inert.

After fourteen days of decomposition he found a poisonous substance, mydaleine. From a cadaver which had been kept at from  $-9^{\circ}$  to  $+5^{\circ}$  C. for four months, Brieger obtained mydine,  $C_8H_{11}NO$ , the poisonous substance mydatoxine,  $C_8H_{13}NO_{21}$ , also the poison, methyl-guanidine. From poisonous mussel he separated mytikotoxine,  $C_8H_{15}NO_2$ . From pure cultures of the typhoid bacillus of Koch and Eberth, Brieger obtained a poison, typhotoxine, and from like cultures of the tetanus germ of Rosenbach, tetanine.

Gautier and Etard have also isolated some ptomaines, which will be described later.

In 1885, Vaughan succeeded in isolating the active agent of poisonous cheese, to which he gave the name tyrotoxon. This discovery has been confirmed by Newton, Wallace, Schæffer, Stanton, Firth, and Wolf.

Nicati, Rietsch, Koch, and others have shown the presence of a ptomaine in cultures of the cholera bacillus. Salmon and Smith have done the same with cultures of the hog cholera germ; Hoffa, with those of the anthrax bacillus; and Brieger with those of the tetanus germ.

#### FOODS CONTAINING POISONOUS PTOMAINES.

*Poisonous Mussels.*—Judging from the symptoms produced, there are three different kinds of poisonous mussels. In one class, the symptoms seem to be those of a true gastro-intestinal irritant. Fodere reports the case of a sailor, who, after eating a large dish of mussels, suffered from nausea, vomiting, pain in the stomach, tenesmus, and rapid pulse. After death, which occurred within two days, the stomach and intestines were found inflamed, and filled with a tenacious mucus. Combe and others also report cases of the choleraic form of poisoning from mussel.

However, the symptoms which most frequently manifest themselves after the eating of poisonous mussel are more purely nervous. A sensation of heat and itching appears usually in the eye-lids, and soon involves the whole face and perhaps a large portion of the body. An eruption, usually called nettle rash, though it may be papular or vesicular, covers the parts. The itching is most annoying, and may be accompanied by marked swelling. Then follows a distressing asthmatic breathing, which is relieved by ether. In some cases reported by Mohring, dyspnœa preceded the eruption, the patients became insensible, the face livid, and convulsive movements of the extremities were noticed. Burrow reports similar cases with delirium, convulsions, coma, and death within three days.

In a third class of cases, there may be a kind of intoxication resembling somewhat that of alcohol; then paralysis, coma, and death.

In 1827, Combe observed thirty persons poisoned, two of them fatally, with mussels. He describes the symptoms as follows: "None, so far as I know, complained of anything peculiar in the smell or taste of the animals, and nine suffered immediately after taking them. In general, an hour or two elapsed, sometimes more; and the bad effects consisted

rather in uneasy feelings and debility, than in any distress referable to the stomach. Some children suffered from eating only two or three; and it will be remembered that Robertson, a young and healthy man, only took five or six. In two or three hours they complained of a slight tension at the stomach. One or two had cardalgia, nausea, and vomiting; but these were not general or lasting symptoms. They then complained of a prickly feeling in their hands, heat and constriction of the mouth and throat, difficulty of swallowing and speaking freely, numbness about the mouth, gradually extending to the arms, with great debility of the limbs. The degree of muscular debility varied a good deal, but was an invariable symptom. In some it merely prevented them from walking firmly, but in most of them it amounted to perfect inability to stand. While in bed they could move their limbs with tolerable freedom, but on being raised to the perpendicular posture, they felt their limbs sink under them. Some complained of a bad, coppery taste in the mouth, but in general this was in answer to what lawyers call a leading question. There was slight pain of the abdomen, increased on pressure, particularly in the region of the bladder, which organ suffered variously in its functions. In some the secretion of urine was suspended; in others it was free, but passed with pain and great effort. The action of the heart was feeble; the breathing unaffected; the face pale, expressive of much anxiety; the surface rather cold; the mental faculties unimpaired. Unluckily, the two fatal cases were not seen by any medical person, and we are therefore unable to state minutely the train of symptoms. We ascertained that the woman, in whose house were five sufferers, went away as in a gentle sleep, and that a few moments before death she had spoken and swallowed."

The woman died within three hours. The other death was that of a watchman, who was found dead in his box six or seven hours after he had eaten the mussels. Post-mortem examination in these showed no abnormality. The stomach contained some of the food partially digested.

The explorer, Voncouver, reports four cases similar to those observed by Combe. One of the sailors died in five and a half hours after eating the mussels.

In some recent cases reported by Schmidtman, as quoted by Brieger, the symptoms were as follows: Some dock hands and their families ate of cooked blue mussels, which had been taken near a newly built dock. The symptoms appeared, according to the amount eaten, from soon after eating to several hours later. There was a sensation of constriction in the throat, mouth, and lips; the teeth were set on edge as though sour apples had been eaten. There was dizziness, no headache, a sensation of flying, and an intoxication similar to that produced by alcohol. The pulse was rapid (from eighty to ninety), no elevation of temperature, the pupils dilated and reactionless. Speech was difficult, broken, and jerky. The limbs felt heavy; the hands grasped spasmodically at objects, and missed their aim. The legs were no longer able to support the body, and the knees knocked together. There were nausea, vomiting, no ab-



dominal pain, no diarrhœa. The hands became numb, and the feet cold. The sensation of cold soon extended over the entire body, and in some the perspiration flowed freely. There was a sensation of suffocation, then a restful and dreamless sleep. One person died in an hour and three quarters, another in three and a half hours, and a third in five hours, after eating of the mussels.

In one of these fatal cases, rigor mortis was marked, and remained for twenty-four hours. The vessels of all the organs were distended; only the heart was empty. Virchow concluded from the conditions observed that the blood had absorbed oxygen with great avidity. There was marked hyperæmia and swelling of the mucous membrane of the stomach and intestines, which Virchow pronounced an enteritis. The spleen was enormously enlarged, and the liver showed numerous hæmorrhagic infarctions.

Many theories have been advanced to account for poisonous mussels. It was formerly believed that the effects were due to copper, which the animals obtained from the bottoms of vessels; but as Christison remarks, copper does not produce these symptoms. Moreover, Christison made analysis of the mussels which produced the symptoms observed by Combe, and was unable to detect any copper. Bouchardat found copper in some poisonous mussels; but he does not state the amount, nor the source of the animals.

Edwards advanced the theory that the symptoms were wholly due to idiosyncrasy in the consumer. This may be true in some instances where only one or two of those partaking of the food are affected, but it certainly is not a tenable hypothesis in such instances as those reported by Combe and Schmidtman, where all those who partook of the food were affected.

Coldstream found the livers of the Leith mussels, as he thought, larger, darker, and more brittle than normal, and to this diseased condition he attributed the ill effects.

Lamoroux, Möhring, De Beune, Chenu, and Du Roxleau have supposed that the poisonous effects were due to a particular species of medusæ, upon which the animals fed. De Beune found in the vomited matter of one person suffering from mussel poisoning some medusæ, and he states that these are most abundant during the summer, when mussels are most frequently found to be poisonous.

The theory of Burrow, that the animal is always poisonous during the period of reproduction, has been received with considerable credit. However, cases of poisoning have occurred at different seasons of the year.

Crumpe, in 1872, suggested that there is a species of mussel which is in and of itself poisonous, and this species is often mixed with the edible variety. Schmidtman and Virchow formerly supported this idea. They state that the poisonous species has a brighter shell, a sweeter, more penetrating, bouillon-like odor, than the edible kind; also, that the flesh of the former is yellow, and that the water in which they are cooked is bluish.

Lohmeyer also champions this opinion. This theory, however, is opposed by the majority of zoölogists. Möbius states that the peculiarities of the supposed poisonous variety, pointed out by Virchow and Schmidt-mann, are really due to the conditions under which the animal lives, the amount of salt in the water, the temperature of the water, whether it is moving or still water, the nature of the bottom, etc. Finally, Möbius states that the sexual glands, which form the greater part of the mantle, are white in the male and yellow in the female. However, it has been shown later by Schmidtmann and Virchow that edible mussels may become poisonous if left in filthy water for fourteen days or longer; and, on the other hand, poisonous ones may become fit for food if kept for four weeks in good water. This, of course, overthrows the theory of the existence of a special poisonous species.

Cats and dogs which have eaten voluntarily of poisonous mussels have suffered from symptoms similar to those observed in man, and rabbits have been poisoned by the administration of the water in which the food has been cooked. A rabbit, which was treated in this manner by Schmidt-mann, died within one minute. From these mussels Brieger extracted the ptomaine, mytilotoxin. This poison has a curare-like action. Whether or not those mussels which produce other symptoms also contain ptomaines, remains for future investigations to determine.

*Sausage Poisoning.* This is also known as *botulismus* and *allantiasis*. While considerable diversity has been observed in symptoms of sausage poisoning, we cannot divide the cases into classes from their symptomatology, as was done in mussel poisoning. The first effects may manifest themselves at any time from one hour to twenty-four hours after eating of the sausage, and cases are recorded in which, it is stated, no symptoms appeared until several days had passed. However, we must remember that trichinosis was frequently, in former times, classed as sausage poisoning, and it is highly probable that these cases of long delay in the appearance of the symptoms were really not due to putrefaction, but to the presence of parasites in the meat. A large majority of the 124 cases more recently reported by Müller sickened within twenty-four hours, and out of the forty-eight of these which were fatal, six died within the first twenty-four hours.

At first, there is dryness of the mouth, constriction of the throat, uneasiness in the stomach, nausea, vomiting, vertigo, indistinctness of vision, dilatation of the pupils, difficulty in swallowing, and usually diarrhœa, though obstinate constipation may exist from the first. There is, as a rule, a sensation of suffocation, and the breathing becomes labored. The pulse is small, thready, and rapid. In some cases the radial pulse may be imperceptible. Marked nervous prostration and muscular debility follow. These symptoms vary greatly in prominence in individual cases. The retching and vomiting, which may be most distressing and persistent in some instances, in others are trivial at the beginning, and soon cease altogether. The same is true of the diarrhœa. As a rule, the functions of the brain proceed normally, but there may be delirium,

then coma, and death. In some there are marked convulsive movements, especially of the limbs; in others, paralysis may be an early and marked symptom. The pupils may dilate, then become normal, and again dilate. There is frequently ptosis, and paralysis of the muscles of accommodation is not rare. Complete blindness has followed in a few instances.

The fatality varies greatly in different outbreaks. In 1820 Kerner collected reports of seventy-six cases, of which thirty-seven were fatal. In his second publication (1822) he increased the number to 155 cases, with eighty-four fatal results. This gave a mortality of over fifty per cent.; while in one outbreak reported by Müller the mortality was less than two per cent.

A large proportion of the cases of sausage poisoning have occurred in Würtemberg, and the immediately adjacent portions of Baden. This fact has, without doubt, been correctly ascribed to the methods there practised of preparing and curing the sausage. It is said to be common for the people to use the dried blood of the sheep, ox, and goat in the preparation of this article. Moreover, the blood is kept sometimes for days in wooden boxes and at a high temperature before it is used. In these cases it is altogether likely that putrefaction progresses to the poisonous stage before the process of curing is begun. However, cases of poisoning have occurred from beef and pork sausages as well.

Moreover, the method of curing employed in Würtemberg favors putrefaction. A kind of sausage known as "blunzen" is made by filling the stomachs of hogs with the meat. In curing, the interior of this great mass is not acted upon, and putrefaction sets in. The curing is usually done by hanging the sausage in the chimney. At night, the fire often goes out, and the meat freezes. The alternate freezing and thawing renders decomposition more easy. The interior of the sausage is generally the most poisonous. Indeed, in many instances those who have eaten of the outer portions have been unharmed, while those who have eaten of the interior of the same sausage have been most seriously affected.

Many German writers state that when a poisonous sausage is cut, the putrid portion has a dirty, grayish-green color, and a soft, smeary consistency. A disagreeable odor, resembling that of putrid cheese, is perceptible. The taste is unpleasant, and sometimes there is produced a smarting of the mouth and throat. Post-mortem examination after sausage poisoning shows no characteristic lesion. It is generally stated that putrefaction sets in very tardily; but Müller shows that no reliance can be placed upon this point, and states that out of forty-eight recorded autopsies, it was especially stated in eleven that putrefaction rapidly developed. In some instances there has been noticed hyperæmia of the stomach and intestinal canal, but this is by no means constant. The liver and brain have been reported as congested, but this would result from the failure of the heart, and would by no means be characteristic of poisoning with sausage.

Von Faber, in 1821, observed sixteen persons, who were made sick by eating fresh, unsmoked sausage made from the flesh of a pig which had suffered from an abscess on the neck. Five of the patients died. The symptoms were as follows: There was constriction of the throat, difficulty in swallowing, retching, vomiting, colic-like pains, vertigo, hoarseness, dimness of vision, and headache. Later, and in the severe cases, there was complete exhaustion, and finally paralysis. The eye-balls were retracted; the pupils were sometimes dilated, then contracted; they did not respond to light; there was paralysis of the upper lids. The tonsils were swollen, but not as in tonsillitis. Liquids which were not irritating could be carried as far as the œsophagus, when they were ejected from the mouth and nose with coughing. Solid foods could not be swallowed at all. On the back of the tongue and in the pharynx there was observed a puriform exudate.

Obstinate constipation existed in all, while the sphincter ani was paralyzed. The breathing was easy, but all had a croupous cough. The skin was dry. There was incontinence of urine. There was no delirium, and the mind remained clear to the last.

Post-mortem examinations were held on four. The skin was rough ("goose-flesh"). The abdomen was retracted. The large vessels in the upper part of the stomach were filled with black blood. The contents of the stomach consisted of a reddish-brown, semi-fluid substance, which gave off a repugnant, acid odor. In one case the omentum was found greatly congested. The large intestines were very pale, and the right ventricle of the heart was filled with dark, fluid blood.

Schüz cites thirteen cases of poisoning from liver sausage, in which the symptoms differed from the foregoing in the following respects:

(1) In only one out of the thirteen was there constipation: all the others had numerous, watery, typhoid-like stools.

(2) Symptoms involving the sense of sight were present in only three; in all the pupils were unchanged.

(3) The croupous cough was wholly wanting; though in many there was complete loss of voice. Difficulty of swallowing was complained of by only one.

(4) Delirium was marked in all; and in one the disturbance of the mental faculties was prominent for several weeks.

(5) There were no deaths.

(6) The time between eating the sausage and the appearance of the symptoms varied from eighteen to twenty-four hours, and the duration of the sickness from one to four weeks; though in one case complete recovery did not occur until after two and a half months.

The sausages were not smoked, and all observed a garlic odor, though no garlic had been added to the meat.

Tripe reports sixty-four cases. The symptoms came on from three and a half to thirty-six hours after eating. The stools were frequent, watery, and of offensive odor. In some there was delirium. One died. In the fatal case, the hands and face were cold and swollen. The pulse

was rapid and weak. The pupils were contracted, but responded to light. The small intestine was found inflamed.

Hedinger reports the cases of a man and a woman with the usual symptoms, but during recovery the dilatation of the pupils was followed by contraction. Birds ate of this sausage, and were not affected.

Röser reports cases in which there was found after death abscesses of the tonsils, dark, bluish appearance of the mucous membrane of the pharynx, larynx, and bronchial tubes, dark redness of the fundus of the stomach, and circumscribed gray, red, and black spots on the mucous membrane of the intestines. The liver was brittle, and the spleen enlarged.

Many theories concerning the nature of the active principle of poisonous sausage have been advanced. It was once believed to consist of pyroligneous acid, which was supposed to be absorbed by the meat from the smoke used in curing it; but soon it was found that unsmoked sausage might be poisonous also. Emmert believed that the active agent was hydrocyanic acid, and Jäger's theory supposed the presence of picric acid. But these acids are not found in poisonous sausage, and, moreover, their toxicological effects are wholly unlike those observed in sausage poisoning. As we have elsewhere seen, Kerner believed that he had found the poisonous principle in a fatty acid. This theory was supported by Dann, Buchner, and Schuman. Kerner believed the poison to consist of either caseic or sebacic acid, or both, while Buchner named it *acidum botulinicum*; but the acids of the former proved to be inert, and that of the latter to have no existence. Schlossberger suggested that the poisonous substance is most probably basic in character, and he found an odoriferous, ammoniacal base, which could not be found in good sausage, and which did not correspond to any known amides, imides, or nitric bases. However, this substance has not been obtained by any one else, nor has it been demonstrated to be poisonous.

Liebig, Duffas, Hirsch, and Simon believed in the presence of a poisonous ferment. Van den Corput described *scarcina botulina*, which were believed to constitute the active agent. Müller, Hoppe-Seyler, and others have found various micro-organisms, and Virchow, Eichenberg, and others have examined microscopically the blood of persons poisoned with sausage. Recently Ehrlich has attempted to isolate the poisonous substance by employing Brieger's method; but he obtained only inert substances.

In the light of the knowledge of to-day concerning the nature of putrefaction, there can scarcely be a doubt that the active agent of poisonous sausage consists of an easily decomposable base, and we predict its isolation in the very near future.

*Poisonous Ham.* Under this head we shall not discuss cases of poisoning from trichina or other parasites, but shall refer only to those instances in which the toxic agent has originated in putrefactive changes. A number of such cases have been observed within the past ten years, but only a few of them have been investigated scientifically. The best

known of these, as well as the most thoroughly studied, is the Wellbeck poisoning, which Dr. Ballard investigated successfully. In June, 1880, a large number of persons attended a sale of timber and machinery on the estate of the Duke of Portland, at Wellbeck. The sale continued for four days, and lunches were served by the proprietress of a neighboring hotel. The refreshments consisted of cold boiled ham, cold boiled or roasted beef, cold beefsteak pie, mustard and salt, bread and cheese, pickles, and Chutnee sauce. The drinks were bottled and draught beer, spirits, ginger beer, lemonade, and water. Many were poisoned; and Dr. Ballard obtained the particulars of seventy-two cases, among which there were four deaths.

The cause of this illness was traced conclusively to the hams eaten. Klein found in the meat a bacillus, cultures of which were used for inoculating animals. These inoculations were found generally to be followed by pneumonia. No attempt was made to isolate a ptomaine.

Later, Ballard reported fifteen cases, with symptoms similar to the above, and with one death, from eating baked pork. Not all of those who ate of this pork were made sick. This might have been due to inequality in the putrefactive changes in different portions of the meat, or it may have been due to differences in temperature in various portions of the meat during the cooking. In the blood, pericardial fluid, and lungs of the fatal case, Klein observed bacilli similar to those discovered in the Wellbeck inquiry. Pneumonia was produced by inoculating Guinea-pigs and mice with these bacilli.

*Poisonous Canned Meats.* Cases of poisoning from eating canned meats have become quite frequent. Although it may be possible that in some instances the untoward effects result from metallic poisoning, in the great majority of cases the poisonous principles are formed by putrefactive changes. In many instances, it is probable that decomposition begins after the can is opened by the consumer. In others, the canning is carelessly done, and putrefaction is far advanced before the food reaches the consumer. In still other instances the meat may be taken from diseased animals, or it may have undergone putrefactive changes before the canning. What is true of canned meats is also true of canned fruits and vegetables.

*Poisonous Cheese.* In 1827, Hünnefeld made some analyses of poisonous cheese, and experimented with extracts upon the lower animals. He accepted the ideas of Kerner in regard to poisonous sausage in a somewhat modified form, and thought the active agents to be sebacic and caseic acids. About the same time, Sertürner, making analyses of poisonous cheese for Westrumb, also traced the poisonous principles, as he supposed, to these fatty acids. We see from this that during the first part of the present century the fatty acid theory, as it may be called, was generally accepted.

In 1848, Christison, after referring to the work of Hünnefeld and Sertürner, made the following statement: "His [Hünnefeld's] experiments, however, are not quite conclusive of the fact that these fatty acids are

really the poisonous principles, as he has not extended his experimental researches to the caseic and sebatic acids prepared in the ordinary way. His views will probably be altered and simplified if future experiments should confirm the late inquiries of Braconot, who has stated that Proust's caseic acid is a modification of the acetic acid combined with an acrid oil."

In 1852, Schlossberger made experiments with the pure fatty acids, and demonstrated their freedom from poisonous properties. These experiments have been verified repeatedly, so that now it is well known that all the fatty acids obtainable from cheese are devoid of poisonous properties.

It may be remarked here that there is every probability that the poisonous substance was present in the extracts obtained by the older chemists: indeed, we may say that this is a certainty, since the administration of these extracts to cats was, in some instances at least, followed by fatal results. The great mass of these extracts consisted of fatty acids, and as the chemists could find nothing else present, they very naturally concluded that the fatty acids themselves constituted the poisonous substance.

Since the overthrow of the fatty acid theory, various conjectures have been made, but none of them are worthy of consideration.

We make the following quotations from some of the best authorities, who wrote during the first half of the present decade upon this subject:

Hiller says,—“Nothing definite is known of the nature of cheese poison. Its solubility seems established from an observation of Husemann, a case in which the poison was transmitted from a nursing mother to her child.”

Husemann wrote as follows: “The older investigations of the chemical nature of cheese poison, which led to the belief of putrefactive cheese acids and other problematic substances, are void of all trustworthiness; and the discovery of the active principle of poisonous cheese may not be looked for in the near future, on account of proper animals for controlling the experiments with the extracts, as dogs can eat large quantities of poisonous cheese without its producing any effect.”

Brieger stated in 1885,—“All kinds of conjectures concerning the nature of this poison have been formed, but all are even devoid of historical interest, because they are not based upon experimental investigations. My own experiments towards solving this question have not progressed very far.”

In the above quotation, we think that Brieger has hardly done justice to the work of Hünnefeld and Sertürner. Their labors can hardly be said to be wholly devoid of historical interest, and they certainly did employ the experimental method of inquiry. We shall soon see as to the correctness of the prediction of Husemann, as given above.

In the years 1883 and 1884, there were reported to the Michigan State Board of Health about 300 cases of cheese poisoning. As a rule, the first symptoms appeared within from two to four hours after eating the cheese. In a few the symptoms were delayed from eight to ten hours,

and were very slight. The attending physicians reported that the gravity of the symptoms varied with the amount of cheese eaten, but no one who ate of the poisonous cheese wholly escaped. One physician reported the following symptoms: "Every one who ate of the cheese was taken with vomiting, at first of a thin, watery, later a more consistent reddish-colored, substance. At the same time, the patients suffered from diarrhœa with watery stools. Some complained of pain in the region of the stomach. At first, the tongue was white, but later it became red and dry; pulse was feeble and irregular; countenance pale, with marked cyanosis. One small boy, whose condition seemed very critical, was covered all over his body with bluish spots."

Dryness and constriction of the throat were complained of by all. In a few cases the vomiting and diarrhœa were followed by marked nervous prostration, and, in some, dilatation of the pupils was observed.

Notwithstanding the severity of the symptoms in many, there was no fatal termination among these cases, though several deaths from cheese poisoning in other outbreaks have occurred. Many of the physicians at first diagnosed the cases from the symptoms as due to arsenical poisoning, and on this supposition some administered ferric hydrate. Others gave alcohol and other stimulants, and treated upon the expectant plan.

Vaughan, to whom the cheese was sent for analysis, made the following report: "All of these 300 cases were caused by eating of twelve different cheeses. Of these, nine were made at one factory, and one each at three other factories. Of each of the twelve I received smaller or larger pieces. Of each of ten I received only small amounts; of each of the other two I received about eighteen killograms. The cheese was in good condition, and there was nothing in the taste or odor to excite suspicion. However, from a freshly cut surface there exuded numerous drops of a slightly opalescent fluid, which reddened litmus instantly and intensely. Although, as I have stated, I could discern nothing peculiar in the odor, if two samples, one of good and the other of poisonous cheese, were placed before a dog or cat, the animal would invariably select the good cheese. But if only poisonous cheese was offered, and the animal was hungry, it would partake freely. A cat was kept seven days, and furnished only poisonous cheese and water. It ate freely of the cheese, and manifested no untoward symptoms. After the seven days, the animal was etherized, and abdominal section was made. I predicted, however, in one of my first articles on poisonous cheese, that the isolated poison would affect the lower animals. As to the truth of this prediction we will see later.

"My friend Dr. Sternberg, the eminent bacteriologist, found in the opalescent drops above referred to numerous micrococci. But inoculations of rabbits with these failed to produce any results.

"At first, I made an alcoholic extract of the cheese. After the alcohol was evaporated *in vacuo* at a low temperature, a residue consisting mainly of fatty acids remained. I ate a small bit of this residue, and found that it produced dryness of the throat, nausea, vomiting, and diarrhœa. The



mass of this extract consisted of fats and fatty acids, and for some weeks I endeavored to extract the poison from these fats, but all attempts were unsuccessful. I then made an aqueous extract of the cheese, filtered this, and, drinking some of it, found that it also was poisonous. But after evaporating the aqueous extract to dryness on the water-bath at 100°, the residue thus obtained was not poisonous. From this I ascertained that the poison was decomposed or volatilized at or below the boiling point of water. I then tried distillation at a low temperature; but by this the poison seemed to be decomposed.

“ Finally, I made the clear, filtered aqueous extract, which was highly acid, alkaline with sodium hydrate, agitated this with ether, removed the ether, and allowed it to evaporate spontaneously. The residue was highly poisonous. By resolution in water and extraction with ether, the poison was separated from foreign substances. As the ether took up some water, this residue consisted of an aqueous solution of the poison. After this was allowed to stand for some hours *in vacuo* over sulphuric acid, the poison separated in needle-shaped crystals. From some samples the poison crystallized from the first evaporation of the ether, and without standing *in vacuo*. This happened only when the cheese contained comparatively a large amount of the poison. Ordinarily, the microscope was necessary to detect the crystalline shape. From sixteen kilograms of one cheese I obtained about 0.5 gram of the poison, and in this case the individual crystals were plainly visible to the unaided eye. From the same amount of another cheese I obtained only about 0.1 gram, and the crystals in this case were not so large. I have no idea, however, that by the method used all the poison was separated from the cheese.”

To this ptomaine, Vaughan has given the name tyrotoxicon (*tuross*, cheese, and *toxikon*, poison).

During 1887, Wallace found tyrotoxicon in two samples of cheese which had caused serious illness. The first of these came from Jeansville, Penn., and the symptoms as reported to Wallace by Dr. Doolittle, who had charge of the cases, were as follows: “ There were at least fifty persons poisoned by this cheese. There were also eight others who ate of the cheese, but felt no unpleasant effects: whether this was due to personal idiosyncrasy, or to an uneven distribution of the poison throughout the cheese, I am unable to say.

“ The majority, however, comprising fifty or sixty persons, were seized in from two to four hours after eating the cheese with vertigo, nausea, vomiting, and severe rigors, though varying in their order of appearance and in severity in different cases. The vomiting and chills were the most constant and severe symptoms in all the cases, and were soon followed by severe pain in the epigastric region, cramps in the feet and lower limbs, purging and griping pain in the bowels, a sensation of numbness, or pins and needles, especially in the limbs, and, lastly, very marked prostration, amounting almost to collapse in a few cases.

“ The vomit at first consisted of the contents of the stomach, and had a strong odor of cheese; afterwards, it consisted of mucus, bile, and in

three or four of the severest cases blood was mixed with the mucus in small quantities. Microscopic examination of the same was not made, but to the eye it appeared as such. The vomiting and diarrhœa lasted from two to twelve hours; the rigors and muscular cramps, from one to two hours. The diarrhœa, at first fecal, became later watery and light-colored. No deaths occurred, and for the most part the effects were transient, and all that remained on the following day were the prostration and numbness; the latter occurred in about one half the cases, and disappeared in from one to three days.

“Children, as a rule, seemed to suffer less than adults, and, of course, it was not possible to elicit as definite symptoms from them. The suddenness of the attack was remarked by all, some feeling perfectly well until the moment of attack. Nor did the symptoms seem to be in proportion to the amount of the cheese taken. Some of the severest cases declared they had not eaten more than a cubic inch of it. One of the severest cases was about six and a half months pregnant, but no interference with pregnancy occurred. All the cheese which caused the sickness came from the same piece.”

The second sample of cheese examined by Wallace came from River-ton, N. J. This outbreak included a smaller number of persons, all of whom recovered.

Still more recently Wolf has detected tyrotoxinon in cheese which poisoned several persons at Shamokin, Penn. The pores of this cheese were found filled with a grayish-green fungoid growth, though it is not supposed that this fungus was connected in any way with the poisonous nature of the cheese. Tests were made for mineral poisons with negative results, after which tyrotoxinon was recognized both by chemical and physiological tests. “A few drops of the liquid (extract) placed on the tongue of a young kitten produced prompt emesis and numerous watery dejections, with evident depression and malaise of the animal. A larger cat was similarly affected by it, though the depression and malaise were not so marked nor so long continued.”

Cheese poisoning caused the death of several children in the neighborhood of Heiligenstadt in 1879, and there were many fatal cases from the same cause in Pymont in 1878. Unfortunately, we have not been able to find any detailed account of either the symptoms or the post-mortem appearances in these cases.

*Poisonous Milk.* In 1885, Vaughan found tyrotoxinon in some milk which had stood in a well stoppered bottle for about six months. It was presumed that this milk was, when first obtained, normal in composition; but since this was not known with certainty, the following experiments were made: Several gallon-bottles were filled with normal milk, tightly closed with glass stoppers, and allowed to stand at the ordinary temperature of the room. From time to time a bottle was opened, and the test for tyrotoxinon was made. These tests were followed by negative results until about three months after the experiment was begun. Then the poison was obtained from one of the bottles. The coagulated

milk was filtered through paper. The filtrate, which was colorless and decidedly acid in reaction, was rendered feebly alkaline by the addition of potassium hydrate, and agitated with ether. After separation, the ethereal layer was removed with a pipette, passed through a dry filter paper in order to remove a flocculent, white substance which floated in it, and then allowed to evaporate spontaneously. If necessary, this residue was dissolved in water, and again extracted with ether. As the ether takes up some water, there is usually enough of the latter left, after the spontaneous evaporation of the ether, to hold the poison in solution, and in order to obtain the crystals this aqueous solution must be allowed to stand for some hours *in vacuo* over sulphuric acid.

From a half gallon of the milk there was obtained quite a concentrated aqueous solution of the poison after the spontaneous evaporation of the ether. Ten drops of this solution placed in the mouth of a small dog, three weeks old, caused within a few minutes frothing at the mouth, retching, the vomiting of frothy fluid, muscular spasm over the abdomen, and after some hours watery stools. The next day the dog seemed to have partially recovered, but was unable to retain any food. This condition continuing for two or three days, the animal was killed with chloroform. No examination of the stomach was made.

In 1886, Newton and Wallace obtained tyrotoxin from milk, and studied the conditions under which it forms. Their report is of so much value that the greater part of it is herewith inserted.

“On August 7th, twenty-four persons at one of the hotels at Long Branch were taken ill soon after supper. At another hotel, on the same evening, nineteen persons were seized with the same form of sickness. From one to four hours elapsed between the meal and the first symptoms. The symptoms noticed were those of gastro-intestinal irritation, similar to poisoning by any irritating material,—that is, nausea, vomiting, cramps, and collapse; a few had diarrhœa. Dryness of the throat and a burning sensation in œsophagus were prominent symptoms.

“While the cause of the sickness was being sought for, and one week after the first series of cases, thirty persons at another hotel were taken ill with precisely the same symptoms as noticed in the first outbreak.

“When the news of the outbreak was published, one of us immediately set to work, under the authority of the state board of health, to ascertain the cause of the illness. The course of the investigation was about as follows:

“The character of the illness indicated, of course, that some article of food was the cause, and the first part of our task was to single out the one substance that seemed at fault. The cooking utensils were also suspected, because unclean copper vessels have often caused irritant poisoning. Articles of food, such as lobsters, crabs, blue fish, and Spanish mackerel, all of which at times, and with some persons very susceptible to gastric irritation, have produced toxic symptoms, were looked for; but it was found that none of these had been eaten at the time of the

outbreak. The cooking vessels were examined, and all found clean and bright, and no evidence of corrosion was presented.

“Further inquiry revealed the fact that all who had been taken ill had used milk in greater or less quantities, and that persons who had not partaken of milk escaped entirely. Corroborative of this it was ascertained that those who had used milk to the exclusion of all other food were violently ill. This was prominently noticed in the cases of infants fed from the bottle, when nothing but uncooked milk was used. In one case an adult drank about a quart of the milk, and was almost immediately seized with violent vomiting, followed by diarrhœa, and this by collapse. Suffice it to say that we were able to eliminate all other articles of food, and to decide that the milk was the sole cause of the outbreak.

“Having been able to determine this, the next step was to discover why that article should, in these cases, cause so serious a form of sickness.

“The probable causes which we were to investigate were outlined as follows: (1) Some chemical substance, such as borax, boric acid, salicylic acid, sodium bicarbonate, sodium sulphate, added to preserve the milk or to correct acidity; (2) the use of polluted water, as an adulterant; (3) some poisonous material accidentally present in the milk; (4) the use of milk from diseased cattle; (5) improper feeding of the cattle; (6) the improper care of the milk; (7) the development in the milk of some ferment or ptomaine, such as tyrotoxin.

“At the time of the first outbreak we were unable, unfortunately, to obtain any of the noxious milk, as that unconsumed had been destroyed; but at the second outbreak a liberal quantity was procured.

“It was soon ascertained that one dealer had supplied all the milk used at the three hotels where the cases of sickness had occurred. His name and address having been obtained, the next step in the investigation was to inspect all the farms, and the cattle thereon, from which the milk was taken. We also learned that two deliveries at the hotels were made daily, one in the morning and one in the evening; that the milk supplied at night was the sole cause of sickness, and that the milk from but one of the farms was at fault. The cows on this farm were found to be in good health, and, besides being at pasture, were well fed with bran, middlings, and corn meal.

“So far, we had been able to eliminate, as causes, diseased cattle and improper feeding, and we were then compelled to consider the other possible sources of the toxic material.

“While the inspection of the farms was being made, the analysis of the milk was in progress. The results of this showed that no chemical substance had been added to the milk; that it was of average composition; that no polluted water had been used as a diluent; and that no poisonous metals were present. This result left us nothing to consider but two probable causes,—improper care of the milk, and the presence of a ferment.

“As to the former, we soon learned much. The cows were milked at the unusual and abnormal hours of midnight and noon; and the noon’s milking—that which alone was followed by illness—was placed while hot in the cans, and then, without any attempt at cooling, carted eight miles during the warmest part of the day in a very hot month.

“This practice seemed to us sufficient to make the milk unpalatable, if not injurious; for it is well known that when fresh milk is closed up in a tight vessel, and then deposited in a warm place, a very disagreeable odor and taste are developed. Old dairymen speak of the animal heat as an entity, the removal of which is necessary, in order that the milk shall keep well and have a pleasant taste. While we do not give this thing a name, we are fully convinced that milk should be thoroughly cured, by proper chilling and aeration, before it is transported any distance, or sold for consumption in towns or cities.

“The results of our inquiry having revealed so much, we next attempted to isolate some substance from the poisonous milk, in order that the proof might be more evident. A quantity of the milk that had caused sickness in the second outbreak was allowed to coagulate, was then thrown on a coarse filter, and the filtrate collected. This latter was highly acid, and was made slightly alkaline by the addition of potassium hydrate. This alkaline filtrate was now agitated with an equal volume of pure, dry ether, and allowed to stand for several hours, when the ethereal layer was drawn off by means of a pipette. Fresh ether was added to the residuum, then agitated, and, when separated, was drawn off, and added to the first ethereal extract. This was now allowed to evaporate spontaneously, and the residue, which seemed to contain a small amount of fat, was treated with distilled water and filtered, the filtrate treated with ether, the ethereal solution drawn off and allowed to evaporate, when we obtained a mass of needle-shaped crystals. This crystalline substance gave a blue color with potassium ferricyanide and ferric chloride, and reduced iodic acid. The crystals, when placed on the tongue, gave a burning sensation. A portion of the crystals was mixed with milk and fed to a cat, when, in the course of half an hour, the animal was seized with retching and vomiting, and was soon in a condition of collapse, from which it recovered in a few hours.

“We are justified in assuming, after weighing well all the facts ascertained in the investigation, that the sickness at Long Branch was caused by poisonous milk, and that the toxic material was tyrotoxin.

“The production of this substance was no doubt due to the improper management of the milk,—that is, too long a time was allowed to elapse between the milking and the cooling of the milk, the latter not being attended to until the milk was delivered to the hotel; whereas, if the milk had been cooled immediately after it was drawn from the cows, fermentation would not have ensued, and the resulting material, tyrotoxin, would not have been produced.”

In the same year Shearer found the same poison in the milk used by, and in the vomited matter of persons made sick at, a hotel at Corning, Iowa.

In 1887, Firth, an English army surgeon stationed in India, reported an outbreak of milk poisoning among the soldiers of his garrison. From the milk he separated, by Vaughan's method, tyrotoxin. He also obtained tyrotoxin from milk which had been kept for some months in stoppered bottles, as had been previously done by Vaughan.

In 1887, Mesic and Vaughan observed four cases of milk poisoning, three of which terminated fatally; and Novy and Vaughan obtained tyrotoxin from the milk, and from the contents of the intestine in one of the fatal cases. The report of these cases may be found in the first quarterly report of the Michigan State Laboratory of Hygiene, or in the *Medical News* of Dec. 3, 1887.

*Poisonous Ice-Cream.* In 1886 Vaughan and Novy obtained tyrotoxin from a cream which had seriously affected many persons at Lawton, Mich. Vanilla had been used for flavoring, and it was supposed that the ill effects were due to the flavoring. This belief was strengthened by the fact that a portion of the custard was flavored with lemon, and the lemon cream did not affect any one unpleasantly. Fortunately some of the vanilla extract remained in the bottle from which the flavoring for the ice-cream had been taken, and this was forwarded to the chemists. Each of the experimenters took at first thirty drops of the vanilla extract, and no ill effects following this, one of them took two teaspoonfuls more, with no results. This proved the non-poisonous nature of the vanilla more satisfactorily than could have been done by a chemical analysis.

Later it was found that that portion of the custard which had been flavored with lemon was frozen immediately, while that portion which was flavored with vanilla, and which proved to be poisonous, was allowed to stand for some hours in a building which is described as follows by a resident of the village:

“The cream was frozen in the back end of an old wooden building on Main street. It is surrounded by shade, has no underpinning, and the sills have settled into the ground. There are no eave-troughs, and all the water falling from the roof runs under the building, the streets on two sides having been raised since the construction of the house. The building had been unoccupied for a number of months, consequently has had no ventilation, and, what is worse, the back end (where the cream was frozen) was last used as a meat-market. The cream which was affected was that portion last frozen; consequently it stood in an atmosphere more like that of a privy vault for upward of an hour and a half or two hours before being frozen.”

The symptoms observed in these cases were identical with those produced by poisonous cheese and milk.

The tyrotoxin obtained from this cream was administered to a kitten about two months old. Within ten minutes the cat began to retch, and soon it vomited. This retching and vomiting continued for two hours, during which the animal was under observation, and the next morning it was observed that the animal had passed several watery stools. After this, although the animal could walk about the room, it was unable to

retain any food. Several times it was observed to lap a little milk, but on doing so it would immediately begin to retch and vomit. Even cold water produced this effect. This condition continuing, after three days the animal was placed under ether and its abdominal organs examined. Marked inflammation of the stomach was supposed to be indicated by the symptoms, but the examination revealed the stomach and small intestines filled with a frothy, serous fluid such as had formed a portion of the vomited matter, and the mucous membrane very white and soft. There was not the slightest redness anywhere. The liver and other abdominal organs seemed normal.

A bit of the solid portion of this cream was added to some normal milk, which by the addition of eggs and sugar was made into a custard. The custard was allowed to stand for three hours in a warm room, after which it was kept in an ice-box until submitted to chemical analysis. In this tyrotoxinon was also formed.

Tyrotoxinon has since been formed in some chocolate cream which poisoned persons at Geneva, N. Y., and in lemon cream from Amboy, Ohio.

Shearer reports the finding of tyrotoxinon in both vanilla and lemon ice-cream which made many sick at Corning, Iowa.

Allaben reports poisoning with lemon cream, and makes the following interesting statements concerning it:

"I would first say, July 4, 5, and 6 were very warm. Monday evening, July 5, the custards were cooked, made from Monday morning's cream and Monday night's milk, boiled in a tin pan that had the bright tin worn off. It was noticed that one pan of cream was not sweet, but thinking it would make no difference, it was used; the freezers were thoroughly cleaned and scalded, and the custards put in the same evening while hot; the cream was frozen Tuesday afternoon, having stood in the freezers since the night before, when the weather was very warm."

No analysis of this cream was made, but the symptoms agree with those of tyrotoxinon poisoning.

Wellford observed several cases of poisoning from custard flavored with lemon. These custards were tested for mineral poisons with negative results.

Morrow has put forth the claim that ice-cream poisoning is solely due to vanillin, which is, according to his statement, used instead of vanilla extract, but the facts stated above concerning poisoning with creams in which other flavors had been used contradicts this claim. Moreover, Gibson has shown the utter absurdity of the claim, inasmuch as he calculates, from the amount of flavoring ordinarily used in ice-cream, that in order to produce the toxic symptoms observed, the flavoring must be ten times as poisonous as pure strychnia.

Bartley suggests that poisonous cream sometimes results from the use in its manufacture of poor or putrid gelatine. This is highly probable, and with the gelatine the germs of putrefaction may be added to the milk.

## THE PTOMAINES OF CERTAIN DISEASES.

*Anthrax.* Anthrax has probably been more thoroughly studied than any other infectious disease. Kausch taught that anthrax has its origin in paralysis of the nerves of respiration. Delafond thought that the cause of the disease was to be found in the influence of the chemical condition of the soil affecting the food of animals and leading to abnormal nutrition. The investigations of Gerlach in 1885 demonstrated the contagious nature of the disease, which was emphasized by Heusinger in 1850, and accepted by Virchow in 1855. However, in 1849 Pollender found numerous rod-like micro-organisms in the blood of animals with the disease. This observation was confirmed by Brauell, who produced the disease in healthy animals by inoculation with matter taken from a pustule on a sick horse. Attempts were made to ridicule the idea that these germs might be the cause of the disease, and it was said that the bodies seen were only fine pieces of fibrine, or blood-crystals. But in 1863 Davaine showed that these little bodies must have some casual relation to the disease, inasmuch as his experiments proved that inoculation of healthy animals with the blood of animals sick with anthrax produced the disease only when the blood contained these organisms. He also demonstrated beyond any question that these bodies are bacteria. The conclusions of this investigator were earnestly combated by many. But Pasteur, Koch, Bollinger, DeBarry, and others studied the morphology and life-history of these organisms, and then came the brilliant results of Pasteur and Koch in securing protection against the disease by the vaccination of healthy animals with the modified germ. Now, the bacillus anthracis is known in every bacteriological laboratory, and by inoculation with it the disease is communicated at will to animals. But here the question arose, How do these bacilli produce anthrax?—and in answer to this question various theories were proposed. Recently Hoffa has given us the true answer by obtaining from pure cultures of the bacillus anthracis a ptomaine which, when injected under the skin of animals, produces the symptoms of the disease, followed by death. The anthrax ptomaine causes at first increased respiration and action of the heart, then the respirations become deep, slow, and irregular. The temperature falls below the normal. The pupils are dilated, and a bloody diarrhœa sets in. On section, the heart is found contracted, the blood dark, and ecchymoses were observed on the pericardium and peritonæum.

*Cholera.* Although the ptomaine of cholera has not been isolated, there are reasons for believing that the comma bacillus of Koch is one of the most active, chemically, of all known pathogenic micro-organisms. In the first place Bitter has shown that this germ produces in meat-peptone cultures a peptonizing ferment, which remains active after the organism has been destroyed. It was shown that this ferment, like similar chemical ferments, would convert an indefinite amount of gelatine or coagulated albumen into peptone. It was also demonstrated that this



ferment was more active in alkaline than in acid solutions, thus proving that it resembles pancreatine more than pepsine. This resemblance to pancreatine was further demonstrated by the fact that certain chemicals, such as sodium carbonate and sodium salicylate increased its activity.

That a diastatic ferment is also produced by the growth of this bacillus was indicated by the development of an acid in nutrient solutions containing starch paste. However, all attempts to isolate the diastatic ferment were unsuccessful. A temperature of 60° destroys or greatly decreases the activity of ptyaline, and this seems to be also true of the diastatic ferment produced by the comma bacillus. But the formation of an acid from the starch presupposes that the starch is first converted into a soluble form.

[It is proper to mention here that Sternberg, independently of the experiments of Bitter, has shown that a number of micro-organisms are capable of producing a peptonizing ferment which remains active after destroying the germs by raising the temperature of the culture to 80°. Sternberg experimented with bacillus prodigiosus, b. indicus, b. pyocyaneus, and Finkler-Prior's spirillum. It is probable that all germs which liquefy gelatine do so by the production of this ferment.]

In order to investigate the digestive action of bacteria, Rietsch precipitated peptone cultures of the cholera bacillus, typhoid bacillus, bacillus of consumption, and staphylococcus aureus with alcohol, collected, washed, dried, and weighed the precipitates, and tested their action upon coagulated fibrin. The powders thus obtained from cultures of the typhoid and consumption bacillus had no digestive action in either neutral or alkaline fluids. On the other hand, the precipitates obtained from the cultures of the cholera bacillus and the staphylococcus aureus, the latter less energetically than the former, dissolved the fibrine, and the solutions gave reactions for peptones.

Rietsch believes that the destructive changes observed in the intestines in cholera are due to the action of this peptonizing ferment.

Cantani injected sterilized cultures of the comma bacillus into the peritonæal cavities of small dogs, and observed, after from one quarter to one half hour, the following symptoms: great weakness, tremor of the muscles, drooping of the head, prostration, convulsive contractions of the posterior extremities, repeated vomiting, and cold head and extremities. After two hours these symptoms began to abate, and after twenty-four hours the recovery seemed complete. Control experiments with the same amounts of uninfected beef tea were made. These cultures were three days old when sterilized. Older cultures seemed less poisonous, and a high or prolonged heat in sterilization decreased the toxicity of the fluid. From these facts Cantani concludes that the poisonous principle is volatile. The cultures in bouillon containing peptone were more poisonous than those in the simple bouillon.

Klebs has attempted to answer experimentally the question, In what way does the cholera germ prove harmful? Cultures of the bacillus in fish preparations were acidified, filtered, the filtrate evaporated on the

water-bath, the residue taken up with alcohol, and precipitated with platinum chloride. The platinum was removed with hydrogen sulphide, and the crystalline residue obtained on evaporation was dissolved in water and intravenously injected into rabbits. Muscular contractions were induced. Death followed in one animal, which in addition to the above treatment received an injection of a non-sterilized culture. In this case there was observed an extensive calcification of the epithelium of the uriniferous tubules. Klebs believes this change in the kidney to be induced by the chemical poison, and from this standpoint he explains the symptoms of cholera as follows: The cymosis is a consequence of arterial contraction, the first effect of the poison. The muscular contractions also result from the action of the poison. The serous exudate into the intestines follows upon epithelial necrosis. Anuria and the subsequent severe symptoms appear when the formation and absorption of the poison become greatest.

Hueppe states that the severe symptoms of cholera can be explained only on the supposition that the bacilli produce a chemical poison, and that this poison resembles muscarine in its action.

Bujwid found that on the addition of from five to ten per cent. of hydrochloric acid to bouillon cultures of the cholera bacillus, there was developed after a few minutes a rose-violet coloration which increased during the next half hour, and in a bright light showed a brownish shade. The coloration is more marked if the culture is kept at about  $37^{\circ}$ . In impure cultures this reaction does not occur. The Finkler-Prior comma bacillus cultures give after a longer time a similar, but more of a brownish, coloration. Cultures of many other bacilli were tried, and failed to give the reaction.

Brieger found that this color is due to an indol derivative. In cholera cultures on albumens he obtained indol by distillation with acetic acid.

*Tetanus.* In 1884, Nicolaier, by inoculating 140 animals with earth taken from different places produced symptoms of tetanus in 69 of them. In the pus which formed at the point of inoculation he found micrococci and bacilli. Among the latter was one which was somewhat longer and slightly thicker than the bacillus of mouse-septicæmia. In the subcutaneous cellular tissue he found this bacillus alone, but could not detect it in the blood, muscles, or nerves. Heating the soil for an hour rendered the inoculation with it harmless. In culture, Nicolaier was unable to separate this bacillus from other germs, but inoculations with mixed cultures produced tetanus. In the same year Carle and Ratone induced tetanus in lower animals by inoculations with matter taken from a pustule on a man just dead from tetanus. In 1886 Rosenbach made successful inoculations on animals with matter taken from a man who had died from tetanus consequent upon gangrene from frozen feet. With bits of skin taken from near the line of demarcation he inoculated two Guinea pigs on the thigh. Tetanic symptoms set in within twelve hours, and one animal died within eighteen and the other within twenty-four hours. The symptoms corresponded exactly with those observed in the

“earth tetanus” of Nicolaier, and the same bacillus was found. With mixed cultures of this Rosenbach was also able to cause death by tetanus in animals. Beumer had under observation a man who died from lock-jaw following the sticking of a splinter of wood under his finger-nail. Inoculations of mice and rabbits with some of the dirt found on the wood led to tetanus. The same observer saw a boy die from this disease following an injury to the foot from a sharp piece of stone. White mice inoculated with matter from the wound and those inoculated with dirt taken from the boy’s play-ground died of tetanus. The bacillus of Nicolaier was again detected. Giordano reports the case of a man who fell and sustained a complicated fracture of the arm. He remained on the ground for some hours, and when assistance came the muscles and skin were found torn and the wounds filled with dirt. On the fifth day he showed symptoms of tetanus, from which he died on the eighth day. Inoculations and examinations for the bacillus were again successful. Terrari also made successful inoculations with the blood taken during life from a woman with tetanus after an ovariectomy. Hocksinger has confirmed the above-mentioned observations by carefully conducted experiments, the material for which was furnished by a case of tetanus arising from a very slight injury to the hand, the wound being filled with dirt. Finally, Shakespeare has succeeded in inducing tetanus in rabbits by inoculating them with matter taken from the medulla of a horse and of a mule, both of which had died from traumatic tetanus. These uniform observations leave no room to doubt that tetanus is, often at least, due to a germ which exists in many places in the soil, and that the disease is transmissible by inoculation.

The question now arises, How do these germs induce tetanus? Brieger has given us an answer, inasmuch as he has obtained in cultures of the germ of Nicolaier and Rosenbach four poisonous substances. The first, tetanine, which rapidly decomposes in acid solutions, but is stable in alkaline solutions, produces tetanus in mice when injected in quantities of only a few milligrams. The second, tetanotoxin, produces first tremor, then paralysis followed by severe convulsions. The third, to which no name has been given, causes tetanus accompanied by free flow of the saliva and tears. The fourth, spasmotoxin, induces heavy clonic and tonic convulsions.

It may be that all these will be found to be modifications or impure forms of the same poison. Brieger states that the exact character and relative amounts of the poisons formed vary with the nutrient in which the germ grows. With this evidence before us we feel justified in saying that the tetanus germ produces its poisonous effects by elaborating one or more ptomaines in the body of the animal into which it has been introduced.

*Typhoid Fever.* In 1880 Eberth discovered a bacillus, which he believed to be the cause of typhoid fever, and this belief has been confirmed. The fever with its characteristic lesions has been produced in animals by inoculation with the germ. Gaffky was the first to inoculate

animals with pure cultures of the bacillus of Eberth, but his results were wholly negative. Fränkel and Simmonds produced fatal results, and observed after death enlargement of the spleen, mesenteric glands and intestinal follicles. Moreover, microscopical examination of the spleen showed the same conditions which are found in the spleens of persons dead of typhoid fever. Seitz, using Koch's cholera method of inoculation, produced with the typhoid bacillus acute enteritis with ulceration and enlargement of the spleen. Vaughan and Novy, using the germ which they had obtained from drinking-water, produced in a cat vomiting, great muscular weakness or prostration, primary depression of temperature four degrees below the normal, and secondary elevation of temperature three degrees above the normal. Section showed ulceration in both the small intestine and ascending colon. Results of this kind leave no doubt that the bacillus first described by Eberth is the true germ of typhoid fever.

In 1885 Brieger obtained from pure cultures of the typhoid bacillus a toxic ptomaine, which produced in Guinea pigs a slight flow of the saliva, frequency of respiration, dilatation of the pupils, profuse diarrhœa, paralysis, and death within from twenty-four to forty-eight hours. Post-mortem examination showed the heart in systole, the lungs hyperæmic, and the intestines contracted and pale. This substance Brieger considers the special poison of typhoid fever, and calls it typhotoxine. However, he obtained with this poison no elevation of temperature.

In 1887 Vaughan and Novy obtained from pure cultures of the typhoid bacillus, found in drinking-water, which had been the supply for many persons who had the disease, an extract which, when injected under the skin of cats, caused an elevation in the temperature of from two to four and one half degrees above the normal.

In one sick of typhoid fever the bacillus grows and multiplies in the intestines and forms the poison, the absorption of which is followed by the rise in temperature and other symptoms of the disease. The lesions in the intestines are probably due to the bacteria themselves, or possibly to the local irritating effect of the ptomaine.

*Cholera Infantum.* There are many reasons for believing that this disease is sometimes at least due to poisoning by tyrotoxin. The fact that infants nourished exclusively from the mother's breast are almost wholly exempt from the disease, strengthens this belief. We have already seen how quickly and abundantly this poison appears in milk when the conditions are favorable. Moreover, the symptoms induced by the poison agree with those observed in the disease, and the post-mortem changes are identical. Then cholera infantum is a disease of the summer months, when decomposition in milk goes on most readily. It is most common in cities, and among classes who cannot obtain fresh milk or have not the means necessary to keep it fresh. Moreover, it is often allowed to stand in a foul atmosphere, and all know that milk readily takes up disagreeable odors. Even in the country insufficient attention is given to the care of milk. Cows stand and are milked in

filthy barns. The udders are generally not washed before the milking, and the vessels for the milk are frequently not as clean as they should be. There can be no doubt that greater attention to the milk used by infants would result in saving many thousands of lives annually.

#### HOW TO AVOID BEING POISONED WITH PTOMAINES.

To one who has read the preceding pages, it will be evident that the only way in which poisoning by ptomaines can be avoided consists in preventing their formation. The majority of poisonous ptomaines are not destroyed at the temperature to which food is raised in cooking. The addition of the most powerful disinfectants, such as mercuric chloride, to solutions of ptomaines does not destroy them. Panum boiled his putrid poison for eleven hours without destroying its virulence, and Brieger uses mercuric chloride in the separation of many of his ptomaines. However, the formation of ptomaines may be prevented by the destruction of the germs which produce them, and the methods of accomplishing this have been pointed out in the preceding portions of this report. In exceptional cases, as in milk containing tyrotoxicon, boiling the milk will destroy both the germ and the ptomaine, but boiling does not destroy the active principle of poisonous mussel, nor the poison of typhoid fever.

## METHODS OF PRACTICAL DISINFECTION.

By GEORGE H. ROHÉ, M. D.

The scientific determination of the germicide value of various agents used for purposes of disinfection is so recent that practical methods of applying them have not yet been developed to any great degree. Disinfection by means of steam has received most attention during the last two years, and a number of apparatuses have been devised for the efficient and economical application of this agent. As a supplement to the paper by the writer in the last annual report of the Committee on Disinfectants, a description of some of these devices will be given in the following pages.

By referring to the report of the committee for 1886 it will be seen that the most efficient devices for disinfection by heat consist of those in which steam under pressure, or passing through the articles to be disinfected in a free current (strömender Wasserdampf), are employed. The opinion was expressed, based upon practical experience, that steam under pressure, in order to raise its temperature (or possibly to increase its penetrating power), was the best form in which to employ the agent. This opinion was justified by European experience, and especially by the personal observations of Drs. S. H. Durgin and Joseph Holt, members of the committee, to whose reports attention is directed (*vide supra et infra*).

Recent experience abroad seems to indicate, however, that an apparatus in which the steam is not confined under pressure may be equally efficient, more easily managed, and much more economical. The simple disinfecting stove of Gibier (*vide Report for 1886*), as well as the disinfector of Henneberg (*vide infra*), seem to meet all the requirements of an efficient, economical, and safe disinfecting apparatus. During the recent epidemic of sweating sickness in France, Gibier's stove is said to have been used for purposes of disinfecting clothing and bedding with entire success.

For small communities, or for county and township health authorities, either of the two apparatuses above mentioned, or a modification of them, would seem to best subserve the requirements of an efficient apparatus. A disinfecting stove large enough to disinfect the furnishings of an ordinary sized bed should not cost more than one hundred dollars. If made in sections like Gibier's stove, it could be transported in any sort of vehicle, and, if necessary, used in the infected room itself. By a little ingenuity the wagon upon which the apparatus is transported might be made to serve as the disinfecting chamber.

The temperature in the interior of the chamber should be maintained at 100° C. (212° F.), or above for ten to fifteen minutes in order to make sure of the destruction of all infectious material. Every apparatus should be tested for its disinfecting power before being placed in actual service. It would seem that all machines of the same size and pattern should be equally efficient, but practical experience shows that no safe prediction of the "functioning capacity" of any apparatus can be given before a thorough test has been made.

## HENNEBERG'S DISINFECTOR.

(Zeitschrift f. Hygiene, Bd. I, Hft. 2.)

This apparatus consists of two superimposed cylinders, of which the upper (Fig. 1, *a*) is intended to receive the articles to be disinfected,

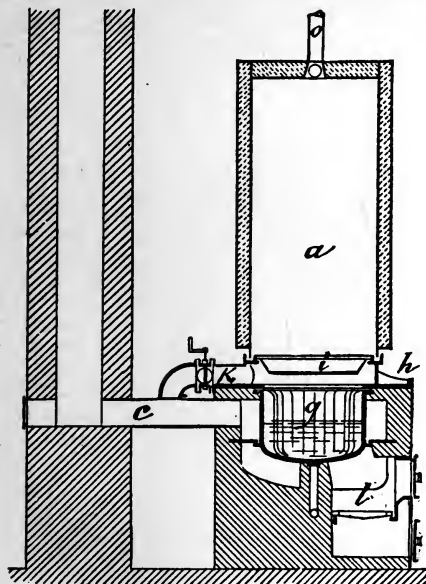

Fig. 1.

while the lower (*g*) is the boiler in which the steam is generated. The upper cylinder has double walls and a cover of tin. The interspace between the outer and inner walls is filled with some non-conducting material. The lower end of the cylinder is open, and rests in a groove which forms the upper end of the boiler. When this groove is filled with water, the joint between the receptacle and boiler is perfectly tight and does not permit the escape of steam. The walls of the boiler are corrugated to increase the heating surface. A perforated iron plate (*i*) forms the lid of the boiler. The fire, heating the upper portion of the iron sides of the boiler, prevents

condensation of the steam first disengaged, and at the same time aids in drying the materials to be disinfected, and expelling the air in the upper cylinder before the latter becomes filled with steam. The steam evolved at the surface of the water is also superheated in passing over the heated surfaces of the sides of the boiler.

The steam is not confined under pressure, but is allowed to escape through the duct (*o*) which may lead directly to the open air or into a chimney. At the lower end of the escape pipe a thermometer is attached which registers the temperature attained in the chamber.

To charge the disinfector, the upper cylinder is raised a short distance by means of an ingenious mechanism, until clear of the groove in which its lower end rests. The cylinder is then turned on its side until it rests

almost horizontally. It is fixed in this position until the articles to be disinfected have been placed in it, enclosed in a wire basket. The cylinder is then again turned upright, sunk into its proper groove, and the fire started. After the steam has passed a sufficient length of time to make sure of thorough disinfection, a valve ( $k$ ) is opened which leads into the chimney. The strong draught not only causes the steam now produced to pass into the chimney, but also draws out that in the cylinder. In a few minutes the contents of the disinfector are entirely dry, and can then be removed by turning the cylinder on its side, as in the process of charging.

The other, non-essential, parts of the apparatus are pipes for filling and emptying the boiler, and for removing the condensed vapor. The estimated expense of running this apparatus, including interest on capital invested, is 8.90 marks (about \$2.10) per day for a machine of sufficient size to disinfect 7.35 cubic meters (about 250 cubic feet) of materials.

The disinfecting power of the apparatus has been tested by Dr. E. Esmarch, and found to meet all requirements.

W. Budenberg, a manufacturer of disinfecting apparatus in Dortmund, exhibited a model of a new disinfector at the last meeting of the German Association of Naturalists and Physicians. No description was published, but the following points are of some interest. The steam is under slight pressure. The apparatus is easily transportable, and can be readily connected to any steam generator. After the steam begins to enter the disinfecting chamber, a temperature of 105° C. (221° F.) is secured in five minutes, and after five minutes longer the temperature in the interior of large packages is raised to 102°–103° C. (216°–218° F.). A bacteriological test showed complete destruction of spores. An apparatus 2.25 meters (7 ft. 4 in.) long, nine tenths of a meter (35 inches) broad, and 1.50 meters (4 ft. 11 in.) high, can be made for 400 marks (\$100).

#### COST OF DISINFECTION IN BERLIN.

H. Merke gives in the *Deutsche Vierteljahresschrift für Öffentliche Gesundheitspflege*, Bd. 19, Hft. 2, some interesting details concerning the management and expense of the public disinfecting station in Berlin. The station was opened for the use of the public on November 1, 1886; and in the two months, November and December, 1886, 327 persons made use of the apparatus for purposes of disinfection. The materials to be disinfected occupied a total space of 722.4 cubic metres (25,284 cubic feet). In 298 of the 327 applications, the disease for which disinfection was requested was ascertained. In the remaining 29 cases, either the diagnosis could not be learned, or the materials disinfected consisted of rags, furniture, or trimmings of sleeping-cars, or articles from places suspected of being infected. In these cases the disease to which the articles were supposed to have been exposed was generally cholera.



Disinfection was practised in the 298 cases in which the disease was known,—

After diphtheria in 122 cases, . . . . .	or 40.93 per cent.
After suspected cholera in 23 cases, . . . . .	or 7.72 per cent.
After consumption in 47 cases, . . . . .	or 15.77 per cent.
After scarlet fever in 34 cases, . . . . .	or 11.40 per cent.
After typhoid fever in 11 cases, . . . . .	or 3.60 per cent.
After syphilis, scabies, and other skin diseases in 61 cases, or	20.47 per cent.

Curiously, the larger proportion of those desiring disinfection belonged to the better classes.

- Of the applications, 28.6 per cent. were from merchants.
- 13.4 per cent. were from mechanics.
- 11.4 per cent. were from professional men.
- 9.0 per cent. were from officials.
- 5.7 per cent. were from manufacturers.
- 4.0 per cent. were from rentiers.
- 3.0 per cent. were from officers.
- 5.7 per cent. were from laborers.
- 19.3 per cent. were from restaurateurs, etc.

The charges for disinfection are four marks (\$1.00) per cubic meter, including bringing and returning the articles. Where rags are disinfected, the charges are one mark (24 cents) per 100 pounds, exclusive of transportation to and from the disinfecting establishment.

The materials disinfected consisted of 12,935 different articles, classified as follows :

Clothing . . . . .	1,710 pieces.
Body linen . . . . .	5,351 pieces.
Feather beds . . . . .	1,940 pieces.
Mattresses and bolsters . . . . .	1,084 pieces.
Straw sacks . . . . .	20 pieces.
Furniture . . . . .	101 pieces.
Other articles, such as carpets, sacks of rags, curtains, spreads, etc.,	2,729 pieces.

NEW ELECTRICAL REGISTERING THERMOMETER.

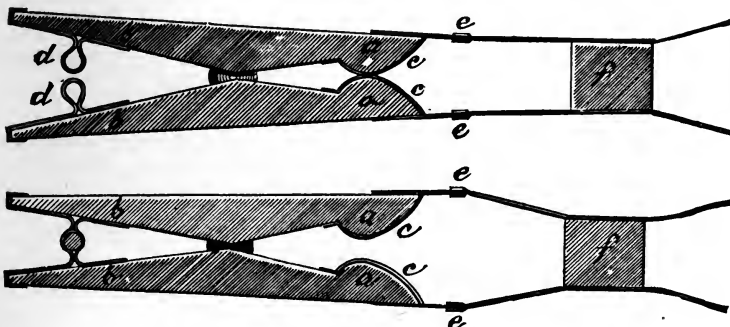

Fig. 2.

Merke has also devised a new electrical contact thermometer for use in determining the temperature of the interior of the disinfecting apparatus. It is constructed as follows: An ordinary wooden spring clamp

(Fig. 2) is faced at the clamping end (*a a*) with metal strips (*c c*). The other end (*b b*) is armed with small strips of metal with two equal-sized openings or rings (*d d*) upon each arm of the clamp. In pressing together this end of the clamp the rings should exactly dovetail into each other. Through the short tube thus formed by the rings, a small rod of fusible metal, made by melting together 8 parts of bismuth, 3 parts of lead, and 3 parts of tin, is inserted. This constitutes the thermometer. To the metal facings of the other end of the clamp conducting wires are attached, which connect it with an electrical alarm bell. The wires are kept from getting entangled in the clamp by a square block of wood (*f*), to which the wires are attached. The whole apparatus is now enclosed in a hollow wooden capsule, with numerous openings in its sides to permit access of steam, and placed in the centre of the package of articles to be disinfected. When the temperature in the centre of the package, or around the thermometer, reaches 100° C. (212° F.), the metal rod melts, the spring comes into play and closes the clamp. The two metal surfaces (*c c*) coming in contact close the circuit, and the electric bell rings to indicate the temperature. This thermometer is cheap, and not liable to get out of order. By placing a number of them in different parts of the disinfecting apparatus, and connecting each one with an electric circuit, the exact time at which the temperature of 100° C. is reached in each portion of the apparatus can be exactly determined.

This contact thermometer can also be used without the electric circuit. If introduced with the articles to be disinfected, and the rods are found to have been melted after exposure, it indicates that the temperature of 100° C. has been reached.

#### DISINFECTION BY CHEMICAL AGENTS.

In the latest instructions issued by the Berlin health authorities, all disinfectants are discarded except heat and carbolic acid. The latter is used in five per cent. solution for fecal and urinary excreta, expectoration, nasal discharges, etc., and in two per cent. solution for articles of clothing, bedding, and wiping cloths used about the sick-room. These articles are directed to be soaked for twenty-four hours in the two per cent. carbolic acid solution, then boiled for half an hour, and afterward washed in water with half an ounce of soft soap to the gallon. Leather articles (boots, shoes, etc.) are washed in five per cent. solution of carbolic acid. Articles which cannot be washed are sent to the public disinfecting station for disinfection; or, if of little value, are destroyed by burning. To the great surprise of many sanitarians, bichloride of mercury and chloride of lime are not mentioned in the Berlin instructions.

In Boston, mercuric bichloride is generally used as a disinfectant. Dr. S. H. Durgin, a member of the committee on disinfectants and chairman of the board of health of that city, uses a solution of the strength of one part in 3:4000 for spraying the streets. A bag of the salt is hung inside of the street watering-carts, and as it dissolves the water is impregnated with the disinfectant. The rapidity of solution of the salt is regu-

lated by the thickness of the wraps placed around it. The capacity of the water-tank and the number of times it is filled during the day, together with the weight of the mercuric bichloride, give the data for finding the strength of the solution.

In Chicago, the solution of the bichloride is freely used in yards, cellars, gutters, etc. Watering-pots with fine sprinklers are used to scatter it over the surfaces where it is required.

Guttman and Merke have studied the methods of disinfecting apartments after infection by infectious diseases. Many experiments were made, using a five per cent. solution of carbolic acid and a 1 : 1000 solution of mercuric bichloride. The latter was found to be the most efficient, and always trustworthy. The method decided upon as the best is the following: The floor of the room is first saturated with a solution of mercuric bichloride (1 : 1000), and then a spray of the same solution directed against the walls and ceiling until these are thoroughly moistened, which is manifested by the formation of small drops. The floor is then mopped dry, and afterward washed up with clean water. Finally, the walls and ceiling are again sprayed with a one per cent. solution of soda. This causes the formation of oxychloride of mercury, which is brushed off when dry. By this subsequent treatment, all danger of mercurialization of the occupants of the room is removed. The proceeding seems to be rational, cheap, and more efficient than any other hitherto used.

Heræus and Kreibohm experimented with volatilized mercuric bichloride and sulphur in combination (following one fumigation by the other), but failed to secure disinfection of the walls and contents of the room. The method seems to be untrustworthy, and to have nothing in its favor.

The method of disinfecting the bilge of ships has been studied by Koch and Gaffky. A solution of mercuric bichloride was employed, using a sufficient quantity to produce the copper reaction when thoroughly mixed with the bilge water. At the end of eighteen hours the disinfection was complete, as shown by bacteriological tests. The solution is poured into the bilge, and a thorough mixing secured by pumping. No injury results to the ship or her occupants from this treatment. The pump used becomes "infected" with mercury, however, and should not be employed afterward for pumping water for drinking or domestic purposes. This caution, which is given by the authors, seems hardly necessary, as no one would think of drinking bilge water under any circumstances, and the bilge pump is generally a fixture on vessels.

The disinfection of stables is an important part of the prophylaxis of the contagious diseases of animals. Dr. Hugo Plaut, of Leipzig, recommends the following procedure: A wooden structure equally divided into two apartments by a partition is to be built before the main stable door. A door is placed in the partition wall, allowing communication between the two apartments, and one door is to open externally. The outer apartment serves as a receptacle for the clothing worn outside of the stable, while the inner one contains the stable dress. When the

attendant enters, he undresses in the outer apartment, then passes through the communicating door into the inner apartment, where he dresses in the stable clothes. When he leaves the stable, he removes his stable dress in the inner apartment, washes his hands and feet, steps through the door into the outer apartment, and resumes his ordinary clothing.

The air of the interior of the stables should be kept saturated with moisture, in order to lessen the mobility of disease germs. When a stable is infected, all animals in it are to be removed, and kept under observation. Before removal they are to be well cleaned, and their hoofs washed in a disinfectant solution.

The stables are then cleaned, and all floors, walls, and partitions scrubbed with water, after which they are to be sprayed with a solution of mercuric bichloride (1 : 500). After several hours' exposure to the action of the bichloride, the excess of this salt may be rendered innocuous by spraying all surfaces with a saturated sulphuretted hydrogen water, diluted with ten parts of water. A simple lime wash would probably answer equally well.

Laplace has found that by adding an acid to a solution of mercuric bichloride or carbolic acid the germicide power of the latter is much increased. A two per cent. solution of carbolic acid, to which one half per cent. of hydrochloric acid has been added, will destroy the spores of anthrax, while without the addition of the hydrochloric acid the carbolic acid is inefficient for the destruction of these spores in five per cent. solution. Tartaric acid acts in a similar manner when added to the disinfectant.

## THE QUARANTINE SYSTEM OF LOUISIANA.—METHODS OF DISINFECTION PRACTISED.

BY JOSEPH HOLT, M. D., PRESIDENT BOARD OF HEALTH, STATE OF LOUISIANA.

In describing the methods of disinfection used in the quarantine of Louisiana, it is necessary first to examine the system itself synthetically.

There are three maritime approaches to New Orleans,—the Mississippi river, which is the central and main avenue; the Rigolets, thirty miles to the eastward, a narrow strait connecting Lake Pontchartrain with Lake Borgne and the Gulf of Mexico; and the Atchafalaya river near its debouchment into the bay of that name and Mexican Gulf, eighty-two miles to the westward.

On account of the character of shipping coming through the two lateral approaches, “light in tonnage and mostly from domestic ports,” the Rigolets and Atchafalaya are completely closed by a proclamation of forty days’ detention against all vessels from quarantined ports, compelling such to seek the Mississippi as the only available route to New Orleans. This is done in order to avoid the immense expense of keeping up three completely equipped stations, and to concentrate at a single point the fight against infection.

The quarantine in the Mississippi is a system composed of three stations, the first of which is an advance guard inspection station, situated at Port Eads, one hundred and ten miles below New Orleans, where the waters of South Pass are jettied into the Gulf.

When an inward bound vessel comes into the offing, she is immediately boarded by a thoroughly skilled medical officer, and a careful inspection is made of her sanitary record and present condition. If from a non-quarantined port, and all is well, she is given pratique and goes on to the city. If from a quarantined port, but presenting a clean health-record of voyage, and no evidence of sickness of a dangerous or doubtful character, she proceeds to the upper quarantine station, situated on the left bank of the river, seventy miles below the city, where she is subjected to a full course of sanitary treatment, and is detained such length of time, not exceeding five days (except in rare instances, wherein further observation may be deemed necessary), as the board of health may provide.

If, upon inspection of a vessel entering the river, she is found to be foul,—that is, showing positive or suspicious evidences of infection, either in a person then ill or in a foul health-record of voyage,—she is at once remanded to the lower station, located on Pass à L’Outre, an unused outlet of the Mississippi, one hundred and three miles below the city. The sick, if any, are at once removed to the hospital, where every provision has been made for them. The vessel, with the well on board, is dropped down-stream a few hundred yards and anchored. In the mean-

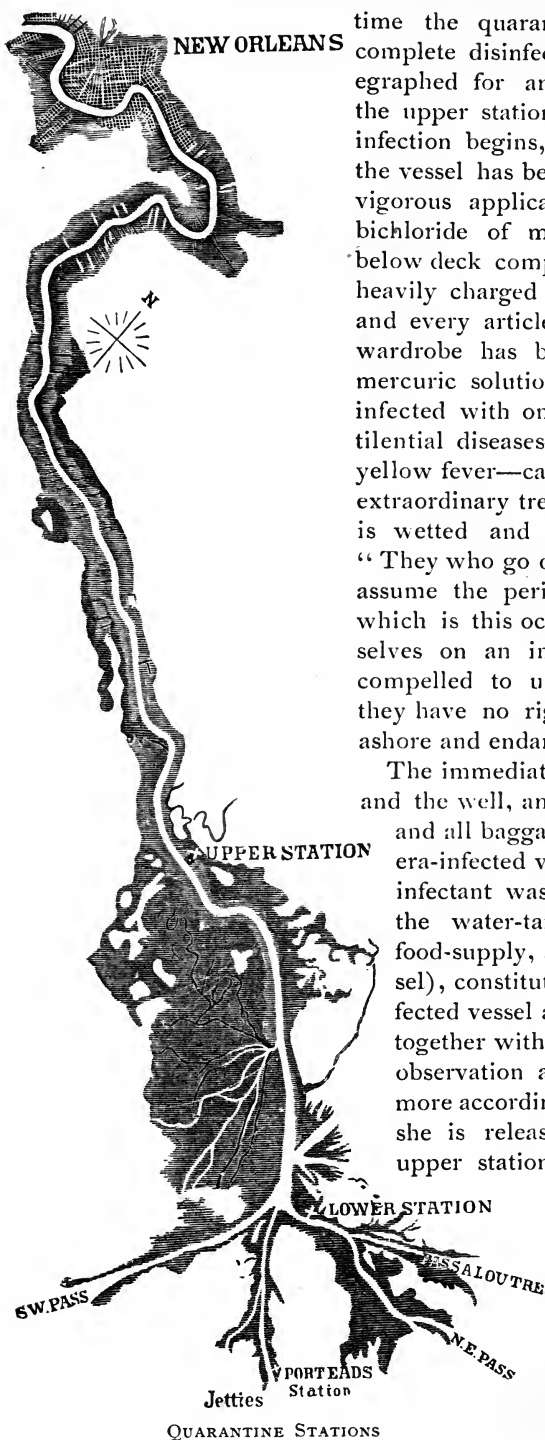

QUARANTINE STATIONS

time the quarantine tug-boat, with its complete disinfecting outfit, has been telegraphed for and speedily arrives from the upper station, when the work of disinfection begins, and does not cease until the vessel has been subjected to the most vigorous application of the solution of bichloride of mercury, her atmosphere below deck completely replaced with one heavily charged with sulphurous oxide, and every article of baggage and ship's wardrobe has been saturated with the mercuric solution. A ship known to be infected with one of the three great pestilential diseases—small-pox, cholera, or yellow fever—can stand and must endure extraordinary treatment, even if clothing is wetted and some articles damaged. "They who go down to the sea in ships" assume the perils of the voyage, among which is this occurrence of finding themselves on an infected vessel and being compelled to undergo a cleansing; for they have no right to bring their perils ashore and endanger others.

The immediate segregation of the sick and the well, and disinfection of the ship and all baggage (in the case of a cholera-infected vessel extended to the disinfectant washing-out and refilling of the water-tanks, destruction of the food-supply, and revictualling the vessel), constitute the treatment of an infected vessel at this station. The ship, together with all on board, is held for observation a period of ten days or more according to circumstances, when she is released and proceeds to the upper station, where the processes of sanitary treatment are repeated, with the addition of the use of moist heat applied to baggage, ship's apparel, etc. (which latter process will be described hereafter), and the vessel is then allowed to proceed to the city.

This course of treatment at the upper station, while probably unnecessary, is enforced purely as an extraordinary precaution. Inasmuch as infected ships are the exceptions, but inasmuch also as the board of health will take no risk in the case of vessels from known infected or suspected ports, regardless of bills of health, the vast majority of vessels are treated at the upper station. Arriving at this station the vessel is brought alongside the wharf. All on board, officers, crew, and passengers, are at once sent ashore, where they find ample accommodation in commodious shelter provided for their entertainment during the time occupied in the sanitary treatment of the ship and all baggage. As soon as this is completed they are permitted to return aboard ship, where they remain under observation during the prescribed period, determined by the remoteness or nearness of the port against which these precautions are taken. The object of this brief detention for observation, after the sanitary treat-

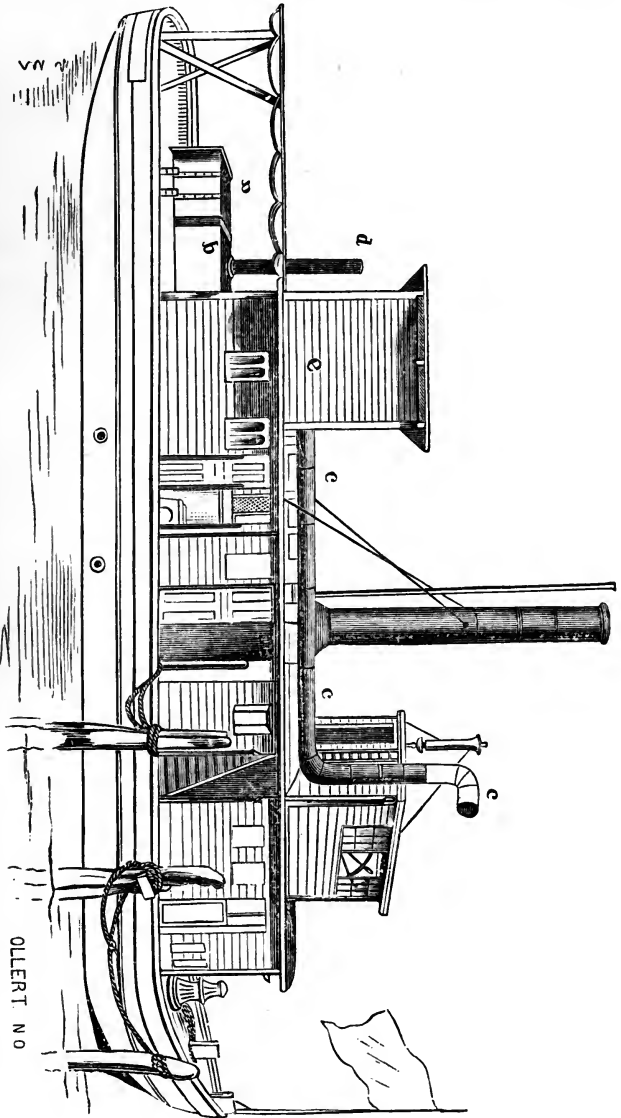

(PLATE I.) TUG-BOAT WITH FUMIGATING APPARATUS.

- a.* Furnace. *b.* Reservoir for reception of gas. *c.* Discharge pipe conveying gas to ship's hold. *d.* Escape for gas when fan is at rest and sulphur is burning; closed by a valve when fan is in motion. *e.* House protecting from weather the machinery for driving fan and containing accelerating gearing.

ment of the vessel has been completed, is to allow for a probable outbreak of an infectious disease already incubating in the system of any one on board.

As an essential part of the service, there is a tug-boat of sufficient power to move a sailing vessel to or from the wharf. In addition to this requirement, this boat is equipped with a complete outfit for generating and applying germicidal gas for displacement of the entire atmosphere within the ship, transported, perhaps, directly from some infected port. In the hold of this tug is constructed a wooden tank of 2,000 gallons' capacity, to hold the bichloride of mercury solution for the treatment of vessels in the lower quarantine, as described. This tank is furnished with a steam pump (made of iron on account of the greater resistance of that metal to amalgamation) supplied with three-quarter-inch rubber hose. (See plate 1.)

In the sanitary treatment of a vessel in quarantine there are three processes of disinfection currently applied.

#### APPLICATION OF BICHLORIDE OF MERCURY.

The first is the wetting of all available surfaces of the vessel, excepting cargo, but including bilge, ballast, hold, saloons, forecastle, decks, etc., with a solution of the bichloride of mercury, made soluble by an equal weight of muriate of ammonia, in the proportion of 1 : 1,000 of water.

The idea of using this agent as a disinfectant in "municipal and maritime sanitation" suggested itself to me while reading the chapter on "Wound Disinfection—Antiseptics," in the volume entitled "The Treatment of Wounds," by Lewis S. Pilcher, M. D., containing an account of the experiments of Dr. George M. Sternberg, with a table of chemical agents and their relative germicidal strengths (at the head of which stands the bichloride of mercury), and also a table of the results obtained by Koch in Berlin, 1881, and by Schede and Kümmler in the Hamburg General Hospital in the same year.

The board of health immediately endorsed the idea, and ordered the adoption of the bichloride of mercury, as explained in the following letter:

NEW ORLEANS, July 17, 1884.

*Dr. Thomas Y. Aby, Resident Physician Mississippi Quarantine Station:*

DEAR SIR: Because of the signal failure of carbolic acid as a disinfectant and prophylactic agent after a trial more fair and extended than has ever been allowed any other; because of its excessively offensive odor and the oppressive and sometimes mischievous effects of its fumes; because of the low order of the commercial acid as a germicide and the considerable expense involved in its use,—you are hereby requested to discontinue its application.

In its stead I have ordered to your station two packages of bichloride of mercury and muriate of ammonia, the latter to act as a solvent.

In its preparation for use, take five and a half ounces of each and dissolve in a half gallon of water; add this to forty gallons of water in a cask. I have sent three large watering-pots, with a fine rose or spray. Your men can quickly wet down a ballast pile



and all available surfaces of a ship, and it needs no repetition when once thoroughly applied.

The advantages of this agent are briefly these: The mercuric bichloride stands pre-eminently above all chemicals as a universal germicide. Not only are definite organisms immediately destroyed, but all protoplasm and albuminoids are devitalized by it. It is efficient to accomplish this work when applied in a solution so weak as not to be recognized except by chemical re-agents. It is devoid of color or smell. It does not poison the air by vaporizing, but adheres in an innocuous form to the surfaces upon which originally applied. Its cost is about one eighth of that of carbolic acid.

I feel that this transition is quite as much of a relief to you, my dear doctor, as to the afflicted people on shipboard, who must surely suffer severely from the stifling fumes emanating from carbolic acid applied to surfaces heated by a July sun, as the people of this city can testify to their terrible cost!

The position of persons confined on shipboard under such circumstances, particularly in the instance of women and children as passengers, as related by yourself, must at times be most distressing. The board of health heartily joins with you in the satisfaction and sense of relief afforded by this change, which is an important step in the great work of humanizing our quarantine.

I remain, with great esteem, yours very truly,

(Signed) JOSEPH HOLT, M. D.,

*President Board of Health, State of Louisiana.*

The bold adoption of this poisonous agent in domestic, municipal, and maritime sanitation at once called forth a flood of most gloomy forebodings of fearful effects upon the human system.

Our declaration at that time is confirmed by an experience of four years' trial on an immense scale, that our standard solution, as used in sanitation, is absolutely harmless to persons unless swallowed, it matters not how extensive or constant the contact. The only objection we have yet discovered is that certain articles, particularly blankets and flannels, treated by the solution, sometimes becomes spotted, and colors liable to "run" when wetted, suffer; but unlike all other chemical agents applied as disinfectants, the textile itself is in nowise injured.

Recapitulating its merits: Being colorless, stainless (except as stated), odorless, not injurious to fabrics, perfectly safe to handle for months at a time, easily applied, and exceedingly cheap, it is impossible to imagine a substance more efficient, and as free from objection in practice. It is indeed the key unlocking difficulties otherwise insurmountable, and rendering practicable in municipal and maritime sanitary work the efficient execution of scientific requirement.

The amalgamating powers of the mercuric salt presented many serious obstacles in the contrivance of an apparatus for its application, all of which have been overcome without sacrificing simplicity, efficiency, or economy.

Immediately adjoining the quarantine wharf and near its water edge is constructed a heavy framework of piles, each twelve inches in diameter. This structure has an ample base, is pyramidal, and forty-five feet in height above mean level of the river. On top of this is a circular

wrought iron tank, capable of holding eight thousand gallons of the mercuric solution. (See plate.)

In order to prevent contact of the latter with the iron, the interior of the tank is painted over with three coats of red lead and two of paraffine paint. The top of the tank is closed by a secure cover to prevent access of light to the solution. This, together with the general exterior, is painted black. On the top of this cover is placed centrally a sixty gallon wooden cask, in which is dissolved the mercuric salt, which is then emptied into the tank through a wooden faucet. Seventy pounds are used for one charge.

In the tank near the lower edge are three heavy galvanized iron faucets, to each of which is screwed a lead of three-quarter-inch, four-ply rubber hose, the farther ends of which lie on the wharf. These are lengthened by additional sections to reach any part of the largest vessel. To the far extremity of each hose is attached a short, wide nozzle, provided with a stop-cock. During disinfection all three are simultaneously used, fore, aft, and amidship. For spraying we use a perforated, heavy black-tin rose, four inches across the face, similar to an ordinary watering-pot spray. These are made with a shank about six inches long, to fit snugly into the open end of the pipe. On a single vessel we averaged fifteen hundred gallons of solution, but often used three thousand. The process requires from thirty minutes to two hours, according to circumstances.

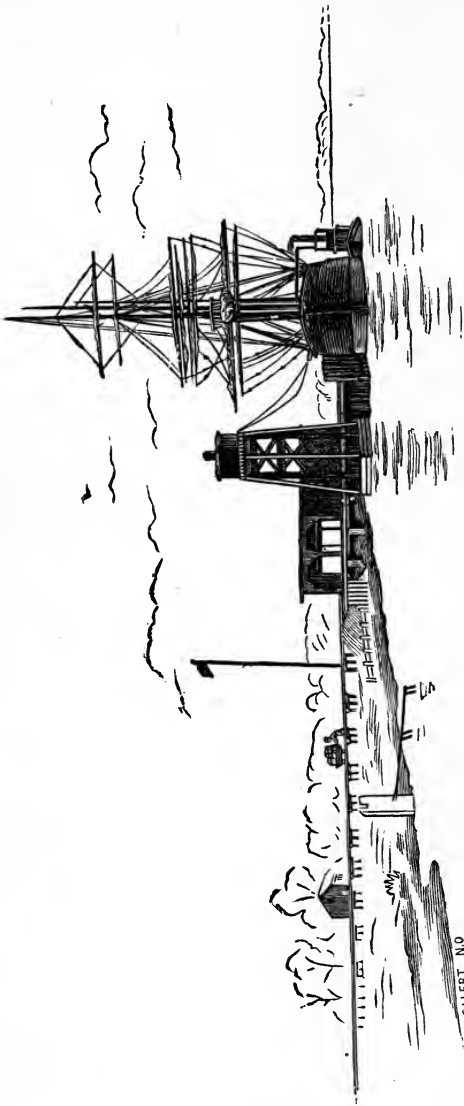

(PLATE 2.)

View of disinfecting wharf, showing tug fumigating vessel; elevated tank containing 8,000 gallons of bichloride of mercury solution, 3 leads of hose from tank to ship. Gangway leading to building containing super-heating chamber.

## SULPHUROUS OXIDE FUMIGATION.

As soon as the men have completed the work of "bichloriding" below decks, the fumigating pipe is then extended from the quarantine tugboat lying alongside. (See Plates 1 and 2.) It is lengthened by sections, being fitted together like stovepipe, and conducted down a convenient hatchway to the bottom of the hole or as near the kelson as possible, preparatory to the fumigation of the entire vessel (and cargo if any) with sulphurous oxide. In the case of a sailing ship, one hatchway gives access of the sulphurous gas to the entire hold; but in large steamers the hold is subdivided by bulkheads into two or more distinct compartments, which must be treated separately.

In undergoing treatment the cargo is not disturbed except when the removal of bags of coffee is required to permit the passage of the fumigating pipe, which is twelve inches in diameter, down into the dunnage at the bottom of the cargo.

I have given explicit instructions to coffee importers, whereby the expense of removing bags to make this well or shaft through the cargo may be avoided. It is necessary to have an open, frame-work shaft, allowing a clear inside space of fifteen inches, placed in the centre of the main hatch in a sailing vessel, or in the centre of each hatch in a steamship having bulkhead compartments. The frame-work of this shaft is set before loading, and should be cut flush with the top of the cargo. This simple arrangement avoids all handling and delay.

When the connections are made and the fumigating pipe is arranged, the fan on the tugboat is started and the process of displacing with sulphurous oxide the entire atmosphere within the ship begins. The length of time required to complete the fumigation varies from thirty minutes to three hours, according to size of vessel, number of compartments, etc. The quantity of commercial roll sulphur used varies from one hundred to seven hundred pounds per vessel.

The apparatus invented for rapidly evolving and supplying the germicidal gas consists in a battery of eighteen furnaces, each supplied with a pan to contain the sulphur during combustion. These furnaces open into a common reservoir, to the farther end of which is connected a powerful exhaust fan (Sturtevant's No. 29). (See Plates 3 and 4.)

The gas drawn by the fan is driven into a twelve-inch galvanized iron pipe, through which it is conducted over the side and down the hatchway of the vessel into the bottom of the hold. The gas, as it is driven into the vessel, is quite hot, but would extinguish rather than create fire. The outflow should not impinge directly against bags of coffee or bales of textiles, if it can be avoided, in order to prevent formation of sulphuric acid and some slight injury therefrom at that point. In treating coffee, and for convenience in some other instances, the vertical lead of pipe into the hold is made of abestos cloth, closely and heavily woven for our purpose. Every opening is closely battened during the process, and remains so for at least eight hours after it is discontinued.

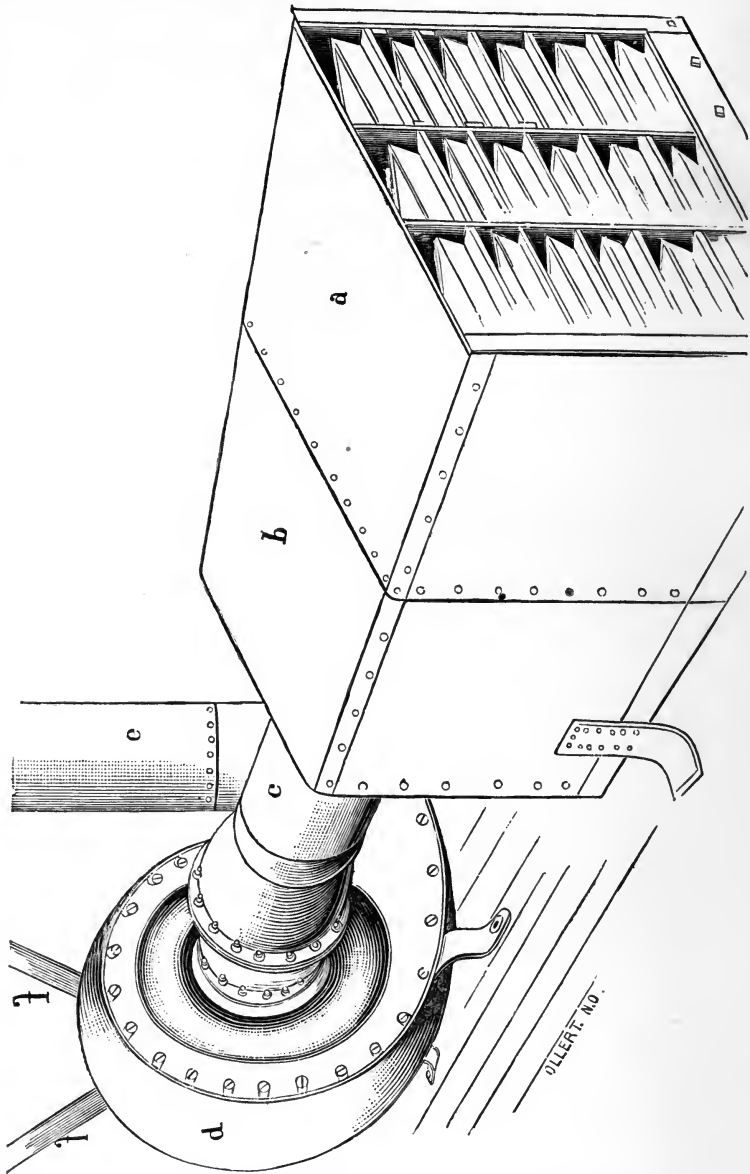

(PLATE 3.) FUMIGATING FURNACE, RESERVOIR, AND EXHAUST FAN.

- a.* Furnace of cast iron,  $\frac{1}{2}$  inch thick; 3 feet wide, 3 feet long, 2 feet high. Upper and lower plates grooved for reception of partitions, and sides shouldered for same, as shown in Plate 4.
- b.* Reservoir, No. 10 iron, same dimensions as furnace.
- c.* Exhaust pipe connecting reservoir and fan.
- d.* Exhaust fan, Sturtevant's No. 29, Medium Planing Mill Exhauster.
- e.* Discharge pipe from fan, made of No. 20 galvanized iron.
- f.* Driving belt.

Height of legs supporting furnace and reservoir, 10 inches. On reservoir at letter (*b*) should be shown a 12-inch opening for escape pipe, as indicated (*d*) Plate 1.

The apparatus throughout is made ample in size and power for rapidity of work and economy in wear and tear, by lessening velocity and friction. The fan is run by a special engine at a slow rate as compared

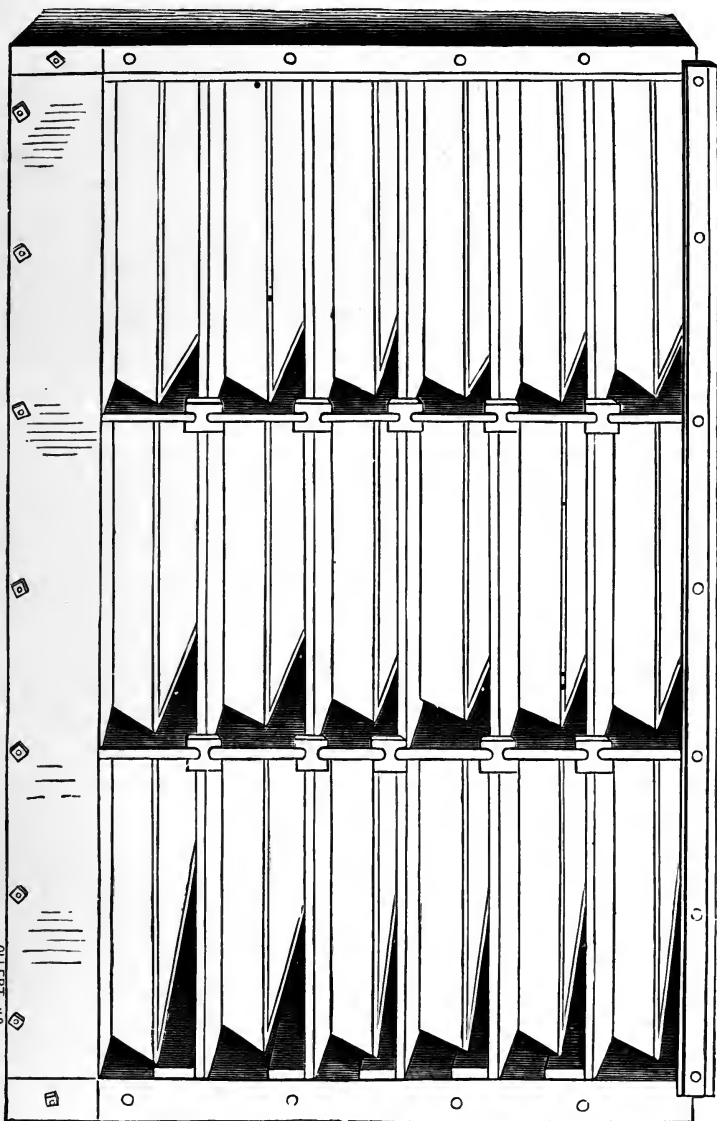

(PLATE 4.) FRONT VIEW OF FUMIGATING FURNACE.

Dimensions of each compartment, 12 x 3½ inches. Pans of cast iron 5-16 inch thick; 1½ inches deep, 11 inches wide, and 2 feet 10 inches long, outside measure. Free space above pan about 1¾ inches.

with its capacity, but driving into the ship 180,000 cubic feet per hour of atmosphere surcharged with sulphurous oxide.

APPLICATIONS OF DRY AND MOIST  
HEAT.

While these two processes of sanitary treatment of the vessel are going on, all bedding, ship's linen, cushions, mattresses, flags, mosquito nets, curtains, carpets, rugs, all personal baggage and wearing apparel of whatever description, are removed from the ship to a commodious building in close proximity (see Plate 5), in which these articles are treated by moist heat at a temperature of not less than 230° Fahrenheit.

The apparatus for this work consists in a steel forty-horse power steam boiler (see Plate 9), for supplying steam to a superheating chamber a few feet distant, and which I will now describe. (See Plates 6, 7, and 8.) The dimensions of this chamber, taken interiorly or inside measure, are 60 feet long, 11 feet wide, and 7 feet high. The framework is composed of 3x3 inch seasoned pine lumber, joined as in the construction of a frame house. Upon the outside of this framework (and corresponding to weatherboarding in the case of a house) is nailed tongued and grooved flooring material three fourths of an inch thick by six inches wide. The inside or interior of the ends, rear, and top of the chamber is ceiled with the same material, and a flooring of the same is also laid. Upon these interior surfaces is tacked heavy "Russian hair-cloth or felting;" and upon this, at intervals of three feet, are nailed parallel strips of wood 1½x2 inches, and, in turn, upon these strips is fastened another sheathing or ceiling of floor-

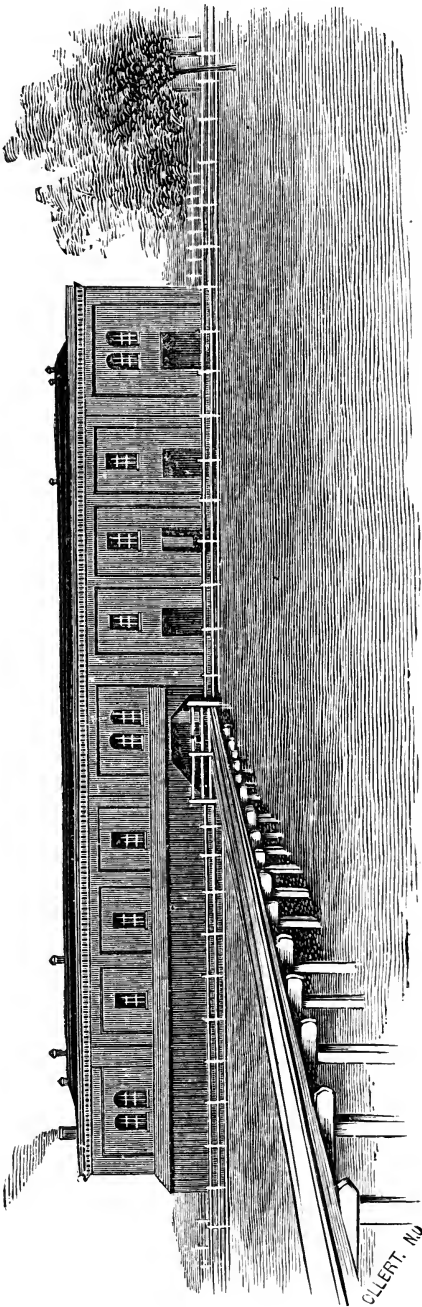

(PLATE 5.)

Brick building in which is located the superheating chamber; gangway in front connecting with disinfecting wharf.

ing plank, as already described. This secures an air space between the hair-cloth and the inner ceiling. Upon this now smooth interior surface of wood is finally tacked and held in place by very broad-headed

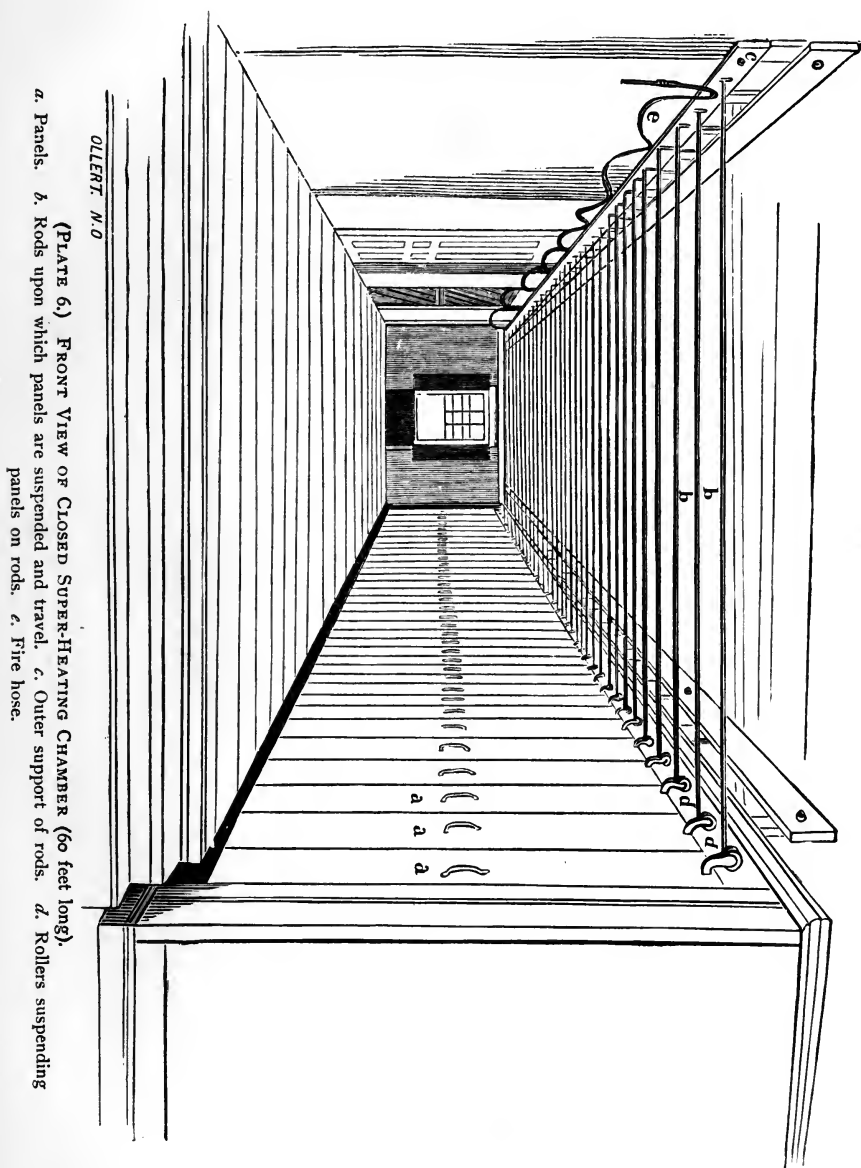

(PLATE 6.) FRONT VIEW OF CLOSED SUPER-HEATING CHAMBER (60 feet long).

*a.* Panels. *b.* Rods upon which panels are suspended and travel. *c.* Outer support of rods. *d.* Rollers suspending panels on rods. *e.* Fire hose.

nails, or better, by nails supplied with tin discs or washers, a double layer of "Asbestos Building Felt," well lapped and securely tacked, thus rendering the interior of the chamber fire-proof.

By the foregoing described construction, it will be seen that the walls of the chamber, which are eight inches in thickness, consist of seven non-conducting media: First, the outer layer of planking; second, three inches of air space; third, an inner ceiling of planking; fourth, one inch thickness of "Russian hair-cloth;" fifth, one and a half inch air space; sixth, a third layer of three fourth inch planking; seventh, a double layer, or interior lining, of heavy asbestos felting.

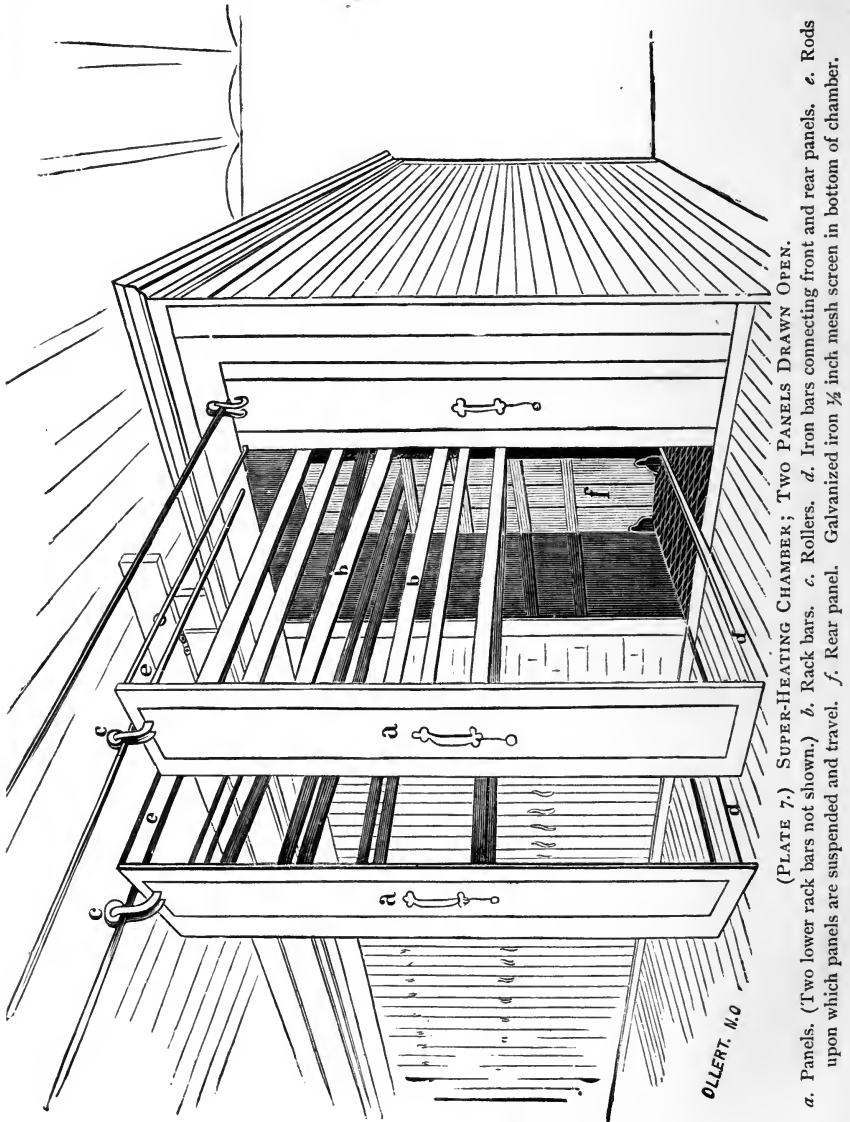

The front wall is divided into forty panels, eighteen inches wide each (see Plate 6), which represents that number of racks contained within



the chamber. Upon the bars of these racks the clothing, etc., is hung for exposure to disinfection by moist heat. (See Plate 7.) These racks are constructed with a front and rear panel united by horizontal bars, six to each side. Each rack is suspended overhead, on travelling rollers, upon an iron rod which extends from the rear wall of the chamber to a support ten feet in front of the chamber, the rod, therefore, being twenty feet in length. By this arrangement overhead the racks may be drawn out and pushed in with facility, thus avoiding tracks or rods on the floor obstructing the movements of employés. When drawn out the full length of ten feet, the rear panels of the racks securely close the chamber, as do the front panels when the racks are pushed in, thus admitting of the heating of the chamber during the time of hanging the articles of clothing, etc., on the rack-bars preparatory to disinfection.

For this admirable device, and, indeed, for the entire skeleton of the superheating chamber, including the dry heat double steam coils, we are indebted to the Troy Laundry Machinery Company, Chicago, Ill. We found the purchase of this apparatus, constructed to include certain of our specifications, to be the most economical and satisfactory we could have desired. The interior surface of each panel is lined with a layer of Russian hair-cloth, over which is applied a double layer of asbestos felting. At intervals of seven and a half feet a bulkhead of one inch tongued and grooved flooring is constructed, subdividing the chamber into eight compartments. These bulkheads or partitions are made fire-proof by a covering of a double layer of asbestos felting. The object of this arrangement is to provide against the spread of fire in the event of its occurrence. In addition to this provision, there is a double lead of one inch fire hose connected with a steam pump near the boiler, and at all times ready, within fifteen seconds' notice, to turn on two streams of water upon any rack on which fire might have originated.

These minute specifications concerning provision against fire are particularly appreciated by ourselves: it cost us two fires and the destruction of a large amount of property to learn a lesson which experience alone could teach. Lacking experience and precedent, these accidents could not have been foreseen, and therefore could not have been provided against. They were the result of an underrating, and failure to appreciate the prodigious force the contrivance invented placed at our will to invoke. Under the present arrangement, including early use of free steam, fire is hardly possible; but if it should occur, we are prepared to draw out instantly the burning panel, to strip it of clothing, and to put out the fire. With reasonable care and watchfulness on the part of the employés, there need be absolutely no danger of loss by fire.

The superheating of this chamber is so provided as to furnish at will dry or moist heat, or both; and by a turn of the hand a temperature of 300° F. can be obtained. Within and at the end of this chamber, next to and connected with the boiler, are two manifolds, one above the other, to which is connected a system of forty-five three quarter inch steam pipes (aggregating 5,509 lineal feet), placed horizontally near the floor

of the chamber, running its full length, and supplied with a "bleeder" for conveying off the water of condensation. This double coil furnishes the dry heat. (See Plate 8.) Above and in close proximity to this system of pipes is extended a horizontal screen of galvanized iron, one half inch mesh, to catch and so prevent the coming in contact with the super-heating pipes any article falling from the racks. (See Plate 7.)

The moist heat is supplied by a one inch steam pipe laid centrally in the midst of the above described dry heat pipes, and running the entire length of the chamber, constituting a steam-main, connected with the boiler, and controlled, as the others, by a ball valve on the outside. This pipe is perforated by eighty one-twelfth inch holes, so placed as to furnish steam to each rack.

During the time of hanging the articles of clothing, etc., on the racks, the dry heat is turned on, and the temperature raised to about  $190^{\circ}$  F.,

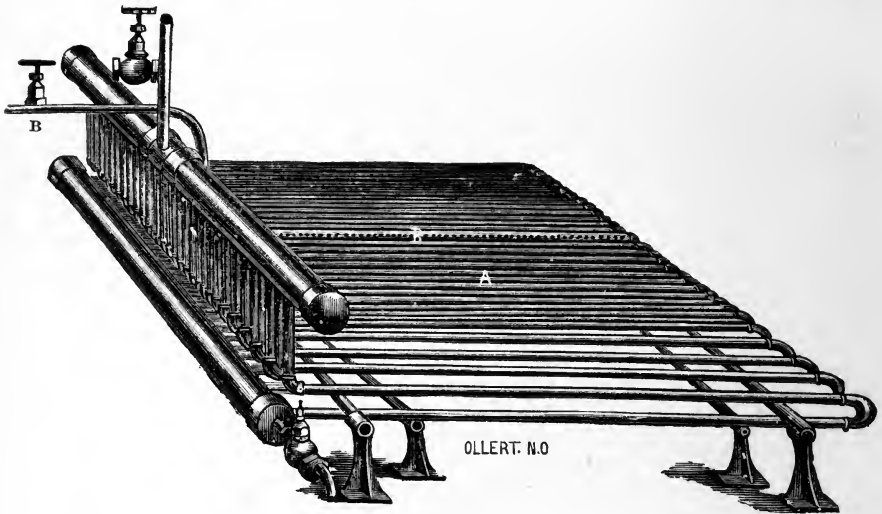

(PLATE 8.)

Super-heating steam coil for dry heat. *l-b.* Perforated steam pipe for moist heat.

made known by a thermometer having a large mercurial column, and suspended near the centre of the chamber, working on a slide or travelling rod in such a manner, when it is desired to make a reading, as to allow of being drawn forward (by a cord extending outside) to a long, narrow pane of glass set in the panel. This thermometer should have a scale of at least  $275^{\circ}$  F. As each rack is filled it is put back into place. By the time the last of the articles have been hung on the racks, the entire mass of the material within the chamber has attained a temperature between  $190^{\circ}$  and  $200^{\circ}$  F., when free steam is turned on; the thermometer speedily rises to a point varying between  $230^{\circ}$  and  $240^{\circ}$  F., at which it is maintained for a period of twenty minutes.

The steam pressure in the boiler, at the beginning of this process, reg-

isters between 100 and 110 pounds by the steam gauge; at the end of the process of blowing in steam the pressure will have fallen to about sixty pounds. The steam is now entirely cut off from the chamber, the racks are drawn out, and their contents removed. During the process of

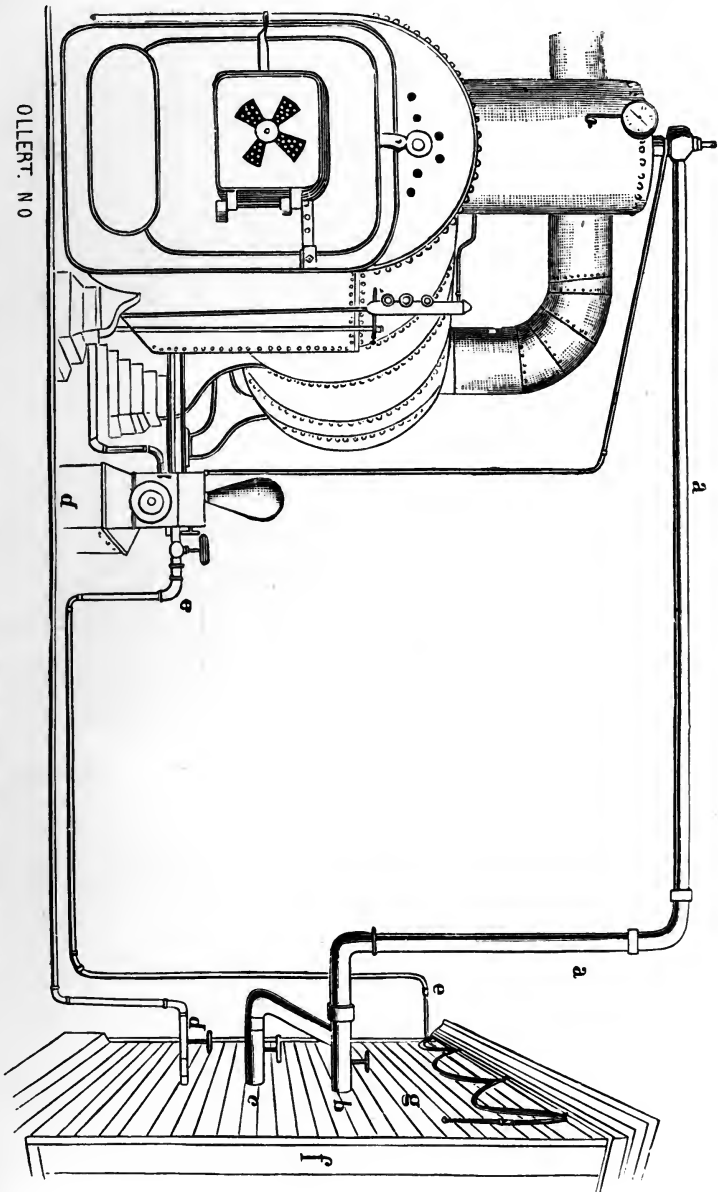

(PLATE 9.) BOILER AND STEAM CONNECTION WITH SUPER-HEATING CHAMBER.

- a. Steam-main from boiler.
- b. Pipe supplying dry heat.
- c. Pipe supplying moist heat.
- d. Bleeder.
- e. Pipe from pump, supplying fire hose.
- f. Front of chamber.
- g. End view of chamber.

steaming, every article is perceived to be saturated and intensely hot, the steam freely permeating to the interior of mattresses, double blankets,

etc. ; but so great is the heat in the texture of the fabrics as to immediately expel all moisture upon drawing the racks and exposure to the open air. Shirts, collars, etc., instantly assume the crisp dryness they possessed before exposure, losing the musty smell of long packing in a trunk. Silks, laces, and the most delicate woollen goods show no signs of injury whatever from the treatment. Of course, articles of leather, rubber, and whalebone would be injured by the heat, and are therefore disinfected with the mercuric solution, and not permitted to go into the heated chamber. Time required to charge chamber with apparel for disinfection, thirty minutes ; time required for moist heat, twenty minutes ; for removal of articles, fifteen minutes ;—a total of sixty-five minutes. A large steamship, particularly a passenger vessel, may require two or three charges of the chamber. Amount of coal consumed, from two to four barrels per vessel.

In the summer of 1885, we devised and put up a chamber of the above general plan, but wholly inadequate as to size for the requirements of our service. This was replaced by one operating on the same principle, but fifty feet long and supplied with a twenty horse-power boiler, which latter proved too small for rapid work. This apparatus was burned last spring. Our present chamber and supply boiler are of the dimensions given in the appended plates. We prepared the plans of the foregoing described apparatus during the summer of 1884. Obtaining a liberal appropriation of \$30,000 from the state legislature for the avowed purpose of establishing a new system of quarantine through the elaborations of purely experimental work, and thoroughly endorsed and sustained in all our efforts by the press of New Orleans and by the merchants, we put the new system into practical operation, and threw open the Mississippi to commerce June 10, 1885. As it stands to-day, we sincerely believe in a nearly perfected state, it is the consummation of experimental effort, through a long and tedious process, beset with difficulties of the most perplexing and often disheartening kind. Without precedent, having to deal with natural forces of prodigious power, repeatedly encountering unexpected difficulties, meeting with accidents, obliged continually to devise improvements upon our several inventions, and continually combating a surly discontent and sometimes violent opposition from those subjected to the sanitary processes, while these were still in an imperfect and unsatisfactory stage of development, the modernizing of quarantine, and bringing it into line with other branches of science and art in the general progress, has been an expensive and difficult task.

We submit to your honorable committee the foregoing plans and specifications of the "System of Quarantine" established by the state of Louisiana, in order to place the results of our experience in the hands of those who, like ourselves, are compelled to resist pestilential invasion by maritime quarantine. We do this, encouraged by the hope that others may find in these results matter worthy of consideration, and beneficial in strengthening their defences against a common enemy.

THE FOLLOWING ARE THE REQUIREMENTS IMPOSED UPON ALL VESSELS ARRIVING AT THE QUARANTINE STATIONS IN THE STATE OF LOUISIANA, DURING THE QUARANTINE PERIOD, BEGINNING ABOUT MAY 1ST AND ENDING OCTOBER 31ST.

All vessels arriving at the several quarantine stations in the state, together with their crews, passengers, and their cargoes, shall be subjected to the inspection of the quarantine officers at the said stations. All vessels, together with their cargoes, crews, passengers, and baggage, arriving at the Mississippi Quarantine Station from intertropical American and West Indian ports, shall be subjected to thorough maritime sanitation, according to the following schedule :

First Class—Vessels arriving from non-infected ports.

Second Class—Vessels arriving from suspected ports.

Third Class—Vessels arriving from ports known to be infected.

Fourth Class—Vessels which, without regard to port of departure, are infected; that is to say, vessels which have yellow fever, cholera, or other contagious or infectious diseases on board at time of arrival, or have had same on voyage.

Vessels of the first class to be subjected to necessary maritime sanitation at the Upper Quarantine Station, without detention of either vessels or persons, longer than may be necessary to place such vessels in perfect sanitary condition.

Vessels of the second and third classes to undergo the same conditions, together with detention for observation for a period of five (5) full days from hour of arrival in quarantine.

Vessels of the fourth class to be remanded to the Lower Quarantine Station, there to undergo sanitation and detention of vessels and persons such length of time as the board of health may order.

The five days' detention, as above provided, shall apply to all ports of the Gulf of Mexico and the Caribbean Sea, exception being made in regard to vessels coming from ports south of the Equator, whose period of detention shall be three (3) days.

All vessels arriving from Mediterranean or other ports known or suspected to be infected with cholera, or which may hereafter become infected, shall be subjected to maritime sanitation and such detention as the board of health may determine.

Vessels arriving from the above named ports and places, and belonging to the second, third, or fourth class, as set forth in the foregoing schedule, shall not be allowed to pass the Rigolets or Atchafalaya Quarantine Stations, or other state quarantine stations which may hereafter be established, without having undergone a period of detention of forty (40) days, and thorough cleansing and disinfection.

SPECIAL SUGGESTIONS TO OWNERS, AGENTS, MASTERS OF VESSELS,  
AND PASSENGERS.

The Louisiana State Board of Health recommends the following suggestions to agents, owners, masters of vessels, and passengers, for the

purpose of facilitating the work of quarantine officers, and reducing the period of detention to a minimum :

1. That vessels should be stripped during the quarantine season of all woollen hangings, carpets, curtains, and such like materials, and upholstered furniture, so far as practicable. Hair or moss mattresses to be replaced by wire or wicker beds.

2. That, so far as possible, vessels trading with tropical ports should be manned with acclimated crews.

3. Masters of vessels, ship and consular agents, are earnestly requested to instruct passengers from quarantinable ports to dispense, so far as possible, with baggage which may be injured by wetting, in case of pestilential outbreak on board, while undergoing disinfection. Such passengers are especially warned against bringing silks, laces, velvets, and other fabrics of delicate texture. as they will be compelled to assume all risks of injury.

4. While in ports infected with yellow fever, vessels should be anchored out in the harbor when this is possible, and the crew prohibited from going ashore, especially at night.

5. When practicable, cargoes should be loaded in such a manner as to allow access to the pumps, and also to enable the quarantine officials to pump out and wash the bilge.

6. Special attention should be given to cleanliness of vessels and persons, and provision should be made for all possible ventilation of the entire vessel. The best disinfectants and instructions for using same can be obtained by application to the board of health, or any of its officers.

7. Masters should, before arrival, see that the bilge is thoroughly pumped out and cleansed, and that the entire vessel be put in such good sanitary condition as to permit of the least possible detention. Fruit vessels particularly should be kept thoroughly cleansed, for the purpose of avoiding delay at the Quarantine Station.

8. Vessels observing the above recommendations will receive special consideration at the quarantine station, detention and cost of cleaning, disinfecting, etc., being materially lessened thereby.

## CONCLUSIONS.

The experimental evidence recorded in this report seems to justify the following conclusions:

The most useful agents for the destruction of spore-containing infectious material are,—

1. *Fire.* Complete destruction by burning.
2. *Steam under pressure.* 105° C. (221° Fahr.) for ten minutes.
3. *Boiling in water* for half an hour.
4. *Chloride of lime.*<sup>1</sup> A 4 per cent. solution.
5. *Mercuric chloride.* A solution of 1 : 500.

For the destruction of infectious material which owes its infecting power to the presence of micro-organisms not containing spores, the committee recommends,—

1. *Fire.* Complete destruction by burning.
2. *Boiling in water* for ten minutes.
3. *Dry heat.* 110° C. (230° Fahr.) for two hours.
4. *Chloride of lime.* A 2 per cent. solution.
5. *Solution of chlorinated soda.*<sup>2</sup> A 10 per cent. solution.
6. *Mercuric chloride.* A solution of 1 : 2,000.
7. *Carbolic acid.* A 5 per cent. solution.
8. *Sulphate of copper.* A 5 per cent. solution.
9. *Chloride of zinc.* A 10 per cent. solution.
10. *Sulphur dioxide.*<sup>3</sup> Exposure for twelve hours to an atmosphere containing at least 4 volumes per cent. of this gas in presence of moisture.

The committee would make the following recommendations with reference to the practical application of these agents for disinfecting purposes:

## FOR EXCRETA.

(a) In the sick-room :

1. Chloride of lime in solution, 4 per cent.

In the absence of spores :

2. Carbolic acid in solution, 5 per cent.
3. Sulphate of copper in solution, 5 per cent.

(b) In privy vaults :

1. Mercuric chloride in solution, 1 : 500.<sup>4</sup>
2. Carbolic acid in solution, 5 per cent.

<sup>1</sup> Should contain at least 25 per cent. of available chlorine.

<sup>2</sup> Should contain at least 3 per cent. of available chlorine.

<sup>3</sup> This will require the combustion of between 3 and 4 lbs. of sulphur for every 1,000 cubic feet of air space.

<sup>4</sup> The addition of an equal quantity of potassium permanganate as a deodorant, and to give color to the solution, is to be recommended.

(c) For the disinfection and deodorization of the surface of masses of organic material in privy vaults, etc. :

Chloride of lime in powder.

FOR CLOTHING, BEDDING, ETC.

(a) Soiled underclothing, bed-linen, etc. :

1. Destruction by fire, if of little value.
2. Boiling for at least half an hour.
3. Immersion in a solution of mercuric chloride of the strength of 1 : 2,000 for four hours.
4. Immersion in a 2 per cent. solution of carbolic acid for four hours.

(b) Outer garments of wool or silk, and similar articles, which would be injured by immersion in boiling water or in a disinfecting solution :

1. Exposure in a suitable apparatus to a current of steam for ten minutes.
2. Exposure to dry heat at a temperature of 110° C. (230° Fahr.) for two hours.

(c) Mattresses and blankets soiled by the discharges of the sick :

1. Destruction by fire.
2. Exposure to super-heated steam, 105° C. (221° Fahr.) for ten minutes.

(Mattresses to have the cover removed or freely opened.)

3. Immersion in boiling water for half an hour.

FURNITURE AND ARTICLES OF WOOD, LEATHER, AND PORCELAIN.

Washing, several times repeated, with,—

1. Solution of carbolic acid, 2 per cent.

FOR THE PERSON.

The hands and general surface of the body of attendants of the sick, and of convalescents, should be washed with,—

1. Solution of chlorinated soda diluted with nine parts of water, 1 : 10.
2. Carbolic acid, 2 per cent. solution.
3. Mercuric chloride, 1 : 1,000.

FOR THE DEAD.

Envelop the body in a sheet thoroughly saturated with,—

1. Chloride of lime in solution, 4 per cent.
2. Mercuric chloride in solution, 1 : 500.
3. Carbolic acid in solution, 5 per cent.

FOR THE SICK-ROOM AND HOSPITAL WARDS.

(a) While occupied, wash all surfaces with,—

1. Mercuric chloride in solution, 1 : 1,000.
2. Carbolic acid in solution, 2 per cent.



(*b*) When vacated, fumigate with sulphur dioxide for twelve hours, burning at least three pounds of sulphur for every 1,000 cubic feet of air-space in the room; then wash all surfaces with one of the above-mentioned disinfecting solutions, and afterward with soap and hot water; finally throw open doors and windows, and ventilate freely.

#### FOR MERCHANDISE AND THE MAILS.

The disinfection of merchandise and of the mails will only be required under exceptional circumstances; free aeration will usually be sufficient. If disinfection seems necessary, fumigation with sulphur dioxide will be the only practicable method of accomplishing it without injury.

#### RAGS.

(*a*) Rags which have been used for wiping away infectious discharges should at once be burned.

(*b*) Rags collected for the paper-makers during the prevalence of an epidemic should be disinfected before they are compressed in bales by,—

1. Exposure to super-heated steam of 105° C. (221° Fahr.) for ten minutes.
2. Immersion in boiling water for half an hour.

#### SHIPS.

(*a*) Infected ships at sea should be washed in every accessible place, and especially the localities occupied by the sick, with,—

1. Solution of mercuric chloride, 1 : 1,000.
2. Solution of carbolic acid, 2 per cent.

The bilge should be disinfected by the liberal use of a strong solution of mercuric chloride.

(*b*) Upon arrival at a quarantine station, an infected ship should at once be fumigated with sulphurous acid gas, using three pounds of sulphur for every 1,000 cubic feet of air-space; the cargo should then be discharged on lighters; a liberal supply of the concentrated solution of mercuric chloride (4 oz. to the gallon) should be thrown into the bilge, and at the end of twenty-four hours the bilge-water should be pumped out and replaced with pure sea-water: this should be repeated. A second fumigation, after the removal of the cargo, is recommended; all accessible surfaces should be washed with one of the disinfecting solutions heretofore recommended, and subsequently with soap and hot water.

#### FOR RAILWAY CARS.

The directions given for the disinfection of dwellings, hospital wards, and ships, apply as well to infected railway cars. The treatment of excreta with a disinfectant, before they are scattered along the tracks, seems desirable at all times in view of the fact that they may contain infectious germs. During the prevalence of an epidemic of cholera this is imperative. For this purpose the standard solution of chloride of lime is recommended.

At the annual meeting of the Sanitary Council of the Mississippi Valley, held in New Orleans, La., March 10, 11, 1885, the following resolution was adopted :

*Resolved,* That the secretary request from the chairman of the Committee on Disinfectants, appointed at the last meeting of the American Public Health Association, a plain, practical paper on "Disinfection and Disinfectants," for popular use and distribution, to be furnished to the chairman of the special committee of this council on General Sanitation.

In compliance with this request a Preliminary Report was prepared, which has been quite widely circulated. This report having been made before the experimental researches of the committee were completed, and being a "preliminary report," was only intended to serve a temporary purpose; but it has been thought best to revise it, and to introduce it into this our final report, so that it may be available for distribution in a separate form if sanitary officials find it suitable for popular use.

#### DISINFECTION AND DISINFECTANTS.

The object of disinfection is to prevent the extension of infectious diseases by destroying the specific infectious material which gives rise to them. This is accomplished by the use of disinfectants.

There can be no partial disinfection of such material: either its infecting power is destroyed, or it is not. In the latter case there is a failure to disinfect. Nor can there be any disinfection in the absence of infectious material.

It has been proved for several kinds of infectious material, that its specific infecting power is due to the presence of living micro-organisms, known in a general way as "disease germs;" and practical sanitation is now based upon the belief that the infecting agents in all kinds of infectious material are of this nature. Disinfection, therefore, consists essentially in the destruction of disease germs.

Popularly, the term disinfection is used in a much broader sense. Any chemical agent which destroys or masks bad odors, or which arrests putrefactive decomposition, is spoken of as a disinfectant. And in the absence of any infectious disease it is common to speak of disinfecting a foul cesspool, or bad smelling stable, or privy vault.

This popular use of the term has led to much misapprehension, and the agents which have been found to destroy bad odors—deodorizers—or to arrest putrefactive decomposition—antiseptics—have been confidently recommended and extensively used for the destruction of disease germs in the excreta of patients with cholera, typhoid fever, etc.

The injurious consequences which are likely to result from such misapprehension and misuse of the word disinfectant will be appreciated when it is known that recent researches have demonstrated that many of

the agents which have been found useful as deodorizers, or as antiseptics, are entirely without value for the destruction of disease germs.

This is true, for example, as regards the sulphate of iron or copperas, a salt which has been extensively used with the idea that it is a valuable disinfectant. As a matter of fact, sulphate of iron in saturated solution does not destroy the vitality of disease germs, or the infecting power of material containing them. This salt is, nevertheless, a very valuable antiseptic, and its low price makes it one of the most available agents for the arrest of putrefactive decomposition.

Antiseptic agents, however, exercise a restraining influence upon the development of disease germs, and their use during epidemics is to be recommended when masses of organic material in the vicinity of human habitations cannot be completely destroyed, or removed, or disinfected.

While an antiseptic agent is not necessarily a disinfectant, all disinfectants are antiseptics; for putrefactive decomposition is due to the development of "germs" of the same class as that to which disease germs belong, and the agents which destroy the latter also destroy the bacteria of putrefaction when brought in contact with them in sufficient quantity, or restrain their development when present in smaller amounts. A large number of the proprietary "disinfectants," so-called, which are in the market, are simply deodorizers or antiseptics, of greater or less value, and are entirely untrustworthy for disinfecting purposes.

Antiseptics are to be used at all times when it is impracticable to remove filth from the vicinity of human habitations, but they are a poor substitute for cleanliness. During the prevalence of epidemic diseases, such as yellow fever, typhoid fever, and cholera, it is better to use in privy-vaults, cess-pools, etc., those antiseptics which are also disinfectants, *i. e.*, germicides; and when the contents of such receptacles are known to be infected, this becomes imperative.

Still more important is the destruction at our seaport quarantine stations of infectious material which has its origin outside of the boundaries of the United States, and the destruction, within our boundaries, of infectious material given off from the persons of those attacked with any infectious disease, whether imported or of indigenous origin.

In the sick-room we have disease germs at an advantage, for we know where to find them as well as how to kill them. Having this knowledge, not to apply it would be criminal negligence, for our efforts to restrict the extension of infectious diseases must depend largely upon the proper use of disinfectants in the sick-room.

#### GENERAL DIRECTIONS.

*Disinfection of Excreta, etc.* The infectious character of the dejections of patients suffering from cholera and from typhoid fever is well established; and this is true of mild cases and of the earliest stages of these diseases as well as of severe and fatal cases. It is probable that epidemic dysentery, tuberculosis, and perhaps diphtheria, yellow fever,

scarlet fever, and typhus fever, may also be transmitted by means of the alvine discharges of the sick. It is therefore of the first importance that these should be disinfected. In cholera, diphtheria, yellow fever, and scarlet fever, all vomited material should also be looked upon as infectious. And in tuberculosis, diphtheria, scarlet fever, and infectious pneumonia, the sputa of the sick should be disinfected or destroyed by fire. It seems advisable also to treat the urine of patients sick with an infectious disease with one of the disinfecting solutions below recommended.

Chloride of lime, or bleaching powder, is perhaps entitled to the first place for disinfecting excreta, on account of the rapidity of its action. The following standard solution is recommended :

*Dissolve chloride of lime of the best quality<sup>1</sup> in pure water, in the proportion of six ounces to the gallon.*

Use one quart of this solution for the disinfection of each discharge in cholera, typhoid fever, etc.<sup>2</sup> Mix well, and leave in the vessel for at least one hour before throwing into privy vault or water-closet. The same directions apply for the disinfection of vomited matters. Infected sputum should be discharged directly into a cup half full of the solution. A five per cent. solution of carbolic acid may be used instead of the chloride of lime solution, the time of exposure to the action of the disinfectant being four hours.

*Disinfection of the person.* The surface of the body of a sick person, or of his attendants, when soiled with infectious discharges, should be at once cleansed with a suitable disinfecting agent. For this purpose solution of chlorinated soda (liquor sodæ chlorinatæ) diluted with nine parts of water, or the standard solution of chloride of lime diluted with three parts of water, may be used. A 2 per cent. solution of carbolic acid is also suitable for this purpose, and under proper medical supervision the use of a solution of corrosive sublimate—1 : 1,000—is to be recommended.

In diseases like small-pox and scarlet fever, in which the infectious agent is given off from the entire surface of the body, occasional ablutions with the above mentioned solution of chlorinated soda are recommended.

In all infectious diseases the body of the dead should be enveloped in a sheet saturated with the standard solution of chloride of lime, or with a 5 per cent. solution of carbolic acid, or a 1 : 500 solution of corrosive sublimate.

*Disinfection of clothing.* Boiling for half an hour will destroy the vitality of all known disease germs, and there is no better way of disinfecting clothing or bedding which can be washed than to put it through

<sup>1</sup> Good chloride of lime should contain at least 25 per cent. of available chlorine (page 92). It may be purchased by the quantity at 3½ cents per pound. The cost of the standard solution recommended is therefore but little more than one cent a gallon. A clear solution may be obtained by filtration or by decantation, but the insoluble sediment does no harm, and this is an unnecessary refinement.

<sup>2</sup> For a very copious discharge, use a large quantity.

the ordinary operations of the laundry. No delay should occur, however, between the time of removing soiled clothing from the person or bed of the sick and its immersion in boiling water, or in one of the following solutions until this can be done :

*Corrosive sublimate*, one drachm to the gallon of water (about 1 : 1,000), or,—

*Carbolic acid, pure*, one ounce to the gallon of water (1 : 128).

The articles to be disinfected must be thoroughly soaked with the disinfecting solution and left in it for at least two hours. after which they may be wrung out and sent to the wash.

N. B. Solutions of corrosive sublimate should not be placed in metal receptacles, for the salt is decomposed and the mercury precipitated by contact with copper, lead, or tin. A wooden tub or earthen crock is a suitable receptacle for such solutions.

Clothing or bedding which cannot be washed should be disinfected by steam in a properly constructed disinfection chamber. In the absence of a suitable steam disinfecting apparatus, infected clothing and bedding should be burned.

*Disinfection of the sick-room.* In the sick-room no disinfectant can take the place of free ventilation and cleanliness. It is an axiom in sanitary science that it is impracticable to disinfect an occupied apartment for the reason that disease germs are not destroyed by the presence in the atmosphere of any known disinfectant in respirable quantity. Bad odors may be neutralized, but this does not constitute disinfection in the sense in which the term is here used. These bad odors are, for the most part, an indication of want of cleanliness, or of proper ventilation ; and it is better to turn contaminated air out of the window or up the chimney than to attempt to purify it by the use of volatile chemical agents, such as carbolic acid, chlorine, etc., which are all more or less offensive to the sick, and are useless so far as disinfection—properly so called—is concerned.

When an apartment which has been occupied by a person sick with an infectious disease has been vacated, it should be disinfected. The object of disinfection in the sick-room is mainly the destruction of infectious material attached to surfaces, or deposited as dust upon window ledges, in crevices, etc. If the room has been properly cleansed and ventilated while still occupied by the sick person, and especially if it was stripped of carpets and unnecessary furniture at the outset of his attack, the difficulties of disinfection will be greatly reduced.

All surfaces should be thoroughly washed with the standard solution of chloride of lime diluted with three parts of water, or with 1 : 1,000 solution of corrosive sublimate. The walls and ceiling, if plastered, should be subsequently treated with a lime-wash. Especial care must be taken to wash away all dust from window ledges and other places where it may have settled, and thoroughly to cleanse crevices and out-of-the-way places. After this application of the disinfecting solution, and an interval of twenty-four hours or longer for free ventilation, the floors

and wood-work should be well scrubbed with soap and hot water, and this should be followed by a second more prolonged exposure to fresh air, admitted through open doors and windows.

As an additional precaution, fumigation with sulphurous acid gas is to be recommended, especially for rooms which have been occupied by patients with small-pox, scarlet fever, diphtheria, typhus fever, and yellow fever. But fumigation with sulphurous acid gas alone, as commonly practised, cannot be relied upon for disinfection of the sick-room and its contents, including bedding, furniture, infected clothing, etc., as is popularly believed.

When fumigation is practised, it should precede the general washing with a disinfecting solution, heretofore recommended. To ensure any results of value, it will be necessary to close the apartment to be disinfected as completely as possible by stopping all apertures through which the gas might escape, and to burn not less than three pounds of sulphur for each thousand cubic feet of air space in the room. To secure complete combustion of the sulphur, it should be placed in powder or in small fragments, in a shallow iron pan, which should be set upon a couple of bricks in a tub partly filled with water, to guard against fire. The sulphur should be thoroughly moistened with alcohol before igniting it.

*Disinfection of privy vaults, cesspools, etc.* When the excreta (not previously disinfected) of patients with cholera or typhoid fever have been thrown into a privy vault, this is infected, and disinfection should be resorted to as soon as the fact is discovered, or whenever there is reasonable suspicion that such is the case. It will be advisable to take the same precautions with reference to privy vaults into which the excreta of yellow fever patients have been thrown, although we do not definitely know that this is infectious material.

For this purpose the standard solution of chloride of lime may be used in quantity proportioned to the amount of material to be disinfected, but where this is considerable it will scarcely be practicable to sterilize the whole mass. The liberal and repeated use of this solution, or of a 5 per cent. solution of carbolic acid, will, however, disinfect the surface of the mass, and is especially to be recommended during the epidemic prevalence of typhoid fever or of cholera.

All exposed portions of the vault, and the wood-work above it, should be thoroughly washed down with the disinfecting solution. Instead of the disinfecting solutions recommended, chloride of lime in powder may be daily scattered over the contents of the privy vault.

*Disinfection of ingesta.* It is well established that cholera and typhoid fever are very frequently, and perhaps usually, transmitted through the medium of infected water or articles of food, and especially milk. Fortunately we have a simple means at hand for disinfecting such infected fluids. This consists in the application of heat. The boiling temperature maintained for half an hour kills all known disease germs. So far as the germs of cholera, yellow fever, and diphtheria are con-

cerned, there is good reason to believe that a temperature considerably below the boiling point of water will destroy them. But in order to keep on the safe side, it is best not to trust anything short of the boiling point (212° F.) when the object is to disinfect food or drink which is open to the suspicion of containing the germs of any infectious disease.

During the prevalence of an epidemic of cholera it is well to boil all water for drinking purposes. After boiling, the water may be filtered, if necessary to remove sediment, and then cooled with *pure* ice, if desired.

## BIBLIOGRAPHY FROM 1880 TO 1888.

COMPILED BY GEORGE H. ROHÉ, M. D., SECRETARY OF THE COMMITTEE.

The following list of titles supplements and brings up to date the excellent bibliography of the older literature on disinfection and disinfectants given in the third volume of the Index Catalogue of the National Medical Library.

In the preparation of this list, free use has been made of the *Index Medicus*. Indeed, without the aid of that valuable publication the work would not have been undertaken. It is hoped the present compilation will prove useful to those desiring to pursue the study of the subject further than it is carried in this volume.

- Abbott, A. C.* The disinfectant value of stannous chloride. *Med. News*, Phila., 1886, *xlvi*, 120.
- The germicide value of some of the vegetable acids. *Med. News*, Phila., 1886, *xlvi*, 33.
- Adams, J.* On disinfection by heat, with description of a new disinfecting chamber. *Tr. San. Inst. Gr. Brit.* London, 1883-'4, *v.* 303-324.
- On disinfection by heat, with description of a new disinfecting chamber. *Glasgow M. J.*, 1883, *xx*, 337-357.
- Albanese, F.* Rapporto sulle stufe ad alta temperatura come mezzo di disinfezione. Palermo, 1886, 14 pp. 8vo.
- Albrecht.* Die erste öffentliche Desinfectionsanstalt der Stadt Berlin. *Gesdhts. Ingr.* München, 1887, *x*, 118, 122; also, in *Anst. d. Stadt Berl., f. d. öff. Gsndhtspf.*, 1886, 174-184.
- Alcina, B.* Estudio comparativo del poder disinfecante del cloro, ácido hiponitrico y ácido fénico, deducido de una experimentacion directa. *Gac. de hig. y climat.* Cadiz, 1881, *ii*, 103, 138.
- American Public Health Association.* Report of Committee on Disinfectants. Balto., 1885, 149 pp. 8vo.
- Andeer, J.* Die hohe Bedeutung der sogenannten Desinfections-mittel. *Wiener Med. Presse*, 1885, *xxvi*, 271-274.
- André.* De l'assainissement par l'acide sulfureux, etc. *Rec. de mém. de méd.* . . mil. Par., 1881, *3*, s. xxxvii, 110-113.
- Anvisning til Benyttelse af Desinfektions midler. *Ugeskr. f. Læger*, Copenhagen, 1880, *4*, *R. ii*, 450-452.
- Anweisung zur Ausführung der Desinfection für geprüfte Heildiener und sonst amtlich mit der Desinfection beauftragte Personen. Berl., 1883, 8vo.
- Anwendung des Broms als Desinfectionsmittel für Quarantäne, Lazarethe und Wohnhäuser. *Med. Chir. Centralbl.* Wien., 1880, *xv*, 343.
- Arloing.* De la chaleur comme adjuvant des antiseptiques. *Compt. rend. Soc. de biol.* Par., 1885, *8*, s. ii, 275.
- Armaingaud.* De la nécessité de créer à Bordeaux des étuves publiques pour la désinfection, par la vapeur d'eau surchauffée, etc. *J. de Méd. de Bordeaux*, 1880-'81, *x*, 310-313.
- Arribas, M.* Breves consideraciones sobre los agentes quimicos que se tienen par desinfectantes. *Bol. de benef. y sanid. municip.* Madrid, 1881, *i*, 57-61



- Aubert*. Nouvelles expériences sur la désinfection des habitations privées ou publiques à l'aide de l'acide sulfureux et sur l'action de cet agent sur les effets meublants. Bull. gén. de thérap. Par., 1886, cx, 397-408.
- Sur l'assainissement de la caserne . . . an moyen de l'acide sulfureux. Bull. gén. de thérap. Par., 1884, cvii, 304-307.
- Balogh, C.* Ueber desinficientia. Transl. from Orvosi hetil., 1884, in Pest. Med. Chir. Presse, Budapest, 1884, xx, 1025-1028.
- Baraban, V.* Note sur la désinfection constante et simultanée des fosses de Paris. Chaumont, 1884. 8vo.
- Barbier*. Le café comme désinfectant. J. de méd. et pharm. de l'Algérie. Alger., 1881, vi, 315-318.
- Barth de Sandfort*. De l'acide hypoazotique comme désinfectant; d'après le Dr. R. T. Munoz de Luna. Gaz. hebd. d. sc. Méd. de Bordeaux, 1885, vi, 369-372.
- Bayer, S.* O desinfektion. Upsala Läkaref. Förh., 1885, xxi, 1-31.
- Beissel*. Bericht über die Versuche, welche mit dem von Walz und Windscheid zu Aachen erbauten Desinfections-Apparate angestellt wurden. Centralbl. f. Allg. Gesdhtspf. Bonn, 1886, v, 438-441.
- Berlin*. Anleitung zum Desinfections-Verfahren. Gesundh-Ingenieur. Berl., 1883, vi, 491-498. Also, Berl., Klin. Wochnschr., 1883, xx, 559.
- Biggs, H. M.* The germicide power of sulphur dioxide. Med. News, Phila., 1887, li, 702-706.
- Biscaro, G.* Studio del miscuglio d'ipoclorito di calcio commerciale ed acid fenico, usato in Padova nell' estate, 1884, come antisettico. Atti r. Ist. Veneto di sc. lett. ed arti, 1885-'86, 6, s. iv, 663-671.
- Blyth, A. W.* Studies of disinfectants by new methods. Proc. Roy. Soc. London, 1885, 259-276.
- The action of disinfectants on micro-zooids. Tr. Soc. Med. Off. Health. Lond., 1884-'85, 156-167.
- Criticisms on the exhibits of disinfectants at the Health Exhibition. Med. Times & Gaz. Lond., 1884, ii, 498-501.
- Bochefontaine*. Note sur quelques expériences relatives à l'action antiseptique des sels de cuivre. Par., 1883. 8vo.
- Boillat, F.* Contributions to the study of antiseptics. (Transl.) Van Nostrand's Engin. Mag. N. Y., 1885, xxxii, 428-432.
- Bonilla, Mirat S.* Medios para desinfectar las aguas de los micro-organismos que pueden contener. Med. Castellana. Vallad., 1886, i, 247-254.
- Bonnewyn*. Considérations pratiques sur l'emploi des antiseptiques et désinfectants comme moyens préventifs des épidémies. Bull. Acad. roy. de Méd. de Belg. Brux., 1887, 4, s. i, 237-269.
- Bourru*. Note sur l'emploi du gaz sulfureux comme désinfectant dans les hôpitaux de la marine. Arch. de Méd. Navale. Par., 1884, xlii, 171-374.
- Brémond, fils*. Procédé facile pour obtenir de l'ozone dans les appartements. Bull. et mém. soc. de thérap. Par., 1884, xvi, 112.
- Bromo-chloralum for sanitary, hygienic, and medical purposes, as well as in the care of the sick. N. Y., 1883. 8vo.
- Bruun Pederson, N.* Om Desinfektion. Tidsskr. f. Vet. Copenhagen, 1887, xvii, 1-19.
- Buchner, H.* Desinfection von Kleidern und Effecten an denen Milzbrand contagium haftet. In: von Nägeli, C., Unters. ü. niedere Pilze. München u. Leipz., 1882, 225-230.
- Buck, W. E.* Note on disinfectants. Brit. M. J. Lond., 1883, i, 1281.
- Burcq*. Sur l'action désinfectante et antiseptique du cuivre. Compt. rend. Acad. d. sc. Par., 1882, xcvi, 862-864.
- Carpenter, A.* Theory and practice as to disinfection. San. Rec., Lond., 1886-'87, n. s. viii, 433, 479.
- Carreras Sanchis, M.* Un nuevo antiseptico; el aseptol ó ácido ortoxifenilsulfuroso. Diario Med.-farm., Madrid, 1884, i, Nos. 223, 224.

- Carroll, A. L.* Concerning the disinfection of rags. *Med. Rec.*, N. Y., 1886, xxix, 54.
- Cash, J. T.* Report on certain chemical disinfectants. *Rep. Med. Off. Local Govt. Bd.* London, 1885, 192-203.
- Report on the disinfectant properties of oxygen and ozone. *Rpt. Local Govt. Bd.* London, 1885-'86, xv, 193-208.
- Causse, A.* Rapport présenté à la commission municipale de salubrité, concernant une étude de désinfection dont il avait été chargé d'étudier le fonctionnement. *Gaz. Med. Chir. de Toulouse*, 1884, xvi, 225.
- Chamberland.* Les essences au point de vue de leurs propriétés antiseptiques. *Ann. del' Inst. Pasteur. Par.*, 1887, i, 153-164.
- Chapin, C. V.* Disinfection. *Tr. Rhode Island M. Soc.* 1886. Providence, 1887, iii, pt. 4, 345-354.
- Chateau, Edourd.* Étude sur les principaux désinfectants. Montpellier, 1885, 62 pp. 4to.
- Chautemps, Émile.* L'organisation sanitaire de Paris. Hôpitaux d'isolement, voitures, d'ambulances, stations de désinfection. Rapport présenté au Conseil municipale. *Par.*, 1888, 142 pp., 5 pl. 4to.
- Chirone, V.* Di un nuovo criterio per determinare con rigore scientifico il valore relativo dei diversi antisettici; ricerche sperimentali. *Bull. d. sc. med. di Bologna*, 1880, 6, s. vi, 5-24.
- Cholera disinfection; also, typhoid. *Med. News, Phila.*, 1883, xlii, 244-247.
- Christoc, W. S.* Phenyle as a disinfectant. *Canada Lancet, Toronto*, 1881-'82, xiv, 107.
- Coelho, S. M. T.* O acido sulfuroso como desinficante. *J. Soc. d. sc. Med. de Lisb.*, 1884, xlvi, 127-129.
- Cruces Villodres, A.* Algunas palabras sobre la desinfeccion. *Gac. Med. de Granada*, 1884, ii, 97, 129.
- Curtiss, R. J.* Bichloride of mercury as a germitoxic. *St. Louis M. & S. J.*, 1884, xlvii, 14-17.
- Cyrnos, J. M.* La désinfection des vidanges, des égouts et des établissements insalubres; note de M. Huet *J. d'hyg. Par.*, 1881, vi, 53-55.
- Czernicki.* Note complémentaire sur l'assainissement . . . au moyen de l'acide sulfureux. *Arch. de méd. et de pharm. milit. Paris*, 1884, iv, 301-307.
- Note sur l'assainissement . . . au moyen de l'acide sulfureux. *Rec. de mém. de méd. . . mil. Par.*, 1880, 3, 5, xxxvi, 513-521.
- Dake, J. P.* Fermentation as a process in the disinfection of rooms after small-pox. *Hahnemannian Month.*, Phila., 1881, n. s. iii, 34, 35.
- Dehetamendi, J.* The experimental truth in regard to disinfectants. (Transl. from *Rev. Argent. de cien. Med.*, Buenos Ayres, by J. Workman.) *Canada Lancet, Toronto*, 1885-'86, xviii, 159-162.
- Depérais, C.* La desinfezione delle materie putride ed infettive. *Atti. r. Ist. d'incorag. d. sc. nat. di Napoli*, 1884, 3, s. iii, No. 14, 1-38.
- Dévai, M.* Infection und Desinfection. *Pest. Med. Chir. Presse, Budapest*, 1880, xvi, 904, 924.
- Desinfection mittelst warmer Luft. (Transl. from *San. Rec.*, Lond.) *Gesundheits-Ingenieur, Berl.*, 1881, iv, 45-48.
- Des mesures prophylactiques et des moyens de désinfection à employer dans les maladies infectieuses. *Ann. Soc. Méd. Chir. de Liège*, 1885, xxiv, 590-595.
- Discussion de la proposition de M. Craninx ayant pour but de faire établir quelle est de ces deux espèces de produits, les antiseptiques et les désinfectants, cell à laquelle il faut dans les épidémies accorder la préférence? *Bull. Acad. roy. de méd. de Belg. Brux.*, 1885, xix, 380, 513.
- Disinfection by steam. *San. Rec.*, Lond., 1883-'84, n. s. v, 84-86.
- Disinfection in Paris. *San. News, Chicago*, 1885, v, 80.
- Disinfection of rags. *Brit. M. J.*, Lond., 1885, i, 907.
- Disinfection of rags. *San. Engin.*, N. Y., 1885, xii, 267.
- Disinfection of rags; Communication of the health officers of the port of New York upon. N. Y., :885, 21 pp. 8vo.

- Disinfection. *Med. News*, Phila., 1882, xl, 359, 387.
- Disinfection; a circular from the state board of health. *Rep. Bd. Health*, Mass. Bost., 1879, xi, 19.
- Disinfectants. *Rep. Mississippi Bd. Health*, Jackson, 1879, 173-177.
- Disinfectants. Preliminary reports of the Com. on Disinfectants of the Am. Pub. Health Association. *Med. News*, Phila., 1885, xlvi, 87, 144, 205.
- Disinfectants. *Ephem. Mat. Med.*, Brooklyn, 1884-'85, ii, 802-812.
- Disinfectants and their use. Essays for prizes offered by the Druggists' Circular. N. Y., 1885, 168 pp. 8vo.
- Disinfecting apparatus in Warsaw (Bacon's system) [Polish]. *Zdrowie*, Warszawa, 1885. I, No. 2, 24-26.
- Dickson, E. D.* Des désinfectants en temps d'épidémies. *Gaz. méd. d'Orient*, Constantinople, 1885-'86, xxviii, 68-73.
- Dobroslavine, A.* Étuve selhydrique pour la désinfection. *Rev. d'hyg.*, Par., 1886, viii, 487-497.
- Means of disinfection (Russian). *Zdorovje*, St. Petersburg, 1883, x, No. 1, p. 4; No. 3, p. 5.
- Importance of disinfection (Russian). *Zdorovje*, St. Petersburg, 1879, v, 411, 425.
- Dobrovits, M., and G. Pavay.* Wie soll man desinficiren? Pressburg, 1886, 24 p. 8vo.
- Dougall, J.* Disinfection by acids. *San. Jour.*, Glasg., 1879-'80, n. s. iii, 365-370.
- Dozy.* Over ontsmettings-ovens. *Nederl. Tijdschr. v. Geneesk.* Amst., 1887, xxiii, 29-33.
- Duggan, J. R.* On the report of the Committee on Disinfectants of the American Public Health Association. *Med. Rec.*, 1885, xxviii, 695.
- The present abuse and future use of disinfecting agents. *Med. Rec.*, 1886, xxix, 89.
- Germicide power of the hypochlorites. *Med. News*, Phila., 1885, xlvi, 147.
- On the report of the Committee on Disinfectants of the Am. Pub. Health Asso.; a reply to Dr. Sternberg. *Med. Rec.*, N. Y., 1885, xxvii, 304-306.
- and *C. T. McClintock.* On the preliminary report of the Committee on Disinfectants of the Am. Pub. Health Asso. *Med. Rec.*, N. Y., 1885, xxvii, 642.
- Relative value of mercuric chloride and the hypochlorites as disinfectants. *Med. Rec.*, N. Y., 1885, xxvii, 653.
- Dujardin-Beaumez.* Expériences sur la désinfection des locaux ayant été occupés par des malades atteintes d'affections contagieuses. *Bull. Acad. de méd.* Par., 1884, 2, s. xiii, 1261-1271. Also, *Bull. gén. de thérap.*, 1884, cvii, 241-247.
- Durgin, S. H.* Practical experience with moist heat (steam under pressure) as a disinfectant. *Am. Pub. Health Asso. Report*, 1886, xii, p. 226-228.
- Dwitskii.* Table of disinfectants; their comparative value (Russian). Vilna, 1879. 8vo.
- Elliston, W. A.* The value of disinfectants. *Brit. M. J.* Lond. 1886, ii, 809.
- Entwurf einer Petition des österr. Aerztevereinsbandes betreffend die Desinfectionsfrage. *Oester. Ärtzl. Vereinsztg.* Wien, 1883, vii, 143.
- Erllass d. Königl. Polizeipräsidiums zu Berlin vom 15 August, 1883, betreffend Anleitung zum Desinfectionsverfahren. *Deutsche Vrtljrschr. f. öff. Gsdhtspf.* Brnschw., 1884, xvi, 145-150.
- Expediente relativo al proyecto para utalizar el hollin en la desinfeccion de las materias fecales. *Bol. d. Cons. Sup. de salub. d. dist. fed. Mexico*, 1881-2, ii, 33-55.
- Erismann, F.* Die Desinfectionsarbeiten auf dem Kriegsschauplatze der Europäischen Türkei während des Russischtürkischen Feldzuges, 1877-78, München, 1879.
- Esmarch, E.* Der Hennebergs'che Desinfector. *Ztschr. f. Hyg.* Leipz. 1887, ii, 342-368.
- Der Keimgehalt der Wände und ihre Desinfection. *Ibid.*, 491-520.
- Eyselein, O.* Ueber Torfstreu und Torfmull als Desinfections und Düngermittel. *Deutsche Vrtljrschr. f. öff. Gsdhtspf.* Brnschw., 1881, xiii, 266-268.
- Fatio, V.* Désinfection des véhicules par l'acide sulfureux anhydre. *Compt. rend. Acad. d. sc.* Par., 1880, xc, 851-854.
- Fawvel.* Rapport sur la désinfection appliquée aux provenances maritimes, comprenant l'exposé des procédés divers en usage tant en France qu'à l'étranger, l'examen

- critique de ces procédés et l'indication des avantages qu'il y aurait à leur substituer l'emploi de la chaleur dans tous les cas où il serait applicable. Rec. de trav. Comité Consult. d. hyg. pub. de France, 1881. Par., 1883, xi, 41-84.
- Fergus, W.* Diffusion of antiseptics and other remedies in the atmosphere of apartments. *Lancet*, Lond., 1880, ii, 757.
- Fernandez Caro, A.* Los desinfectantes. *Rev. Soc. españ. de hig.* Madrid, 1884, ii, 481-500.
- Fischer, B., und B. Proskauer.* Ueber die Desinfection mit Chlor. und Brom. *Mitth. a. d. Kais. Gsundtsamte.* Berl., 1884, ii, 228-308.
- Fleischhauer und Mittenzweig.* Prüfung des Desinfections-Apparats der Stadt Düsseldorf. *Vrtljschr. f. gerichtl.-Med.* Berl., 1886, xlv, 120-144.
- Ford, W. H.* Report of the Sanitary Committee of the Board of Health of Philadelphia on municipal disinfection of clothing, bedding, etc. *Rept. Bd. Health, Penn.* 1885. Harrisburg, 1886, I, 298-302. 2 pl.
- Forster, J.* Wie soll der Arzt seine Hände reinigen? *Ctbl. f. Klin. Medizin.* Leipz., 1885, vi, 297-299.
- Frank, E.* Ueber Desinfection von Abtrittsgruben. Berl., 1885, 8vo.
- Die Desinfection mit Brom; Antwort an Herrn A. Wernich. *Deutsche Med. Wochnschr.* Berl., 1882, viii, 711.
- und *A. Doleschall.* Ueber die Desinfectionskraft der gasförmigen Körper. *Pest. med. chir. Presse.* Budapest, 1882, xviii, 986.
- Frank.* Ueber die Technik der Desinfection in ihren Beziehungen zu den neuen hygienischen Forschungen. *Tagebl. d. Versamml. deutsch. Naturf. u. Aerzte.* Magdeburg, 1884, lvii, 277-279.
- Gaertner.* Ueber die desinificirende Wirkung der wässerigen Carbolsäurelösungen. *Deutsche Med. Wchnschr.* Berl., 1885, xi, 369.
- Gärtner und Plagge.* Ueber die desinificirende Wirkung wässerigen Carbolsäurelösungen. *Arch. f. Klin. Chir.* Berl., 1885, xxxii, 403-413.
- Geschwind.* Note sur l'assainissement au moyen de l'acide sulfureux. *Rec. de mém. de méd. mil.* Par., 1881, 3, s. xxxvii. 107-110.
- González, Rico G.* Desinfeccion cuartelaria y nosocomial. *Gac. de Sanid. mil.* Madrid, 1885, xl, 296, 343, 420, 476, 523.
- Grancher.* Désinfection par la chaleur des objets de literie et autres . . . à l'aide des étuves à vapeur de MM. Geneste, Herscher et Cie. *Rec. d. trav. Comité Consult. d'hyg. publ. de France*, 1885. Par., 1886, xv, 90-105.
- Granjux.* De la désinfection dans les quartiers militaires. *Rev. mil. de Méd. et Chir.* Par., 1881-'82, i, 732-750.
- Guillaumet, Jean-Albert.* De l'azotite d'éthyle et de son emploi médical comme antiseptique et désinfectant. *Bordeaux*, 1881, 60 pp. 4to.
- Guttman, P.* Desinfectionsversuche in den Apparaten der ersten öffentlichen Desinfections-Anstalt der Stadt Berlin. *Vrtljrsschr. f. gerichtl. Med.* Berl., 1886, n. F. xiv, 161-170.
- Ueber Desinfection von Wohnungen. *Deutsche Med. Zeitung.* Also, *Mitth. d. Ver. d. Aerzte in Nied. Oestr.* Wien, 1887, xiii, 125-128.
- und *Merke, H.* Die Desinfectionsanstalt der Stadt Berlin. *Pest. Med. Chir. Presse.* Budapest, 1886, xxii, 676.
- Ueber Desinfection von Wohnungen. *Arch. f. path. Anat.* Berl., 1887, cvii, 459-475.
- Gruber, M.* Ueber Desinfection. *Oesterr. Ärztl. Vereinsztg.* Wien, 1884, viii, 296-299, 316, 340.
- Ueber Desinfection. *Gesundh. Ingenieur.* Berl., 1884, vii, 505, 537.
- Ueber Desinfections-verfahren. *Med.-Chir. Centralbl.* Wien, 1884, xix, 472-488.
- Haberkorn.* Das Verhalten von Harnbacterien gegen einige antiseptica. *Dorpat*, 1879.
- Hamlet, W. M.* On the actions of compounds inimical to bacterial life. *J. Chem. Soc.* Lond., 1881, xxxix, 326-331.
- Harlan, A. W.* Antiseptics and disinfectants. *Tr. Illinois Dent. Soc.* Chicago, 1886, xxii, 67-89.

- Hassall, A. H.* Investigations relative to inhalation and disinfection. *Lancet*, Lond., 1883, ii, 580-582.
- Heesen und Mitchinson.* Desinfections-Zünder. *Pharm. Zeitschr. f. Russland*. St. Petersburg. 1886, xxv, 97, 113.
- Heidenhain, A.* Desinfection im Hause und in der Gemeinde. *Populär-Wissenschaftliche Anleitung mit besonderem Hinblick auf eine etwaige Cholera-Epidemie*. Cöslin, 1887. 8vo.
- Henry, E.* Note sur les perfectionnements à introduire dans la construction et dans la conduite des étuves désinfectantes à vapeur d'eau sous pression. *Rev. d'hyg. Par.*, 1886, viii, 852-862.
- Heraeus, W.* Sublimatdämpfe als Desinfectionsmittel. *Zeitschr. f. Hyg.* Leipzig., 1886, i, 235-242.
- Hering.* Ueber Desinfections-mittel und Desinfections-methoden. *Monatl. Mitthl. a. d. Gesamtgeb. d. Naturw.* Frankf., a. O. 1886-7, iv, 2, 33, 65.
- Herrmann, F.* Beitrag zur Desinfectionsfrage. *St. Petersburg., med. Wchnschr.*, 1881, vi, 435-438.
- Herscher, C.* Note sur une étuve locomobile à désinfection. *Rev. d'hyg. Par.*, 1887, ix, 738-743.
- Des appareils à désinfection par l'air chaud, etc. *Rev. d'hyg. Par.*, 1881, iii, 585-599.
- Note sur les études à désinfection; conditions de leur efficacité et observations relatives à la détérioration des objets traités. *Rev. d'hyg. Par.*, 1885, vii, 831-743.
- Heydenreich, L., und F. Beilstein.* Ueber die Werthbestimmung von Desinfections-mitteln. *Deutsche Vrtljhrsschr. f. öff. Gsndtspf.* Brnshwg., 1881, xiii, 257-266.
- Hoffman, Exp.* Unters. über die Wirkung der Ameisensäure. *Dissert'n*, Greifswald, 1885.
- Hofmann, F.* Moderne Desinfectionstechnik mit besonderer Beziehung auf öffentliche Desinfectionsanstalten. *Deutsche Vrtljhrsschr. f. öff. Gsndtspf.* Brnshwg., 1887, xix, 117-145.
- Ueber Desinfections-massregeln. *Deutsche Vrtljhrsschr. f. öff. Gsndtspf.* Brnshwg., 1880, xii, 41-50.
- Procédés de désinfection. (From *Deutsche Vrtljhrsschr. f. öff. Gsndtspf.* 1880.) *Ann. d'hyg. Par.*, 1881, 3, 5, vi, 539-443.
- Holbek, F. K.* Experiments with disinfecting materials (Russian). *Med. pribav. K. Morsk. sborniku*. St. Petersburg., 1882, Dec. 17-46.
- Holt, J.* A reply to the letter, "Dr. Joseph Holt and steam as a disinfectant." *New Orleans M. & S. J.*, 1885-'86, n. s. xiii, 376-384. Also, Reprint.
- Horneman, E.* Nogle Bemærkninger om Desinfektion navulig ved Hjælp af hoje Varmegrader. *Hyg. Medd.* Copenhagen, 1879, iii, 1-31.
- Hueppe, F.* Ueber die desinficirenden und antiseptischen Eigenschaften des Aseptol. *Berl., Klin. Wchnschr.*, 1886, xxiii, 909.
- Ueber einige Vorragen zur Desinfectionslehre und über die Hitze als Desinfections-mittel. *Deutsche Mil. Ärztliche Ztschr.* Berl., 1882, xi, 129-154.
- Hüllmann.* Das Abortsdesinfectionssystem des Hrn Max Friedrich in Plagwitz. *Deutsche Vrtljhrsschr. f. öff. Gsndtspf.* Brnshwg., 1880, xii, 112-118.
- Hunt, E. M.* Notes on the report of the committee of the American Public Health Association on disinfectants. *Med. News, Phil.*, 1886, xlvi, 34-36.
- Heat disinfection apparatus. *San. Rec.* Lond., 1885-'86, n. s. vii, 317-323.
- Infectious diseases,—What are they? how are they spread? how to prevent them? By cleanliness, ventilation, and disinfection. *Report Board Health Minnesota*. St. Peter, 1881, viii, 183-188.
- Instructions for disinfection. *Report Board Health Connecticut*, 1884. New Haven, 1885, vii, 129-133.
- Instructions for disinfection. *Report State Board Health, New York*, 1881. Albany, 1882, ii, 118-120.

- Instruction sur la désinfection dans les cas de maladies épidémiques ou transmissibles. Bureau municipal d'hygiène. Havre, 1881, 24 pp. 16mo.
- Jacobi*. Ueber Desinfectionen Einrichtungen. Jahresb. d. schles. Gesellsch. f. vaterl. Kult., 1881. Bresl., 1882, lix, 188-193.
- Jalan de La Croix, N.* Das Verhalten der Bakterien des Fleischwassers gegen einige antiseptica. Arch. f. exper. Path. u. Pharmakol. Leipz., 1880-'81, xiii, 175-255.
- Janssens*. La service communal de la désinfection à Bruxelles. Brux., 1884, 15 pp. 8vo. —Also, in Bull. Acad. Roy. de Méd. Belge, 1884.
- Jeanneret, A.* Note sur un nouveau désinfectant (térébène). Rev. Méd. de la Suisse Rom. Genève, 1882, ii, 466-472.
- Jivopiszev, K.* Disinfection of burying-places in Novorjevski (Russian) Arch. vet. nauk. St. Petersburg, 1885, xv, pt. 4, 15-23.
- Kent, W. H.* Experiments on burning sulphur in closed rooms. Med. News, Phila., 1885, xlvii, 313-316.
- Kingzett, C. T.* Sanitas as a disinfectant. Med. Times and Gaz. London, 1884, ii, 609. —Notes on practical disinfection and the use of "sanitas" as a sanitary reagent. Lond., 1880, 14 pp. 12mo. Also, San. Rec., London, 1880.
- Klein, E.* Experiments on the disinfectant power of various phenyl acids and salts. Rep. med. off. Local Gov't Bd. London, 1885. 188-190. —On air-disinfection. *Ibid.*, 187. —Experiments on disinfecting actions. Rep. med. off. Local Gov't Bd. London, 1884, xiii, 111-130. —Chlorine as an air-disinfectant. *Ibid.*, 130-132. —On the action of perchloride of mercury on bacteria. Rept. Local Gov't Bd. Lond., 1885-'86, xv, 155-184.
- Koch, R.* Ueber Desinfection. Mitth. a. d. k. Gsndtsamte. Berl., 1881, i, 1-49. —und *G. Wolffhügel*. Untersuchungen über die Desinfection mit heisser Luft. *Ibid.*, 1-21. —*G. Gaffky und F. Löffler*. Versuche über die Verwerthbarkeit heisser Wasserdämpfe zu Desinfectionszwecken. *Ibid.*, 1-19. —und *Gaffky*. Versuche über die Desinfection des Kiel oder Bilgeraums von Schiffen. Arbt. a. d. k. Gsdtsamte, Berl., 1885-'86, i, 199-221.
- König*. Die Desinfection inficirter Wohnräume. Ctibl. f. Chir. Leipz., 1885, xii, 197.
- Kohn, E.* Wie sollen wir desinficiren? Stuttgart, 1885. 8vo.
- Von Kosinski, S.* Ein neues Verfahren zum schnellen Austrocknen von Neubauten und zum Desinficiren von Wohnräumen. Gesundheits-Ingenieur. Berl., 1883, vi, 593-600.
- Krajewski, Alfred*. Ueber die Wirkungen der gebräuchlichsten Antiseptica auf einige Contagien. Leipz., 1883. 52 pp., 1 pl. 8vo. —Ueber die Wirkungen der gebräuchlichsten Antiseptica auf einige Contagien. Dorpat., 1880, 8vo. Also, Arch. f. Exper. Path. u. Pharmakol. Leipz., 1881, xiv, 139-148, 1 pl.
- Kratschmer*. Ueber Desinfection. Wien. Med. Bl. 1886, ix, 1423-1428, 1447, 1478, 1510, 1543.
- Kreibohm*. Zur Desinfection der Wohnräume mit Sublimatdämpfen. Zeitschr., f. Hyg. i, 363-368.
- Krocak, F.* Ueber constante Desinfection der Stubenluft bei Infectionskrankheiten. Med. Chir. Centralbl. Wien. 1883, xviii, 105-117.
- Krupin, S. E.* Disinfection in local diseases (Russian). Ejered. klin. gaz., St. Petersburg, 1886, vi, 493, 501, 526.
- Lafosse*. Note sur diverses applications de l'acide sulfureux. Rev. méd. de Toulouse, 1884, xviii, 13-19.
- Laillier, A.* Du gaz acide sulfureux comme insecticide et assainissant. Ann. d'hyg. Par., 1883, 3, s. ix, 97-107.
- Langenbuch, C.* Ueber die Brauchbarkeit des Iodtrichlorids als Desinficiens und Antisepticum. Berl. Klin. Wchnschr. 1887, xxiv, 741-744.

- Laplace, E.* Saure Sublimat-Lösung als desinficirendes Mittel und ihre Verwendung in Verbandstoffen. Deutsche med. Wchnschr. Leipz., 1887, xiii, 866.
- Lassar, O.* Notiz über Städtische Desinfections-Einrichtungen. Deutsche Med. Wchnschr. Berl., 1880, vi, 421.
- Lastres, J. F.* Informe acerca de los desinfectantes de los Estados-Unidos. An. r. Acad. de Cien. Méd. \* \* \* de la Habana, 1884-5, xxi, 175-179.
- Laws, J. P.* Report on the influence of acid reaction (sulphuric acid) on the life and growth of bacillus anthracis. Rept. Med. Off. Local Govt. Board, London, 1885, p. 204-208.
- Report on experiments to determine how far the "killing power" of phenylpropionic acid, as observed in previous experiments, may have been influenced by the absence of any proteid material in the solvent used. *Ibid.*, p. 215-217.
- Report on the relative value of phenol and paracresol as desinfectants. *Ibid.*, 209-214
- Lebedeff, A.* Contribution à l'étude de l'action de la chaleur et de la dessiccation sur la virulence des liquides septiques et sur les organismes inferieurs. Arch. de physiol. norm. et path. Par., 1882, 2, s. x, 175-204.
- Leduc, S.* Note sur une nouvelle étuve à désinfection. Rev. d'hyg. Par., 1885, vii, 828-835.
- Lee, R.* Atmospheric disinfection and its application in the treatment of disease. Brit. M. J. Lond., 1884, i, 713.
- Lereboullet, L.* Établissement à Paris d'étuves publiques pour la désinfection, etc. Gaz. hebdomadaire de Méd. Par., 1880, 2. s. xvii, 561-564.
- Liborius, P.* Einige Untersuchungen über die desinficirende Wirkung des Kalkes. Ztschr. f. Hyg. Leipz., 1887, ii, 15-51.
- Lucio, R.* [et al.] En qué casos emplearse la desinfeccion de los buques, pasajeros, animales y correspondencia? Qué método desinfectante debe usarse? Rev. méd. quir. de México, 1883, i, 83-90.
- Lübbert, A.* Die Desinfection durch Sublimaträucherungen. Aerztl. Int. Bl., 1885, xxxii, 735-737.
- Lyons, W.* Patent steam disinfectant. San. Engin. Lond., 1885, x, 371.
- Mackintosh, A.* Desinfectants and their use. San. Jour. Glasgow, 1884-85, n. s. viii, 209-211.
- Maly and Emich.* Antisept. Wirkung d. Gallensäuren. Sitzungsber. d. Kais. Akad. d. Wiss. Wien., 1883, Jan.
- Martin, A. J.* Le premier établissement public de désinfection de la ville de Berlin. Rev. d'hyg. Par., 1886, viii, 1001-1011.
- Établissement public de désinfection installé par la ville de Berlin. Rec. d. trav. Comité consult. d'hyg. pub. de France, 1886. Par., 1887, xvi, 468-476.
- La désinfection des chiffons. Rev. d'hyg. Par., 1887, ix, 806-813.
- Merke, H.* Bemerkungen über den für die Stadt Düsseldorf bestimmten Desinfections-Apparat. Vrtljhrsschr. f. gerichtl. Med. Berlin, 1886, xlv, 145-150.
- Die erste öffentliche Desinfections-Anstalt der Stadt Berlin. Vrtljhrsschr. f. gerichtl. Med. Berl., 1886, n. F. xlv, 137-160.
- Mittheilungen über Betriebsergebnisse der ersten öffentlichen Desinfectionsanstalt der Stadt Berlin und über ein neues Contactthermometer. Deutsche Vrtljhr. f. öff. Gsndhtspf. Brnschw., 1887, xix, 311-317.
- Ueber Desinfections-apparate und Desinfections-versuche. Vrtljhrsschr. f. gerichtl. Med. Berl., 1882, n. s. xxxvii, 85-108.
- Meyer, H.* Milchsäureferment u. sein verhalten gegen antiseptica. Dorpat, 1880.
- M. J. M.* Los desinfectantes en el laboratorio. Rev. de med. y cirug. práct. Madrid, 1884, xv, 440-445.
- Methods of Disinfection. From proceedings of International Sanitary Conference. Brit. M. J. 1885, i, 1221-1223.
- Miller, J.* Jeyes disinfectant purifier. Pharm. Zeitschr. f. Russland. St. Petersburg, 1883, xxii, 705-707.

- Miller, J. W.* A contribution to the study of disinfectants. Practitioner, Lond., 1884, xxxiii, 185-197, 258-269.
- Miquel, P.* Antiseptiques et bactéries. Annuaire Météorol. Par., 1884. Also Monit. Scientifique. Par., 1884, 3, s. xiv, 170-178.
- Sur les antiseptiques. Bull. gén. de thérap., etc. Par., 1884, cvii, 80-95.
- Mörschell.* Ein weiterer Beitrag zur Frage der Desinfection durch trockne Hitze. Deutsche Med. Wchnschr. Berl., 1880, vi, 487.
- Muter, J., and De Koningh, L.* Simple suggestions for the purchase and assay of commercial carbolic compounds used for sanitary purposes. Analyst, Lond., 1887, xiii, 191-195.
- Notter, J. L.* Experiments on disinfectants. Army M. Dep. Rep., 1878. Lond., 188c, xx, 217-222.
- On the experimental study of disinfectants. Dublin J. M. Sc., 1881, 3, s. lxxi, 508-511.
- Nowak.* Ueber Desinfection. Ztschr. f. Diagn. n. Therap. Wien., 1882, i, 33, 49, 60.
- V. O. de M. (Overbeck de Mejer?)* Onsmettings-ovens. Nederl. Tijdschr. v. Geneesk. Amst., 1885-xxi, 1037-1042.
- Olsen, J.* Sublimat som Desinfectionsmiddel. Norsk Mag. f. Lægevidensk, Christiania, 1884, xiv, 899-901.
- Er sublimat i en fortynding af en pro mille et paalideligt desinfections-middel? Norsk Mag. f. Lægevidensk, Christiania, 1884, xiv, 363-373.
- Orum, H. P.* Desinfections-forsog med Ozon. Ugeskr. f. Læger, Copenhagen, 1887, 4, R., xv, 169-175.
- Ovilo y Canales, F.* Los desinfectantes. Bol. de med. y cirug. Madrid, 1884, ii, 227-236. Also in Rev. Soc. españ. de hig. Madrid, 1884, ii, 435-445.
- P., F. A.* De los desinfectantes. Gac. de sanid. mil. Madrid, 1882, viii, 378, 436, 455, 617.
- Parker, W. T.* Boroglyceride, the new antiseptic. Phila. Med. Times, 1883-'84, xiv, 926-930.
- Parsons.* Report on disinfection by heat. Rep. Med. Off. Local Gov't Bd. London, 1885, 218-303, 8 pl.
- Pasteur, L., et L. Colin.* Établissement à Paris d'étuves publiques pour la désinfection, etc. Ann. d'hyg., Par., 1880, 3, s. iv, 97-106.
- Pastor, E. A.* Disinfection of fluids by steam (Russian). Ejened. klin. gaz. St. Petersburg, 1884, v, 312-318.
- Disinfection of running streams (Russian). Trudi Obsh. Russk. vrach. St. Petersburg, 1885, ii, 366-372.
- Patton, G. F.* The fumigation and disinfection of vessels and cargoes, with special reference to the Mississippi river quarantine. N. Orl. M. & S. J., 1882-'83, n. s. x, 641-647.
- Pescetto, F.* La disinfezione per mezzo dell' anidrite azotosa e dell' azotito d'etile. Roma, 1882. Svo.
- Peset-Cervera, V.* Desinfeccion de ropas en los hospitales. Génio Méd.-quir., Madrid, 1882, xxviii, 609.
- Petersen, O. V.* Disinfectants in hospitals (Russian). Vrach. St. Petersburg, 1881, ii, 253-256.
- Petersen, O.* Ueber die Desinfection in Hospitalern. St. Petersburg. med. Wchnschr., 1881, vi, 237, 244.
- Peyrussou.* Sur l'emploi de l'azotite d'éthyle pour assainir les locaux contaminés. Compt. rend. Acad. d. sc. Par., 1880, xci, 338.
- de Pietra Santa, P.* La désinfection par l'acide sulfureux. J. d'hyg., Par., 1884, ix, 46:-464. Also, Bull. gén. de thérap., 1884, cvii, 266-272.
- Du rôle et de l'avenir des antiseptiques en médecine et en hygiène. J. d'hyg., Par., 1880, v, 217-229.
- Pistor, M.* Einige Bemerkungen zu der von dem königlichen Polizeipräsidium in Berlin . . . erlassenen Anweisung zum Desinfectionsverfahren bei Volks-Krankheiten. Deutsche Vrtljhrsschr. f. öff. Gsndtspf. Brnschw., 1887, xix, 318-328.



- Pouchet, G.* La désinfection des chiffons employés dans l'industrie. Rev. d'hyg., Par., 1885, vii, 392-396.
- Proskauer, B.* Beiträge zur Bestimmung der Schwefligen Säure in der Luft. Mitth. a. d. k. Gsndhtsamte, i, 1-18.
- Proust, A.* De la désinfection à bord. Bull. Acad. de Méd. Par., 1887, 3, s. xvii, 147-160.  
—Règlements sanitaires Égyptiens; projet de revision du règlement sur la désinfection, etc. Rec. d. trav. Comité consult. d'hyg., pub. de France, 1886. Par., 1887, xvi, 462-467.
- Pulido, A.* Los desinfectantes. Siglo med. Madrid, 1884, xxxi, 690-692.
- Putzeys, F.* Rapport sur les mesures prophylactiques et moyens de désinfection à employer dans les cas de maladies infectieuses. Ann. Soc. Méd. Chir. de Liège, 1885, xxiv, 435-457.
- Queirel.* Rapport sur la désinfection. Marseille méd., 1887, xxiv, 459-463.
- de Ranse, F.* Prophylaxie des maladies transmissibles; de la désinfection des lieux et des objets contaminés. Gaz. méd. de Par., 1880, 6, s. ii, 169.
- Raymond, J. H.* Experiments with sulphurous acid gas. Med. News, Phila., 1885, xvi, 687.
- Reclam, C.* Zur Desinfection bei ansteckenden Krankheiten der Hausthiere. Gesundheit, Frankf. a. M., 1880, v, 97-100.  
—Wirksame Desinfection der Kleidungsstücke und Betten. Gesundheit, Frankf. a. M., 1883, viii, 289-291.
- Redard, Paul.* De la désinfection des wagons ayant servi au transport des animaux sur les voies ferrées. Par., 1885, 162 pp., 6 pl. 8vo.  
—De la désinfection des wagons ayant servi au transport des animaux sur les voies ferrées. Rev. d'hyg., Par., 1885, vii, 629-637.
- Reich.* Ueber Desinfection. Aerztl. Mitth. a. Baden, Carlsruhe, 1882, xxxvi, 91-97.
- Reichardt, E.* Die ansteckenden Krankheiten und die Desinfection. Corr.-Bl. d. allg. ärztl. Ver. v. Thürigen, Weimar, 1879, viii, 313-326.  
—Disinfezione e mezzi disinfettanti, per combattere le influenze nocive alla salute e per conservare gli alimenti, etc. Transl. by D. Gibertini. Parma, 1883. 8vo.  
Report of the Committee on Disinfectants for 1885. Baltimore, 1885. Also, in Rept. Am. Pub. Health Asso., Concord, N. H., 1886, xi, pp. 189-282.  
Report of the Special Committee of the American Public Health Association on the Disinfection of Rags. Concord, N. H., 1886, 30 pp. 8vo. Also, in Rept. of Am. Pub. Health Asso., vol. xii.  
Report of the joint standing committee of the Health Department on the disinfection of foreign rags. Boston, 1886, 10 pp. 8vo.  
Report of the Committee on Disinfectants of the American Public Health Association for 1886. Concord, N. H., 1887, 34 pp. 8vo.
- Richardson, B. W.* A simple disinfecting lamp. Asclepiad, London, 1884, i, 360.
- Richard.* Sur la pratique de la désinfection par l'acide sulfureux. Rev. d'hyg., Par., 1887, ix, 273-280.
- Richebourg.* Des désinfectants. Étude d'un antiseptique nouveau. Par., 1879. 8vo.
- Riedel, O.* Versuche über die desinfizirenden und antiseptischen Eigenschaften des Iodtrichlorids, wie über dessen Giftigkeit. Arb. a. d. Kais. Gsndhtsamte, Berl., 1887, ii, 466-483.
- Ripping, C.* Desinfectie en desinfectieovens. Nederl. mil. geneesk. Arch., etc. Utrecht, 1885, ix, 196-200.
- Rocheport.* Nouvelles expériences sur une étuve à désinfection par la vapeur d'eau. Rev. d'hyg., Par., 1885, vii, 529-535.
- Rohé, George H.* Apparatus for the application of dry and moist heat in disinfection. Am. Pub. Health Asso. Report., 1886, xii, pp. 200-226.
- Roose, R.* Infection and Disinfection. Fortnightly Rev., Lond., and Pop. Sc. Monthly, N. Y., 1886-'87, xxx, 765-777.
- Rosenbach, A.* Disinfection, Otto's fluid (Russian). Vet. dielo., St. Petersburg, 1885, iii, Nos. 3, 4, 7.

- Roth, W.* Beseitigung der Abfälle und Desinfection. Deutsche Vrtljhrsschr. f. öff. Gsdhtspfl., Brnshwg., 1884, xvi, 189-193.
- Rs.* Ueber einige Dampf-Desinfectionsapparate. Deutsche mil.-ärztl. Ztschr. Berl., 1887, xvi, 9-17.
- Russell, J. B.* On disinfection. San. Journ., Glasgow, 1884-'85, n. s. viii, 289-299. Also, in Glasgow M. J., 1884, xxii, 401-412.
- Sambuc.* La desinfection par la vapeur. Rev. d'Hygiène, Par., 1885, vii, 889-898.
- Sanderson, B. J.* Chemical products of putrefaction in their relation to disinfection. Rep. med. off. Local Govt. Bd. London, 1884, xiii, 101-110.
- Observations on the significance of the various researches of the present year into the operations of disinfecting agents. Rep. med. off. Local Govt. Bd. London, 1885, 183-186.
- Memorandum on lines of research concerning infection and disinfection. Rept. Local Gov't Bd. xii, and San. Jour. Glasgow, 1884-'85, n. s. viii, 97-107.
- Saunders, W.* Disinfectants. Rep. Prov. Bd. Health, Ontario, 1883. Toronto, 1884, ii, 327-331.
- Schär, E.* Zur Uebersicht und Kritik der Desinfectionsmittel. Bl. f. Gsndhtspfl. Zurich, 1880, ix, 153, 161, 173, 181.
- Die Bedeutung des Wassers für die Desinfection. Bl. f. Gsndhtspfl. Zurich, 1884, xiii, 57, 65, 73.
- Schenck.* Uric acid as a parasiticide. St. Louis Cour. Med., 1884, xii, 283.
- Schmidt-Rimpler, H.* Zur Desinfection mittelst Borsäure. Klin. Monatsbl. f. Augenh. Stuttg., 1880, xviii, 249-252.
- Schnetzler, J. B.* Sur les propriétés antiseptiques de l'acide formique. Arch. d. sc. phys. et Nat. Genève, 1884, 3. s. xi, 5-14.
- Schidlovski, S. V.* Disinfecting cartridges of sulphur (Russian). Vrach. St. Petersburg., 1885, vi, 853, 871.
- Nitric acid as a disinfectant for dwelling-houses (Russian). Vrach. St. Petersburg., 1886, vii, 130, 151.
- Schultz.* Die antisept. Eigenschaften d. Citronensäure. Deutsche Med. Wochnschr. 1883, n. 17.
- Ameisensäure als Antisepticum. *Ibid.*, 1885, ii, 24.
- Schwartz, N.* Ueber das Verhalten einiger Antiseptica zu Tabacksinfusbacterien. Pharm. Ztschr. f. Russland. St. Petersburg., 1880, xix, 610, 641, 673.
- Selmi, A.* I disinfettanti e gli antisettici; Studi ed osservazioni. Bull. d. Com. spec. d'ig. d. municip. di Roma, 1884, v 152, 212, 327.
- Serbourne, E.* Étude clinique et expérimentale sur les propriétés désinfectantes et antiseptiques de la "liqueur minérale." Par, 1882, 60 pp. 4to.
- da Silva Pinto, M. V.* A desinfeção pelo gaz acido sulfuroso, es o fumigader sulfothermico. Correio med. de Lisboa. 1884, xiii, 181-183.
- Smith, A.* The disinfection of rags at the port of New York. New York Med. Jour., 1885, xiii, 695.
- Smith, W. M.* Contagious diseases propagated by rags, and the necessity of disinfection. Sanitarian, N. Y., 1885, xv, 481-524.
- Sonderegger.* Zur Lehre von der persönlichen Desinfection. Deutsche Vrtljhrsschr. f. öff. Gsndhtspfl. Brnshwg., 1883, xv, 254-259.
- Soper, W.* Disinfection of excreta. Rept. Cong. San. Inst., Gt. Brit., 1879. London, 1880, i, 255-258.
- Stecher.* Vorschläge zur Verbesserung der Desinfection unter amtlicher Controle. Aerztl. Int. Bl., München, 1881, xxviii, 553-556.
- Steinmeyer, H.* Ueber Desinfectionslehre und ihre Anwendung auf die Praxis. Monatsbl. f. öff. Gesndhtspfl. Brnshwg., 1884, vii, 129-150.
- Sternberg, G. M.* Experiments designed to test the value of certain gaseous and volatile disinfectants. Nat. Bd. of Health Bull., Wash., 1879-'80, i, 219, 227, 287, 365.
- Experiments with disinfectants. Johns Hopkins Univ., Stud. biol. lab., Balto., 1882, ii, No. 2, pp. 201-212.

- The thermal death-point of pathogenic organisms. *Am. J. M. Sc.*, Phila., 1887, n. s., xciv, 146-160.
- Prize essay on Disinfection; in *Rept. State Bd. of Health, Calif.*, 1884-'86, ix, 241-270.
- Experiments to determine the germicide value of certain therapeutic agents. *Am. J. M. Sc.*, Phila., 1883, n. s., lxxxv, 321-343.
- The comparative antiseptic value of the salts and oxides of mercury. *Med. News*, Phila., 1885, xlvii, 287.
- Practical experiments on the sterilization of feces. *Med. News*, Phila., 1885, xlvii, 368.
- Metallic sulphates as disinfectants. *Med. News*, Phila., 1885, xlvii, 204.
- Commercial disinfectants. *Med. News*, Phil., 1885, xlvii, 144-147.
- Germicide power of potassium permanganate. *Ibid.*, 30-35.
- Reply to Dr. Duggan. *Med. Rec.*, N. Y., 1885, xxviii, 643.
- Disinfection and individual prophylaxis against infectious diseases. *Lomb Prize Essays*. Concord, N. H., 1886. 8vo.
- Suggestions in regard to general sanitation, disinfectants and deodorants; issued by the Mississippi State Board of Health. Jackson, 1880, 17 pp. 8vo.
- Suite de la discussion de la proposition de M. Craninx ayant pour but de faire établir quelle est de ces deux espèces de produits, les antiseptiques, et les désinfectants, celle à laquelle il faut, dans les épidémies accorder la préférence. *Bull. Acad. roy. de méd. de Belg.* Brux., 1884, 3. s. xviii, 722-735.
- Svietlov, G.* Disinfection in contagious diseases—cattle plagues (Russian). *Arch. vet. nauk.* St. Petersburg, 1885, xv, pl. 4, 364-382.
- Szabó, D.* Sublimate as a disinfectant (Hungarian), *Orvosi hetil.* Budapest, 1884, xxviii, 1029-1037.
- Tangeman, C. W.* Disinfection. *Therap. Gaz.*, Detroit, 1884, n. s. v, 481-486.
- Tanret, C.* Des fumigations de parfums; trochisques désinfectants. *Bull. gén. de therap.* Par., 1882, 460-465.
- Testa, B.* Acido fenico ed acido picrico. *Scuola Med.*, Napol, 1883, vi, 419-440.
- Tissandier, G.* Use of sulphurous disinfectants (transl. from *La Nature*). *Pop. Sci. Monthly*, N. Y., 1885, xxvii, 218-222.
- Trauser, E.* Un nouvel antiseptique; l'aseptol ou acide orthoxyphényl sulfureux. *Union Méd.* Par., 1884, 3. s. xxxviii, 549, 558.
- Tripe, J. W.* Disinfectants in contradistinction to deodorants and anti-putrefactive agents. *Med. Times and Gaz.*, Lond., 1880, i, 51.
- Disinfectants as contra-distinguished from deodorants and anti-putrefactive agents. *Tr. Soc. M. Off. Health*, Lond., 1879-'80, 36-43.
- On the action of disinfectants on sewage and the living organisms contained therein. *San. Rec. Lond.*, 1880-'81, n. s. ii, 201-204.
- On the action of disinfectants on sewage and the living organisms contained therein. *Tr. Soc. M. Off. Health*, 1880-'81, Lond., 1881, 28-29, 1 pl.
- Disinfectants and their sanitary uses. *San. Rec.*, Lond., 1884-'85, n. s. vi, 437-442.
- Torrálbas, F.* Desinfectantes. *Ann. r. Acad. de cien. méd.* . . . de la Habana, 1881-'82, xviii, 184-191.
- Torres Muñoz de Luna, B.* Ueber die Anwendung des Stickstoffdioxyds als Desinfections-Präservativ-und Heilmittel in Cholerafällen (Abstr. Transl.). *Berl. klin. Wchnschr.*, 1886, xxiii, 140.
- Vallin, E.* Les nouvelles étuves à désinfection et les perfectionnements dont elles sont susceptibles. *Rev. d'hyg.*, Par., 1883, vi, 974-992.
- Expériences sur les étuves à désinfection des hôpitaux de Paris. *Rev. d'hyg.*, Par., 1884, vi, 25, 53.
- Quelques expériences sur les étuves à désinfection dans les hôpitaux de Paris. *Ann. d'hyg.*, Par., 1884, 3, s. xi, 255-271.
- De la désinfection de la chambre des malades à la suite des affections contagieuses. *Rev. d'hyg.*, Par., 1882, iv, 770, 782.

- La désinfection des amphithéâtres d'anatomie. Rev. d'hyg., Par., 1882, iv, 639-649.
- Recherches sur la valeur désinfectante de l'éther azoteux. Rev. d'hyg., Par., 1882, iv, 207-216.
- Traité des désinfectants et de la désinfection. Par., 1883, 808 pp. 8vo.
- Ueber die Desinfection der Krankenzimmer nach ansteckenden Krankheiten. Deutsche Vrtljhrsschr. f. öff. Gsndhtspf. Brnshwg., 1883, xv, 248-254.
- et A. *Gerardin*. Désinfectants. Dict. Encycl. d. sc. méd. Par., 1882, i, s. xxviii, 298-400.
- Vanden Corput*. Les désinfectants et les antiseptiques au point de vue de la prophylaxie de quelques maladies. Bruxelles, 1885. 8vo.
- Vaughan, V. C.* Disinfection with mineral acids. Med. News, Phila., 1885, xlvi, 62-64.
- Considerations concerning the practical use of mercuric chloride as a disinfectant. Med. News, Phila., 1885, xlvi, 235.
- Verbitsky, E. V.* Methods of disinfecting cholera excretions (Russian). Priloj. k protok. zasaid. Obsh. Kievsk. vrach. Kiev., 1886, 39-59.
- Vidal et Herscher*. Études à désinfection par l'air chaud. Par., 1881. 8vo.
- Vidal*. Désinfection obligatoire des appartements, etc., qui auraient pu être imprégnés du miasme variolique. Bull. soc. de méd. pub., 1879. Par., 1880, ii, 159.
- Vigier, F.* Le sulfo-carbol (acide orthoxyphénylsulfureux) ses propriétés physiologiques antifermentescibles et antiseptiques. Tribune Méd., Par., 1884, xvi, 328-333.
- Vigier, M. F.* Sur le sulfo-carbol et ses propriétés antiseptiques. Bull. et mém. soc. de thérap. Par., 1884, 2, s. xiv, 82-88.
- Vinay, C.* De la valeur pratique des étuves à désinfection. Lyon Médical, 1886, xvii, 545-560.
- De la valeur pratique des étuves à désinfection. Lyon Méd., 1887, lv, 67-75.
- Vore officielle Anvisninger til Benyttelse af Desinfektionsmidler. Ugesk. f. Læger. Copenhagen, 1882, 4, R. vi, 40-45.
- Warder, R. B.* An antiseptic called "ozone." Scient. Proc. Ohio Mech. Inst. Cincin., 1882, i, 40-44.
- Warrikoff*. Wirkung von Antiseptica auf Milzbrand contagium. Leipzig, 1884.
- Walz und Windscheid*. Der neue Desinfections-Apparat in Düsseldorf. Centralbl. f. allg. Gsndhtspf. Bonn, 1886, v, 426-438.
- Entgegnung, betr. den neuen Desinfections-Apparat in Düsseldorf. Ctrbl. f. allg. Gsndhtspf. Bonn, 1887, vi, 208-214.
- Weisgerber*. Le lazaret des épidémies à Strasbourg, et le nouvel appareil à désinfecter de M. A. Koch. Rev. d'hyg., Par., 1886, viii, 497-505.
- Weiss, F.* Zur Desinfection. Med. Chir. Centralbl. Wien., 1883, xviii, 478.
- Wenckrewicz, B.* Das Verhalten des Schimmelgenus *Mucor* zu Antisepticis und einigen verwandten Stoffen, mit besonderer Berücksichtigung seines Verhaltens in zuckerhaltigen Flüssigkeiten. Dorpat, 1880, 50 pp. 8vo.
- Wernich, A.* Desinfectionsverfahren. Wien. Med. Presse, 1883, xxiv, 965, 992.
- Ueber Desinfectionskriterien. Verhdl. d. Berl. med. Gesellsch., 1883, xiii, pt. 2, 158-178.
- Die Desinfection mit Brom. Deutsche med. Wchnschr. Berl., 1882, viii, 592.
- Desinfectionslehre. 2 Aufl., 358 pp. Wien., 1882. 8vo.
- Ueber Desinfections-Kriterien. Deutsche med. Wchnschr. Berl., 1882, viii, 329. Also, Berl. Klin. Wchnschr., 1882, xix, 585, 603.
- Ueber ein praktisches Desinfectionsverfahren mit Bromdampf und dessen sporen-tödtende Wirkung. Centralbl. f. d. Med. Wissenschaften, Berlin, 1882, xx, 180-183.
- Zur Hitzedesinfection. Gesundh-Ingenieur, Berl., 1881, iv, 215-220.
- Ueber Wahl und Ausführung von Desinfectionsmassregeln. Deutsche Vrtljhrsschr. f. öff. Gsndhtspf. Brnshwg., 1880, xii, 567-587. Also, Deutsche med. Wchnschr. Berl., 1880, vi, 498.
- Grundriss der Desinfectionslehre zum praktischen Gebrauch. Wien., 1880. 8vo.
- Ueber den gegenwärtigen Stand der Desinfectionsfrage. Wien. Klinik, 1880, vi, 199-220.

- Die neuesten Fortschritte in der Desinfections-Praxis. Wien. Klinik, 1887, xiii, 337-358.
- Wernitz, Iwan.* Ueber die Wirkung der Antiseptica auf ungeformte Fermente. Dorpat, 1880. 8vo.
- Westmoreland, J. B.* Carbolic acid. Atlanta M. & S. J., 1880-'81, xviii, 193-197.
- White, C. B.* Remarks upon "Disinfection," etc. N. Orl., 1880, 12 pp. 8vo.
- Whitelegge, A.* The present position of the question of disinfection. San. Rec., Lond., 1886, 7, n. s. viii, 389-394.
- Wight, O. W.* Experiments in disinfecting sewers. San. News, Chicago, 1885, vii, 45.
- Wolff, M.* Zur Desinfectionsfrage. Ctbl. f. d. Med. Wissensch., Berl., 1885, xxiii, 177-179.
- Ueber die Desinfection durch Temperaturerhöhung. Arch. f. path. Anat., etc. Berl., 1885, cii, 81-148.
- Wolffhügel, G.* Ueber Desinfection mittels Hitze. Gesundh-Ingenieur, München, 1887, x, 1-13.
- Ueber den Werth der schwefligen Säure als Desinfectionsmittel. Mitth. a. d. K. Gsndtsamte, Berl., 1881, i, 1-46.
- und *G. Knorre.* Zu der verschiedenen Wirksamkeit von Carbol-Oel und Carbol-Wasser. Mitth. a. d. K. Gsndtsamte, Berl., 1881, i, 1-8.
- Zinno, O.* Disinfezione e disinfettanti. Proposte, studii ed effetti. Napoli, 1884. 8vo
- Zlatovratski, N. H.* Disinfective apparatus in contagious diseases (Russian). Ejened. klin. gaz., St. Petersburg, 1884, iv, 337-341.



# INDEX.

---

A	Page.
Abbott, Dr. A. C., quoted or mentioned . . . . .	16, 40, 51, 123, 132
Dr. S. W., " " . . . . .	117
Acid, carbolic, action of, upon vaccine lymph . . . . .	28
as an antiseptic . . . . .	41, 82
and disinfectant . . . . .	27
experiments with, on various micro-organisms, . . . . .	160
germicide powers of . . . . .	29
in surgery . . . . .	27
better than mercuric chloride, when . . . . .	166
chromic . . . . .	36
hydrochloric, as a disinfectant . . . . .	34
mineral, action of, on lead pipes . . . . .	37
as disinfectants . . . . .	36
nitric . . . . .	36
nitrous, as a disinfectant . . . . .	35
osmic . . . . .	36
phenyl-acetic, as an antiseptic . . . . .	82
phenyl-propionic, as an antiseptic . . . . .	82
sulphuric, as a disinfectant . . . . .	35
various, as a product of putrefaction . . . . .	82
Aluminium, tersulphite of, as a germicide . . . . .	77
Animals, convulsions in, produced by mouldy meal . . . . .	184
Anthrax bacilli (see Bacilli anthracis).	
ptomaines in . . . . .	202
spores, action of certain acids upon . . . . .	83
chlorinated atmosphere upon . . . . .	23
chromic acid upon . . . . .	36
hydrochloric acid upon . . . . .	34
mercuric chloride upon . . . . .	42
osmic acid upon . . . . .	36
<b>Apparatus for the Application of Dry and Moist Heat in Disin-</b>	
<b>fection, by Dr. George H. Rohé, . . . . .</b>	<b>89</b>
Aspergillus nigrescens, action of chlorinated atmosphere upon . . . . .	24
destruction of . . . . .	24, 25
B	
Bacilli <sup>1</sup> acidi lactici . . . . .	129, 143
action of heat upon . . . . .	137-149
alvei . . . . .	128, 145
anthracis . . . . .	10, 25, 26, 43, 44, 52, 57, 60, 61, 78, 79, 81, 145, 155, 196, 206, 208
action of carbolic acid upon . . . . .	30
certain disinfectants on spores of . . . . .	13

The various bacilli given in this index will be found mentioned in various other places in connection with experimental work. The same remark applies to micrococci and spores.

Bacilli anthracis, action of cupric sulphate upon . . . . .	39
heat upon . . . . .	141
hydrogen peroxide upon . . . . .	22
mercuric chloride upon . . . . .	41
moist chlorinated atmosphere upon . . . . .	23
permanganate of potassium upon . . . . .	20
zinc chloride upon . . . . .	40
culture of . . . . .	125
in the production of ptomaines . . . . .	202
Brieger's . . . . .	127, 143
butryicus . . . . .	129, 145
cholera . . . . .	202
comma . . . . .	120
action of heat upon . . . . .	138
crassus sputigenus . . . . .	128, 143
cyanogenus . . . . .	143
Emmerich's . . . . .	127, 143
fluorescent . . . . .	129, 143
Friedlander's . . . . .	127, 143, 155
indicus . . . . .	128, 143
of fowl cholera, . . . . .	24
mouse-septicæmia, culture of . . . . .	126, 142
destroyed in chlorinated atmosphere . . . . .	24
<i>schwimerothlauf</i> . . . . .	126, 142
prodigiosus . . . . .	128, 143, 149
punctum . . . . .	31
pyocyanus . . . . .	128, 143
relation of, to blood corpuscles . . . . .	126
spore-forming, action of heat upon . . . . .	145
subtilis . . . . .	39, 40, 43, 45, 60, 61, 64, 78, 80, 81, 82, 84, 85, 86, 129
action of mercuric chloride upon . . . . .	41
agents that will destroy . . . . .	14
effect of permanganate of potassium upon . . . . .	19
power of resisting heat of . . . . .	20
used as a test of germicide powers . . . . .	10
syncyanum . . . . .	129
termo . . . . .	26, 31, 32, 35, 85, 86
tuberculosis . . . . .	128
action of heat upon . . . . .	148
typhoid . . . . .	123, 177
action of calcium oxide upon . . . . .	169
carbolic acid upon . . . . .	162
cold upon . . . . .	150
heat upon . . . . .	149
mercuric chloride upon . . . . .	159
sulphate of copper upon . . . . .	167
and ptomaines . . . . .	205
destroyed by chloride of lime . . . . .	154
results of alternate freezing and thawing of . . . . .	150
various, action of sulphate of copper upon . . . . .	167
culture of . . . . .	121-123, 170
effect of heat upon . . . . .	78
experiments with carbolic acid upon . . . . .	161
chloride of lime upon . . . . .	155
sulphurous acid gas upon . . . . .	60



Bacilli, Wurtzel . . . . .	129, 145
Bacteria, action of permanganate of potassium upon . . . . .	20
classification of . . . . .	178
in the production of ptomaines . . . . .	177
of fowl cholera, action of chlorinated atmosphere upon . . . . .	24
putrefaction, action of carbolic acid upon . . . . .	31
the cause of putrefaction . . . . .	177
Bedding, disinfection of . . . . .	234
<b>Bibliography from 1880 to 1888</b> , by Dr. George H. Rohé . . . . .	<b>242</b>
Blood corpuscles, relation of bacilli to . . . . .	126
septicæmic, action of sulphurous acid gas upon . . . . .	66
Bolton, Dr. Meade, quoted or mentioned 120, 134, 136, 138, 155, 159, 162, 164, 166, 168	
Boston, quarantine disinfecting station at . . . . .	115
Bromine, when an efficient disinfectant . . . . .	26
vapor, action of, upon various germs . . . . .	25
<b>C</b>	
Calcium oxide, experiments with, as a disinfectant . . . . .	169
<b>Carbolic acid</b> , by Dr. Charles Smart . . . . .	<b>26</b>
Cesspools, disinfection of . . . . .	240
Cheese, poisoning, symptoms of . . . . .	193
poisonous . . . . .	192
experiments with poison of . . . . .	194
spirillum . . . . .	123
action of heat upon . . . . .	138
Chloride of lime, available chlorine in certain preparations of . . . . .	7
<b>Chlorine, Bromine, and Iodine</b> , by George H. Rohé . . . . .	<b>23</b>
Chlorine, action of, on various germs . . . . .	24
inconvenience of, as a disinfectant . . . . .	25
when an efficient disinfectant . . . . .	26
Cholera, action of heat upon spirillum of . . . . .	138
Asiatic, experiments with the spirillum of . . . . .	120-124, 155
discharges, disinfection of . . . . .	84
experiments with . . . . .	179
infantum due to tyrotoxon . . . . .	206
spirillum, action of calcium oxide upon . . . . .	169
mercuric chloride upon . . . . .	159
various disinfectants upon . . . . .	174
culture of . . . . .	121
experiments with . . . . .	138
the ptomaines of . . . . .	202
Clothing, the disinfection of . . . . .	234, 238
Cogswell, Dr. Charles H., quoted or mentioned . . . . .	117
<b>Commercial Disinfectants</b> , No. 1 and No. 2, by Dr. George M. Sternberg <b>8, 16</b>	
Committee on disinfectants, how created . . . . .	5
members of . . . . .	5
<b>Considerations Concerning the Practical Use of Mercuric Chloride as a Disinfectant</b> , by Dr. Victor C. Vaughan . . . . .	<b>47</b>
Copper, sulphate of, a favorite disinfectant . . . . .	38
as a disinfectant . . . . .	39
experiments with, as a disinfectant . . . . .	166
Copperas . . . . .	38
Corrosive sublimate as a germicide . . . . .	41
Councilman, Dr. William T., quoted or mentioned . . . . .	148
Creoline . . . . .	165

Culture experiments, methods used in . . . . .	133
temperature in . . . . .	136
flasks, how made . . . . .	133
fluids, preparation of . . . . .	133
<b>D</b>	
Dead, disinfection of the . . . . .	234
Deaths from poisonous mussels . . . . .	185
Diarrhœa, septic, disinfection of discharges of . . . . .	84
Diseases, certain, ptomaines in . . . . .	202
Disinfectants, commercial . . . . .	8, 16
list of, tested . . . . .	11
value of certain . . . . .	17
committee on, preliminary remarks of chairman of . . . . .	7
report of, for 1885 . . . . .	5
1886 . . . . .	87
1887 . . . . .	118
conclusions regarding . . . . .	118, 233
the most efficient non-destructive . . . . .	87
Disinfecting agents, various . . . . .	173
apparatus, Bradford's patent "safety" . . . . .	93
another form . . . . .	94
Dr. Ransom's self-regulating . . . . .	98
Dusseldorf . . . . .	114
Fraser's patent . . . . .	90
Geneste, Herscher et Cie's . . . . .	104
Jenning's . . . . .	102
Merke's . . . . .	95
Nelson's patent . . . . .	89
Scott's patent . . . . .	102
Schimmel's . . . . .	113
steam, for baled rags, etc., Parker and Blackman's . . . . .	112
chest, Dr. Heron Rogers's . . . . .	98
closet, Taylor's . . . . .	103
oven, Raetke's . . . . .	104
station at Strasburg . . . . .	114
Boston and New Orleans quarantines . . . . .	115
stove, Dobroslavine's "Selhydric" . . . . .	111
movable, Gibier's . . . . .	107
Disinfection and disinfectants . . . . .	236
apparatus for the application of dry and moist heat in . . . . .	89
requisites of a good (Parsons) . . . . .	87
as practised in the quarantine system of Louisiana . . . . .	215
bibliography from 1880 to 1888 . . . . .	242
conclusions regarding . . . . .	118, 233
cost of, in Berlin . . . . .	210
experiments in, test organisms employed in . . . . .	120
with germ culture . . . . .	134
general directions regarding . . . . .	237
of cesspools . . . . .	240
clothing, bedding, etc. . . . .	234, 238
excreta . . . . .	233, 237
furniture, and articles of wood, leather, and porcelain . . . . .	234
ingesta . . . . .	240
merchandise and the mails . . . . .	235

Disinfection of privy vaults . . . . .	240
rags . . . . .	116, 235
railway cars . . . . .	235
ships . . . . .	235
with bichloride of mercury . . . . .	218
the dead . . . . .	234
person . . . . .	234, 238
sick-room and the hospital wards . . . . .	234, 239
practical methods of . . . . .	208
street with mercuric bichloride . . . . .	212
with calcium oxide . . . . .	169
carbolic acid . . . . .	27, 160
chemical agents . . . . .	212
chloride of lime . . . . .	153
dry heat . . . . .	77, 87
heat . . . . .	137
mercuric chloride . . . . .	43, 48, 157
metallic sulphates . . . . .	38
moist heat . . . . .	80
potassium permanganate . . . . .	21
steam . . . . .	115, 209
sulphate of copper . . . . .	38, 39, 166
sulphur . . . . .	52, 77
sulphurous acid gas . . . . .	52
oxide fumigation . . . . .	221
<b>Disinfection with Mineral Acids, by Dr. Victor C. Vaughan . . . . .</b>	<b>33</b>
Disinfectors, Henneberg's . . . . .	209
Leoni's patent . . . . .	101
steam, Benham & Sons' . . . . .	106
Bradford's . . . . .	107
Herscher et Cie's . . . . .	110
Lyon's patent . . . . .	105
Reck's patent . . . . .	105
Dress goods, effect of sulphur disinfection upon . . . . .	70
Duggan, Dr. J. R., quoted or mentioned . . . . .	10, 12, 154
on the germicide power of the hypochlorites . . . . .	13
Durgin, Dr. S. H., quoted or mentioned . . . . .	115, 208, 212
on practical experiments with moist heat (steam under pressure) as a disinfectant . . . . .	115

## E

Eberth's bacilli (see Bacilli, typhoid).	
Ernst, Dr. H. C., quoted or mentioned . . . . .	147
Erysipelas, micrococci of, destroyed in chlorinated atmosphere . . . . .	24
Excreta, disinfection of . . . . .	233, 237
Experimental data, commercial disinfectants No. 1 . . . . .	8
<b>Experiments on Burning Sulphur in Closed Rooms, under Direction of Dr. J. H. Raymond . . . . .</b>	<b>68</b>
<b>Experiments with Sulphurous Acid Gas, by Dr. J. H. Raymond . . . . .</b>	<b>65</b>

## F

Ferric sulphate . . . . .	39
Finkler-Prior spirillum, action of heat upon . . . . .	138
Flesh, decomposing, poison contained in . . . . .	179
Food containing poisonous ptomaines . . . . .	185

Fumigating furnace . . . . .	222
Fumigation with sulphurous oxide . . . . .	221
Furniture, disinfection of . . . . .	234

## G

<b>Germicide Power of the Hypochlorites</b> , by Dr. J. R. Duggan . . . . .	13
Glanders, virus of, experiments with . . . . .	54
Gonococcus of Neisser, action of heat upon . . . . .	146
Griffin, Dr. Arthur G., quoted or mentioned . . . . .	117

## H

Ham, poisonous . . . . .	191
Heat, action of, on spirillum of cholera . . . . .	138
various disease germs . . . . .	140
application of dry and moist . . . . .	224
dry, as a disinfectant . . . . .	77, 87
effect of, on micro-organisms and spores . . . . .	137
moist as a disinfectant . . . . .	80
Holt, Dr. Joseph, quoted or mentioned . . . . .	88, 115, 208, 219
on quarantine system of Louisiana. Methods of disinfection practised . . . . .	215
Hospital wards, disinfection of . . . . .	234
<b>Hydrogen Peroxide</b> , by Dr. George M. Sternberg . . . . .	21
Hydrophobia, experiments with . . . . .	147

## I

Ice-cream, poisoning . . . . .	200
Ingesta, disinfection of . . . . .	240
Iodine, disinfecting power of . . . . .	26
when an efficient disinfectant . . . . .	26

## L

Labarraque's solution, available chlorine in certain preparations of . . . . .	17
Lead pipes, action of mercuric chloride upon . . . . .	49
mineral acids upon . . . . .	37
Leather, disinfection of . . . . .	234
Leeds, Prof. Albert R., quoted or mentioned . . . . .	22
Lime, chloride of, experiments with, as a disinfectant . . . . .	153
in the disinfection of feces . . . . .	84
bi-sulphate of, as a germicide . . . . .	77
Liquor sodæ chlorinatæ, available chlorine in certain preparations of . . . . .	17

## M

Mails, disinfection of . . . . .	235
Meat, poisonous . . . . .	78
canned . . . . .	191
(ham) . . . . .	191
Merchandise, disinfection of . . . . .	235
Mercuric bichloride in the disinfection of vessels . . . . .	218
not dangerous unless swallowed . . . . .	219
<b>Mercuric Chloride</b> , by Dr. George M. Sternberg . . . . .	41
action of, upon lead pipes . . . . .	49
as a disinfectant . . . . .	157
experiments with, as a disinfectant . . . . .	43, 48
in the disinfection of feces . . . . .	86
strength of aqueous solution of, necessary to destroy micro-organisms . . . . .	47

Mercury, antiseptic value of various forms of . . . . .	51
<b>Methods of Practical Disinfection</b> , by Dr. George H. Rohé . . . . .	<b>208</b>
<b>Micrococci</b> . . . . .	20, 41, 60, 61, 62, 63
action of carbolic acid upon . . . . .	162
sulphate of copper upon . . . . .	168
crepusculum . . . . .	31
gonorrhœa . . . . .	131
of erysipelas, destroyed in chlorinated atmosphere . . . . .	24
effect of bromine vapor upon . . . . .	23
fowl cholera, action of carbolic acid upon . . . . .	30
disinfected . . . . .	26
of pus, action of hydrogen peroxide upon . . . . .	22
destroyed . . . . .	26
septicæmia destroyed . . . . .	26
swine plague, action of heat upon . . . . .	80
Pasteuri . . . . .	132
prodigiosus . . . . .	24, 58
action of chlorinated atmosphere upon . . . . .	24
tetrigenus . . . . .	22, 24, 25, 39, 77, 131
action of hydrogen peroxide upon . . . . .	22
zinc sulphate upon . . . . .	39
destroyed in a chlorinated atmosphere . . . . .	24
ureæ . . . . .	62, 63
various . . . . .	129
action of heat upon . . . . .	78, 145
experiments with sulphurous acid gas upon . . . . .	60
Micro-organisms, methods of research in . . . . .	133
various, thermal death-point of . . . . .	151
Milk, how to prevent poisonous fermentation of . . . . .	191
poisoning . . . . .	196
epidemic from . . . . .	197
<b>Moist Heat</b> , by Dr. George M. Sternberg . . . . .	<b>80</b>
Mussels, poisonous, deaths from . . . . .	185
<b>N</b>	
New Orleans, quarantine disinfecting station at . . . . .	115
system at . . . . .	215
<b>P</b>	
Permanganate of potassium, germicide power of . . . . .	19
Person, disinfection of the . . . . .	234, 238
Porcelain, disinfection of . . . . .	234
<b>Potassium Permanganate</b> , by Dr. George M. Sternberg . . . . .	<b>18</b>
action of, on bacilli anthracis . . . . .	20
as a disinfectant . . . . .	21
in the destruction of micrococci of pus . . . . .	19
disinfection of feces . . . . .	86
<b>Practical Experiments on the Sterilization of Feces</b> , by Dr. George M. Sternberg . . . . .	<b>83</b>
<b>Practical Experiments with Moist Heat (Steam under Pressure) as a Disinfectant</b> , by Dr. S. H. Durgin . . . . .	<b>115</b>
Privy vaults, disinfection of. . . . .	240
Prudden, Dr. T. M., quoted or mentioned . . . . .	149
<b>Ptomaines</b> , by Dr. Victor C. Vaughan . . . . .	<b>177</b>
how to avoid being poisoned with . . . . .	207
in certain diseases . . . . .	202

Ptomaines, poisonous, in foods . . . . .	185
qualities relating to . . . . .	178
various, determined . . . . .	184
Pus, micrococci of, destroyed by permanganate of potassium . . . . .	19
Putrefaction, poisonous products of . . . . .	178
<b>Q</b>	
Quarantine requirements in Louisiana . . . . .	231
stations of Louisiana, Map of . . . . .	216
<b>Quarantine System of Louisiana—Methods of Disinfection Practised</b> , by Dr. Joseph Holt . . . . .	215
<b>R</b>	
Rags, disinfection of . . . . .	235
experiments in . . . . .	116
Railway cars, disinfection of . . . . .	235
Raymond, Dr. J. H., quoted or mentioned . . . . .	10, 58, 88, 117
experiments on burning sulphur in closed rooms under the direction of . . . . .	68
on experiments with sulphurous acid gas . . . . .	65
Rinderpest, infectious material of, destroyed by heat . . . . .	147
Rohé, Dr. George H., quoted or mentioned . . . . .	6, 81, 88, 138, 146
on apparatus for the application of dry and moist heat in disinfection . . . . .	89
chlorine, bromine, and iodine . . . . .	23
dry heat . . . . .	77
methods of practical disinfection . . . . .	208
zinc chloride . . . . .	40
Rooms, experiments in disinfecting, with sulphur . . . . .	70
<b>S</b>	
Sanitas . . . . .	11
Sarcinæ . . . . .	133
action of heat upon . . . . .	146
Sausage poisoning . . . . .	188
symptoms in . . . . .	190
poisonous . . . . .	178
Sepsin . . . . .	181
Sheep-pox, infectious material of, destroyed by fire . . . . .	147
Ships, disinfection of . . . . .	235
bilge of . . . . .	213
with bichloride of mercury . . . . .	218
Sick-room, disinfection of the . . . . .	234, 239
Smart, Dr. Charles, quoted or mentioned . . . . .	26, 88
on carbolic acid . . . . .	26
the disinfectant properties of putrefactive products . . . . .	82
Smith, Dr. William M., quoted or mentioned . . . . .	58, 117
Soda, bisulphite of, as a germicide . . . . .	77
hypochlorite of, as an oxydizing disinfectant . . . . .	46
Sodium hyposulphite, as a disinfectant . . . . .	77
sulphite, as a disinfectant . . . . .	77
Spores, various, action of calcium oxide upon . . . . .	171
carbolic acid upon . . . . .	163
sulphate of copper upon . . . . .	168
experiments upon, with heat . . . . .	137-149
Stables, disinfection of . . . . .	213

Staphylococcus pyogenes albus . . . . .	131, 145
aureus . . . . .	129, 145
citreus . . . . .	130, 145
Steam disinfecting apparatus [see disinfectors, steam].	
Steam as a disinfector . . . . .	115
Sternberg, Dr. George M., quoted or mentioned	14, 24, 26, 29, 32, 33, 35, 36, 40, 49, 54
	65, 67, 88, 194, 203, 218
on commercial disinfectants No. 1 and No. 2 . . . . .	8, 16
hydrogen peroxide . . . . .	21
mercuric chloride . . . . .	41
moist heat . . . . .	80
potassium permanganate . . . . .	18
practical experiments in the sterilization of feces . . . . .	83
sulphites . . . . .	77
sulphur dioxide . . . . .	52
the comparative antiseptic value of the salts and oxides	
of mercury . . . . .	51
the metallic sulphates . . . . .	38
" Wither's Antizymotic Solution " . . . . .	17
Stove, a disinfecting . . . . .	208
Streptococcus erysipelatos . . . . .	131, 145
Sulphates, metallic, as disinfectants . . . . .	38
<b>Sulphites</b> , by Dr. George M. Sternberg . . . . .	<b>77</b>
<b>Sulphur Dioxide</b> , by Dr. George M. Sternberg . . . . .	<b>52</b>
Sulphur, disinfection of rooms with . . . . .	70
with . . . . .	52-77
Sulphurous acid gas, as a disinfectant . . . . .	52
results of experiments with, upon various germs . . . . .	67
Swine plague, action of acids upon . . . . .	88
micrococci of, action of heat upon . . . . .	80
<b>T</b>	
Tar-acid disinfectants, various . . . . .	11
Tetanus, micro-organisms in . . . . .	204
ptomaines in . . . . .	204
<b>The Comparative Antiseptic Value of the Salts and Oxides of</b>	
<b>Mercury</b> , by Dr. George M. Sternberg . . . . .	<b>51</b>
<b>The Metallic Sulphates</b> , by Dr. George M. Sternberg . . . . .	<b>38</b>
Thermometer, new electrical registering . . . . .	211
Trichlorphenol . . . . .	164
Tubercular sputa, action of carbolic acid upon . . . . .	30, 32
chlorinated atmosphere upon . . . . .	24
experiments upon the disinfection of . . . . .	46
virus, action of certain acids upon . . . . .	83
Tuberculosis, discharges of, disinfection of . . . . .	84
Typhoid fever, bacilli of . . . . .	123, 177
action of calcium oxide upon . . . . .	169
carbolic acid upon . . . . .	162
cold upon . . . . .	150
heat upon . . . . .	140
mercuric chloride upon . . . . .	159
sulphate of copper upon . . . . .	167
and ptomaines . . . . .	205
destroyed by chloride of lime . . . . .	154
results of alternate freezing and thawing of . . . . .	150

Typhoid fever, delirium, possibly from ptomaines . . . . .	181
discharges, disinfection of . . . . .	84, 156
Tyrotaxicon . . . . .	195
experiments with . . . . .	200
in cheese . . . . .	195
cholera infantum . . . . .	206
ice-cream . . . . .	200
milk . . . . .	196
<b>V</b>	
Vaccine virus, action of carbolic acid upon . . . . .	28
chlorine upon . . . . .	24
corrosive sublimate upon . . . . .	45
heat upon . . . . .	146
nitrous acid upon . . . . .	35
sulphurous acid upon . . . . .	66
various chemicals upon . . . . .	34
as a test of disinfecting power . . . . .	53
effect of heat upon . . . . .	78
Vaughan, Dr. Victor C., quoted or mentioned . . . . .	194
on considerations concerning the practical use of mercuric chloride as a disinfectant . . . . .	47
disinfection with mineral acids . . . . .	33
ptomaines . . . . .	177
Vessels, special suggestions to owners, agents, etc. . . . .	231
<b>W</b>	
Wood, disinfection of . . . . .	234
<b>Z</b>	
Zinc, bisulphate of, as a germicide . . . . .	77
<b>Zinc Chloride</b> , by George H. Rohé . . . . .	40
action of, upon bacilli anthracis and other micro-organisms . . . . .	40
sulphate, an unreliable germicide . . . . .	39



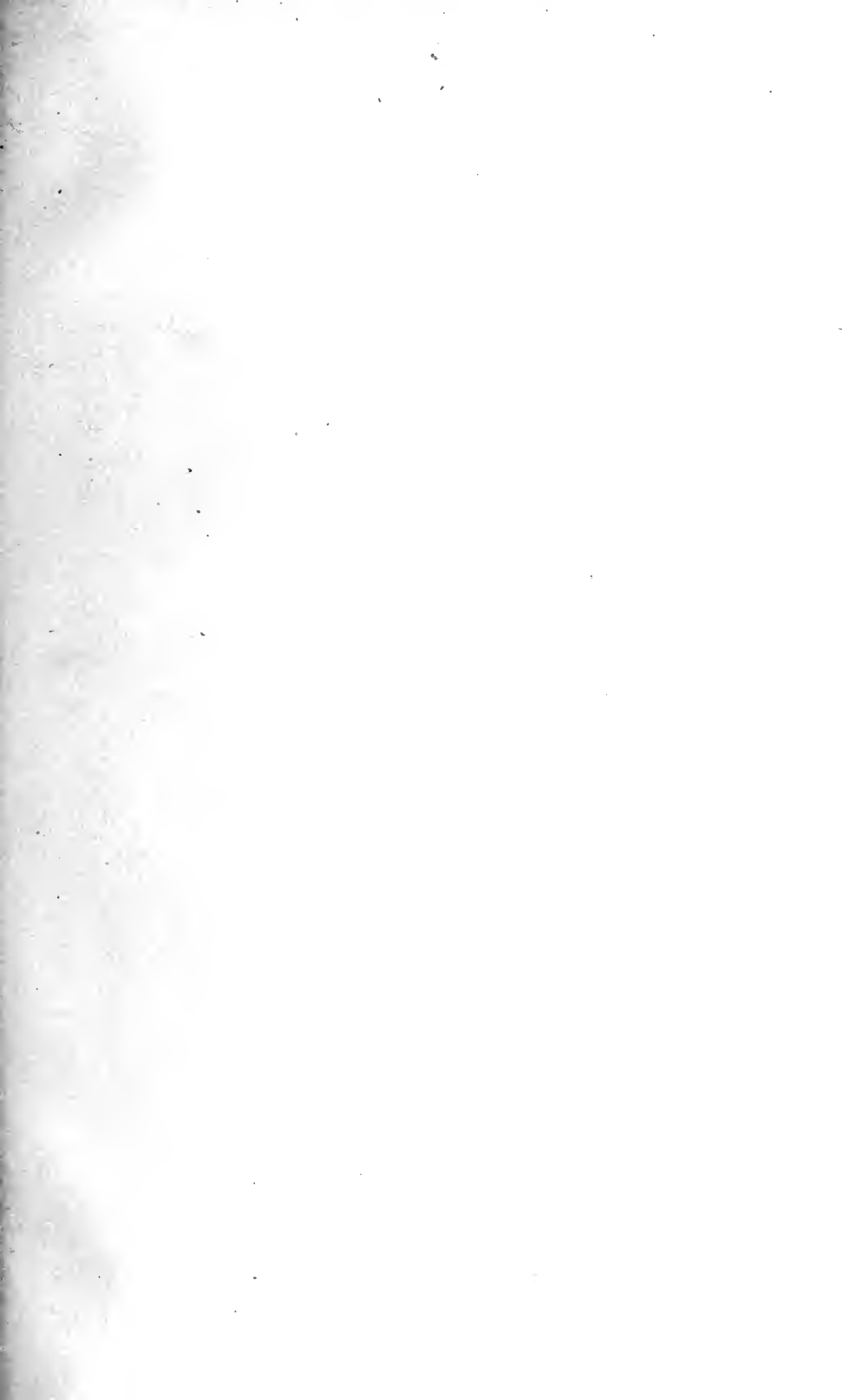







UNIVERSITY OF CALIFORNIA  
DEPARTMENT OF ECONOMICS  
HOUSEHOLD SCIENCE

THIS BOOK IS DUE ON THE LAST DATE  
STAMPED BELOW

**AN INITIAL FINE OF 25 CENTS**

WILL BE ASSESSED FOR FAILURE TO RETURN  
THIS BOOK ON THE DATE DUE. THE PENALTY  
WILL INCREASE TO 50 CENTS ON THE FOURTH  
DAY AND TO \$1.00 ON THE SEVENTH DAY  
OVERDUE.

PUBLIC HEALTH LIBRARY

FEB 26 1957

MAY 22 1957 *g*

OCT 9 1959

OCT 9 1959

NOV 6 1973

NOV 7 1975

SENT ON ILL

MAR 27 1996

U. C. BERKELEY



