

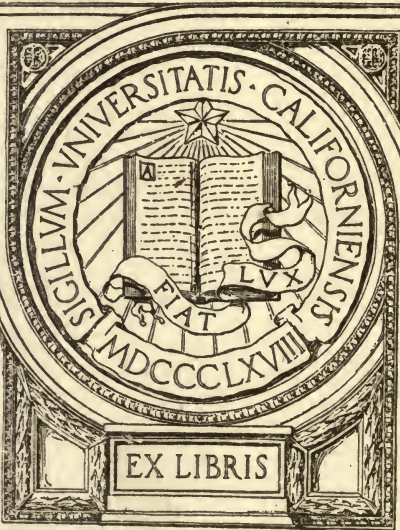

GIFT OF
MICHAEL REESE

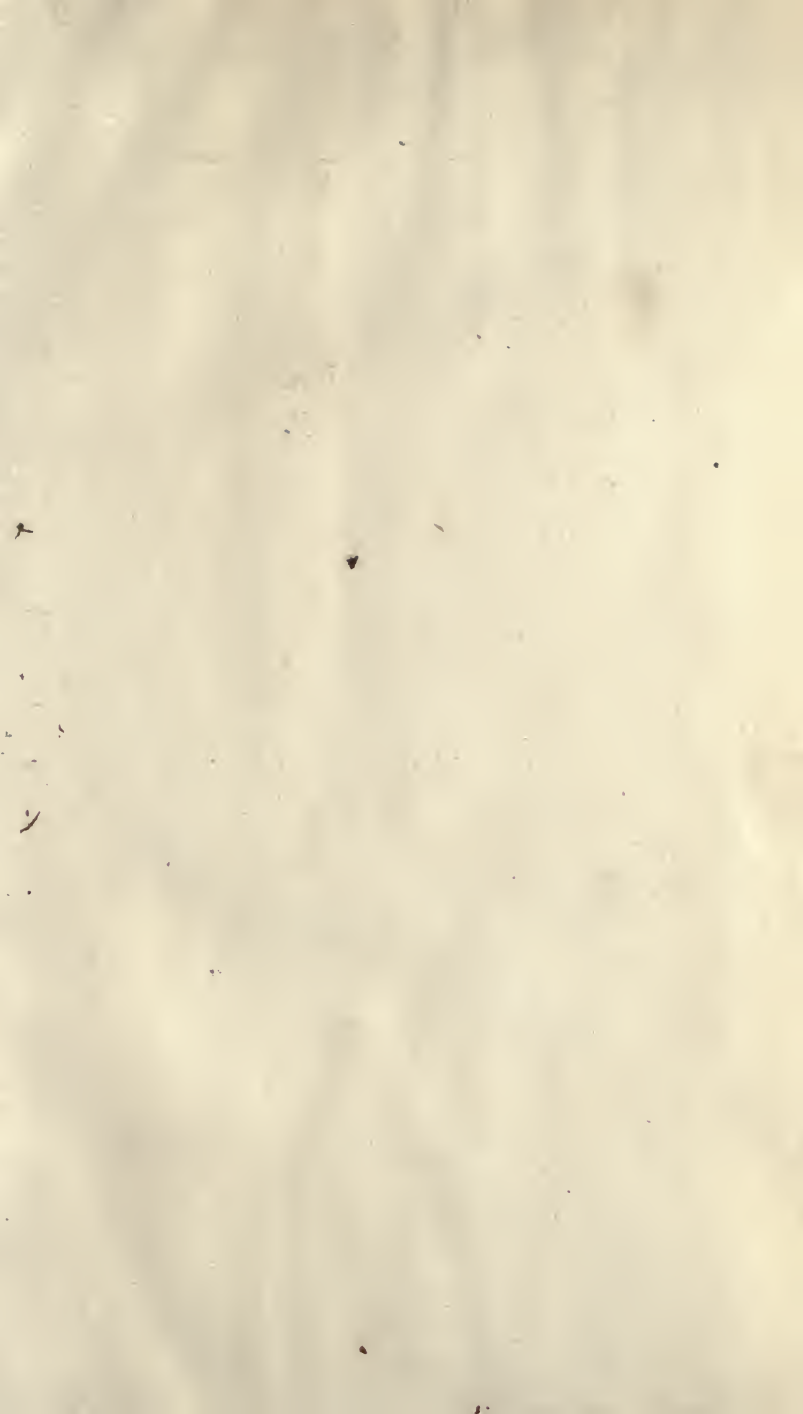

EX LIBRIS



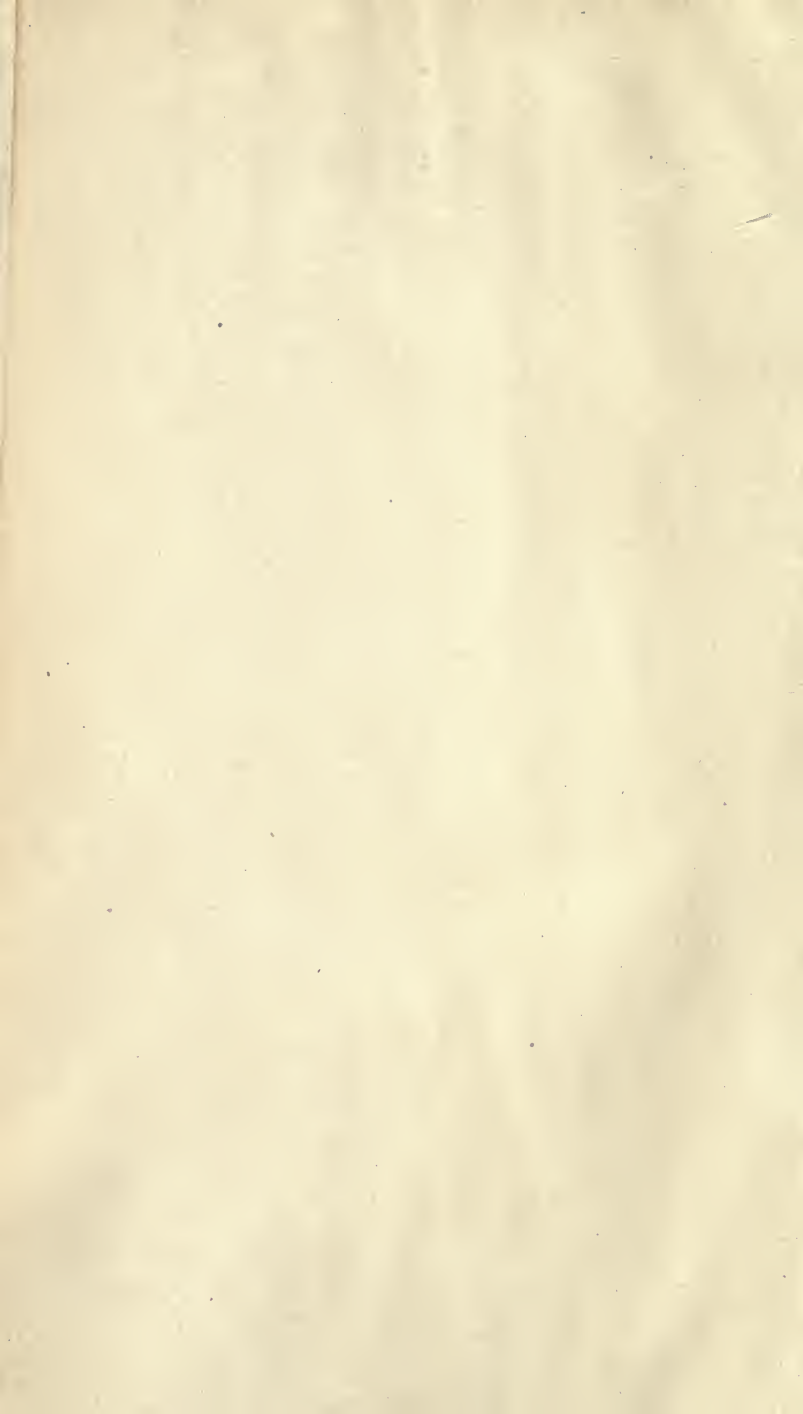



ECONOMIC MINING

A PRACTICAL HANDBOOK

FOR

THE MINER, THE METALLURGIST, AND
THE MERCHANT

BY

C. G. WARNFORD LOCK

MEMBER OF THE INSTITUTION OF MINING AND METALLURGY

AUTHOR OF 'PRACTICAL GOLD MINING' AND 'THE MINERS' POCKET BOOK'

SUPERINTENDENT WENTWORTH GOLD FIELDS PROPRIETARY CO., LD., LUCKNOW, NEW SOUTH WALES



London:

E. & F. N. SPON, 125 STRAND

New York:

SPON & CHAMBERLAIN, 12 CORTLANDT STREET

1895

TN145
L6

62049

INTRODUCTION.

NOTWITHSTANDING a fairly abundant mining literature, there is no room for doubt that a book founded on the lines of this volume will supply a want. The reason for this is that by the rigid exclusion of matters having only an academic or historic interest, space is afforded for dealing with just those points which, while perhaps not of a strictly scientific value, have nevertheless a high *economic* importance, and go far towards determining the profitable or unprofitable result of an undertaking. As mining and metallurgy are industrial pursuits, followed with a view to financial gain, the economic aspect is quite as deserving of study as the highly controversial questions regarding the history of strata and the genesis of ore bodies, on which geologists will probably differ till doomsday. Accepting the beds, and lodes, and veins as accomplished facts, this book endeavours to describe in plain language and with a practical aim how these deposits may best be worked under the various conditions encountered, and how the valuable portion of their contents can most cheaply and effectively be separated and prepared as marketable commodities.

To promote condensation and facility of reference, and to avoid repetition, those operations which are common to all mining and metallurgy are first described in general and comprehensive terms, and as far as possible in natural sequence. Next, the non-metalliferous minerals are taken in alphabetic order, a chapter being devoted to each, and embracing all the available practical information respecting their occurrence, working, extraction, preparation, qualities, uses, valuation, and commerce, with details of special processes and machinery employed.

Similar treatment is given to the metals and their ores in their turn, not omitting the metallurgical operations necessary for separating allied metals from each other.

Obviously, in the preparation of such a volume it is impossible to be independent of the experiences of others, and therefore originality is to be looked for less in the facts recorded than in the method of marshalling them, the one aim and object of the book being Practical Utility.

15 GEORGE STREET, MANSION HOUSE,
LONDON, E.C.

August 1895.

CONTENTS.



	PAGE
Prospecting	1
<p style="margin-left: 2em;">General indications. Veins. Diamond drills. Sampling the ore-body. Testing auriferous samples. Sampling base ores. Developing. Surveys.</p>	
Power	15
<p style="margin-left: 2em;">Sources. Water power. Oil engines. Electric power. Compressed air.</p>	
Drilling	33
<p style="margin-left: 2em;">Hand drilling. Machine drilling. Special forms of drill. Tapping wastes containing water.</p>	
Blasting	43
<p style="margin-left: 2em;">Explosives. Tamping. Electric firing. Water cartridges. Multiple wedges.</p>	
Shaft and Well Sinking	51
<p style="margin-left: 2em;">Methods successfully adopted for overcoming difficulties in wet and insecure ground.</p>	
Ventilation	59
<p style="margin-left: 2em;">Draft. Shaft fires. Blowers and Fans. Resistance to air-currents. Cooling and moistening air. Compressed air.</p>	
Lighting	65
<p style="margin-left: 2em;">Safety lamps. Oil <i>v.</i> Electricity.</p>	
Draining	71
<p style="margin-left: 2em;">Elementary water-lifting contrivances. Siphons. Hydraulic ejectors. Pumps of various kinds. Pumping systems on large scale compared</p>	

	PAGE
Mining and Winning	81
<p>Shafts, adits, tunnels. Timbering and securing. Overhead stoping. Underhand stoping. Nevada timbering. Examples of contingencies requiring modified systems of working. Rock-filling. Soft ore bodies. Stripping veins. Flat beds. Long-wall. Pillar and stall. Modifications. Props. Preserving timbers.</p>	
Hauling and Hoisting	103
<p>Wagons, tipplers. Underground haulage systems compared. Hoisting methods, and the conditions which govern them. Ropes. Drums. Safety cages. Counterbalances. Self-dumping skips. Coal dumps. Coal conveyors. Wire rope-ways.</p>	
Reducing	121
<p>Principles. Crushers, simple and multiple jaws. Jaw crushers for fine work. Rolls, dry and wet. Stamps, special forms. Edge-runners. Rollers. Huntington mill. Ball mills. Pneumatic pulverisers. Metal for wearing surfaces. Screens.</p>	
Concentrating	133
<p>Objects of dressing. Specific gravities of minerals. Effects of associated minerals. Separation by water. Jigging, principles and practice. Jigs. Pyramidal separating troughs. Vanners. Buddles. Slime frames. Magnetic separators. Dry concentration.</p>	
Non-metalliferous Minerals.	
Alum	153
Amber	155
Arsenic	156
Asbestos	163
Asphalt	167
Borax	174
Bromine	179
Cement	180

Non-metalliferous Minerals—continued.

	PAGE
Clay	185
Coal and Coke	191
Emery and Corundum	218
Fluorspar and Felspar	221
Fuel	225
Fullers' Earth	230
Gems	232
Graphite	249
Gypsum	253
Infusorial Earths	255
Iodine	257
Jet	259
Lime	261
Mica	265
Pearls	269
Peat	271
Petroleum, Natural Gas, and Ozokerit	273
Phosphates	292
Pigments	309
Potash	319
Pumice	321
Pyrites	322
Refractory Materials	326
Salt	333
Saltpetres	346
Soda	352
Stone	357
Sulphur	373
Talc	384

Metalliferous Minerals.

Aluminium	387
Antimony	399
Bismuth	408
Chromium	409
Cobalt	411
Copper	415
Gold	465



ECONOMIC MINING.

PROSPECTING.

WHILST it is true that some of the most remarkable mineral deposits have been discovered by accident, it is also true that the great majority have only been found by persistent search in accordance with recognised geological facts; therefore this volume cannot more fitly be commenced than with a few general hints on the finding of mineral deposits, and on the approximate estimation of the extent and richness of the find.

The first indications of a deposit possessing economic value are as a rule to be met with among the materials forming the beds of streams, and wherever watercourses have seamed and furrowed the rocks. Metalliferous deposits should be looked for in hilly districts as a general rule, though alluvial accumulations may be found in comparatively flat country. A close study of natural phenomena will often help in the discovery of mineral wealth. Thus the form and colour of the surface; stained patches; springs of water, whether sweet or mineralised; scum floating on water (petroleum, &c.); accumulations of earth brought to the surface by burrowing animals; changes in vegetation; behaviour of the magnetic needle. These, however, only serve to indicate existence without reference to quantity or quality. (See also the author's 'Miners' Pocket Book,' p. 263.)

Of the special conditions, geographical, stratigraphical, and mineralogical, under which each useful metal, ore, earth, or other substance may be profitably sought for, an account will be given under the heading of the particular product in view, and this information need not be summarised here. The object of the present chapter is rather to indicate how the true nature of the deposit may be studied and learned when its existence has been ascertained.

Veins.—As a preliminary it will perhaps be expected that something should be said concerning the source and origin of mineral veins regarded as a whole. To a certain extent this study borders on the theoretical side of geology, and is often dismissed by the "practical miner" as beneath attention; but the observations of painstaking mining engineers and geologists in recent years have tended to greatly simplify the subject and to place a proper understanding of it within reach of any intelligent miner. Moreover it is impossible that large-scale mining operations can be profitably conducted without due regard to geological evidence. Without trespassing on matter specially applicable to particular kinds of mineral

deposits, it will be useful to describe the main features of veins in general.

And here it may be well to warn the captious critic that the term "vein" is used in its wide sense as implying a mass of mineral matter enclosed in rocks of different character and affording useful metal or ore—in other words an "ore body"—for the multiplication of such terms as "lode," "reef," "shoot," "seam," &c., conveys no information without a detailed description in each instance.

Contraction of rock formations due to drying, cooling, and consolidation, is the primary cause of division planes or "joints," which often are subsequently magnified by other movements such as earthquakes, and afford convenient receptacles for the collection of ore-forming matters. To contraction as the cause of compression are also to be ascribed the foldings, fissures, and faults, which vary with the degree of resistance offered by the various beds. Sometimes the displacement accompanying the crush or faulting may be almost absent, at other times very marked, without affecting the ore body occupying the fissure. Part of the Comstock vein shows a vertical displacement of about 3000 ft. As a rule, when the direction of the fault or displacement is away from the workings, the continuation of the ore body should be sought *down* the dip, and conversely when the dip is towards the workings; but sometimes a reverse fault occurs. Veins occupying fissures in massive rocks will usually be more persistent on the dip than on the strike (i. e. in depth rather than in length), but in soft or diversified rocks no rule holds good.

Water, containing carbonic acid derived from the atmosphere, and possibly organic acids liberated by decaying vegetation, acquires great solvent powers under the influence of heat and pressure at considerable depths, and is the medium by which fissures are enlarged and modified, rocks are decomposed, and the selection and interchange of the constituents are brought about to form the secondary accumulations constituting the ore bodies and mineral deposits utilised by man. "Metasomatic" interchange between aqueous solutions of metallic ores and the carbonates of lime and magnesia in limestones and dolomites accounts for the formation of many metalliferous veins. The source of the metallic contents themselves is to be found in the igneous rocks. J. F. Kemp * quotes Dr. Mörice as finding native gold in obsidian, plagioclase, and sanidine; J. S. Curtis as demonstrating the existence of silver in quartz-porphry; G. F. Becker as discovering gold and silver in diabase, and antimony, arsenic, copper, gold, lead, and silver in granite; S. F. Emmons as detecting silver in porphyry; and he himself traces copper to augite. Prof. C. Le Neve Foster † is convinced "that many of the tin lodes of Cornwall have been formed by the alteration of granite." Finally, in the author's own experience, ‡ both gold and silver have been found in appreciable quantity in a recent lava near Myvatn, Iceland; and investigations of the porphyritic rocks associated with the important auriferous deposits of the Black Hills, South Dakota, carried out under the author's directions during the past year, proved that gold was present

* 'Ore Deposits,' p. 25.

† 'Ore and Stone Mining,' p. 7.

‡ 'Gold: its Occurrence and Extraction,' p. 715.

in every specimen examined, and in some cases to the extent of $2\frac{1}{2}$ to 5 oz. per ton.

The question whether the mineral solutions have flowed from above or from below has occasioned much discussion; probably each theory is right in turn and neither is universal. The influence of the wall rocks has been little observed and less understood; but it is undoubtedly a very important factor in most cases, and demands as much attention as the study of the ore body itself.

One word in conclusion as to the permanency of ore bodies. A little reflection will show that generalisations on this head are pure nonsense. To begin with, the sphere of action of the mineralised waters which have formed the ore bodies is necessarily limited and cannot be expected to continue to vast depths. Then again erosion may have removed the greater part of a deposit, so that what was once a deep vein now remains only as a shallow one. The only safe guide is *experience* of the particular *locality*. The "fissure vein" and its permanency is a fallacy founded on erroneous notions of the history of ore bodies; and while it must be admitted that only exploration will develop deep-lying deposits, it must be remembered that the *rule* is for ore bodies to *decline* in size and value as the depth increases, though of course some exceptions to this rule are encountered. In at least nine cases out of ten it will be found that if a mine does not pay for working the upper levels it will pay still less in depth.

Diamond Drills.—The solid core extracted by the diamond drill makes it a very useful implement for the prospector. Recently great improvements have been made in diamond drilling machinery as applied to exploratory work in mining. Considerable success is reported to have attended the introduction of these drills, especially in the operation of iron and coal mines. In mines of these classes diamond drills are eminently well adapted to the purposes of exploration, because of the peculiar character of the deposits in question.

Compared with the already recognised value of the diamond drill as an adjunct to the mining plants in coal, iron, copper, lead, and silver mining operations, the use will be limited in gold mining. Nevertheless, there are many classes of gold deposits where diamond drills can be very advantageously employed for prospecting purposes. Where the veins are narrow and the pay shoot undergoes apparent pinching, or exhibits changes of dip, strike, &c., or where the character of the gangue or vein-filling of the pay shoot is of no clearly marked difference (save in respect of gold tenure) from that of the barren portion of the reef, their use will not, as a rule, be advantageous. On the other hand, where the pay ore bodies are wide and the pay shoot is long, and there exists a conspicuous difference between the pay ore bodies and the barren reefs as to the character of the vein-filling, &c., drills may be of utility.

It may be well to remark, however, that in a new district it is advisable to let a very thorough surface prospecting precede the use of a diamond drill, because if no or but little gold can be found at or near the surface in the neighbourhood of quartz reef outcroppings, it is very unlikely that sinking will be adequately rewarded.

Diamond drilling plants are made to drill upwards of 3000 ft.,

and of various sizes, in accordance with the length of drill holes for which they are designed.

The construction of drilling plants and the uses of the various forms of tools are fully described and illustrated in 'Mining and Ore-

dressing Machinery,' but passing reference may here be made to the very useful hand-power diamond boring machine invented by Croëlius, made by Richard Schram & Co., London, and illustrated in Fig. 1.

This machine is intended and well adapted for prospecting purposes, for proving the existence of mineral lodes, for tapping water in old workings, &c., where it would be difficult to use steam power. Holes can be bored up to 300 ft. deep at any angle from the vertical to the horizontal, or inclined upwards. It can be arranged to bore holes underground.

The power is transmitted through the horizontal spindle A and bevel wheels B, to the boring spindle C, through which the boring rods D pass. The machine can be driven at about 60 to 70 rev. a minute. The advance motion is obtained by a weighted lever acting upon a toothed wheel E, with which is connected a wire rope passing round a pulley F, which is attached to the bore-spindle. The other end of the rope is fixed to the frame of the machine.

The crown G is set with diamonds of about 1 carat each in the usual way. The crown for ordinary purposes is $1\frac{1}{2}$ in. diam., and makes a core of 1 in. diam. Larger holes can, however, be bored with this machine if necessary. The crown G is screwed into the

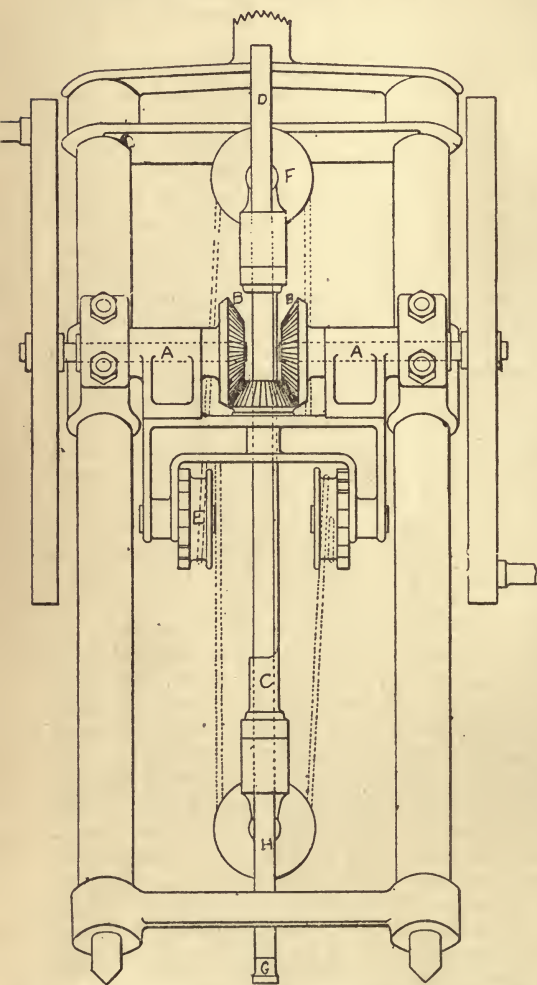

FIG. 1.—HAND-POWER DIAMOND BORING MACHINE.

core-barrel H, which is 3 ft. long; and the core-barrel is screwed into the boring rods, which are $4\frac{1}{2}$ ft. long and are provided with screwed couplings.

Water for washing away the *débris* and keeping the diamond crown cool, is supplied through the boring rods by a small hand force-pump; about 1 gal. of water a minute is required. From 2 to 4 men are required to work the machine, according to the depth of hole; and the speed obtainable varies from $5\frac{1}{2}$ to 13 ft. per shift of 8 hours, according to the hardness of the rock passed through. The total weight of the machine with 200 ft. of boring rods and all the necessary tools for working it is 14 cwt., and it can be taken to pieces for transport, so that no piece weighs more than 150 lb.

The cost of diamond drilling per foot is dependent upon the character of the ground, cost of power, labour, &c. The speed made exceeds sometimes 60 ft. per 24 hours. A good rate, however, allowing for loss of time incident to the operation, for depths of 200 to 700 ft., in rock of favourable character, would be 20 to 40 ft. per 24 hours. The most favourable kinds of rock are those which are homogeneous in their structure. Fissured rocks, or those in which cavities occur, are not favourable for drilling, owing to the liability of breaking the bit and rods, and the consequent delay. Hard rocks, if homogeneous, are favourable; but in very hard rocks the progress is less rapid and the wear of the carbons (diamonds) is greater than in softer homogeneous rocks.

At the present price of diamonds, a bit of 8 carbons, weighing $17\frac{5}{8}$ carats, costs about 50*l.* The consumption of diamonds is not so much due to the gradual abrasion incident to the grinding, as to breakage by pressure against the face of the rock.

The average cost of drilling is variously stated. In the United States, under ordinary conditions, it is estimated to range between 4*s.* and 8*s.* per foot. The averages of costs of boring in Victoria, Australia, in 1891, are officially quoted as below. They cover an aggregate of over 27,000 ft. in gold prospecting, and over 14,000 ft. in coal prospecting. In the case of the gold prospecting, the wear and tear of diamonds was responsible for about one-third of the total cost; in the case of coal prospecting, this item only amounted to one-fifth of the total. The average costs were:—

		Per foot.		
		£	s.	d.
Gold prospecting ..	{ diamond drills (inclusive of cost of wear and tear of diamonds)	0	11	$5\frac{1}{2}$
		0	5	$7\frac{1}{2}$
		{ other boring machines on contract		
Coal prospecting ..	{ diamond drills (inclusive of cost of wear and tear of diamonds)	0	10	$4\frac{3}{4}$
		Average cost per ft. for all descriptions of boring		

The use of corundum instead of diamonds is proposed as an economy.

Sampling the Ore Body.—A most important step in determining the value of a mineral deposit is to adopt a correct system of sampling.

For the sake of example, let us assume it to be a vein, with an average width of about 4 ft., varying say from 1 to 6 ft. Commencing at the bottom level, take from the face of one of the drifts across the

entire width of vein sample No. 1. To obtain this sample, break down 15 to 30 lb. of vein matter, allowing the broken rock to fall upon a piece of rough canvas stretched upon the floor of the drift. In selecting this sample, aim to break down, as nearly as possible, rock to represent the average character of the material at this point. Waste as well as clean ore occurring in the vein must be included in the sample. The 15 to 30 lb. of rock thus broken down are spalled upon the canvas, and quartered so as to obtain a sample of 4 to 6 lb. This sample is sacked, marked "No. 1," and sealed. The locality from which the sample is selected, the width of the vein at that point, &c., are noted.

In a similar manner sample No. 2 is taken, extending from point at which sample No. 1 was taken, across the vein towards the shaft, a distance of 10 to 15 ft. About the same quantity of material is broken down, and the sample is selected in the same manner as sample No. 1. This sample is likewise sacked, marked, and sealed.

Where there is a pinch in the vein, or where the vein is filled with waste, or where the rock is obviously of a grade too low to be profitably worked, it is not necessary to take a sample, but a note is made describing the condition of the ground at the point where no sample was taken.

In this way samples are taken from all parts of the mine, the winzes, upraises, backs of the stopes, drifts, shafts, &c., where there are exposures of ore.

These samples are all kept separate, and their values are separately determined. The values of the samples thus obtained are indicated on a diagram of the mine. The extent and method of occurrence of the ore body is thus graphically illustrated, and it can be readily seen whether or not it increases in length with increase of depth; likewise the continuous or spotted condition of the ore becomes apparent.

Determination of the cost of mining and milling having been made from investigation of the conditions of the mine, the delimitation or definition of the ore body and the amount of ore in the mine, can be readily ascertained.

In many wide veins the pay ore does not extend across the entire width of the vein, but is confined to a streak near the foot or hanging wall of the fissure. Sometimes, but more rarely, this streak occurs near the middle of the fissure. This pay streak is sometimes wide enough to be stoped profitably, whereas the stoping of the entire width of the vein would not pay.

In sampling such veins, where the ore body is not of even value, the sample should not be taken across the entire width. In such cases a sample should be selected for a width of 4 to 10 ft., beginning at the foot wall, and sampling towards the hanging wall. This sample should be marked "A." Another sample, selected for the same width as "A," should be taken from the uppermost part of the streak toward the hanging wall. This sample should be marked "B." In this way the entire width of the ledge is sampled, and separate tests are made of these samples to ascertain the width of any workable pay streak, if such pay streak exists.

These samples, A, B, C, &c., are further marked by numbers as "1 A," "1 B," &c., to indicate the points from which they were taken along the strike and dip of the vein.

In this way the miner can determine in what part of his vein the pay ore lies, and to what distance this pay ore extends in length, depth, and width. From such data, the value of the property can be estimated as far as developments extend, and predictions, to a great degree reliable, may be made as to the result of future developments upon the vein, based upon the character of the deposit as far as explorations extend. Of course, good judgment, based upon extensive experience, greatly enhances the accuracy of these predictions.

Testing Auriferous Samples.—The determination of the value of an auriferous quartz is usually made by means of the horn spoon, in which a few ounces of pulverised quartz or vein-filling is horned out, and an estimate is made of the yield of the quartz in free gold. Sometimes 1 lb. or more of the quartz is panned out in a miners' pan, and the value of the ore in free gold per ton is estimated from the quantity of gold saved in the pan. As a rule the amount of pulp taken for the test is not determined by weighing, nor is the quantity of gold saved ascertained by weighing, but is judged simply by the eye.

Such methods are obviously very unreliable, especially where gold ores of various localities are being tested, since the fineness or coarseness of the gold may vary so far as to make the estimate by the eye of the weight of the gold but little better than guesswork. A far better system is the following:—

Take a sample of 10 to 20 lb., the more the better. Select it without discrimination, so as to obtain a sample of the average character of the material of the vein where the sample is taken. Crush all this ore to about the size of walnuts, and from this lot by "quartering down" take a sample of about 3 lb. Pulverise this sample so as to pass it through a 40-mesh sieve. From this, by further quartering, select a sample of 1 lb. to be tested as follows:—

Having covered the hands with rubber or other gloves to prevent the introduction of greasy substances into the water used in panning, weigh out the sample (1 lb.), then work it down carefully in the batea or pan, preferably the batea, until most of the sands have been washed off; then add a few drops of mercury, which bring in contact with the gold by rubbing it throughout the pulp. Collect the small amalgam, and boil it slowly in nitric acid in a test-tube until the mercury disappears.

The application of heat (spirit-lamp) hastens the process by dissolving the mercury. Pour out carefully the acid, and wash out with water all traces of acid left in the test-tube; then pour the gold carefully into an annealing cup, and heat over spirit-lamp until the gold is thoroughly dry, when weigh it. This gives the amount of free gold per pound of ore, from which the free gold per ton may be readily calculated.

An approximation as to the fineness of the gold can be made by the eye sufficiently accurate for these tests.

Instead of "cutting" the amalgam by the use of nitric acid, the mercury may be volatilised by the blowpipe.

The tailings from this sample should be saved, and the sulphurets collected by washing off the sands. The sulphurets are to be then weighed; from this weight the percentage contained in the ore is ascertained, and an assay is made to determine their value per ton.

A few small vials with carefully weighed amounts of gold will be found useful for comparison with the pannings made upon the field. Such measures materially improve the guesswork otherwise practised.

Sampling Base Ores.—The sampling of the ores of the base metals is an equally important matter. For illustration let us take a 10-ton pile of 10 per cent. copper-ore, prepared for market. It will consist of masses generally the size of one's fist, smaller pieces, and even of dust. Procure a clean, tight floor or pavement, an iron mortar and pestle, a shovel, a small hammer, a piece of iron for an anvil, a broom, and a wheelbarrow, barrel, or box.

Begin by shovelling the pile roughly into the form of a flattened cone or flattened pyramid. Make a trench straight through the pile, cutting it into two nearly equal parts; again by a trench, at right angles to the first, divide these halves into four nearly equal quarters. A part of the ore taken from these trenches will form the sample required. Proceed as follows:—

Having the wheelbarrow ready, begin at the middle of any side of the made-up pile and cut the first trench. Cast the first shovelful to the right, the second to the left, the third into the wheelbarrow. Repeat this order of shovelling until the barrow is full; then empty it upon the well-swept floor intended to receive the sample. Continue in the same way until the trench has passed through the pile, when there will result two rather long and narrow piles. Begin the second trench, extending it across the middle of the two piles, casting the first shovelful right, the second left, the third into the barrow. Proceed in the same way as with the first trench. When done, you will have shovelled about 6000 lb. of ore. As every third shovelful was thrown into the barrow, there will result about 2000 lb. of sample upon the floor. That this is a fair sample of the original pile is based upon the assumption that each third shovelful thrown into the barrow was like the first and second ones cast into the piles. The hypothesis is reasonable and freely to be trusted.

Having the sample, proceed with it after the regulation method, as follows:—

Spread it thinly on the floor; now examine it. If there be any lumps which look larger than the general run, place the anvil upon the pile, and between that and the hammer break those lumps. The next step is to thoroughly well mix the sample. Begin at one edge of it and shovel the ore over upon itself. Move around to the opposite side of the pile, and from that side shovel the ore again upon itself and back into its original place upon the floor. Having it well mixed, form it into a flattened cone and sweep all the dust upon and around the pile. You have now to halve and quarter the sample as follows:—

Commence at any point and shovel a road through the centre of the pile, casting the shovelfuls alternately right and left as you proceed. This movement will result in cutting the pile into two elon-

gated nearly equal ones. Beginning at the middle of one of them, shovel a road through it in the same way as before. And in precisely the same way cut the other pile in two; sweep upon each pile the dust belonging to it. These movements will result in four piles.

If the sample were well mixed, as directed, then will each of the quarters, A, B, C, D, have the same composition as all the others. But if, upon inspecting them, you judge one or another to be poorer or richer than the other, you will then have sufficient evidence that the work has been badly performed. In that condition of affairs mix well together all the piles, and once more halve and quarter them. Having made all the quarters of the same composition, it follows that any two of them may safely be accepted as representing the original 2000 lb. of rough sample. This opens a road leading in the right direction, since it enables us finally to get rid of half the sample. We may cast out two of the quarters and retain the other two for the sample. It is a matter of indifference which two are retained, say A and B. Remove from the floor C and D, together with the dust belonging to them.

We have again to break the larger stones, until there remain none larger than walnuts. Place the anvil between the piles, within easy reach of them. Take a stone from A, break it; take one from B, break that. Continue in this way, taking stones alternately from each pile, until all are reduced to the size stated. By proceeding in this way, the sample is more or less mixed while being broken. Complete the mixing as before, by shovelling all the sample to and fro over the floor. Form it once more into a flattened cone, and sweep the dust upon and around it. Divide the cone into two halves, and those into four quarters as before. You have now to reject two of these quarters. The unwritten law of the sampler says that it must be those holding the positions A and B, because those were retained in the last quartering. Remove A and B from the floor, retaining C and D for the sample. These would now weigh about 500 lb.

Proceeding as before, break down the lumps of ore until none is left larger than, say, 1-in. cubes. Again mix well the sample, make it into a pile, sweep up the dust, halve and quarter the pile. Reject two quarters (C and D of course), retain two, as in former quarterings.

Once more break the lumps, this time down to $\frac{1}{2}$ -in. cubes. Mix well the sample, make it into a pile, sweep up the dust, halve and quarter; reject two quarters. The two quarters retained would weigh about 125 lb. Break it down until comparable to fine gravel and coarse sand. Mix and quarter once more.

The two quarters this time retained would weigh about 60 lb. With the mortar and pestle break this to something approaching coarse sand. Again mix and quarter. The quarters this time retained are to be ground yet finer, mixed, and quartered.

If you have no mortar and pestle, the hammer and anvil may be substituted throughout. After getting the material into the form of coarse sand, it is best to mix and quarter it upon a sheet of paper, even an old newspaper.

At this point the sample would weigh about 15 lb.; its larger grains would be in size like coarse sand. It would be safe now, without further breaking, to mix and quarter it twice, or until its weight did not exceed 4 lb. Run this through the mortar, and then mix and quarter it twice, or down to 1 lb. weight. Grind this to something approaching powder, and, for the last time, mix and quarter it. Have ready six wide-mouth 1-oz. bottles. Place them in a line, side by side, upon a sheet of paper. From the other paper pour the ground sample in a small stream, to and fro across the mouths of the bottles, until they are all full up to their shoulders. Cork, seal, and label them, and the sampling is done.

It does not matter of what solid a sample may consist, or how much or how little it may be, it should be worked down in the manner just detailed.

A word may be added as to larger and rougher ore piles than have yet been mentioned. It is not unusual to have a pile of 100 or 200 tons to sample. Such piles are apt to consist of lumps larger than a man's head, together with masses of all smaller sizes. Where a pile is formed by dumping ore uniformly upon its top, the likelihood is that the pile is homogeneous. In such a case it is safe to make short cuts into it at several points around its base, and to consider as sample the ore so got. It is safer to make one cut through the pile, retaining as sample each third shovelful, as in the case of the copper ore just considered. In forming ore piles of the weights given, it is a good custom to put upon a separate platform each tenth or twentieth barrow-load coming from the mine; the small pile will prove a fairly good sample of the large one. But no matter how it may be got, the rough sample is to be broken and mixed and proceeded with after the regulation method.

A very ingenious and efficient mechanical sampler was recently described and shown at a meeting of the Institution of Mining and Metallurgy.*

Developing.—When the value of a sample of a mineral deposit has been determined, the next consideration for the prospector is laying out the development work he proposes to do, to ascertain the extent and permanency of the ore body.

In the first instance, the exploratory work should as nearly as possible be confined to those portions of the property which give the most encouraging indications. The Mexican system of developing consists in closely following the discovered ore body; and when this fails, their explorations, if continued at all, are confined to the neighbourhood of ore bodies already proved.

This method has obvious merits in avoiding any appreciable expenditure on profitless deadwork, and in multiplying the chances of striking subsidiary veins and bunches of ore.

The character of the exploratory work is chiefly determined by the situation of the ore body to be prospected, and by the local topographical features. Where practicable, adits are preferable to shafts, especially in a country where veins carry much water. In addition

* T. Clarkson, "The Sampling of Ores and Tailings," *Trans. Inst. Min. and Met.*, ii. 229.

to the expense obviated by tunnels in draining the mine, the cost of extracting the ore is very greatly diminished as compared with that attending hoisting through shafts. Much greater depth upon the vein may be reached without it being necessary to resort to the erection of a hoisting plant, than where the ores are extracted through shafts.

Where possible, tunnels are run upon the vein. In some places, notwithstanding the fact that the topography admits of tunnelling, should it be necessary to run a long crosscut tunnel (tunnel not run upon the vein), or should the flat character of the country prevent the attainment of sufficient depth upon the vein to compensate for the expense of tunnelling, the vein should be prospected, other circumstances admitting (absence of great amount of water in vein), by shafts. The inclined shaft following the dip of the vein is generally adopted in prospecting the mines of California, the better to examine the character of ground being developed, and also, because it is usually cheaper to sink such shafts than vertical shafts outside of the vein formation.

The adoption of the best system of prospecting, whether by tunnels or shafts, must be determined by local conditions, and only after careful consideration of all the questions involved. Too often lack of discrimination in this matter involves the useless expenditure of much time and money, as well as often the accomplishment of but nugatory results.

The pay ore, as previously explained, often occurs disposed with more or less irregularity through the veins along its course as well as its dip. Several pay shoots of variable extent and pitch may likewise occur in the same vein and upon the same property. In order to ascertain the location, as well as the extent of these bodies of pay ore, exploratory work must be carried out. Such work should be systematically conducted, and the character of ground thus prospected be recorded upon a map of the underground developments of the mine. The developments by drifts, raises, stopes, &c., and the approximate width of the vein, should be monthly recorded upon such a map. Without a working map no scientific system of prospecting can be conducted. Such data, if comprehended by the superintendent, are of inestimable value in laying out his work. To prospect the ground, drifts and crosscuts are run, and winzes and raises are made.

The character of the ground will determine the most economical method of its exploration; but these explorations should be so planned as to cover the most ground with the least amount of exploratory work, and the work should be so laid out as to avoid the duplication of results. This seems axiomatic, but frequently long drifts are run in ground, the character of which had already been so satisfactorily established by other work as to be susceptible of reliable determination by sinking a winze from an upper level to prove the absence of ore bodies. Therefore, in ground in which the chances of discovering valuable ore bodies are very slight, this tendency to run drifts too frequently is to be avoided. There are few mines where much money has not been thrown away by fruitless exploration of this character. In other words, the sinking of a winze a short

distance, or the raising of an upraise for a short distance, will oftentimes conclusively establish the absence of pay ore bodies within the region to be explored, without the necessity of running frequent drifts through this barren stretch of country.

Of course, no arbitrary lines can be laid down as to the best system of prospecting, owing to the great differences that prevail in the occurrence of the ore bodies in various mines; but there should be a *system*. Where the vein is flat and small, and subject to many pinches and changes of strike and dip, it sometimes becomes necessary, in case the vein is lost, to defer the extension of the drifts until the stopes have advanced far enough to indicate the direction in which the extension of the vein may be looked for.

Surveys.—Too much care cannot be exercised in laying out first plans with accuracy and precision, and this can only be accomplished by the aid of levels, dials, and other engineering instruments, which can always be advantageously bought of W. F. Stanley, Great Turnstile, Holborn. Some of his mining specialties are described in his excellent little work on surveying instruments.*

The usual operations of mineral surveying and many hints and examples are given in the author's 'Miners' Pocket Book,' pp. 239–251. Space can only be found here for a description of an ingenious way of transferring surface alignments to underground workings through vertical shafts.† It is used a great deal in Montana, to depths of 2000 ft. and more; the operation monopolises one compartment of the shaft, but the cage may be run meanwhile in the other if at reduced speed.

The method is simply to hang two plumb-lines in one compartment in line with a determined surface alignment—this line, generally, being the centre line of the compartment—then range the instrument in line with the two plumb-lines, at the different levels where surveys are wanted.

By reference to Fig. 2 the points of the method can be understood. A is a horizontal cross section of the shaft, at the collar, showing the plumbing board in place, across the shaft, and the two plumb-lines, 3 ft. apart, centred in the alignment N. 20° 13' E. The plumbing board C, D, E is a 2 in. × 10 in. plank, 8 ft. long, provided with two movable supports for the wires. The support is a round iron rod $\frac{1}{2}$ in. diam. and 5 in. long, resting in two iron upright pieces D, d. The rod has a groove across one end of it for the wire to rest in, and the other end is seated against a set-screw and held against it by a small coil spring around the rod. The plumbing board is placed approximately in line and nailed firm; then centre each of the wires in line with the instrument, using the screws for setting the wires in line. The plumb-line should be a No. 22 copper wire; this will stand a 10-lb. bob, which is sufficiently heavy.

When the wires are centred in the supports, and they are ready to be let down, a small weight (1 lb.) is attached to the end of the wire and let down to the lowest level where alignment is wanted, and there made fast to one corner of the shaft, and pulled taut in the same corner as at the surface, so there will be no possibility of the other

* 'Surveying and Levelling Instruments.'

† L. Kuhn, En. and Min. Jl.

line coming in contact with it while being lowered. When both wires are down, the bobs are put on and each is placed in a pail of water; if the shaft is wet, use about 1 in. of common black oil on the surface of the water to prevent rippling by the water dropping down the shaft into the pails.

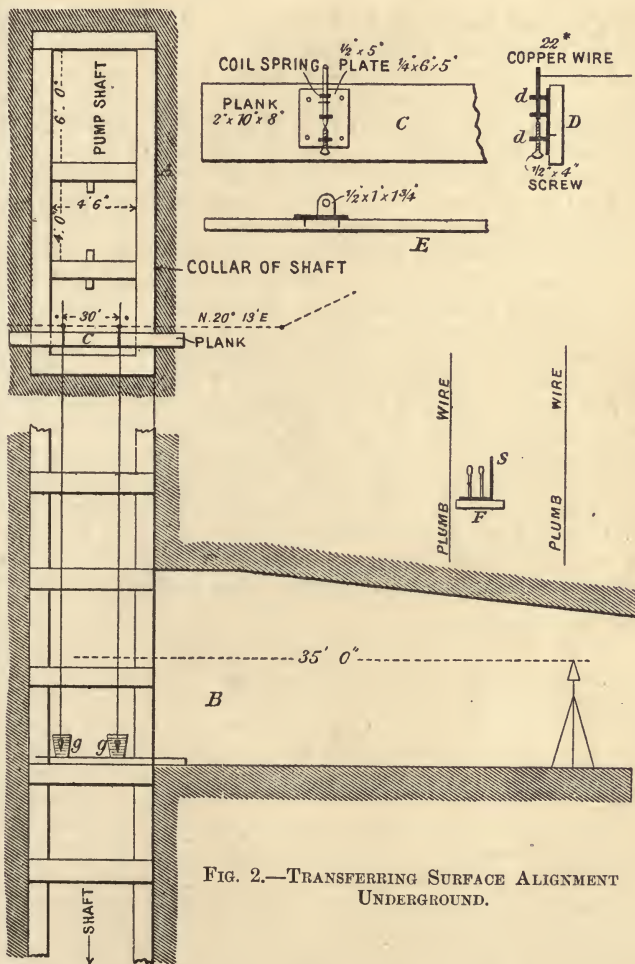

FIG. 2.—TRANSFERRING SURFACE ALIGNMENT UNDERGROUND.

The same signals used in hoisting can be used here to advantage, between the person at the bobs and the one at surface; as, for instance, three light jerks of the wire to raise it, two to lower, and one to stop. When the lines are still the instrument is ranged in line with the wires. From experiment, Kuhn found 35 to 40 ft. distant from the wires to be a good point to place the instrument. It will facilitate the work to light one of the wires, the one farthest from the

instrument, and have the wire nearest the instrument dark; in this way one will be able to distinguish the wires, having one light and one black. The light should be placed as close as possible to the wire to be lighted, but itself screened from view at the instrument so that only the light reflected from the wire is visible at the instrument.

B is a vertical cross section of the shaft and station, showing bobs in the pails, the two plumb-lines, and the instrument. F is an enlarged section of an arrangement which Kuhn used to advantage. Six common candles are placed close to the wire, and hid from view by the screen S. The base on which the candles rest should be 2 in. longer than the screen, then by placing this end of the screen about 1 in. to the side of the line of the wires, the base will be a light surface for the dark wire. An incandescent lamp is the best light but common candles will answer.

When the instrument is in line, permanent line points are set within the caps of the station. When these are set and connected with the wires by measurement, the transfer of the alignment to this level is completed, and the other levels are proceeded with in the same manner, the wires not being molested until all are finished. A check can be made by recentring the wires 1 in. backward or forward which will give a parallel line. However, if the wires are exactly the same distance apart at the bobs as at the surface, it would be almost impossible for either of them to touch at any point of the shaft. One of the wires is the O station for the mine and all surveys of the mine, both surface and underground, begin or are connected with this station O. Let all angle points be stations; that is, make each station an angle point running consecutively from O. If traverses are used in mapping, the O of the surveys is the O of the traverses.



POWER.

A MATTER of no small importance is the source from which power is to be derived for working drills and cutters, hauling and hoisting the mineral, pumping water out of the workings, and driving the reducing and dressing machinery.

In general terms, it may be said that

Water power is cheaper, but less dependable owing to frosts and droughts.

Steam power is dearer, but is more reliable.

Besides these, a third must be mentioned, namely the petroleum engine, whose great advantage over either is that it can be applied in positions which almost preclude the other forces.

In addition to these prime sources of power, there are two important secondary or intermediate motors, which give effect to force derived from some other source. These are compressed air and electricity.

Water Power.—The value of a water power* depends upon a variety of elements; numerous conditions may reduce its value. The essential points to be considered are as follows:—(a) Quantity of water during a dry year; (b) uniformity of flow during the year, considering the storage capacity, natural and artificial; (c) head of fall; (d) conditions which fix the expense of building dam and canal, and flowage of land; (e) conditions which affect the cost of foundations for buildings; (f) geological conditions which determine the permanency of the falls; (g) freight charges for fuel, supplies, raw materials, and finished product; (h) how much low-pressure steam can be used for heating purposes; and whether exhaust steam can be used for those purposes; (i) if water is needed for other purposes than power, and in what quantities; (k) the greater uniformity of speed with steam than with water power. The value of a variable power is usually nothing if its variation is great, unless it is to be supplemented by a steam plant. It is of value then only when the cost per horse-power for the double plant is less than the cost of steam power under the same conditions for a permanent power. The value of a developed water power is as follows: If the power can be run cheaper than steam, the value is that of the power, plus the cost of plant, less depreciation. If it cannot be run as cheaply as steam, considering its cost, &c., the value of the power itself is nothing, but the value of the plant is such a sum as could be paid for it new, which would bring the total cost of running down to the cost of steam power, less depreciation. That is, it is worth just what can be got out of the plant and no more.

* C. T. Main, 'Value of Water Power.'

Channels.—The section of the channel in which the water is led to the water motor depends on the ground in which the channel is cut. If the channel be made in brickwork or masonry, the angle of its sides would be 90° ; in stone without mortar, 60° ; in clay, 45° ; in coarse gravel and stones, 40° ; in finer gravel, 35° ; in sand, 30° ; in ordinary soil, 25° . Regarding the speed of water in channels, it will be understood that it runs at its highest rate just below the water surface, decreasing toward both the bottom and the sides. The average speed at which water can be run depends largely upon the nature of the material in which the channel is cut; soft material will not admit of the water running over it so rapidly as hard material. The nature of the water must also be considered. Some water brings mud, and other carries sand. In some instances, the settling of this sand in the channel is a great hindrance: but if the water runs at a speed of 9 in. per second when muddy, and twice as fast when carrying sand, no disadvantage by settling will be felt. The maximum speed of the stream should be in ordinary soil, 3 in. per second; sand, 1 ft.; fine gravel, 2 ft.; coarse gravel, 3 ft.; stony ground, 4 ft.; rock, 5 ft.; larger rock, 6 ft.; solid rock, 10 ft.

Pipes.—Should it be necessary to lead water through pipes, as is generally the case for turbines, such pipes should not be longer than is absolutely necessary, owing to a loss by friction in them. From end to end they should be equal in diameter. Any difference in the section will cause friction and loss of efficiency, as every increase or decrease in the section alters the speed of the water, and consequently causes it to whirl at that particular part of the pipe. Sharp bends should be avoided; if bends are necessary, they should be arranged on an easy curve, the radius of which should not be less than double the diameter of the pipe. It will be understood that sharp bends and other obstructions in the pipe have a similar effect to that caused by a decrease in fall.

Many water-power plants otherwise well designed are rendered inefficient by bringing the water to the turbine in pipes which are too small for the quantity they have to carry. If much water is to pass through a small pipe it must of necessity flow fast. Except under unusual conditions, even for large sized pipes, no higher speed than 6 ft. per second should be used. High speeds of flow involve a loss of working head. For example:—If a pipe 1000 ft. long, with 100 ft. fall, is 7 in. diam., and the quantity of water flowing through it is 100 cub. ft. per minute, the speed is 6 ft. per second. The pressure at the bottom of the pipe is 43 lb. per sq. in. when no water is passing, but when 100 cub. ft. per minute is flowing through, the pressure is reduced to $33\frac{1}{2}$ lb. per sq. in.; this is equal to a loss of 22 ft. head. A 9-in. pipe should be used if it is important to make the most of the water power; the loss will then be under 7 ft., or only 7 per cent. instead of 22 per cent.

Motors.—Water motors are divided into two classes, vertical water wheels and turbines, which are mostly horizontal. Vertical water wheels are classed as undershot wheels, breast wheels, and overshot wheels. Their efficiency varies very much according to the circumstances under which they perform their work. Breast and overshot wheels give up to 75 per cent. of the theoretical power.

Ordinary paddle water wheels are not much used in this country, but can be seen in large rivers on the Continent, where they float in the middle of the stream. Their diameter varies from 12 to 20 ft. The speed on the circumference is about half the speed of the stream. Their efficiency ranges from 25 per cent. to 30 per cent.

Undershot wheels are mostly used for small falls, generally less than 3 ft. The diameters vary from 10 to 20 ft., the speed on circumference being about equal to half the speed of the stream, similar to the paddle water wheel, and the efficiency is also the same, ranging from 25 to 30 per cent.

The Poncelot wheel ranges in diameter from 10 to 20 ft., the speed on circumference varying from 10 to 12 ft. per second, efficiency being from 50 to 55 per cent. The fall is about 4 or 5 ft.

There are two kinds of breast wheels, the low and the high. The diameters of these wheels vary from the fall of the water to double this measurement. The speed on circumference ranges from 5 to 6 ft., and the efficiency from 55 to 75 per cent. The water enters the low breast wheel slightly below its centre, and in the case of the high breast wheel it enters above the centre.

Overshot wheels are generally used where high falls can be obtained, and but small water quantum. Their diameters are generally equal to the fall, or slightly higher, the speed on circumference being from 4 to 5 ft., and the efficiency from 65 to 70 per cent.

Below is given a table of water wheels with their usual diameters, and the head of water at which they work most satisfactorily:—

FALL, QUANTITY OF WATER, AND EFFICIENCY OF WATER WHEELS.

Kind of Wheel.	Suitable for Falls of	Gallons of Water per second.	Efficiency, per cent.
Paddle	3 in. to 1 ft.	50 to 200	25 to 30
Undershot	6 in. to 3 ft.	20 to 1000	25 to 30
Poncelot	9 in. to 5 ft.	20 to 800	50 to 60
Low breast	2 ft. to 5 ft.	20 to 600	70 to 75
High breast	5 ft. to 10 ft.	20 to 600	70 to 75
Pitch-back	10 ft. to 30 ft.	15 to 200	70 to 75
Overshot	15 ft. to 40 ft.	10 to 100	65 to 70

With paddle and undershot wheels, the quantity of water is of less importance, as in cases where such wheels are used there is generally more water available than is necessary to drive them. The pitch-back water wheel mentioned in the table is similar to an overshot wheel, but turns in the same direction as the breast wheel, that is, in the opposite direction to which the water is running. All paddle, undershot, and Poncelot wheels work in the same direction as the stream is flowing.

The only merit possessed by the preceding forms of water motor is their simplicity, making them available where a more efficient but more complex form would be undesirable, owing to inability to execute necessary repairs. Whenever possible, they are now replaced by turbines, whose great advantage is that they utilise the *vis viva*

possessed by the water in virtue of the velocity with which it arrives upon the wheel, this velocity being due to height of fall. The water is brought upon the buckets or blades of the turning portion of the wheel, or turbine proper, by channels distributed over the whole, or sometimes over a portion only of the circumference of the turbine; these, with their various parts, constitute the fixed part of the wheel, sometimes called the distributor. Turbines may be erected upon either vertical or horizontal shafts. There are two classes of turbines with a vertical shaft. In those of the first class the water arrives horizontally upon the blades of the revolving part of the wheel through the interior of the latter, and issues horizontally, thus flowing away from the axis. The revolving blades form thus a series of vertical cylindrical channels included between two horizontal walls. In those of the second class, the water enters the wheel from above and issues from below, remaining thus at a constant distance from the axis.

In any application of water power, or indeed any other form of power, certain losses of effect are unavoidable; but the turbines made on the "vortex" pattern, as designed by the late Prof. J. Thomson, and manufactured by Gilbert Gilkes & Co., Kendal, materially reduce these losses. In them the power is obtained with slower velocity of water than in ordinary turbines. This is effected by balancing the centrifugal force of the water in the revolving wheel against the pressure due to half the head, so that only one-half the fall or head is employed in giving velocity to the water, the other half acting simply in the condition of fluid pressure. Hence the velocity of the water in no part of its course exceeds that due to one-half of the fall, and the loss from fluid friction and agitation of the water is thus materially lessened. The principle of injection of the water from without towards the centre produces another saving of effect, since it admits of the use of long and well-formed channels, by which the water is made gradually and regularly to converge in passing from the outer chamber (where it is comparatively at rest) to the point of entrance to the wheel chamber, where its velocity should be greatest. Further, from the same principle of injection towards the centre, there is an accordance between the velocities of all parts of the moving wheel and the proper velocities of the water in its passage between the points of entrance and discharge. The water when it has its greatest velocity is admitted to the circumference of the wheel, which is the most rapidly moving part, and when it has, as far as possible, imparted its power to the wheel, leaves at the central portion, which has the least motion. The water enters from the guide passages, with the velocity at which the outer circumference of the wheel is moving and without change of direction, so that there is no loss from impact. The steadiness and regularity of motion of vortex turbines are remarkable, consequent upon the action of the centrifugal force of the water, which on any increase in the velocity of the revolving wheel augments, and so checks the supply entering from the guide-passages; and on any diminution of the velocity of the wheel, decreases and admits the water more freely; thus counter-acting, in degree, the irregularities of speed arising from variations in the work to be performed.

The double vortex with movable guide-blades is the best means of applying water power in many situations, and should be adopted on all medium and high falls in cases in which the amount of power employed varies considerably at different times, and the saving of water is important, so that it is necessary to use as small a quantity as possible to do the work required; or when the available supply of water is at times less than the full amount for which the turbine is designed. The consumption of water can then be economised to the utmost, as the passages can be regulated to admit only the exact quantity needed to do the work, or to suit the available supply. If the power required and the quantity of water available be very constant, the guide-blades may be fixed and the apparatus simplified, a

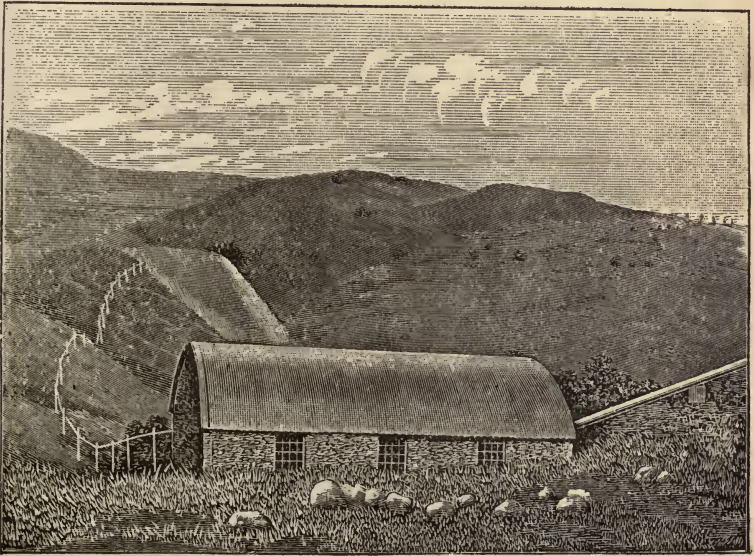

FIG. 3.—TURBINE HOUSE, HELVELLYN.

considerable saving in first cost being effected. The orifices through which the water is directed on to the revolving wheel are made of such a size as is necessary for the passage of the quantity intended to be consumed when the turbine is in full work.

When the fall of water is very high, the periphery of a turbine wheel must move at a very high speed, and if the revolving wheel is submerged, as in the case of Vortex or Lunedale turbines, there is some loss of power in the friction of the wheel-covers against the water. Again, if the wheel be of so small a diameter as to admit of an arrangement by which it receives the water all round, the speed of the axis must be very high, probably inconveniently so. It is therefore, in the case of a high fall, necessary to make a wheel of such diameter as will suit the speed of the axis, and to construct it in such a manner that it need not receive the water all round, and need not

run submerged. Such are known as "Impulse Turbines." There is no pressure between the guide-blades and the wheel, and as the water

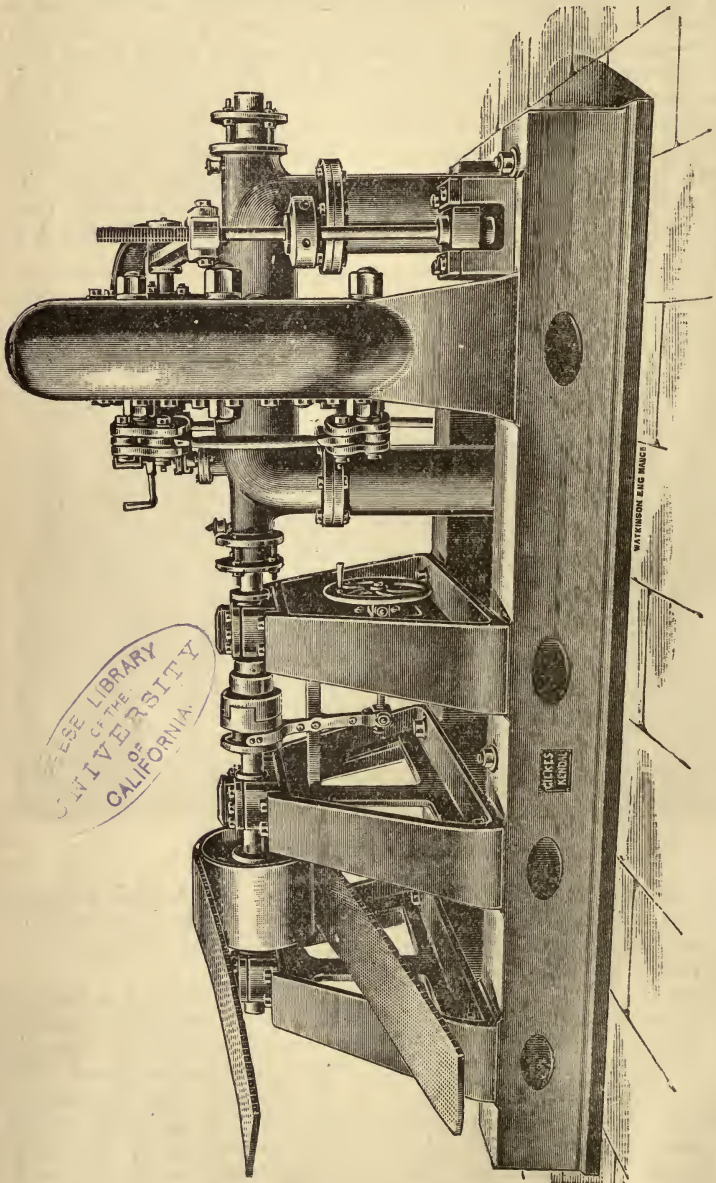

FIG. 4.—100 H.P. TURBINE, HELVELLYN.

enters the buckets with no pressure it is freely deviated by them, and takes a course quite independent of their shape. The action of the

water on the wheel depends on the angle through which each particle is deviated whilst freely flowing over the buckets, and as these latter are not full there is no disturbance of the action as they pass in front of, or away from, the jets. The well-known Girard turbine is of this type.

The transmission of power obtained from water, to a considerable distance, for use underground, is very well illustrated at the lead mines of the Greenside Mining Co., near the village of Patterdale, at the head of Ulleswater. The mines are on the slopes of Helvellyn. The Red Tarn and the Keppel Cove Tarn form the natural reservoirs in which the water is stored for use in these mines. Although this water is stored many hundred feet above the place where the power is required, it has until recent years been allowed to flow down the stream bed until it reached the mines, where it was made use of in Vortex turbines and water wheels; but since it has become easy to transmit the power electrically, the water is made to do work on its way downhill from the reservoirs. A channel has been cut from the Tarns, nearly following the contour lines for about a mile, where the water passes into a timber pentrough at the head of 15 in. pipes, which, descending very rapidly, bring the water into the turbine house (Fig. 3). This house is 400 ft. below the pentrough, and contains the turbine (Fig. 4), which is capable of giving 100 h.p. This turbine drives a dynamo, and the current, at 500 volts, is conveyed to the mines as shown in Fig. 3.

The Pelton wheel possesses undoubted advantages over some other turbines on very high falls. In common with the Girard, its efficiency is unaffected by the diameter of the wheel, and therefore the number of revolutions may be made small or great as required. It is, moreover, cheap, is easily kept in repair, and its efficiency under high falls is good. There are some cases in which it is the best form of turbine that can be used. In remote mining districts, duplicate buckets or nozzles can be fixed by any intelligent labourer. In mining work, when the water, before it reaches the turbine, has been used for sorting or milling, it contains sand, which in time cuts both the nozzles and the buckets, and it is a great advantage to be able to replace these without more than a few minutes' stoppage. The annexed table gives approximate costs of Pelton wheels to develop various powers with certain heads of water:—

H.P.	100 ft.	200 ft.	300 ft.	400 ft.	500 ft.	600 ft.	700 ft.
	£	£	£	£	£	£	£
10	36	22	16	8	10	12	14
20	42	30	23	25	18	19	20
30	56	40	31	26	26	20	21
40	70	46	38	32	27	27	24
50	71	46	39	33	33	28	29
75	90	55	45	39	40	34	35
100	92	66	52	46	40	41	36
150	118	87	62	53	47	48	41
200	120	100	63	54	54	49	50
300	120	102	109	65	66	54	52
400	135	110	111	86	67	68	55
500	150	130	113	117	89	72	69

Calculating H.P. given.—The driving power of water is obtained by its weight, and not by its velocity.

The power developed by a certain weight of water falling a certain height is equal to the product of the water in lb. and the fall in ft. The theoretical power in a fall of the water is consequently equal to

$$\frac{62.4 \text{ lb.} \times \text{cub. ft. per second} \times \text{fall in ft.}}{550}$$

62.4 lb. being the weight of 1 cub. ft. of water, and 550 foot pounds per second being equal to 1 h.p. Some wheels, however, are driven by sea water, sewage, or small streams containing impurities from factories higher up the stream. In such cases the formula given would be incorrect, as it is based on 1 cub. ft. of water weighing 62.4 lb. Sea water, for instance, weighs 64.1 lb. per cub. ft., and sewage water will be found to weigh 63 lb. per cub. ft., which would, of course, give a larger result than that mentioned in the formula.

The theoretical power cannot by any means be said to be the power available from the mill wheel shaft, as, in the first place, there is a leakage of water to be deducted from the efficiency, and in addition to this much power is lost by the friction caused in overcoming the resistance of the water wheel, and in this fact will be found the reason for the low percentage of power given by some water wheels.

From the last column of the table on p. 17, it will be seen that there is a loss of from 25 per cent. to 75 per cent., according to the type of water wheel. To calculate the actual power which may be expected from a wheel, the formula given will be found sufficient, but deduction must be made in accordance with the efficiency. For instance, if the wheel is of the pitch-back type, and of good construction, it may be expected to produce 75 per cent. of the useful effect or efficiency, consequently, from the result obtained by the table, 25 per cent. has to be deducted.

Turbines, in addition to generally giving a larger efficiency, may be said to possess still another advantage over water wheels, owing to the fact that they run at a higher speed, which can be directly transmitted in first motion shaft, while the action of the water wheel is so slow that it generally necessitates several pairs of geared wheels in order to obtain the desired speed, thus causing a further outlay of power.

Oil Engines.—The novel and important feature of the oil engine is the use of the common petroleum of commerce (kerosene and lamp oil) at once as fuel and working agent. From the petroleum in its crude state are obtained several oils—liquid hydrocarbons. The heavy oil remaining from the distillation is an excellent liquid fuel, and is used with most satisfactory results for generating steam, &c. The light or volatile products of petroleum, such as benzoline, gasoline, &c., have been used for producing motive power, but are used in a similar way to steam, and very many and serious accidents have happened with them. The other products from the crude petroleum are the intermediate oils, light lubricating oils and kerosene, or ordinary lamp or burning oils, and it is that form of hydrocarbon that is used as the source of power in the oil engine, the method employed being

the combustion of the oil within the cylinder of the engine. That oil is now procurable in all civilised countries at prices ranging in some places from $3\frac{3}{4}d.$ per gal. or even less. The engine is complete in itself; it requires no boiler to give a supply of steam, no supply of gas, the power in the oil engine being obtained direct from the oil which is in the supply cistern, the engine having to prepare its own charge of vapour for combustion. It has been found that the most satisfactory and only really reliable method of utilising the petroleum as a source of power is to employ it in the internal-combustion type of engines in a similar way to that in which coal gas is used. The engine, therefore, in general construction is very similar to a gas engine, working as it does upon the same principle—that is, by the internal combustion of a mixture of gas and air. In the oil engine the petroleum becomes the substitute for the gas, it being vaporised before entering the cylinder, and the heat generated by the combustion of a mixture of oil vapour and air inside the cylinder is used directly to expand the products of combustion and drive forward the piston. In the horizontal type of engine the cylinder and outside working parts rest and are fitted upon the foundation or bed-plate, which is a casting, hollow and of box form. Inside this bed-plate, and resting upon a sole plate which covers the entire under side of the bed-plate, is the reservoir, a closed iron vessel, in which is contained the oil for working the engine. The apparatus for vaporising the oil is also fitted within the bed-plate; and in connection with the reservoir, upon the side of the engine, is an air pump, which supplies air to the oil reservoir, that being necessary for forcing the oil through the spray maker into the vaporiser. The action of the engine is briefly this: The vapour is formed by the oil being forced from the reservoir through a pipe leading to the spray maker. There a fine jet of oil is met at the nozzle by a supply of air, and is completely broken up into a fine spray, which enters the chamber called the vaporiser; that being warm, the spray is quickly turned into vapour, and is ready for being drawn into the cylinder, together with the necessary amount of air to make a combustible charge. An explosion takes place in the cylinder every second revolution, the action of the piston upon its forward stroke being to draw into the cylinder a charge of vapour; upon its return that charge is compressed, and upon the crank turning its centre, an electric spark in the cylinder ignites the charge, giving the requisite impulse to the piston. The return stroke then exhausts the spent vapour, and the next stroke recommences the cycle. The spent vapour thus liberated, being at this point at a high temperature, is allowed to pass around the vaporiser, so that the heat is utilised in aiding the conversion of the incoming oil into vapour. After doing service in this way it escapes through the exhaust pipe. The electric spark which fires the compressed charge is produced by allowing a current of electricity to play between the ends of two platinum wires, which pass through the two insulating porcelains in the igniting plug, these being connected to an induction coil, for which a current is obtained from a simple primary battery of the Bunsen type. The oil engine is made in various forms, but the same method of working is carried out in all.

The reservoir in the bed-plate generally contains sufficient oil for a day's work, but in case of a prolonged run being necessary the supply of oil may be replenished in the reservoir without stopping the engine, either by gravitation from a larger oil supply tank, or by forcing it in by a hand pump. Amongst the openings for oil engines, their use in collieries, mines, &c., for underground work is specially noticeable. In deep workings of mines, the pumping of water, hauling, &c., has always been a source of trouble and expense, particularly when a considerable distance from the bottom of the shafts, so many difficulties attending the use of steam, compressed air, &c., apart from the cost of conducting such power, steam, &c., in pipes for long distances underground.

Among the objections to steam are (1) loss of power by condensation; (2) increase of temperature of intake or return; (3) difficulties in dealing with the exhaust; (4) bad effect of the exhaust, &c., i.e. moisture and increased temperature on the roof stone; (5) its use in confined places attended with danger in case of leakages.

With compressed air, some of the objections are dispensed with, but only comparatively small useful effect is obtained, more especially at high pressures.

In some cases where the oil engine has been adopted no other system can compare, either in first cost or actual working expenses, with it.

At one colliery a set of pumps were originally worked from the tail rope of the haulage system, and to dispense with this an oil engine and a double-acting pump were put down. These were placed at a distance of about 2400 yd. from the shaft, and at a point 165 vertical ft. in the dip. The engine was of 5-h.p., and drove the pump by belt, this being double-acting, having a barrel 6 in. diam., with a stroke of 18 in.; the water was forced a distance of 1320 yd. to a height of 72 ft. The engine house was walled in with two brick partitions, and the temperature never exceeded 65° F. The cost of working the oil engine plant was only 10s. 8d. per 10 hours, but here one man was charged for as being always occupied at the engine, whereas, in reality, after the engine was started it could be left and the man employed elsewhere. The cost of working the pump from the tail rope per 10 hours was 34s., or more than thrice as much.

For rock drilling in ironstone mines, A. L. Steavenson, of Durham, has put to work a number of drills worked by oil engines, the apparatus being specially designed by him. The power is transmitted by means of a rope band running in grooved pulleys; the spindle actuates the drill through bevel wheels connected to drill spindle. There is provision made in that to allow of the drill being released and drawn out when the hole has been bored deep enough. The position of the drill can be altered so as to cover the face of the rock up to 10 ft. high by 14 ft. wide. The result of working has proved that two holes, each 5 ft. 6 in. deep by 2 in. diam., have been drilled in 5 minutes, including the time required for changing the drills and moving from the first hole to the second. The averages taken over several days showed on one occasion 59 such holes per day

of $8\frac{1}{2}$ hours, with one skilled attendant. The tonnage per day was estimated at 150 tons, at a total cost of $8\frac{3}{4}d.$ per ton for labour, engine maintenance and fuel, as against 20 tons by hand labour at a cost of 1s. per ton. The large cost of the necessary piping and plant for drilling by aid of compressed air, and the serious loss of power by leakage, were the reverse of satisfactory, but the use of the oil engine dispensed with these difficulties.

It is not quite fair to compare the economy of the oil engine with that of the steam engine, as they are used under different circumstances. One gallon of petroleum weighs about 8 lb., and at $4d.$ this would be $\frac{1}{2}d.$ per lb. A ton of coal will be 10s., or $\frac{1}{10}d.$ per lb., against $\frac{1}{2}d.$ for oil. Coal is therefore one-tenth the price of petroleum, but the theoretical heat units of the coal are about 12,000, while those of the petroleum are 21,000 or 22,000, or, roughly speaking, about double. Thus, while coal is one-twentieth the price of oil it is only half as efficient. If oil were reduced to $1d.$ per gal. then it and coal would be on an equality.

In regard to cost of working, oil engines can not yet compete with the steam engine *here* using coal. But that is not the point altogether. Before coal can be used in the steam engine we must have a boiler and water. A good boiler will evaporate 10 lb. of water per lb. of coal used. In those situations where the coal and water have to be conveyed to the engine, we should have 10 lb. of water and 1 lb. of coal, altogether 11 lb., doing the work of $\frac{1}{2}$ lb. of petroleum. It is in such situations that oil engines will be very advantageous, also for rock boring at the ends of headways in non-fiery mines which are a long way from the shaft.

Electric Power.—An electrical power plant consists of four essential parts:—(a) steam or water power to drive the dynamo; (b) dynamo in which the power is converted into electrical energy; (c) conductor by which the current is carried from the dynamo to the motor; (d) motor which reconverts the electrical energy into mechanical work. The motor is simply a machine capable of giving so many h.p., and may be coupled to any required work by the ordinary methods—belting, gearing, &c. It is not necessary to understand the principles of the motor in order to successfully work an electrical plant.

Electric motors are being used successfully for drilling by impact and boring with diamond drills, and are able to compete with steam or compressed air. In rapid tunnelling, in running adit-levels, in deep and crooked workings, or in all work requiring hasty construction, the great trouble and expense of shifting and relaying pipes, with great losses due to leakage, &c., are avoided; the necessary wires are simply cleated to wall or posts as work advances, thus always being entirely out of the way. Furthermore, the room which pipes, &c., occupy in shafts is by no means small, and is an important item to be considered as compared with wires.

A mine ventilated by electricity, as it could be if electricity were used for drilling, &c., would not require compressed air for the benefit of the men.

The original cost of a compressed-air plant and its maintenance is

much greater than that of the electric system, and for large work, it is not as economical to operate.

For short distances only, and in open work, steam may be more advantageously employed; beyond these conditions it cannot be considered a competitor.

In placer-mining, and in mines of but a few hundred feet in depth also where there is uncertainty as to the location of workings, or the permanence of the location temporarily selected, as well as in all preliminary explorations, &c., the electric motor is so easily moved and applied, and its scope so great, that it is cheaper and better than any other, beyond certain limits. In very deep and large mines, however, permanently located, probably steam, acting direct, is to be preferred.

The best known application to mining haulage was made in 1882, at the Zauckerode pit, near Dresden, in Saxony. They employ there some 800 wagons, each of about 3 cub. ft. capacity. The motors are of 6 h.p., and haul trains of from 10 to 20 wagons, maximum weight 13 tons, at a speed of about 5 miles per hour. The length of track is $\frac{1}{3}$ mile. The cost of operation has been about $\frac{3}{4}d.$ per ton. The total cost of the plant was about 800*l.*

Since then great improvements have been made in the efficiencies of motors, which to-day range from 85 to 95 per cent.

Pumping is a most important application. For practical working, the only methods now employed to any considerable extent are those of direct-acting steam-pumps and pumps operated from the surface through wooden beams. Compressed air is too expensive, and there is no practical motor for driving pumps. Wire ropes are likewise expensive and inapplicable; and any hydraulic method is out of the question. Steam, for any considerable distance, is entirely impractical.

The application of the electric motor is simple, since most pumps are adapted for belts or gears. The only thing to provide for is a belt or a pinion for the armature-shaft. The intervening distance between the power-station, on the surface, and the point where the pump is needed, is of small consideration as regards construction, for copper wires can be easily run irrespective of distance or conditions.

A number of applications have already been made, notably at St. John's colliery, Normanton, and at the Thallern colliery, on the Danube. Another application is a small plant at the Trafalgar colliery, where the duty of the motor is to pump 114 gal. per minute through 3900 ft. of 7-in. pipe, with a lift of 300 ft.

One of the most interesting installations for electrical transmission of power for coal mining purposes in Europe is in operation at the Decize Collieries, France. This installation is remarkable from the fact that diphas alternating currents are employed for transmission, and diphas alternating current motors are used for reconverting the electrical energy into mechanical power at the different pits. In designing this plant the problem to be solved was to erect a central generating station for the distribution of electrical energy at the different pits where it could be utilised in electromotors for operating

ventilating fans, hauling machinery, pumps and for lighting purposes. A general idea of what had to be accomplished is shown in the annexed table:—

Site.	Distance from Generating Station.	Electrical Machinery or Lamps receiving the Current transmitted.
—West.	yards	
Puits des Chagnats ..	5090	30 h.p. electric motor.*
Fendue des Lacets	3466	” ” ” *
Puits des Coupes	2058	” ” ” *
Puits des Zagots	1084	Electric hauling machine of 15 h.p.†
—Generating station.		
Various installations ..	—	6 arc and 100 incandescent lamps.‡
—East.		
Fendue de Marizy	1300	30 h.p. electric motor and 24 arc lamps.§
Sorting and washing shops } of the Pré Charpin .. }	2490	500 incandescent lamps of 16 c.p.‡
Champfvert	3250	12 h.p. electric motor.

* Used for ventilating fan.

† Inclined plane.

‡ Lighting.

§ Ventilating fan and lighting.

|| Pumping.

The generating station is situated respectively at 3·1 miles and 1·86 miles from the extreme points which have to be supplied with current. It contains a battery of 6 boilers and 2 units (steam engines and dynamos), each of a capacity of 100 kilowatts; a further unit will shortly be laid down. The two units may be worked singly or in parallel. The engines are horizontal non-condensing, running at 200 rev. per minute, and driving the diphas alternators by belting. Each electrical unit comprises a twin alternator, or in reality two machines, placed one at each end of the shaft, the driving pulley carrying the engine belt being arranged in the middle of the shaft. Where current is employed both for lighting and for power purposes, one of the circuits may become more loaded than another, and in this event the equilibrium must be established by varying the ratio of the electromotive forces. The arrangement adopted in the Decize installation allows of this being accomplished, as each of the two circuits having a distinct field, it is only necessary to vary the exciting current by means of rheostats to get the desired effect. The generators introduced are Ziperowsky 10-pole alternators, with revolving field magnets. The 10 field magnets are connected together in series, and the exciting current is led to them by means of two metallic rings carried on an extension of the driving shaft on the opposite side to that of the driving pulley—that is to say, on an outer extension of the shaft. Two ordinary brass brushes press upon these rings, to which the exciting current is furnished by a direct current dynamo. This latter machine is operated by a belt from the shaft of the alternator. At 900 rev. a minute this direct current dynamo supplies the exciting current for the twin alternator, being between 25 and 30 ampères at 110 volts. The fixed armature of the alternators is formed of

10 coils, any one of which can be withdrawn and replaced with little trouble.

After passing through the switchboard, the current is transmitted mainly by means of overhead wires to the points of utilisation, the only portion laid underground being towards the end of the principal line leading to the Chagnats Pit. The wires forming the overhead line are of silicon-bronze, and are carried on porcelain insulators attached to poles 24 ft. high. The diameter of the wires constituting the principal line to the western part of the district is 6 mm., and 4 mm. in the case of the remainder of the line. The same pole carrying the transmission wires also support telephone wires, the latter being arranged 12 ft. from the ground. In order to counteract the effects of induction in the telephone wires, the line conductors are crossed at distances averaging 540 yd., and by this means the difficulty of understanding conversation along the telephone wires which use the earth as return, has been overcome. The small portion of underground line forms a lead-covered cable, laid in a wooden conduit, and also does the telephone line for the same distance. Suitable lightning conductors are provided at the generating and distributing sub-stations and at intervals along the line. The electromotors at the sub-stations, where the current is utilised for the different purposes mentioned in the table given above, are of the same type as the generators. These diphasic motors are easily set in operation, and are to all intents and purposes left to themselves for several hours together. The only attention they receive is a visit every 6 or 8 hours to ascertain whether the motors are working properly. The sub-stations are situated in the forest, and the facility of working of this system as compared with the erection in each place of a boiler engine and ventilating fan, is remarkable, apart from the question of the cost of transporting fuel.

From the published statements of leading electrical firms, it is possible to deduce approximate costs for transmission plants based on 100 h.p. units. The primary power (engine or turbine) is estimated at 8*l.* per h.p., the dynamos at 6*l.* per h.p., and the motors at 8*l.* per h.p., using 1000 volts. For distances of a mile or less, 80 per cent. efficiency can be counted on, and the cost of the electrical plant will be 16*l.* to 17*l.* per h.p., and of the total plant (including engine or turbine) 24*l.* to 26*l.* per h.p. For distances up to 5 miles 70 per cent. efficiency, and 27*l.* and 36*l.* per h.p. cost respectively. For 10 miles, 50–55 per cent. efficiency, and 40*l.*–42*l.* and 56*l.*–58*l.* per h.p. cost respectively.

Up to the present time a danger has been felt to exist in the use of electric motors in fiery mines, from the fact that bad setting or wearing of the brushes might result in sparking, and ignition of a gas that might be present; in fact, the use of electric motors in a mine where safety lamps were necessary has hitherto been considered unsafe. All previous attempts at the construction of a safe motor have taken the direction of encasing either the whole machine, the armature, or the commutator and brushes. These arrangements not only introduced difficulties in the ventilation of the armature, but

also necessarily included a considerable air space, so that when this space became filled with gas it would be possible for an explosion to take place inside the case, of such violence as to entirely destroy the case, and communicate with the outside atmosphere, thus causing an explosion. The safety commutator designed by Davis and Stokes, and made by John Davis and Sons, Derby, overcomes these difficulties, and is so arranged that the commutator itself is practically equivalent to a locked safety lamp enclosing the brushes, since it cannot be worked unless closed, and cannot be opened while running; the junction between the fixed and the revolving portions of the machine being made by a flame-tight joint which requires no packing and causes no friction.

The most marked deviation from the ordinary commutator is, that instead of the brush contact being on the outside of the cylinder formed by the commutator segments, this cylinder is hollow, and the brushes bear on the inside face of the segments. The method of construction is as follows:—The commutator segments are clamped between a ring and a disc, the latter being keyed on the shaft. This disc forms a permanently closed end to the commutator cylinder at the side nearest the armature. The brass bearing of the shaft is extended nearly up to the disc, leaving room for a slight end play (the shaft of course only bearing in the usual portion of the brass), and means are provided to prevent the oil from the bearing working along the extended portion of the brass and entering the commutator. The open end of the commutator cylinder is closed by a disc sliding on the extended brass bearing and carrying the brush holders and brushes; and a clamping handle provides for setting the disc and brushes in their proper position. This disc, as stated, closes the end of the hollow cylinder, the latter revolving with a clearance of $\frac{1}{32}$ in. from the disc; and in order to avoid the chance of the disc with its brushes being withdrawn while the machine is running, or started before properly closed, a locking ring is provided. Small windows are fitted in the disc, so that any sparking at the brushes can be seen and corrected; and the brushholders are furnished with springs working on the outside of the disc, for adjusting their pressure while running.

When it is necessary to clean the interior of the commutator and brushes, the locking ring is unscrewed, and the disc (with brushes attached) is slid towards the bearing as far as possible, thus leaving both commutator and brushes clear for cleaning and inspection; means are provided for attaching a small slide rest, so that by the use of a crank handle bolted to the pulley, the commutator can be turned up in position, should this be required.

Carbon brushes of a special type, admitting of very easy renewal, are used, thus obviating any trouble that might occur from accumulation of copper dust within the commutator with the ordinary copper brushes.

Compressed Air.—Compressed air is almost exclusively used in preference to steam as the direct motive power of drills. While the direct application of steam as the power to drive drills is far more

economical, there are many serious objections to its use underground the chief of which is the excessive heat which its use causes when employed in confined or close places. In addition to this objection there is a great loss of pressure in transferring the steam to the point of application, because of condensation in the pipes *en route* to the point. Hardly more than 40 per cent. of the power consumed in compressing the air to the required degree (usually 60 to 70 lb. per sq. in.) is utilised by the drill. This loss of power arises chiefly from the fact that none of the power expended in the compression of the air can be utilised, inasmuch as the air when applied to the drill does not act expansively. Power is thus wasted in the compression of the air by the transformation of this power into heat, which is subsequently lost by conduction and by radiation. Heat generated in the compression of air, not only results in loss of power directly, but is a further disadvantage, for the reason that the air during compression in the cylinder is cooled in the various compressors used, by the introduction of a spray of water into the cylinder, or by means of a flowing stream of cool water enveloping the cylinder. The loss through heat arises from the cooling contraction of the air, and the consequent decrease of the tension of the air as it passes from the compressor to the air reservoir. The heated air likewise, because of its increased tension due to the heat, reacts upon the piston causing a resistance, and consequently far less of the power is applied to the piston. The friction of the compressed air passing through the valves also causes a loss of power. These, with the other causes before adduced, will account for the small amount of power utilised in the application of compressed air to the drills. In short the power expended by the piston during the first part of its stroke is wasted in the compression of air, since, as above stated, the air cannot be applied expansively to the drills. This loss is unavoidable. The latter part of the stroke however, is utilised in driving the compressed air into the reservoir, under the pressure from which reservoir or receiver it is distributed to the drills. The lowest pressure in the transmission of the air from the receiver to the drills should not exceed 1 to 3 lb. per sq. in. for a distance of 1000 to 2000 ft., where pipes of sufficient diameter are used. Where pipes are too small, the loss due to friction may be very considerable. The proper diameter of the pipes will depend upon the number of drills used and the distance of the drill from the receiver.

In addition to its use as a power to drive the drills, the air performs a valuable service after it accomplishes the above work, when it is discharged in the drifts, or stopes, or wherever it may be used as exhaust air. In confined places, as at the face of a drift for example, this feature of the use of compressed air is often of great importance, though the use of compressed air for purposes of general ventilation of mines is inadmissible from an economical point of view.

The most perfect modern forms of air-compressor are made by the Ingersoll-Sergeant Co., and the following particulars of the pattern known as "class A" cannot fail to be interesting. The machine

complete in itself, both steam and air cylinders being situated on one solid bed. All strains are direct. The chief features are indicated in the annexed table:—

Diam. Steam Cylinder.	Diam. Air Cylinder.	Stroke.	Rev. per Minute.	Free Air per Minute.	No. of 3-in. Drills run.	Weight complete.	Actual Boiler h.p.	Cost.
in.	in.	in.		cub. ft.		lb.		£
10	10 $\frac{1}{4}$	12	160	183	2	5,500	30	250
12	12 $\frac{1}{4}$	14	155	295	3	7,400	40	313
14	14 $\frac{1}{4}$	18	120	398	5	10,800	55	417
16	16 $\frac{1}{4}$	18	120	518	7	12,000	70	521
18	18 $\frac{1}{4}$	24	94	683	10	20,050	100	636
20	20 $\frac{1}{4}$	24	94	840	12	21,400	130	709
22	22 $\frac{1}{4}$	30	75	1011	16	29,000	155	917
24	24 $\frac{1}{4}$	30	75	1202	20	34,500	200	1042

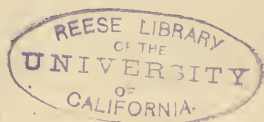



CALIFORNIAN PUMP, AS USED IN RIVER MINING.



"FLY CATCHING," OR COLLECTING FLOAT GOLD.

DRILLING.

A good deal of confusion arises from the application of a single word to convey two distinct meanings. The term "drill" is used to indicate an instrument which removes a solid core of the strata through which it passes—this is the diamond drill already alluded to under Prospecting (see p. 3); and to the common tool, simply a steel chisel, by which holes are made for the insertion of an explosive—which falls under notice in this section.

Despite modern progress in all kinds of machinery, a very large proportion of the drilling done at this day is still performed by hand labour. Sometimes the drill is worked single-handed, the workman holding and rotating the drill with one hand and wielding the hammer in the other, and sometimes the work is shared by two men or even three. In small undertakings hand drilling is always the cheapest and best.

In soft ground, or indeed, in tolerably stiff ground, drilling can be done cheaper or fully as cheap by hand as by power drills. This is true even where the power for the drills costs but little. But where the ground is very hard, drilling with power drills is more economical than by hand. The comparative cost of this system of drilling depends upon the hardness of the ground, and also upon the cost of the power for the air drills. The cost of power is of course exceedingly variable. Where steam is used for the power to compress air, the expense of the engineer must be added to the cost of running the air drill. Where the time of the engineer is to be charged entirely to this account, the cost of drilling will evidently be greater than when this item is apportioned among several charges, as hoist, pumping, &c., as well as where many power drills are used at the mine.

The same relation exists where water is used for power, some mines having free water, while others pay for all they use.

The drills generally used in California are 3 to 3½ in. diam. of cylinder, and require about 10 to 12 h.p. per drill. Where speed is an object, air drills are used to advantage, doing the same work as hand drills in about two-thirds the time in soft ground, to one-fifth the time in hard ground.

In drifting main tunnels, from which a large output of ore is to be made, two drills are employed in the face of the tunnel. This greatly expedites the progress of the tunnel, with not a greatly enhanced cost per ft. of tunnel run. The consumption of powder per ft. of drifts run is greater when air drills are used than by hand drilling. From two to four times the quantity of powder is used with machine drills as when hand drilling is employed, for the same length of drift run.

Air drills are often used to advantage in stoping. Where the vein is wide and the ground is hard, that method is preferable to hand drilling, but it cannot be used to advantage in small or flat veins.

Some mines employ as many as 6 to 10 drills in the stope. In the Idaho mine, Grass Valley, California, nearly the entire stoping is done by machine drills. Two men are required to run a drill. Self-feeding drills have, as yet, been introduced into but few localities.

The progress of drifting with drills varies with the hardness of the ground, &c. With a single drill, 100 to 150 ft. per month in hard ground is good speed. The cost per ft. in California varies from 14s. to 50s. in drifts about 4 ft. wide by 7 ft. high, exclusive of timbering and track. This is reckoned on the basis that two 3½-in. drills consume daily 3 cords of firewood, which costs 7s. to 29s. a cord, but generally about 14s. to 18s.

It is almost unnecessary to remark, especially when one remembers the very confined spaces where it is so often desirable to run rock drills, that the length should be reduced to a minimum, for in narrow workings it is impossible with a long drill to place the holes as a skilled miner would do in hand labour. When this vital point (as regards economy in explosives) is kept in view, holes can be as advantageously placed as in hand boring, whereby the same economy in explosives is obtained, with the highest advance of machine drilling.

The advantage of a short drill is by no means confined to stoping; for it is quite as marked in the main headings, as no hard-and-fast system of holes need any longer be followed, for, as in hand boring, all holes can be so placed as to take full advantage of all joints and cleavages, whereby greater progress is made and a large saving in explosives is effected.

In gneiss and homogeneous rocks, free from faults, the ordinary chisel-shaped bit is to be preferred, as, in such rocks, it cuts faster than any other, and smiths can more readily sharpen it. In schistose rocks, wherein layers of uneven hardness, with numerous fissures, are encountered, the chisel bit does not answer so satisfactorily, as the drill seeks the softer material, gets out of line, sticks fast in the holes, and much time is lost in extricating it, and unnecessary jar and strain are thrown on the machine. In such ground, to obtain the best results from machine drilling, the chisel bit should be replaced by the cross, of which there are two varieties, the + and ×. For the softer rocks, the cutting edge can with advantage be made Z shaped.

The quality of steel used in the tool bits requires careful selection, as will be readily conceded when it is mentioned that at 4 atmos. effective pressure a 3-in. diam. cylinder drill will deliver 700–800 blows, each of 175 foot-pounds per minute, and the best brands of tool steel are required to stand this severe strain in hard rock.

The drill bits, according to the size of hole to be bored, should be made from 1½ in., 1¼ in., 1⅓ in., and 1 in. octagonal or round steel, and care must be taken in changing, and that the bit to follow fits easily and revolves freely in the hole. The borers should be sharpened in successively diminishing diameters, and a difference of ⅓ in. in each successive tool will generally be found sufficient.

It is well to get a supply of the necessary drill steel for use in

machines, cut to length, with the shanks truly turned, and the bits sharpened ready for immediate use.

If the shanks are not truly turned in a lathe, but only swaged, it is all important to see that when fitted in the machine the tool forms a true central extension of the piston rod, for if there be any eccentric motion in the cutting edge of the tool when revolving—to which too little attention is often paid—the power of the drill will be wasted in friction, by the grinding of the bit in the hole, involving serious waste of time and power.

It is frequently quite as difficult to drill a straight hole as a round one. The shape of the bit has something to do with the alignment of the hole. It is an invariable rule that the edge of the bit should never be tapered in rock of uneven or irregular construction. The marble bit is of no use except in a material like marble which is uniform. It is obvious that with a tapered bit passing through a flint seam or other irregularity in rock the tendency would be to glance, and this would result in “running” of the hole.

Where drill holes tend to run out of line the bit should invariably have a straight edge, that is, at right angles to the axis of the drill steel. It makes no difference whether the bit is a + or an × bit, so far as the alignment of the hole is concerned. In some difficult places where the hole passes through soft spots or seams running diagonally across the hole it is advisable to upset the steel for a distance of about 6 in. above the bit. In other words, the steel should be very nearly the full diameter of the bit for a distance of about 6 in. at the bottom. The purpose of this is, that the steel may be caught by the wall of the hole, thus preventing “running” until the pocket or seam has been passed. This is readily understood when it is known that the steel used with percussive drills is usually about 1 in. diam. octagon with a bit of about $2\frac{1}{4}$ in. diam., thus there is a space of about $\frac{3}{4}$ in. between the steel and the drill hole, and should the condition of the bottom of the hole be such as to tend to thrust the bit to one side, it will gradually work the steel up against the side of the hole, and will result in a crooked hole, which will give trouble through binding and sticking. If the bar of steel were nearly equal in diameter to that of the bit, it would, as it were, force the hole to run straight. It will not do, of course, to carry so much weight of steel, hence where trouble is met it is best to upset the steel at the bottom.

In the ordinary course of drilling the runner sometimes finds that his hole is going crooked, and without waiting to get a special piece of steel he attempts to pass through the obstruction. The first thing to do is to reduce the speed of cutting. This is done by either throttling the steam or shortening the stroke of the drill by dulling the bit, but whatever is done it is necessary to “go slow” with the drilling. An effective means by which to prevent “running” is to pull out the steel and throw some iron filings, or small pieces of iron in any shape, into the hole; then put in the steel and go ahead. This not only reduces the speed of cutting, but the pieces of iron are thrust into the softer places, and thus the bit cuts through the obstruction, and keeps the hole in line.

Let us assume that a cobble-stone of the size of an egg or larger is discovered by the bit in the line of the hole, but a little to one side of the centre. Obviously as the flange of the bit strikes this obstruction it will be thrown off at a tangent and will gradually eat away the side of the hole farthest from the cobble. It is now simply necessary to drill a few inches more of hole without losing the line, and a few pieces of iron, or even a nut thrown in the hole, will retard the "running" until the bit cuts through the obstruction.

Perhaps the most difficult place to put in a line of straight holes is through a mass of old masonry or concrete. It is sometimes necessary to drill holes in masonry for the purpose of inserting foundation bolts. The largest drill at hand should be used, no matter what the depth of hole is, because a large drill gives less trouble by sticking, and its force of blow may be regulated by the throttle. It is also advisable to use steel of large diameter—nearly as large as the diameter of the bit. The legs of the drill should be firmly set, and the runner should watch the hole, carefully following the instructions given each time that there is a tendency to get out of line.

Should the hole get the best of him in this respect, and the steel bind so as to stick badly, he had, perhaps, better abandon the hole and start a new one, for a great deal of time is lost in expensive efforts to straighten a hole.

A drill hole will sometimes "run" in a most unexpected manner, and in rock of uniform texture. In a case of this kind the runner should at once stop his machine and see if his bit is in good shape. Sometimes one of the flanges breaks off and serves the same purpose in throwing the steel out of line as though a "hard head" was encountered. If the broken piece is large it will sometimes get in one corner of the hole and give considerable trouble, even after the bit has been repaired.

It is of much importance that the hole be well started, that is, it should be started straight. In dimension stone quarries, the mouth of the hole should be preserved at about the diameter of the hole, and not cratered or broken. This can be done by starting with a light blow and a short stroke, lengthening the stroke and the force of blow after the hole has been made a little deeper than the length of the stroke.

The well-known firm of Siemens Brothers & Co., Westminster, have introduced two new forms of drill, one being an improvement on percussive drills and the other a substitute for them. Percussive drills require when working to perform three different motions:—(a) The drill must receive a percussive or hammering motion in the direction of its axis; (b) it must at the same time revolve slowly round such axis; (c) it must be propelled forward at a speed relative to its effective work. Siemens's drill accomplishes the three motions simultaneously by means of a single electro-motor, and very simple mechanism.

The other Siemens drill is intended to prevent the rapid wearing away of boring tools when boring in hard stone and other similar material, and consists essentially in substituting for the concussive

action of percussion tools, or the abrading action of rotating tools, the crushing action of hard metal balls, which are caused, while subject to pressure, to roll over the surface of the material to be operated upon. This rolling action of the balls is produced by forming on the lower end of the boring rod, which constitutes the abutment of the balls, an annular groove of nearly semicircular section, so that on the rotation of the boring rod round its axis, while subject to end pressure, the balls will roll freely both in the groove of the rod and on the surfaces of the stone, and thus in exerting a crushing action successively upon comparatively small portions of the surface, they will grind the material to powder. From the above described arrangement it follows that the wear, if any, of the abutment will take place uniformly all round in the annular groove, resulting merely in the deepening of the latter and thus preventing any defective action being produced by such wear. The arrangement of the balls and boring rod may be variously modified.

The Jeffrey power drills have an excellent reputation in America and are now being introduced into Great Britain by John Davis & Son, Derby.

The drilling machinery made by the Ingersoll-Sergeant Drill Co. is known all over the world, and has an excellent reputation everywhere.

Before the introduction of the Sergeant drill the Ingersoll was the only rock drill in the market with a variable piston stroke. The variable stroke is of the utmost importance in a rock drill. In starting a hole in hard rock, the stroke is shortened by simply turning the crank, thus feeding down the bit close to the rock. A hole can be started with a short stroke in one-half the time as with a full stroke. Another advantage of the variable stroke is that it enables the drill to work loose in seamy or broken holes, and to loosen the mud in muddy holes.

The Ingersoll drill has but two quick moving parts, the piston and the valve. No part other than the piston is subject to violent shocks.

The Ingersoll drill strikes an uncushioned blow. The valve does not move until the blow is struck, thus the full force of the blow is delivered on the rock. It does not use steam or air expansively, but at full pressure in the blow and the recovery—an important factor, distinguishing a rock drill from other steam engines. It has elastic buffers in the front and back heads of the cylinder, their purpose being to prevent breakage should the runner neglect to feed his machine, or should the piston, through any cause whatever, strike the front head. It is claimed to be the lightest rock drill made in proportion to its force of blow. It is easily handled, and is equally effective in both wet and dry holes. Owing to its simplicity of construction and the independence of its piston from any connection with moving parts, it has proved itself to be extremely economical in repairs. Many Ingersoll drills made 15 and even 18 years ago are running to-day in good condition.

The Sergeant auxiliary valve drill is, strictly speaking, a drill for hard rock. The design and purpose of the inventor was to strike a

hard blow, and to so build the machine that it would stand hard usage for years. The experience of the last four years has conclusively proved that not only is the Sergeant drill remarkably efficient in cutting capacity, but that it does its work after years of use equally as well as when new.

The Sergeant is the only rock drill in the world which combines the independent valve operated through an auxiliary valve, and which contains a release rotation. These two features are the most important as distinguishing the Sergeant from other rock drills.

The Sergeant, like the Ingersoll, strikes an uncushioned blow. The valve is held in such a position that while the piston carrying the cutting tool is moved toward the rock the exhaust remains open on one end, while the full pressure acts on the other end until the blow is struck, at which time the valve immediately reverses. It must hit the rock, and does it before the steam or air enters the front end. It does not use steam or air expansively, but has the benefit of full pressure to strike the blow and to recover from broken or crooked holes.

The Sergeant has an auxiliary valve operated by shoulders upon the piston. The auxiliary valve and its valve seat are entirely independent of the main valve and seat. The auxiliary is the trigger to the main valve. It opens or closes the steam or air passages releasing the pressure from one end or the other of the main valve. The pressure bears it upon its seat; hence its wear is uniform and cannot produce leakage. The auxiliary valve being light, of steel, and moving on the arc of a circle through contact with the piston operating tangentially, it is easily moved, does not wear rapidly, and never breaks. It is inexpensive and readily duplicated.

Using a round piston made of steel and hardened, fitting plug-like in the ends, a large opening is effected by a slight movement of the valve. Being perfectly balanced, there is little or no wear.

A short or long stroke can be obtained at will by turning the crank and feeding the cylinder toward the rock. This is a most important feature. A short stroke is of great advantage in starting or blocking out holes.

A new rotating device, with a release movement, prevents twisting of the spiral bar or breaking of pawls and ratchets. When a rock drill strikes a hard blow upon an uneven surface there is a tendency sometimes to twist the steel in the opposite direction to that in which it rotates. The effect of such a blow on the Sergeant drill is simply to turn the back head around, overcoming the friction of the back head springs, when with a rigid rotation it might twist the rifle bar or break the pawls and ratchets.

Two strong steel springs are used in place of buffers. These springs are placed on the back head and are connected with the front head through the side bolts; hence a blow upon either the front or the back head is cushioned by the springs, thus preventing breakages.

The volume and pressure of steam or air used is reduced to a minimum in proportion to the work performed.

Its construction is such that it can be taken apart and put together

in a few minutes, the parts being few and simple. It is not liable to get out of order. It is easily handled and understood by the runner.

The mountings are all new, durable, and especially arranged for convenience of handling.

The legs of the tripod are adjustable to any angle, being operated on what is equivalent to a ball joint.

PRICE LIST OF INGERSOLL-SERGEANT ROCK DRILLS.

	Letter indicating Size.						
	A.	C.	D.	E.	F.	G.	H.
Diameter of cylinder in.	2	2 $\frac{3}{4}$	3	3 $\frac{1}{4}$	3 $\frac{1}{2}$	4 $\frac{1}{4}$	5
Length of stroke in.	4 $\frac{1}{2}$	6 $\frac{1}{2}$	6 $\frac{1}{2}$	6 $\frac{1}{2}$	7	8	8
Weight of machine lb.	124	222	236	246	310	620	693
Weight of tripod without weights } lb.	40	165	165	208	249	260	260
Strokes per minute at 60 lb. pressure } No.	500	325	325	325	300	250	250
Approximate weight of blow lb.	250	500	550	650	750	1000	1500
Depth drilled without changing bits } in.	12	24	24	24	24	30	30
Average work in 10 hours, including setting drill and changing bits } ft.	..	70	70	75	75	70	70
Depth of hole each machine will drill easily } ft.	4	10	14	14	20	30	50
Best size boiler to give steam } nom. h.p.	2 $\frac{1}{2}$	4	4	5	5	8	8
Price of drill only } £	35 10	52 5	57 10	62 10	67 0	76 0	86 10
Price of tripod complete, with weights } £	6 5	10 10	10 10	10 10	11 10	13 11	13 11

The "Optimus" rock drill made by R. Schram & Co., London, and illustrated in Fig. 5, works on the compound principle. The lower end of the cylinder is bored out to a larger diameter than the upper end, and, during the forward stroke of the piston, the air is exhausted from the lower end of the cylinder, and the air at full pressure is simultaneously admitted to the upper end of the cylinder, thus giving a most powerful and rapid stroke. The air that has been used to make the forward stroke, instead of being exhausted to the atmosphere, is now taken through the valve to the under side of the lower piston and utilised for the backward stroke; the result of this in combination with the other improvements in the construction of this drill is that the consumption of compressed air is 40 per cent. less than that of any other drill of the same size; and in addition to this enormous economy, the following further advantages are claimed by the adoption of the "Optimus" drill:—

Considerably smaller air compressors and boilers are required, and consequently reduced first cost of plant.

Great reduction in quantity of coal burnt.

Cost of transport of plant materially lessened.

Smaller air-conducting pipes and flexible hose required.

Where an air compressing plant is already installed, a large addition can be made to the number of drills without increasing the plant and without any extra power.

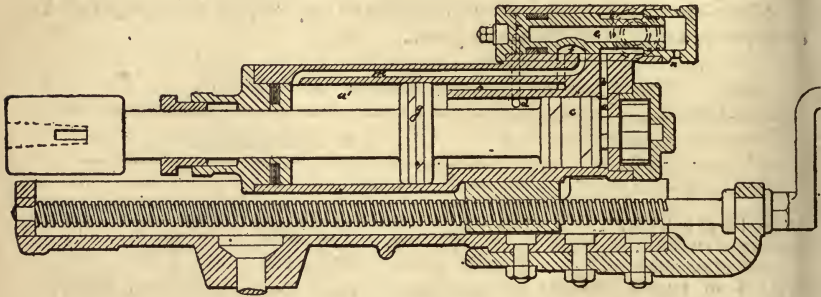

FIG. 5.—OPTIMUS ROCK DRILL.

Tapping Wastes.—In a working approaching an old waste known to contain water, bores must of necessity be kept in advance, and in practice it has been found that, with the ordinary method of drill or jumper, the boring of holes of over 20 ft. becomes difficult, owing to their getting stopped up with the *débris* made by the tool, and this difficulty is increased when it is necessary to have a large barrier sufficient to withstand the pressure of water behind, in order to protect the workings to the dip from being drowned. Such a difficulty presented itself at Alloa and Devon Collieries, where there are large areas of waste with water, and to tap these wastes, and leave a sufficiently strong barrier of coal, a machine was introduced by Andrew Hunter, manager of Alloa Colliery.

The machine, Fig. 6, consists of a cylinder *a*, $1\frac{1}{2}$ in. diam. inside, with packing glands. To a side opening is attached a rubber pipe *b*, $\frac{3}{8}$ in. diam., fixed to pump chest *c*. Two plunger pumps *d*, 1 in. diam. with 1 in. stroke, are fixed to crank spindle *e*, and a second rubber pipe leads to a cistern containing water for suction. On the one end of the crank spindle is a handle *f*, 9 in. long, with which to turn the machine, and to the other end *g* the rods are attached. The whole is fixed on a bogie *h*, 3 ft. 6 in. long by 2 ft. 6 in. broad by 4 in. deep, running on ordinary cast-iron rails, and set at the inclination of the seam. In order to keep the machine moving forward while the drill is cutting, a chain $\frac{1}{4}$ in. diam. is fixed to a barrel with ratchet wheel, and passes round two pulleys, *i* *k*, 6 in. and 10 in. respectively, fixed to prop *l*, and a weight *m* is hung upon a hook at the other end of chain. This hook is so made that a number of similar weights can be placed upon it.

The rods, which are hollow, are $\frac{7}{8}$ in. diam. outside, with $\frac{1}{2}$ in. diam. hole inside, and in 6 ft. lengths. A box is put on the crank spindle, into which the first rod is screwed with $\frac{3}{4}$ in. diam. screw. The other rods are screwed into each other, as is done in the ordinary method of boring. The drill *n*, which is also hollow, is $1\frac{1}{2}$ in. outside diam., and of the ordinary description, as used by miners for drilling

holes, except that $1\frac{1}{2}$ in. from the point is the hole to allow the water to escape.

Where water enters from pumps at *b*, are four small holes drilled through crank spindle into the hollow—the hollow being continued right out. A groove is also cut, into which a set pin is screwed to keep the cylinder in its place.

In applying the machine, the handle is turned, which works the cranks, and water is pumped into the cylinder *a*, and forced into the hollow rods to the drill point, and is discharged at the circumference of the rods, carrying the *débris* which has been made with it. As the drill cuts, the machine moves forward, and is kept from going back by the ratchet wheel. When 6 ft. has been cut, the machine is unscrewed from the rods, and run back, and another rod is fixed. Care must be taken in cutting the rods not to allow them to become empty

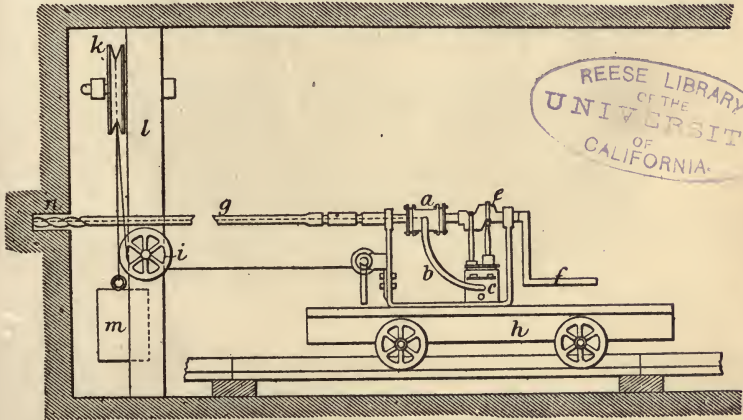
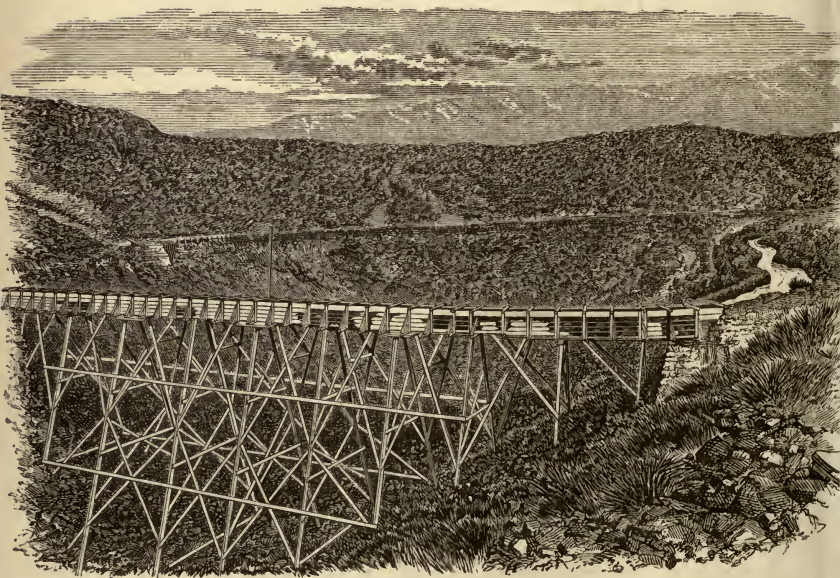
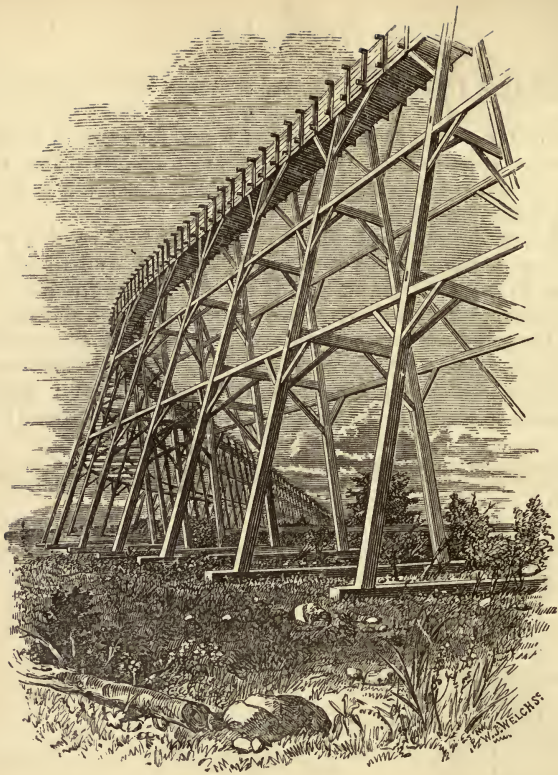

FIG. 6.—TAPPING WASTES.

of water, as, if this is not guarded against, they get filled with small coal and *débris*, and have to be drawn. To prevent this, a small plug is inserted at the part where the rods are cut. Should the weight *m* reach the floor before the machine is up distance, it is taken up by turning the ratchet handle.

At Devon Colliery there is a large area of waste in the lower 5 ft. coal, with a pressure of 135 lb. per sq. in., and waste has been tapped at several places—the greatest distance bored for one hole being 168 ft., 50 ft. of which passed through a hard sandstone. Up to 20 ft. or so, two men can easily bore 1 ft. per minute, while 30 yd. on an average can be bored in a shift of 8 hours by 2 men. At Alloa 3 holes have been put in at different angles, a total distance of 46 yd. in the lower 5-ft. coal in 8 hours by 4 men, including shifting and fixing the machine.



EXAMPLES OF FLUMES.

BLASTING.

Explosives.—The explosives used in mining are chiefly of two classes:—

(a) Those which explode instantaneously (or almost so), and known as quick or shattering compounds. Nitro-glycerine is a decisive type of this class.

(b) The weaker compounds, which explode more slowly, and perform their work by trajection. This class is called slow disintegrating or rending compounds. Black powder is a prominent type of this class.

Explosives of the first class are to a great extent superseding the weaker kinds. In class (a) the initial pressure is the maximum one, while in class (b) the explosion proceeds progressively by combustion, and its gases gradually accumulate and reach their maximum pressure just before the resistance gives way.

This is an important distinction, and determines the application of one or the other of the classes, or the adoption of an explosive of intermediate character in this respect.

The explosive principle in dynamite is primarily nitro-glycerine, consequently its explosive power is dependent on the percentage of nitro-glycerine present.

In order to increase the safety and the convenience of portability of nitro-glycerine explosives, an absorbent is used as the carrier of the nitro-glycerine. Originally this absorbent was of an inert character, consisting of Kieselguhr, an infusorial earth found in Northern Germany. This earth is composed of small diatomaceous shells. The porosity and absorbent quality by capillary absorption render it one of the best of the inert media.

Primarily, the function of the absorbents was to incorporate the nitro-glycerine so as to decrease its liability to explosion by accidental mechanical blows to which it would be exposed in handling it. This absorbent, by reason of its compressibility, forms, as it were, a cushion which deadens the effect of a blow imparted to the cartridge containing nitro-glycerine. As a result of this physical character of the admixture of earth and nitro-glycerine, the effect of concussion of an ordinary character was rendered inoperative in its explosive tendency, the explosive yielding to the blow by reason of the compressibility of the mass, and thus averting the explosion.

In order to complete explosion, detonators are used, while powder may be employed to detonate the dynamite. When the dynamite powders were first introduced, black powder was used as a detonator; but, owing to the uncertainty of its complete detonation, it is but rarely used at present, being almost entirely replaced by com-

pounds called fulminates. Of these, the fulminate of mercury is now the most generally used, and is the best detonating agent. The fulminate of mercury is generally mixed with a small percentage of gun-cotton and chlorate of potash (or other chemical substitutes), in order to make it more safe to handle. When wet, it is pressed into copper capsules, to further decrease the danger of transportation.

Many dynamite compounds employ a chemical absorbent which, being itself of an explosive character, enhances the efficiency of the compound.

These compounds are likewise so made as to reduce the quantity and deleterious character of the fumes which are generated by the explosion of the nitro-glycerine. These fumes are very deleterious in confined or badly ventilated places. Nitro-glycerine powders, however, when fairly detonated, produce innocuous gases. The deleterious gases above referred to result from the incomplete detonation and the slower combustion of the powder, frequently due to the use of detonators too weak to effect complete detonation.

Dynamite cartridges properly made may be burned in an open space without exploding, but when burned in a confined space are liable to be explosive, because the gases generated cannot freely escape; consequently, the best method for the transportation of dynamite is not in iron or other strong boxes, which prevent the escape of the gases when the powder is ignited, but packed in sawdust in wooden boxes.

Carefully made cartridges, dried internally as well as externally, can be transported on very rough roads, and be exposed to considerable jars and shocks without danger.

Leaky cartridges, on the other hand, wet from the percolation of the nitro-glycerine, are very dangerous, and should be condemned as unsafe for handling. In view of the possibilities of imperfect preparation of the dynamite, and the terrible effects attending its explosion, great prudence should always be observed in its use.

At any temperature below 30° F. (dynamite freezes at 40° F.) nitro-glycerine will not explode from any ordinary cause. It is more sensitive at high than at low temperatures. When heated to 360° F. it either burns or explodes. An increase of temperature likewise increases the liability of the dynamite to leak, whence explosions may result.

Many accidents result from endeavouring to thaw frozen dynamite cartridges. The method frequently employed of roasting, toasting, or baking the powder when frozen is almost suicidal in its character. Numerous accidents from these methods are annually recorded.

This practice of thawing is not only attended with great danger, but destroys to a great degree the efficiency of the powder thus treated. The original Kieselguhr dynamite was more affected by low temperature than the modern compounds using chemical absorbents. With strong detonators, the latter class of explosives will do fairly good work even when frozen.

In thawing frozen cartridges, they should be put into a vessel contained in another vessel of water. The interior vessel holding the cartridges should be made of one sheet of iron, so as to preclude

the possibility of the escape of nitro-glycerine into the lower vessel, through defective soldering of the joints, when the vessel is made of more than one piece.

The grade of dynamite with respect to the nitro-glycerine it holds is designated as follows :

No. 1	=	70	per cent. nitro-glycerine.
No. 1*	=	60	”
No. 1**	=	50	”
No. 2	=	40	”
No. 2*	=	35	”
No. 2**	=	30	”
No. 3	=	20	”

Ammonite is a mixture of ammonium nitrate and mono-nitro-naphthalene in the proportion of 81·5 to 8·5, according to Colonel Cundill, and is apparently similar to Favier's explosive. The cartridges are enclosed in a thin casing of a lead alloy, closely resembling the tubes in which artists' pigments are sold. They are hermetically closed, and have a small tubular projection at one end which makes the attachment of the fuse very simple. They are, of course, quite watertight.

For experiment, a weight of 59 lb. was allowed to fall from a height of 5 ft. on to an iron block, upon which the explosive under test was placed. Tonite, gelignite, blasting gelatine, dynamite, stonite, and gun-cotton all exploded at the first shock. The sample of carbonite did not explode until the shock had been repeated. The gunpowder tried did not explode. The quantities used were approximately equal in all cases.

An ammonite cartridge was then cut in two, and one-half tried with the same weight and block, but with a fall of 23 ft. instead of 5 ft.; no explosion resulted. When a detonator was inserted, and the operation repeated, a violent explosion ensued. Gunpowder was then again tried, also with a fall of 23 ft., instead of 5 ft. as in the first trial, and exploded. Cartridges were then exhibited immersed in a freezing mixture, where they had been for 3 hours—according to Butterfield, the company's chemist, under whose direction all the experiments were carried out—at a temperature below anything likely to occur, at any rate in England. The cartridges were still quite plastic, and on one being exploded in the usual manner, it was seen that their properties had not apparently been in any way altered by this attempt at freezing them. Another of them was then thrown on to a bright coke fire, and burnt away fairly rapidly but quietly, giving off rather dense black fumes. Several cartridges arranged in a light frame were fired at and pierced by a bullet from a rifle, but no explosion occurred. One of the pierced cartridges was exploded by means of a detonator. A small parcel of dynamite cartridges exploded at the first shot from the same rifle.

The next experiment consisted in exploding a 1 lb. canister of gunpowder in the midst of a case of ammonite cartridges. None of the ammonite cartridges exploded under this treatment, but some of the scattered fragments that were subsequently collected responded promptly to the action of a detonator.

Ammonite seems to have many good qualities, particularly that of safety, both in transport and in handling. Its manufacture is also simple and apparently very free from risk of accident. That it can compete successfully with dynamite, or the gelatine explosives, in anything like hard rock is not as yet evident, but in soft ground, coal, &c., it should be a useful blasting agent, providing it is comparatively free from liability to ignite the gaseous mixtures occurring in coal mines, and does not give off fumes either in large volumes or of a very noxious nature. To ensure successful explosion, detonators containing 1.25 grm. of fulminate are required.

According to James Ashworth, the use of high explosives in coal-getting has resulted in their being applied without any attention to the question of leverage. That is to say, where a 2-in. diam. hole has been used for blasting powder, a 2-in. diam. hole has been continued for high explosives. Hence, instead of occupying, say, 8 in. or more, of the length of the hole, the high explosive occupies, say, 1 or 2 in., and the pressure exerted is as great or greater on the tamping than on the side of the hole, where the rending should take place.

The worst disasters from blasting have always occurred with shots which faced ventilating currents of high velocity. Detonating vibration appears to be created under such conditions, whereas, if the force of the shot goes with the current, it is not created; and he urges that no explosive is sufficiently safe for use in a dusty or gaseous mine, if its detonating vibration is like that of a mixture of coal-dust, firedamp, and air.

Recent experiments* with a new explosive called Westphalite seem to indicate that it is up to the present the safest of all for blasting in coal mines, as it has been fired without tamping in mixtures of gas and suspended coal-dust without resulting in ignition, explosion, or flame.

Tamping.—The packing which holds the blasting cartridge in place is called “tamping.” The success of a shot very greatly depends on the tamping being efficiently performed, and to carelessness in this operation a large proportion of the accidents due to blown-out shots are traceable. There is therefore a double advantage in having perfect tamping, firstly that the effectiveness of the shot is utilised to a maximum, and secondly that the risk of accident is reduced.

There has recently been introduced a tamping plug for which it is claimed that it automatically increases the chamber, both of gunpowder and dynamite, at the time of explosion, while it greatly increases the safety by causing sufficient resistance to entirely prevent blown-out shots. This is shown in Fig. 7. *a* is an octagonal piece of pinewood, out of which a wedge *b* has been sawn; *c* is a piece of gummed paper which is stuck down over the sides of the block when the wedge is in place.

Fig. 8 shows a section of a blast-hole with the wedge in position: *a* represents the charge of powder; *b*, the tamping plug; *c*, a quantity of loose tamping thrown in above it; *d*, the fuse. When the charge

* J. Higson, ‘Mining Journal,’ Nov. 17, 1894.

is fired, the explosion, it is stated, drives the wedge upwards into the body of the block, jamming it tightly against the sides of the hole. The driving in of the wedge increases the size of the chamber in which the powder is placed by about a lineal inch, thus allowing the powder a little extra time and space in which to ignite before the explosion takes place. The result is claimed to be that 8-10 per cent. less powder needs to be used with this block to produce the same effect as when ordinary tamping is employed.

Henry Johnson maintains that inefficient blasting, together with the attendant disastrous effects, is to be principally attributed to the following causes:—

- (1) Incomplete cleansing, and consequent amalgamation of explosive and coal-dust or borings, left in the borehole.
- (2) The use of coal-dust, or underclay mixed with coal-dust and fragments of coal, or underclay mixed with fragments of hard clunch or rock for stemming.
- (3) Too much explosive with too little tamping.
- (4) Unequal strength of tamping, compact at bottom and loose at top and sides, in consequence of rammer head being excessively smaller in area than borehole, and by its own weight always seeking the bottom of the borehole, rather than the bottom, top, and sides.
- (5) Irregularity of borehole.

With the view of overcoming these difficulties Johnson has designed an apparatus consisting of an improved punch, a cleanser and rammer, and some compressed cartridge tamping.

Just in the same way that the compressed powder cartridge or bobbin has so conveniently and safely superseded loose powder, so it is expected will the machine-made clay pellets supersede the rough loose stemming. In these patents the fuse or battery wire is kept central throughout, obviating abrasion against the wall of the hole, through the use of the rammer.

The price of the tools is not extravagant.

Electric Firing.—The most striking advantage of this over all other systems of firing is that the moment of firing can be determined, and any number of shots can be fired simultaneously; besides which it is the only reliable subaqueous method.

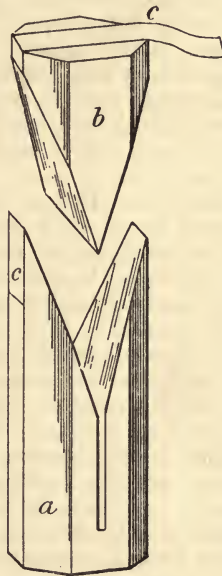

FIG. 7.—TAMPING PLUG.

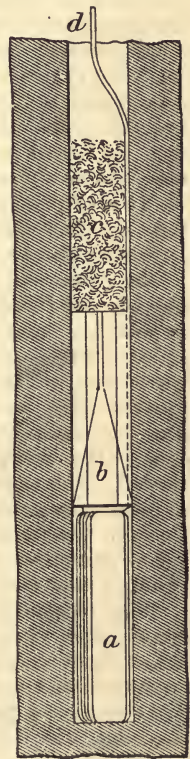

FIG. 8.—TAMPING PLUG.

An electric fuse is an explosive substance placed in the circuit of an electric current, which is passed in either of two ways—(a) by “high tension,” (b) by “low tension” or “quantity” machines. The former have some advantages, especially in simplicity of handling by non-electricians, but with them it is necessary, yet difficult, to ensure perfect insulation. Quantity fuses do not demand complete insulation. The exploder may employ a frictional or a magneto-electric current.

Frictional electrical machines are very effective when in good working order, but as soon as they become damp their power decreases considerably. In consequence of the greater outlay for wires of high insulation, and the care and time expended in keeping the apparatus dry, frictional machines are not so suitable for blasting purposes as magneto or dynamo-exploders.

It is of primary importance that an exploder should possess great power. The mistake of using weak machines has done more than anything else to hinder the adoption of electrical firing.

In cases where only short lengths of conducting wires are employed, and these frequently shifted or subjected to such rough usage as would endanger the insulation of the cable, the use of electricity of small electromotive force is advisable, for this will pass without loss through a cable with faults in the insulation, whereas currents of greater force would readily escape. In such cases, therefore, the quantity exploder should be selected. On the other hand, when the conducting wires remain for the greater part of their length undisturbed, high tension electricity is preferred, because its greater power of overcoming resistance enables it to fire a larger number of fuses through longer distances. On this account the tension exploder is better suited where the firing of a large number of fuses simultaneously through long circuits is required.

For blasting, the tension exploder is also usually preferred, in consequence of tension fuses being cheaper than platinum wire fuses. When, however, a system of mines has to remain a long time inoperative, and yet in a condition to be fired at a moment's notice, daily electrical tests must be taken, and this can only be done when platinum wire fuses are used. In such cases quantity exploders are employed.

In Siemens Brothers' dynamo-electric mine exploders, electro-magnets are substituted for the permanent magnets of the magneto machines, and a Siemens armature is caused to revolve between the poles of the electro-magnets. The coils of the latter are in circuit with the wire of the revolving armature, and during rotation the residual magnetism of the soft iron electro-magnet cores at first excites weak currents, which pass into the coils and increase the magnetism of the core, thus inducing still stronger currents in the armature wire. This accumulation by mutual action goes on until the limit of magnetic saturation of the iron cores is reached.

The choice of the most suitable leading wires and cables depends upon the nature of the blasting operations that have to be undertaken, and the distance of the exploder from the shot-holes. As a general rule, wires insulated with gutta-percha should be employed for subaqueous work, and rubber-covered wires for surface blasting on land,

and subterranean work. In cases where there is no likelihood of damage being caused to the wires leading from the machine, unarmoured cables can be used, these requiring two separate lengths of wire from the exploder to the shot-holes; or concentric or twin cables can be adopted. These latter types have the main and return wires together in one cable, so that only one length is needed for connecting the machine with the fuses.

In electrical blasting it is of the first importance that each joint in the fuse wires, and the joints between the wire of each end fuse and the leading wires or cables from the machine, should be so well protected as to avoid any chance of earth contact, or short circuit. The bared conducting wires after having been scraped clean are twisted together, and then (in the case of gutta-percha wires) slightly smeared with Chatterton compound and covered helically with a narrow strip of thin gutta-percha sheet, which is pressed by means of the moistened fingers around the twisted wires until they are quite insulated. As regards rubber wires, the insulating material should be removed for about 1 in. from the end, and a short piece of rubber tube slipped over one of the cores; the conducting wires are then cleaned and twisted together, and the rubber tube is slipped over them and tied at each end tightly over the insulation of each core. In situations where it might be troublesome to cover the temporary joints in gutta-percha wires in the way described above, the method with rubber tube can be employed.

Water Cartridges.—Experiments have demonstrated that the risks of blasting in coal mines can be greatly reduced by enclosing the explosive in a waterproof envelope, which renders impossible the escape of flame or sparks. Such implements have come to be known as "water-cartridges," but a more accurate term would be "water-jacketed cartridges."

The form introduced by Miles Settle, of the Madely Coal and Iron Company, consists of a simple arrangement of discs or supports, whereby a most essential advantage is obtained, namely, the fixing of the explosive charge in such a manner that it retains a central position, and is therefore entirely and equally surrounded by water, whatever the angle of the bore-hole. Without this precaution security from escape of flame cannot be assured.

The water-cartridge bag is usually made 18 in. long and 2 in. diam., and of specially prepared waterproof material. Gelatine dynamite or gelignite are the explosives used in it. When it is necessary to use more than one cartridge they should be joined by wooden skewers and pressed closely together, to prevent water getting between and causing a missfire. A complete doubly-charged cart-

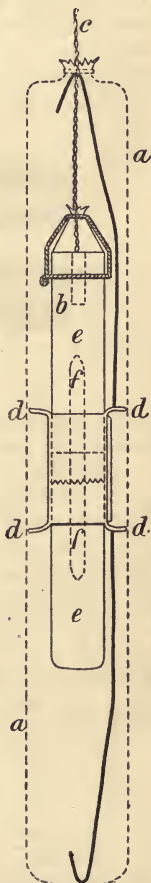

FIG. 9.—WATER-JACKETED CARTRIDGE.

ridge is shown in Fig. 9: *a*, watertight envelope; *b*, fuse; *c*, wire leading to battery or exploder; *d*, tin discs for keeping cartridges central; *e*, cartridges; *f*, wooden skewer joining cartridges.

Wedges.—Fig. 10 illustrates a multiple wedge, for bringing down rock and coal without the use of explosives. The cost is, No. 1, 1 $\frac{3}{4}$ in. diam., 2 ft. 6 in. long, 2*l.* 10*s.*; No. 2, 2 in. diam., 3 ft. long, 3*l.* 10*s.* But there is scarcely any wedge able to hold its own as a means of breaking down coal. The cause is much the same as that which has been the means of limiting the use of the lime-cartridge. The want of success is due almost entirely to the fact that it is difficult to get combined, a face of coal which will break down easily, a roof which

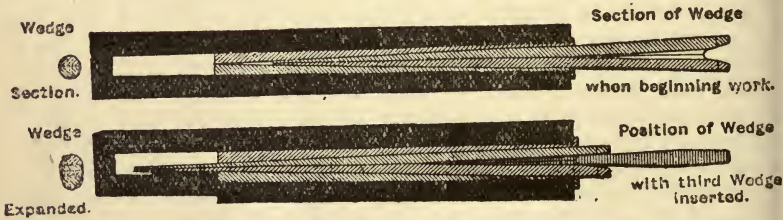

FIG. 10.—MULTIPLE WEDGE.

will separate freely, and a coal which will break off well, conditions which are generally required, whether the wedge or the lime-cartridge is used, both being slow means of applying force to break down coal. A wedge used with great success in Belgium and the North of France consists of two long steel wedge-pieces, which are placed in the shot-hole, the thick end inwards, and a third long wedge is driven between the two. The objection to it is that, with the lime-cartridge or any other means of breaking down coal, simple ordinary explosive force is applied; with the wedge, a considerable quantity of "elbow-grease" is required, and a man has to take 5–10 minutes in striking the centre wedge in order to get the coal broken down.

SHAFT AND WELL SINKING.

THE dimensions and arrangements of shafts must always depend upon the circumstances encountered, provision having to be made for the miners to enter and leave, for raising the ore, for pumping out the water, and for ventilation.

In ordinarily dry ground no particular difficulty presents itself, but where wet ground has to be sunk through, various problems arise, and some useful hints may be gathered from the following examples of shaft-sinking operations carried out under adverse conditions.

(1) In 1881, Foster Brown pointed out the great difficulty and expense attending the sinking of shafts through water-bearing strata, and suggested that a boring might be put down in advance of the sinking, into which a pump might be placed to facilitate the operation of sinking. The water being pumped down in the boring below the bottom of the shaft, the sinking would be done in dry ground, and would go on without intermission. The suggestion appeared to be very valuable. In sinking shafts and wells through water-bearing strata on time-honoured methods there is not only the great cost, but, what is often more serious, the great length of time taken in doing the work. A single well for town water supply often takes 2 or 3 years or more to execute.

The problem is simply that of keeping down the water in water-bearing strata in advance of the sinking operations, so that the excavation of the shaft or well shall be done in dry ground.

The ordinary method of shaft or well sinking is to sling a pump or pumps in the shaft, and to lower the pumps from time to time, as the sinking continues. Obviously the excavation has to be performed in water; and if the quantity of water to be dealt with is very great, a large portion of the work has to be done by the men working in a depth of 2-3 ft. of water. To facilitate the work, and to reduce the water in which the men have to work, a sump is made under the suction pipe of the pump, shown in Fig. 11, and it is the keeping this sump excavated in advance of the other work which is most difficult and tedious. Then there is the delay occasioned by the lowering of the pumps and providing the appliances necessary to the operation.

In the plan proposed by Henry Davey, the pump illustrated in Fig. 12 would be placed in a borehole made before the commencement of the sinking of the shaft. The only novelty in the pump is that of adapting it to the purpose. It is necessary that *débris* shall not go down the borehole in quantity sufficient to choke it up. That is provided against by means of a heavy taper shield of cast steel surrounding the pump, and resting on the edge of the borehole. This shield

is perforated with holes inclined upwards towards the pump, to allow water to get into the borehole, but to exclude *débris*. The shield is made very heavy, and by its own weight follows the excavation around the pump, and also protects it from injury through the blast-

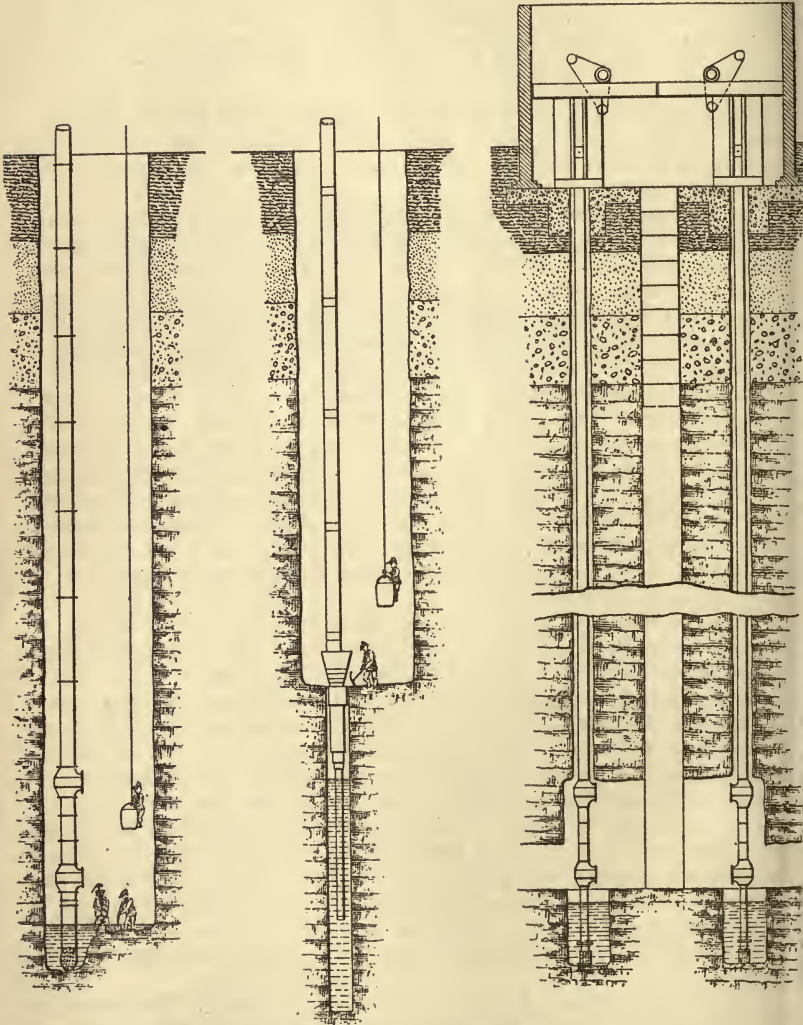

FIGS. 11, 12, 13.—SINKING SHAFTS IN WET GROUND.

ing of the rock. The pump is made without a foot-valve, the rod of the bucket working through the seating of a valve which rests on the top of the working barrel. By this arrangement, the drawing of the bucket also draws the valve; and should the bottom of the borehole

be filled up with sand, it can be removed by lowering a scoop such as is used in making boreholes. The borehole should be made to a greater depth than that required for the pump, to provide a space for sand and *débris*.

The application of this pump to the sinking of shafts can be varied to suit the local circumstances and the geological formation of the strata to be passed through.

It is quite evident that in some situations the shaft might be drained by means of boreholes outside.

It is the usual and necessary practice to provide duplicate pumping engines; and where two engines are made to pump from the same well, the well must be very large that it may accommodate two sets of pumps, as in Fig. 13. Such wells are usually 12-14 ft. diam. To sink such a well in an ordinary way is a very long and costly undertaking, especially if quicksand is met with. On the completion of the well it may be necessary to drive adits to increase the water supply. A simple borehole is made very cheaply and very expeditiously—four 30-in. boreholes can be put down in a very small fraction of the time required to sink a 12-ft. well in the ordinary way.

Instead of making a large well, Davey would put down 4 boreholes, as in Fig. 13, to accommodate the pumps to each engine. The boreholes being completed, the pumps are lowered into them, and coupled up to the permanent engines. Immediately that is done, the water found in the boreholes can be pumped and supplied for use. Should it be insufficient then, a small well would be sunk in the dry to the bottom of the borehole pumps. The boreholes at the level of the pumps would be connected to the centre well, and adits driven to collect more water. Should the boreholes yield sufficient water then there would be no necessity to sink the well.

Fig. 11 is the section of a completed well from which adits have been driven to collect additional water to that yielded by the boreholes. When such a well is made, the changing of the working parts of the pumps may be done underground, thus obviating the necessity of drawing the pump rods from the top.

This system of making wells and shafts certainly promises advantages under ordinary conditions, but the advisability of its adoption in any particular case must be a matter of judgment with the engineer planning the work.

(2) A diamond drill bore was put down 760 ft. from the bottom of the North Magdala Company's shaft, Victoria, which was 920 ft. deep, making the total depth from surface 1680 ft. The drill was fixed on the surface, and placed over the shaft and in such a position that the bore went down in the north-west corner.

A hole 4 in. diam. was first bored by hand to a depth of 10 in. in the bottom of the shaft, and plumb beneath where the 3-in. tubes were intended to come down. The tubes extended to the surface, and were lowered into this hole to within 1 in. of the bottom. Oakum was not procurable locally, so a substitute of chopped hemp and coal tar was used. This was caulked into the space between the 3-in. tubes and the 4-inch hole until it was well filled; a piece of 1-in.

tarred hemp rope was then wound round the tube on top of the hole, so as to make the rope stand up above the hole about 1 in. Over the rope a washer 6 in. diam., of $\frac{3}{4}$ -in. rubber, was placed, and over this washer was also placed an iron washer 6 in. diam. and $\frac{3}{8}$ in. thick (both of these being placed on the tubes before they were lowered). A pair of clamps were then bolted on the tubes, pressing down on the iron washer. The tubes were lowered to rest their whole weight of 5 tons on the iron washer, which pressed on the rubber washer and hemp rope, forcing it down the space between the 3-in. tubes and 4-in. hole. The tubes were then secured to the wood framing of the shaft with stays and clamps every 12 ft. These stays were necessary to prevent vibration, and keep the tubes perfectly rigid. When the tubes were full of water, the pressure at the joint was 407.56 lb. per sq. in., pressing against the rubber and iron washers; but the tubes being 5 tons in weight, it was considered there was sufficient margin over the power of the water in the column of tubes to keep the joint perfectly tight. It was found, however, upon trial, that the pressure, though not sufficient to lift the tubes, buckled them to such an extent as allowed the water to force out the hemp packing at the joint.

The following method was then adopted with complete success:— Over the bottom 3-in. tube a 4-in. covering tube, 7 ft. 5½ in. long, was placed, the top end of which pressed against an iron washer fixed under a wooden frame in the shaft; the bottom end rested on an iron flange, which had 4 bolts screwed into it; these screws pressed down on another iron washer, which likewise pressed on a rubber washer covering the hole. By this plan, the tubes rested on the rock at the bottom of the hole, and, as the tightening of the joint threw the strain only on the covering tube, the 3-in. tubes had no tendency to buckle. The caulking was the same as in the first method tried.

There were many advantages obtained by the plan adopted over that of putting a drill down at the bottom of the shaft. It was more expeditious and economical, as when the joint was made tight the water could be allowed to rise, which saved the expense of keeping the water out. A larger drill was also used than would be possible down a shaft, and consequently a deeper bore could be sunk. No air-compressing plant was required, and in this alone a great saving was effected. The diamond drill used in connection with this bore is known as the "Victorian Giant Drill." Among other improvements in the construction of this drill were larger hydraulic cylinders and the substitution of friction rollers in place of friction rings, which had hitherto been used on all drills. The rollers, about 20 in number, are of hardened steel, of a shape known as truncated cones, and work between two troughs whose internal faces are made to suit the cones or rollers. The difficulty with the rings was that in work it was impossible to keep them efficiently lubricated; consequently they were continually heating, and had to be relieved of a part of the weight by a counterpoise when the bore had attained a depth of 600 ft. But with the cone friction gear the lubrication is complete; the troughs being filled with oil, the roller was thoroughly oiled as it revolved in the trough. The beneficial effect of the substitution of roller friction gear in place of rings was demonstrated at the North Magdala to be

manifold. Not only did they lessen the friction of working, but enabled the drill to bore to a depth of 1700 ft. without the aid of a counterpoise or back balance. This is by far the greatest depth attained without the aid of a counterpoise, and is solely due to the adoption of friction rollers in place of friction rings. With such ease and freedom from heating did the rollers do their work at 1700 ft. that it is believed that a depth of 2700 ft. could be bored without any aid from a counterpoise being necessary; and those who have been compelled to use a counterpoise will readily appreciate the economy and saving of time thereby effected. Another improvement introduced is the friction break on the drum. This allows the drum to be thrown out of gear when lowering rods, as this can be done by the break, thus saving time and the great wear and tear of the machinery that is caused by lowering rods with the engines.

(3) An extensive swamp covers a large part of the town site of Norway, Michigan, and adjacent land. Through this swamp run two parallel oil formations. On the edge of the swamp, about 1000 ft. from the Aragon mine, a diamond drill, in the fall of 1889, located an ore-bearing formation, to explore which, the Penn Iron Mining Company proposed, in the spring of 1890, to sink a shaft.

The depth of the glacial drift being more than 60 ft., and a large flow of water having been struck at a depth of 20 ft. by a test pit, it was decided to sink a caisson or drop-shaft. Two 40 h.p. boilers, a Lidgerwood engine, with 4-ft. drum and a good derrick, were set up, and two No. 10 Knowles pumps, rated at 400 gal. a minute, were brought on the ground.

The dimensions adopted for the top of the shaft were 6 ft. by 13 ft. inside. To give sufficient space for pumps and working, and to aid the shaft to settle, it was made 4 ft. larger each way at the bottom. The shaft was divided, to within 12 ft. of the bottom, into three compartments, the middle one uniformly 4 ft. wide. This compartment was used for hoisting, a ladder-way and pipes. The pumps were placed one in each end compartment. Above the pumps the end compartments were planked up to be filled with sand to increase the weight. A ventilation-box was put in one corner. The bottom of the shaft was left unobstructed for working purposes, and sufficiently high to allow two additional pumps to be put in under the first.

The bottom-pieces, made of oak and constituting what is called the shoe *a*, Fig. 14, were 15 in. square, but the bottom inside was bevelled off to 6 in. Above the shoe, white pine timbers *b*, 12 in. square, framed in sets, were laid close and bolted together and to the shoe with eight 5 ft. bolts. The successive sets were reduced 1 in. in length and width, until at 48 ft. above the bottom their dimensions corresponded with the top. Corner-posts 12 in. square, of unequal lengths so as to break joints, were bolted to every other side-piece and end-piece. The bolts, being put in from the inside and having the nuts countersunk, were easily unscrewed and recovered when the corner posts were removed. Like the corner posts, side posts were put in, one at each corner of the middle compartment; 12-in. dividers were used every 5 ft.

After the levelling of the ground the timbers were built up and

bolted as far as the derrick and bucket would permit, nearly 30 ft. The seams were then carefully caulked outside, and 3-in. planks in unequal lengths were spiked on, to protect the caulking and timbers and to strengthen the shaft.

Ground inside the shaft was broken in the morning, and by next morning the shaft had gone down 6 ft. On the fifth day, at 15 ft. the pumps had to be started. The first week's work resulted in 18 ft. sunk. During the first three days of the second week 9 ft. more were

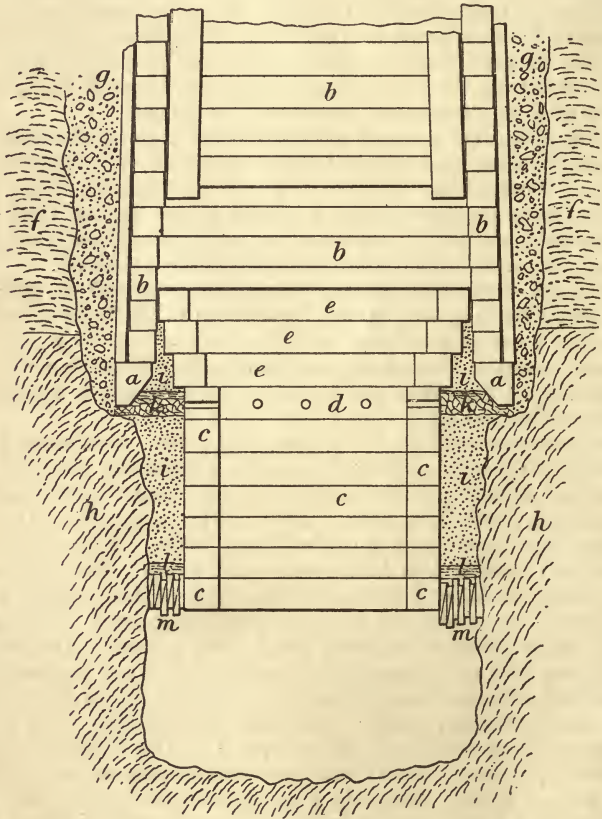

FIG. 14.—SINKING SHAFT THROUGH GLACIAL DRIFT.

sunk. At this time it was evident that both pumps had to run fast to keep the water out, and if one should break down or the water should increase, the men would be drowned out. Therefore, before sinking the pumps below the water-level, it was necessary to get more power.

Two portable boilers, of 35 h.p. and 100 h.p. respectively, were connected, and two No. 10 Cameron pumps were placed, without air-

chambers, 4 ft. under the Knowles pumps. During the stop the shaft was built up again as high as possible.

Everything went well. The pumps were kept busy; three running constantly, and the Knowles pumps often making 160 strokes a minute. The quantity of water was estimated at 1500 gal. a minute. The sand-boxes were now filled to keep the shaft down to the bottom of the excavation. The sand and gravel would come in under the shoe, and the surface about the shaft settled into a large pit which continually grew larger.

At this time the shaft was down 50 ft., and it became necessary to again build it higher. This took three days. A drill in the bottom gave some encouragement, as at 10 ft. it struck something hard. During the next three days hard pan was found in a corner of the shaft. At this point the shaft did not settle well, even when the ground was out 1 ft. or more from under the shoe. To increase still further the weight of the shaft, 30 tons of rails were laid loosely on the top. While going through the hard pan, the settling of the shaft was irregular, accompanied by inrushes of sand and water which kept the pumps busy. Props had to be placed against the shaft at different times to keep it straight. It took 18 days to go through the 14 ft. of hard pan; but parts of two days were spent in weighting the shaft and one day with an accident which bade fair to stop proceedings summarily.

The time spent in sinking may be summarised as follows:—4 days sinking 15 ft. above water-level; 17 days sinking 42 ft. through wet gravel and quicksand; 16 days sinking 14 ft. through hard pan; 4 days sinking 2 ft. in slates; making a total of 41 days sinking 73 feet. To this must be added 6 days required to build up the shaft and 2 days weighting shaft with rails, or a total of 49 days, or one day over 8 weeks actual working time.

The shaft was now down firmly in the ledge; but the most delicate part of the operation was still to come, namely, stopping the flow of water. Before that could be done, however, many things were necessary.

The rails had to be removed from the top and the sand from the boxes, the pipes changed, and the shaft built up to the surface. There was now a sink-hole about the shaft 75 ft. diam. and 20 ft. deep, and the top of the shaft was about 6 ft. below the original surface level. The shaft was but little out of plumb, the top set having to be raised 2 in. at one end to level it. The corner posts were taken out, the bolt-holes were plugged, and the shaft was caulked on the inside. This work took 8 days. The next 14 days were spent in sinking 11 ft. farther into the ledges, which work proceeded slowly.

The work of sealing up the bottom of the drop-shaft was now undertaken. A set, 6 ft. by 13 ft. inside, of 12 in. square timber, was carefully placed in line with the top set of the shaft, about $6\frac{1}{2}$ ft. below the shoe. This was thoroughly blocked against the rock all around with wedges. Six sets *c* of the same size were placed on top of the first and each bolted to the next. Behind the sets as they were built up was put a thin layer of clay over the wedges and then concrete of equal parts of sand and cement. The middle of the top set *d*

was about opposite the bottom of the shoe. Through this set twenty 2-in. holes had been bored. Behind the holes a layer 4 in. deep of gravel and broken stone was laid, leaving a free passage for the water. Upon this perforated set were put three other sets *e* of increasing inside dimensions, so that the top set was against and bolted to the drop-shaft. The space behind these sets was filled with concrete as before. This timbering and cementing in such a flood of water was a tedious process, and took 18 days. The holes were plugged with some difficulty, but this finally accomplished, the water at once fell to about 200 gal. a minute. After the pumps and side-posts had been removed, and the interior had been thoroughly caulked, the water was decreased to about 90 gal. After the shaft had been sunk farther, and bearers put in, a small station was cut at one end and the water was gathered to a No. 8 Cameron pump. Below this the shaft was sunk with a No. 4 Cameron, which now works about 1½ hour a day.

The time taken for sealing up the bottom may be summarised as follows:—8 days to alter shaft after it rested; 14 days to sink 11 ft. in slates; 18 days to timber and cement; 16 days to remove pumps, caulk and arrange shaft for regular sinking, giving a total of 56 days.

References:—*a*, oak bottom-pieces; *b*, white pine sets; *c*, series of 6 sets bolted together; *d*, top set opposite bottom of shoe; *e*, series of 3 sets of increasing inside dimensions; *f*, hard pan; *g*, sand and gravel; *h*, slate; *i*, concrete; *k*, broken stone; *l*, clay; *m*, wedges.



VENTILATION.

NATURAL ventilation is obtained by a current of air passing through the workings, induced by the difference in level between the two openings of the mine at the surface. In summer the current is ordinarily from the higher towards the lower, while the reverse direction prevails in winter. The greater the difference in temperature between the exterior and interior, the greater draft the current will have.

Local conditions will often determine the direction of this current without reference to the aforesaid principle which primarily controls this question. Likewise the draft increases with an increase in the difference of elevation between the two openings of the mine. Where there is naturally a strong current, no difficulty is experienced in ventilating the portions or block of ground within the circuit of the current. The air can be directed by means of properly disposed doors into any desired portion of the workings within the limits above specified. It may be also carried into the face of drifts beyond this circuit by wooden boxes or other means subdividing the current.

Sometimes, to increase the draft, a fire is made near the mouth of the upcast shaft, or a suction fan is used for the same purpose. The suction fan of the Idaho mine is 12 ft. diam. with 4-ft. face; 8 h.p. is required for its operation. But in many mines there are certain points situated without this course of the current, to which, from lack of strength, it cannot be carried in sufficient quantities to renew the air fouled by gases generated by blasting quickly enough to enable the uninterrupted prosecution of work. In such cases recourse must be had to some system of artificial ventilation. Where pneumatic drills are used, these perform a valuable service in this respect. The exhausted air from the drills keeps the atmosphere fresh and pure during drilling, and after a blast, the stopcock of the pipe conveying the air to the drill is turned on, and the compressed air rushes into the face of the drift, or whatever place worked, and soon restores good air. This is a very expensive system of ventilation, and is not employed where artificial air is necessary on a large scale.

Blowers of various designs are used for ventilation. Among the most popular of these blowers are the Baker, the Sturtevant, and the Root. The smaller mines use blowers of sizes corresponding to Nos. 1, 2, and 3 of the Baker Rotary Pressure Blower, while blowers in use at the larger mines correspond to Nos. 4, 4½, and 5. No. 2 has a capacity of 5 cub. ft. per minute. No. 5 has a capacity of 24 cub. ft. per minute.

The temperature of the mines is more dependent upon the system

of ventilation employed than upon the increase of temperature due to depth. In testing the temperature of many mines in California, it was ascertained that no significant increase of temperature, due to the increase in depth, was evident, the temperature being so much dependent upon the circulation of the air as to obliterate any influence that would otherwise exist because of the difference in depth of the points of observation.

The following notes* show the great differences in the coefficient of resistance to air-currents in mines under various conditions; e. g. presence of timber either across the shafts or as supports in the roadways, the repeated enlargements and contractions of the airway, sudden bends in the ways, or the abrupt junction of two air-passages, are all important factors in the increase of resistance. Shortly, the alternate increase and decrease in the velocity of the current, the degree of smoothness of the sides, &c., and the change of direction of the air current, are the most important factors in the loss of pressure.

The following table shows the amount of variation. In this and the other tables the coefficient in all cases represents the total pressure which must be distributed over the transverse section of the airway for every square foot of rubbing surface, in order to maintain a velocity of 1000 ft. per minute in the airway. It will be observed that this is a constant quantity for the same kind of surface, and independent of the dimensions of the airway.

	Coefficients in lb. per sq. ft. of rubbing surface, velocity 1000 ft. per minute.
Straight airways, very even in section, without timber, driven in the coal seam	} .002769
Straight airways, irregular section, without timber, driven in the coal seam	} .003594
Straight airways, regular section, without timber, very jagged sides	} .004230
Straight airways, regular section, timber plentiful, driven in the coal seam	} .004792
Shafts timbered (buntars or brattice)	} .003686
Straight airways, very irregular section, without timber, driven in the coal seam	} .005510
Straight airways, driven in the coal seam, irregular section, plenty of timber	} .005595
Airways, round bord and pillar, face of workings	} .013685

The increase shown between the first condition and the last is nearly 400 per cent.

Having in view the general condition of the several parts of the mine, the following coefficients might be adopted for use in calculation:—

	Coefficients as before.
Shafts (timbered)	} .0037
Intakes	} .0042
Workings	} .0137
Returns	} .0056

* T. L. Elwen.

The above results are similar to those derived from experiments made in Belgium, viz. :—

	Coefficients as before.
Averages of all the galleries of a coal mine	·00936
At the face of the workings	·01419
Galleries and pits of uniform section, and without obstructions	·00208

The practical conclusions that may be drawn are that, next to having the airways large in section, the most important thing is to keep them as straight, as regular in section, and as free from obstruction as possible.

The effectual cooling of mines is a subject which has long occupied the minds of engineers. An invention of some moment has been introduced to the managers of the Cornish mines by Captain Williams, and is one very likely to become adopted by colliery managers also. The machine is simple, and the moving parts are enclosed in a large upright box, and may be made in different sizes to suit the requirements of particular mines. Within the box is a cup-shaped cylinder which swims in water, whilst the motion of the piston-rod, actuated by steam power, produces a strong current of air at both its upward and downward strokes. It can be placed at any required depth in the mine or colliery, and receives its full supply of air from the surface. No grease or oil being used, the air is, of course, preserved in the same condition as supplied. The under portion of the machine always contains about 6 ft. of water, and the up-stroke of the cup piston going to the top of the machine, with the water running down the sides, keeps the inner part of the machine deluged with water, by which means the air is cooled before it is delivered into the mine—even to a temperate heat in the hottest summer. The inventor claims that the machine will force some 5,598,720 cub. in. of cool air into the interior of the mine, each minute, or that it will only require an engine of some 2 h.p. to deliver 7000 to 8000 cub. ft. of air into any part of the mine or colliery per minute. At the Planitz Colliery, in Saxony, the air used for ventilation is caused to turn a wooden lap-wheel working in water. The flaps or blades are thus being continually moistened, and a portion of the moisture is given up to the incoming air.

The winning of coal is exceedingly dangerous during all periods of low or diminished atmospheric pressure. At those times falls of roof's and of other parts, and also escapes of gas, frequently occur. The main difficulty is, of course, to get rid of the gas. The system of ventilation used tends to evil whenever the air is rapidly drawn through the workings of the mine during such low or decreased atmospheric pressure, as the direct or forward motion and force of the air destroy its power of propping the roofs and sides and likewise facilitate explosions owing to the gases being drawn out of the solid coal. The present system of ventilation in coal mines only deals with the danger of gas, that is to say, the gas escapes under the force of gravitation, which remains practically the same while the atmospheric pressure is seriously less; hence the great increase of gas which must be discharged.

To overcome these defects in ordinary methods of ventilation,

Jabez Stanley proposes accomplishing by mechanical means what nature does when the atmospheric pressure is favourable, and when, therefore, there is a minimum of danger. To attain this object he forces air, as may be required, into the mine down the ordinary down-cast shaft, such air passing through the workings in the mine as at present, and from thence out through the ordinary up-cast shaft. When both are drawing shafts, the usual doors to prevent ingress and egress of the air are required for both up-cast and down-cast shafts; the air enters the latter below the doors. The up-cast shaft is provided in an offshoot from the top of the shaft with a regulating valve or valves consisting of a swivel door made to partially open or close by its own weight, so that a favourable or maximum pressure of air is maintained during all weathers, through all parts of the mine, at any time and in all seasons.

To ensure more perfect ventilation of large coal mines, Stanley also employs an additional supply of compressed air. A metal reservoir or receiver is provided in which the air is received from the blast engine or blower through an opening in the reservoir, which can be closed or opened when necessary. This reservoir is placed in the most convenient part of the mine, that is to say, either inside the workings or outside the mine. One or more iron or steel mains or conduits are fixed and laid inside the mine and workings, so as to proceed from the air-reservoir or receiver as permanent outlets thereof, from which branches in the form of pipes or tubes are attached. Wherever the ordinary current or currents of air fail to displace and discharge the gas or foul air from the mine, or to supply thoroughly any part of the workings with pure air, the air-mains and branches are used as accessories.

In order to obtain satisfactory results in ventilation, it is not enough to force a great quantity of fresh air into the mine, but this air must be brought into as close proximity as possible to the face of the workings. The solution of this problem is all the more difficult because it varies with the circumstances, and also for the reason that it depends on the attention, goodwill, and intelligence, not only of those who have the supervision of affairs, but also of the men themselves.

Special arrangements for ventilating the working faces consist of air-pipes, partitions, compartments, parallel roads and borings. The use of air-pipes supposes the mouth of the pipe which reaches the working face to be received by the air-door, which can either be set up in the gallery which first receives the air-current, or in the return airway. But, as a general rule, the use of air-pipes is only advisable in large-sized galleries and for short distances.

Ventilating partitions offer much greater security, for by their means two independent currents of air of almost equal section, and reaching the working face, can be obtained. They are made of brickwork or of boarding; and of sailcloth, either stretched on frames or hung loosely. Brickwork partitions are specially suited for long cross-cuts, and the sailcloth arrangements for the working properly so called. The partition should naturally be kept airtight, and approach as closely as possible to the working face.

In deep levels and broad roads, the embankment, if sufficient, may serve for partition purposes, but an airway must be maintained in the lower part, to permit of the passage of fresh air, and the gallery proper must be intercepted by a door which will expel the foul air issuing from the working face, in the direction of the nearest heading. But in this case it is absolutely necessary that the embankments should be carefully made, and especially that a facing as smooth and impermeable as possible be made the length of the airway and also of the gallery. But in the event of a violent explosion this arrangement presents the great inconvenience of its being easily destroyed, which might result in the entire suspension of the ventilation of a portion of the mine.

When winning in fiery beds, where there is an abundance of gas, it is better to proceed with the deep levels, self-acting planes, and other main galleries, and at the same time also to drive a secondary parallel gallery in the seam or rock, which should connect with the principal gallery by means of shafts which ought not to approach each other too closely. In this case it is best to forward the working face of the parallel gallery (upper) with respect to that of the main gallery (lower), but the air-current ought to arrive there in the last place, in order that the gases which are liberated from it may be carried away immediately. Under some circumstances it would be necessary not to drive the two galleries simultaneously, but one after the other, and in portions. In fiery seams it is also strictly necessary to set up a ventilating partition in each of the two galleries from the last rubble to the face of the working. Lately, particularly in the coal mines of Westphalia, ventilating rubbles have been replaced by bored air-holes, which have this great advantage—that they do away with the always dangerous necessity of driving ascending galleries. But, on account of their small size, it is not usually possible to circulate the air-current through them, which, in the event of an explosion, might be the cause of serious danger. Nevertheless, if by boring holes of greater diameter this defect were remedied, they would answer all requirements.

Of the various means of ventilation enumerated above, preference is usually given to parallel roads for such operations as shafts, cross-cuts, and isolated galleries; but even for these, partitions, embankments, or air-pipes, provided the latter were of adequate size, might suffice. In fiery mines the works cannot be executed without the help of one of these means of ventilation. All airways which have become useless should be stopped up as completely and in as durable a manner as possible.

It is not always possible to efficiently circulate either the main or partial current through all the working places, without its becoming either dangerously enfeebled or receiving a downward direction. Therefore, in narrow mines especially, it becomes necessary to supply badly ventilated and isolated parts of the mine with independent means of ventilation. The most simple means of effecting this is the method which is adopted in fiery parts of Prussian mines—namely, that of setting up fans combined with pipes.

Fans may be exhausting or blowing. As a general rule, the latter

are preferable, because the mechanical effect of the air-current is better able to keep the workings free from gas, and to continually convey fresh air to the miner; whilst with an exhausting fan, the air, before its arrival at the working face, has already absorbed the gases which have been liberated from previous portions of the gallery. On the other hand, it is true that the gallery itself is better ventilated by an exhausting fan. In all cases it is strictly necessary that fans shall only be placed in currents of pure air. When they exhaust there must also be an air return pipe which will lead the foul air as directly as possible into the issuing current.

The most prominently successful colliery fan now in use is that made by Bumsted & Chandler, Hednesford, Staffordshire, and known as the "silent" pattern.

Efficient ventilation should aim at rendering the mine atmosphere free from mechanical impurity, as well as from poisonous gases, and this is especially the case where friable lead ores are being worked, or other minerals producing an injurious dust. At the well-known Broken Hill mines, water-mains have been laid underground, and the faces and workings are sprinkled at intervals, thus keeping the atmosphere in a fairly satisfactory state, even in the worst portions of the mine.

LIGHTING.

It has been justly observed by a writer in the 'Iron and Coal Trades Review,' that no invention connected with mining work has been looked forward to with greater interest than that of the electric lamp, which is to displace the old Davy and Clanny. It is perhaps as well to remember that the old miners' lamp fulfils two distinct duties; it gives light for the miner to work by, and it shows him where gas is present. The first duty, that of giving light, it performs in such a crude fashion, that every new idea which promises a better light is eagerly welcomed. So there have been numerous improvements on the old original Davy, all tending either to increase the light given, or to increase the safety of the lamp in the presence of the strong currents of air now used in the ventilation of mines. This brings us to another point. Even the most improved form of oil or spirit-burning lamp, while giving infallible and easily understood warning of the presence of inflammable or explosive gas, is itself not safe if the gas be driven through its meshes at a given velocity.

Now, it will be obvious that the electric lamp can fulfil two of the above requirements. It can give a better light than is the rule with oil or spirit-burning lamps, and it can give that light in such a form that no matter what the velocity of the gas-laden air current may be, no particle of gas can penetrate to the glowing filament. But, up to the present, no electric miners' safety lamp has been provided with a simple, safe, and reliable apparatus that will warn the user of the lamp that he is working in a gaseous atmosphere. Nearly every inventor has tried to solve the problem by attaching a platinum wire to his lamp, which is allowed to glow at a dull red heat behind a metallic gauze screen, except when gas is present, when the platinum wire assumes a yellow heat. Apart from the electrical difficulties of ensuring that you have always such a current-strength passing through the wire as will raise it to the proper dull red temperature, it is evident that the adoption of this plan surrenders the most valuable property of the electric lamp under the conditions, viz. the absolute impossibility of contact between the gas and the source of light.

Swan and Pitkin & Niblett have tried other plans, each, however, depending upon the presence of heat in some form in a body exposed to the gas, and therefore not fulfilling the primary condition that any gas-tester attached to an electric miners' lamp must conform to. Apparently for this purpose a new discovery is necessary, and the discovery if made will probably be in the domain of the chemist. A careful and exhaustive examination of the properties of the explosive gases which are found in coal mines will probably reveal something,

such as that some substance changes its colour, or its form, or its physical condition when these gases are present, in such a manner as to be readily observed, even in the comparative obscurity of the mine, and by the eyes of uneducated men, after a little training. It is possible that electricity may aid the process. An electric current may set up a certain state in a certain body or class of bodies, such that the presence of gas is readily detected by its influence on the same bodies. But, until some such discovery has been made of some substance that, without heating, will give indications of the presence of gas, as surely and as easily read as those given at present by the old Davy lamp, the miners' electric safety lamp will not be complete.

Meanwhile, pending the above discovery, it may be interesting to discuss in what position the electric safety lamp stands at present, with reference to its fulfilling the other duties named. Though it will be inconvenient to be without a gas indicator on each lamp, the advantages of additional light, and absolute freedom from the possibility of ignition of gas, are so great, that means can be taken to provide for the presence of gas being indicated by means of a certain number of the old form of lamps specially provided for the purpose. It will be remembered, of course, that the miner can have no temptation to open an electric lamp. He cannot light his pipe at it, nor can he warm his "tommy." And if he should succeed in opening the lamp, he can do no further harm than leaving himself in darkness.

There are two methods of arranging a miners' portable electric lamp. The lamp may receive its current from the ordinary lighting service of the colliery, by means of a pair of flexible wires connected to the electric light mains, or it may receive the current from some form of battery which is carried about with the lamp. The first plan, though it has been tried on one or two occasions, is too dangerous for adoption until the working collier has been educated up to it. Falls of roof are so frequent where these lamps would be used, that except with great care and supervision, there would be constant danger of wires breaking, sparks passing across the break, and gas being fired if present. There are also two methods of carrying out the second arrangement, namely the attachment of a portable battery to the lamp. The battery, in this case, corresponds to the reservoir of oil in the old form of lamp, which allows the wick to burn its allotted time. The two methods are, by means of what are termed primary and secondary batteries.

In the primary battery, a metal, usually zinc, is consumed in some form of acid, and in consuming or burning, furnishes an electric current which can be used to give light by means of an incandescent or glow lamp. To complete the primary cell, as each vessel in which zinc is consumed is termed, another plate, usually of carbon, sometimes of copper, is required; and with some batteries it is also necessary that this second plate shall be immersed in a second liquid, in order that certain products of combustion, the smoke and ashes of the galvanic cell, may be got rid of. It is further necessary with the present glow lamps, at any rate, to have two or more of these

cells, in order that a sufficient E.M.F. may be generated to furnish the required light with a small expenditure of current. The cells, whether one, two, four or more, must be held together in some form of case, to which also must be attached the lamp and a handle for carrying the whole apparatus by. The zinc and carbon plates also, if immersed in separate liquids, must be separated by a porous partition, and the plates of the different cells must be connected together, and to the lamp terminals in a certain order. If the light given also is to be much better than that of the old Davy, and the battery furnishing the current is to occupy a small space, the acids used must be very powerful, such as will quickly eat wires in two, destroy connections to terminals, make holes in many forms of containing vessels, and produce other troubles.

In the secondary battery, we have the same condition of things, viz. two different metals, or two pieces of the same metal in different physical states, immersed in acid; but in this case the conditions are produced by the action of an electric current, which is passed through the cells for several hours before the battery is required for use. The metal plates used in the secondary battery are lead, one sometimes being coated with a layer of oxide of lead. On the electric current being applied, one lead plate becomes oxidised, or if already covered with oxide, the latter is raised to a higher oxide, while a deposit of what is called spongy lead appears on the other plate. Spongy lead and lead oxide, in the presence of sulphuric acid, form a powerful galvanic cell, and so it happens that after the plates of a secondary cell have been prepared in this way by means of an electric current, they will furnish a current—in the opposite direction to that which created their electromotive force—if required to do so.

It will be seen that here are no highly corrosive acids, only weak sulphuric acid being used, and no porous divisions; but the same necessity for a number of cells exists, and for connecting their plates in a certain order among themselves and to the terminals of the lamp. With the secondary battery, however, as refilling or recharging is effected by merely passing a current through the cells, the connections between the plates and to the lamp should be able to be made permanent. And in fact, at first sight it would appear as if the secondary battery lamp fulfilled all the conditions required, except that of being able to test for gas. In practice, however, things are not quite so rosy. Though only weak sulphuric acid is used, and the metal employed is lead, one not so easily attacked, the sulphuric acid does combine with the lead not only within the cell, where it does useful work in the process, but outside the cell, at the points of connection between cell and cell, and between the cells and the lamp, forming there a hard white substance which offers enormous resistance to the passage of the current, in proportion to the E.M.F. present, with the result that the light goes down and is finally extinguished. The presence of this troublesome lead salt being unsuspected, the connections being concealed, adds to the inconvenience, as the lamps may go out for no apparent reason. The sulphuric acid also attacks any copper connections that are present, and in the same manner may be doing its work unseen and unsuspected, till some

sudden jerk given to the lamp parts a wire so weakened, and the light goes out.

Another source of trouble with the secondary battery lamp is that if the plates are to give a current of a certain strength for the period of a shift, and to repeat the operation for several months, they must be made strong and heavy, and this renders the lamp heavier than the collier cares to carry to and from his work. In addition to this also, there is a strong element of uncertainty as to the duration of the light given by the secondary battery lamp. A lamp may give its full light for 10 or even 15 hours one day, and only for one hour the next, though the charging current may have been passed through it for the same time in each case. In the secondary battery, we have really two batteries, one on each plate, which are constantly at work; and though the powerful charging and discharging currents mask, so to speak, the smaller electro-chemical reactions which are present, these occasionally make themselves felt, by perhaps short-circuiting a pair of plates, or by introducing a high resistance between the positive plate and its oxide, which cuts off the light perhaps for hours, while this reaction is working itself out. It should be mentioned, too, that the life of secondary battery plates is a most uncertain quantity.

Though it appears a simple matter to pass a current of electricity through one or any number of lamps, having a dynamo ready to furnish the current; and though it is a simple matter—to a trained electrical engineer—to arrange for charging a limited number of lamps from any form of dynamo; where the number of lamps is large, as it would be at most collieries if secondary battery lamps were generally adopted, it is by no means a simple affair, even to a trained electrical engineer, unless he has his dynamo specially constructed for this purpose, and his arrangements for connecting his lamps very carefully planned indeed. If he has to use the ordinary 100 or 110 volt dynamo that is in use for the regular lighting of the colliery, or a 300 volt dynamo that is doing both lighting and pumping, for say, charging 500 lamps, he will be very fortunate indeed if he does not have frequent cross connections, failures of the connections to individual lamps, and other little things that will add to the cost of the lamps by creating an element of uncertainty in their work.

The question, too, of the use of a switch with any miners' electric safety lamp is very troublesome. If the lamps are charged before the colliers are ready for them, their current is wasting unless it is switched off, and this might be a serious matter where, as often happens, colliers do not come to work when expected. If a switch is provided with the lamp, it is almost certain to give trouble. It cannot be strong, as it will then add too much to the weight of the complete lamp, and if it is not strong, it will not only be broken, but cause the lamp to give an intermittent light. The difficulty may be overcome by having the secondary cells in batches, removed from their cases while being charged, and only put in at the last minute. But the question would naturally arise if there is time to do this in the early morning, when hundreds of pitmen are clamouring at the lamp-room window, and if, in the hurry attendant on following this

plan, some lamps will not be improperly connected, and so fail before the end of the shift, perhaps before the face of the coal is reached. The new switch introduced by the Edison-Swan Company, in which turning the light in or out is effected by tilting the lamp, is certainly worth a fair trial.

It would appear, however, that the primary battery lamp is the one which will eventually be adopted for mining work, as the operation of charging them more nearly resembles that of refilling the ordinary lamp now in use. The connections also will be under inspection each time the lamp is refilled, and can be cleaned then just as the gauzes and glasses are now. Further, the matter of connections can be arranged in a very simple manner, and so that there need be very little waste of power, while the lamp is not in use, the operation of lighting the lamp and making the final connections being very much like screwing the bottom of the Davy lamp on, as at present.

The working cost of electric lighting in mines is the chief point of interest, and to give an idea of this the following example of lighting a colliery is given, based on the estimates of John Davis & Son, Derby.

Lamps: Pit top, 2 × 100 c. p. and 2 × 16 c. p. Screens, 4 × 50 c. p. Sorting belt, 12 × 30 c. p. Engine-rooms, 6 × 25 c. p. Boilers, shops, offices, &c., 12 × 16 c. p. Underground—Pit bottom, 4 × 30 c. p. Main roads and stables, 20 × 16 c. p. Total equivalent to about 100 × 16 c. p. lamps.

Taking the usual hours of working, and taking into account the all-night lights, the expenses per annum will be as follows:—

Surface, 6 A.M. to daylight and dusk to 5.30 P.M. } = 400 hours × 60 × 16 c. p. lamps }	= 24,000 lamp-hours.
Underground, all day = 4000 hours per annum } × 25 × 16 c. p. }	= 100,000 ,,
All night—surface, 6 × 16 c. p.; underground, } 4 × 16 c. p. = 10 × 16 c. p. × 4000 hours .. }	= 40,000 ,,
	164,000 ,,

	£	s.	d.
Coal. 164,000 lamp-hours, at 2s. 6d. per ton, say	12	10	0
Renewals of lamps	20	0	0
Depreciation at 5 per cent. on 200l.	10	0	0
Oil, water, waste, and sundries	2	10	0
	£45 0 0		

This is equivalent to a cost for gas of about 1s. per 1000 cub. ft.

In addition to the lighting, small fans, pumps, drills, &c., may be driven by motors from the lighting wires, and will work without attention, the working cost being merely the value of the coal used in the boiler to drive the dynamo.

A specimen estimate of cost for the installation of 100 lamps of 16 c. p. is given by the same firm at 200l., the details being as follows:—

Dynamo. One compound wound self-regulating dynamo, capable of maintaining 110 × 16 c. p. lamps (or their equivalent) complete, with cast-iron foundation rails and belt tightening screws, lubricators, belt pulleys, &c.

- Cables and wires. Average requirements, with lead-covered cable for pit shaft.
- Lamps. 100 × 16 candle power incandescent lamps.
- Fittings. 60 Davis' special dust-proof reflector fittings, of various types as required, fitted with lampholders.
- 40 polished brass lampholders with shade-carriers.
- 40 enamelled steel conical reflectors.
- 12 × 10 light porcelain-base switches, combined with cut-out.
- 3 × 30 light " "
- 12 small porcelain-base cut-outs.
- 4 large " "
- Switchboard. Slate switchboard, fitted with voltmeter and with main switch, main double-pole cut-out, and voltmeter switch.
- Sundries. Staples, screws, insulators, brackets, angle irons, spikes, coach-screws, jointing materials, wood casing, &c.

An installation for 200 lamps would cost 375*l.*; for 500, 850*l.*; for 1000, 1370*l.*; by using larger lamps than 16 c. p. the cost is appreciably lessened.

DRAINING.

WHEN a mine can be worked by adits these are driven at such a gradient that the mine water will automatically flow out. When sinking is adopted the water will accumulate at the lowest point, and some means of raising it is rendered necessary.

The simplest of all methods, but the usefulness of which is limited to lifts of less than 33 ft., is the siphon, varying from a common rubber hose in the smallest installations up to an 8-in. pipe.

At Byer Moor Colliery five siphons are in use, working over a distance of 3557 yd. The greatest lift of any one is 21 ft.; and this siphon is 1275 ft. long, 4 in. diam., has three right-angle turns in it, falls 27 ft., thus working under a 6 ft. head giving a pressure of 2.59 lb. per sq. in., delivers 40 gal. a minute, and is set by an Evans force pump. Another drains two sumps, respectively 2766 and 1887 ft. from point of delivery; it is 4 in. diam., lifts 14 ft., falls 35 ft., pressure 9 lb. per sq. in., discharge 35 gal. a minute. The longest has three branches; the main trunk is 996 ft. long and 8 in. diam., and the branches are 2310 and 1227 ft. long respectively and 4 in. diam., lift 8 ft.

At Chester South Moor Colliery a siphon 1800 ft. long and 6 in. diam. lifts 26 ft.

An ingenious air valve* used at Byer Moor is shown in Fig. 15: *a* is the siphon pipe; *b*, a flat circular leather disc valve attached to feed pipe *c*, surmounted by a pail *d*. While the siphon is running, *c* and *d* are filled with water, and keep the valve closed; while the siphon is being filled, the pressure of air against the under side of the valve opens it, and the accumulating air thus escapes.

Where the quantity of water to be raised is small, and no fall is available for a siphon, while a head of water can be obtained, a most useful contrivance is the hydraulic ejector, which depends on the principle of an induced current created by the force and velocity of the falling stream. This simple and effective method is much in vogue on the deep gravel mines in California,

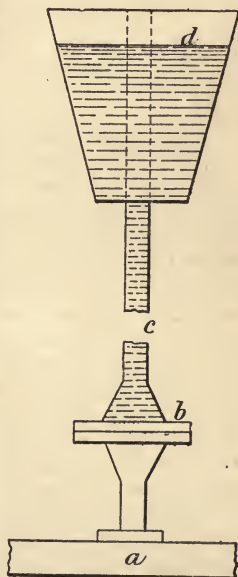

FIG. 15.—AIR VALVE
FOR SIPHON.

* H. F. Bulman in 'Journ. Brit. Soc. Min. Students,' Jan. 1893.

where a great head of water can be had, and entirely replaces pumps for limited duty, practically at no cost for either operation or repair.

The arrangement is shown in Fig. 16, where *a* is the pressure-pipe bringing water from the surface; *b*, the suction-pipe for drawing water from the mine sump; *c*, the discharge-pipe. The suction created in *b* by the rush of water from *a* into *c* induces the water in *b*

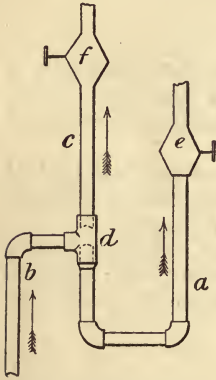

FIG. 16.—HYDRAULIC EJECTOR.

to flow upwards. The precautions necessary are that the diameter of *c* shall be great enough to accommodate the flow from *a* and *b*, but not so great as to nearly counterbalance the pressure (less the friction) in *a*; that the nozzles inserted in the ends of the respective pipes united in the T *d* shall be proportioned to each other (say a $\frac{3}{8}$ -in. pressure nozzle for a $\frac{5}{8}$ -in. receiver), and adjusted relatively so that the stream from *b* is caught up before it can spread; that valves *e f* are inserted in *a* and *c* so as to shut off the water in case of anything going wrong; and that bends be avoided as much as possible, especially after the pressure water encounters the suction water. The effective power of the apparatus is about 30 per cent. of the pressure water and a lift of 200 ft. is easily accomplished.

When the foregoing methods are not available, and the quantity of water to be raised does not demand a pumping plant, buckets or tanks may be employed in connection with the ordinary hoisting appliances.

In vertical shafts buckets of various sizes and designs are used. Where the shaft is provided with guides and the ore is hoisted in cages, the baling tanks are rectangular in form and are made to run upon these guides. These tanks are usually provided with safety catches, similar in design to those used on the cages. A hinge valve at the bottom of the tank permits the automatic discharge of the water in the launders at the surface. A more expeditious method is to dump the tanks by the arrangement of the guides used with self-dumping skips. The tanks have a capacity of 300 to 800 gal. Where the hoisting is done through incline shafts, self-dumping skips are used to raise the water. At the Utica Mine, California, 675 gal. of water can be raised in $1\frac{1}{2}$ minute, from a depth of 560 ft., through a single compartment of the shaft.

Where the amount of water is too great to be handled by buckets, tanks, or skips, which is often the case where the water and rock must be raised through a single compartment of a shaft, a steam pump is very serviceable. A pump of this character is especially to be recommended in the preliminary stages, when the developments of the mine are not sufficient to justify the erection of the far more costly system of the Cornish pumping plant. Steam pumps are also a valuable adjunct to the Cornish or to any other system of pumping plant, as they are very useful in emergencies. In case of accident disabling the Cornish pump, or in the event of the sudden influx of a great volume of water, the auxiliary steam pump might prevent the

inundation of the mine, or of the lower workings at least. Compressed air is often used instead of steam. This is the case always where the pump is remote from the boiler.

Compound steam pumps, although the most economical of all types of steam pumps in the consumption of fuel, are seldom employed on account of their great first cost, preference being given to the Cornish system, when the erection of a large plant is necessary.

Non-rotary pumps without flywheels are used in preference to rotary pumps. Although the latter are more economical in power, they are too expensive and too cumbersome as compared with the non-rotary class to be advantageously employed.

Simple steam pumps are either horizontal or vertical. Both classes are used. The vertical pump is especially useful for sinking, on account of the facility with which it can be lowered or raised. By far the most important class of pumps is the Cornish plunger and lift pump. For handling large volumes of water from great depths this system is superior with respect to economy in the use of fuel to pumps of any other design. The first cost of the plant is considerably greater than that of the steam pump. The lift pump is used to raise the water from the bottom of the mine to the lowest of the set of plungers. From the lowest plunger upwards, plunger pumps alone are used. The motion of the plunger or piston is imparted to it by the pump rods, which are placed in the shaft along the line of pump-column through which the water is raised. The pump-rod is composed of timbers 4 to 12 in. square, joined together so as to form a continuous piece. This rod is connected with the balance-“bob” at the surface. Intermediate balance-bobs are likewise used at various points in the shafts. To the nose of this oscillating bob, the upper end of the pump-rod is attached. The oscillating motion is imparted to the bob by a pitman, which connects the king-post of the bob with the pump wheel. To one side of this wheel the pitman is attached by means of a wrist-pin.

A reciprocating motion is thus given to the pitman, which in turn actuates the bob, imparting to it, as before explained, its oscillatory motion. The length of the stroke imparted to the rods and thence to the plunger is regulated by the distance of the wrist-pin from the centre of the wheel. The length of strokes varies from 3 to 8 ft., and the number of strokes per minute varies from 3 to 10 or 12, depending upon the duty required of the pump.

At the inner end of the bobs, counter weights are placed in boxes attached to the bob for that purpose, to prevent the too rapid descent of the rods, and to equalise the work of the engine at either stroke.

The following figures are an average month's results from five years' experience by J. T. Forgie of a pumping plant dealing with a whole coalfield, and as actual working results they cannot fail to be valuable.

The engine is an old horizontal one, with cylinder 26 in. diam., stroke 4 ft., and geared 4 to 1 through tooth wheels. The tumbling crank sits right over the pit, and works directly on to one of the lifts of pumps through a set of guides, from the crosshead of which are two connecting rods driving the double-nosed bell-crank, which in its

turn drives the second bell-crank through radius bars, and this other bell-crank works the second set of pumps. The whole arrangement is compact, but not desirable. To the engine was applied a simple air-pump and condenser, worked off the end of the engine shaft. There are four double-flued Lancashire boilers, 25 ft. long by 5 ft. 9 in. diam., fired underneath the boiler, the flame being conducted underneath, then back in the tubes, and again along the outside of the boiler to the chimney-stack.

Stroke in pumps, 6 ft.; top lift, 16 in. plunger, 58 fathoms 4 ft.; bottom lift, 15½ in. plunger, 35 fathoms 2 ft.; total depth, 94 fathoms.

The pumps went 261,485 strokes during the month. Total hours in month, 758. Hours pumps were standing, 33. Actual hours pumping, 725—equal to 43,500 minutes.

$261,485 \div 43,500 = 6.01$ strokes per minute when pumping.

Foot-pounds per stroke of top lift	180,224
Do. do. bottom lift	101,760
						281,984
Total foot-pounds per stroke of pumps	281,984
Deduct 5 per cent.	14,099
						267,885
Foot-pounds per stroke	267,885

$267,885 \times 261,485 = 70,047,909,225$ foot-pounds per month.

Coal consumed during the month, 125 tons. $261,485 \div 125 = 2091.08$ strokes per ton of coal. 125 tons are equal to 2979 bushels of 94 lb. each. The duty of engine, or foot-pounds of actual work performed per bushel of coal consumed, was $70,047,909,225 \div 2979 = 23,573,900$.

The dross used during the month was coking coal dross, which is very good in quality, but in comparing with Cornish pumping engines duties of 90 to 100 million foot-pounds, we must remember that they base their calculations on a bushel of the best quality of round screened coal.

Horse-power exerted by engine in doing actual work, not counting that exerted in overcoming friction, &c.:— $70,047,909,225 \div 43,500 = 1,610,297$ foot-pounds per minute $\div 33,000 = 48.80$ h.p.

Diagrams taken with speed at 6 strokes of pumps per minute, showed an average pressure of 12.8 lb. of steam in piston, and a vacuum of 9.2 lb. per sq. in., equal to a total working pressure of 22 lb. per sq. in. This pressure, and with the average strokes per working minute per month (6.01) gives an indicated h.p. of 67.95. The actual h.p. in work done was 48.80, leaving 19.15 h.p., or 28.18 per cent. of the total indicated h.p. as that used in overcoming the friction of the engine, gearing, pumps, &c. In other words the engine was giving 71.82 per cent. of useful effect. The steam pressure in the boilers when the diagrams were taken was 40 lb. per sq. in.

125 tons are 280,000 lb. weight of coal—

$280,000 \div 725 = 386$ lb. coal consumed per hour.

$386 \div 48.80 = 7.91$ lb. coal consumed per h.p. per hour of actual work performed.

$386 \div 67.95 = 5.68$ lb. coal consumed per indicated h.p. per hour.

Actual Ashes made by Coal—

125 tons of coal gave 35 hutches of ashes, weighing 4 cwt. each, or in all 7 tons. Ashes from coal = 5·6 per cent.

For six months' continuous work, raising 345,981 tons of water, the cost was:—

Labour:	73 <i>l.</i> 19 <i>s.</i> , or 4·06 <i>d.</i> per 100 million foot-pounds, or 5·13 <i>d.</i> per 100 tons of water.
Repairs:	32 <i>l.</i> 18 <i>s.</i> 10 <i>d.</i> , or 1·81 <i>d.</i> per 100 million foot-pounds, or 2·29 <i>d.</i> per 100 tons of water.
Fuel:	138 <i>l.</i> 6 <i>s.</i> 2 <i>d.</i> , being 823 tons ordinary quality dross at 3 <i>s.</i> 4 <i>d.</i> per ton, or 7·59 <i>d.</i> per 100 million foot-pounds, or 9·59 <i>d.</i> per 100 tons of water.
Total:	245 <i>l.</i> 4 <i>s.</i> , or 13·46 <i>d.</i> per 100 million foot-pounds, or 17·01 <i>d.</i> per 100 tons of water.

No allowance is made for depreciation of plant or interest on capital.

Appended are results, also by Forgie, of pumping at an Ayrshire pumping station with a compound condensing horizontal engine. The fuel used was very much inferior to that used in the other case, and the pumping machinery only worked 12 hours, necessitating the boiler fires to be damped over night; hence the reasons for the results per 100 tons pumped 100 fathoms being so very little better with the compound condensing than with the simple condensing engine.

High-pressure cylinder, 20 in. diam., 4 ft. 6 in. stroke.

Low-pressure cylinder, 34 in. diam., 4 ft. 6 in. stroke.

Gearing 4 to 1. Stroke in pumps, 6 ft.

Pumps—Top lift 40 fathoms 4 ft., two 14-in. plungers.

„ Bottom lift 31 fathoms 2 ft., two 14-in. plungers.

Foot-pounds per stroke—Top lift 195,810

„ „ Bottom lift 150,870

346,680

Deduct 5 per cent. 17,334

Foot-pounds per stroke 329,346

329,346 foot-pounds = 76·23 gal. of water raised 72 fathoms per stroke of pumps. Water pumped in one year, 552,156 tons. Cost:—

Labour: 97*l.* 3*s.* 11*d.*, or 4·36*d.* per 100 million foot-pounds, or 4·22*d.* per 100 tons of water, or 5·86*d.* per 100 tons of water pumped 100 fathoms.

Repairs: 71*l.* 14*s.* 6*d.*, or 3·22*d.* per 100 million foot-pounds, or 3·12*d.* per 100 tons of water, or 4·33*d.* per 100 tons of water pumped 100 fathoms.

Fuel: 87*l.* 1*s.* 5*d.*, or 3·91*d.* per 100 million foot-pounds, or 3·78*d.* per 100 tons of water, or 5·25*d.* per 100 tons of water pumped 100 fathoms.

Total: 255*l.* 19*s.* 10*d.*, or 11·49*d.* per 100 million foot-pounds, or 11·12*d.* per 100 tons of water, or 15·44*d.* per 100 tons of water pumped 100 fathoms.

It would be impossible in the scope of the present work to even enumerate the many forms of pump in the market, and only one or two prominent examples can be mentioned.

The Worthington Pumping Engine Company have gained a world-wide reputation, notably in connection with the gigantic operations of the American oil pipe lines. In their hydraulic pressure pump, the ordinary interior double-acting plunger is replaced by two plungers or rams having external adjustable packings, readily renewed, which work into each end of a cylinder having a central partition. The

plungers are connected together by yokes and exterior rods in such a manner as to cause them to move together as one plunger, so that while the one is drawing, the other is forcing the fluid, thus making the pump double-acting. The valve boxes are also modified for the purpose of subdividing them into separate small chambers, easily accessible and capable of resisting very heavy pressures. The general arrangement is subject to numerous alterations, to adapt the pump to different requirements. The general characteristic of independent plungers with exterior packing is, however, in all cases preserved, as being not only more accessible in case of leakage, but also as allowing the use of different forms and material of packing. The severe pressure to which these pumps are often subjected, not less in some cases than 8000 lb. to the square inch, demands the most thorough construction and the use of the very best material.

Not less renowned are the "sinking" pump and the "Lehigh" pattern mine pump of the same firm, in which simplicity of action, economy of power, facility of repair, and unvarying reliability are kept in view.

The extensive character of the pumping operations in connection with the sinking at the new Cadeby Colliery, Yorkshire, recently completed, lends a special interest to the means employed. The ground passed through was so insecure that it was decided to try some kind of pump, capable of being suspended in the shafts, and not so heavy as to necessitate the preparation of very strong foundations, or to require staying from the sides, which were too unsafe to stand any vibration, and too soft even to permit of holes being cut through the wood lining.

The shafts being sunk through such loose and soft material, frequently converted by the water into mud, had to be very carefully spiled in sinking; and were then lined by placing 9 in. by 3 in. wood cribs about 2 ft. apart, backed with 7 in. by 2½ in. battens close together behind, the whole being bolted together crib to crib, and suspended from long cross-beams laid on packs on the surface. Flat iron rods were also run down inside the cribs from the top beams, and secured thereto as an additional precaution to prevent slipping.

Choice fell upon the sinking pump made by W. H. Bailey & Co., Salford. This pump, which has been called the "Denaby," consists of 3 hollow plungers; the upper pair are stationary, and over them slide barrels which are connected to the steam piston. From the lower ends of these barrels the bottom plunger projects. This plunger works into a third barrel, and is actuated together with the first two barrels by means of the steam piston. The third barrel is secured, together with the pair of stationary plungers, to the steam cylinder by means of connecting-rods. Thus there are two small barrels in connection with the large ram, moving between the smaller rams and the large barrel, which also are connected. There is a system of rubber disc-valves in the junction between the smaller barrels and the large ram, constituting the delivery valves; and another similar system of valves at the bottom of the large barrel, which constitute the suction valves.

The action of the pump is as follows:—As the plunger rises, the

water follows it into the lower barrel ; and at the same time the water in the hollow plungers is forced into the rising main. On the down stroke, the water in the lower barrel is forced through the lower plunger and valves into the upper barrels and plungers, and thence into the rising main. Thus there is a continuous delivery on the up and down strokes. One of the upper plungers was open at the top and formed the discharge orifice for the water, and the other was closed, to form an air-vessel. On the later type of pump, both the hollow plungers are connected with pipes passing up each side of the steam cylinder and joining together above, with the rising main. Inside each of these pipes is a lesser tube, air-tight at the top, leaving an annular space which forms an air-vessel. The steam cylinder is of the Davidson type, which is found to give excellent results in work. There is practically no dead point, with small movement in the reversing eccentric lever ; and the steam valve is actuated by direct steam pressure as well as a positive movement, should sticking occur, communicated from the reversing lever. The first pump obtained was guaranteed to lift 50,000 gal. water per hour 300 ft. high with 80 lb. boiler pressure of steam. This quantity was obtained when running at about 35 strokes per minute, but on emergency, for many days together, a speed of 45 strokes per minute was maintained.

A telescopic suction-pipe of steel, with cast-steel snore, was provided, by means of which the sinking proceeded about 6 ft., without necessitating the lowering of the pump. This slide pipe was cased outside with strips of deal 3 in. thick, secured with iron clamps, to prevent bulging by shot firing. The whole was suspended from the surface on two old winding ropes passing from suitable eye-bolts on the four connecting-rods of the pumps, up the shaft, over pulleys carried on long beams laid on packs over a considerable area of ground, and thence to the drums of a capstan engine. After the pump was placed in position it was further secured by means of wooden clamps on the rope resting against the pulley framing. The supply, steam, exhaust, and water pipes were secured to the hanging ropes by iron stretchers, placed about 9 ft. apart, provided with staples. Steam was conducted to the pit-top through 6 in. cast-iron pipes, connected with a length suspended in the head gear, provided with a stuffing-box at the lower end, wherein the $3\frac{1}{2}$ in. steel shaft-pipes were free to slide.

As the sinking progressed, after the suction-pipe was drawn out to its full extent, the pump with the columns of pipes was lowered by running the ropes off the capstan, and exhaust- and water-pipes were built as required on the top ; the steam-pipe, after being drawn its full length out of the stuffing-box, was pushed back and another was inserted. A stop-valve and a lubricator were placed in the fixed steam-pipe on the surface. A lad was in charge to regulate the supply of steam as required, he being in communication with the sinkers in the shaft bottom by means of a signal bell. The speed of the pump was thus controlled and lubrication effected without any one being in the shaft for these purposes. This was a great advantage when more pumps were put in, as the same lad looked after the whole of them.

On reaching a depth of 55 yd., the influx of water increased so as to necessitate the use of another pump, which was of the same

construction, except that the stroke was increased to 36 in. This pump was guaranteed to lift 70,000 gal. an hour while running 35 strokes per minute. But this, on getting down a few inches farther, was still inadequate to deal with the amount of incoming water, and another similar pump was obtained and put to work. The sinking progressed to a depth of 57 yd., and was then stopped on account of the inability of the pumps to drain the shaft. In the meantime the No. 2 shaft was following down comparatively dry, and it was decided to continue it until it reached the same stratum as in No. 1, and put additional pumps in that shaft. The first, or No. 4 pump, was put to work at a depth of 45 yd., and No. 5 was placed in No. 1 shaft, making four pumps in that pit. Both shafts were sunk simultaneously to sandstone 73 yd. deep in No. 1, and 62 yd. deep in No. 2 shaft. Another pump, No. 6, was put in No. 2 shaft, and the sinking was carried on until the first wedging crib was laid in No. 1 shaft at a depth of 72 yd. 2 ft. The tubbing was now built up to the surface and wedged. Before this was fixed, the quantity of water lifted out of both shafts exceeded 400,000 gal. per hour, as tested in a tank and over a sill. This quantity had to be dealt with for 3 months until the tubbing was wedged.

The first wedging crib was laid in No. 2 shaft at 78 yd. 2 ft., and the tubbing was built thereon up to the surface. Both shafts were afterwards sunk to a depth of 100 yd., wedging cribs being laid and the tubbing joined up in short lengths, so as to lay open as few fissures as possible to bring the water. At this depth the limit of the pumps was reached and two more were procured, making a total of eight. They were then re-arranged, two being placed in the bottom of each shaft delivering into a cistern fixed 70 yd. from the surface, and two lifting from the cistern to the surface. These latter pumps were hung by similar means to the lowering ones, but the ropes were attached to beams on the surface. The sinking was continued by this means until the whole of the feeders were stopped by tubbing at depths of 131 yd. 2 ft. in No. 1 shaft and 123 yd. in No. 2 shaft. The tubbing was continued to obtain a solid and hard bed, to cribs laid at 137 yd. 2 ft. in No. 1 shaft, and 129 yd. in No. 2 shaft.

The capstan consists of six drums connected to a pair of 13-in. cylinder by 26-in. stroke engines geared on the third motion 25 to 1. These are arranged so as to hang scaffolds in both shafts for putting in the tubbing, and afterwards bricking. The pump-ropes were provided with couplings to attach to the capstan ropes, and were changed as required. Eight Lancashire boilers, 30 ft. by 7 ft. 6 in., were required to provide steam for all purposes, which included two pairs of 24-in. cylinder by 48-in. stroke sinking engines, three steam winches, one 16-in. cylinder by 42-in. stroke fan engine, which also drives an electric dynamo for lighting, mortar mill, shop engine, &c. These boilers were worked at a pressure of 80 lb. per sq. in.

It will be noticed that the pumps have not been designed for economy of steam, but for the following advantages:—Comparative small first cost; no firm, stable, or expensive foundation required; taking up little room in the shaft; working independently of each other; requiring no staying in the shaft; having few working parts,

and these of simple construction; easily repaired in case of accident; freely controlled from the surface; capability of working in case of submersion and with wet steam; quickly raised or lowered; and they can be tied out of the perpendicular, a great advantage in putting in tubbing, &c. All these points were practically proved to have been attained in a degree beyond anticipation, and, as before stated, the quantity of water lifted was far in excess of the calculated capacity.

Electricity in its application to pumping machinery is attracting much attention, and at the Andrews House Colliery, Durham, is a good instance of a plant for driving pumps inbye. This colliery is noted for the large quantity of water that must be handled; at one time 40 tons of water were raised for each ton of coal. The electrical plant was put up in June 1889, and has been enlarged and extended. A dynamo, with armature 10 by 10 in., shunt wound, was located about 300 ft. from the shaft-mouth, and connected, on the third motion, through two leather belts and a counter shaft, ratio 24 to 1. The engine has one cylinder 12 in. diam. and 24 in. stroke. At 980 rev. the dynamo gave 17 amperes at 245 volts, equivalent to 5.5 h.p. The motor was in the workings 4800 ft. from the dynamo, and was of 1.8 h.p., 175 volts, 10 amperes, 850 rev., 10 by 4 in. armature, series wound. It was connected by means of a leather link belt, 4 in. wide, with a treble ram pump, to lift 30 gal. a minute 44 ft. high, the rams being 3 in. diam. and $7\frac{1}{2}$ in. stroke. The ratio of speed between the motor-shaft and the crank-shaft of the pump was 15 to 1.

The cable, as first put in, was of 7 copper wires 18 W.G., insulated with the Fowler-Waring patent lead covering, which has proved very satisfactory. For the return current, old rope was at first and is still used nearly all the way, and is allowed to lie on the ground, or is attached roughly to the side of the way by nails. Only 250 yd. of the return conductor is insulated cable. A test gave the total resistance of the cable as 5 ohms; that of the 4800 ft. lead cable may be reckoned at 3.05 ohms, and of the 750 ft. return cable 0.47 ohm, leaving 1.48 ohms as the resistance of the 1350 yd. of old rope. The first motor and pump replaced a horse crank pump, which was employing 8 horses, and then could not drain the feeder of water. As the water increased, it was soon found necessary to add a second motor and pump. This motor is of the same size and type as the other, and the pump has three rams 3 in. diam. by $8\frac{1}{2}$ in. stroke, the ratio of speed between the motor-shaft and crank-shaft of the pump being 17 to 1. A test showed that the motors utilised 34 per cent. of the power given by the driving engine. The total cost of the installation, including dynamo, two motors, two pumps, cable, and labour of fixing, was about 500*l*. More recently it was found that the two motors and pumps were not sufficient to cope with the water, which had more than doubled in quantity. A larger dynamo was therefore got, armature 12 by 12 in., compound wound, yielding at its normal speed 38 amperes at 270 volts, but it has been run up to 50 amperes and 300 volts. It is connected with the same driving engine, on the second motion, by a leather link belt, the ratio of speed being 1 to 11. The field of the old dynamo was rewound, and it was utilised as a motor to drive a third pump, at a distance of about 6000 ft. from the dynamo. This pump has three

rams 5 in. diam. and lifts 60 gal. a minute a height of 84 ft. A new cable was got. For 250 yd. it is 19-18, i. e. 19 wires of 18 W.G., and for the rest of the distance to the first motor there are two cables, one 7-18 and the other 7-16; from the first motor to the second, which is 900 ft. farther inbye, the cable is 7-16, and from the second motor to the third 7-18.

Fig. 17 shows the form of support used for the insulated cable. The cable *a* is fastened by wire to the earthenware insulator *b*; the

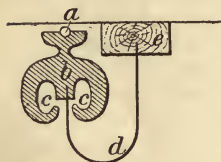

FIG. 17.—SUPPORT FOR CABLE.

cups *c* are intended for holding a little oil, so as to break a continuous surface of moisture, which might allow the current to get to earth; *d* is an iron rod fixed into a timber balk or plug in the roof or side. Old ropes are still used for the return current, as before. Considering the resistance in the pipes, the average work done by the pumps is as follows: 1st, 0.57 h.p.; 2nd, 0.89 h.p.; 3rd, 1.78 h.p.; a total of 3.24 h.p. The normal current required at the

third or farthest inbye motor is 19 amperes and 172 volts. Between the motor and the dynamo there is a loss of electromotive force of 100 volts. The efficiency of transmission of the present plant has been calculated to be 45 per cent., as follows: Brake h.p. of driving engine at 75 rev., 15.50 h.p.; the dynamo gives 85 per cent. of this = 13.17; the cables give 69 per cent. = 9.08; the motors give 80 per cent. = 7.27; the total being, 45.02 per cent. The pumps are kept at work constantly, resting only 40 to 60 minutes in 24 hours, and one man attends to them, the motors and the pumps. The speed of the motors is regulated by resistance coils in the usual manner. The installation is giving complete satisfaction.

In slate formations, or where junctions of slate and sandstone, for example, occur, there is likely to be considerable leakage of surface water into the workings, and unless great care is taken the storage reservoir for the mill, &c., may add very largely to the amount of pumping required.

In limestone formations particularly the quantity of underground water is so great that no pumping machinery has yet been devised to cope with it; and where drainage cannot be effected by tunnels, the mineral deposits have to be abandoned.

In copper mines the decomposition liberates so much sulphuric acid that the pump pipes and valves become very rapidly corroded. So much is this the case, for instance, at the Gagrion mine, Montana, that Superintendent Goodale proposes lining the iron pipes with wood.

MINING AND WINNING.

EXCEPT in the case of simple open quarries, where the whole operation is carried on in daylight, the extraction of ores and other mineral substances is conducted by means of horizontal passages, which bear very various names, according to the precise manner and object with which they are constructed.

When the deposit to be worked lies beneath a level or flat surface, the first preliminary is to sink a shaft down to the bed. But when the country is mountainous or hilly it is generally possible to attack the mineral by means of a tunnel or adit driven directly in from the face of the slope. This latter method possesses numerous advantages, among which may be specially mentioned that the cost of pumping out the natural drainage water from the workings is avoided, and that the expense of bringing the product to surface is very greatly reduced. (These considerations render mining by adit immeasurably preferable to the shaft system wherever circumstances allow it to be done.)

Obviously many points arise in determining how the adit shall be driven, firstly with regard to its location and secondly with regard to its construction. (The aim of the miner is to reach the ore body as quickly and economically as possible, to attack the maximum of mineral by one expenditure, and to ensure continuous and safe working at a minimum cost.)

Two of the most vital conditions in all mining are drainage of the workings and cheap transport of the mineral both inside and outside the mine. Therefore the adit must be so driven that it shall discharge its water where it can readily flow away, and deliver the mineral at a spot handy for further treatment. In vein mining, the adit is generally driven on the vein, but there are cases where it is advantageous to run the adit in the country rock at one side, and tap the mineral by occasional cross cuts. The annexed illustrations show various forms of adit.

Fig. 18 is the simplest, the whole tunnel being in the vein matter, which is sufficiently firm to render timbering unnecessary. The tramway or barrow road is laid along the middle of the gallery, and, the mine being dry, a small gutter on the footway side suffices to carry away the drainage water.

In Fig. 19 the tunnel is driven entirely in the country rock, which, being firm on all sides, requires no timber; but the drainage water is so abundant that a larger gutter has to be provided under the roadway, and the latter is supported on timber.

In Fig. 20 the adit is run entirely in the vein. The walls of country rock being firm and the bedding flat, no timber is needed at

the sides; but the veinstuff affords a bad roof, and timbers have therefore to be run across, their ends being secured in the country rock at each side, and smaller timbers laid across them.

In Fig. 21, the country rock is flat bedded, and stands well in the wall and roof, but the veinstuff requires the support of timbers let in as shown.

In Fig. 22, it is the veinstuff which stands firm, while the country rock is not flat bedded, and timbering becomes necessary on that side of the adit.

FIG. 19.

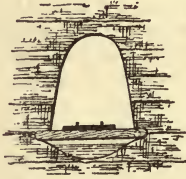

FIG. 18.

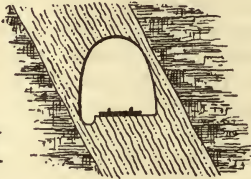

FIG. 21.

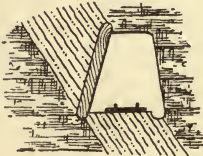

FIG. 20.

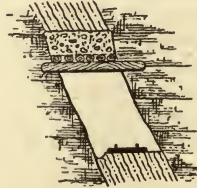

FIG. 23.

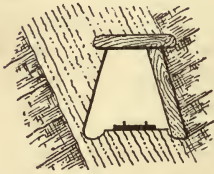

FIG. 22.

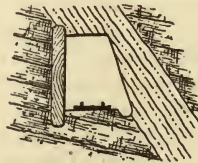

FIG. 25.

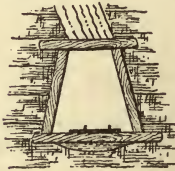

FIG. 24.



EXAMPLES OF TUNNELS.

In Fig. 23 the dip of the country rock makes it necessary to timber the roof as well as one wall, while the veinstuff stands alone.

In Fig. 24, the country rock is firm despite its dip, but the veinstuff is weak, and on that side of the adit double timbering is necessary, the adit being run entirely in the country rock.

In Fig. 25 the ground is weak on all sides, and there is no alternative but to make a complete timber framework.

(Levels are run at varying distances apart. When the vein is steep it is best to have the levels far apart, up to 150 ft., thus effect-

ing a greater saving in the dead-work of cutting out stations and of running drifts to open up the ground. Flatter veins demand that the levels shall be nearer.

When the levels have been run, the ground is ready for mining proper, or "stopping," as it is called. This operation may be conducted in either of two ways, known respectively as "overhead" and "under-hand."

Overhead stopping aims at removing a block of ground by commencing at one of the lower corners. During the progress of the work, the solid ground, as seen from the stopes, resembles a series of staircase steps. It is by far the more generally adopted system, and is started from a raise which was previously made to the level above to obtain a current of air.

In this system, the "deads" or waste is piled back as the stopes progress. When the ore has been extracted, the block of lode is thus replaced by a block of waste occupying entirely or in part the same space. "Mills" or "shutes" are carried up as stopping advances, and shoot the ore to the level below, where it is drawn into the cars. Sometimes the shutes are lined on the sides and bottom with lumber; sometimes only on the bottom with lumber, while the sides are lined with small poles or with piled up rock.

As from 12 to 15 ft. is about the extreme distance to which a man can shovel the material broken in the vein, in order to avoid the more expensive method of using wheelbarrows, the shutes must come within about 30 feet. Where the vein is wide (40 ft. or more for instance) the shutes are carried near the middle of the stopes. In veins of greater width than 40 to 50 ft. there is usually one shute near the hanging and another near the foot wall of the stopes.

Where the material to be shovelled is very heavy, as in lead mines, the shutes are kept very close. An angle of 45° is necessary to have the ore carried down the shutes by gravitation. Where the shutes are flatter, owing to the flat character of the vein, more or less shovelling is necessary. In some flat veins this is an item of considerable expense. Where the shutes are flat, a chain fastened at the upper end may be used to start the ore. On the other hand, where the vein is very steep, "set-offs" are required to prevent undue wear and tear of the shute in case the levels are very far apart.

An example of overhead mining on a vein which does not exceed 2 fathoms thick is shown in Fig. 26. The main adit or level *ab* is first driven, and from this at intervals the winzes or shafts are made upwards as at *c*, and from these again other levels *d* are driven. Similar operations are extended downwards as at *efg*, the bottom of the shaft *e* forming a "sumpf" or sump at *h*, into which the mine water will drain and from which it must be pumped.

The process of excavating one of the square masses *i* of ore is better seen in Fig. 27, where *ab* is the adit; *cd*, shafts or mills or shutes; *e*, timbering which forms the roof of the adit, and at the same time the floor of the chamber being excavated; *f*, a heap of ore broken down from overhead ready for running out of the adit; *g*, that portion of the mineral which has no value—the "deads,"—and which accumulates under the feet of the miners as their work progresses;

h, a substantial wall forming one side of the shaft or shute *c*, sometimes built of the larger pieces of rock broken down from *i*, but more often timbered; *i*, the unworked portion of the vein; *k*, space in which the miners wield their tools.

The advantages of this system are that less timber is needed, and the ore is more easily brought to bank. Its disadvantages are that the miner has to reach upward to his work, and that some ore must necessarily get mixed with the waste *g* and be lost.

Underhand stoping consists in beginning the removal of the block of ground at one of its upper corners. In this method the waste is piled on stages or "stulls," one of which is generally required for every stope. The workings resemble steps of stairs seen from above, and the stulls on which the waste is stored look like a staircase seen from below, the arrangement being just the reverse in appearance of overhead stoping.

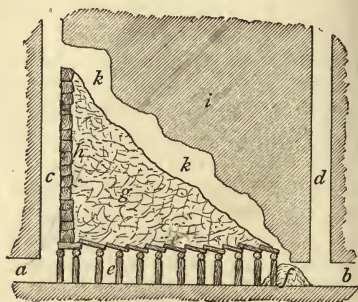
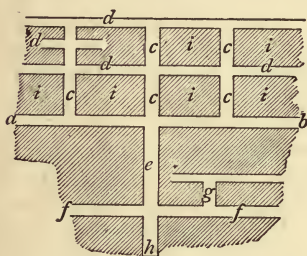

FIGS. 26, 27.—OVERHEAD MINING.

Overhead stoping is started from a raise, while underhand stoping is started from a winze. From the raise or winze, as the case may be, the stopes extend in both directions, forming two wings, which resemble an inverted fan in the case of overhead and a fan in ordinary position in case of underhand stoping.

In underhand stoping more timber is used than in overhead stoping. In overhead stoping one line of stulls is necessary just above the roof of the level, whereas each stope, which represents a height of 6 to 8 ft. in underhand stoping, requires a line of stulls. The expense of timber for underhand stoping increases greatly with width of the vein and with the lack of solidity of the walls. Consequently, this method is of economical application only in narrow veins, say, as a rule, 2 to 4 ft. wide, though for short depths where the walls and vein are solid, greater widths may be worked.

On the contrary, overhead stoping may be worked sometimes 30 ft. or more in width, depending upon the character of the ground. Also, overhead stoping possesses facilities for breaking down the stuff, for stowing away the waste, and conveying the air to the levels. It is also much safer than underhand stoping, where the walls are bad, but not so safe where there is much loosened ground in the vein. Underhand stoping is sometimes preferably adopted where the ore is

very friable and very rich, because there is less loss of rich pieces in breaking the ore, as the broken ore falls on solid ground in this method, while it falls upon waste in the method of overhead stoping, and may get lost. But this loss may, to a great extent, be obviated by laying boards near the face to be blasted.

An example of underhand mining when the vein does not exceed 2 fathoms thick is shown in Fig. 28. From the main adit *ab* a shaft *c* is sunk on the vein. Then, commencing at *d*, miners standing on the ore in the vein excavate it in a series of steps *d e f g*, the ore having to be raised by windlass or other contrivance through openings in the floor timbers of the adit *ab*, whilst the waste or deads is thrown back on strong timber shelves *h* built against the wall of the shaft *c*.

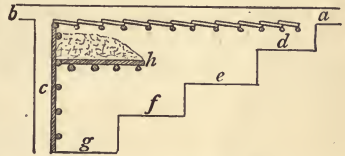
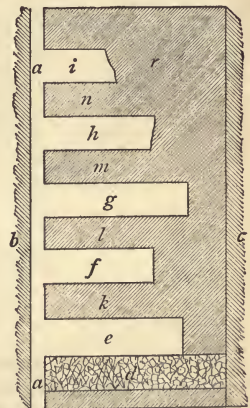
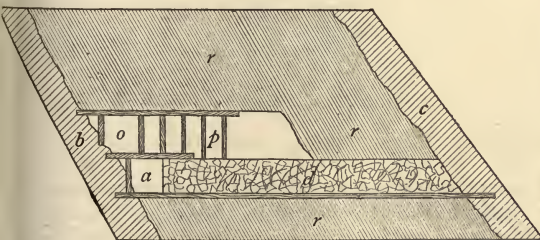

FIG. 28.—UNDERHAND MINING.

The advantages of this system are, that the miner has easier access to the ore and can apply more power, while the loss of ore is less. The disadvantages are extra cost for timbering and for transporting ore to bank, and increasing difficulties in ventilation and removal of water.

With very thick veins, e. g. those over 2 fathoms thick, it is necessary to modify either of the systems described, so as to deal with the width of the vein in successive sections. This is illustrated in Figs. 29, 30. A main gangway *a* is first driven along either wall *bc* of the vein *r*, and substantially timbered. From it a series of breasts or cross-cuts *d e f g h i* are driven at right angles through the vein till they reach the opposite wall *c*. These breasts are 1 fathom high and 1 to 2 fathoms wide, and are so worked as always to have



FIGS. 29, 30.—CROSSWORK ON THICK VEINS.

firm ground on both sides of them, either solid ore as at *k l m n*, or waste stowed back in a former breast as at *d*. As one level is worked out, new gangways, as at *o*, are driven overhead, and the cross-cutting is repeated, with timbering *p* where necessary, and always providing that no two breasts in the same vertical line shall be worked simultaneously.

Where the width and character of the ground to be stoped render

the employment of either overhead or underhand stoping impracticable, recourse is had to the system known as "square sets" or "Nevada timbering," which has grown out of the conditions encountered in working the enormous bodies of silver ore in Australia and America. An illustration of this system is given in Figs. 31 and 32. Sawn timber is used throughout. The uprights and cross-pieces are 10 in. by 10 in., and stand 4 ft. 6 in. apart along the course of the drive; the cross-pieces are 5 ft. long, and the height of the main drive and sill floor sets is 7 ft. 2 in. clear. In blocking out the stopes, the uprights are 6 ft. 2 in., just 1 ft. shorter than those in the main drives. The caps and struts are of the same dimensions and timber as the sill floor. The planks used as staging are 9 in. by

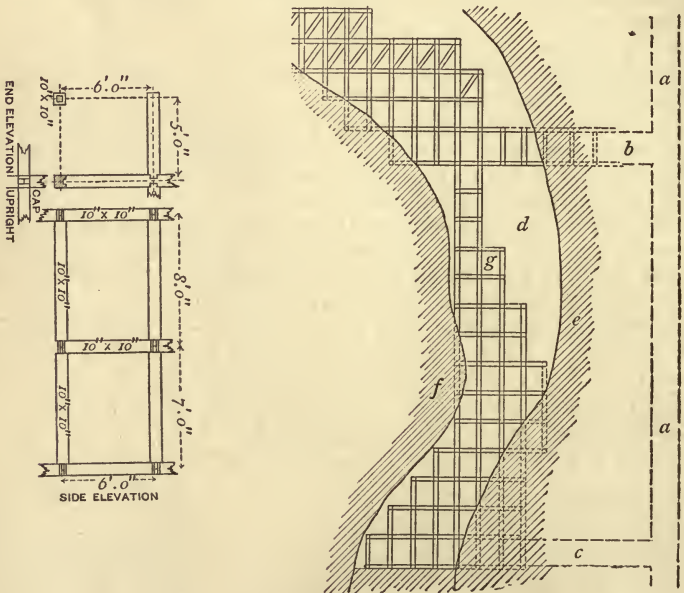

FIGS. 31, 32.—SQUARE SETS OR NEVADA TIMBERING.

$2\frac{1}{2}$ in.; they are moved from place to place as required, and upon them the men stand when working in the stopes and in the faces. A stope resembles a huge chamber fitted with scaffolding from floor to ceiling. The atmosphere is cool and pure, and there is no dust. Stage is added to stage, according as the stoping requires it, and ladders lead from one floor to another. The accessibility of the face is a great advantage. If, whilst driving, a patch of low-grade ore is met with, it can be enriched by taking a higher class from another face, and so on; any grade can be produced by means of this power of selection.

Opinions have been expressed that this system of timbering is not secure, and that pressure from above would bring the whole structure down in ruins. But if signs of weakening become apparent in the

timbers, the remedy is very simple. Four or more of the uprights are lined with planks, and waste material is shot in from above, and thereby a solid support is at once formed; or if signs of crushing are noticed, it is possible to go into the stope, break down ore, and at once relieve the weight. The cost is said to be 30 per cent. less than in the usual system, the ventilation is not impeded, and much timber is saved under ordinary conditions.

A prominent example of the adoption of the square set system is the well-known Broken Hill mine, in Australia, where the ore-bodies

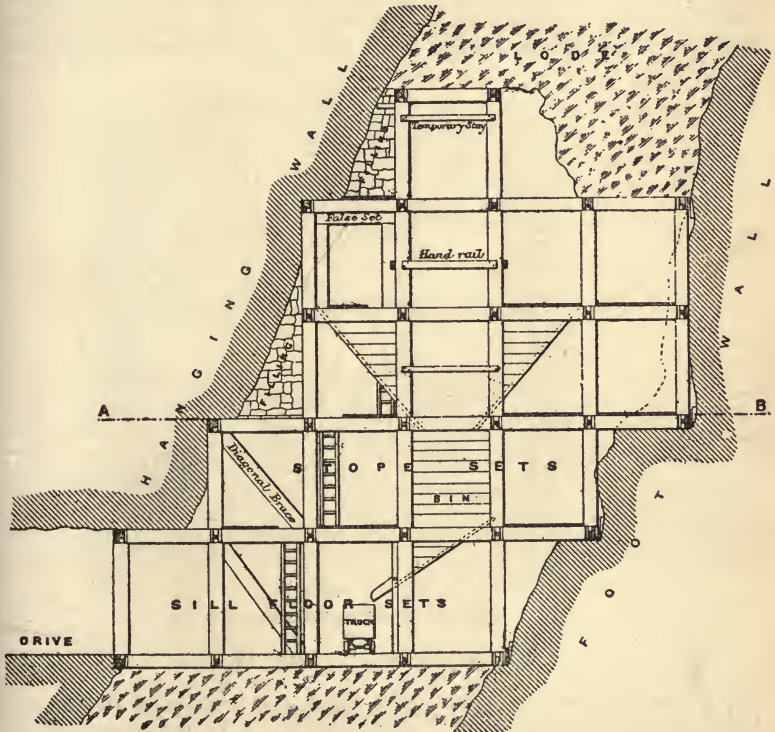

FIG. 33.—TIMBERING AT BROKEN HILL.

range from 15 ft. to 316 ft. wide, and average about 105 ft.^x In the early days of this mine, before the great width and friable character of the lode had manifested themselves, the ordinary method of stoping was adopted, but in 1887 the square set system forced itself upon the management. Figs. 33, 34 represent the system. Where the pressure is light, single timbering suffices; but under heavy pressures, false or double sets, with diagonal struts, are necessary, and in extreme cases solid timber bulkheads have been built. The timber preferred is Oregon pine from Puget Sound.

It is not to be expected, however, that timbering carried out on

the square set or any other system, however well designed and executed, can of itself always withstand the pressures arising from the excavation of such enormous ore-bodies; and filling the stopes at certain points from the hanging- to the foot-wall with hard dry material, such as slag or waste rock, must sooner or later be undertaken, to prevent the spread of fire, as well as the collapse of timbers due directly to excessive pressure.

The opinions of mining experts differ as to the advisability of commencing the removal of ore from the foot-wall or hanging-wall side; but, as a question of mining and engineering combined, Jamieson and Howell, in a paper read before the Institution of Civil Engineers, have no hesitation in saying that, in a lode of the character and

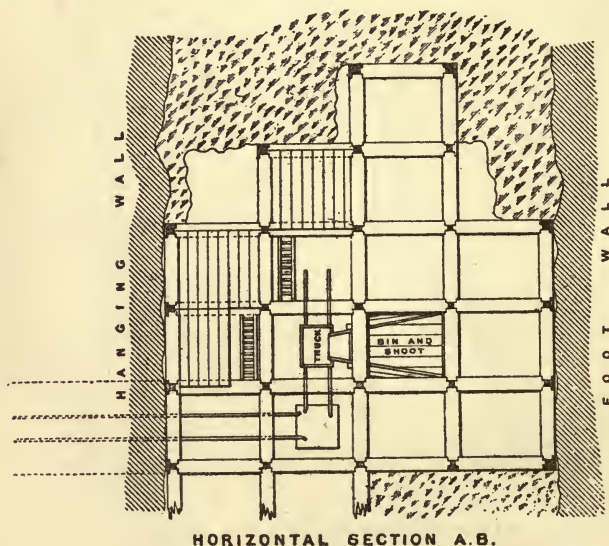

FIG. 34.—TIMBERING AT BROKEN HILL.

dimensions of that at Broken Hill, the correct method of opening up the lode and sustaining the hanging-wall, is to commence at the hanging-wall side and carry the timbers up to it—always keeping the base of the timber sets, in cross section, so far advanced towards the foot-wall that the line of timbers on working faces may form a right-angle with the hanging-wall until the foot-wall be reached. At stated points stopes can be carried ahead of the main longitudinal stopes across the lode from the hanging- to the foot-wall, so that the requisite number of different ore-faces may be exposed. In any case, the space from which ore has been removed should be filled with hard dry material as soon as possible. Experience, and very costly experience, has clearly demonstrated that if a systematic opening of such large and continuous ore-bodies be not carried out, serious and dangerous settlement takes place in them, and, in some cases, great

masses of country rock become detached from the surrounding rock on the hanging-wall side, and press with enormous force on the ore and timbers underneath. In one case, a mass of country rock, estimated to weigh about 300,000 tons, broke loose from the hanging-wall side, owing to the shrinkage of the timbers and the friable ore underneath. In this instance, proper attention had not been paid to securing the hanging-wall, and the ore had been taken out chiefly from the centre and the foot-wall side of the lode, leaving a large mass of friable and easily compressed ore between the timbers and the hanging-wall. The quantity of timber required in the framework of one complete set amounts to 533·4 super. ft. for sill-floor sets, and 405·7 super. ft. for stope-sets; the average total quantity of timber of all sizes, including decking, shoring, lathing, false sets, &c., required per ton of ore removed being about 40 super. ft. (i. e. 12 in. by 1 in.) per ton of ore.

The cost of mining at Broken Hill by day wages (including dead work, trucking, and raising the ore to the surface), per ton of ore, is as follows:—

	£	s.	d.
Wages.. .. .	0	17	2
Timber	0	6	10
Fuel and stores	0	2	10
Repairs and sundries	0	0	11
Management	0	0	6
Total	1	8	3

Though the most experienced and skilful men have been employed to superintend the underground operations, it has been clearly demonstrated that timbering alone is, except in certain places and under certain conditions, quite insufficient to support the enormous masses of ore and the superimposed hanging-wall. Even the use of solid bulkheads of timber of large scantling has been practically valueless; for, although filling the stopes with solid timber has, in certain cases, prevented utter collapse, it has been so costly and so blocked up the workings, that the extraction of ore at the back of the bulkheads has been rendered almost impossible, and other means have had to be devised to open portions of the mine. If the mine had been opened under the hanging-wall first, and the space from which ore was removed had been filled with rock, probably little danger would have resulted; but when this style of timbering was introduced, the full extent and character of the ore-bodies had not been accurately determined, and sometimes ore of a certain quality had to be obtained irrespective of systematic mining, in order to enable the output to be maintained. Not only to relieve the pressure on the timbers, but also to obtain certain qualities of ore more cheaply, the removal of the cap of the lode and quarrying from the surface has been commenced. The depth to which this open-cut work will be carried depends upon circumstances that may arise as the work proceeds; but, so long as it is cheaper and safe, this work will be carried out. The hanging-wall will need to be cut away simultaneously with the quarrying of the ore, and it is estimated that the quarry will thus require the removal of between $2\frac{1}{2}$ and 3 cub. yd. of rock for each

ton of ore, down to depths between 60 and 100 ft. from the surface. A large quantity of timber will also be recovered, which will go to defray the cost of this work.

In order to maintain the hanging-wall below the level of this open-cut work, strong and well-designed walls of waste rock will have to be built from the foot-wall to the hanging-wall. This will cost little, and will practically amount to replacing rock which under any circumstances would have had to be removed.

Excellent examples of the contingencies arising in the course of long-continued mining operations are afforded by the East and West Vulcan mines of the Penn Iron Mining Company, Michigan. The ore occurs here in immense bodies, lying between hard jasper-slates and soft clay-slates; it is soft hæmatite, and varies in thickness from a few inches to over 100 ft. The earliest mining methods were of the crudest sort, but the gradual increase of depth and multiplication of difficulties have compelled successive improvements.

The first was the introduction of the square-set system of timbering, which, as already described, consists in filling the space exhausted in the ore-body with a series of frame cubes. These cubes are constructed with white pine timber of excellent quality, 12 to 15 in. sq., framed into squares of 7 ft. from centre to centre. There is great value in this system of timbering as related to strength, facility in erecting, and its adaptability to all thicknesses of ore-deposits or variations in hanging- or foot-walls. When the walls are tolerably firm and not easily softened by exposure to the moist atmosphere of the mine, it possesses great strength; but where the hanging-wall is of soft clay-slates, softening rapidly on exposure, this system with its large timbers affords only temporary support. When the crush begins, the upright posts lose their vertical position, and many of the timbers are reduced to splinters. Collars and cross-braces are sometimes used to arrest a squeeze; but a brief respite only is secured in this way. The flexure of a soft hanging-wall indicates the early crushing of timbers in the exhausted portion of the level. It becomes then a struggle on the part of the miner to remove as much as possible of the ore out of the creeping levels before the final crush comes to close out all mining operations. It has thus been found that for certain qualities of mine-walls this elaborate system of timbering fulfils its office satisfactorily, but that under a softening hanging- or foot-wall it is not reliable for a sufficient time to afford opportunity for exhaustive mining in each level, or to protect ways to the adjoining level. The depth to which it can be safely carried depends on the firmness of the hanging- and foot-walls more than on the increased pressure from depth, although the latter is also an important factor.

The adoption of the method known as "rock-filling" was compelled by the conditions, already described, in the West Vulcan mine. At the eighth level the ore is 600 ft. long and the average thickness about 25 ft. The shaft is 665 ft. deep to the ninth level. The timbering, mainly after the Nevada system, has been carried to the eighth level. Rock-filling is now being used in the ninth level.

Figs. 35-37 show the method of this filling. From the main

shaft *a* a drift cuts the ore-body *b* and 25 ft. into the foot-wall *c* of firm jasper-slates. From this point *d* a rock-tunnel *e* is driven in the foot-wall *c* east to shaft *f*. Along this rock-tunnel *e* ports *g* are made at intervals of about 100 ft. into the ore-body *b*. From these ports the mining of the ore begins on the bottom of the ninth level.

The first cut of the ore is mined about 8 to 10 ft. high, and the spaces from which the ore has been removed are filled with rock. This rock-filling *k* follows the mining and affords absolute safety and inflexible support to the walls of the mine. The broken

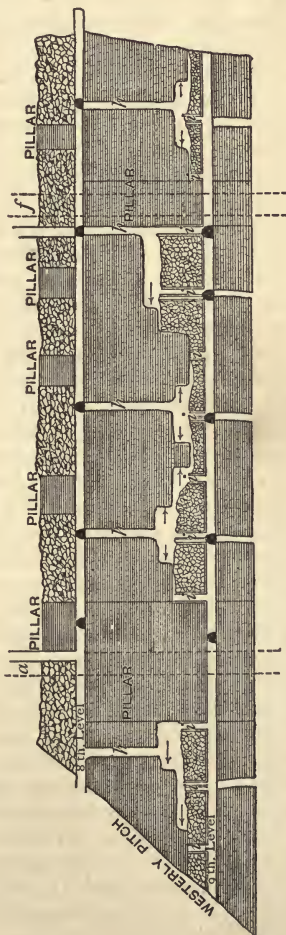
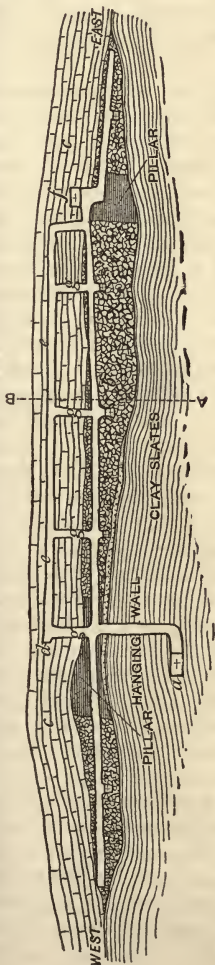
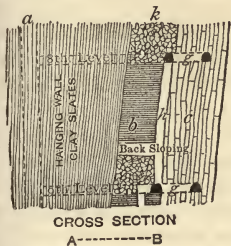

Figs. 35, 36, 37.—ROCK FILLING AT WEST VULCAN.

rock for filling is conveyed down the winzes *h*, and the ore through the shutes *i*, which are built up as fast as the filling is made upwards.

It will thus be seen that the tunnel *e* in the foot-wall secures complete safety to the mainways of each level; it is out of the crush range in any event. The winzes *h* are also ventilators, and greatly improve the sanitary conditions of the mine.

The ore-body *b* is under this system attacked by the miners on double face at each port *g*, from the main rock level or tunnel *e* in the foot-wall. The mining by sections upwards is simply a repetition of the first 8–10 ft., the rock filling following the mining work and occupying the spaces from which the ore has been removed as rapidly as room for the mining operations will permit. Some timbering will be required occasionally in this rock-filling, especially in sustaining the filling in upper levels, as it is approached from below, in removing the last cut of ore.

This rock-filling system has not been adopted on the score of economy over the Nevada system of timbering, but has been compelled by the necessities of the case. Sufficient work has not been done to afford a reliable statement of the relative cost of the two systems. Nor would such a statement at any time form a permanent basis of comparison, because the forests of this region are being exhausted, with consequent effects on the market prices of timber, while the cost of breaking up and shooting waste rock into the mine fluctuates but little. The price paid for timber and timbering at West Vulcan was 1s. 7½*d.* per ton of ore mined. The cost of rock-filling, with attendant consumption of timber per ton of ore mined, was 7*d.* a ton for rock-filling and 3*d.* a ton for timber used therewith. It may be pointed out that the rock-filling affords a permanent support, which is not liable to decay as is the timbering system, and will not require renewals during the progress of the mine-workings.

There are other important factors in connection with the general application of this system of rock-filling, e.g. the location of the shafts or slopes to the mines. The first planning of these slopes or skip-ways placed them in the ore-body, requiring large pillars of ore for their maintenance. Where the ore is of moderate thickness (12–15 ft.) this method is not so open to criticism; but when the ore-body is 20–100 ft. thick and rather soft, it has serious drawbacks in the great pillars of ore which must be set apart for this purpose, and in their tendency to crumble, especially in the event of a creep or crush, which follows in a greater or less degree in exhaustive mining. The use of skip-ways in the foot-walls, or the sinking of shafts in the hanging-walls, are matters of the greatest importance in assuring safe and economical mining. It has been shown that slopes or skip-ways in the ore-body are open to serious objections in large deposits of ore. It is quite possible to sink the slopes or skip-ways in the foot-wall, especially when this is firm. They could be driven in the foot-wall, and a sufficient distance under the plane of the ore, say 10–20 ft., so as to assure a permanent rock tunnel under all conditions of creep or crush. This will have some exceptions, as where the ore-body is much flexed and pitching; but there are many deposits where a slope

or skip-way could be driven in the foot-wall of an ore-deposit, and be readily made to conform to the flexures met, in ordinary cases, in these foot-walls. This would be costly at first, but it would ultimately be found to assure great safety, and permit exhaustive mining, since no pillars would be required for its protection.

West Vulcan mine exhibits an example of approaches by slope or skip-ways, partly in foot-wall slates, and a vertical shaft in the soft slates of the hanging-wall. The location of the main shaft in the hanging-wall was the result of several conditions bearing on the ultimate economy of mining its ore. It is near the siding of the railroad, affording a ready way for delivering the ore into railroad cars, and also for receiving coal by the same way for the boilers, and timber for the mine. This location also reduced largely the height of the pumping column, and the shaft was sunk in soft slates rapidly and cheaply. ~~Aside from these special conditions, the locating of a shaft in the hanging-wall cannot be commended, as there is generally some shifting in the hanging-wall ground, endangering shaft and machinery.~~

It has been a matter of discussion whether the usual method of mining by beginning operations at or near the surface and working downwards, is the best plan. It is true that it affords a ready output of ore, and a quick return of money; but, unless permanent rock-ways are established, it involves increasing expenditure in the downward workings. It is submitted by Fulton that in deposits of ore of moderate thickness, a slope could be cut in the ore to the bottom of the deposit, and workings commenced there, entirely exhausting the ore in the progress of the working upwards. The exhausted spaces below would afford a ready place for mining refuse, and could, if necessary, be supplemented with additional rock-filling. Even should the hanging-wall swell or buckle, no serious injury could result, as such a crush would be arrested at each level.

The objections to the rock-filling system are the amount of dead work entailed, and the inconveniences and destruction of timbering owing to the ground sinking unevenly under foot.

The system of mining in use at the Iron River mine, Menominee region, is extremely well adapted to ores hard enough to stand over the width of the vein. A section across a stope (Fig. 38) shows the method of work. The ore *a* is taken down in an overhead stope *b* running the width of the vein from the hanging-wall *c* to the foot-wall *d* for any desirable length, and for a height of say 12 ft. A timber-drift *e* is then built along the floor of the stope, and the balance *f* of the stope is packed with waste sent down from the surface through winzes previously sunk or upraised at intervals of

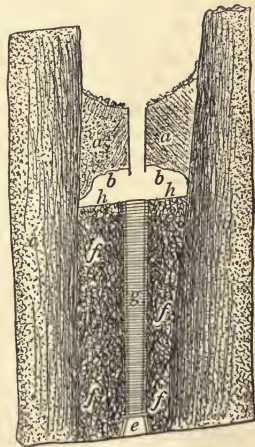
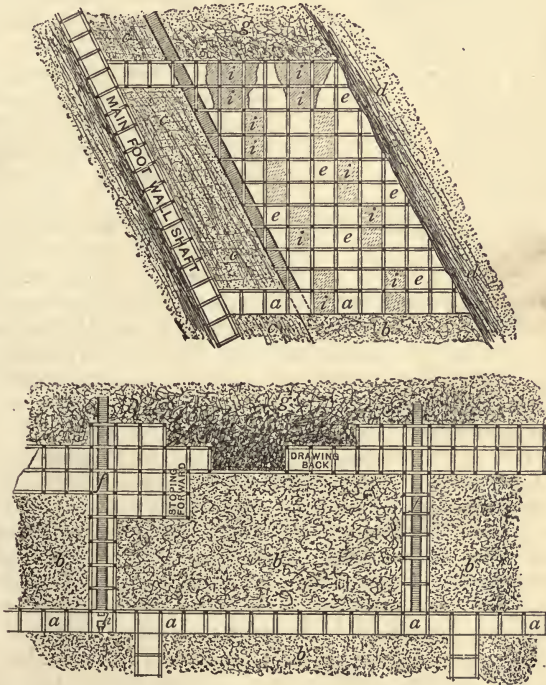

FIG. 38.—WORKING ON HARD VEIN.

about 50 ft. in the length of the stope. A "mill" or "shute" *g* is carried up every 50 ft., along the level to run the ore down; it is about 4 ft. sq. inside, and is built of round, rough hardwood sticks. The spaces between the sticks when they do not fit closely are filled with pieces of plank, and the inside of the "mill" is lined with hardwood planks spiked on to the side timbers. These planks are easily replaced when worn. The packing is levelled over as close to the backs of the stope as is convenient for working, and is planked *h* over, to keep the ore from mixing with the filling. The "mill" is carried up before the filling as high as this is to go; and when the filling is levelled off, a few large sticks are laid across the mill, leaving intervals large enough to throw the ore down, but so narrow as to prevent the falling in of a man or a block of ore that would choke up the outlet from the mill. This method is extremely satisfactory where the ore is strong enough to stand without timbering across the vein. It requires no timber, except for the level and the mills, and a few planks, while permitting the extraction of nearly all the ore. The cost of filling at Iron River was only 6½*d.* a ton on the ore got out, but on the average this figure would be much exceeded.

For working in large soft ore bodies, Rothwell thinks it would be found in every way advantageous to work the vein out from the top downwards. He would drive the main levels *a* in the vein *b* (Figs. 39, 40), and most conveniently on the foot-wall *c*, *d* being the hanging-wall. As the ground is undisturbed, it should be feasible to keep open a level the width of an 8-ft. set, no matter how soft the ore, thus avoiding much dead work. At suitable intervals the vein would be cross-cut *e*, and stoped out the width of one set, up from one level to the next above. However soft the ore, it should be possible, even with rather light timber, to hold a stope only 8-9 ft. wide running across the vein in the solid well-drained ore. This will take the place of winzes and cross-drifts at much less cost, and will serve as a pocket or shute *f* to hold the ore, which can be drawn thence into the cars *h* below; or the mill or shute *f*, through which the ore is sent down, can be built say 3½ by 4 ft. in the clear, of round hardwood sticks lined with hardwood plank. By a little care in packing round it, this can probably be held in the filling *g* as a waste mill, through which filling may be sent down from above; or the mill can be cut in the foot-wall. When the cross-stope reaches the upper worked-out ground, longitudinal stopes *i*, one or two sets in height and one set in width, are driven to half the distance between the cross-stopings, leaving between them intervals or pillars two sets wide or more if the ground permits. These longitudinal stopings are timbered lightly, having to stand but a very short time, and being in the solid undisturbed ore, with the filling from above resting on each side of them on solid ore. When the mid-distance between the cross-stopings is reached, the back-stoping commences by taking out the ore on each side of the stope *i* to the width of a set, or half the pillar left between the longitudinal stopings *i* supporting the "gob" roof while doing so, and laying lagging poles or slabs across the floor of the stope as the work proceeds. Any waste rock or material available or desirable may be thrown back in the packing, and when a space the area of one

or two sets is worked out on each side of the last sets of the longitudinal stope *i*, the temporary timbering is drawn, and the "gob" roof, with the lagging previously laid under it, is allowed to drop on the bottom of the stope lagged to receive it. Light poles, and even brushwood, will serve for thus keeping the ore from mixing with the waste. (It will probably be found possible, as well as advantageous in many cases, to drive these longitudinal stopes *i* two sets high, and draw back the upper one a little in advance of the lower, and as they can be driven out at any point in the cross-stope, a whole horizontal slice or section of the ore-body, no matter what its thickness, can be opened out, say two sets in height, at the same time.



FIGS. 39, 40.—WORKING DOWNWARDE ON SOFT ORE-BODIES.

The advantages claimed for this system are: (1) that all the work is simply stoping; (2) all levels and stopes that have to be timbered are in solid, undisturbed ore, and being only one "set" in width, are easily held, and require but light timber, while much of this is drawn and saved in letting the roof down; when the stope comes up to the filling, this has only to be supported over one set of timber, while it rests on the solid ore on each side; (3) the filling follows the ore down, and as long as this occurs, the cave on the surface can be constantly filled from "borrow pits" much cheaper than by sending the filling below; (4) it is possible to obtain practically all the ore in the

vein, and to get it free from mixture with waste; (5) caves or crushes are impossible; (6) more ore can be extracted from a given amount of ground in a given time.

Another example of working in soft ore-bodies is that at Low Moor, Virginia. The ore is generally soft, and all drifts require close timbering. The hanging-wall *a* (Fig. 41) is a band of broken flint and clay, and the foot-wall *b* is sandstone. Main levels *c* are driven in the vein along its strike, 60–80 ft. apart vertically, starting from the surface on the side of the hill or from a hoisting shaft in the valley.

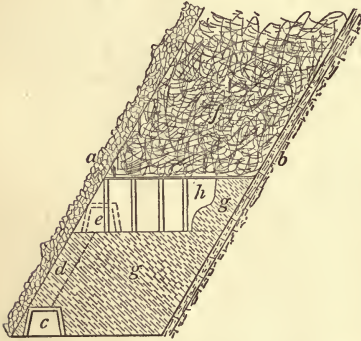

FIG. 41.—WORKING ON SOFT ORE-BODIES.

They are usually on the flint wall, whether it be the foot or the hanging, because the flint is a better guide in following the vein. These levels are driven along the vein to such a distance from the hoisting-shaft as may be required to reach all the ore which it is intended to raise through that

shaft—in some instances over half a mile. While the main levels are being driven, the pillar between two levels is usually left untouched, except by up-raises connecting the two levels every 400–600 ft. for ventilation. When the levels are completed, the portions of two levels farthest from the hoisting-shafts are connected with up-raises *d*, 60–75 ft. apart, two or three up-raises are joined by air-drifts *e*, and the ground is ready for stoping. The timber in the air-drifts is recovered in stoping. The stopes are 12–15 ft. high, each pillar between two main levels making 4–6 stopes. As soon as a stope is worked out for 40–60 ft. along the vein, a floor is laid, consisting of sills covered with refuse timber or slabs, and the props are shot down. The waste material *f* from above packs solidly upon this floor, and in a short time the next lower stope can be worked, using the floor previously laid as a roof to hold the waste material from the ore. A stope 40–60 ft. long, measured along the vein, is begun in the drifts, by first mining the ore *g* above the drift-timbers till the floor of the next stope above is reached, and setting props. The face of the ore for the length of the stope is then mined back to the opposite wall, as shown at *h*. The ore is dumped into the shutes *d*, drawn from them into cars on the main levels *c*, and hauled by mules to the surface or to the hoisting-shaft.

When the vein is 12 ft. or less in thickness, so that a single prop will reach from wall to wall, the method is somewhat modified. A stope-drift is driven a short distance above the main level, parallel with it, and connected with it by shutes at intervals of about 50 ft. The ore is then stoped from this drift to the next upper main level, props being placed from wall to wall. These props are eventually shot down, and the waste material is caught by a horizontal floor,

which will serve as a roof for the next lower stope, as before. In this way the timber for a number of floors is saved, but the modification is only of advantage when the vein is narrow enough to permit a single prop to reach from wall to wall, and where, moreover, the hanging wall is fairly good. In this way all the ore is mined, no filling is required, and the work is comparatively safe. In some instances, means must be taken to exclude surface water from the breaks which run up to daylight when the country rock sinks to fill cavities.

The term "stripping" is applied to what is really simple quarrying adapted to the exploitation of a vein. It has been rendered possible by modern improvements in mining machinery and appliances, which allow of much more complete preliminary determination of the quality and extent of underground deposits, and much less costly blasting operations. The advantages of stripping are that the work is conducted in the open day, and that there is less risk of unremunerative dead work on the one hand and of overlooking ore on the other.

At the Peters mine, Ringwood, New Jersey, where the limit of profitable mining by the old method has been reached, it is intended to remove the ore floors and pillars by stripping. While the vein stands nearly vertical, the ore shoots overlie each other at an angle of 35° and some 10-30 ft. apart. It is proposed to take advantage of this, and pile up the waste on the end wall of the lowest shoot as rapidly as the wall is uncovered by removal of ore. This back filling will make the mine safer, and will obviate much excavation by allowing the slopes to be considerably steeper than if the pit were to be left open permanently.

At the Bertha zinc mines, in Virginia, zinc carbonates are found to the extent of about 8000 tons per acre, underlying some 80 ft. of earth, so that 30 cub. yd. of earth have to be removed for every ton of ore mined, and this is done profitably.

In the case of the Dannemora mine, Sweden, stripping has been successfully carried to a depth of about 500 ft., and at the Fahlun copper mines to even greater depths.

When mining was first begun at the mines of the Longdale Iron Company, Virginia, the outcrop was 500 ft. above the creek level, and the deposit was for many years worked entirely by open cuts. As time went on, however, the excavation was carried so deep (130 ft.) that the cover grew too heavy, and it became necessary to obtain the ore by underground workings. It was finally decided to stope the ore from the top down. This plan was adopted in 1881, and has been followed ever since with complete success.

The method of attack is to sink a test-shaft upon the ore to the depth at which it is desired to drive an adit.

The line of least distance from the surface to the ore at the level chosen (the length of which line is obviously largely governed by the height of the "lift" to be secured) is then determined, and the adit is driven straight in, through the overlying shale, to the ore, a distance varying from 300 to 1200 ft., according to the height above the creek at which the adit is driven. The highest adit was driven directly upon the ore from the bottom of a ravine which cut across the vein.

On reaching the ore, the adit is continued by galleries in both directions, following the bends of the vein. These, it may be remarked, are both many and sharp. Parallel with the main entry or car-level, an air-way is driven at a height of 20 ft. from the bottom of the main entry at the bottom of the air-way. As the main entries are 6 ft. high, this leaves a pillar of ore 14 ft. thick between the two levels. At intervals of about 120 ft. on the car-level, shutes or raises are driven up through this pillar to the air-way. These shutes are supplied with spouts and gates for loading the mine cars; 20 ft. beyond each shute, in the direction of the heading, a second passage, called the man-way, is driven up, to afford means of ascent for the men who are working above.

As the air-way is always connected with the test-shaft above mentioned, this system affords very perfect means of ventilation. Of course, it is necessary to keep most of the shutes and man-ways nearest the mouth of the adit closed in order to force the incoming air to the headings. From the air-way the shutes and man-ways are driven up until they reach the surface in the bottom of the old open-cut workings. This, however, is not all done at once, but only as needed for the working of the mine.

At every 10 ft. of vertical height above the air-way a lateral level 5 ft. high is driven off along the ore, thus leaving a 5 ft. pillar under each drift.

When the open-cut workings, mentioned above, were about to be finally abandoned, a grillage of small poles was laid down; this formed a floor resting upon the ore in the bottom of the cut.

Outside working was then discontinued, and the sides were suffered to fall in upon the grillage, after which the mines were ready for underground working. The system is as follows:—

The pillar of ore over the highest level, or, in other words, the ore left in the bottom of the old cut, is first attacked and taken out, the roof being supported during this operation by heavy props set up a short distance behind the working-face, under the grillage mentioned above, and standing upon a similar grillage placed upon the ore under foot. Where the vein is horizontal, or nearly so, the lower grillage may be omitted, the roof being allowed to fall directly upon the floor, which, in such cases, is the foot-wall. This row of posts supports the roof until the ore has been taken out for a short distance ahead of them, when a second series is set up in similar manner.

It is customary not to leave the roof standing, even if the props are strong enough to support it for some time, but to cause it to fall, by either "shooting out" the props (i. e. breaking them down by means of dynamite) or by drawing them out if they can be saved.

The ore that comes from the face is wheeled to the nearest shute, into which it is dumped. After the top pillar has been robbed for a few feet, generally 10 to 20 ft., the next one below is attacked in the same way. Every level in the mine can thus be worked simultaneously, the workings resembling a series of 10 ft. steps.

The construction of a cheap floor or grillage of poles is repeated on every level to prevent the sliding of the waste from old caved

stopes above. This floor is of course removed after serving its temporary but important purpose.

The ore dumped into the shute descends by gravity to the car-level, unless it is stopped by meeting a flat place or "bench" in the vein and consequently in the shute. When this occurs, rehandling becomes necessary, which is carried out in the manner best suited to the circumstances. As the ore finally arrives at the car-level it is drawn into mine cars, hauled to daylight, and dumped upon a horizontal screen of round iron bars, which is set in the top of the ore-bin beside the railroad. The fine ore falls through the screen into a pocket, while the lumps remaining upon the bars are further broken and sorted by hand and thrown into an adjoining pocket. From these pockets the ore is drawn into cars on the railroad leading to the furnaces, the lump ore being taken directly to the furnace bins, while the fine is conveyed to the washer.

In the case of flat beds, such as coal and ironstone, a totally different method is adopted, the main object being to afford support to the roof.

The "longwall" method, which closely resembles the overhead system already described, is applicable to nearly horizontal thin

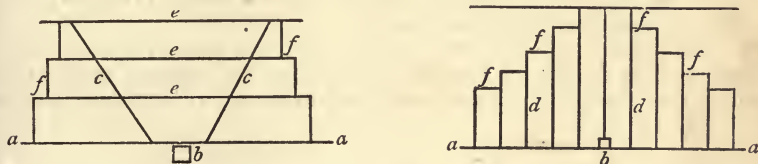

FIGS. 42, 43.—LONGWALL WORKING.

beds which furnish sufficient waste for filling. The main tunnel *a*, Figs. 42, 43, is built high enough to accommodate the trucks for transporting the mineral to the hoisting shaft *b*, and is run at the lowest part of the bed, so as to form a natural drainage for the mine water. From it drifts are run into the mineral, either diagonally as at *c*, or transversely as at *d*, and connected by parallel levels *e*. The direction of the drifts is governed by the rate of dip of the bed, the object being to secure a suitable incline for the trucks which carry out the mineral. The workings are connected all round by cross-cuts as at *f*, to complete the circulation of air for ventilation.

The system known as "pillar and stall" is adopted where the beds are thicker, and do not afford sufficient waste for filling, so that pillars of mineral have to be left standing as a support for the roof. The main tunnel *a*, Figs. 44, 45, is run as before from the shaft *b*, and from it are run drifts *c* at intervals, and crossing these again, levels *d* parallel with *a*, and occasionally diagonal drifts *e*. The bed is thus divided into regular blocks, portions of which, varying in size, are left to form the pillars that support the roof, these being finally withdrawn as far as safety will allow.

In seams having a rate of dip of 40-60° it is the custom to drive the stalls square off from the gangway, up the "rise" of the seam, and

have the coal to run down the shute into the tram at the bottom of it: with this rate of dip the shute does not require planking at the side or bottom to make the coal run, and by keeping the shute full, except 3-4 ft. working room at the breast, there is very little coal lost by pulverising in its descent down the shute, as by that method it descends by slow settling in proportion as it is allowed to run into the trams at the bottom.

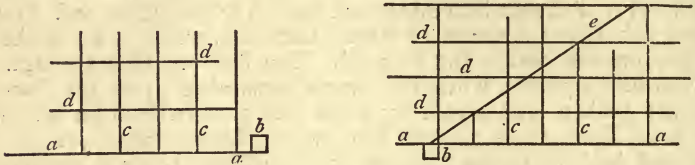

FIGS. 44, 45.—PILLAR AND STALL WORKING.

In seams of 30-40° rate of dip the miners are compelled to plank the sides of the shute to some extent, in order to enable the coal to slide down without assistance. In seams of 25-30° the coal will not descend in the shute unless the sides are partly planked, and the bottom covered with sheet iron. In working seams having a dip of 10° or under, the stalls are driven diagonally to the direction of the gangway, unless the rate of dip is less than 4°.

The trams or mine cars used in Europe are, in nearly every case, smaller than the American; the reason for making them so, in most cases, is to reduce the enormous first cost of the deep shafts,

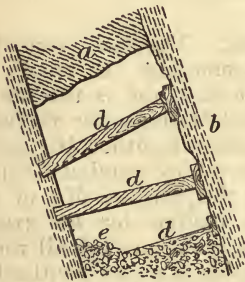

FIG. 46.
STEEP COAL VEIN: BAD ROOF.

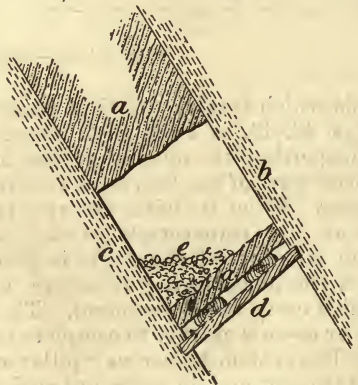

FIG. 47.
STEEP COAL VEIN: GOOD ROOF.

by having a small shaft area, thus leaving but a small space for the mine cars or cages and pump way; the small mine cars also suit the large number of boys employed in European mines.

For more detailed illustration of the manners of working coal and similar beds, the reader is referred to the following figures and descriptions:—

In Fig. 46 is shown a very steep coal vein. The coal *a* is over

4 ft. thick; the roof *b* is full of joints and very treacherous, necessitating the use of many timbers *d*; the floor *c* is hard and sound. The waste *e* from floor and roof is allowed to fall and accumulate under the feet of the miners, and by it the timbers are gradually and successively buried.

Fig. 47 delineates a similarly steep bed, but in this case the roof is very good, and consequently no timbering is necessary. Both roof *b* and floor *c*, however, are lined with a friable rock some inches in thickness, which falls with the coal *a*, and is allowed to collect as at *e*, forming a platform for the miners. The seam is worked in sections, which are separated by stout timbering *d*.

Fig. 48 illustrates the mode of timbering a roadway. The coal seam *a* is surmounted by a considerable thickness of weak shale *e*, which does not long survive the removal of the subjacent coal, and is quite distinct from the firm and reliable sandstone roof *b*. The practice is, therefore, to let this shale break down and accumulate, as at *f*, on the floor proper *c*, and to lay the tramway *g* upon it. Falls from the upper part of the seam into the roadway are prevented by a lining of posts and slabs *d*, well secured in roof and floor, and further strengthened by cross-posts.

Fig. 49 represents a seam carrying three separate qualities or kinds of coal, called respectively "tops" *a*, "middles" *b*, and "bottoms" *c*. The roof *d* and floor *e* are both very sound and firm. Owing to the top coal being very

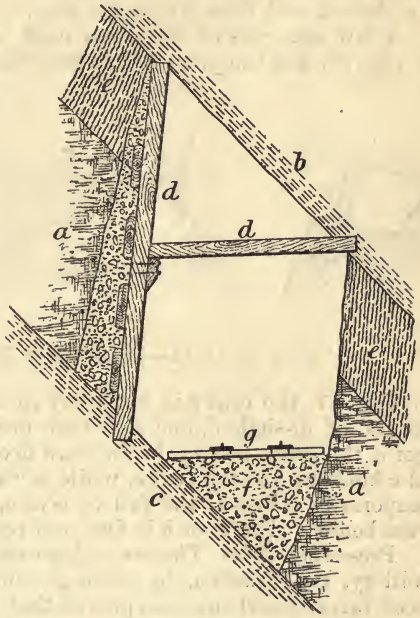

FIG. 48.—TIMBERING ROAD-WAY IN COAL.

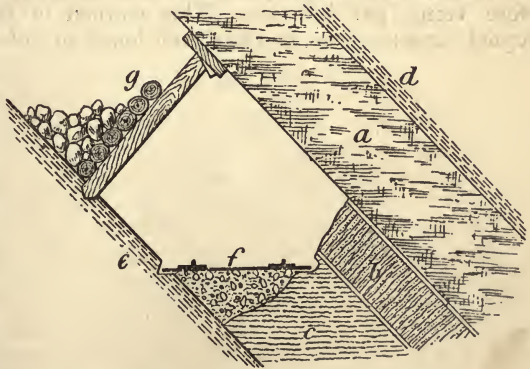
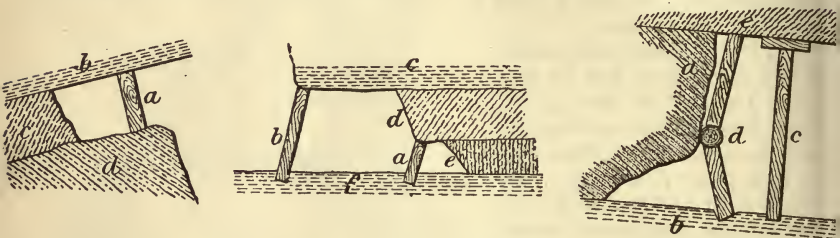

FIG. 49.—SEAM WITH THREE KINDS OF COAL.

owing to the top coal being very

strong, it is possible to work the middles and bottoms separately, leaving the tops for a distinct operation. The tramway *f* is laid on waste, and at *g* is shown a staging of slab-posts, on which the coal is collected, and from which the loading is done in safety.

A few examples of the props used in flat veins are given below. In Fig. 50, *a* is the prop, *b* the roof, *c* rock overlying the coal, *d* coal.



FIGS. 50, 51, 52.—EXAMPLES OF PROPS IN FLAT VEINS.

In Fig. 51, the coal *e* is cut away in advance, a prop *a* supporting the bed of oil-shale *d*, and a further prop *b* sustaining the sandstone roof *c*, the props resting in the hard floor *f*. In Fig. 52, a prop with a lid *c* holds up the top coal *e*, while a “knee joint” or “cocker meg” *d* temporarily prevents the fall of coal *a*, while it is being worked on from below. The floor *b* is firm and resisting.

Preserving Mine Timbers.—Experiments made at the Altenwald Colliery, Saarbrücken, in coating mine timber with lime, coal tar, wood tar, and carbolineum, proved that lime was the worst and carbolineum the best preventive against dry rot. The cost of a double coating of carbolineum to a prop $8\frac{1}{4}$ ft. long and 10 in. diam. was $6d.$ for the carbolineum and $1\frac{3}{4}d.$ for labour. At various mines in Saxony not only are the supports wetted occasionally to prevent dry rot, but the wood is first impregnated with a solution of ferrous sulphate before being put into use. This method of treatment has been adopted for some time, and has been found to give very good results.

HAULING AND HOISTING.

WHEN the mineral, of whatever kind, has been broken down in the mine ready for removal, the next step is to load it into receptacles in which it can be hauled along the levels and hoisted up the shafts at the least possible expenditure of time, labour, and wear and tear of machinery.

Wagons.—The ordinary mineral wagon or hutch is simply a miniature railway truck running on a miniature line of rails. These latter are generally of iron, but often also of squared timber covered with strap iron, and sometimes are simply small round poles laid end to end. The wagons are of numberless kinds: some entirely of wood, some entirely of iron, some of wood and iron combined; some have no tipping arrangement, some tip sideways, some tip endways, some tip in any desired direction. For details of construction and illustrations of many forms, the reader is referred to the author's work on 'Mining

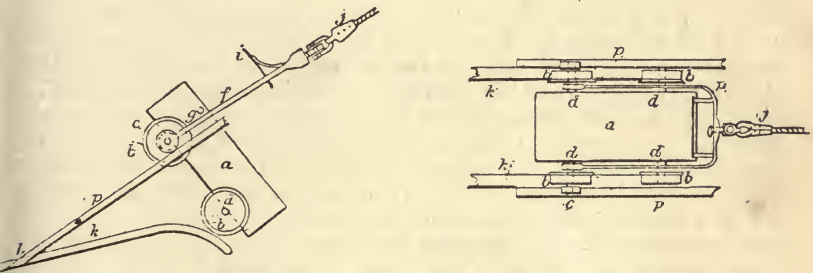

FIGS. 53, 54.—AUTOMATIC INDEPENDENT TIPPLER.

and Ore-dressing Machinery.' It will suffice here to describe an ingenious arrangement for tipping wagons which has the twofold advantage of being quite automatic, and of providing a tipping contrivance independent of the wagon, by which means the common ordinary wagon is rendered available, avoiding the complicated structure, increased cost, and serious wear and tear incidental to the specially built "tippler." The arrangement is shown in Figs. 53, 54. The wagon *a*, running upon 4 wheels *b*, is made to ascend a slight incline just before tipping, being drawn by the bow *f* attached to the rope *j*. The bow is also rigidly united to the axles of the hind wheels, and in front it carries the door *i* of the wagon; *k* is the railway at the top of the incline, and *p* is an additional outer line of rails laid on a steeper grade. When the wagon in its upward course reaches the point *l*, the rails *p* pick up the small outer wheels *c* on the hind axle,

so that the hind wheels travel up the steeper grade while the front wheels follow the rails *k*. Consequently the wagon is tilted forward, and as the door or front end *i* is attached to and rises with the bow *f*, the contents of the wagon are shot out. A stud *g* prevents the wagon being drawn too far. On slackening the rope *j* the wagon rights itself, and descends properly, the door *i* automatically closing.

Underground Hauling.—The loaded wagons have to be hauled either to the mouth of the adit or to the bottom of the shaft. The power to perform this hauling may either be attached to and move with the wagon, e. g. men, horses, engines; or it may be derived from a distance, as in rope and chain haulage. Whenever possible, the roadways are made with a slight and regular gradient, so that the wagon shall exert its own gravity in travelling loaded to its destination, and it is sometimes possible to make the loaded wagons running downhill pull the empties up again, which is manifestly an economy of power.

In such a self-acting incline the road must be more or less uniform in gradient, for if steeper in some parts than in others the train must be run over the steep portion with great velocity in order that it may acquire sufficient momentum to carry it through the flatter portion; while in a great many cases it is impossible to work an incline by trains at all if the flat portion of the road happens to be at the top and the steep portion at the bottom, as a start cannot be obtained.

In working with a self-acting endless chain, if the average inclination of the road is not less than will give an excess of power in the pull side sufficient to overcome all the frictional resistances and the weight of the empty side, the incline will work no matter how undulating it is, provided the average inclination is calculated from the total length of the road, and not from the horizontal distance on the section. The surplus power on a steep mine may be utilised for the purpose of drawing from a dock or level, not necessarily in the same straight line, by fitting the top wheel with a long shaft and putting on it a second driving wheel, or clip-pulley, or rope-drum provided with a clutch. In the same way water may be pumped, or almost any description of work done, if the power be sufficient.

The advantages which a self-acting endless chain possesses over an ordinary incline may be summed up shortly as follow:—

(1) Small cost of upkeep of rolling stock, owing to slow speed causing few breakages. When a wagon goes off the road the chain stops.

(2) Regularity of delivery. The wagons arrive at their destination in such a regular manner that only very short lyes are required, and consequently the travel of the bottomers or landers is diminished, and their labour is rendered so much the more effective.

(3) When the output exceeds 100 tons a day, and probably before that, it can be worked much more cheaply than an ordinary self-acting incline.

(4) Length makes no difference in the output or cost further than the increased upkeep of the road.

(5) Much less expenditure is required in making benches, as no long trains require to be collected on the incline.

(6) The cost for chains is less than for ropes, as a good chain will last 12-18 years.

The question of the relative economies of man power, horse power, endless ropes or chains, electric engines, compressed air, &c., for effecting haulage, is very largely governed by local conditions. The subject is dealt with at length in the author's 'Miners' Pocket Book,' where many instances of actual costs under various circumstances are given.

Hoisting.—Hoisting, during the early stages of a mine's history, is done in buckets or kibles of various forms by means of a common windlass. This is feasible, up to a depth not much exceeding 150 ft., beyond which a horse whim is useful up to about 300 ft. As the depth increases, hydraulic, electric, or steam power is called into requisition, usually the last named.

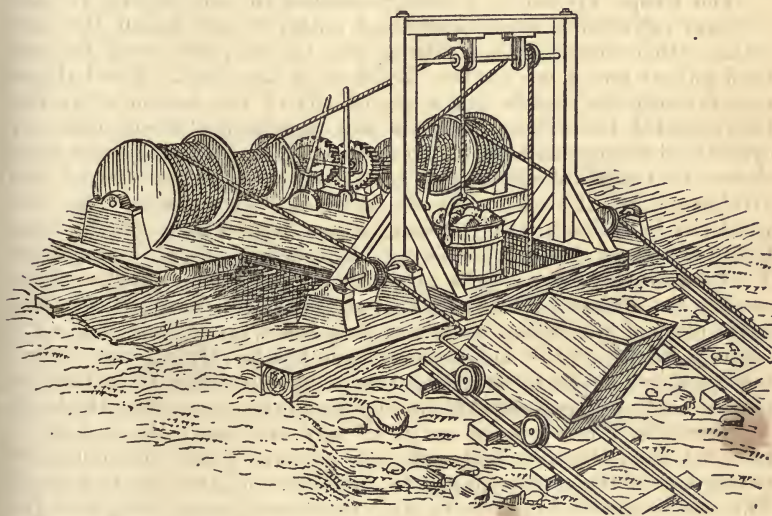

FIG. 55.—GRAVITY HOIST.

Where the contour of the country at the pit mouth is suitable, the arrangement shown in Fig. 55 is very economical, gravity being the force employed. The drums or windlasses of the apparatus are carried by two shafts geared together at their inner ends, each shaft carrying two drums, one of which is larger than the other. On the smaller drums are wound the hoisting ropes, which pass over pulleys on a shaft on a suitably constructed frame, and are connected with the buckets travelling in the shaft, the arrangement being such that when one bucket descends the other rises, and *vice versa*. On the larger drums are wound cables connected with cars travelling in opposite directions on inclined tracks, the cables and the hoisting ropes being so arranged relatively to each other that when an empty car is at the upper end of the incline a filled bucket will also be at the top of the shaft, in position to be conveniently emptied into the car, the down-

ward travel of each filled car along the inclined road exerting a pull on one of the ropes on the large drums to cause a filled bucket to be raised, while at the same time an empty car is drawn up and an empty bucket is let down. A brake-band is provided for each shaft, operated by a lever conveniently arranged, and that the two shafts may be readily disconnected, for lengthening or shortening the cables or other purposes, their inner bearings are fitted to slide, and are each connected by a link with a lever pivoted on the frame, by means of which the bearings may be moved to disengage the gear-wheels. The construction is very simple, and the hoisting work is all the time under the control of the operator.

In the case of rapid hoisting, a direct-acting hoisting engine is essential. Various forms are described at length in 'Mining and Ore-dressing Machinery.'

The Koepe system of winding consists in substituting for the ordinary cylindrical drum a grooved pulley round which the rope makes rather more than half a turn, and thence passes over the pit-head pulleys and down the two divisions of the shaft. The balance rope beneath the cage is not a peculiarity of the system, as it has been applied for a long time to winding-engines where ordinary cylindrical drums are used. Experiments on the Koepe system have shown that with the rope passing only one-half turn round the driving-pulley, the coefficient of adhesion between steel rope and wood rim is in practice 30 per cent., which admits of a great excess being placed on present ascending loads before any slip can occur. That no slip actually results in practice (under the *usual* working conditions) is shown by the fact that at Bestwood colliery the winding takes place at the upcast shaft which is cased in, and the cages are entirely out of sight of the engineer, who has to rely entirely on the indicator, and under these circumstances has no difficulty in landing the load. It is, however, evident that when the cages reach the landing-places and rest on the stops (if any are used) the weight is removed from the rope, and sufficient adhesive power may not exist on the rim of the motive-pulley to enable the loads to be re-started. This can be guarded against by dispensing with stops altogether (as is done at the Sneyd colliery), or by continuing the rope past the cages by means of cross-heads above and below each cage, connected together by side pieces passing outside; the bridle chains are hung from the top cross-head, and when the cage rests on the tops the weight of the winding- and tail-ropes still remains on the motive-pulley. This is the arrangement used at Bestwood. The single winding-rope at the Hanover colliery has been found to last more than twice as long as the two ropes formerly adopted. The chief advantage of the system, apart from the perfect equalisation of the load, which can also be obtained in any engine with ordinary cylindrical drums, consists in doing away with the drum, which in many instances weighs 60 tons, and has of course to be set in rapid motion and stopped in a short space of time, causing a large waste of energy. The Koepe system of winding has been adopted at Oberhausen and Westhausen in Westphalia, Stassfurth in Upper Silesia, and Bestwood and Sneyd collieries in England, but has since been abandoned

at Oberhausen and Westhausen, possibly because breakage of one rope would cause the stoppage of both sides of the pit. After 7 years' successful working, Koepe's system has been lately abandoned at Bestwood for two reasons: the management do not consider it safe, and slipping of the rope takes place every time it is oiled; this slipping commences immediately oil is applied, and after a time ceases altogether, to re-start, however, at the next oiling. This action is very objectionable at Bestwood, for, as before stated, the engineman has to rely entirely on the indicator for landing the cages, as he cannot see them when they reach the surface, owing to the top of the shaft being cased in. Against these abandonments we have the fact that no accident has occurred at the Hanover pit since the installation was put down in 1877; indeed, the life of winding-ropes is increased as before stated. This system is also giving every satisfaction at the Sneyd colliery in North Staffordshire.

The improved Robey mining engine, made by Robey & Co., Limited, Lincoln, is one of the most modern types, and is well spoken of.

The following notes on ropes, obligingly contributed by Felten & Guilleaume, of Mulheim-on-Rhine, through their English agents, W. F. Dennis & Co., London, will be read with interest as conveying the experience of the foremost rope-making establishment in Europe.

Mining ropes may be classed as winding, hauling, and guide ropes. For winding and hauling purposes the most common construction is 42 wires and 1 hemp, or 36 wires and 7 hems; but the makers do not confine themselves to these constructions, and it is desirable if possible to furnish particulars of the conditions under which the rope is required to work, so that they may use their discretion in case they consider it advantageous to alter the construction. The two constructions before-named are usually supplied by English rope-makers, which simplifies their work, but it is not always to the advantage of the buyer.

The class of wire employed depends more or less upon the conditions of working, and the principal factors to be considered are:—

(1) Dimensions of drums and pulleys, as small pulleys generally tend to shorten the life of a rope unless the rope can be made more flexible, in which case however it is more apt to suffer from friction or abrasion.

(2) The presence or absence of guide-rollers, in the case of hauling ropes, and their dimensions; it is injurious to ropes to work without guide-rollers.

(3) The angle made by the rope in passing from the drum and going round the pulley; the sharper the angle the more injurious it is to the rope.

(4) Whether the rope is wound on the drum in one or more layers; if in more than one layer, the rope suffers.

(5) Whether the shaft is dry or wet; in the latter case, especially if the water is acidulous, the rope must be selected differently and very carefully treated. Generally in such cases the size of wire must be as large as conveniently possible, and sometimes it may be preferable to have the wire galvanised; but in every case the ropes must

be well dressed with a good grease free from acid or creosote. This greasing is always beneficial also for ropes working in dry mines, but is indispensable in wet or acid shafts.

The class of wire too may be different as regards the material employed to ensure a lower or higher breaking strain. Ropes of iron or steel are supplied with a breaking strain of 20 to 40 tons per sq. in., but are now very little used.

The quality most employed for winding and hauling ropes is patent cast steel with a strain of 80–85 tons per sq. in., but in cases where it is desirable to get the rope in the smallest compass with the highest attainable strength, other classes of wire are employed, with a breaking-strain of 110–120 tons per sq. in.—so-called “plough” steel wire.

The prices of ropes usually increase with the reduction in size of the wires employed, and for the purpose of simplifying matters Dennis & Co. give in their general price list for wire ropes the gauge of wires usually employed and the corresponding prices in the different qualities.

Guide-ropes for mines are usually composed of 7 to 19 wires of soft, tough material, “homo” steel or iron.

Felten & Guillaume’s ropes have a high reputation, and give great satisfaction wherever introduced, all over Europe and in the Colonies. They also supply ropes on the principle of Albert or so called “Lang’s lay” (wires and strands stranded in one direction), which is especially adapted for haulage and will usually outlive the ordinary construction; as well as the “lock coil” rope, which is composed of round and sectional wires, the latter so shaped that they interlock, preventing a broken wire from rising out of its place. They can be used of spiral construction for guide-ropes where the ordinary construction of rope would require to be stranded, and are of less weight strength for strength by the reduction of section, as compared with the old style.

In the United States the wire ropes manufactured by the John A. Roebling’s Sons Co., Trenton, New Jersey, are the standard throughout the many mining fields for lifting and hauling plants. The suspension bridges at Niagara and at East River are built with the wire of this firm. Their electrical copper wires have a remarkable reputation.

The drums or reels of hoisting machinery are made for either round or flat cables or rope. Where the shaft is inclined, and the hoisting is done by cars, round rope is used. In vertical shafts, where cages are used, flat rope is preferred. The drums should be of large diameter, to reduce the bending strain to which the rope is subjected. Ropes are of iron or steel. Where lightness and strength are especially necessary, as in the case of deep hoisting, steel is preferred.

Ropes used in inclined shafts are subjected to more friction, and consequently last a shorter time than ropes used in vertical shafts.

Ropes hoisting 80 to 100 tons a day last about one year. After a wear of 6 months, however, the rope should be moved to the side of the shaft which is not used for the purpose of lowering the men.

Rules for the selection and care of ropes, and for calculating the

sizes of drums, &c., are fully given in the author's 'Miners' Pocket Book.'

In hoisting through vertical shafts, the gallows frame upon which the sheaves are supported should be 50 ft. or more in height. The additional height reduces the liability of over-winding. There are several automatic devices, connected with the hoisting hooks from which the cable is suspended, for preventing over-winding.

An excellent arrangement at the Lens Colliery, near Lille, consists of an arrangement of valves, which come into play directly the cage reaches a certain point in the shaft and, if the engine should at that moment not be under control, immediately apply a powerful air-brake. This, however, allows the cage to proceed at a certain speed; but should another point in the shaft be passed, and the engine be still out of control, the brake is increased in power, steam is entirely shut off, and the cage is brought to a standstill.

Cages.—Every cage should have a spring or buffer for taking the strain off the winding rope at the moment of commencing the hoist.

In vertical shafts, the cages run upon guide-timbers. The cages are provided with safety catches, which operate when the tension of the rope is suddenly released, and hold the cage fast in the guides. The safeties should be frequently tested.

Double-deck cages are preferable when hoisting from great depths, as their use increases the capacity of the shaft.

When the shaft is steep but not vertical, cages may be used, nevertheless, by having an adjustable platform, which ensures a constantly horizontal position of the platform. Cages of this design are useful where there is a departure from verticality at any point of the shaft.

The adoption of some form of balance to the cage or skip equalises the strain on the winding gear and leads to great economy in reducing the wear and tear of rope and machinery and conserving power. A simple method consists mainly in coupling the shaft of an auxiliary winding drum or "spider" to the shaft of the main winding gears, and in attaching to this auxiliary drum or spider a rope or chain of increasing weight to act as a counterpoise to the cage and haulage rope. This rope or chain may hang either down the pump-shaft or down a blind shaft or bore-hole, in any convenient position adjacent to the winding gears.

The counterbalance chain is made in lengths, the weight of each of which is relatively greater than that of the length next above it. The upper end is secured by a light rope to the auxiliary drum or spider.

Skips.—Self-dumping skips are often used in vertical shafts instead of cages. They are useful for moderate depth, and especially for sinking, as they can raise rock and water at the same time. When the skip reaches the surface, wheels arranged on either side are forced to pass between the inclined guides, as a consequence of which the skip is tipped sufficiently to dump its contents.

In incline shafts, self-dumping skips are run upon tracks. Where the incline is flat, cars are generally used. There is an economy in having large cars of about $1\frac{1}{4}$ tons capacity; as large, in fact, as are easily handled.

The Frongoch skip shown in the accompanying illustrations (Figs. 56-66) is worthy of special mention, as it empties itself automatically on reaching the top of the shaft, and then rights itself without the aid of a lander, as soon as it is lowered. The time occupied in lowering the skip on to a door, knocking up a bolt so as to discharge its contents, closing it again, and raising the skip so that the door may be drawn back, is all saved, and the services of the lander are entirely dispensed with. The skip is the usual box *a*, made of sheet iron or sheet steel, with 4 wheels *b* running on the vertical wooden conductors *h*, and prevented from leaving them by the back guide *d*, at or near the bottom. The bow or loop *e*, instead

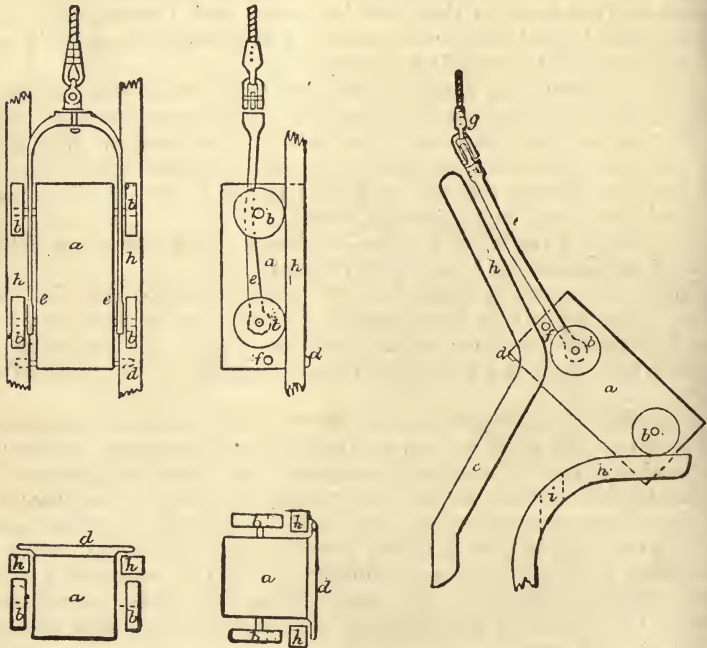

FIGS. 56-60.—FRONGOCH SKIP.

of being attached to the top of the skip, reaches down, and is attached to the axles of the bottom wheels. It rests against the axles of the upper wheels, and the skip is thus prevented from falling away from the guides. At the surface, each perpendicular conductor terminates in a curved piece, and a front guide *h* is added on each side. When the skip comes up, these front guides press upon the top wheels and turn them on to the flat ends of the conductors. The partial cutting away of the conductors at *i* enables the back guide to pass through and the bottom end of the skip is now raised, and the contents are tipped or "dumped" into a large bin or pass, from which the ore can be drawn away at pleasure. If the engineman does not stop at once

the skip is simply drawn a little way up, resting upon the front guides *c*, the stop or stud *f* preventing it from assuming a wrong position. As soon as the engineman begins to lower, the top wheels drop upon the flat ends of the conductors, and pivoted upon these top wheels the tail end of the skip drops, the back guide passes through the slot *i*, and the skip, resuming its upright position, descends the shaft. One great recommendation of this system is that it can be applied to existing shafts, whether perpendicular, inclined, or crooked. It is the subject of a patent.

Coal Dumps.—There is a special feature about coal dumps in that it is essential to avoid breakage of the coal so far as possible. Perhaps the best form yet introduced is Wilson's automatic safety dump, as furnished by John Davis & Son, Derby, and shown in Fig. 61. The safety-horns A, placed at any given point or at any distance behind the dump, prevent a second wagon from entering on the dump till desired. Push and pull rods are attached to the horns, and

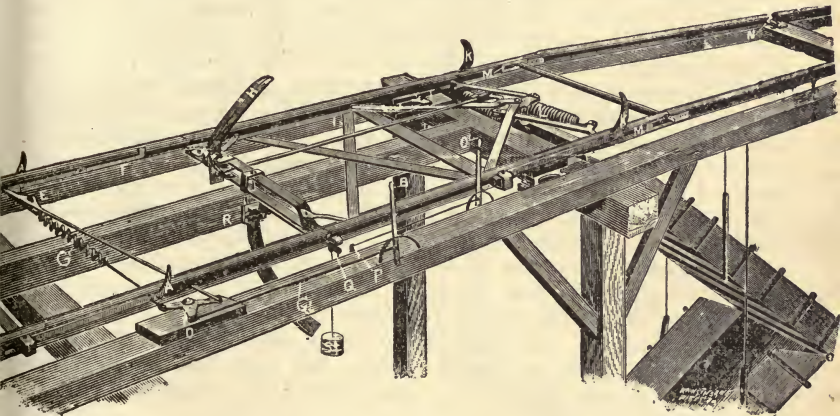

FIG. 61.—AUTOMATIC SAFETY COAL DUMP.

connected by a T-iron D and spreading-rod C to a lever B. The notch E in the push-rod extending from D and intersecting the latch F, holds the safety-horns open until the rear wheel of the wagon has passed the horns A, when the front wheel strikes the projecting part of latch F, lifting it from notch E, allowing spring G to close the horns A immediately behind the rear wheels, and preventing another wagon from entering the dump until desired by the operator. A press-lever H has connection through rod I with T-iron J, whose arms reach the dump-horns K. Thus, when the bottom of the wagon begins to ride upon the press-lever H, giving it a downward movement, the lever pulls backward on rod I and through J spreads apart the dump-horns K so as to allow the empty wagon to pass between them on a down-grade to a return track. When the empty wagon has passed the dump-horns K the rear end of the full or approaching wagon has passed the press-lever H, allowing springs L to close the dump-horns K, holding the wagon in place until it is dumped in

turn. The break rails have a slot M in the rear end, and are hinged at their forward end N, giving them a lengthening and shortening motion as required in the up-and-down motion of the dump. The motion of the dump is regulated by the lever O, having connections with point of weight-lever Q and arm P, extending to brake R, and held in place by weights S. The dump-brake has a smooth, regular rocking motion, and has none of the jarring and jerking produced by other dump-brakes now in use.

Coal Conveyors.—The conveyance or transfer of coal from the mine to distributing centres such as railway stations and river piers, without undue breakage, is an operation demanding particular care, and has called into existence special appliances whose adoption may be usefully extended outside the coal trade. The construction of what are known as "river tipples" in America requires various precautions to be taken against sudden freshets, drifts, and ice-gorges, and generally something more than the building of mere breakwaters.

The first method adopted for river transfer was a simple incline, with a movable cradle, which could be raised or lowered to suit the different stages of water. This system, though limited to a small capacity, and to cars not larger than those commonly used underground, possessed two advantages. The first cost was comparatively small; and, since the structure did not obstruct the channel, there was little risk from freshets, the utmost damage from which could be repaired at small expense. Its disadvantages, however, were many, the principal among them being the breakage of the coal by reason of the necessarily high dump; the damages to barges from the same cause; and the difficulties of screening and distributing the different sizes into separate barges. Hence this system has been almost abandoned in favour of the basket-arrangement, lowering vertically into the barge, with the aid of counter-weights, which return the empty basket; while pipes or shutes convey the small coals into other barges, from a complete set of screens, which this method will readily accommodate.

The latter system is now generally employed along all the tributaries of the Ohio.* It has been elaborated to meet enlarged outputs, until the cost of construction, in many cases, has reached 8000–10,000*l.* Where mines have been connected with the river by railway, necessitating the transfer into larger cars at the drift-mouth, the same system has been employed to lower the railway cars, so as to avoid the breakage from an extra dumptage. Owing to the fact, however, that a barge must be laden uniformly, to avoid damage, it has not been found advisable to dump more than 2–3 tons on any one point; and the largest car used in this manner has a maximum capacity of about 6 tons, dumping from the centre upon a roofed cage, so as to distribute the load. The Winifrede Coal Co. has an arrangement of this kind, with a maximum capacity of about 1300 tons in 12–14 hours, and costing about 5000–6000*l.*, including the structure for its protection. At the Faulkner Mines, 30 miles above Charleston, a regular basket-arrangement has been erected, at a cost of about 5000*l.*; and the Crescent Mines, 2 miles lower, have a

* W. N. Page, Tr. Am. Inst. Min. Engs.

similar arrangement, costing about 4000*l*. Neither of these tipples can transfer more than 400 tons per diem.

Since the best devised structures, upon such waters as the Ohio, are liable to be washed away, and become a total loss, it is clear that one of the first considerations should be economy in construction, and that as little resistance as the conditions will admit should be opposed to the current. Where breakwaters are used, they must be raised, to afford absolute protection, at least 50 ft. above low water. Such a structure, in stone, would be beyond the means of most coal operators; and in timber, they are not only expensive, but depreciate rapidly at and above the water-line. Bearing the above conditions in mind, and confining his remarks to the transfer of bituminous coal into barges, Page names the following *desiderata* in order of importance.

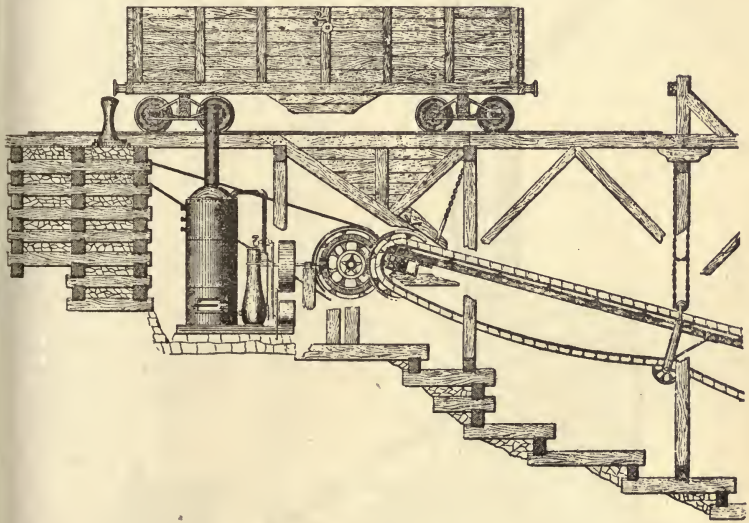

FIG. 62.—COAL CONVEYOR.

(1) The arrangement should permit a structure accommodating any car; and, since the majority of the mines, in the future, must reach the rivers over lines of railway too extensive for the economical use of small cars, the requirements of the standard railways should be met.

(2) All bituminous coals, being more or less damaged by breakage, should be handled as gently as possible. Since breakage occurs not only from the shocks and friction on the bottom and sides of a chute, but from the weight and grinding of the superincumbent mass when in motion; hence it is clear that any method by which the coal can be literally carried, while it remains at rest, will best meet this condition.

(3) The barge should be loaded uniformly; otherwise its timbers will spring, and leakage will become a source of constant expense.

The cost of a barge is too great to permit the neglect of any precaution for its preservation.

(4) The cost of transfer should be reduced to a minimum, and the machinery should not be so complicated for a large capacity, as to make a small output disproportionately expensive.

(5) The capacity should be practically unlimited, since gravitation furnishes unlimited power.

(6) Above all, the structure should be a protection in itself against high water, or subject to such damage only as may be quickly repaired at a small cost.

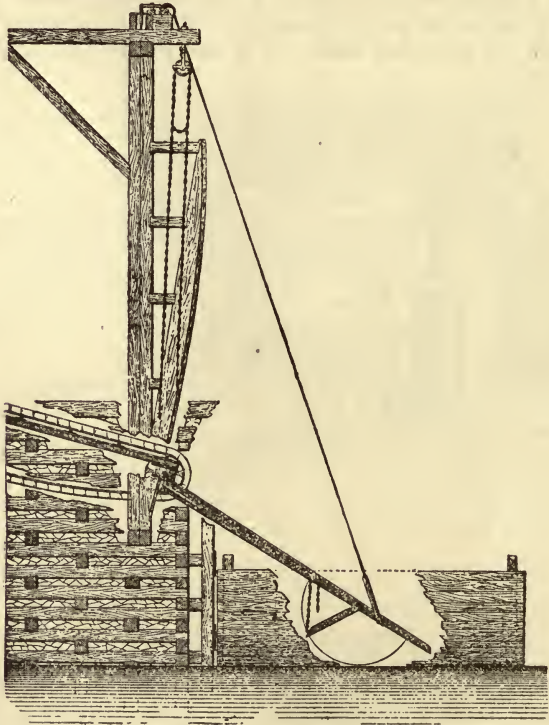

FIG. 63.—COAL CONVEYOR.

After a careful study of the conditions and requirements—which are of course slightly modified by circumstances—Page ventured to make a departure from the conservative methods now in use, and erected a transfer on the Kanawha, for the Mt. Carbon Company Limited, which is described below, and illustrated in Figs. 62 to 65.

As will be seen, it is a simple application of a flexible steel belt 4 ft. wide, with 6-in. flanges, and 95 ft. from centre to centre of sprocket-shafts. The 3 chains are made of $\frac{1}{2} \times 2$ in. steel bars, with $\frac{3}{4}$ -in. steel pins, 6 in. from centres. Each alternate link has a 2-in.

flange, to which is bolted a segment of the belt, as shown in Fig. 60; consequently every other link is an idler, which increases the flexibility of the belt. The segments are made of No. 12 gauge soft steel, and lap $\frac{3}{4}$ in. The lower lap is curved downwards, for which the idle link is notched.

The hopper underneath the car holds less than a ton; consequently the belt practically draws the coal direct from the car after this hopper has been once filled. The feed-apron is narrower than the belt, and is adjustable so as to feed automatically, the coal on the belt regulating the charge. No difficulty is encountered in regulating the feed to any desirable load; and no attendant is required. The links of the loaded chain run in small flanged rollers, placed every 4 ft. on 6-in. girders, 24 ft. long, with fish-joints at every point of suspension. There are 4 such points within the 95 ft., using eight 2-ton differential blocks, four on each side. It was first proposed to use counterweights at these points; but upon estimation blocks proved cheaper and more satisfactory.

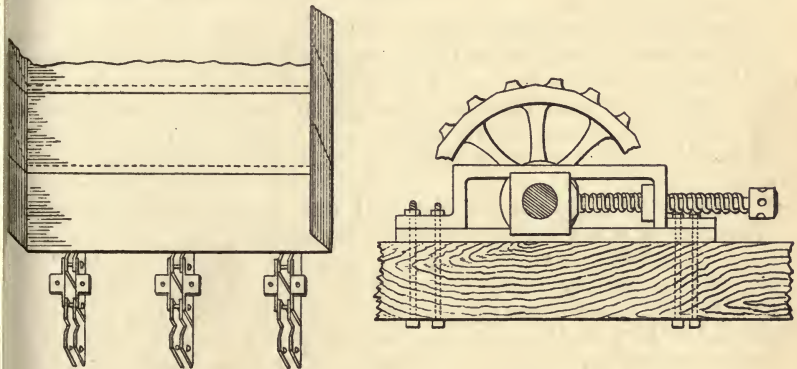

FIGS. 64, 65.—DETAILS OF COAL CONVEYOR.

The total weight of belt and attachments, exclusive of the upper, or fixed, shaft and sprockets, is 5 tons; and the level load is 5 tons; consequently each revolution of the belt conveys a little more than 10 tons. The arrangement for returning the empty portion of belt consists of 3 pulleys, 2 ft. diam. by 12 in. face, set on the shaft so that each pulley supports a chain. To suit the different stages of water, the entire system can be readily raised or lowered at one end, by one man, care being taken to have the girders in line when the proper elevation is reached. The guide on the movable end is an arc of the circle to which the belt is radius; though, to cover any inequalities, or spring in the timbers, the fixed ends of the girders are provided with movable connections to the main shaft, which is also provided with extension-boxes, to facilitate making the connections. The shute which distributes the load in the barge is built of light steel, arranged so as to convey the coal to both sides at the same time, the proportion delivered to either being regulated by the angle of inclination. It is adjusted so that the coal moves in it very slowly,

and has a minimum drop into the barge. When the sides have been fully loaded, the hinged apron is folded back, and the discharge falls in the centre of the barge, which is thus loaded so as to require little or no levelling.

It is apparent that the greatest inclination of the belt should not exceed the friction-angle of coal on iron; and that, within certain angles, gravity will revolve the belt, on the principle of an ordinary incline. Though Page put a brake-wheel on the main shaft, intending at the time to use gravity-power, he determined later to make use of a small 6 × 8-in. engine, which was on hand to operate a capstan for handling the barges. He connected the belt with it, and made the greatest angle of inclination only 15°. The belt is speeded to 100 ft. per minute—the engine making 150 rev.—and makes a complete revolution in a little less than 2 minutes. In actual practice, the belt empties a 12-ton car in 2 minutes, or at the rate of 360 tons per hour. This capacity can be increased, without additional expense, by simply increasing the speed of the belt, or, at a very small additional cost, by increasing its width.

As the belt has never been operated by gravity alone, it is not possible to say exactly what the factor of friction is, but doubtless it will revolve between the angles of 10° and 30°; in other words, it can be operated by gravity alone, through an arc of 20°; and with a radius of 95 ft. this arc would approximate a difference in elevation of 34 ft., which is more than ample to cover all loading-stages in the river.

The little engine mentioned will run the loaded belt without difficulty, in a horizontal position; consequently the total friction must be considerably less than the power of its cylinder, as it is geared (the gravity force exerted in direction of belt, at any angle, may be easily determined by the resolution of forces). The total cost of all the iron in the structure was under 500*l.*, excepting only the engine and boiler, which cost originally about 120*l.* To this must be added 100,000 ft. of white oak timber in the crib and trestle, which cost 400*l.* erected, and 120*l.* for stone filling, making the total cost, in working order, under 1150*l.*, including engine, capstan, and all gearing. The cost in timber and stone will, of course, vary according to conditions. It will be seen from the drawings that Page has used timbers lavishly, both in the wings of the crib and for the protection of the bank. The whole structure is so framed and drift-bolted together that no part can be moved independently of the other, including the stone crib, which extends back to the railway grade, 50 ft. above low water, and 10 ft. above the Chesapeake and Ohio Railway.

The distance between bents being 24 ft., little resistance is offered to the current (none of them is in the channel); and even should drift or ice gain a lodging, there is as much strength to withstand the pressure as is presented by an ordinary breakwater. The belt can be raised clear of water, up to a 40-ft. rise, and should this (the highest gauge yet recorded) be exceeded, it can be lowered in safety beneath the surface. As the crib is filled so that it cannot be undermined, the greatest damage which could possibly result would be the breaking of the bents, which are composed of 4 timbers of 12 × 12-in.

oak, each firmly bolted and braced to the stone crib and its two wing-walls. The belt would of course remain; and even such an improbable catastrophe would result in small damage.

In actual working, only 2 men are required to run this conveyor to its full capacity: an engineer, at 6s. per day, who also attends the capstan, and one man on the barge at 8s. per day, who is a carpenter and caulker; consequently the total cost per diem does not exceed 14s. The trainmen dump the cars; but if this expense be added it would amount to 10s. more. The tracks are arranged so that the loads run in, and empties out, on down grades.

In 3 months' working the cost of repairs was nothing; and since every member has a large bearing and safety factor, the wear and depreciation will be very slight. No breakwaters have been put in, nor is there need for any.

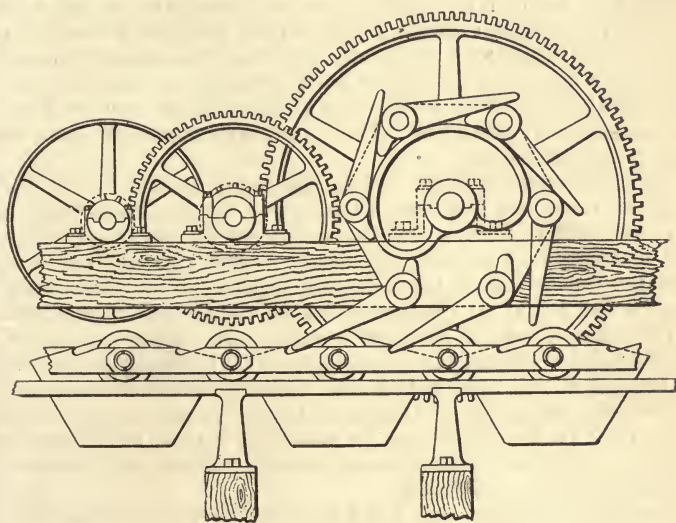

FIG. 66.—HUNT COAL CONDUCTOR.

Apart from the advantages already named, it has been clearly demonstrated that both coal and coke can be put into barges with half the breakage of any other arrangement; that there is nothing complicated to get out of order; that, as the barge sinks in proportion to the load, the belt has to be moved only for the different stages of water. Moreover, there is no danger to life or property from the breakage of any part, as is the case with the vertical system, in which frequently the breaking of a rope causes loss of life, barge and ear.

With self-dumping cars, Page would feel safe in guaranteeing to transfer 4000 tons with this machine, within 12 hours, at a cost per ton not exceeding $\frac{1}{10}d.$, and, with 200*l.* extra outlay, he would undertake to double this capacity, and lower the cost named.

As the mines of the Mt. Carbon Company are connected with the

river by 5 miles of standard-gauge railway, and their coal is screened at the mine-tipple, where they have 202 bee-hive ovens, no arrangement has been made to separate the nut and slack at the river. The vertical distance between the car and belt, however, could be easily utilised for screens; and the small coals could be conveyed to either side of the belt, where they could be carried by a trough and scraper connected to the main shafts, into separate barges, which might be arranged inside of the lump-receiver. Under favourable conditions the angle of inclination to these inside barges would be sufficient to slide the coal in fixed pipes, since breakage there need not be considered.

In Hunt's conveyor, instead of the usual sprocket wheels for effecting motion, pawls are used for pushing the chain along, a second pawl taking hold before its leader lets go. As shown in Fig. 66, a pocket is formed in each of the links of an endless chain, or the latter is fitted with 2 pins into which a pawl drops, and 6 or 7 more of these pawls are attached to a revolving disc, their movement to enter the link pockets being governed by a fixed cam, which turns them toward or allows them to drop away from the centre as may be required. The tracks upon which the wheels run are supported upon timber framing and brackets.

Wire Ropeways.—Hardly any of the many mechanical inventions of modern times has done more to develop the mining industry than the simple and ingenious contrivance known as the aerial wire ropeway; and certainly no particular form of wire ropeway has acquired a greater reputation or proved more successful in overcoming the obstacles incidental to transportation in rough and rugged country than that known as the Bleichert system. The home of this ropeway is in the United States, where, out of nearly 500 examples erected, not one has failed, and now it is being introduced into Europe and the British colonies by W. F. Dennis & Co., of London. By its valleys up to 1650 ft. in width can be spanned; rivers, buildings, roads, railways, and other obstacles are crossed without the necessity of erecting elaborate structures.

Gradients of 85 per cent. to 90 per cent. have been repeatedly and successfully worked; and ropeways have been constructed with a carrying capacity up to 1000 tons per day of 10 hours.

The lines are proof against strong winds, floods, snow, ice, &c., and unskilled labourers can perform all the necessary operations.

The automatic connection and disconnection of the trucks or buckets to and from the rope ensures the greatest possible simplicity of working. These trucks are designed to suit the materials that have to be carried, whatever the nature of such materials may be.

The "Bleichert" system consists of two parallel stationary wire ropes, called the "bearing ropes," anchored at one end and strained as required at the other end; thus a regular and certain stress is put upon the ropes. Along the line from terminal to terminal, these bearing ropes are supported by wood or iron standards of special improved construction. The ends of the two bearing ropes are connected by switches and steel shunt rails of a special shape, so that the buckets or cars are easily run off from one bearing rope

to the other at the terminals. Upon these fixed ropes the buckets or cars are suspended by two grooved wheels; while a hanger and another rope, the hauling rope, forming an endless band, working over horizontal pulleys fixed at the terminals, effects the movement of the buckets or cars along the bearing ropes. To the hauling rope the buckets are attached by one of two patent grip mechanisms. It may be here pointed out that this mechanism is the vital part of an aerial wire ropeway, and Bleicherts, after the experience of over 20 years in the design and construction of wire ropeways, have introduced and patented a roller friction grip for use on inclines up to 1 in 4, which automatically adjusts itself to the varying gradients of the track, thereby reducing the wear and tear on the rope to a minimum, and at the same time being a perfectly safe attachment. For use in very mountainous countries, with great spans and heavy gradients, the Bleichert patent lug grip is used; this is absolutely secure even upon gradients of 1 in 1, and on spans of 1650 ft.

If required, an automatic counting mechanism can be fitted to the ropeway, registering the number of loaded buckets transported; and further, by means of the Bleichert patent track scales, the loaded buckets can be weighed in a few seconds.

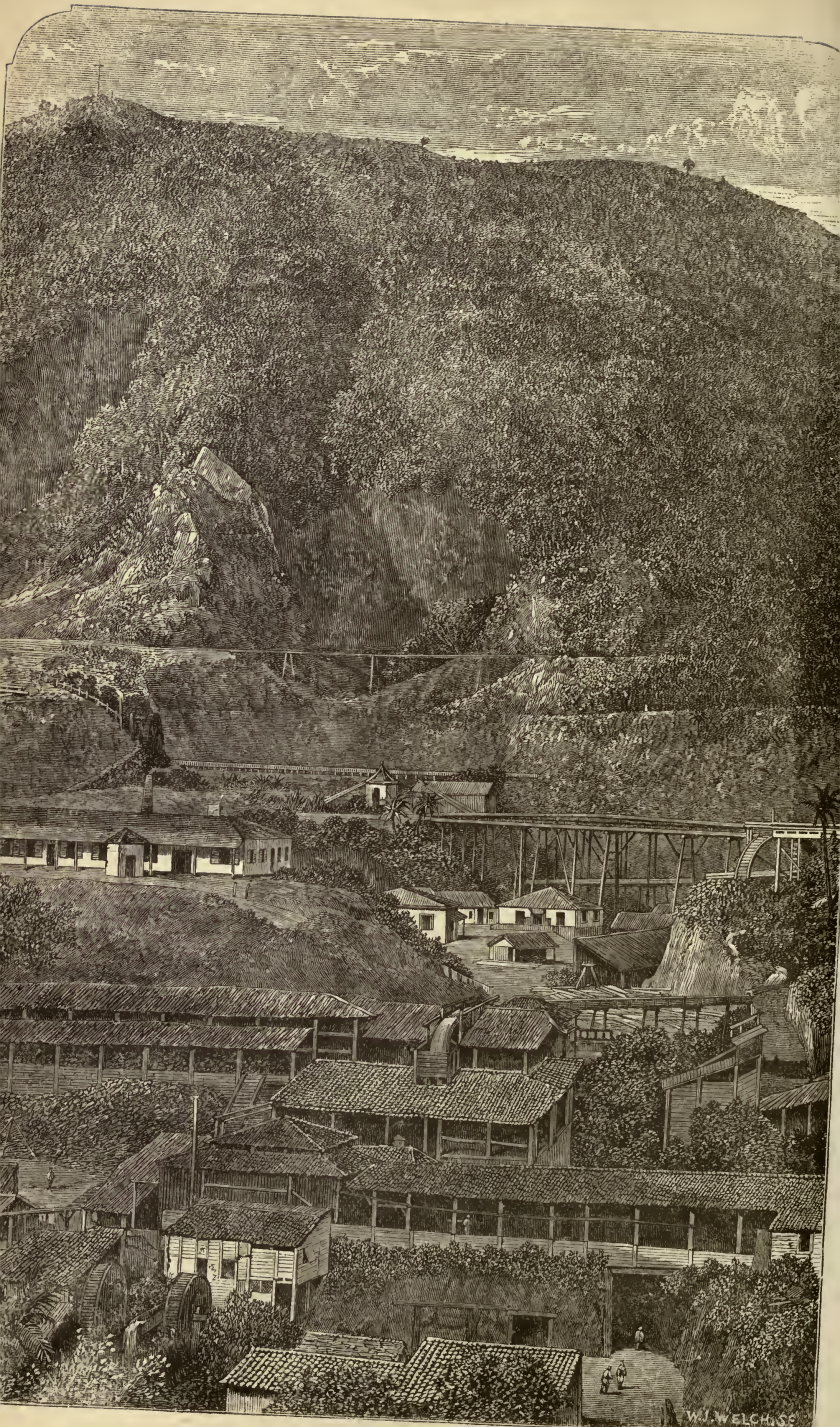

REDUCING.

VERY few mineral products as they come from the mine are in a fit state for commercial use, and in most instances the preliminary operation is one intended to effect their reduction in size. Obviously there will be great differences in the size desirable in various articles, but it may be taken as a leading economic principle in every case that crushing or grinding is an operation which can be best and most cheaply performed in stages, and that it is impossible with any hard substance to reduce it to a fine state in one single treatment, either so effectively or at so little cost as where the process is graduated. This remark seems unnecessary if only on common sense grounds, yet the persistent manner in which the principle of gradual reduction is overlooked warrants attention being called to it here. At every stage, too, screening is essential, so as to eliminate as quickly as possible all those particles which are sufficiently small, as not only do those particles occupy space uselessly, but they also form a cushion for the larger particles and reduce the crushing effect of the machine. Where power costs nothing, or next to nothing, these conditions may be to some extent neglected, especially if the labour entailed in attending to the screens, and the wear and tear of the screens themselves be excessive.

If the lumps of mineral are of an inconvenient size for tramping, they are first reduced by firing a charge of some explosive on them, and then by large hand hammers. The next step is the "crusher" or "rockbreaker," of which several forms are in use.

One of the best known is the Blake, with its many imitations. In this machine, at every revolution an eccentric on a shaft causes a movable jaw to advance about $\frac{1}{2}$ in. towards a stationary jaw. Thus lumps of mineral dropped between the jaws are broken by each succeeding bite, the fragments falling lower and getting broken again, until they are small enough to pass out at the bottom, the distance between the jaws at the bottom limiting the size of the fragments, which may be regulated at will. This crusher is made in sizes ranging from a machine having a mouth 10 in. by 8 in., and giving a product of 4 tons per hour, of a size suitable for fine pulverisers, up to one measuring 30 in. by 24 in. and turning out 23 tons an hour.

Another variety of jaw crusher differs in the motion being given to the crushing jaw from a crank-shaft, instead of an eccentric shaft.

In the Dodge crusher, the reciprocating jaw is pivoted at its lower end, so that the movement of the jaw is greatest at top and least at bottom, consequently the product is of more nearly uniform size and the size of the product being regulated by the distance the jaws are

set apart, a finer product is obtainable, though at the cost of a certain amount of capacity.

The principal objections to jaw-crushers are (a) that the jaw does effective work only during its forward stroke; (b) that thin flat pieces of rock may pass without being broken; (c) that the product is of varying and not uniform size.

Gyratory crushers, such as the Gates and the Comet, are a decided improvement so far as capacity is concerned, for, the motion being rotary, every portion of the stroke is effective. There is no grinding action. Gyratory machines are more costly and more complicated, besides requiring more power, but the output is disproportionately greater and the product is uniform.

The Coles crusher is so designed that each set of jaws has a very small amount of breaking or reduction to perform. It has two pairs of jaws, each pair receiving its motion from one vertical moving piece, as in ordinary machines, but the lower pair is arranged so as to make two strokes while the upper pair makes only one, by arranging toggles of different length. Assuming that a piece of rock entering the upper jaws is broken in two—it would in most cases be broken into more—then the lower jaw is supposed to be able to take the product from the upper jaw, and, with its short length and double frequency of stroke, to break that material and effectively give a uniform, or a more uniform, smaller product. Such a machine is proposed as being capable of performing something approaching twice the work of any ordinary stone-breaker, and it is suggested as a means of obtaining gradual reduction and enabling the machines that follow to receive material much more likely to meet their capacity.

The Schranz crusher is of interest as forming a link between the ordinary breaker and the crushing roll. The action of this machine resembles rolls rather than crushers. The movable jaw has a rocking motion, and its effective action is absolutely continuous instead of being intermittent. The opening of the outlet being constant, the product is uniform in size, and excellent work is done by this machine to a fineness of 8 mm. (say $\frac{1}{3}$ in.), at a rate of speed, figure of cost, and degree of wear and tear far surpassing rolls.

In the Lancaster crusher, the jaw is hung on a toggle or vibrating link above, and attached to the reciprocating arm below, producing a compound motion, with beneficial results as to quantity and uniformity of output. A simple mechanical arrangement of the driving gear permits double the number of reciprocations at a given speed as compared with eccentrics or cranks, and a lever gives control over the stroke of the jaw during operation.

The most remarkable development of the crusher principle is the Blake multiple-jaw machine which, in combination with an ordinary breaker, can be used in the reduction of any hard ore or mineral to almost any degree of fineness, and certainly so fine that all particles will pass a 30-mesh wire screen, though the economical limit of such a system of crushing will probably be found between 14- and 20-mesh.

In the construction of the multiple-jaw crusher, the main sliding or toggle jaw is replaced by main swinging, thus doing away with

the upward thrust on the tension rods and consequent wear. Experience has also shown that in machines of not over $\frac{1}{2}$ in. width of opening it is better to use several small machines with a series of jaw openings say 15 in. \times $\frac{1}{2}$ in., than a single large machine with a series of openings 24 in. \times $\frac{1}{2}$ in. or 36 in. \times $\frac{1}{2}$ in.

It is a necessary condition for most economic working that the material to be operated upon be sufficiently dry to screen readily, so as to take out the fines as rapidly as made, or it must be fed with such an excess of water as will ensure successful screening. Accumulations will mean diminished output or even actual stoppage.

The first mill built on this system was for the Chateaugay Company in 1882, and it crushed many thousand tons of tough magnetic

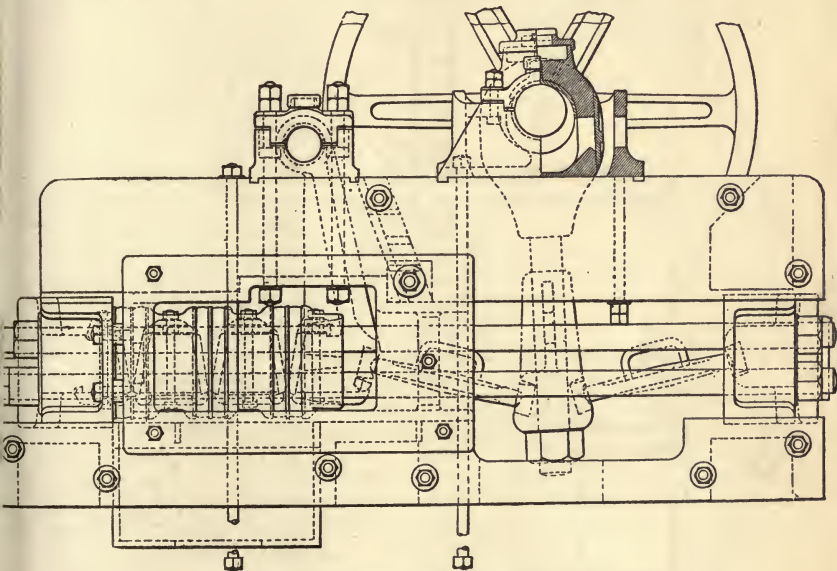

FIG. 67.—BLAKE MULTIPLE-JAW CRUSHER.

iron ore to pass a $\frac{1}{4}$ in. round screen. Another large installation was for the Haile gold mine, dealing with a tough, coarse quartzite. As at first arranged, the system consisted of one 20 in. \times 10 in. breaker, the product of that going to a 30 \times 5, product again being split and passed to parallel sets of 60 \times 2 multiples, each with three jaws, leaving at approximately $\frac{1}{4}$ -in. gauge, and going thence to rolls for reduction to 40 mesh. Fig. 67 illustrates a section of the 60 \times 2 multiple-jaw.

A second installation for the Chateaugay Company was erected in 1886, with a daily capacity of 600 tons from 15 in. down to $\frac{1}{4}$ in. A sectional elevation of this mill is shown in Fig. 68. The ore is brought to the mill by rail, in side-dumping cars, carrying on the average $7\frac{1}{2}$ to 8 tons each. The mill consists of two groups or systems of crushers, with elevating and screening appliances, each

group being an exact duplicate of the other, a "jack-pulley" on main-line shafting being placed centrally between them. Each group consists of the following crushers:—one 20×15 , crushing from 15 in.

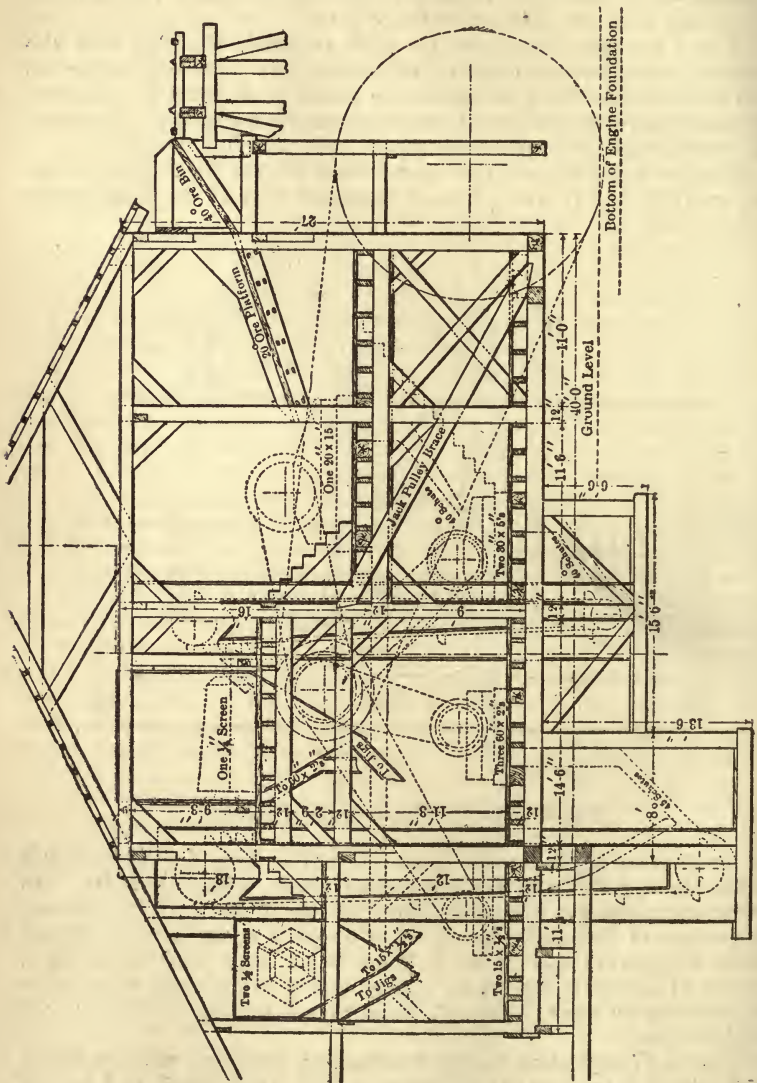

FIG. 68.—BLAKE MULTIPLE-JAW CRUSHER SYSTEM.

to 2 or $2\frac{1}{2}$ in. Product of each 20×15 is divided, going to two $30 \times 5s$. Product of $30 \times 5s$ is elevated and screened; that passing $\frac{1}{4}$ in. round hole is finished product, as far as crushing is concerned, and is carried to the jigs. The "coarse," $1\frac{1}{2}$ to $\frac{1}{4}$ in., goes to three

60 × 2 multiple-crushers, each with 3 jaw openings 20 × 2 in. Product of these is elevated and screened, formerly through holes $\frac{1}{4}$ in. diam., now through $\frac{5}{16}$ in. holes. That passing through the $\frac{5}{16}$ screen-holes goes to jigs; that going through $\frac{11}{16}$ in. holes goes to two 15 × $\frac{1}{2}$ fine-crushers. Each of the 15 × $\frac{1}{2}$ crushers has 7 jaw openings, each 15 × $\frac{1}{2}$ in. Material not passing $\frac{11}{16}$ in. holes, but going out the end of screen, goes back to the 60 × 2 multiple crushers. Product of 15 × $\frac{1}{2}$ fine-crushers is elevated and screened, material not passing $\frac{5}{16}$ in. holes returning to them. Each group of crushers has 3 jigs.

The actual quantity crushed from Sept. 1886 to January 1888 was 122,814 tons of 2240 lb., at a cost for crushing and concentration of 34.36 cents (1s. 5d.) per ton, distributed as follows:—

Fuel for power	7 cents or	3½d.
Labour.. .. .	17 "	8½d.
Oil, waste, &c.	2 "	1d.
Renewals and repairs	8 "	4d.
	—	—
Total	34 "	1s. 5d.

This economy is the more remarkable when it is considered that the ore instead of being reasonably dry for screening was often wet or frozen. With really dry ore, or with the adoption of efficient wet screening, the cost could doubtless be much reduced, in favourable instances perhaps to as low a figure as 1s. or 24 cents a ton. Accidental intrusion of foreign bodies such as gads and picks does not result in injury to the machine. Packing of all the jaws with damp fine stuff mixed with the coarse is a much more serious matter, which must be avoided by proper screening.

Ordinary Cornish rolls are a simple form of machine for crushing mineral after it has passed through a breaker and reducing it to perhaps 20 mesh. In their range of applicability and general qualities they compare with fine jaw-breakers, and there is not much to choose between these two classes under ordinary conditions. The substitution of steel springs or rubber buffers is a great improvement on the old weighted lever principle.

Where rolls are to be used at all, Krom's system is much to be preferred to the old Cornish pattern, the principal advantages being:— (a) That the crushing tyres are made of forged steel, and are firmly and simply secured to the shafts by cone-shaped heads; (b) that belt-pulleys are substituted for tooth gearing, enabling the rolls to be run at any desired speed, thereby increasing their capacity; (c) the adoption of swinging pillow-blocks; (d) that the crushing strain is taken up by bolts, mounting powerful springs; (e) that a special form of hopper spreads the ore evenly across the face of the rolls.

The chief point determining the value of rolls is whether the faces of the tyres wear evenly, and do not become grooved. The life of Krom's rolls is prolonged by their being, in general, arranged in double sets, one pair receiving bean-sized ore from the breakers, the other "finishing" or finely pulverising the screened coarser produce of the first pair. At the Bertrand Mill, Nevada, Krom's rolls are stated to crush 50 tons of hard quartzose ore in 12 hours, to pass

through a 16-mesh screen; while in the Mount Corry Mill, Nevada, 50 tons are reduced to 30-mesh in the same time; and the pulverising is so done as not to cause the production of an excessive quantity of "slimes." The very fine dust produced, in greater or smaller quantity, according to the character of the rock, may be separated by exhaustion with a fan.

The average speed of the rolls is 80 to 100 rev. per minute. Two sets of 26-in. rolls with faces 15 in. long give rather more effective crushing surface than 50 gravitation stamps, each 8 in. diam., falling at the rate of 90 drops a minute, the average diameter of the rolls being taken as only 24 in., so as to allow for their gradual wearing, while their speed is taken at 100 rev. a minute.

Krom's rolls were designed as dry-crushers. On the other hand, a small percentage of moisture will not prove a serious disadvantage, unless such slightly moist ore be argillaceous. An accident to any part of the machine causes a stoppage of the whole; but this defect is of less importance, because the whole operation is so graduated and regular that there is little room for accidents.

Krom rolls as made by Bowes Scott & Western, London, are much superior to the original pattern.

Though designed for dry crushing, and occupying the foremost position of any machine in the market for dry crushing to a fine mesh, these rolls are being largely used as wet crushers. In one instance, with copper ores not needing to be crushed very fine, six sets of rolls, each consisting of three pairs, are turning out 1000 tons a day, and working very satisfactorily; but any attempt to increase the fineness influenced the output largely. The rollers are removed immediately they show signs of wear from the last mill to the first of the series.

At a dressing-floor belonging to the Mosel-Lahn Company, at Trier, rolls are used to crush per hour 3 to 3½ tons of wet ore, from bean-size to pass 2 mm. (say $\frac{1}{12}$ in.) circular holes, without inconvenience so long as the rolls are kept clean by a jet of water. A way of reducing the drawbacks attendant on the uneven wear of the rolls, which must happen to a certain extent in every case, is to cast the rolls extra heavy in the first place and to fix a slide-rest to the frame, so that the face of the rolls can be turned whenever desirable without removing them at all.

A system of convex and concave rolls has been introduced by Bowers, for which it is claimed that there is a grinding action incidental to their form, and that they have no tendency to end thrust or wear against the collars.

Stamps consist of a series of heavy pestles, shod with iron or steel, arranged in "batteries" of 5 stamps each. These pestles are lifted by cams keyed on a horizontally revolving shaft, resting in bearings secured to the framework of the battery, and dropped in a certain order, e. g. 1, 4, 2, 5, 3, upon ore fed into a mortar box or coffer, and lying upon a false bottom of iron or steel dies. As the ore becomes sufficiently fine, it is ejected from the mortar through a grating or screen of perforated metal or wire cloth. The chief advantages of stamps are:—(a) Simplicity of working parts and tolerance of ill-

usage; (b) most repairs can be effected by an ordinary smith, and do not entail stoppage of a whole mill; (c) wearing parts are simple castings; (d) every millman understands them, or thinks he does. Against these advantages it must be said:—(a) that they require very costly foundations; (b) that they are not adapted to dry crushing though sometimes so employed; (c) that they turn out a very uneven product owing to the impossibility of ejecting each particle as soon as it is small enough; (d) which also means that much power is consumed in doing useless and for some purposes injurious work.

The effective capacity of a stamp battery depends upon many conditions, arising from the nature of the mineral and the operations which are to succeed the crushing, as well as from peculiarities of the battery itself. Chief among the latter are the nature of the blow (due to the weight of the stamp, the height it falls, its speed, whether it rotates or not), the rate and regularity of feed, the character of the wearing surfaces (shoes and dies), the gauge and inclination of the screens, and the supply of water for carrying out the "pulp" or crushed ore. The product of every mine may be said to possess special features demanding a certain combination of qualities in the stamp battery in order to give a maximum economy, yet it is very seldom thought worth while to experiment with an ore before erecting the battery, a stereotyped pattern being adopted without any thought.

To overcome some of the faults inherent in the ordinary falling or gravitation stamp various devices have been introduced. One of these, due to Harvey & Co., of Hayle, is a second cam shaft to hasten the blows of the stamps, by which they can be increased from 90 to 250 a minute. Automatic feeders are essential for good work, and must be adapted to the nature of the ore.

The so-called "steam-stamp" consists of a single stamp head worked by a direct-acting vertical engine—a steam hammer in fact—in a mortar having a discharge screen on all sides. Its capacity is great, where coarse crushing is all that is desired, but it compares very unfavourably with fine jaw-breakers even in this application; it is altogether unsuited for fine work, and notably increases the proportion of "slimes."

As the stamp is only effective at the moment of its fall, firstly in crushing the ore, and secondly in splashing the pulp over the screen, an obvious method of increasing its effectiveness is to multiply the number of drops per minute. One practical way of doing this is with the double cam, already alluded to; another is by providing an air-cushion to raise the stamp and drive it down; and a third is by attaching a steel spring. In Husband's stamp the rapidity of the blows is thus augmented. The stems of the stamps, usually a pair, work in pneumatic cylinders. Each cylinder is pierced with holes about $\frac{3}{8}$ in. diam., above and below the central position of the piston; so that when the piston momentarily occupies the mid-position, air at atmospheric pressure fills both ends of the cylinder. The cylinder, being coupled to the crank-shaft by connecting-rods, is raised by its rotation, the air in it below the piston is compressed, and the stamp is thereby pushed up. Similarly, the downward motion of the cylinder causes a compression of the air above the piston, which

urges the stamp down with greater velocity than it would have by virtue of its weight alone. This arrangement gives the stamp a fall several inches greater than that given by the crank. A contrivance may be added for rotating the stamps, so as to induce even wearing of shoes and dies. The effective capacity of a single Husband stamp is stated to be about 6 times as great as that of an ordinary gravitation stamp of the same weight, and under proper management their working generally is attended with satisfactory results. The air-cushions formed between the ends of the cylinders and the pistons, besides increasing the effective capacity of the stamps, reduce the jar on the machine. Other advantages are portability and small consumption of power. But it seems best suited for coarse and medium pulverising, owing to the difficulty attending the use of thin screens in machines of such large capacity.

A four-head battery of Husband stamps, working on hard tin ore at Tregurtha Downs mine, Cornwall, during 1889 stamped $28\frac{1}{2}$ tons a day per head including all stoppages, to pass a No. 36 grating, consuming $23\frac{1}{2}$ indicated h.p. per head, and costing $4\frac{1}{2}d.$ per ton for renewals and repairs. These figures are about six times as favourable as for gravitation stamps, to say nothing of the reduced size of building required, and lessened wear and tear. Punched metal screens last much better than wire cloth. Of course, the introduction of the air-cushion means an additional complication of the machine, which would be a disadvantage in some cases, as for instance where skilled labour was not procurable, or where low temperature would be likely to create trouble by formation of ice in the pneumatic cylinders. Much lubrication is also necessary, and may contaminate the product unless care be taken.

The peculiar principle of the Elephant stamp lies in the introduction of semicircular bow springs, compressed at their ends by helical springs, between the crank-shaft and the lever, which, receiving the force of the recoil from the blows of the stamps, store it up, and give it out at the next descent of the crank, effecting a certain saving of power. The springs also act as cushions, and take up a great part of the wear and tear of the machine. Two heads of Elephant stamps are stated to be capable of stamping 12 to 15 tons of hard quartz per 24 hours fine enough to pass wet through 30-mesh screens. They are considerably cheaper, lighter, and more easily transported and erected than ordinary stamps, and require less driving power for the same effective capacity; being less simple they run greater risk of injury, and are by no means so easy to repair, while the lateral wear on the top, caused by the levers carrying the heads, is excessive, and that of the heads themselves is uneven.

It is very interesting to note that while engineers generally point with pride to the increased capacity gained by the introduction of circular rotating stamps, the most recent development in Germany, where stamp-batteries were invented, is a stamp-head rectangular in section. These are placed in batteries of 11 instead of 5, occupying only the same space by reason of their being closer together—less than $\frac{1}{2}$ in. apart—and this arrangement is said to have given very good and economical results for fine crushing.

Among edge-runner mills, the most familiar and widely used is the simple yet cumbersome Chili mill, of which it may be said that no machine has a better record in practice, though it is the fashion to despise it by reason of its rudeness. Properly used, the Chili mill is a most useful machine. It is urged against it: (a) that the runners are so bulky and heavy that they cannot be transported up country; (b) that the material being crushed is apt to run away in front of the runner; (c) that a reduction to impalpable powder results rather than a granular comminution; (d) that much power is wasted by reason of the excessive friction at the end collars of the spindles owing to the centrifugal motion of the runners.

Against all these indictments it will be sufficient to quote one example of the highly successful introduction of a Chili mill (by

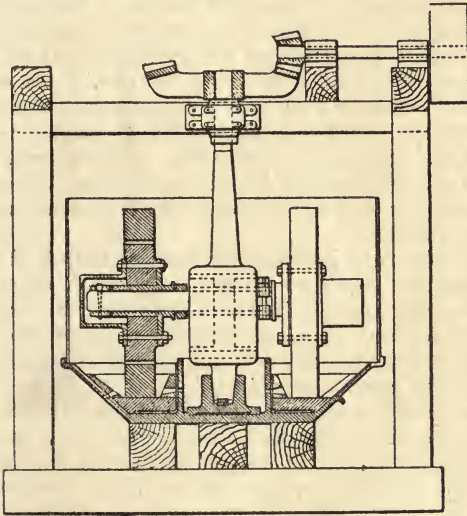

FIG. 69.—CHILI MILL.

Blake of New Haven) into a works for reducing very hard mineral from $\frac{1}{4}$ in. till it would pass a 40-mesh screen. Each runner of the mill, as shown in cross-section in Fig. 69, weighed about a ton and measured 4 ft. diam. and 8 in. across the face, the distance between outsides being 4 ft. 2 in. The central spindle carrying horizontal axis on which the runners revolved, made 40 rev. a minute. The tyres of the runners were of hard white iron 8 in. thick; and the bed of the pan carried segmental dies of best chilled iron, and was surrounded by an enclosure of sheet iron 4 ft. high to retain the splashes of ore and water. The crushed ore was discharged from the pan by a current of water on to the inner periphery of revolving screens of 40-mesh, quite separate from the mill. The output reckoned on thousands of tons was at the rate of $3\frac{3}{4}$ tons of the hardest and toughest quartzite per hour per mill, at a cost for power far less than by rolls. For 3000 tons, the wear on the runners was $\frac{1}{4}$ in., and on the

segmental dies $\frac{1}{4}$ to $\frac{3}{8}$ in., the total amount being equal to .12 lb. of iron per ton of ore.

An excellent form of Chili mill is made by the Humboldt Engineering Works, of Kalk, near Cologne, containing some improvements of their own introduction. One of the most important of these is that the runners are carried on cranked axles, which pivot in bearings on the head of the vertical shaft, so that each runner can rise independently of the other, remaining at the same time perpendicular. In the older patterns the runners are carried on a common axle, dependent on each other, and as it does not often happen that they are passing over stones of equal size, they are the greater part of the time inclined from the vertical. A funnel rotates with the vertical shaft and feeds the material equally, while a scraper continually spreads the material; the capacity of the mill has been thereby considerably increased, as compared with the older pattern. The cast-iron runners have renewable chilled iron tyres; the grinding bed of the pan also consists of a renewable chilled iron ring, in two, three, or four parts, according to size. Chilled iron lasts longer than cast steel. To avoid as much as possible the diffusion of dust which occurs in dry grinding most materials, the runners have a casing of sheet iron, through the top of which only the feeding hopper protrudes; these casings are made in two parts for ease of removal, and are further provided with tightly closing doors.

The Bryan roller mill is a modification of the Chili without any obvious superiority. Neate's "dynamic grinder" appears to differ chiefly in having the runners inclined inwards until the centrifugal force, at the predetermined speed, exactly balances the tendency to fall inwards, thus relieving the end collars. This machine has given great satisfaction in cement-grinding.

Another development of the roller mill is the Schranz fine-crusher, employed at Lauremburg, on the Lahn, for reducing the mixed products from the fine jigs. This mill consists of a revolving pan and 3 conical rollers. The rolls revolve on spindles fixed radially at an angle to each other of 120° . The inner ends of the spindles are rigidly fixed. The outer ends move in a frame, and are capable of being pressed down by means of set-screws and rubber buffers on to the revolving pan, or annular crushing ring. As the pan revolves, the rolls are driven by frictional contact, the fact that they are conical preventing any grinding action and consequent production of slimes. The ore, which has been reduced in a rocking crusher, is passed successively beneath each of the 3 rolls, under increasing pressure, and on escaping from the third is washed into a launder for further treatment.

The Huntington mill has gained a prominent position as a competitor with stamps in wet-crushing gold ores. It consists of a series of circular pestles hung by yokes so as to revolve inside a casing, the centrifugal action bringing them into close contact with a circular steel ring-die, and the ore being pulverised by being thrown into the path of the rollers. For soft or argillaceous material the machine does well, but its success with really hard ores is very doubtful, and in any case it demands skilled attendance. Though much more

quickly and cheaply erected than stamps, and consuming less power in working, the Huntington mill is more liable to injury and more inaccessible for repairs, besides doing less work, and being much more difficult to feed. Its true sphere seems to be in fine-grinding for finishing an already ground material, as the abundant area available for screens provides a rapid discharge. Highly sulphuretted ores will not issue.

Recent years have witnessed the introduction of a number of reducing machines depending on the action of a revolving ball or series of balls.

One of the earliest to claim attention was the Globe mill, since modified and renamed the Cyclops. In this a single free ball of hard metal is carried round in a vertical plane by frictional contact with a pair of flexible discs fitted on a horizontally revolving shaft, the grinding being done between the ball and a grooved circular path. This machine has considerable capacity, but it is heavy and complicated, and much power is wasted in raising the ball during half of each revolution, entailing also uneven wear.

Jordan's fine-reducer is on a much better principle, a revolving pan carrying 3 large white iron balls, while the centre of the pan is domed and fitted with screens, over which the pulp is constantly washed, and can thus readily escape as soon as it is fine enough, avoiding that perpetual grinding and regrinding which is such a glaring fault in most machines. Excellent work has been done by the Jordan pulveriser in reducing hard mineral to pass through an 80-mesh screen.

The Crawford mill is a rotating pan carrying a series of 8 small balls, and is remarkable for dispensing entirely with screens and relying upon a current of water for overcoming the specific gravity of the mineral and floating it away as soon as fine enough. For operations on a limited scale this seems to be a useful little machine, simple, compact, self-contained, cheap, and easily erected and set to work. It operates efficiently down to 120 mesh, which few other machines can do.

A multiple ball mill made at the Gruson works, Magdeburg, and favoured in Germany for dry crushing, depends partly upon a stamping action, the balls being picked up and dropped during each rotation. The power required is small, and the output is relatively large, but the wear and tear of the crushing surface is excessive. The machine has been used chiefly on cement clinker and basic slag.

Probably the best form of ball mill using a number of balls is that made by the Humboldt Engineering Works, in which the screening appliances and the arrangements for renewing the most rapidly wearing parts are greatly improved.

Quite a number of so-called "pneumatic pulverisers" have been introduced of late years, in which currents of air are supposed to charge themselves with the material to be pulverised, and bring about mutual comminution of the particles by attrition among themselves. These machines display great ingenuity, but consume much power for a small capacity of work, and, the "attrition" being impartially distributed, the wear and tear on the interior of the machines

is excessive. They may have a useful sphere with substances of only moderate hardness.

One of the principal economic features of all reducing machinery must necessarily be the durability of the wearing surfaces, and apart from considerations determined by the special needs of the minerals under treatment, the manufacturer should be guided by this circumstance in his choice of the metal, alloy, or other substance composing the actual grinding surfaces. In the United States, chrome steel has largely come into use for stamp-shoes, and in this country Hadfield have adopted manganese steel with great success in rolls, crusher-jaws, and stamp castings.

Experiments made at the Robinson mill, Johannesburg, in 1892 showed that chrome steel shoes and dies lasted on the average about 30 to 35 days longer than Fraser & Chalmers' Bessemer steel, or Sandycroft forged steel, when crushing about 5 tons per head per 24 hours.

Another part of the mill, whatever its kind, which has to withstand excessive wear and tear, is the screen or grating through which the pulverised material must pass. These are either of punched metal or of wire cloth, and as much delay is caused in replacing worn screens, it is essential to have the best quality procurable and of suitable kind. An excellent article is turned out by Greening, of Warrington, Lancashire.

CONCENTRATING.

THE object of concentrating ores is to separate the useful from the useless portions, and to sort the valuable minerals from each other. It should be carried out as near the mine as possible, to avoid carriage of worthless material. Water is essential, and dressing-floors should be arranged so that the matters can be moved forward in a measure by their own specific gravity, otherwise extra cost will be incurred for elevating.

The specific gravities of minerals commonly met with are as follows:—

Gold (always containing some silver)	12·7-19·3	Magnetite	4·8-5·2
Mercury	10·6	Stibnite	4·6
Silver	10·5	Barytes	4·3-4·7
Copper	8·4-9	Copper pyrites	4·1-4·3
Iron	7·5	Zincblende	4·1
Galena	7·5	Chalybite	3·6-3·9
Cassiterite	6·4-7·1	Calamine	3·3-3·6
Cinnabar	6·7-8·2	Fluorspar	3·1
Mispickel	6·0-6·2	Calcite	2·6-3·0
Proustite	5·5	Felspar	2·5-2·9
Iron pyrites	4·8-5·2	Quartz	2·5-2·7
Fahlerz	5·0-5·1	Gypsum	2·2-2·4
Purple copper ore ..	4·9-5·1	Coal	1·2-1·5
		Lignite	1·2-1·4

Decomposed silver and other ores are difficult to dress, especially if easily powdered, e. g. malachite, argentiferous cerussite, cinnabar, and spangles of native silver. It is difficult to separate zincblende, copper pyrites, iron pyrites, mispickel, and barytes from silver ores; wolfram from tin ores; chlorite and epidote from copper ores; and chalybite from copper pyrites and galena.

The following minerals are affected by the association of those in brackets:—

Hæmatite, limonite, and chalybite (iron and copper pyrites and apatite are injurious).

Cassiterite (iron pyrites, copper pyrites, mispickel, and zincblende are injurious; bismuth makes the colour dull; copper makes it brittle).

Lead (arsenic makes it brittle; antimony makes it hard; fluor-spar promotes its fusibility; chalybite and barytes are also advantageous).

Zinc (lead spoils it).

Copper (lead must be separated from it if the copper is to be treated by precipitation process.)

Silver (lead and antimony are injurious for the amalgamation process; also talc for chlorination.)

Cobalt (for blue paint: calcespar, brownspars, manganese spar, hornstone, ferruginous quartz, and galena are injurious; nickel, when predominant, imparts a red tinge; arsenic intensifies the blue colour, and renders it more agreeable).

Magnetite (mica, lime, garnet, augite, and hornblende promote its fusibility).

Auriferous pyrites (for chlorination process, talc and tellurides are injurious).

When pieces of different minerals of the same size are allowed to settle in water, the heavier particles fall first. When pieces of different minerals of the same weight are subjected to a flow of water sufficient to move them along, the specifically lighter material, having a larger surface exposed, is washed away quickest.

Jigs.—The process of “jigging” or “hutching” is resorted to chiefly in the dressing of minerals in fragments of comparatively large grain, such for instance as are delivered by jaw-crushers. The charge of ore is placed in a sieve or frame having a bottom of wire gauze or perforated metal plate, where it is subjected to a series of small lifts or jerks in rapid succession from water being forced upwards, by which means the lighter earthy fragments are gradually collected at the top, while the clean ore accumulates on the bottom. The jigging motion is produced either by jerking the sieve up and down in a cistern of water, or by forcing water up through the bottom by means of a piston. In its crudest form, the operation is intermittent, being suspended during charging and discharging, but it may easily be made continuous.

Within its proper sphere no substitute for the jig has been found that does the work as well or as cheaply. Its capacity is large, it requires but little attention, and the losses of ore are small. In one form or another, it is the principal machine used in the concentration of low-grade ores, and for the separation of one metallic mineral from another; and it is almost the only machine used for the purification of coal.

There are two recognised systems of jigging, the English and the Continental or German. The English system is a development of the hand-jigging formerly employed in Cornwall and other metaliferous districts of England. In this method the crushed ore, coarse and fine together, is first jigged on a hand-sieve with coarse mesh; and the fine stuff, somewhat concentrated by passing through the bed of coarse mineral-grains on the sieve, is again jigged on a sieve of finer mesh. In the adaptation of the system to machine-jigging, many modifications of detail have been necessary. The general treatment, however, is the same, and includes a preliminary jigging on roughing-jigs, followed by a concentration of the hutchwork on finishing-jigs of finer mesh. In both roughing- and finishing-jigs, a bed of mineral is maintained on the sieve, and the concentration is mainly effected by jigging through this bed. The Continental or German system starts with a size-classification by screens, after which the different sizes are treated on separate jigs.

There are also combinations of the two systems. The use of a bed of mineral-grains, and concentration by jiggging through the sieve, has been adopted in Continental practice for fine jiggging. At the Lake Superior dressing-works, a somewhat imperfect size-classification by water has been introduced as a preliminary to jiggging. In the Continental dressing-works, again, the tendency of late years has been to reduce the number of sizes jiggged, and to abandon the very close sizing which formerly characterised the method.

The arguments for close sizing are drawn from the well-known laws governing the fall of bodies in water, which may be stated as follows:—A body falling in still water moves at first with accelerated velocity, as in a vacuum. The resistance of the water, however, increases with the square of the velocity, and finally equalises and neutralises the accelerating force. Thereafter the grains move with uniform falling velocity.

It is argued that, in order to effect a separation by the water-currents of a jig, the range of size in the grains treated must not exceed the size-ratio of equal-falling grains. But the conditions which obtain in jiggging are not the same as in the case of bodies falling freely in water. We have to deal not with single isolated grains, but with numbers of these grains moving together. The smaller grains move in the interspaces between the large grains, and, consequently, in constricted channels. The large grains, also, so far as their movements are independent of the surrounding grains, as in the separation of gangue from ore, and of one mineral from another, move in the interstitial channels between the other grains. These channels must have great influence on the movement of the grains. Nevertheless many have been content to assume the formula for free-falling grains as of universal application, and have drawn therefrom the arguments and data for the close and accurate sizing characterising the Continental system of ore-dressing. It is, however, possible to effect a very satisfactory separation on jigs, with material sized between wide limits only, and in a very imperfect manner, or even entirely without sizing.

The principal advantage of the English method of jiggging is that it dispenses with the operation of sizing by screens. The plant is thus simpler and cheaper, and the expense of treatment is less. If the jiggging be conducted entirely without size-classification, it has the further advantage that very fine material can be treated successfully on jigs, which would otherwise have to be treated on tables. The bulk of the gangue, both fine and coarse, is thus at once separated by the "roughing-jigs," leaving but a small amount of rich stuff to be treated on the finishing-jigs and tables. As the treatment of the fine stuff by itself is troublesome, and the capacity of slime-jigs and tables is small, the plant and method of treatment are still further simplified and cheapened.

The English method is especially well suited to the concentration of low-grade ores on a large scale.

The principal objection in practice to the English system of jiggging is the imperfect concentration of the material passing through the jig-bed. The hutchwork is much richer when the stuff is sized

before jiggling. This difficulty is overcome by the re-treatment of this hutchwork on finishing-jigs. At Bonne Terre, the hutchwork is classified in pointed boxes, the sands are re-treated on jigs, and the slimes are concentrated on side-bump tables.

Munroe's investigations suggest means whereby the hutchwork can be enriched without the necessity for this second treatment. By treatment of fine and coarse material together on the same jig, interstitial channels will be formed between the coarse grains, in which the fine stuff can be very perfectly concentrated. Again, by decreasing the mesh of the jig-sieve, the size of the interstitial channels may be reduced, and still finer material be successfully concentrated. Experiments made to test the possibility of reducing the number of grades of sand, developed the unexpected result that the hutchwork was much improved by jiggling coarse and fine stuff together, the reason for which is now clear. So also at Bonne Terre, where, however, the problem is complicated by the necessity of running the roughing-jigs so as to suck as much fine stuff through the sieve as possible.

The problem to be solved in connection with the English method of jiggling is to determine the best method of treating the stuff too fine to be concentrated successfully in the interstitial channels of the jig-bed.

The first and most obvious method is to separate the fine stuff by water-classification before jiggling the sands. The objections to this course are, first, the quantity of water required to effect the separation of the slime; and, second, the fact that much fine stuff will be sent to the tables that could be treated successfully on the jigs.

A second plan is to separate the fine stuff from the tailings of the jigs by proper classifiers. This is perfectly feasible, and has the advantage that the jigs can be so run as to produce a rich hutchwork. This plan requires large settling-tanks, and a considerable amount of clean water to effect the separation of the slime. It has the advantage over the plan of separating before jiggling that the fine mineral is partly concentrated and saved by the jigs.

A third plan, which will effect a partial solution of the problem, is to run the jigs so as to take full advantage of the interstitial action. By reducing the mesh of the jig-sieve, finer material can be concentrated. With a given maximum size for the coarse sand-grains, however, a limit will be found beyond which the mesh of the sieve cannot be reduced. Possibly it may be found practicable to use a three or four-sieved jig, with different mesh on each sieve, and, by varying the stroke of the pistons, to adapt each sieve to the saving of a certain grade of sand. At Lake Superior the tail-sieves have finer mesh than the head-sieves. Or the roughing-jigs may be run with little under-water, so as to suck all, or nearly all, of the fine stuff through, thus ensuring poor tailings, and the hutchwork may then be treated again on jigs of finer mesh. These finer jigs should be run in the same way, and their hutchwork should be treated on tables.

By one or another of the above methods, it may be found practicable to save and treat the slime without using classifiers to separate it from the sands.

A fourth plan is to conduct the crushing so as to produce a

minimum amount of slime; for example, by a system of gradual crushing, using two or more sets of rolls; or by coarse-crushing, followed by jigging and fine-crushing of "raggings" only; or, again, by calcining the ore so as to make it more friable. By one or another of these methods it may be possible to limit the production of fine stuff, so that in many cases it may be allowed to escape without serious loss.

The following are the main points developed by Munroe's investigations:—

1. Bodies falling through water in a tube do not attain as high a velocity as in falling through the same medium in large vessels.

2. The falling velocity is but little affected when the diameter of the body is less than $\frac{1}{10}$ that of the tube.

3. The falling velocity is the more retarded as the diameter of the body approximates that of the tube.

4. A sphere $\frac{4}{10}$ the size of the tube will develop the greatest falling velocity, and will require a current of maximum velocity to support or raise it.

5. Grains falling *en masse* are really moving in confined channels, and follow the law of the movement of bodies in tubes. The falling velocity, and the velocity of the current necessary to support or raise the mass of grains, increase and diminish with the distance apart of the grains.

6. The diameter of the channel in which the single grain moves equals the cube root of the volume of the grain with its proportion of the interstitial space, or, in other words, the cube root of the space occupied by the grain.

7. In a mass of grains of different sizes, the large grains move relatively in smaller channels than the small grains. The ratio of the diameters of equal-falling grains of quartz and galena, under such conditions, is 31 to 1, instead of 4 to 1, which latter ratio holds good for free-falling grains only.

8. The formulæ for grains moving in tubes, when applied as above to grains moving *en masse*, enable us to compute the velocity of jig-currents, and thus determine the proper length and number of strokes of the jig-piston. The old formulæ gave results many times too large.

9. Close sizing is not necessary for the separation of different minerals by jigging, unless the difference in specific gravity is small.

10. Downward currents are apparently necessary to success in jigging through a bed. This requires confirmation by experiments on a larger scale.

11. Very fine material, less than $\frac{1}{10}$ mm. diam., can be treated successfully on jigs, if treated with coarse stuff, the concentration taking place in the small interstitial channels between the grains forming the mineral bed. For the treatment of fine stuff on jigs, close sizing is a positive disadvantage. Jigs work well on mixed stuff, and very badly on fine stuff alone. Stuff less than $\frac{4}{10}$ the size of the smallest interstitial channels cannot be treated successfully in this way.

12. The size of the mesh of the jig-sieve has a very important influence, and must be proportioned to the work to be done.

In the common hand-lever Cornish jig, the sieve is rectangular; to each of the short sides is attached a vertical iron bar, perforated at the upper end with 3 long holes, through which a pair of bolts are passed, linking them to the parallel arms of an oscillating frame. By altering the holes through which the suspension bolts pass, the sieve is made to hang at a greater or less depth in the rectangular water cistern or hutch in which it is worked. The suspension frame is an unequal-armed lever; the sieve is attached to the shorter side, while the longer arm is terminated by a slotted part, in which works a T-headed fixed link or connecting rod attached to the shorter arm of a second lever placed below it. The motive power is supplied by a boy, who jerks the longer arm of the second lever, moving it through a height of 48 in., while the sieve is only moved through 8 in. Clean

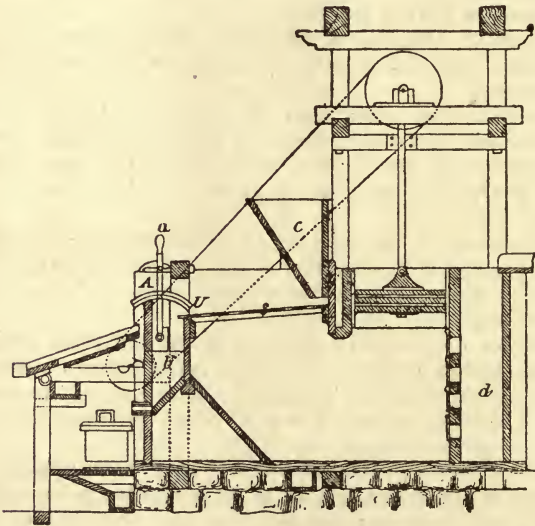

FIG. 70.—RITTINGER'S JIG.

water is introduced through a pipe on one side of the cistern to replace the muddy waste which is carried off through a similar pipe fitted with discharging apertures at different depths on the opposite side. The sieve is emptied by scraping out the contents, which are usually classified into three parts, the uppermost being thrown away; the middle, containing mixed ore with earthy matter, requires further treatment, while the bottom is clean ore. The hutch work or fine stuff passing through the sieve collects in the cistern, and is subsequently treated on the round buddle or some other slime-washing machine.

Rittinger's jig, Fig. 70, is characterised by the inclination of the grates and the lowness of the front partition, over which the poor and lighter stuff falls continuously, and with very little water, while the heavier and rich portions fall through the opening or slit, at the

base of the partition. This partition is the segment of a cylinder, and is supported upon the lever or arm *a*, so as to be movable backward and forward in such a manner that the slit may be increased or diminished at pleasure. The heavy stuff, passing through the opening, falls into the box *b*, from which it is removed as required. The inclination of the grate in this machine is 5° – 8° . It is fed through the hopper *c*, which plunges below the surface of the stuff accumulated on the grate. The loss of water which occurs at each stroke of the piston is replaced from a reservoir *d* at the back of the apparatus. According to Rittinger, experience has shown that the duty of self-acting machines of this kind is generally three times as great as that from the ordinary intermittent working apparatus.

The peculiarity of the Frongoch jig (Figs. 71, 72), as described by Prof. Le Neve Foster, is that the piston is vertical, and works in the partition between two tubs or hutches; *c* is the middle partition, and *d* is the piston working between two plates of iron *e*. The piston occupies the whole length of the jig, as shown by *f*, and is worked by the rod *g*, guided at *h*, and passing through a stuffing-box *i*. The

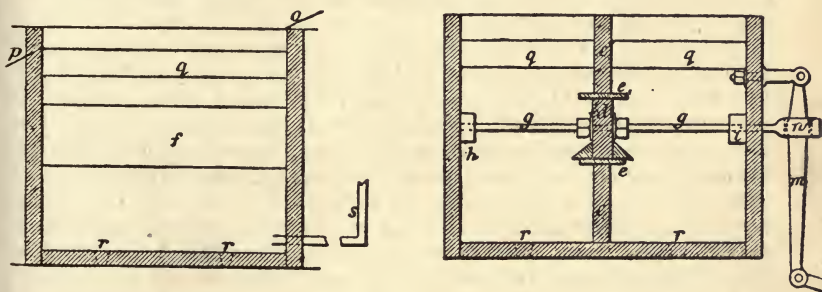

FIGS. 71, 72.—FRONGOCH JIG.

reciprocating motion is given by a crank through the connecting rod *l* and lever *m*, which traverses the head of the piston-rod *n*. The crank has a long loop, which enables the stroke to be varied. The same end can be attained by an eccentric with a slot, which allows the eccentricity to be altered at pleasure. *o* shows where the ore is fed on, and *p* is the place of discharge of the waste or impoverished ore. *q* is the sieve, and *r* are holes with plugs manipulated by handles (not shown) by which the concentrates that pass through the sieve are drawn off. *s* is the pipe bringing in fresh water. These machines are doing good work with ores containing blende and galena at Frongoch, and have been favourably spoken of for the treatment of tin ore.

Many other forms of jig will be found described at length in the author's 'Mining and Ore-dressing Machinery.'

Pyramidal Troughs.—Pyramidal separators, like so many other apparatus used in mining and metallurgy, originated in Germany, and are often known by the German name of *Spitzkästen*. They are hollow, generally rectangular, pyramids, constructed of strong boards,

well joined together (strong sheet-iron may be employed also). The sides are inclined at angles of not less than 50° , and there is a small hole in one side close to the apex. They are fixed horizontally, in an inverted position, and the crushed material is introduced at one of the narrow sides, a few inches below the top, by means of a launder. The result is that, as soon as the box is filled, a certain portion of the crushed matter—i. e. the coarsest and heaviest, which the water, on account of its diminished velocity, is not able to carry farther—sinks and slides down the inclined sides of the pyramid, and escapes through a small hole near the apex, whilst the finer and lighter matter passes off at the top by an outlet *a* in the centre of the side, opposite to the point of entrance. If now a second larger box be attached to the first, a third still larger to the second, and so on—each succeeding box at a slightly lower level, in order to prevent any settlement of stuff in the passage-ways—it follows not only that the same process of settling and escaping of the particles from the apex will take place in every box, but also that their size will decrease nearly in inverse proportion as the surface of a succeeding box is larger than that of the preceding one, or directly as the velocity of the water is diminished in it.

According to this principle, if the boxes were made of only very gradually increasing size, and the apex holes proportionately small, it would be possible to classify the stuff into a great number of portions, different in size of grain, before it had entirely settled, i. e. till clear water passed off from the last box. Experience has, however, shown, that for fine ore-dressing in general, classification into 4 different sizes by an apparatus of 4 boxes is quite sufficient. The sizes of the different boxes, in order to ensure the most perfect classification, depend both on the amount of material which has to pass through them per second, and the size and character of the grains; and it has been found, that for the supply of every cubic foot of material, the width of the first or smallest box must be $\frac{1}{10}$ ft.—i. e. for instance, for 20 cub. ft., 2 ft.—and for every succeeding box it ought to be about double that of the preceding one, or, generally, the widths of the boxes must increase nearly in geometrical progression, 2 : 4 : 8, &c., and their lengths in an arithmetical one, 3, 6, 9, &c.

Their depths depend on the angle of inclination of the sides, which, as already stated, is generally 50° , because if less, the stuff would be liable to settle firmly and choke the central orifice, and if larger, unnecessarily great height of the boxes would be required. The form of the two smaller boxes is commonly such that the two short sides are inclined at the above angle, and the two long ones, which would become far steeper, are broken—i. e. are for a certain depth from the top vertical, and afterwards inclined at the normal angle. This modification has, however, no influence upon the action of the boxes, but simply facilitates somewhat their construction and firm fixing. The sides of the larger boxes are generally even throughout.

The way in which the apex-holes are constructed has an important bearing on the operation of the boxes. At these points, the hydrostatic pressure is considerable, and the holes should naturally

be kept small, in order to prevent too much water passing with the particles of stuff; such small outlets are, however, especially in the treatment of coarser material, very liable to become choked. This difficulty has been met by the holes being made of conveniently large size, but connected with pipes $\frac{3}{4}$ in. diam., which rise up the side of the boxes, that of the smallest box to within $3-3\frac{1}{2}$ ft., and of others to within $2-2\frac{1}{2}$ ft. from the top, and are there furnished with small mouthpieces supplied with taps for regulating the outflow. This arrangement, on account of the outlets being so much higher, has the further advantage that a considerable amount of fall is gained (especially as regards the large boxes), which for the subsequent treatment of the material, is in some cases of special value.

Two more points require attention, to ensure good action of the apparatus, namely, the introduction of the material into the different boxes equally and without splashing, and prevention of the entrance of chips of wood, gravel, or other impurities that are likely to stop or obstruct the outlets. The first point is met either by having the supply-launder expanded fan-like and furnished with dividing-ledges, or by the interposition of small troughs, the sides of which nearest the box to be supplied are perforated near the bottom by equidistant small holes. The cleaning of the material, previous to its entering the first box, is generally effected by the main supply-launder being made a little wider near the point of entrance, and the insertion at this place of a fine wire-sieve across the launder and somewhat inclined against the stream. This sieve must be occasionally looked after, to remove any impurities collected in front; and this, in fact, is the chief attention the whole apparatus requires, for otherwise it needs hardly any supervision. If once in proper working order, its action is constant and uniform, provided the material introduced does not change in amount and quality; and it has this further advantage, as compared with the slime labyrinths, that the classified stuff can, from the outlets, be directly conveyed in small launders to other concentration-machines for further treatment. One point, however, not in favour of the apparatus, is that a great fall of ground is required, to permit the direct introduction of the material and allow sufficient fall for the tailings; and thus, where local circumstances are unfavourable, it has to be erected at a higher level, and necessitates the use of elevators or pumps for lifting the stuff.

There are many forms of pyramidal trough in use, their dimensions varying according to the duty, but space only admits of typical examples being described here. One of these is when it is desired to settle all the pulp, including the slimes, by reason of there being too much water present for subsequent concentration. The pointed box should then be about 6 ft. deep, and 3 ft. by 7 ft. at the top, the longest sides sloping till they meet at the bottom. Such a box will settle and save about 6 tons of ore in 24 hours, discharging it automatically and continuously from the bottom by a siphon hose, with the proper amount of water for subsequent concentration. This form is used when the tailings from pan amalgamation are to be concentrated, after leaving the settlers and agitators, for they contain a large excess of water, which must be got rid of, so that the tailings

may be of the proper consistency for concentration. Fig. 72 shows a form of pointed box recommended by J. M. Adams in cases where the slimes are to be separated from the battery pulp and saved. Each box is 40 in. square at the top, and 40 in. deep, coming to a point at the bottom; and one box will handle 6-10 tons of pulp in 24 hours,

making a good separation. The pulp from the battery, entering the box *a* at the top, is confined by partition *b*, until it passes into the box proper *c*, near its bottom. Clear water is conveyed from a launder *d* above, through a $\frac{1}{2}$ in. pipe *e*, which delivers it into the box at the bottom. Care must be taken that this pipe is kept full, so that no air bubbles may be carried through it, creating agitation, and causing sand, &c., to pass off with the slimes. The quantity of clear water needed varies, so it is a good plan to have a cock in the pipe just below the clear water box *d*; or

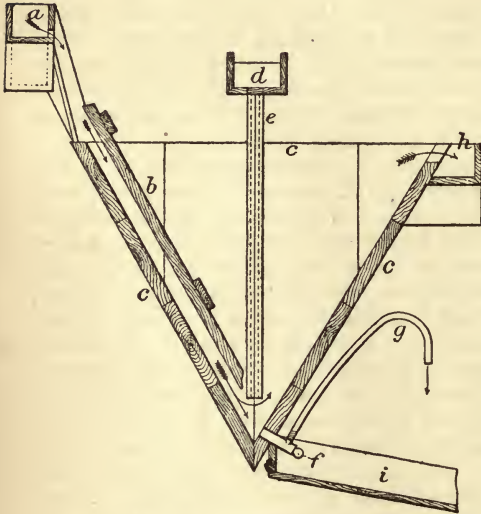

FIG. 72.—POINTED BOX.

to partially close, with a wooden plug, the opening of the pipe in the clear water box. At *f* is a hollow plug, and to it is attached a piece of hose *g*, which is used as a siphon, so that the pressure is lessened, and too violent discharge of the pulp is prevented. Without the siphon hose, $\frac{1}{8}$ in. opening would not be too small, while with it $\frac{3}{8}$ in. opening is about right, and the end of the hose is plugged accordingly. Inasmuch as foreign coarse material occasionally gets into the box (prevented as much as possible by a screen over the top), it is advisable to use in place of the hollow wooden plug shown, a $1\frac{1}{2}$ in. iron T with one end plugged, and with $\frac{3}{4}$ in. side outlet, attaching the siphon hose by nipple. The launder *h* carries off slimes, and the launder *i* conveys rich matters to the concentrators.

The Frongoch classifier (Fig. 73) is a simplification of, and improvement on, the German double troughs, or *Spitzluten*, fully described and illustrated in 'Mining and Ore-dressing Machinery.' It consists of an inverted wooden cone *a*, which can be more or less completely closed at the bottom by a plug *b*, controlled by a handle and screw-nut *c*. The cone *a* stands upon a wooden box *d*, which receives water under pressure from a pipe *e*, and is provided with a discharge-valve *f*, a mere flat plate of iron working on a pin, which can be pushed sideways so as to close the orifice more or less entirely. Inside the wooden cone *a* is a sheet-iron funnel *g*, which receives the stream of ore and water from a launder *h*, and causes

it to descend to the level *i*. There it meets with the upward current of clear water, and a separation is effected. The coarse and heavy particles which can overcome the stream pass into the box *d* below, and flow out continuously at *f*, while the fine and light particles are lifted by the current and carried over the top edge of the wooden cone *a*, which is surrounded by a circular launder *k*. By altering the flow of the upward current of clear water and the size of the discharge orifice, the separator can be adjusted to the special requirements of any particular case, giving it a distinct advantage over the older forms, which were useless for any but the purpose for which they were designed. At Frongoch this separator is used for classifying a mixture of galena and blende, just as it comes from the crusher, through a screen with 12 holes (3 by 4) per sq. in., the coarse going to the jigs, and the fine to the buddles.

Vanners.—The material having been classified according to size, the next step is to submit each separate size to a process of concentration, with the object of eliminating the valuable portion, or separating the several valuable portions where such occur and require subjection to different treatments at a later stage. Of the various apparatus in use for this purpose, all working upon the principle of

taking advantage of the differences in specific gravity of the several substances encountered, no class is more important than the "vanners" or "shaking tables," which, in every conceivable variety, provide a smooth inclined or horizontal surface, over which the ore is spread by a small quantity of water, and subjected to repeated and regular disturbance by an "end shake," or "side shake," or other sudden movement. For a description of numerous examples of these machines, the reader is referred to 'Practical Gold Mining.' It will suffice here to mention the Lührig system, the striking feature of which, as will be seen from Fig. 74, is the combination of 3, 4, or 6 (according to

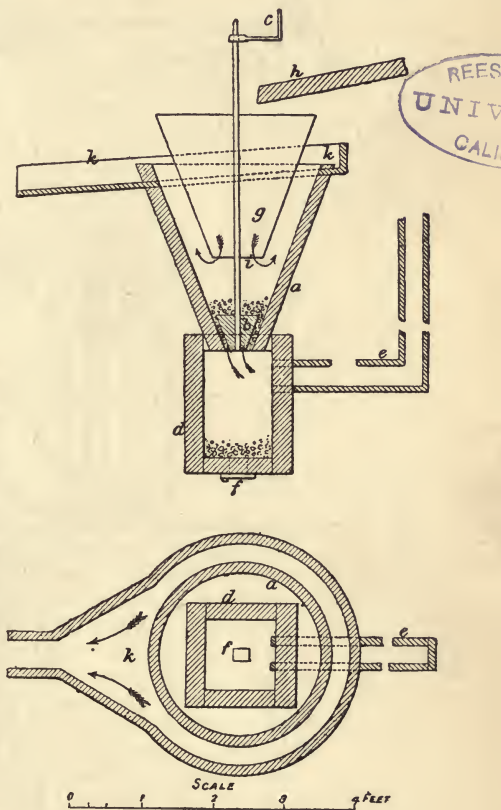

FIG. 73.—FRONGOCH CLASSIFIER.

the nature of the ore) single tables of an improved construction arranged in such a way as to allow of automatically feeding the "middle products" (or not yet sufficiently clean products) from the

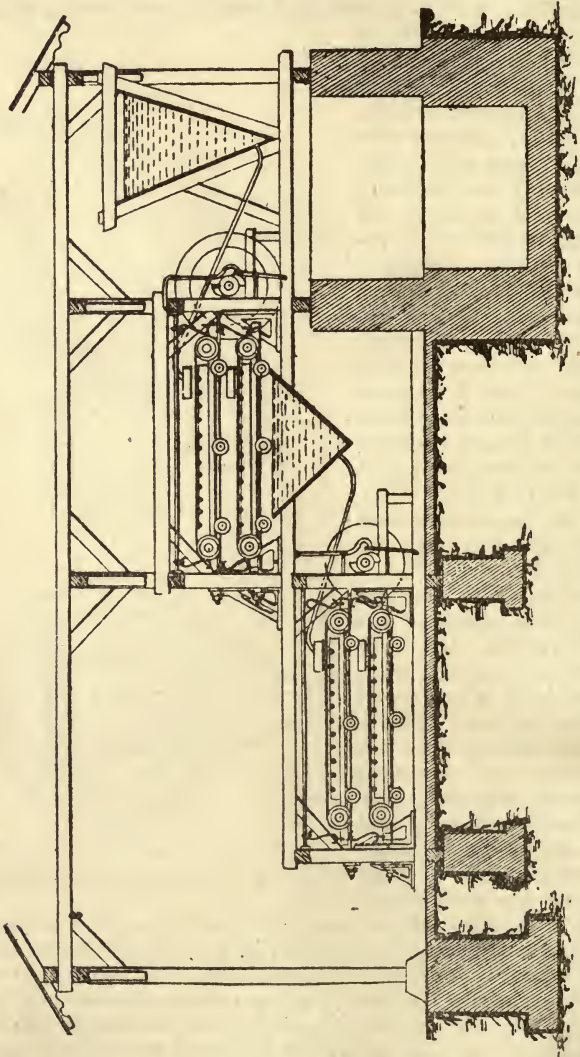

FIG. 74.—LÜHRIG'S COMPOUND VANNER.

upper tables on to the lower tables. By this subsequent treatment of the middle products on the same machine, high concentrates are obtained without requiring manual labour or incurring loss of mineral.

The single table consists in the main of a travelling band, with adjustable lateral inclination, suspended from a frame receiving an end-shake, which, combined with the action of a spray-pipe extending diagonally across the table, effects the separation of the various minerals in the pulp, according to their specific weights. These various products are washed off by the spray into receptacles in front of the table. The material is fed on to the table by a siphon discharge from a hydraulic classifier or pyramidal trough.

The advantages of the single table over others consist, firstly, in the circumstance that *one* clean product is always obtained in one operation; and, secondly, any number of grades of concentrates of different ores may be obtained on one table, and the degree of concentration, as well as the percentage of mineral left in the tailings, be adjusted according to wish. The intermediate grades would then be made to yield higher concentrates by the lower tables of the compound vanner, as described before.

One compound vanner will treat about 9 tons per day of 10 hours, giving absolutely clean tailings, besides separating the various minerals contained in the ore, one from the other. It has been proved to give excellent results in treating slimes of lead and blende ores containing iron or copper pyrites, or spathic iron; and it is particularly well adapted for dealing with tin and copper ores, avoiding all the handling now so frequently necessary in consequence of the use of imperfect machines.

In dressing auriferous ores containing a percentage of pyrites, this vanner does closer work with less cost than any other machine.

The Stein vanner, adopted at the Himmelfahrt works of the German Government, possesses several advantages. At Freiberg, one vanner washes $2\frac{3}{10}$ (dry) tons pulp in 10 hours, yielding at once a clean product, and giving poorer tailings than either the Rittinger or the Frue. Working on mixed ore containing blende and pyrites it delivers: pure galena; galena and mispickel mixed; iron pyrites clean; blende and iron pyrites mixed; tailings. When the pulp is not too low grade, galena with 70 per cent. lead can be easily obtained. They need little labour, one millman being able to handle 8 of them. Tailings show no lead and only $\cdot 005$ – $\cdot 01$ per cent. silver.

Buddles.—These machines are of several patterns.

The convex or centre-head (Fig. 75) consists of a circular pit about 22 ft. diam., and 1– $1\frac{1}{2}$ ft. deep at the circumference, with a raised centre 10 ft. diam., and a floor falling towards the outer circle at a slope of about 1 in 30 for a length of 6 ft. The stuff is brought to the centre of the buddle by launders *a*, into which flows a constant stream of water, and is distributed upon the raised centre from a revolving pan *b*, carrying a number of spouts, so as to spread the stream of pulp very uniformly in a thin film, which flows gradually outwards over the whole of the sloping floor to the circumference. In its passage down the slope, the material held in suspension by the water is gradually deposited according to its specific gravity, and the ore being the heaviest is the first thrown down, and is consequently in greatest proportion towards the centre of the buddle. The overflow *c* for the waste and slime from the circumference of the buddle is regulated by

a wooden partition perforated with horizontal rows of holes, which are successively plugged up from the bottom as the height of the deposit in the buddle rises. To facilitate the uniform spreading of the stuff over the floor of the buddle, and prevent the formation of gutters (

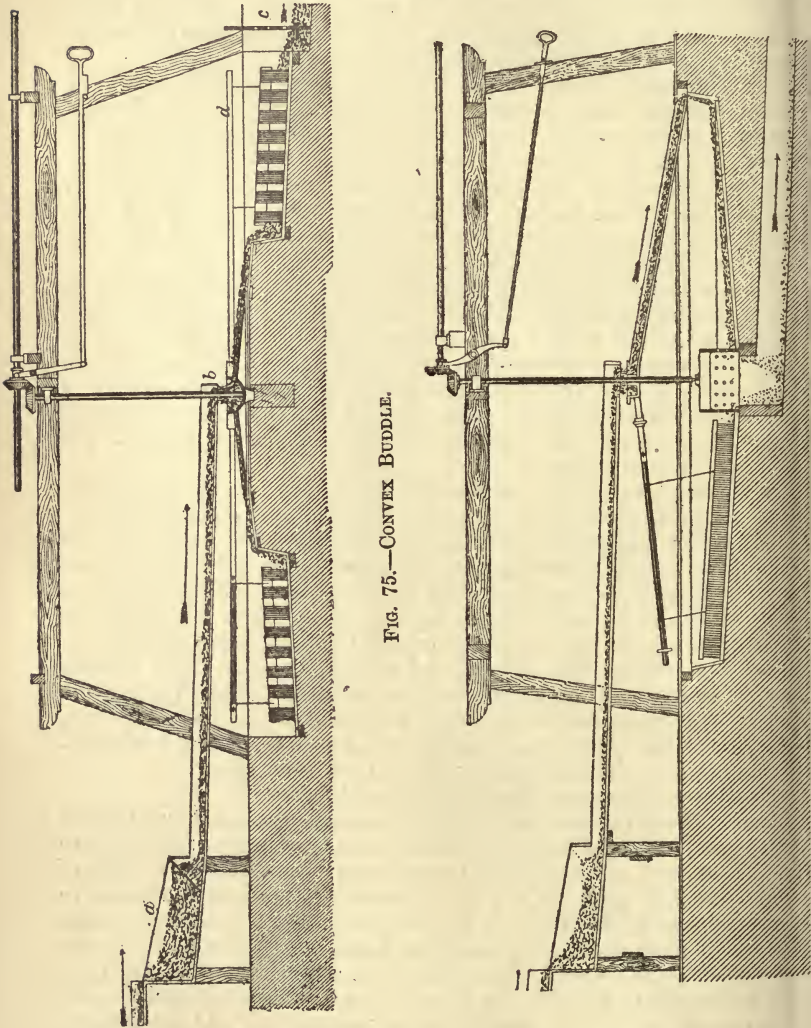

FIG. 75.—CONVEX BUDDLE.

channels in the deposit, a set of revolving arms *d* are employed, from each of which is suspended a sweep carrying a number of brushes or small pieces of cloth, and these being drawn round on the surface of the deposit keep it to an even surface throughout; the distributing spouts and sweeps are driven at about 5 or 6 rev. per minute. A

the deposit accumulates in the buddle, the sweeps are successively raised to a corresponding extent; and the process is thus continued until the whole buddle is filled up to the top of the centre cone, which usually takes about 10 hours. The contents are then divided into three concentric portions, each about a third of the whole breadth, which are called the head, middle, and tail; the head, or portion nearest the centre, contains about 70 per cent. of all the metal in the stuff supplied to the buddle, the middle nearly 20 per cent., and the tail, or portion next the circumference, contains only a trace; the remaining particles of metal are carried off by the water in the state of slime.

In the concave buddle (Fig. 76) the stuff is supplied at the centre, but is conveyed thence direct to the circumference, by revolving spouts that deliver it in a continuous stream upon a circular ledge, from which it flows uniformly over the conical floor, falling at a slope of about 1 in 12 towards the centre; it is kept uniformly distributed by means of revolving sweeps. The greatest portion of the metal is in this case deposited round the circumference of the floor, and the slime and waste flow away through rows of holes in the sides of a centre wall; as the depth of deposit increases, the level of the overflow is gradually raised by plugging up these holes in succession.

Quite in advance of the older forms of buddle is the Linkenbach table, a circular buddle made by the Humboldt Works at Kalk, on the Rhine. It has a fixed table and continuous action, and is made 35 ft. diam. or more. The surface is cemented quite smooth. Working at the Maria mine, near Beuthen, Germany, on partly concentrated slimes from fine jigs and partly old waste slimes, this buddle has given good results. With 3 tables, each 33 ft. diam., about 40 tons of clayey blende slimes are treated per 10 hours shift, and a product containing 28–30 per cent. zinc is obtained from a slime with originally 8–10 per cent. zinc. The waste water contains only 4–5 per cent. zinc.

A necessary appendix to the common buddle is a slime-frame or table, an effective and simple self-acting form of which is shown in Fig. 77. A launder bringing the slimes from the buddles passes between two rows of the slime-frames, set back to back, and the delivery to each frame is distributed by a fluted spreader, and then flows uniformly in a gentle stream over the surface of the frame, which is at a slope of 1 in 7, and is divided at the middle into two halves by a 5-in. step; the waste flows off at the bottom of the frame into the launder *c*. The stuff deposited on the frame is then flushed off at successive intervals of a few minutes each, by a self-acting contrivance consisting of two rocking troughs *d*, which are gradually filled with clear water from a launder *e*; when full, they overbalance, and discharge their whole contents suddenly upon the top of each half of the frame. The tipping movement of the troughs opens at the same time the covers of two launders *f*, one at the foot of each half of the frame, into which the stuff deposited on the frame is washed by the discharge of the water, the two halves being kept separate because the greater portion of the ore is retained on the upper half of the frame.

In wet dressing ores, the treatment of fine sands and slimes forms the most difficult part of the operation, and the one occasioning

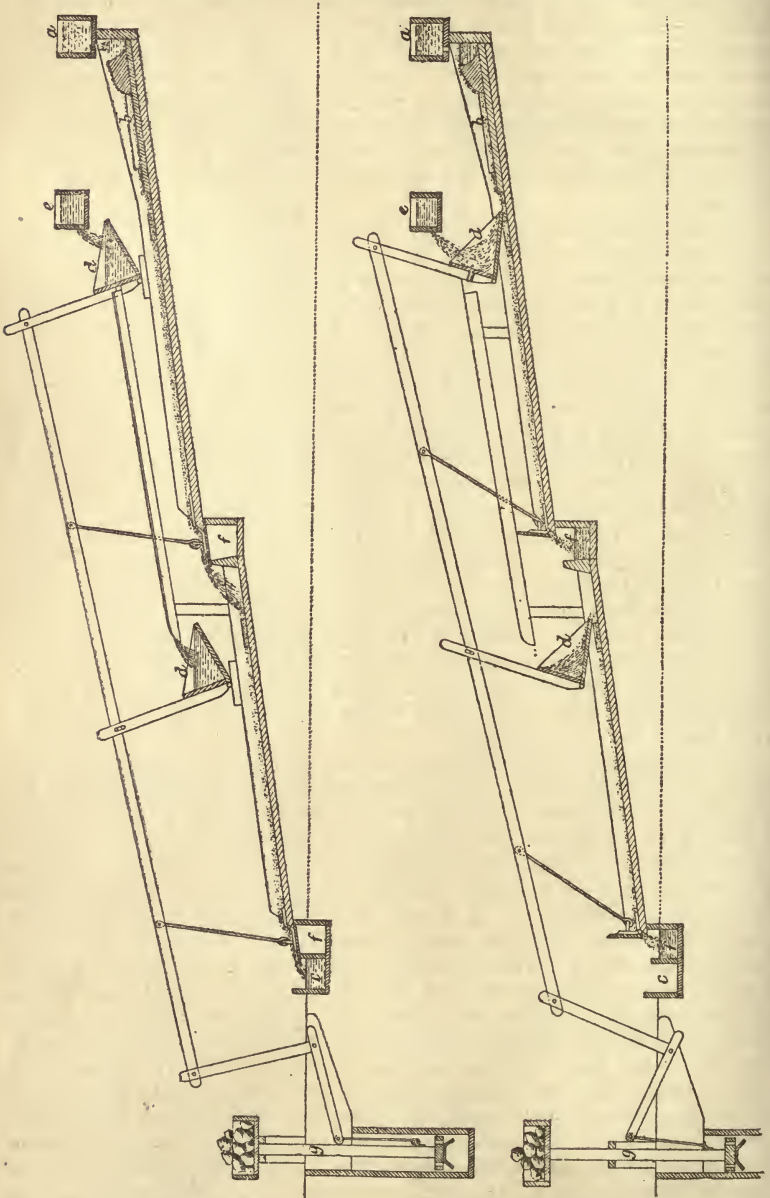

FIG. 77.—AUTOMATIC SLIME FRAME.

greatest loss. This loss is often augmented by the circumstance that some metallic ores, notably silver, have a tendency to crumble and

float away on the water. This has led Prof. Bilharz of Himmelfahrt to enunciate the principle that disintegration must take place step by step. He asserts that only by gradual crushing is it possible to guard the single grains of the separated substance against unnecessary destruction, and to let complete pulverisation take place only where the most intimate intermixture makes it absolutely necessary. Even in cases where the several substances of the ore are very intimately interwoven or finely disseminated in particles hardly visible to the naked eye, as in auriferous quartz, he thinks it will be found advisable to reduce the size of the particles gradually, and to remove a part in the coarser grain even when thereby running the risk of obtaining a final product of a lower degree of enrichment. But such ores as most silicious plumbiferous and auriferous arsenical or iron pyrites are seldom so much intermixed that a large part may not be separated in coarse grains, and they admit of very successful application of graduated disintegration, so that the production of slimes, that is to say, complete pulverisation, may be limited considerably. His method of treatment, according to these maxims, is:—The mixed ore derived from hand-picking the so-called crushing and stamping ore of the size of a fist, is, together with the mine smalls, thrown on a grate consisting of an inclined plate having 30 mm. perforations. This allows the small particles to fall through it, while the coarser ones are taken to the rockbreaker, which is set coarse, and admits a second hand-picking or gleaning of the ore leaving it. The material which has fallen through the grate, and likewise the broken-up ore turned out by the stonebreakers, is collected in a separating apparatus placed immediately below the former. This apparatus assorts the ore into particles of accurately graduated sizes and separates it from such coarser pieces as are not sufficiently broken up. The sizes over 7 and under 16 mm. are turned over directly to the waste jiggers, so called, because they are intended principally to separate the waste matter and to produce partly enriched, although still mixed, ore, which is reduced still further in the crushing mill. The pieces which are not sized in the separation apparatus, being refused as too coarse, fall on a moving belt or plane placed obliquely, and are separated by gleaning into pure ore and pure waste, the remaining pieces of mixed material being left on the belt to be dropped through a funnel into the first (coarse) crushing mill. The particles broken up in the crusher go directly to the separation apparatus for over medium-sized grains placed under it. From this, the grains graduated into fixed sizes flow directly on the jiggers, while the refuse of this second separation apparatus has to undergo another crushing in the second rolling mill. By arranging the works in stories, without any intermediate transportation whatever, the gradual separation into grain sizes is continued in a similar manner, as is also the jigging conducted in connection with it, after which, generally another (fourth) crushing in the third rolling mill becomes necessary. Not until after this occurs the last (fifth) crushing of the still remaining particles of intermixed material, or the complete pulverisation of the ore in the stamp mill.

Magnetic Concentration.—Where a magnetic ore is associated with

non-magnetic bodies, it is quite feasible under certain conditions to effect separation by electro-magnetism. This refers not only to those ores which are naturally magnetic, but also to those which by roasting can be rendered magnetic, provided of course that the cost of roasting is not prohibitive. In some cases, as with low grade iron ore, it is the iron which is sought to be concentrated by magnetic selection. In other cases, as with the auriferous beach sands of New Zealand and Oregon, the object is to isolate the gold particles by removing the iron grains. While the operation is always the same in fact, viz. collection of the iron particles, the objects are reversed, and the success of the operation must be measured by the special features of each case, particularly with regard to the degrees of concentration which are required and brought about. In one instance, a 10 per cent. enrichment of the iron ore may be highly satisfactory; in another case, removal of 50 per cent. of the iron from the auriferous sand may be totally useless. Thus the matter resolves itself at an early stage into a subject for special rather than general treatment. (See Iron.)

One point, however, may be insisted on here, viz. that magnetic separation can in any case only succeed with pulverulent matters, consequently everything in the shape of an ore or massive mineral must first be reduced more or less to powder, the degree depending on various circumstances, but averaging about 16 mesh, and it is of some importance that a granular condition be secured.

Dry Concentration.—There are many points which render dry concentration a desideratum. Water for concentrating purposes is often costly and uncertain in supply, and wet concentrated ores carry much water which has to be got rid of before further treatment. Dry concentration delivers the product in the best form for transport and smelting. Hence the application of air instead of water as a medium for separating gangue from ore has received much attention. All the earlier attempts courted failure by neglecting to size the material. Later inventors have not overlooked that essential feature, but some allow it to follow instead of preceding the classification by weight.

One of the most recent processes is the Pape-Henneberg, in which the dry pulverised ore is placed on rapidly revolving discs from which it is scattered in all directions. The centrifugal force acts proportionately to the weight of the particles, in such a way that particles of equal weight collect radially at an equal distance round the centre. When circular collecting troughs (called "rings") are arranged round the discs, the products which collect in each arrange themselves in such a way that a small heavy ore particle will be found with a large particle of waste rock or gangue. This mixture must be separated either by dry screening or by wet jigging or buddling.

In actual practice, difficulties occur, although the process appears very simple, and the reason is that in order to properly separate the mineral particles a large proportion of the ore has been reduced to fine dust or slime; and in treating this very fine dust the centrifugal force becomes powerless owing to the particles having practically no weight. This dust generally becomes mixed up during the scattering of ore with the various products in the rings, and hinders the centri-

fugal action, and in particular the screening operation. The Pape-Henneberg process deals with this difficulty in the following manner.

The centre of the centrifugal machine is covered over $6\frac{1}{2}$ ft. diam., and the disc hangs free. A current of air, formed by exhaustion, plays radially from all sides of the disc in a contrary direction to the ore particles, and carries off the dust down a funnel below the disc. It is possible to regulate this opposing current of air, so that the velocity of the ore particles may be acted upon not only according to their initial velocity but also according to pleasure. And as different ores behave in different manners, it is only a question of varying the intensity of the opposing blast to suit each particular case. It is, however, of importance not to produce more fines than the ore treated calls for.

The result obtained by the use of centrifugal force is a heavy product in the outside ring, and a light product in the inside ring—with middle products between the two.

All the products in the rings are capable of being screened, as they contain no dust proper. The coarse products screen easiest, and the fine ones with more difficulty, and the operation may be conducted with screens of very small mesh without modifying results. Although every ring product consists of small particles of mineral mixed with large particles of waste rock or gangue, yet every such mixture contains "middles" obtained by screening, and it is always advisable to separate such "middle" products, and submit them to a further treatment, which may be, in places where there is a total want of water, a repetition of the above treatment, or, where water is plentiful, a treatment on tables.

Wet table treatment is to be commended for all products of the process, which, owing to their fineness, cannot be screened, that is for all products obtained from the chambers where the exhausted fine dust settles. The value of this product is, however, with most ores so small, that a further treatment, when water is scarce, may be neglected. But in treating complex ores, and especially those in which the different minerals have similar specific gravities, it is absolutely necessary to combine the ordinary wet process with the dry process.

In the Clarkson-Stanfield dry concentrator, which is better known in this country, the classification by size precedes the concentrating process, and this would seem to be the more rational method. The operation of this machine will be better understood by reference to the illustration (Fig. 78), in which H is the feed hopper; P, pulley driving distributor; D, distributor; F, fan; S, speed regulator; N, speed-regulator handle; M, air-damper handle; R, receiver. It is based on the principle that when a particle of weight w is revolved at a velocity v around a vertical axis, and at a distance r from it (g representing the value of gravity), the centrifugal force is represented by the expression $\frac{w v^2}{g r}$. Now for any one place, g is a constant

quantity; r , the radius of the distributor is constant; and v , the velocity with which the outer edge of the distributor revolves, is made constant; therefore w , the weight of the particle, is the only

variable quantity. Thus the centrifugal force with which each particle is ejected is proportional to its weight, and when the particles are all of the same size the weights are proportional to the densities. Thus a particle of galena is ejected with about 3 times the force which carries a particle of quartz of the same size, but with less than twice the force of a particle of blende, in accordance with their relative specific gravities. A particle having been ejected has a kinetic or motive energy proportional to the force with which it has been ejected, and consequently to its weight, as already shown, or to its density for particles of equal size. The resistance of the air impedes the motion of each particle to an extent measured by the ratio of this resistance to the energy of the particle, and thus causes a separation of particles of different weights. Assuming that the resistance of the air is proportional to the area of the cross-section through a particle, the distance to which each particle will fly will be proportional to the ratio of its weight to this area.

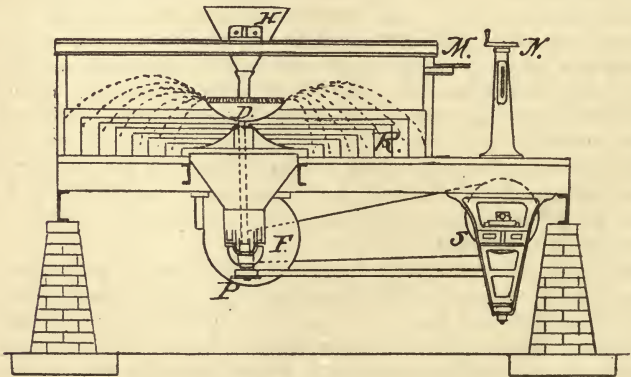

FIG. 78.—CLARKSON-STANFIELD CONCENTRATOR.

Since the introduction of the machine several improvements have suggested themselves in the direction of economy in operation, such as minimising the wear and tear, augmenting accessibility for control and repairs, and rendering the process as automatic as possible. Thus in recent forms, the driving mechanism for the distributor is suspended from above, where it is out of the way of the discharge and less liable to be impaired by falling grit. So too, with the various divisions of the receiver, instead of having to be brushed out as in the older form, they are now prolonged downwards at the bottom, forming self-discharging shutes. Points like these have as much to do with the industrial success of a machine as the correctness of the principle on which it is founded, and very satisfactory results have followed this attention to practical details. The machine as it stands now is much the most simple of the dry concentrators, and has done excellent work on mixed ores in competition with wet concentrators, with as good efficiency at much less cost.

NON-METALLIFEROUS MINERALS.

ALUM.

To a very small extent, alum is found native, as an efflorescence or incrustation, in regions of recent volcanic activity, where it is collected, dissolved in water, and purified by re-crystallisation. This product as found contains usually equal quantities of alumina sulphate and some other sulphate combined with water.

Alum rock or alum stone, also found in volcanic districts, is produced by the action of sulphurous vapours upon aluminiferous earths or rocks. It is composed principally of alumina sulphate and silica, various samples showing the following range of percental ingredients:—Silica, 0 to 62; alumina, $17\frac{1}{2}$ to 40; sulphuric acid, $12\frac{1}{2}$ to $35\frac{1}{2}$; potash, 1 to 14; water, 3 to 10; iron oxide usually nil but sometimes $1\frac{1}{2}$. The mineral is calcined in large kilns, and then lixiviated with boiling water. The presence of lime carbonate or of iron oxide is very detrimental.

	a.	b.	c.	d.
Sulphide of iron (pyrites)	4·20	8·50	38·48	9·63
Silica	52·25	51·16	15·41	20·47
Protoxide of iron	8·49	6·11	..	2·18
Alumina	18·75	18·30	11·64	18·91
Lime	1·25	2·15	2·22	·40
Magnesia	·91	·90	·32	2·17
Oxide of manganese	trace	trace	..	·55
Sulphuric acid (SO ₃)	1·37	2·50	..	·05
Potash	·13	trace	..	1·26
Soda	·20	trace	..	·21
Chlorine	trace	trace
Water	2·88	2·00	..	8·54
Coal	4·97	8·29	..	8·51
Loss	4·60	(?)	3·13	1·59
Carbon or bituminous matter	28·80	..

Alum shale is of much greater industrial importance. It is a kind of clay, containing much iron pyrites and bituminous matter, and closely resembling ordinary clay slate. Large beds are found in the Scandinavian peninsula, Bohemia, the Hartz, and the mountainous districts of the Lower Rhine. In Great Britain, they occur at Hurlet and Campsie, near Glasgow, near Whitby, in Yorkshire, and in Lanca-

shire and Warwickshire. For many years these places were the chief seats of the manufacture, alum works at the latter place having been established since the year 1600. The Whitby beds occur in Liassic strata, and are overlaid by a deposit of hard stone called "dogger." The shale beds reach a thickness of 200-300 ft., and are of a bluish-grey colour and general shaly character, but do not exhibit regular features. Some portions are much more earthy and soft than others, these being the most richly aluminous. The composition varies as shown in the table given on the preceding page, *a* being Whitby top rock; *b*, Whitby bottom rock; *c*, Campsie top rock; *d*, Campsie bottom rock.

The mineral is submitted to pile roasting under very careful supervision, an operation occupying several months. Some 4000-6000 tons are raised yearly in Great Britain, and 500-3000 tons in Germany, the value being about 16s. a ton.*

* Full details of manufacture are given in 'Spons' Encyclopædia,' article "Alum."

AMBER.

THIS interesting fossil resin occurs along the shores of the Baltic in deposits of varying thickness and productiveness. Occasionally detached pieces of amber are gathered along the Danish and Swedish coasts and on the eastern counties of England. Sicilian amber, from the neighbourhood of Catania, is particularly beautiful, showing brilliant plays of colour. Amber has been found also near Basle, in Switzerland; and in France, particularly in the Departments of Aisne, Bas Rhin, Gard, and Loire. In England it has been found in the London clay; and in the United States in New Jersey, Maryland, and North Carolina.

But with the exception of the Burmah deposits, which are worked irregularly, and have an indefinite value, the only commercial sources of amber are the Baltic mines. Here it is found in close association with mineralised wood underneath a covering of sand and clay that in places is 40 and 50 ft. deep. The amber is found in rounded or stalactitic pieces, with pyrites and sulphate of iron. Some of the excavations are 100 ft. deep, but there seems to be little regularity in the course of the lead. The richest deposits are between Memel and Königsberg, and at other points along the coast. Here the amber-bearing deposit is about 3 ft. thick, and is mined as any other similar stratum. Amber is obtained also by dredging and diving, and is picked up along the shore after heavy storms. Of recent years the greater amount has been obtained by mining, the product of the dredgers and the divers having shown for some years past a steady decline.

A certain amount of preparation is necessary before marketing. The lumps are freed from adhering sand, &c., by washing, and then sorted according to quality. That which is valuable for its beauty is treated with great care, and worked up for pipes, &c. The small scraps are steamed with chemicals to destroy the dark colour, and when thus rendered clear they are melted and agglutinated into larger pieces and are thus bought by varnish-makers.*

The total production amounts to the very large figure of 150 to 200 tons yearly, and the average value is stated at about 12s. 6d. a lb., but varying very much with the quality.

* See Spons' 'Encyclopædia,' pp. 1628, 2023.

ARSENIC.

ARSENIC is an iron-grey, metallic-looking, brittle substance, sometimes occurring native in veins in the older rocks, but commercially obtained principally as a sulphide in association with iron and copper pyrites and tin-stone.

Arsenic itself is a substance of no commercial importance, but some of its compounds, as the oxide, commonly called "white arsenic," or "arsenious acid," and the sulphides, orpiment and realgar, are largely used for various industrial purposes.

Arsenical pyrites, or "mispickel," is roasted solely for the arsenic which it contains; but from the ores of tin and copper arsenic is obtained as a bye-product in the various smelting processes.*

Arsenic sublimes at 424° F., and in order to effect the thorough roasting of the ore, the temperature must be raised to low redness, but not beyond, since any increase of temperature above that which is absolutely necessary for sublimation, must be compensated for by a greater length of flue, in order that the vapours may be sufficiently cooled in their progress to be entirely deposited. This, of course, applies only to the ores (as mispickel) which are roasted solely for the sake of the arsenic which they contain. When tin and copper ores are employed, and arsenic is yielded merely as a bye-product, a much greater heat is required, and consequently the series of flues and condensing chambers must be longer in proportion, in order that the requisite space may be afforded for the cooling of the superheated vapours.

The arsenical tin and copper ores of Cornwall and Devonshire contain arsenic in the form of arsenical pyrites ($\text{Fe As} + \text{Fe S}_2$), a compound of arsenide and bisulphide of iron. It is common to see the manufacture of arsenious acid forming part of the first process to which the tin ores are subjected in West Cornwall, and the copper ores in East Cornwall. The quantity of arsenic in the tin ores raised in Cornwall and dressed there, either at the mines or on the streams which carry down tin ores from the hills ("stream tin"), varies greatly, so that at some works the arrangements for collecting arsenious acid are on a much more extensive scale than they are at others. The process is similar whether it be a cupreous or a stannous ore that is dealt with.

The ore, first stamped and then dressed by buddling, is subjected to a process of calcination, the object of which is to burn off the arsenic as arsenious acid, and the sulphur as sulphurous acid, and to peroxidise the iron. Three methods of doing this are commonly in use in Cornwall. One of these is by burning the ore in a reverberatory

* Much useful information on ready means of estimating arsenic will be found in a paper by A. Dickinson, "On the Assaying of Arsenic Ores," in *Trans. Inst. Min. and Met.*, ii. 110.

furnace with a flat bed, on which the ore in the state of powder is subjected to a dull red heat for about 24 hours, during which it is frequently turned over. When believed to be sufficiently burned, it is raked out, either on to a floor or a hearth prepared to receive it. The material is again buddled, and the product of the washing is again calcined for about 12 hours, this time with a stronger heat. In many instances one calcination is found to suffice. This method is called "hand-calcining." If the heat be too great at the first calcination, or if the material has been introduced not sufficiently dry and powdery, and if it be not kept well stirred, it is apt to cake, and then the centre of the caked masses may be insufficiently burned. Hence the operation requires constant careful watching. The inside dimensions of these flat furnaces, which are usually built in pairs, are commonly 20 ft. long, $6\frac{1}{2}$ ft. wide, and 16 in. from bed to roof; a double furnace will treat 8-10 tons per 24 hours, using 3 cwt. coal per ton roasted, and employing 2 men on each 8-hour shift, who receive $3-3\frac{1}{2}$ s. per ton.

Another apparatus largely used in Cornwall is Brunton's calciner. It is essentially a circular reverberatory furnace, the floor or bed of which, made of firebrick laid on a slightly curved table of iron, revolves slowly. Numerous iron "flukes" or ploughs project down from the roof nearly to the bed, and are so constructed as to turn the powder over and to move it a little outwards on the floor as it revolves. The ore fed in at the middle of the roof is in this way made to travel slowly towards the edge, and at last to fall into a box or "wrinkle" prepared for its reception. A portion of ore takes 6 to 8 hours to travel thus to the edge. The calciner is heated by two fires, placed as near as convenient to each other, opposite the uptake through which the gases escape. It is said that this calciner is best adapted for stamped ores, stream material (ore washed down in the streams) being too fine to be dealt with in this way. The average capacity is 4-5 tons per 24 hours, employing 1 man per 12-hour shift, who receives about 2s. a ton, and consuming $1\frac{1}{2}$ -2 cwt. coal per ton calcined. This roaster is, perhaps, the most efficient so far as uniformity of product goes, but it operates slowly, verifying the general law that oxidising roasting will not admit of hurry; it might be much improved in speed, capacity, and economy of fuel, by furnishing supplementary supplies of pure hot air.

The third kind of calciner in use in Cornwall is that of Oxland and Hockin, shown in Fig. 79. It consists of a wrought-iron cylinder 20 to 30 ft. long, with an internal diameter of 3 ft. to 4 ft. 6 in., and lined with firebrick. It is mounted in an inclined position, and caused by machinery to revolve slowly; the ore fed in at the upper end is turned over and over as it flows slowly towards the lower end, where it is discharged. The turning over of the ore, so as to expose all parts of it to the heat, is effected by four longitudinal ribs of firebrick, which project into the interior. The flame from a furnace enters at the lower end, and the products of combustion and calcination pass away by a flue from the elevated end. The Oxland calciner, which is often only an old boiler shell lined with firebrick, will roast 20-25 tons per 24 hours, consuming only 10-20 lb. coal per

ton, and employing 1 man and 1 boy per 8-hour shift, who receive 10–12*d.* a ton. It is thus by far the cheapest in fuel and labour, but requires 2–3 h.p. motive power, costs more for repairs, and is less amenable to control, so that its work is not uniform and sometimes an excessive draught causes mechanical admixture of solid particles of ore with the volatilised arsenious acid.

A fourth mode of burning a highly sulphurous arsenical ore, containing, say, as much as 30 per cent of sulphur—at any rate enough to burn by itself without fuel—is in kilns built like the limekilns used for continuous burning, but covered in at the top, where the ore is charged in through hoppers, each provided with a damper to close the bottom. The arsenious and sulphurous fumes are carried off from the upper part of the kiln by flues. The process is very imperfect.

At Deloro, Canada, where large quantities of auriferous mispickel have been worked, the Oxland calciners first used were modified by Rothwell, as follows:—In the upper 3–4 ft. of the cylinder the usual brick shelves were retained, but were arranged spirally, so that they

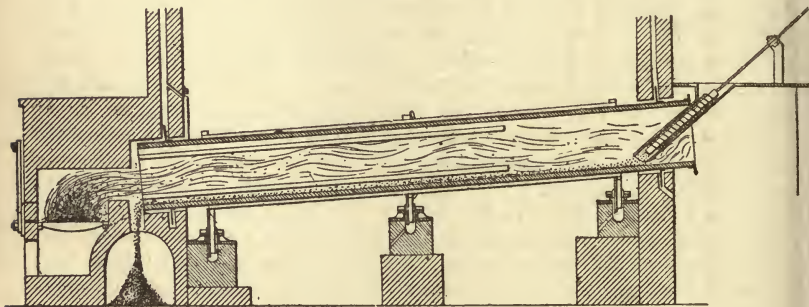

FIG. 79.—OXLAND AND HOCKIN CALCINER.

“screwed” the charge into the furnace and prevented backing up at the feed. Beyond that distance, the brick shelves were replaced by tile diaphragms 12 in. wide, which met in the centre of the cylinder and divided it up longitudinally into 4 compartments, so that the ore was divided into as many equal parts, each revolving in its own compartment. About halfway down the cylinder, the several tiles forming the diaphragms were set 1 in. apart, so that as the cylinder revolved the ore filtered down from one compartment to another, encountering the stream of air passing up the furnace, which air was supplied by a suction fan near the chimney and was thus always under control. With two furnaces thus equipped, one 30 ft. \times 5½ ft. delivering into a second 60 ft. \times 6½ ft., 48 tons were roasted per 24 hours with 2 men per 12-hour shift, and a third during the day on the cooling floor, the consumption of fuel being, it is claimed, reduced by one-half.

With a view to collect the arsenious acid, one or more chambers are constructed in the course of the flue (which itself is usually capacious) to the chimney shaft. The chamber may vary in height from 7 to 12 ft., and is provided with a number of vertical partitions,

springing alternately from opposite sides or ends of the chamber, so as to constitute the chamber a series of zigzag passages 3 to 4 ft. wide and 8 or 10 to 40 ft. long. Each passage or section in the zigzag is provided with an iron door, by which a workman enters it at due intervals to remove the deposited arsenic, but which at other times is closely luted up. From the chamber the flue usually proceeds either straight or angularly, and when feasible up a hill-side, to the chimney-shaft. Fig. 80 is a plan of one of these zigzag chambers. It is 6 ft. high, but there are other chambers longer and higher. From the chambers at Devon Great Consols a capacious flue passes with angular bendings for 150 yd. up a hill to the chimney stack, 120 ft. high, the base of which is 80 ft. above the level of the works. Other works have chambers much longer. For instance, at the burning-houses in

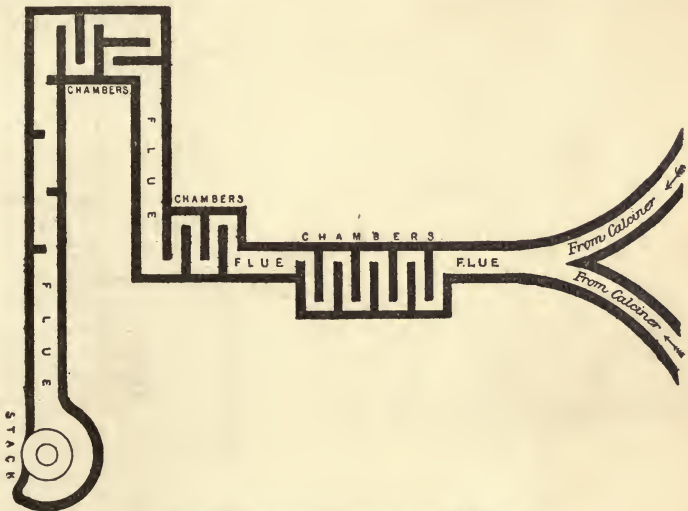

FIG. 80.—ARSENIC CONDENSING FLUE.

the Tuckingmill Valley there is a zigzag chamber containing 18 passages, each 33 ft. long and 7 ft. high by 4 ft. wide, and at the East Pool "burning-house," close to it, there are 400 yd. and more, mostly of similar zigzag, 10 or 12 ft. high, between the calciners and the chimney. The flues are also in all cases provided with doors at convenient distances when they are above ground, as they usually are; but sometimes they are constructed under ground, and then they have to be opened above to gain access to the interior of them.

If the flues be duly tight, all the sulphurous acid from the combustion of the ore not condensed with the watery vapour in the flues (and this is probably only a small proportion of the whole) escapes into the air by the chimney, and with it so much of the arsenious acid passes off as the flues have failed to arrest. In works where the ore is more sulphurous than arsenical, but little pains are sometimes taken to collect the arsenic, and then the larger proportion of it goes

off by the chimney with the sulphurous acid. By building the first portion of the condenser as a spacious chamber, and making the exit for the vaporous part of the fumes some 10–12 ft. high above the entrance, considerable mechanical cleansing can be secured, as it remains hot enough to avoid condensation in the chamber. The sides and bottom of this chamber are made steeply sloping, and the feed of the raw ore is carried through it. By building a lip of boiler iron into the base of the chamber it will deliver ore and dust within the grasp of the spiral shelves described above.

The arsenious acid taken from the flues and zigzags of the burning-houses is more or less crystalline, and mixed with sooty matters and also with some moisture which is acid from the oxidation of the sulphur of the ores; it has therefore to be refined. For this

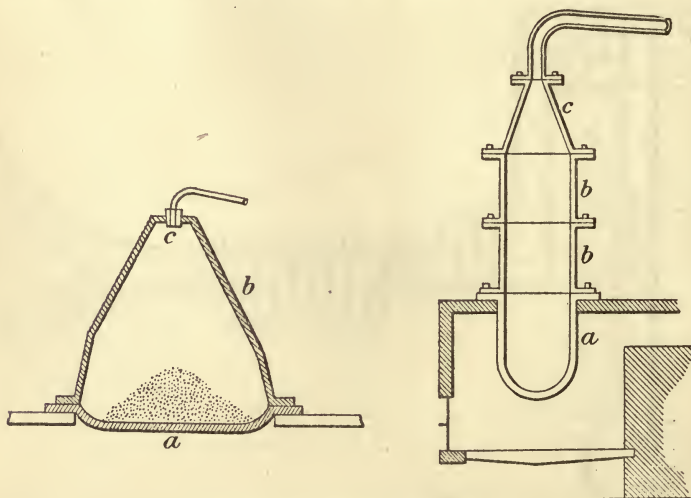

FIGS. 81, 82.—REFINING ARSENIC.

purpose a reverberatory furnace is again used, with a flat, square, or oblong floor, and smaller than the furnace used for hand-calcining. The fuel used is mostly coke, and sometimes a second fire is used, the flue from which is made to pass beneath the floor of the oven. The volatilised arsenic is collected in zigzags as before. Such refined arsenic is powdery: when lump or vitreous arsenious acid is to be made the arrangement adopted is of a different character. There are two forms of apparatus in use for this purpose. In the one form, Fig. 81, a strong circular cast-iron dish *a*, about 2 ft. wide, is provided, which is supported by the flange over a fire; on this is placed a conical iron cover *b*, termed the “kettle,” and the flange of the kettle is closely fitted to that of the dish by wedges. At the summit of the cone is a hole about 2 in. wide, which, during the sublimation of the arsenic, is closed by a stopper *c*. A pair of these dishes are placed so as to be heated by one fire, in a sort of closet terminating

above in a low chimney and enclosed in front by an iron door, so that any arsenious acid that may escape shall not pass into the room, and so injure the workmen. The charging is effected in portions thus: the kettle being wedged on, a quantity of crude arsenious acid is introduced by a funnel into the hole at the top, and falling down forms a little conical heap in the centre of the dish. A similar fresh charge is introduced about every 2 hours, and at the end of about 24 hours the fire is put out and the kettle is removed, when the vitreous arsenic is found coating its interior, and is chipped out.

The other form of apparatus is indicated by Fig. 79. It consists of four flanged pieces bolted together by their flanges. The lowermost is a strong cast-iron pot *a*, about 2 ft. deep and 18 in. wide, heated by a fire beneath and all round. Above this are two cylindrical pieces *b*, rising above the pot to a height of about 3 ft., and surmounting these is a conical piece *c*, from the summit of which a 3-in. pipe conveys any uncondensed matters into a zigzag chamber. The charge is all introduced at once, and the process of volatilisation is completed in about 4 hours. The fire is then put out, and the apparatus is allowed to cool; the vitreous arsenious acid is found lining the three top pieces. Whatever escapes condensation in the apparatus is passed into the zigzag, and not as in the other form of apparatus into the air.

When the fumes are, as is the case at some works, carried in tight flues up a hill-side, and discharged from the top of a tall chimney, or where the works are situated in a wild uninhabited part of the country, no offence or damage is occasioned by the fumes so discharged; but in some cases, where carelessness or bad arrangements of the flues and chimney prevail, the nuisance from the fumes is considerable, especially when the burning-houses are situated at the bottom of a narrow valley, and the chimney tops are not higher than the level of the head of the valley. Nuisance may also arise from drawing the ore before it is thoroughly calcined, and from leaky flues. The uncondensed fumes should be discharged at such an elevation and at such a distance from dwellings, crops, and water supplies that they shall be thoroughly dispersed before they have time to fall. Where this is not practicable, other remedies are not easily to be found, as the acid fumes given off by the calciners are largely diluted with air, and most difficult of condensation. Any additional condensing appliance, such as a water spray or dip tower, greatly impedes the draught, and renders a blower or fan almost a necessity. Where there is a demand for impure sulphuric acid, the fumes may be conducted through leaden chambers after precipitation of as much arsenic as can be thrown down; but where the ore is rich in arsenic so much air has to be admitted for its oxidation that this plan is not feasible.*

The quality of commercial arsenic depends upon its purity. The best quality is perfectly white, but the presence of sulphur, due to its deposition with the arsenic in the condensing flues or chambers, imparts to the latter a highly objectionable yellow tinge. This is especially characteristic of the German article, which is often called "yellow arsenic." The arsenic from Swansea is also yellowish in

* For further details of manufacture, see Spens' 'Encyclopædia,' p. 336.

colour, while that from the works in Cornwall and Devon is entirely free from sulphur. That obtained from treating tin whits is often so soiled by smoke as to be called "arsenical soot," and requires to be re-sublimed before putting on the market. Refined arsenic should be in compact, vitreous lumps, and perfectly free from particles of metallic arsenic; when of bad quality, it is in loose masses, more or less soft and friable, due to re-subliming the crude acid under too feeble a temperature.

The production of arsenic in Great Britain fluctuates between about 4000 and 8000 tons annually, with a value of about 6 to 9*l.* a ton.

Considerable quantities of white arsenic have of late years been produced at the Gatling mines near Marmora (Deloro), Ontario, Canada, as a bye-product of the treatment of auriferous mispickel for recovery of the precious metal, the mispickel occurring abundantly in quartz veins in granite.

ASBESTOS.

THE familiar fibrous substance commonly known as asbestos embraces at least two distinct minerals—asbestos proper, which is a variety of hornblende; and chrysotile, which is a variety of serpentine, and readily distinguishable by its yielding water when heated in a closed tube. Though both minerals are found in the altered crystalline rocks, each has its particular associates, and while asbestos proper occurs in metamorphics rich in hornblende, chrysotile is encountered in distinct veins penetrating masses of serpentine, which have generally resulted from the alteration of eruptive rocks rich in olivine. Commercially, the two minerals are indiscriminately known as asbestos, but they possess marked features governing their mercantile value, despite close resemblances in chemical composition. The Italian product is true asbestos; the Canadian is chrysotile. These two countries practically supply the whole output.

Although asbestos mining and prospecting in Canada has continued for years, and the areas of serpentine are very extensive, the portions in which asbestos of good quality or in paying quantity is found, are in comparison so small that mining operations are practically confined to two centres only a short distance apart. These places may be reached in a few hours from the city of Quebec by train on the Quebec Central Railway, which runs through the heart of the asbestos mining district at Thetford and Black Lake Stations, about midway between Quebec and Sherbrook. The formation is metamorphic, and the asbestos is found in a belt of serpentine which extends from the township of Broughton on the north-east, to that of Ham on the south-west, and includes the townships of Thetford, Coleraine, Ireland, and Wolfreton. The whole district in which asbestos is thus mined has a radius of about 10 English miles.

The asbestos-bearing lode of serpentine varies in width from 10 to 100 ft., and in many parts contains innumerable veins of asbestos varying from $\frac{1}{8}$ in. up to 4 in. thick, which cross and re-cross each other in every direction and at every angle. Frequently several veins are found parallel to each other, being only separated by thin layers of chrome ore. The outcrop of the veins is generally impure, containing oxide of iron, and being leathery instead of fibrous; but a few feet in, this disappears, and the veins are of a beautiful greenish-white colour.

The mining of asbestos is wholly conducted by opencast or quarrying, the drilling, blasting, and removing of the broken rock out of the pits to the dumps going hand in hand with the gathering of the asbestos mineral and transport of the same to the dressing establishment or cobbing shed. The average cost of this in Quebec may be set at about $1\frac{3}{4}d.$ per ton of rock handled for drilling, $1\frac{1}{2}d.$ for blasting, and $12\frac{1}{2}d.$ for removing of rock and gathering asbestos in the pits. The cost of production of 1 ton of asbestos will

naturally depend upon the number of tons of rock to be removed per ton of asbestos, or upon the richness of each individual mine. Few places show ground as rich as 50 tons of rock per ton of asbestos, while others run as high as 150 and more. One per cent. of asbestos in the works, with a fair proportion of high grade (that is, long fibre), is considered a profitable mine at the present price of the product. Dressing or cobbing consists in separating the asbestos fibre from the adhering rock, and grading it in different qualities, followed by packing, transport to railroad, loading, shipping, and marketing. Of course, the cost of cobbing varies considerably, according to the quality of the material. While some stuff will break from the stone very easily, other kinds require considerable labour. Some occasionally may be contracted for at 12s. per ton (this, however, never includes the manipulation of cobbing stones), while other material may cost as high as 3*l.* and more. Including the breaking of the cobbing stones, 28s. may be estimated as the average cost of cobbing for a ton of marketable material. Bags and bagging, with transport to railway and loading, may be set at an average cost of 8s. per ton; supplies, such as fuel, steel, iron, timber, and other material and repairs, 22s. per ton; general business expenses, management, insurance, offices, and marketing product, 24s. per ton: to which is to be added wear and tear of machinery, depreciation, and interest on capital.

The grading is done in three qualities. "No. 1" represents the longest and finest fibre, from about $\frac{3}{4}$ in. up, without discoloration and is used chiefly for spinning purposes. "No. 2" is composed of an inferior grade of long fibre, being either harsh and less flexible or discoloured (principally from iron), and short but clear,—i. e. unbroken fibre from about $\frac{1}{2}$ in. up—and is principally used for inferior qualities of wick-packings and for fillers. "No. 3" consists of pieces containing still shorter fibre, to a large extent intermixed with serpentine and iron, and is, when cleaned from foreign substances, principally used in the manufacture of paper, cardboard, &c.

It has been noticed by Dr. Ells that the serpentine carrying the marketable asbestos is generally of some shade of green on fresh fracture, usually a greyish green, and in which are contained numerous small particles of iron, both magnetic and chromic, more usually the former. Serpentine that have a black, hard, chippy aspect do not promise well. In the asbestos-bearing rock proper the veins of asbestos are seen, without any special arrangement, intersecting the mass of the rock generally in every direction. In size they range from mere threads sometimes close together, to a thickness of 1 to 2 in. and, very occasionally, 3 to 4 in. The asbestos from these larger sized veins, provided it contains no serious impurities, is classed as "No. 1," and is used for spinning and weaving.

Hand labour, which is much employed in Italy, owing to the difficult nature of the ground, has been largely superseded in Canada by the use of steam derricks, drills worked by compressed air, and other appliances.

Of Italian asbestos there are three distinct varieties, viz. the grey, which has a long strong fibre, and is saponaceous to the touch; the

flossy, which has a smooth, silky appearance, but is dry to the touch; and asbestos powder, which, while possessing all the heat-resisting properties of the preceding, crumbles into powder when crushed.

When asbestos is first found in any new place, generally the only superficial indication is that the cracks in the rocks are filled with a white powdery substance. When the surface is broken up, this usually changes into a leathery looking material, and entering still farther, the true asbestos fibre may be found.

The Italian mineral lies in beds and pockets which are mostly reached by open quarrying, dynamite being largely used. Transport of the crude mineral down the mountain side is often effected by loading it in a sort of sled, about 8 cwt. at a time, which two men can guide over the ground, whether it be snow-covered or not.

The lumps of mineral, as they are taken from the mine, consist of bundles of hard fibres, lying parallel to one another, and strongly bound together. They vary in colour from light grey to brown, and the general appearance of a fine sample of asbestos is suggestive of the interior of the riven trunk of a tree. By the exercise of a little care, threads may be separated, many feet or even yards in length, the continuity being perfect from end to end, the general appearance and strength being very similar to those of flax. It is this quality of length and strength of fibre that distinguishes Italian asbestos from all other. The best comes from Emarese; the most fire-proof from Usseglio; that of Campiglia Souna has long fibres, but is often in a state of decomposition; on the whole, the mineral from Valtellina has the strongest fibres.

Asbestos of inferior quality is found in a number of localities in the United States, but these are for the most part of no more than mineralogical interest, and have never become important producers. The total amount of asbestos mined in the United States in 1889 was but 30 tons; in 1890, the product was only 71 tons, the production in each year being limited to California. In 1891 the output was 66 tons. The American mineral is adapted only for grinding, for paints and cements, for boiler and steam-pipe covering, &c.

African asbestos is dark blue in colour, and while the length of the fibre is about the same as the Canadian, it is altogether wanting in fire-resisting power. Whilst Italian asbestos contains nearly 80 per cent. magnesium silicate and only about 3 per cent. iron oxide, this African asbestos only contains about 50 per cent. silica and no less than 40 per cent. iron oxide. It will not stand much heat without disintegrating and becoming quite rotten, this effect being probably due to the fact that a portion of the iron is in the form of a ferrous salt. By exposure to air and heat this salt oxidises, and alters the composition of the asbestos to such an extent that it is easily charred.

A considerable quantity of asbestos, somewhat resembling the Canadian in character and formation, has been imported from beyond the Ural Mountains in East Russia. This fibre, although darker in colour than the Canadian asbestos, is certainly superior to the African, but has very little commercial value.

In composition, asbestos is essentially a hydrated magnesium silicate. The following analyses are interesting for comparison:—

	Canadian.				Italian.	
	a	b	c	d	i	ii
Silica	40·57	40·52	39·05	40·9	40·3	41·69
Magnesia (and lime)	41·5	42·05	40·07	33·2	43·37	37·84
Alumina	·9	2·1	3·69	6·6	2·27	2·57
Iron oxide	2·81	1·97	2·41	5·75	·87	3·01
Potash	traces	..	·85
Soda	·68	..	1·41
Chlorine	·25
Water	13·55	13·46	14·48	..	13·72	3·04
Loss (organic matter, &c.)..	·3	12·5	..	9·59

NOTE.—a is very finest quality; d, average commercial; i, average commercial.

A curious feature of Canadian asbestos is that while it is perfectly fireproof and acid-proof, it is easily damaged if exposed to rain or water when newly mined, becoming hard and woody.

Asbestos is used in making liquid and fireproof paints, roofing, piston and valve packing, flat packing, covering steam-pipes and boilers, fireproof cements, sheet and roll millboard, flooring, felt, tubes for carrying electric wires, lamp-wicks, &c. It is often used in combination with hair felts and other substances.

All asbestos goods may be classed, as regards their process of manufacture, under two heads—paper and yarn. The paper may be worked up in various ways, and the yarn may be twisted, plaited, or woven, but the crude material is made to assume one of these two forms before it is worked into the finished article.

The crude asbestos is brought in bags containing 1 to 2 cwt. each. When unpacked, it is found in pieces of all sizes from that of a man's hand to such as a man can scarcely lift. These have first to be opened out to free the fibres from one another, and from the non-fibrous material by which they are bound together. For this purpose a machine has been devised consisting of two rollers covered with teeth of pyramidal form. These revolve, as a rule, at equal peripheral speeds, and at the same time have a sideways motion in relation to each other, so that the asbestos, which is fed in with the fibres lying parallel to the line of motion, is both crushed and separated at the same time. By the direct pressure, the binding agents are separated, and then the loosened fibres are combed apart by the reciprocating motion, which, however, is not sufficiently great to interfere with their parallelism. In the subsequent operations there is nothing special, the short fibre being dealt with like paper pulp, and the long fibre being spun and woven as a textile.

The total yearly production is about 6000 to 9000 tons of Canadian, and about half that quantity of Italian. The trade being in few hands prices fluctuate arbitrarily, ordinary figures being 20*l.* a ton for Italian and 8*l.* to 15*l.* a ton for Canadian.

ASPHALT.

ORIGINALLY applied specifically to a peculiar substance found in a single locality—on the shores of the Dead Sea—the term asphalt is now used generically to denote a great number of semi-solid bitumens or bituminous rocks, differing widely from each other in chemical composition and in behaviour under the influence of heat and of reagents. The original substance, of which very little is seen now, was defined as having a sp. gr. of 1.0 to 1.2, fusing at 212° F., dissolving in five times its weight of naphtha, insoluble in water and in alcohol, emitting a strong smell of pitch, and burning with a bright flame. All bituminous minerals are supposed to be derived from vegetable matters acted on by water, other conditions probably being exclusion of air, and presence of heat or pressure, or both.

Until the remarkable impetus given to the asphalt industry in California and Utah in 1888, the Pitch Lake in the island of Trinidad, and the deposits of Seyssel, in France, Val de Travers, in Switzerland, and Limmer, in Brunswick, furnished the bulk of the world's supply. Cuba produces asphalt of excellent quality, some of which has been imported into the United States. Venezuela has furnished a small portion of the supply in the past, and a few tons of bituminous limestone are produced annually in the island of Sicily. In Mexico large deposits of asphalt are reported.

The American discoveries have led to a multiplication of names without any corresponding usefulness, each deposit apparently receiving a new appellation. Thus we have albertite, asphaltum, brea, elaterite, gilsonite, grahamite, maltha, piauzite, uintite (or uintahite), wolongonzite, and wurtzilite.

The most important European source of asphalt is a limestone hill impregnated with bitumen close to the town of Seyssel, on the Rhone. The product varies much in appearance and in the proportions of bitumen and limestone, but contains no other substance.

The Val de Travers mine is very different from that of Seyssel. It is much richer in bitumen, but of considerably less extent. The bed of asphalt is covered with a thin layer of soil, underneath which is another layer of earthy asphalt, varying in thickness from 2 ft. 6 in. to 3 ft. The bed itself is circular in form, about 22 ft. thick and 160 yd. diam. It contains 12 or 13 per cent. of bitumen, and it was the first kind ever employed in the construction of pavements.

These two mines are by far the most important European sources of asphalt; but there are several smaller ones from which an equally good product is obtained, e.g. those of Chalonge, Chavaroché, Manosque, Lobsann, Dallet, and Pont du Chateau. There is also a large mine at Maestu, near Vittoria, in Spain, the product of which is of a very fine quality; but access to this mine can only be gained by

means of mules and oxen, which is a serious drawback to its successful working.

Asphalt is ordinarily obtained from the mine by blasting, like other rocks. This is sometimes carried on in the open air, as at Seyssel and Val de Travers, and sometimes in underground workings, as at Challonge and Chavaroche. In winter, owing to the hardness of the rock, the work is much easier than in summer, when it is more or less soft and sticky. It sometimes happens that the elasticity of the mineral cannot be overcome by gunpowder, in which case it must be hewn out with the pick. In the very hot weather, the miners work for only a few hours in the morning, before the rock has had time to soften under the influence of the sun. These remarks do not, of course, apply to the extraction of the rock from underground workings, where these obstacles are avoided by the unvarying low temperature of such workings. The blocks of mineral should never be piled up in high heaps, as in such a case an elevation of temperature would cause the undermost blocks to crumble to pieces, when, should the fragments become mixed with rain-water, the subsequent operations are much impeded.

The best European asphalt is lime carbonate (containing sometimes slight traces of silica) impregnated naturally with bitumen, in the proportion of about 7 or 8 parts of bitumen to 93 or 92 parts of the limestone. The mineral is found in layers interposed between beds of ordinary limestone, especially in the Upper Jurassic formation, and presents the following physical characteristics:—

Its colour is a deep chocolate, almost black. Its fracture also resembles chocolate in appearance and colour; it is granular and irregular, without any plane of cleavage; its colour is deeper according as it is worked in the direction of the stratification or perpendicularly to that direction; it is deeper and more floury in the first case, and drier and clearer in the second. Each individual mine has its own particular shade. In consistence, it varies with the temperature; it is very hard and sonorous when cold, but softens when heated, until at 120° to 140° F. it falls to powder. Its average sp. gr. is 2.235. Its structure varies in different samples.

Asphalt of the best quality may be known by the following conditions:—The grain is fine and homogeneous, and does not exhibit a particle of ordinary or white limestone. The rock is often lined with streaks of a darker colour than the rest, which give it very much the appearance of a tiger's skin. Other samples contain crystals of lime carbonate, impregnated with bitumen like the rest, sometimes of considerable size. All these varieties are perfectly good so long as they are completely penetrated by the bitumen. Bad qualities may be recognised as follows:—Sometimes the rock is regularly impregnated, but the proportion of bitumen is as low as 6 per cent., when it can be worked only with much difficulty. Sometimes the limestone is very hard and much cracked, the cracks being filled with bitumen, so that, when broken, the fracture appears brownish black, like the good samples, but when examined with the microscope, the impregnation is seen to be very incomplete. Samples of this kind are frequently met with in Auvergne. Sometimes the limestone, while it appears rich in

bitumen, contains clay, which, being impenetrable, spoils the homogeneity, and causes the fissures so often seen in streets paved with the material; the presence of clay in the sample is easily recognised. Some bituminous limestones, that of Lobsann,⁸ for instance, contain an oily principle besides the bitumen, which renders them greasy, and spoils the consistence of "mastic" made from it; this oil may be removed by distillation, after which the asphalt is fit for use. When asphaltic rock has been long exposed to the air, the bitumen on the surface dries up, to a depth of about .01 in. This desiccation, which is due to the slow evaporation of the bitumen, is sufficient to discolour the asphalt so much that it becomes similar in appearance to ordinary limestone; blocks of this kind, which are suspected to contain bitumen, must be broken up to ascertain the colour of the interior. This evaporation rarely extends farther into the rock than $\frac{1}{32}$ in.

Inferior asphalts, such as the bituminous limestones of Auvergne, contain clay, silica, magnesia, iron salts, &c. The Auvergne samples contain also traces of arsenic. As a general rule, it may be stated that samples of asphalt are valuable in proportion as they are free from these foreign matters. It is seldom necessary to make a qualitative analysis of asphalt, but it is often required to determine the proportion of bitumen. Following is a simple method. A quantity (about 200 grm.) of the substance is reduced to a fine powder, and dried by exposing it in a current of air heated to a temperature higher than 230° F., but not above 300°, since above this temperature the bitumen may be altered by the vaporisation of certain essential oils. After well mixing this powder, 100 grm. is taken and placed in a beaker; 100 grm. pure carbon bisulphide is then poured upon it, and the mixture is well stirred with a glass rod. After resting a moment, it is poured into a weighed filter, having another beaker placed beneath. More carbon bisulphide is poured upon the limestone remaining in the first beaker, well stirred, allowed to stand, and the clear portion is again added to the filter; this is continued until the powdered limestone is perfectly white, and the last portions of carbon bisulphide added exhibit no tinge of brown. The limestone is then dried whilst the liquid in the filter is running through. When perfectly dry, the limestone and the filter are weighed together, and after deducting the weight of the filter, the weight of the washed limestone is obtained, and, by difference, the weight of the bitumen removed by the carbon bisulphide.

The production of asphalt in Germany reaches 40,000–50,000 tons yearly, with a value of about 7s. 6d. a ton; that of Italy, 30,000–40,000 tons, worth about 20s. a ton; that of Spain, 200–600 tons at 7s. 6d. French statistics are comprehensive of all bituminous substances, which average about 200,000 tons per annum, estimated at about 5s. a ton.

The asphalt of Trinidad is found in a so-called "lake" (really a plain), situated about 100 ft. above the sea and about 2 miles from the sea-shore, at the village of La Brea ("Pitch"), 40 miles from Port of Spain. The area of the deposit is over 100 acres, and the depth ascertained by rough borings varies from 18 ft. at the margin to 78 ft. in the middle. On this basis, the deposit must contain some

millions of tons, and certainly the removal of nearly a quarter of a million tons has not appreciably lessened it. The deposit appears as a level tract of brownish material having an earthy appearance. Cracks or fissures, having a width and depth of a few feet, appear here and there over the surface; some are filled with rain-water, others with soil blown there by the wind and giving support to a scrubby vegetation.

Travellers have reported that the deposit is liquid in the middle, but such is not the fact. Carts and mules can be driven everywhere on its surface. The material is dug with a pick and shovel, loaded into carts, and hauled to the beach. Here it is placed in baskets, which are carried by coolies wading through the surf to lighters, and from these lighters it is loaded on vessels. During the voyage the material unites into a solid mass, and has to be removed again by the use of the pick and shovel. On being unloaded, it is placed for about 5 days in large tanks heated by a slow fire. The moisture is expelled, the roots of trees and other vegetable matters are skimmed off the surface, the earthy matter with which it is combined settles by gravity, and the refined product is run off into barrels. This refining is in reality a mere heating to a liquid condition, in order to allow the sediment to deposit; and great care is taken not to heat the material to a point which will in any way change its chemical condition, or produce distillation.

The crude asphalt has the following properties: sp. gr. 1.28; hardness at 70° F., 2.5 to 3 in Dana's scale; colour, chocolate brown; analysis:—

Bitumen	39.83
Earthy matter	33.99
Vegetable matter	9.31
Water	16.87
	<hr/>
	100.00

The earthy matter consists mostly of clay, and the rest is very fine sand. The refined asphalt has the following properties:—sp. gr. 1.49; hardness at 70° F., 2.5; colour, black; breaks with a conchoidal fracture; burns with a yellowish-white flame, and in burning emits an empyreumatic odour; analysis:—

Bitumen (by CS ₂)	59.86
Earthy matter	35.82
Vegetable matter	4.32
	<hr/>
	100.00

An analysis of the pure bitumen dissolved out by CS₂ gave

Carbon	85.89
Hydrogen	11.06
Sulphur	2.49
Unknown, possibly oxygen	0.56
	<hr/>
	100.00

After treatment with petroleum residue, in order to make asphalt paving cement, the bitumen soluble in CS₂ varies from 68.5 to 70 per cent.

The approximate cost of the crude product per ton delivered f.o.b. is 13s., made up as follows:—rock, 5s.; cartage, 4s.; boating, 3s. 3d.; export duty, 9d. The annual shipments are about 90,000 tons crude and 10,000 tons *épurée* (purified), about 10 per cent. of the former and 90 per cent. of the latter coming to Europe. The selling prices in 1892 were 28s. 6d. a ton for crude, and 58s. 6d. for pure, f.o.b.

The bituminous sandstone of California is found in large quantities at various points between San Francisco and Los Angeles. It contains about 12 to 18 per cent. of bitumen, and the rest is quartz sand, in grains about $\frac{1}{10}$ in. diam. The material is sufficiently soft to yield to the heat and pressure of the hand. Within the last few years it has come into use for paving purposes and coating iron pipes on the Pacific coast. The rock is quarried, broken to fragments of about 2 in., heated in kettles by steam (which causes it to fall into powder), and then, while still hot, taken to the street and compressed by rolling or tamping. Reports as to its quality as a paving material are conflicting.

In 1888 a large deposit of bituminous rock containing an unusually large percentage of asphalt was discovered in Ventura county, California. This mineral contains 24 per cent. of bitumen, the other constituents being silica (about 64 per cent.), iron oxide, and calcium carbonate. Its high percentage of bitumen increases its value, and the price ranges from 32s. to 2l. per ton, while the bituminous rock of San Luis Obispo and Santa Cruz is valued at about 10s. per ton at the mines. Deposits of a nature similar to the Ventura product are also being operated in Santa Barbara county.

The Ventura mine is situated 5 miles from San Buenaventura. The lode presents an excellent illustration of the general character of the asphalt deposits of the locality, which are true fissure veins in a mass of grey silicious clay. It was indicated on the surface by a mere seam 7 to 15 in. thick; but when stripped it was found to increase rapidly, both horizontally and downward, so that at the depth of 66 ft. from its surface cropping and 60 ft. horizontally from the same, its thickness is 5 ft., and the material has improved in quality. The strike of the vein is 30° N.; its pitch, 65° to 70° , S. 30° W.

While going in upon this vein for 100 ft. in an open cut, it was found to expand into several "pockets" of 7 to 16 ft. diam., from which great masses of material were extracted; the whole output from this cut alone was 1400 tons. At one point a wall of the "ore" appeared sideways overhead. This proved to be a "spur" vein joining the other at an oblique angle, with a thickness of 3 to 4 ft., increasing to 6 ft. of clear asphalt about 90 ft. from the entrance of the cut.

The spur vein was found to expand into a huge pocket, which, when mined out, formed an irregular chamber about 30 ft. square by 12 to 15 (at one point 30) ft. high, from which 450 tons of material were obtained.

The variability of thickness and the tendency to the formation of "pockets," introduces an element of uncertainty which, fortunately, seems generally to run in the direction of an increase of mass. This

sporadic expansion into large masses appears to be a characteristic of these asphalt veins; and the regular vein body itself, as a rule, increases downward.

The material is a brownish black, uniform mass, of conchoidal fracture; yielding somewhat under light blows of the hammer, but splintering under heavy ones, so that it can readily be blasted. The sp. gr. is about 2. On heating to about 450° F. it softens into a mushy condition, but does not attain fusion without the aid of some "fluxing" or thinning substance. An attempt to replace the somewhat tiresome process of drilling blast-holes by the use of hot iron bars failed to give satisfactory results.

Assays show that the total bitumen fixed at 212° F., while ranging within the several veins from a minimum of 15·28 per cent. to as much as 22·75 per cent., will in each case, on the average, be close upon 20 per cent.—generally above. The fixed residue or ash is in all cases a silicious clay, usually containing but little sand and about 3 per cent. of lime carbonate; occasionally occur streaks, or "horses," in which is a notable admixture of either coarse sand or nests of peculiar gravel hardened by lime carbonate, gypsum, and iron pyrites. At some points the floor clay, or footwall, is so strongly imbued with bitumen that, while inferior in quality to the vein mass, it can nevertheless be profitably used for certain purposes.

There are several deposits of bituminous rock in San Luis Obispo and Santa Cruz counties, in which the peculiar features of asphalt formations are strikingly illustrated, clearly showing that they belong to no particular era or age; they are found at various altitudes, and with no uniform character in appearance, hardness, or chemical composition. Deposits of solid asphalt and springs of viscid, oily material, commonly called "brea," occur in places not 1000 ft. apart, and yet in strata of unquestionably different periods of formation. The bituminous rock of San Luis Obispo and Santa Cruz is a sandstone thoroughly impregnated with bitumen. It is used almost entirely for street paving, and for that purpose is probably more easily and cheaply prepared than any of the asphalt products. The only treatment necessary is to steam it, so as to thoroughly mix its ingredients and soften it for spreading to a uniform thickness and a smooth even surface. Analyses gave:—

Sand.. .. .	65·917
Bitumen	16·255
Iron and alumina	8·405
Calcium carbonate.. .. .	8·212
Magnesium carbonate	1·003
Undetermined	0·208

100·000

An important deposit is worked in Uintah Valley, about 100 miles from Price, Utah. The vein is described as a regular fissure, cutting across the country for 12,000 ft., or more, in length, and 3 to 4 ft. thick. It has been opened by 14 shafts or pits, aggregating 700 ft. in depth. The surface-portions of the mineral are fissured and cracked by weathering, are more or less contaminated with sand and earthy matters, and are regarded as of second quality, while the portions below are com-

fact and pure. The mineral is obtained in masses several inches in diam., and apparently free from mechanically disseminated impurities. It breaks with a conchoidal fracture, is very brittle, and is readily reduced to powder in a mortar. Hardness, 2 to 2.5. Sp. gr. 1.065 to 1.070. Colour, black, brilliant, and lustrous; streak and powder, a rich brown. It is a non-conductor of electricity, and is electrically excited by friction. Analysis gives:—

Carbon	78.43
Hydrogen	10.20
Nitrogen	2.27
Oxygen	8.70
Ash	0.40

100.00

Soluble as follows: carbon bisulphide and chloroform dissolve it completely; benzol dissolves 95 per cent.; ether, 86.5 per cent.; absolute alcohol, 9.5 per cent.

The output in 1892 was about 1500 tons, which found a ready market at 10*l.* a ton in St. Louis. Mixed with turpentine in the proportion of 1 lb. to 5 pints turpentine, and heated, it makes an excellent japanning varnish.

The total production of American asphalt is now about 40,000 tons a year, worth 21*s.* a ton.

A variety of bituminous substances, from pure hard asphalt to fluid petroleum, exist in immense quantities along the coast of the Gulf of Mexico, chiefly in the States of Tamaulipas, Vera Cruz, and Tabasco, but there has been no organised effort to utilise the deposits. Almost inexhaustible beds of asphalt exist on both banks of the river Thamesi, about 60 miles above Tampico, in a comparatively pure state, and containing only an insignificant proportion of foreign matter. Asphalt, or *chapotote*, as it is called in Mexico, is frequently found floating in masses on the rivers and lagoons, and is cast up on the beach by the waves all along the Gulf Coast, and especially in the vicinity of Tuxpan, and on the Grijalva river in Tabasco, and sold at the rate of 8*s.* to 9*s.* per cwt.

In many other places asphalt occurs, and is used locally as fuel. This is notably the case in Cuba.

When the bituminous matter is to be sold as pitch, it requires to undergo some purification. Usually, this takes the form of melting in boiling water, by which the pitch is made to float and may be skimmed off and poured into moulds, while the sandy matters have a tendency to collect at the bottom of the vessel. If the earthy matters are very fine-grained, their superior specific gravity is not conspicuously exercised, and repeated meltings may be needed to effect anything like complete removal of impurities. Sometimes boiling shale oil is employed as a substitute for the hot water, especially if the crude pitch contains much water, as by this means separation of both earthy matters and moisture is accomplished in one operation.

The chief consumption of asphalt is for paving purposes, either alone or in conjunction with gritty materials. It is claimed that the bituminous sandstones afford a better foothold for horses than the bituminous limestones, as they never wear so smooth. Much so-called "asphalt" is simply coal-tar concrete.

BORAX.

THOUGH the term "borax" is properly applied only to minerals consisting essentially of soda baborate, it forms a convenient heading for the whole class of boracic products, more especially as their uses are practically identical.

While there are many minerals which contain more or less boracic acid in various combinations, commercial supplies are obtained only from about half-a-dozen, chiefly as follows:—

Borax or tinkal, soda baborate, $\text{Na}_2\text{O}, 2\text{B}_2\text{O}_3 + 10\text{H}_2\text{O}$, containing 36.65 per cent. of boracic acid.

Ulexite or boronatrocalcite, calcium-sodium borate, $\text{NaCaB}_2\text{O}_6 + 5\text{H}_2\text{O}$, containing 49.7 per cent. boracic acid.

Priceite, calcium borate, $4\text{BO}_3, 3\text{CaO}, 6\text{HO}$, containing about 49 per cent. boracic acid.

Pandermite, calcium borate, $2\text{CaO}, 3\text{B}_2\text{O}_3, 3\text{H}_2\text{O}$, containing 55.85 per cent. boracic acid.

Stassfurtite, magnesium borate, $2\text{Mg}_3\text{B}_5\text{O}_{15} + \text{MgCl}_2$, containing 60.75 per cent. boracic acid.

Sassolite, boracic acid, H_3BO_3 , containing 56.45 per cent. boracic acid (anhydrous).

The tinkal trade of Central Asia is very remarkable. The borax does not effloresce on the upper surface of the soil; the upper efflorescence consists principally of soda sesqui-carbonate and sulphate, with more or less chloride. Under this is the borax, which appears as a greasy greenish-yellow substance, never exceeding 2 or 3 in. deep, and is underlaid by a deposit of inferior material.

The borax and salt fields of Gnari or Hundes, in Thibet, lie to the north of Bongbwa Tal, in the eastern part of the Zjang of Rohtoh (Rudukh), and at the Chapakani lake. The two salts are obtained from different spots in the same vicinity, and are both worked in the same way by lixiviation from the earth taken from the surface of the ground in which the salts are developed by natural efflorescence. These salt-fields are open to all who choose to adventure their labour in them on payment of one-tenth of the produce to the Lhasa Government, who have an excise establishment on the spot. The borax is collected from June to September and sold at the different fairs, at Ganpa, Gartoh, Sibilam, Chajna, Taklakhar, Dabakhar. It is brought down by the Bhotiya traders and purchased by the merchants of Ramnagar, where it is refined. The transport is an exceedingly arduous and hazardous undertaking, mostly performed by pack-sheep.

The refining process is as follows:—The tinkal is pounded, placed in shallow tubs, and covered with water to a depth of a few inches; to this is added a mixture of about 2 lb. lime in 2 pints water, for every 10 maunds (820 lb.) of tinkal, and the whole mass is well stirred

every 6 hours. Next day, it is drained on sieves or cloth, and after this is again dissolved in $2\frac{1}{2}$ times its weight of boiling water, and about 16 lb. lime is added for the above quantity. It is then filtered, boiled down, and subsequently crystallised in funnel-shaped vessels, usually of *kansa*, an alloy of copper and zinc or lead. The loss in weight is about 20 per cent. The yearly contribution to European supplies is about 500–1000 tons.

A great deal of adulteration takes place among the native dealers, to the detriment of the reputation which this article has always had among potters.

The American sources of borax have latterly come into prominence. The depressed alkaline plain, known as the Great Basin,* contains, along the Nevada-California border, and in California, at least ten boraciferous "salines" or marshes. These marshes are the old beds of relatively restricted lakes, which received boracic water, probably from hot springs. Volcanic phenomena are abundant in the region, and were doubtless the principal stimulating cause. Borate of lime and soda (ulexite), borate of lime (priceite), and borate of soda (borax) are all found, and always mingled with dust, and more or less gypsum, sodium carbonate, sodium chloride, sodium sulphate, and various other alkaline salts. Artesian wells have shown standing water at no great depth in some of the marshes, and in at least one instance it is charged with borax. The crust of borax is often renewed on the surface after it has been removed, and after an interval of 3 or 4 years may be gathered again. This is due to capillary attraction through the pores of the underlying soil.

The best known of the salines in Nevada are Teel's Marsh, Columbus Marsh, Fish Lake Valley, and Rhodes Marsh, all in Esmeralda County. Although the marshes cover thousands of acres, the portions productive of borax are comparatively limited.

There is a minor deposit at Salt Wells, in Churchill County, Nev., and in California there are three marshes in Inyo County—the Saline Valley (said to be the largest of all), the Amargosa, and the Furnace Creek; one in San Bernardino County, the Slate Range or Searle's Marsh; and one, of less present importance, at Little Borax Lake, Lake County. The last named is north of San Francisco. Borax is also shown by analysis to be present in the water of Owen's Lake, and boracic acid is found in the water of Mono Lake to the extent of .16 grm. per litre. The total American output is about 5000 tons yearly.

Great quantities of borax crystals have been dredged from some of these lakes, in addition to the product obtained by boiling the water to crystallisation. A "fissure vein" 7–10 ft. thick, carrying calcium borate, is being mined near Calico, San Bernardino County, California.†

Refining the crude borax consists in collecting the material from the plain, by simply shovelling layers of the surface to a depth of 18 in., and loading it into waggons provided with wide tyres to the wheels. Below the surface of the marsh at a depth of 4 ft., liquor is

* C. Napier Hake in *Jl. Soc. Chem. Ind.*, viii. 854.

† Report State Mineralogist, 1893, p. 345.

found highly impregnated with borax. The material is hauled to the refining works, which are conveniently situated upon firm ground at the edge of the marsh, and where the next step consists in dissolving in water all the soluble matter in the crude material. For this purpose wrought-iron pans are used, about 35 ft. long by 7 ft. wide, semicircular in shape, set on arches of stone, beneath which are furnaces and flues for heating the contents of the pans. The crude borax is thrown into the pans, and with the aid of long poles is vigorously stirred until all that is soluble is dissolved; the liquor is then allowed to settle for some hours, and when perfectly clear is drawn off into round tanks made of light galvanised iron, where the borax crystallises on cooling. When the crystallisation is complete, the "mother liquor" is drawn off, leaving only the crystalline borax, which is removed and packed into sacks for commerce. The total cost of production is said not to exceed 5*l.* a ton.

There is no difficulty in refining crude borax, but with ulexite it is a different matter. This can be changed to sodium borate by boiling with sodium carbonate, but losses ensue from the reaction being incomplete, so that various other processes have been devised. Steam, when superheated and passed over ulexite, volatilises the boracic acid and yields sassolite. In the Formhals process the fumes of burning sulphur are introduced into a hot emulsion of ulexite in water: sodium sulphite and sassolite are yielded. In the Robertson process there are conducted into a similar emulsion the fumes which are employed in the usual manufacture of sulphuric acid. In the Gutzkow process the ulexite is first treated with sulphuric acid, and then the gypseous residue is distilled with superheated steam. But by whatever process the solution of borax is procured, some precautions in obtaining its crystals are necessary. Thus, borax ($\text{Na}_2\text{O}, 2\text{B}_2\text{O}_3 + 10\text{H}_2\text{O}$) crystallises best when an excess of sodium carbonate is added to the solution, equal in amount to 5 per cent of the resulting borax. But if the excess be too great, the neutral borax ($\text{NaBO}_2 + 4\text{H}_2\text{O}$) results. Further, if the hot solution exceeds 24° – 28° B., octahedral borax ($\text{Na}_2\text{B}_4\text{O}_7 \cdot 5\text{H}_2\text{O}$) is formed. For large crystals, slow cooling in capacious vats is necessary. For small crystals, small vats, which are kept in agitation, are best. Iron tanks are undoubtedly preferable.

As to the relative merits of the various processes referred to in the last paragraph, it may be observed that by the use of hydrochloric or sulphuric acid, a pure boracic acid is easily obtained, which with soda gives fine clear lyes. The voluminous slimes of calcium carbonate are done away with, because when hydrochloric acid is used calcium chloride is formed, while when sulphuric acid is employed calcium sulphate is produced, forming a heavy precipitate which settles to the bottom. Furthermore a considerable saving of soda is effected, because a large part of the soda used in direct boiling is required for the conversion of the calcium sulphate into calcium carbonate. But there are just as weighty grounds against this method of manufacture. In the first place we must consider the

wear of the factory when acids are used. A second reason is the volatility of the boracic acid with steam, which causes considerable loss, and finally soda is so cheap and pure that an increased consumption is of no great importance. The great point in adopting the simple boiling with soda carbonate is to leach in boiling water the lime-cakes from the filter presses.*

Boronatrocalcite is found in inexhaustible deposits on the high plateaus of the Cordilleras in northern Chili. It is mined at Maricunga, Pedernal, and Acostan, and these places supply almost all the calcium borate which is shipped to Hamburg *via* Antofagasta. The borates which are brought from Rosario (Argentine Republic) are also mined near Acostan, from a deposit at Tecuman on the Argentine side of the Cordilleras. This boronatrocalcite contains 18 to 24 per cent. anhydrous boracic acid, the higher grade being worth about 18*l.* a ton. Chilian exports of borax range from 30 to 3000 tons a year, and of calcium borate from 3000 to 6000 tons annually.

Pandermite occurs in a bed occupying over 13,000 acres, near Panderma, Asia Minor, and is being extensively worked. The field is situated in a basin of Tertiary age, surrounded by volcanic rocks, which vary from granite on the east to trachyte on the north, and columnar basalt on the west. Several basaltic hills and dykes protrude in different portions of the basin, and the presence of hot and mineral springs further testifies to the volcanic influences which have been at work, and in which, doubtless, originated the boracic mineral. The latter occurs in a stratum at the bottom of an enormous bed of gypsum, its greater specific gravity probably impelling it downwards while the whole mass was yet in a soft state. Several feet of clay cover the gypsum bed, which is here 60-70 ft. thick, though in places it attains to double that thickness.

The boraciferous stratum varies in depth, it has been proved for a vertical distance of 45 ft. The mineral exists in closely packed nodules, of very irregular size and shape, and of all weights up to a ton. It can be applied directly in place of borax, and is more economical. The yearly output is about 8000 tons.

The boracic acid lagoons of Tuscany have been repeatedly described. They occur in a volcanic district of limited extent. The most abundant supplies are obtained from artesian wells, which invariably strike the boracic vein at a short distance from the surface. The boring, however, is carried down until the well yields water, when the machinery is withdrawn, and water is let into the shallow pond previously dug around the bore hole. This water very soon becomes heated up to boiling point, and impregnated with the boracic acid, which rushes up from the opening of the artesian well, after which the water is drawn off and evaporated by passing it over a series of 15-20 shallow metal pans, arranged like a cascade. The boracic acid as it reaches the bottom pan is half solidified, and when cold, has the appearance of being frozen over with a skin of rotten ice. This skin is removed and strewn on the floor of a drying-house heated by hot pipes, and by this means the boracic acid becomes

* See also Spons' 'Encyclopædia.' p. 526.

crystallised. The lagoons have a most peculiar aspect during the issuing of the boracic vapours. When full of water, the boiling is continuous, rising to some feet in height, but the vapour is quite clammy and unpleasant from its sulphurous odour. The production is about 3000 tons of crude boracic acid per annum, containing 84-89 per cent. of crystallised, or $46\frac{1}{2}$ - $50\frac{1}{2}$ per cent. of anhydrous boracic acid, worth 25*l.* a ton, in addition to 1000-2000 tons of borax

BROMINE.

THIS substance is not met with in the free state in nature, but always in combination as bromides, notably as magnesium bromide. Bromides are present in small quantity in all sea water, but the chief sources of the European supplies are the kainite beds of Stassfurt. The raw salts are dissolved in water, and when the potash and soda chlorides have crystallised out, magnesium bromide remains in the mother liquor. Through this liquor a current of chlorine gas is passed, and the bromine is distilled off.

The brines produced in the salt regions of West Virginia and Pennsylvania, in Midland County, Michigan, and in the Tuscarawas Valley and Pomeroy, Ohio, contain so large a proportion of bromides that it is profitable to save them and prepare bromine as a by-product. All the bromine produced in the United States comes from these sources. The bromides in the brine are concentrated in the bittern during the process of salt manufacture. The bittern, at a specific gravity ranging from 35° to 42° B., is treated with sulphuric acid and black oxide of manganese (pyrolusite), the amount of reagents used being dependent upon the percentage of bromides in the bittern. The sulphuric acid combines with the base of the bromide and forms hydrobromic acid; the latter is oxidised by the pyrolusite with the evolution of bromine gas, which is collected and condensed in suitable vessels. In Michigan, potassium chlorate is the favourite oxidising agent, because of the large proportion of calcium chloride in the liquor. A detailed and illustrated account of the manufacture will be found in Spons' 'Encyclopædia.'

At the places named the bittern is very rich in bromides, the estimate being that for every 2 barrels of salt 1 lb. of bromine should be made. This, however is not strictly correct, as it differs in different localities and at wells in close proximity. The material at every salt well where bromine can be made is now worked, and the production is as large, probably, as it will reach, unless salt should be found in other places containing it.

The annual production amounts to about 400,000 lb. in America, 400,000 lb. at Stassfurt, and 300,000 lb. in Scotland and Ireland from seaweed. The trade is in few hands, and the price is about 9*d.* a lb.

CEMENT.

CEMENTS are a group of mineral substances consisting essentially of argillaceous magnesian limestone or of mixtures of clay and lime, which, after calcination, possess the property of hardening in contact with water, this property being due to the crystallising energy developed by combination of water with the silicates of lime and alumina formed by the calcination.

It is usual to divide cements into two classes, Roman and Portland, the former being derived from natural rocks and the latter from artificial mixtures, but inasmuch as some Portland cements are now made from natural rocks, a better classification is "natural" and "artificial."

Natural hydraulic cements are made from (a) nodules of calcareous clay called "septaria," found in clay beds of Lower Eocene age (Tertiary), and from (b) argillo-magnesian limestones occurring abundantly for the most part in Upper Silurian rocks. The analyses given on the next page illustrate the divergence in their composition. All but the two last (from Lehigh Valley) contain much magnesia and are made into Roman cement. The Lehigh rocks afford Portland cement.

The process of manufacture consists in quarrying and breaking the rock, calcining in kilns, which are usually continuous in operation, and grinding. The burning is light, and usually not strong enough to expel all the carbonic acid in the rock. The cement until ground is simply a mass of partially vitrified clinker, which is not affected by water. It is only after it is ground that the addition of water induces crystallisation of the silicates formed by calcination. The degree of fineness is wholly a matter of economy. Coarse particles will have no "setting" power, and may for practical purposes be considered as so much sand. The usual demand of fineness is that 90 to 95 per cent. shall pass through a sieve of 2500 meshes to the square inch. Colour is not now regarded as of much importance, except that a yellowish tinge may indicate insufficient burning. Colour is chiefly due to iron and manganese oxides.

If the rock contain too great an excess of clay, the resulting cement will be quick-setting, soon attaining its maximum hardness. Such cements have but limited tensile strength and deteriorate by age. In burning such stone, a heat hardly sufficient to drive off the carbonic acid can be used: if greater, a slag is the product. If the limestone contains an excess of lime to clay, a greater heat is required, and when such cement is used it swells, and if water is allowed to act upon it *in situ*, the free lime hydrate washes out, thus weakening the mortar. What is required is a stone in which the lime and clay are in such proportion that when burned they will chemically react on each other, forming silicates and aluminates of lime. Such a natural

BRITISH NATURAL CEMENT ROCKS.

	Calderwood.	Sheppy.		
Carbonic acid	34.30	31.00	29.00	22.75
Silica	8.80	18.00	17.75	9.38
Alumina	3.40
Iron	10.20	5.25	6.00	17.73
Lime	30.24	30.20	35.00	29.25
Magnesia	6.76	0.20	0.50	7.50
Alkalies	4.20	5.50
Water	2.00	..	3.00	4.00
Manganese	6.75	1.00	..
Totals	99.90	96.90	92.25	90.61

AMERICAN NATURAL CEMENT ROCKS.

	Rosen- dale.	Rosen- dale "Light."	Utica.	Milwau- kee.	Fort Scott.	Georgia.	Lehigh Valley.	
Lime carbonate	45.91	50.82	42.25	45.54	65.21	43.50	78.92	67.14
Magnesia carbonate	26.14	17.74	31.98	32.46	10.65	22.00	2.66	2.90
Silica and insoluble	15.37	22.66	21.12	17.56	15.21	22.10	11.62	18.34
Iron sesquioxide	11.38	2.39	1.12	3.03	..	1.80	6.25	7.49
Alumina				1.41	4.56	5.45		
Lime sulphate	4.37
Manganese oxide	0.55	0.22	..	0.19
Potash and soda	traces
Organic matter	0.99
Water	1.20	..	1.07	4.93	..	3.94
Undetermined		0.48	2.46	..	4.37	..	0.55	
Totals	100.00	100.00	100.00	100.00	100.00	100.00	100.00	100.00

combination is seldom found, but it can be very nearly approached by mixing different rocks and burning them together at as great a heat as possible.

The plant requisite to manufacture natural cement is of simple construction. The kilns are similar to lime kilns, but generally much larger. The mill, preferably situated on a side hill, has the rock breakers and rolls of a quartz mill, with the stones and packing appliances of a flour mill. The burned rock should come in at the top of the mill, to save handling, and be conveyed by spouts through its various gradings into the packing machine or barrel.

A mill to reduce 100 barrels of burned rock to powder will consist of one rock-breaker, one set of rolls, and two sets of stones. The capacity of one set of 4-ft. stones is about 60 barrels a day of 10 hours. This plant would require about 60 H.P. The cement, when ground, should be of such a fineness that 95 per cent. will pass through a 50-mesh screen.

The kilns are about 30 ft. high, of cylindrical form: at the top, 9 ft. diam.; 3 ft. down, 8 ft. 6 in. diam., then widening at 20 ft. to

9 ft. 6 in., then contracting for the next 7 ft. till top of pit is reached to 3 ft. The discharge is 3 ft. high by 2 ft. 6 in. wide. The kiln is lined for the first 12 ft. from the top with firebrick, the remaining distance with well-burned common brick. Coke, anthracite, or semi-bituminous coal can be used.

The kiln is fired up by placing about 3 ft. of cordwood in the lower portion of the kiln. Overlying the wood, a thick layer of rock is placed for about 1 ft., then a thin layer of coarse coal, and from there up alternate layers of coal and rock. This coal or coke should be broken up quite fine. After the kiln is running smoothly, 1 ton of coal will burn about 13 tons of rock, or 55 to 57 barrels of 300 lb. each. The size of the stone should not exceed 6 in. any way. The kiln is drawn at the bottom twice every 24 hours, raw stone and fuel being added at top after each drawing.

Natural cement should weigh 49 to 56 lb. per cub. ft., and set in 2 to 30 minutes. It should give a tensile strain of over 85 lb. when immersed in water 7 days, showing a gradual increase up to one year or even longer.

Artificial cement is made from mixtures of clay and some form of lime carbonate, usually chalk. It is practically a double silicate of alumina and lime. There are three methods used in Europe to reduce the raw material to the required degree of fineness, known as the "wet," "semi-wet," and "dry" processes.

The "wet" method is principally used on the Thames and Medway. The chalk is first passed through rock-breakers and then ground wet in Chili mills, from which it is passed to the wash mills, where the requisite clays and water are added. The wash mills are large circular tanks with arms or racks revolving in them. Through this agitation the combined materials are thoroughly incorporated, and rendered about the thickness of cream. From the wash mill the mass is allowed to flow to the reservoirs. After the "slum" or "slurry" has settled, the water is drawn off, and the residual "slurry" is allowed to evaporate till it becomes a thick mud. From these reservoirs it is carried to the dry floor, where all remaining water is expelled, and it is then broken in pieces the size of a brick. The great disadvantages of this process are (a) the limestone and clay being of different specific gravities separate from each other, (b) large areas of land are required for reservoirs, (c) excessive labour in handling and re-handling, (d) the time from the first manipulation of the raw material till it is ready for kilning is months. Nevertheless it continues to be used by many of the original works.

In the semi-wet method the chalk and clay mixture is passed through the wash mill with as little water as possible, and after being intermixed, is conveyed to millstones, from which it flows to the drying plates, where it is dried and is then ready for the kiln. Even by this process large areas of dry floors are required, as well as labour, time, and fuel.

In the dry method, the dry raw materials are mixed in their correct proportions, passed through rock-breakers which feed rolls, and from here the yet coarse powder is conveyed to millstones, by which it is reduced to such a fineness that 80 per cent. will pass

through a 100-mesh screen. From the stones it is elevated to bins, whence it is carried by double conveyors to pug mills.

During this passage to the pug mill sufficient water is added to make the particles firmly adhere together. From the pug mill it is carried to the dry house, and is ready for the kiln in 24 hours.

In place of "pugging," the mixture has a little water added, and is conveyed directly to a dry brick press, from which it comes ready for the kiln.

The advantages of the "dry process" are (a) the rapidity with which the materials can be combined ready to burn, (b) the saving of labour is about two-thirds, (c) there is a certainty that the different materials have at no time become separated, hence an unvarying product, and (d) less ground is required for works.

The original cost of a dry plant is greater than for a wet, which, however, is amply compensated for by the rapidity of production, not having, as in the "wet process," to wait on a half finished product for which labour has been paid.

Of other processes for the reduction of the raw material, the only one worthy of notice is "double-kilning." The hard limestone is first burned to quicklime, then sufficient water is gently sprinkled over it so that it slakes and yet remains a perfectly dry powder; the lime powder is mixed with clay or ground shale, and then burned.

The kilns principally used in England ("dome kilns") internally are in the form of an elongated egg, or two frustrums of cones, base to base; in height, 30 to 60 ft.; in widest diameter, 9 to 18 ft. One 40 ft. high would have about the following dimensions: At the top, 8 ft. diam.; from top to 17 ft. down it widens to about 12 ft.; for the next 14 ft. (31 ft. from top) it contracts to 8 ft.; from there to the grate bars (36 ft. from top) the diameter is 6 ft. The ashpit or draw-hole is about 4 ft. high. The lining throughout is firebrick.

The mode of burning in this kiln is simple. Wood is placed on the grate bars, 2 ft. high; then a layer of coal, on which alternate layers of coke or hard coal and dry lumps are arranged. The proportion of coke to material decreases from bottom upward. About 10 per cent. of the weight of the raw material of coke or anthracite coal is requisite to burn such a kiln.

These kilns are intermittent. When once lighted they burn till all the fuel is exhausted. The reason is that the material being burned at such a high heat, the cement clinker adheres so strongly to the sides that it is impossible to draw it all from the bottom without first loosening it from the sides.

Clinker of a brown colour, which when taken from the kiln dusts excessively, producing a soft, smooth-feeling powder, contains an excess of clay, is weak in indurating capacity, and will contract after being used. Much less fuel is required to burn it.

Clinker of a black colour, which does not dust when taken warm (not hot) from the kiln, and, when powdered, has a bluish cast, contains an excess of lime. If not great, it can be purged of this dangerous quality by spreading it out on floors till the excess of free lime has become neutralised by the action of the air, and can then be used without danger. But if the excess of lime is very great, no

exposure will eradicate it. To manufacture such a cement is expensive: it takes large amounts of fuel to clinker, and time is lost by the long exposure required.

If there has to be an excess of lime or clay, it would be better for the manufacturer to have a *slight* excess of lime rather than an excess of clay.

The powder of a normal or perfectly combined clinker should, when freshly ground, be of a grey colour, tinged with green, losing much of its green cast after exposure for a few days; it should be granular in character when finely ground, and should at no time have a smooth or silky feel.

Many cements contain an excess of lime sulphate, derived either from a contamination of the limestone with gypsum, or the result of the oxidation of the sulphurets that existed in the clay or shales, or due to the sulphur that is always present in a greater or less degree in the fuel. This lime sulphate is detrimental to a cement, and should not be tolerated in appreciable amounts. Over $1\frac{1}{2}$ per cent. sulphuric acid, or $1\frac{1}{2}$ per cent. carbonic acid, or 1 per cent. magnesia, is very objectionable.

A convenient source of lime carbonate for cement-making is the "lime mud" forming a waste product in alkali manufacture. It is worked by J. S. Rigby's patent.

The consumption of fuel for cement-burning, per ton of clinker, is thus stated:—

For open or chamber kiln	$4\frac{1}{2}$ to $6\frac{1}{2}$ cwt. coke.
„ Hoffman kiln	$3\frac{1}{2}$ „
„ Dietzsch kiln	2 to 3 cwt. small coal.

Continuous kilns of the Dietzsch type, in which the materials and coal are charged in at the top while the burned clinker is withdrawn at the bottom, are coming into general use, and proving very economical of fuel. Duryce's revolving furnace using crude petroleum as fuel, is favoured in America.

CLAY.

THE characteristic property possessed by the mineral substances which are classified under the term clay is plasticity, due to hydrous alumina silicate. The purest clay is known as kaolin, or china clay; it is composed of minute particles loosely aggregated, resembling (when magnified) fish-roe in appearance, and starch globules in physical qualities. The crystalline components of clay are generally designated as sand, and consist of fragments of different mineral species, such as quartz, felspar, mica, hornblende, tourmaline, magnetic iron, &c. These crystalline substances may be found in particles not much larger than the globules of kaolin proper, and thus remain suspended with it in water, while the coarser sand settles quickly, and may be separated from the kaolin and the finer crystalline materials. The contamination of kaolin with these fine crystalline particles gave rise to the erroneous deduction that kaolin itself had a crystalline structure.

Other compounds present in clays, which have an important bearing in determining their economic value, are iron pyrites, lime sulphate, lime carbonate, dolomite, carbonaceous and bituminous matter, iron oxide, &c. To these are due the various colours which characterise ordinary clays, and which vary in their effect upon the material when it is applied for technical purposes.

Disintegration of the primitive rocks, and the rocks that were again formed from them, going on through millions of years, has resulted in a deposition of vast amounts of clays of more or less purity. They occur in beds of varying thickness, and follow the stratification in dip and strike of the underlying rock. These primary deposits of clay have been rearranged many times by subsequent geological changes, which have sometimes resulted in the purification of the clay mineral proper, and at other times in its degeneration.

The power to pass into a plastic state decreases in proportion as a sandy element is mixed with the clay. It is strongest in the "fat" and weakest in the "lean" clays. A "fat" clay dries very slowly and unevenly, and warps and cracks in drying. Equivalent quantities of different fluxing oxides produce the same effect upon the fusibility of a clay; for example, if analysis shows that a certain clay contains magnesia .3 per cent. and that another contains potash .7 per cent., we may expect with certainty that both will have the same resisting power to the action of fire. The presence of these several substances in the clay does not influence the effect produced by each singly, their fusibility increasing only with the higher sum of their combining weights.

Brick Clay.—Ordinary yellow brick clay contains iron as oxide and as carbonate chemically combined with water in the form of hydrates. The expulsion of this water in the process of burning

imparts a red colour, due to the conversion of the hydrated oxides of iron into the anhydrous form. The principal constituent of brick clay, and that upon which its plasticity depends, is silica. This constituent used alone shrinks and cracks in drying, warps and becomes very hard when baked. Silica is also present in nearly all clays in an uncombined state, such as sand. A proper proportion of sand prevents cracking, shrinkage, and warping, and furnishes silica necessary for a partial fusion of the materials, which increases the strength of the brick. The sand also makes the brick more shapely and equable in texture; but an excess of sand in clay renders the brick made from it too brittle. A small quantity of lime carbonate has a beneficial effect upon brick clay in two ways—it lessens the contraction of the newly made bricks in drying, and acts as a flux in the kiln by the formation of lime silicate, which binds the particles together. It is evident from this that excess of lime carbonate in the clay would cause the brick to melt and lose its shape. Iron pyrites in a brick clay is objectionable; also the presence of carbonaceous matter to any extent, as a black discoloration is likely to occur. Common salt is nearly always present in minute quantities in clay. In that near the seashore the amount is apt to be so great that bricks made from it are of poor quality. Salt melts readily and glazes the outside of the bricks, and the heat cannot be raised or maintained sufficiently long to burn them to the core, or into good, hard brick; as a consequence, they are soft and, from the presence of the decomposed salts of magnesia and soda, are always damp, owing to the tendency of these salts to absorb moisture from the atmosphere. The presence of the alkaline carbonates in clay, to any notable extent, prevents its being used as a brick clay, the alkali causing the material to melt readily.

Brickmakers divide clays into three classes:—

Plastic or strong clays, which are chiefly alumina silicate; these are called by the workmen “fat” clays.

Loams or mild clays are those in which a considerable proportion of sand is intermixed.

Marls or calcareous clays contain a notable quantity of lime carbonate.

“Malm” is a name applied to an artificial marl, made by adding to and intermixing with the clay a proper proportion of lime carbonate.

As a general rule, a clay fit for the manufacture of a first-class quality of brick is not met with in nature, being deficient either in sand or lime. A good brick clay is one that contains sufficient fusible elements to bind the mass together, but not so much as to make the bricks adhere to each other or become vitrified. Such clays contain 20 to 30 per cent. alumina, and 50 to 60 per cent. silica, the remainder consisting principally of lime and magnesia carbonates and iron oxide.

Pure or “fat” clays are sometimes used without any admixture. Bricks thus made are generally deficient in weathering qualities.

The following may be taken as the ordinary method of making what are known as “clamp-bricks” (i.e. bricks which are subse-

quently to be burned in clamps) about London. The preparation commences in the winter, during which season the brick-earth is dug and mixed with chalk and fine ashes. These ashes are the siftings from the contents of the dust-bins of London houses, and consist of the finer particles of coal and breeze (cinders), mixed inevitably with saline matters from the burned coal and with organic matter both of vegetable and animal origin. For the ordinary kinds of brick, 20 chaldrons of ashes and 15 tons of chalk are mixed with every 2700 cub. ft. of brick earth. At the Burham works, near Maidstone, where the basis of the ordinary clamp bricks is a red clay which lies below the chalk and above the blue clay (gault), out of which the Portland cement is manufactured, the preparation of the "turf," as it is there termed, is as follows:—A heap is made of successive layers of clay (which contains chalk enough for the brickmaker's purposes), sand, and ashes in the following proportions, viz. 1 ft. deep of clay, 2 in. of sand, and $\frac{3}{4}$ in. of ashes, and these layers are repeated until a heap about 10 ft. high is formed. The heap is left to become "weathered" until the spring, when it is dug down and well mixed.

China Clay.—The whole of the china-clay used in the United Kingdom, and most of that used on the Continent of Europe, amounting in the aggregate to upwards of 3,000,000 tons yearly, is produced in Cornwall and the western part of Devonshire. The greater proportion of that used in the United States is mined in Pennsylvania and Delaware.

Resulting from the decomposition of a rock composed of felspar and quartz, it is found in pockets or beds in low and occasionally swampy ground.

Kaolin is generally proved by boring, or by sinking small shafts. When the position of a deposit is determined, the overlying soil is removed and the clay is uncovered. The clay is toilsome to excavate; the strongest steel-pointed shovels are required for the work. It is removed by means of carts, cars, or derricks, and the bed is drained by pumping. The clay, as extracted, is treated in a washing-machine, in which revolves a horizontal shaft, 3 or 4 in. diam., carrying knives 12 in. long, at 4 in. pitch. A stream of water is turned on, and the clay is charged at the top or hopper entrance. It is divided as it passes through the machine, and the sand or quartz delivered with the clay and water settles in a box or sump, whence it is continually shovelled out. The clay combined with water, to the consistency of cream, runs slowly off into a number of troughs, where impurities settle to the bottom, and whence it is turned into large vats, where it remains until it becomes quite thick. From these it is pumped into filter-presses, which consist of wooden panels or diaphragms, each of which contains a canvas bag. The water escapes through the interstices of the canvas, and the clay is of such consistency that it can be handled and placed on shelves in open air to dry ready for shipment.

Kaolin is improved by exposure. If piled and allowed to freeze and thaw in winter, it is found to be the tougher for it in the spring. From 30 to 50 per cent. of washed kaolin is obtained from the crude clay. The quartz washed from the clay is pulverised and sold to the

pottery, who use it in the body of the ware, and also with felspar as a glaze.

COMPOSITION OF CHINA CLAYS.

	China.	St. Yrieux.	Aue.	Cornwall.	Indiana.	New Jersey.		Wisconsin.	
Silica	50·63	48·37	46·00	45·82	40·50	45·61	38·20	49·94	69·34
Alumina	32·74	34·95	39·00	38·60	36·35	39·04	35·09	36·80	19·19
Iron oxide	2·64	1·26	·25	..	·15	1·10	1·82	·72	1·75
Lime	·50	3·47	·44
Magnesia	·27	·13	..	·21	..	·31
Alkalies	2·52	2·40	..	1·77	·14	2·51	2·65	·92	5·73
Water	10·01	12·62	12·74	9·08	22·60	10·90	12·10	11·62	2·67

Fireclay.—Fireclays are almost exclusively obtained from the coal measures, where they often form the bed on which the coal lies. They are mined simultaneously with the coal. They are remarkably pure, sometimes consisting virtually of silica. As they are required to withstand high temperatures, objectionable impurities would be iron oxides (above 6 per cent.), and magnesia, lime, soda or potash (if exceeding a total of 3 per cent.). One of the most renowned fireclays contains 97 per cent. silica, 1·39 alumina, ·5 water, ·48 ferrous oxide, ·2 potash and soda, and ·019 lime. Weathering improves them.

The clay from which the well-known Mt. Savage firebrick is made is found as a very hard rock-like mass, only to be obtained by blasting, in veins 7 to 14 ft. thick, which appear to belong to the Carboniferous period. As first taken from the mine, it is in the form of large blocks of a rich grey or a dark-brown colour, with highly polished surfaces, which are often beautifully mottled. After exposure to the air for 3 or 4 months, these blocks can be easily broken, by aid of a sledge hammer, into small ones which still have highly polished surfaces. The clay is almost infusible before the blow-pipe, and on this account, as well as on account of its peculiar formation and structure, a full and complete analysis is not devoid of interest.

It has a sp. gr. of 2·54 and a hardness of 3·5. An ultimate analysis gave the following result:—

Water	9·88 per cent.
Silica	60·19 "
Alumina	29·10 "
Iron oxide	0·89 "
Lime	none
Magnesia	trace
Alkalies	0·03 "
Carbon	0·02 "
Total	100·10 "

This analysis shows that the clay is free from any admixtures of felspar or other double silicate, and only contains 0·92 per cent. of fluxing substances. The value of a fireclay, however, depends not only on the absence of double silicates and fluxing substances, but also on

how much of the silica exists united to the aluminium and how much in the free state as sand.

The determination of the free and combined silica made according to the method proposed by Forchhammer gave the following results:—

Combined silica	28.09 per cent.
Free silica or sand	31.84 "
Hydrated silica	0.23 "

There are two methods of determining the fusibility or refractoriness of fireclay—theoretical and experimental.

In the former, conclusions are drawn from the chemical composition; in the latter, from the changes which the clay undergoes when subjected to intense heat.

In the theoretical method, leaving out the hygroscopic and combined water and organic matter as not affecting the fire-resisting property, the refractory constituents are alumina and silica, and the fluxing constituents are magnesia, lime, soda, potash, and ferric oxide. According to Bischof, alumina is the least fusible component, and silica follows close upon it, though a mixture of the two has a much lower melting-point. The manner in which silica affects the refractoriness of alumina is variable.

The least fusible mixture consists of one molecule of alumina and two of silica, and melts at a temperature indicated by Seger cone No. 35. The fusibility increases with the amount of silica up to the proportion $1\text{Al}_2\text{O}_3 : 17\text{SiO}_2$, and then decreases (on account of the preponderance of silica, which cannot combine to form a silicate), until, finally, the alumina disappears and the melting-point of silica, equal to that of Seger cone No. 35, is reached. The practical deduction is that the refractoriness of a fireclay increases with the amount of alumina it contains.

The effects of the fluxing constituents have been studied by Bischof and Richters, who propound the law that the fluxing property is inversely proportional to the molecular weights; thus 40 magnesia would have a slagging effect equivalent to 56 lime, 62 soda, 94 potash or 160 ferric oxide. Seger maintains that ferric oxide has a stronger slagging effect than any other of the four bases. Whatever may be the precise order of these bases, it is a settled fact that if they exceed 6 per cent. of the ignited clay it cannot be classed as refractory.

To sum up, the fire-resisting power of a clay, considered from a chemical point of view, depends first upon the character of the fluxing-constituents and their relation to alumina and silica, and secondly, on the relation of alumina and silica to one another. Bischof arrives at the refractory character of a clay by what he calls the refractory quotient, which he obtains by dividing the quotient of the oxygen of the fluxes into that of the alumina, by the quotient of the oxygen of the alumina into that of the silica, thus:

$$\frac{\text{O in Al}_2\text{O}_3}{\text{O in RO}} \div \frac{\text{O in SiO}_2}{\text{O in Al}_2\text{O}_3}.$$

Bischof's method has found pretty general acceptance within the necessary limitations. It is, however, questioned to some extent by

Seger, who recommends adding the ratio of the fluxing constituent to the alumina with that to the silica, and multiplying this sum by the quotient obtained from dividing the latter into the former, thus :

$$\frac{\text{O in Al}_2\text{O}_3}{\text{O in RO}} + \frac{\text{O in SiO}_2}{\text{O in RO}} \times \left(\frac{\text{O in Al}_2\text{O}_3}{\text{O in RO}} \div \frac{\text{O in SiO}_2}{\text{O in RO}} \right).$$

No deduction, however, made from chemical analyses can have the force of a positive determination, because analysis necessarily ignores the physical constitution, whereas a coarse-grained clay is less fusible than a fine-grained, and a compact than a loose one.

Experimental methods may be classed as direct and indirect. Until lately all the direct methods have given only what may be called qualitative results, that is small samples of clay were exposed to an elevated temperature and the effect was noted. Bischof coats a piece of oiled paper with a clay paste, and gets thin tablets off when the clay dries. Another test is to place a sample of the dry pulverulent clay in a crucible and heat in a furnace. His effective tests to distinguish fritting from fusing are to draw a line with pen and ink over the fracture of the sample or touch it with the tongue. If it is fritted it will adhere, and the ink will spread as it would on blotting-paper; if it is fused it will not stick to the tongue, and the pen and ink line will be sharp and clear. The transition from qualitative to quantitative work is made by Otto, who forms two small test-bricks ($4\frac{3}{4}$ by $2\frac{3}{4}$ by $1\frac{3}{4}$ in.) from a uniform mixture of half raw and half burnt clay, places them alternately with two other bricks of the same size and of known properties to form an oblong on a refractory pedestal in a crucible furnace, and then heats them with charcoal, coke, and forced draught for about 2 hours.

The only quantitative direct method is that by Seger and Cramer, who form from the sample of clay to be tested a number of cones, inclose a test-cone with two different numbers of the standard cones in a magnesia crucible, and heat with gas-carbon in a Deville furnace lined with chromite.

In these experiments the sample has necessarily been excluded from view and the temperature of the furnace could not be controlled with any degree of nicety. To overcome these difficulties an attempt has been made by H. O. Hofman and C. D. Demond* to construct a furnace in which the temperature could be easily measured and the samples watched, and to devise a method of testing which did not require temperatures near that of the melting-point of platinum. This furnace employs ordinary illuminating gas, and is fully described by the authors in their paper.

For additional information refer to article Clay, in Spons' 'Encyclopædia,' and article Brick-making in Spons' 'Dictionary of Engineering.'

* Trans. Amer. Inst. Min. Engs., 1894.

(e) Coal rich in oil and paraffin, of high illuminating power, and therefore valuable for gas making :

Volatile matter	68.40
Coke	31.60
Ash	22.80
Sulphur53
Sulphur in volatile matter45

(f) Coals of moderate quality, used for steam raising and iron smelting :

Carbon	64.9	..	63.8
Volatile matter	34.6	..	34.8
Ash5	..	1.4

From the researches of Mahler, Johnson, and Gruner, it appears that the economic value of a coal, which may be said to depend on its steam raising qualities, may be deduced from its chemical composition, and the outcome of their investigations is condensed in the subjoined table :

APPROXIMATE HEATING VALUE OF COALS.

Percentage of Fixed Carbon in Coal, Dry and Free from Ash.	Heating Value.		Percentage of Fixed Carbon in Coal, Dry and Free from Ash.	Heating Value.	
	Calories.	British Thermal Units.		Calories.	British Thermal Units.
97	8,200	14,760	63	8,400	15,120
94	8,400	15,120	60	8,100	14,580
90	8,600	15,480	57	7,800	14,040
87	8,700	15,660	54	7,400	13,320
80	8,800	15,840	51	7,000	12,600
72	8,700	15,660	50	6,800	12,240
68	8,600	15,480			

But below 50 per cent. of fixed carbon the law does not hold, for some tests of lignites depart considerably from the average curve, as do also cannel coal and turf. In the case of cannel coal this may be accounted for by the relatively high percentage of hydrogen and low percentage of oxygen, but it is difficult to account for the high value shown by turf.

Comparison of the industrial or steaming power by Johnson's and Gruner's tests with the heating value as determined by a calorimeter strongly emphasises the fact that in the burning of highly bituminous coals under ordinary steam-boilers a greater percentage of heat is lost than in the burning of anthracite and semi-bituminous coals. There is but little difference in the calorimetric heating power of coals containing respectively 70 and 85 per cent. of fixed carbon, but in industrial practice the latter give 15 to 20 per cent. higher results. This is simply due to the great difficulty in ordinary boiler furnaces of burning the excess of volatile combustible matter, which consequently passes out of the chimney in smoke and unburned gases.

While a consumer who estimates the value of a coal by its

elementary composition has a good chance of finding a figure sufficiently near to the truth, except in the case of extra-hydrogenous coals (*e*) of the nature of cannel coal, still it is difficult to determine with precision the hydrogen and the carbon contained in a coal, and it is more simple to have recourse to a calorimeter, which permits us to appraise the value of all the combustibles without exception, and with precision.

An excellent form of calorimeter is described in detail in *Annales de Physique et de Chimie*, 1881 and 1885. The bomb consists of a shell of forged Siemens Martin steel, 654 c.c. capacity, weighing about 8 $\frac{3}{4}$ lb., and with walls 8 mm. thick, nickel-plated outside, and internally coated with a white enamel to protect it from the corrosive action of the gases of combustion. This coating is very thin, and offers no appreciable resistance to the transmission of heat.

The combustible whose calorific power is to be determined is placed in a platinum capsule suspended in the interior of the shell, and the shell is immersed in water in a calorimeter made of thin sheet brass, which is surrounded by a non-conducting envelope. The uniform weight of 2.2 kilo. of water is used, and the quantity of combustible used is generally 1 grm. The shell is filled with oxygen gas under a pressure of 20 to 25 atmospheres, the stopper is tightly closed, and the combustible is ignited by passing an electric current through a fine iron wire placed in the combustible. The combustion which takes place is complete and almost instantaneous. The heat disengaged is transmitted, without any loss, to the water in the calorimeter, where its quantity is measured by a delicate thermometer, the water being thoroughly stirred by a spiral agitator. On account of the rapidity of the experiment the greater part of the corrections usually necessary in calorimetric work are negligible; for example, those due to the evaporation of water and to the variations in temperature of the room. The correction for the "water equivalent" of the apparatus itself was determined by experiment to be 481 grm., which is to be added to the weight of water used in the calorimeter, or 2200 grm. The correctness of this figure was further proved by experiments on the combustion of naphthaline, the calorific power of which had been determined by a great number of trials to be 9692 calories per kilo. Three experiments with the bomb gave 9.6855, 9.6855, and 9.6935 calories, a mean of 9.688 calories per grm.

In conducting an experiment, the observer notes the temperature from minute to minute for 4 or 5 minutes before the ignition, while constantly stirring the water; then having made the ignition, the temperature is noted $\frac{1}{2}$ minute and 1 minute afterward, and then from minute to minute until the temperature is reached from which it begins to decrease regularly. This temperature is the maximum. The observation is continued about 5 minutes longer to determine the law followed by the thermometer after the maximum, and the consequent correction to be applied for cooling of the calorimeter by radiation. After opening the bomb its interior is washed with distilled water so as to collect the liquid nitric acid which may be formed during the explosion. The amount of this acid is determined volumetrically by titrating with a solution of potash. All the data

being thus obtained, the calculation for calorific power Q of the combustible is made as follows:—

Let D be the difference of temperature observed;
 a , the correction for cooling;
 P , the weight of water in the calorimeter;
 P' , the equivalent in water of the shell and its accessories;
 p , the weight of nitric acid (N_2O_5, H_2O);
 p' , the weight of the spiral of iron wire;
 0.23 cal. is the heat of formation of 1 grm. of nitric acid; and
 1.6 cal. is the heat of combustion of 1 grm. of iron.

We have

$$Q = (D + a)(P + P') - (0.23p + 1.6p')$$

In an industrial determination of the heating power of a sample of the well-known Nixon's Navigation Coal from South Wales, analysis gave:—

Fixed carbon, without ash	86.30
Volatile matter, without water	10.15
Hygroscopic water	1.85
Ash, by calcination	1.70
	100.00

Preliminary Period.				Combustion.				After Combustion.			
min.	°			min.	°			min.	°		
0	15.20			3½	16.60			7	18.32		
1	15.20			4	17.92			8	18.30		
2	15.20			5	18.32			9	18.30		
3	15.20			6	18.34			10	18.30		
					maximum			11	18.26		

Pressure of oxygen, 25 atmospheres.

$$a = \frac{18^{\circ}.34 - 18^{\circ}.26}{5} = 0^{\circ}.016 \text{ per minute.}$$

Difference of temperature observed	3.140
Correction 4-5, 5-6; $0.016 \times 2 =$	0.032
Correction 4-3½	0.005
	3.177

Difference corrected 3.177; say 3.18

We have then, for the quantity of heat disengaged, $(2200 + 481)$ grm. $\times 3^{\circ}.18 = 8.5256$ calories; less weight of iron wire, $.025$ grm. $\times 1.6 = 0.040$ calories; nitric acid found, 0.15 grm. $\times 0.23 = 0.0345$ —total, 8.4511 , or for 1 kilo. of the coal, 8451 calories.

The tendency to spontaneous ignition in coal has been supposed to increase with the quantity of pyrites present in it, but experiment shows that it is the tendency or power of the coal to absorb oxygen which must be taken as the true index of danger, and this may be roughly gauged by the amount of moisture which the coal has

absorbed from the air. If much moisture be found in an air-dried sample of coal, it at once stamps it as a highly absorbent form, which must on that account be stored with special precautions; if but little moisture be present, it is probably unable to take up enough oxygen to lead to serious mischief.

This is shown in the annexed table, which also makes it clear how little pyrites has to do with ignition:—

Liability to Spontaneous Combustion.	Pyrites per cent.	Moisture per cent.
Very slight	1·13	2·54
	1·01 to 3·04	2·75
	1·51	3·90
Medium	1·20	4·50
	1·08	4·55
	1·15	4·75
Great	1·12	4·85
	0·83	5·30
	0·84	5·52
	1·00	9·01

When once coal has taken up oxygen, and the early stages of heating are passed, and the temperature has again fallen, all danger of ignition is over, and it may be stored in any quantity with perfect safety, so that if it were practicable to keep newly won coal for a month in moderate-sized heaps, and then to avoid much breakage in afterwards loading it, spontaneous ignition would be almost unknown.

An idea of the enormous scale on which coal mining is conducted may be gained from the subjoined statistics of the output of the principal producing countries in 1890:—

	Million Tons.
Great Britain	184½
Germany	70
France	26
Belgium	20
Austria	9
United States	141½

The cost of production per ton, taking total outputs right through, in 1890, was as follows:—

	s.	d.
Canada	4	4¼
Great Britain	4	2¼
United States	3	0½
Continental Europe	2	9½

Of these sums, the labour cost was:—

	s.	d.	Per cent. of the Total.
United States	2	8½	89¼
Canada	3	6	80¾
Great Britain	3	3	77½
Continental Europe	1	10¾	67½

The average output per miner per week is approximately as follows:—

	Tons.
Continental Europe	27 $\frac{3}{4}$
Canada	24 $\frac{1}{2}$
United States	23 $\frac{3}{4}$
Great Britain	18 $\frac{1}{2}$

These calculations refer entirely to hand-mined coal as it comes from the miner, without being screened or otherwise treated. Hand-mined generally costs a good deal more than machine-mined coal, the difference being occasionally as much as 50 per cent. The cheapest-mined bituminous coal is now mined by hand and loaded on the railroad cars—every expense, improvements, &c., included—in some parts of the United States for about 1s. 10 $\frac{1}{2}$ d. per ton of 2000 lb.

Machine mining is steadily being extended in America, and not only is compressed air being used more and more each year, but electricity as well is gaining ground. Some of the best coal-cutters are now driven by the current, and electrical underground haulage (and lighting) is recommending itself for rapidity, easy control, and cheapness.

The various methods of mining for coal and the operations incidental thereto, have been described in a previous chapter (see pp. 99–102 so far as regards matters of general application.

Cutting.—Something remains to be said here about coal-cutting machines as compared with hand labour. The table on p. 197, by Blake Walker, deals with the question on the basis of English rates of wages. It is so far open to comment in that insufficient stress is laid upon the risks of delays and extra costs incidental to breakdowns with cutting-machines, and a certain proportion of cases will occur where a machine cannot be used at all.

Another point which cannot be disregarded is the necessity for having intelligent and skilled men in charge of the coal-cutter. These are not always easily obtained. In any event, the advantages of a machine will greatly depend upon the local labour market, and we may therefore expect machine cutting to make most headway where wages are high. It is therefore all the more interesting to note the following remarks by Scott in drawing a comparison between hand and machine cutting in Pennsylvania. He finds that in machine mining the stalls can be made much wider, because of the great rapidity of mining, so that the roof will stand a shorter time with fewer pillars. The immediate effect of the introduction of coal cutting machinery is to reduce the cost of undercutting from 20d. to 5d. per ton of 1 $\frac{1}{2}$ -in. coal in the Pennsylvanian district. Taking into account the other expenses, there is a saving of 25 per cent. Another advantage of machine mining is that perfect pillars are left and can be recovered, as there is no temptation to rob them. The reduction of the number of stalls for the same output, due to machinery, also causes a great saving in the timber, the number of roads and the tramways that have to be kept up. The saving of coal due to the introduction of machinery, is also very great; this arises from the small amount of slack and the larger coal produced by the smaller height

	In a Seam 36 in. thick.				In a Seam 30 in. thick.				In a Seam 24 in. thick.				In a Seam 18 in. thick.			
	Nature of Holing.				Nature of Holing.				Nature of Holing.				Nature of Holing.			
	Favourable.	Hard.	Very Hard.		Favourable.	Hard.	Very Hard.		Favourable.	Hard.	Very Hard.		Favourable.	Hard.	Very Hard.	
Price for getting coal by hand, per ton	s. d. 1 6	s. d. 1 7	s. d. 1 8		s. d. 1 10	s. d. 2 0	s. d. 2 2		s. d. 2 6	s. d. 2 9	s. d. 3 0		s. d. 3 3	s. d. 3 7	s. d. 4 0	
Percentage of slack by hand ..	40	40	45		45	45	50		50	50	55		55	55	55	
Percentage of slack by machine	20	20	20		20	20	20		25	25	25		30	30	30	
Average selling price per ton— Round (including nuts) at 6s. per ton hand	s. d. 4 7.2	s. d. 4 7.2	s. d. 4 5		s. d. 4 5	s. d. 4 5	s. d. 4 3		s. d. 4 3	s. d. 4 3	s. d. 4 1		s. d. 4 1	s. d. 4 1	s. d. 4 1	
Slack, at 2s. 6d. per ton machine	5 4	5 4	5 4		5 4	5 4	5 4		5 1½	5 1½	5 1½		4 11½	4 11½	4 11½	
Price for filling out coal when coal is holed by machine ..	1 0	1 0	1 0		1 3	1 3	1 3		1 10	1 10	1 10		2 6	2 6	2 6	
Yards holed by each machine per day of 16 hours	140	105	70		140	105	70		140	105	70		140	105	70	
Holed by 7 machines per day	1000	750	500		830	620	415		666	500	333		500	375	250	
Holed by 7 machines in 250 days	250,000	190,000	125,000		207,500	155,000	103,750		166,500	125,000	83,250		125,000	93,750	62,500	
Cost per ton for holing by machine	s. d. 0 3.1	s. d. 0 4.2	s. d. 0 6.3		s. d. 0 3.8	s. d. 0 5.1	s. d. 0 7.6		s. d. 0 4.8	s. d. 0 6.3	s. d. 0 9.5		s. d. 0 6.3	s. d. 0 8.4	s. d. 0 10.6	
Total cost of coal-getting by machine	1 3.1	1 4.2	1 6.3		1 6.8	1 8.1	1 10.6		2 2.8	2 4.3	2 7.5		3 0.3	3 2.4	3 6.6	
Saving, as compared with hand labour	0 2.9	0 2.8	0 1.7		0 3.2	0 3.9	0 3.4		0 3.2	0 4.7	0 4.5		0 2.7	0 4.6	0 5.4	
Saving in yield of coal (value) ..	0 8.8	0 8.8	0 11.0		0 11.0	0 11.0	1 1.0		0 10.5	0 10.5	1 0.5		0 10.5	0 10.5	10.5	
Total saving	0 11.7	0 11.6	1 0.7		1 2.2	1 2.9	1 4.4		1 1.7	1 3.2	1 5		1 1.2	1 3.1	3.9	

and greater depth of undercutting, and also from the pillars not being crushed. An estimate is given of the saving in expense by using a plant of 7 machines, run 10 hours a day, and cutting 233 tons. The cost is 29*l.* 11*s.* 3*d.*, made up as follows: fuel, 9*s.* 7*d.*; wages, 2*l.* 10*s.*; deterioration of boiler, engine, electrical apparatus and wire, 1*l.* 6*s.*; cost of repairs, 1*l.* 0*s.* 8*d.*; cost of working, 4*l.* 17*s.*; loading and blasting, 19*l.* 8*s.* The indirect saving is estimated at 2*l.* 19*s.* The cost of hand mining is 38*l.* 6*s.* 8*d.* Worked out per ton, the saving would seem to be 9*d.* directly and 3*d.* indirectly.

A number of coal-cutting machines will be found described in the author's 'Mining and Ore-dressing Machinery'; but two or three of the most modern forms deserve description here.

The Jeffrey pneumatic coal-cutting machine, introduced into this country by John Davis & Son, of Derby, consists of a bed frame occupying a space 2 ft. wide by 7 ft. 6 in. long, composed of two steel channel bars firmly braced, the top plates on each forming racks with their teeth downward, in which the feed-wheels of the sliding frame engage. Mounted upon and engaging with this bed frame is a sliding frame, similarly braced, consisting mainly of two steel bars, upon which are mounted, at the rear ends, one double 5 by 5½ in. engine, from which power is transmitted through straight gear and worm wheel to the rack, by means of which the sliding frame is fed forward. Upon the front end of this sliding frame is mounted the cutter-bar, held firmly by two solid steel shoes, with suitable brass boxes. The cutter-bar contains steel bits, made of tool steel, held in place by set-screws. When the cutter-bar is revolved these cutters or bits cover its entire face. The cutter-bar is revolved by an endless curved link steel chain from the driving shaft, and as it is revolved, is advanced by the above mechanism into the coal, or other material, to be undercut to the desired depth.

The present cutter-bar is a great improvement over those formerly used, as instead of being weakened at the sprocket by being squared, to admit of the former straight link chain, it is now made round and increased in diameter at this point. The bar is driven as before by a curved link chain, thus not only permitting it to be strengthened at this point, but greatly increasing the leverage of the chain by throwing it farther out upon the sprockets, and greatly lessening the power required to revolve the bar in the coal, as well as reducing the friction and wear upon the chains. The feed is thrown on and off by means of a lever. The cut under the coal, 5 to 6 ft. by 3 ft. 6 in., is made, and the cutter-bar is withdrawn in 4 to 6 minutes.

In the Jeffrey electric cutter, the engine is replaced by an electric motor and the frame is 8½ ft. long. The motor occupies a space 20 in. square. The current required is 30 to 50 ampères at a pressure of 220 volts. Each motor is wound to develop 15 h.p., but often only requires 7½. The armature is run at 1000 rev. a minute and the cutter-bar at 200.

The Sergeant coal-miner, made by the Ingersoll-Sergeant Drill Co., possesses several distinctive features. The valve is operated by a very simple device, consisting of two valves in the same chest, and entirely independent of the action of the main piston. The valve

motion is reliable and positive. Having no dead centres, it always starts on turning on the air, and has no outside hand wheels or moving parts. By means of this duplex slide-valve system the stroke is made variable both in length and strength, and the force of blow and length of stroke are under instant and thorough control of the operator.

The regulator is very simple, and can be adjusted instantly to give a long heavy blow for "blocking out," or a quick light blow for "backing out," or finishing the cut.

An improved air cushion has been substituted for the device formerly used, consisting of a heavy sewn leather washer, held in place by the air pressure in a reservoir, which is connected by a small passage with the main air supply. This leather is protected from the blow of the piston by a steel washer, and both the washer and leather are free to move against the elastic air. Both the outside and inside circumferences of the air cushion are kept tight by an improved form of leather packing ring. The device is very durable, and is inexpensive to replace when worn out. There is no waste of air, as none of the air contained in the reservoir is exhausted or passed through the valve. This makes a most elastic and durable cushion.

The picks are of forged steel, with shanks made square and of full size where they enter the socket, and, unlike the old style of turned shanks, never break. They are readily kept in order by any common blacksmith, and require no special tools for sharpening.

Balancing for any duty is readily effected by loosening one nut and slipping the hub backward or forward in a slot cast in the side of the cylinder. This obviates the necessity for hanging on cumbersome weights.

The piston is made of special forged steel, and is corrugated to prevent rocking or twisting, and unlike the square piston sometimes used, does not bind or cut. It is held in place by a composition metal sleeve which is bolted into the front head.

The wheels are provided with large hub bearings—4 in. diam.—which eases the effect of the blow on the operator, and obviates lost motion. The movement backwards and forwards on the board while running at full speed—190–250 double strokes per minute—is about $\frac{3}{4}$ in.; no ratchet, pawls, or similar device is required to prevent recoil. Wheels can be furnished of any size, thus adapting the machine for shearing, entry driving or any desired duty.

Having but three moving parts, the machine is exceedingly simple, durable, and economical; the makers guarantee it to mine coal at less expense for fuel, labour, and repairs than any other machine.

Its small size, great strength, and extreme simplicity adapt it for nearly all kinds of bituminous coal mining. It has no gears, chains, cutter-bars, levers, pulleys or other complicated attachments revolving under the coal to produce friction or consume power, and requires no tracks or jacks to hold it in place. It is worked from an inclined board of convenient size, while making an open channel under the coal of 4 or 5 ft. of face and 3–5 ft. undercut; as desired. The cut can be made of any desired vertical height, 8–18 in. high on the face

and tapering to 2 in. at the back, the same as done by skilled manual labour. But one man is required to operate the machine, with the assistance of a common labourer to shovel away the cuttings, and keep an extra board set in advance as the work progresses.

The operator can swing the machine and direct the blow with one hand and can work either right or left handed. The machine requires but little space and can be used successfully in narrow veins around and between props, and wherever a miner can swing a pick.

Less air is required to run these machines than any other, and they will cut with an air pressure of 40–50 lb., 75–150 lineal ft. of face, 4–5 ft. undercut, the amount of work done depending on the character of the coal and the skill of the operator.

Following is an estimate of the machinery necessary to run 5 Sergeant coal-cutters by compressed air:—

	£	s.	d.	£	s.	d.
1 Ingersoll-Sergeant standard class "A" straight line air-compressor, of piston inlet cold air pattern, steam cylinder 16 in. diam., air 16½ in., stroke 18 in.; complete, with improved water circulating jacketed cylinder and heads, and automatic and adjustable regulator with unloading device for air and steam; capacity sufficient to run 5 coal-mining machines	531	0	0			
1 steel air receiver, 42 in. diam.; height 120 in.; furnished complete with gauges, safety valve and fittings	35	10	0			
1 70-h.p. (actual) horizontal tubular boiler, of arch front pattern, with stack, grates, gauges, rollers, brackets, and fittings, including injector, complete ready to fire, except brickwork	175	10	0			
Estimated cost of pipes, valves, and fittings, to connect boiler with air-compressor, and air-compressor with receiver	20	0	0			
	<hr/>					
Total net cost of compressor outfit				762	0	0
" weight 28,800 lb.						
5 Ingersoll-Sergeant standard coal-mining machines, at 75l. each	375	0	0			
30 picks for same at 8l. 8s. per doz.	21	0	0			
5 50-ft. lengths of 1-in. air hose, wire-wound, with patent couplings attached, at 6l. 1s. each	30	5	0			
	<hr/>					
Total net cost of coal mining outfit				426	5	0
" weight 4110 lb.						
	<hr/>					
Total net cost of complete outfit				1,188	5	0
" weight 32,910 lb.						

Cleaning.—With the increasing scarcity of good coal, it has become necessary for colliery owners and managers to pay more attention to improvements in and labour-saving appliances for the treatment of the coal when above ground, in order to enable them to profitably work seams of dirty coal, avoiding at the same time all waste. On the other hand the question of having as clean a coal as possible for the production of coke, and clean small coal, such as nuts, for steam purposes, demands no small attention, as buyers pay a higher price for coal free from impurities. Coal-washing therefore becomes essential, being the only means by which dirt can be effectively removed.

Moreover, in the case of anthracite, the coal as it comes from the

mine is hardly marketable. Being very compact and practically free from volatile combustible matter, it burns only at the surface; it is, therefore, deemed important to have the lumps as nearly of a uniform size as possible, so that between them a large amount of surface will remain exposed to the action of the air without checking the draught too much, or allowing enough air to pass to cool the coal below the ignition-point. In other words, if the pieces of coal of the size of a chestnut and smaller are mixed with lumps of the size of an egg, they fill the air-passages and prevent a free draught. Therefore, one of the most important points in preparation is to have uniform sizing, and to make as large a number of different sizes as can be produced without too great expense. It is also essential to remove all dust, which is of little or no use at present, and depreciates the value of the coal.

Mixed with pure coal, occur varying quantities of slate, "slate-coal," and "bony coal." The term "slate-coal" designates lumps composed partly of coal and partly of slate, in which the pure coal occurs in such large masses that, by re-breaking, pieces of pure coal of marketable size can be obtained economically; and "bony coal" designates lumps in which the coal and slate are so interstratified that they cannot be separated economically by mechanical preparation, or in which the impurities form such high percentages that the coal cannot be economically rendered more pure by mechanical preparation, although it may be used for certain purposes in its crude condition.

The problem is, to remove the impurities as completely as possible. Of course, when slate occurs in separate pieces, it should be eliminated without further breaking. But slate-coal must be broken into smaller pieces to separate the slaty portions from the coal. It is generally impossible to sell all the larger lumps as mined, and machinery must be provided for breaking them up. As the coal comes from the mines it should be divided into various sizes, and the free slate in each size should be at once removed, either by hand or by mechanical means. In the first case, the coal is passed along shutes, at the sides of which stand men and boys who pick out the slate, and in some cases the bony and slate-coal, and allow the pure coal to pass into the pockets. Mechanical slating of coal depends upon one or more of three physical characteristics of the coal and slate: the difference in their specific gravity; the difference of the forms in which they break; and the difference of their angle of friction, or, in other words, the difference in the angle of a shute, lined with stone or iron, down which the coal or slate will slide without any increase of velocity. As a rule, slate will not slide down a shute which will carry coal.

Machinery for sizing coal may be divided into two classes—bar gratings and screens, the former having openings much longer than they are wide, while the latter have them practically of uniform diameter. Gratings may in some special cases be employed to remove dust or very fine coal, or when only partial sizing is necessary, or for large coal, because long flat pieces can fall through with cubical pieces of much smaller dimensions.

In using the old form of continuous bar gratings, part of the dirt and fine coal is often carried over the bar, and is delivered in the shute at the lower end instead of falling through; and as the spaces

between the bars are parallel and closed at the lower end, long pieces often wedge and catch, particularly at the bottom, thus necessitating frequent cleaning.

Movable or oscillating bars are shorter and much flatter than the fixed bar of the same cleaning capacity. They act as a regulator or feeder for the breaker, the amount of coal passing over them per minute being constant, if the supply is sufficient and the number of revolutions remains the same; while, by regulating the speed of the driving shaft, the quantity can be varied at will, within certain limits. They allow the men upon the platform to get much nearer their work without danger. With ordinary fixed bars, the pitch must be sufficient to allow the coal to slide down freely. This it often does, with great velocity, so that the men must remain on the side. When oscillating bars are used, the coal can be fed upon their upper end, from which it is gently carried to the platform, allowing the men to stand safely in front of the bars instead of on the sides, and bringing the coal cleaner and with less small stuff to the platform, thus permitting a better separation.

Screens proper may be either fixed or movable. The former consists simply of an inclined plane, formed either of woven wire screens, or punched or cast plates with round, square, elliptical, &c., holes. The coal is allowed to slide or roll by gravity, not too rapidly, down the plane; the larger pieces pass over and the smaller fall through. By placing several screens with openings of decreasing size underneath one another, or a series with openings of increasing size, in the same shute below one another, any desired number of sizes can be made. The objection to these is that their capacity is limited, the sizing is imperfect, and the screens clog more or less.

Movable screens are of two types. In the first type the screening surface forms a cylinder and revolves about its axis. This form of screen has been often described, and is used in almost all the anthracite collieries. In the other type the screening surface is approximately horizontal, and the motion and action are very similar to those of an ordinary hand-sieve. In many cases the screen is moved backward and forward in an approximately horizontal plane. This motion, combined with the inclination of the sieve, causes the coal which is fed on the higher part of the screen to travel gradually across it, allowing the smaller particles to fall through. This form has in many cases been adopted for small coals, and has long been used in metal mining. In other cases the approximately horizontal screen receives a gyratory motion, like the motion a moulder gives to his sieve when screening his sand. Its great advantage is that the whole surface of the screen is constantly in action, while, in the revolving screen of say 5 ft. diam., only about 8 in. of the 16 ft. circumference is at any one time in action, unless the screen is overcrowded, and the revolving of the screen acts like an elevator and tends to throw the coal back into the screen.

The problem in constructing a gyrating screen, when the screen is to be large and must make a great number of sizes, is to support it in such a manner that it will gyrate easily and safely, and at the same time that it will be self-contained, so that the centrifugal force

will be counterbalanced and will not shake the building. A successful method consists essentially in supporting one horizontal plane upon another by means of three or more double cones, while the motion of gyration is given to the upper plate by a crank upon a shaft passing through and journalled in the lower plates.

The screening surfaces have always circular holes, varying from $\frac{1}{4}$ to $\frac{1}{16}$ in. diam. Cast iron is sometimes used when the holes are large, but punched steel is preferred, being much lighter. Copper is used for small sizes when the water is very acid.

For breaking coal two methods are used. When the lumps are large and the pieces of slate attached to them are of such a character as to render it economical, the larger lumps are broken by hand, the men using picks made for that purpose. In this way large pieces of pure coal or pure slate can often be obtained; but by far the larger portion of the breaking is done by corrugated rolls.

The principle upon which rolls act may be explained as follows. In the operation of rolls as ordinarily constructed, i.e. with pointed teeth, the point of one of the teeth inserts itself into a lump of coal passing through, and breaks it much as the stroke of a pick would do; that is, the lines of fracture radiate approximately from the point where the tooth strikes the lump of coal. If two pieces of round iron are placed parallel to one another, and at such a distance apart that a piece of coal will just be supported by them, and if a third piece of round iron, placed midway between and in a direction parallel to and above the other two, is then brought down upon the coal, the piece of coal will break near the middle like a piece of wood subjected to a load in the middle too great for it to bear. The result of this action is generally to break the lump into two pieces of nearly the same size. This is the result sought to be attained with the corrugated rolls, and it is for this reason that the plan of breaking from one size as far as possible into the next size below, has been adopted, using separate rolls each time. Experiment has taught that, although all sizes below the size which is being broken are always made, yet the most economical method is to break any size as nearly as possible into the size immediately below it, of course at each time eliminating all the coal below the size that you wish to break, before passing that size through the rolls. If a piece of any size is simply broken as nearly as possible in two, for the next size, the amount of small coal made is very much less than if the same piece were struck near the centre with a pick and broken into a number of fragments. The old practice, which has not entirely disappeared, was to arrange the rolls in such a manner that putting them farther apart or closer together would increase or decrease the quantity of the larger sizes of coal. But where arrangements are made to break the sizes successively this is not necessary.

For slate picking usually the coal coming from the screens passes down a simple chute or trough, and the men or boys are placed either above or alongside of it, picking out the slate as the coal passes by. There are three objections to this:—(a) When a large quantity of coal is passing, the men can really only pick out the slate on top, much slate being hidden. (b) One and the same piece of coal, having

a slaty appearance, may be picked up by each slate-picker, in succession and returned to the shute, thus wasting labour. (c) The work done by each picker cannot be judged.

For these reasons, a different type of picking shute has been adopted, consisting essentially (1) of a supply shute which receives the slaty coal; (2) of intermediate shutes where the picking is done; and (3) of delivery-shutes which carry off the coal picked over. The coal from the screen or jig slides down the supply-shute, on each side of which the intermediates are placed, as close to each other as possible, there being room enough between each two picking-shutes for a man or boy. At the other end of the intermediate is the delivery-shute. The supply and delivery-shutes have the same inclination, but the former is a little the higher, so as to give a slight inclination to the intermediate, the axis of which is placed at an angle of about 8° to 10° with the horizontal, and 25° to 28° with the supply-shute. The slate-picker, who sits with his face towards the upper end of the shute, causes a thin stream of coal to pass in front of him, cleaning it thoroughly as it passes. The same coal is handled by one man only, with this exception, that one or two men are placed at the end of the delivery-shute to inspect the coal, and take out any pieces of slate which may have escaped the regular pickers. Immediately over the supply-shute, and supported on iron rods, is the half-round slate-shute, into which the pickers throw their slate, slate-coal, &c. This continues to the bottom, where it is examined, and the slate-coal is picked out and taken to the rolls to be broken up and prepared.

The jigs used for the larger coal consist essentially of a wooden box, lined with iron plates where the plunger works, and where the coal is put. In order to guide the water from the plunger to the jig a semicircular row of planks is put in. The coal, rising to the top, is skimmed off by a series of flat strips of iron, carried on two rows of link-belt chain. As the coal is scraped up the inclined plane, the water drains back. At the top of this inclined plane is a small flat, covered with iron, which is nearly horizontal, but inclines slightly towards the jig. The coal forms here a pile, and the water drains from it back to the jig. As each successive quantity of coal is brought up by the flights on the chain it pushes a corresponding quantity, which has been drained, off the other side down the shute, where it goes either to the picking-shutes to be picked, or directly to the pocket, if it is (as in the case of the small sizes) already clean enough. The opening through which the slate passes, is regulated by elevating or depressing the plate so as to allow the largest piece of slate to pass under it.

Automatic slate-pickers depend upon the fact that while coal generally breaks into cubical masses, pieces of slate of the same length and width are of very much less thickness. Hence, of a quantity of slate and coal which has been passed through a screen and properly sized, the slate, if placed edgewise, will drop through a slit over which the coal will pass. There are two types of automatic slate-pickers, one intended to be placed in a shute and to be fixed, and the other to be placed in the discharge lip of a gyrating screen and gyrated.

The fixed slate-picker is of iron cast in one piece, and consists essentially of a series of V-troughs, one side of the V being shorter and at right angles to the other. The lower half of the casting has a taper slit in the short side, so arranged that anything lying on the long side of the trough and of not too great height can slide out through it. Any lump which is thicker than the height of the slit will of course be retained in the trough. The slits widen as they approach the lower end. The apparatus is placed in an ordinary trough or shute down which the coal slides, receiving pitch enough to allow the coal to slide over freely, but with not too great velocity. As the coal and slate come down the shutes, each lump places itself in one or other of the grooves or troughs, which are made a little wider than the largest lump of the size for which the slate-picker is to be employed. As the lumps slide down, all the flatter pieces tend to pass out through the slit on the side, while the cubical lumps go over. Should a piece catch in the slit in consequence of the increase in height towards the end, some one of the pieces which follow will generally knock it loose, so that it does not remain and block the slits. This is an important point. The slits if made parallel would soon clog. The flat pieces, which are mostly slate, and which fall through the taper slit, pass over a shute or picking-table, where they are examined by a boy, who takes out any flat coal that may have come through with the slate.

In the gyrating slate-picker the upper part is done away with, and only the part with the slit is used. This is placed on the discharge-shute attached to the gyrating screen, so arranged that the gyrating motion of the screen has a tendency to throw the coal and slate against the short high side. In this way the latter is thrown out and passes to a jig or picking-table.

A method of mechanically removing slate used in Wyoming consists essentially of an inclined plane, down which the lumps of coal and slate are allowed to slide freely. The plane may be covered with iron, stone, or slate. The angle is such that the slate will slide down uniformly while the velocity of the coal increases. There is a gap at the end of the inclined plane, over which the coal jumps by virtue of the greater velocity acquired in sliding down the plane, while the slate, moving slowly, drops into it. There are a number of devices for changing the pitch of the shute, the form of the opening, &c.

A recent report by the Mining Institute of Scotland concludes by pointing out that the methods and appliances in use in any one district can seldom be adopted as a whole in a similar form in another. This applies in many instances to collieries in the same district, and even to different seams worked by the same shaft. The nature of the coal, the associated and interbedded strata, the skill, customs, and prejudices of workmen, the markets to be supplied, the varying requirements of competition, and the caprice of the public, have all to be taken into account when designing plant for classifying and cleaning coal.

While coal with marked characteristics can with care be selected underground so as to be filled separately, no process can be profitably

applied underground for effectually removing refuse, especially the smaller particles. To clean coal properly, it must be treated on the surface.

As a considerable percentage of dross is made in transit from the cage to the railway wagon, it is evident that the best results are got where attention is paid to the form of hutch and tumbler, the inclination of screens, and the drop into wagons; and this is specially important in the case of soft coals. The careful hand-packing of large coal into the wagons, as practised in the Nottingham district, has advantages.

For effective screening, especially when a large output has to be dealt with, there appears to be no better contrivance than the single or double jigger, or shaking screen, going at 90–100 strokes per minute, and having an inclination suited to the class of coal to be dealt with. There is a preference for wire-meshing for such screens at some collieries, and at others bars or perforated plates are preferred.

For picking, the shaking screen just referred to, or the travelling band, or both combined, is the most effective and economical—the band being about 4 ft. wide, 40–60 ft. long, and moving at a speed of 30–60 ft. per minute, according to the quantity of coal to be passed. Ample length of band allows large coal to be sized and loaded into separate wagons by hand with despatch and economy.

In every case it is necessary that the coal be delivered regularly from the tip hopper to the jigger or travelling band. This can be accomplished by regulating sluices worked by an attendant or automatically by the intervention of a slow-motion band.

Good light is essential to efficient picking.

A rough rule for deciding the number and length of picking tables may be stated as follows:—One picking table for every 30 tons per hour of tripping output, travelling at the rate of 40 ft. per minute, and having a length of 10 ft. for every 3 per cent. of material to be picked off, plus 15 ft.

The cost for labour of this system may be taken at about $1\frac{1}{2}d.$ – $2d.$ per ton of round coal for every 5 per cent. of material picked out of that coal.

For round coal, say above $1\frac{1}{2}$ in. cube, the dry process is universally employed, and this process can be successfully applied to nuts from say $\frac{3}{4}$ in. upwards, where the refuse does not exceed 2–3, or even 4 per cent.; and the table capacity required, judging from the examples in the report, is about one table for every 20 tons per hour, travelling at the rate of 30 ft. per minute, and having an effective length of 15 ft. for every $1\frac{1}{2}$ per cent. of material picked off. The cost for labour will probably be $\frac{3}{4}d.$ – $1\frac{1}{4}d.$ for every 1 per cent. picked off. Balanced screens, on which the coal is picked, are available only when the amount of material to be picked off is very small, say 1– $1\frac{1}{2}$ per cent. For all small under $\frac{3}{4}$ in., and for dross from $1\frac{1}{2}$ in. downwards, with more refuse than 2–4 per cent., the wet process is most applicable.

In the wet process it is desirable to have the arrangement so that the small coal can be delivered direct from the screens into the washing tanks without the intervention of wagons. In all the

systems of washing, the best results are obtained by sizing the small coal before it reaches the machine. This can most conveniently be done by passing it through revolving screens with meshes of varying size. The supply and degree of pulsation or agitation of the water require careful adjustment to suit the various sizes of coal to be treated, and the relative specific gravity of coal and impurities.

To remove the refuse from the smaller sizes, say under $\frac{3}{8}$ in., the felspar washer is the most effective. The felspar system is the most valuable where the coal is crushed before washing and is to be used for coke-making.

Where the coal and the refuse approach one another in specific gravity, it appears that in some cases the trough washer gives the best results. It is applicable for small quantities only, and requires a large flow of water and extra labour, but it has the recommendation of simplicity and small capital cost. It may also be sometimes utilised as a means of transport where the distance from the pit to the wagons or coke ovens is considerable.

The Robinson washer is cheap as regards first cost and upkeep, and requires little water. It largely depends for its efficiency on the attention and skill of the man in charge, who may often be tempted to pass more through it than it can effectually clean.

Speaking generally, more elaborate machinery is effective in avoiding waste in proportion to its cost; but the capital charges and upkeep are also high in proportion.

Other things being equal, coal will be washed best with an abundant supply of clean water; but the more water used, the greater the risk of fine coal being lost, and the greater the difficulty of filtration. Water to wash coal for coking should not be often used over again, as dirty water dulls the coke.

The particulars furnished as to settling ponds do not give sufficient data to justify any definite conclusion as to their capacity in relation to the quantity of coal washed. In most cases no record was kept of the quantity of water used; but settling ponds are a necessity, and their capacity will depend on the special circumstances of each case.

There seems no better way of filtering the foul water, after it has passed through the settling ponds, than pumping it on to the rubbish heap, and allowing it to percolate through.

The washed gum of coal not suited for coking is meantime used almost entirely for firing colliery boilers. Briquettes are made of it to a small extent, but new outlets are required for this product.

The large quantity to be treated daily, and the varying nature and proportions of the coal and dirt to be separated, render washing, at most collieries, a troublesome process; and unqualified satisfaction is seldom expressed as regards any machine in use. In some cases the machine may not be quite adapted to the peculiarities of the coal treated, or it may be over-driven, or not have a sufficiency of water, or be allowed to get out of repair, all or any of these causes leading to disappointment as to results.

An example of a coal-breaker is shown in Fig. 83. It is made by the Humboldt Engineering Works, at Kalk, near Cologne, and is specially suitable for breaking hard coal or anthracite, and coke, and

has the advantage that it makes very little small coal and dust, or nuts larger than required. These advantages are obtained firstly by splitting the coal by means of pointed pins, instead of crushing it as usual between rollers or jaws, thus naturally causing much less dust and slack. The process of breaking is further prevented from going too far by an arrangement of screens, which separates the nuts which have attained the size required in the first division, and prevents them entering the following divisions, and so on, thus avoiding all unnecessary breaking. The capacity of the machine is also considerably increased, as the lower divisions have comparatively light work to do. All unnecessary breaking of the finished nuts by intermediate apparatus and repeated tipping is avoided, as the machine delivers the finished product after the material has passed through once. It requires very little headroom for tipping and small floor-space. All

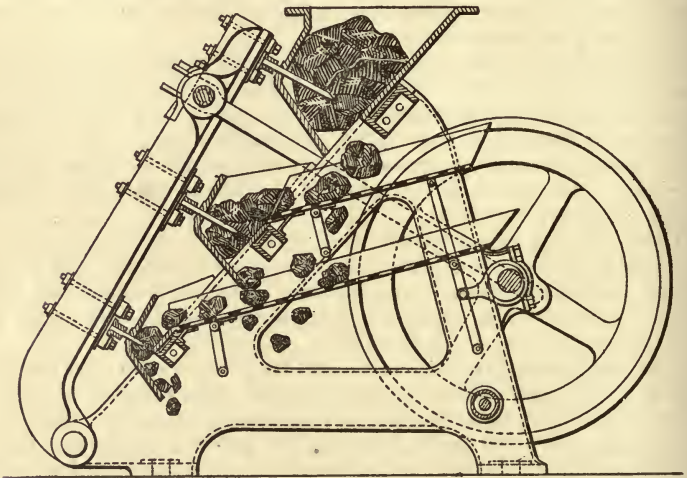

FIG. 83.—HUMBOLDT COAL-BREAKER.

parts are easily attainable and renewable. The pins are made of the best tool steel, and last 4 to 5 months without being repointed. The moving parts are well protected from the dust. Usually these machines have two divisions for a capacity of 15 tons of coal per hour, and deliver according to the quality of the material:—No. 1 nuts (3 in. to 2 in. or 80 to 50 mm.), 4 to 6 per cent.; No. 2 nuts (2 in. to $\frac{3}{4}$ in. or 50 to 20 mm.), 60 to 70 per cent.; fine coal (under $\frac{3}{4}$ in. or 20 mm.), 25 to 30 per cent.

As shown in Fig. 83, this machine consists mainly of two strong cast-iron side frames, with two or more breaking divisions, which are penetrated by the pins fastened on the oscillating arms, at each inward stroke of the latter. The swinging arms are driven by means of connecting rods from crank-pins on the bosses of the fly-wheels on both sides of the machine, and the latter are turned on the face to

serve as driving pulleys. Between the frames are the riddles or shaking screens, driven by eccentrics on the fly-wheel shaft.

So long ago as 1870 dry cleaning of small coal was successfully accomplished by Hochstrate in Germany, the object sought being the production of "Knörpel" coal free from dust. The different sizes of coal from sieves were made to fall on an iron plate lying at an angle of 60° in such a way that a current of air blown up the plate would carry off the coal dust into chambers, while the heavy "Knörpel" coal fell down the plate with the heavy pieces of slate, and passed to a jigger for separation. By this method loss of fine coal was prevented (amounting to 8 per cent. by wet concentration), and the fine dust for coking was delivered to the ovens dry. The economy effected amounted to 16*l.* 10*s.* a day on a daily treatment of 470 tons, without reckoning the prolonged life of the coke ovens.

Figs. 84, 85, illustrate one of the most recent and improved coal-washing plants erected in this country by the Humboldt Engineering Works, of Kalk, Germany, for the Powell-Duffryn Steam Coal Co., near Aberdare, S. Wales, in which some special difficulties had to be overcome.

This washery is intended to wash provisionally 350 tons, and later 500 tons, of nuts and small coal, including dust, per day of 9 hours, and to reduce the whole or only part to the necessary size for making first-class coke. The above mentioned quantity of coal consists of the screenings from ordinary bar screens with 1½ in. spaces, on which the pit coal is screened, in previously erected screening plant as found at most collieries.

The screenings are brought in railway wagons to a self-acting end-tippler, and tipped on the shoots, of which one is for bituminous and the other for steam coal. By means of sliding shutters these coals are mixed in fixed proportions in the boot of an elevator, and lifted by the latter to the large revolving screen C. In case coals should at some future period arrive on the lower line of rails, on the opposite side of the building, a second elevator has been projected for a similar purpose.

The revolving screen C consists of 4 concentric cylinders with perforations of various sizes and peculiarly shaped spiral divisions between the screens, which cause the screen to completely empty itself at each revolution, and thus avoids all unnecessary breakage of the nut coals.

The revolving screen delivers 4 sizes of nuts and pea nuts, besides the small coal and dust. The nuts are washed in the nut washers D, and the small coal in the fine washers E.

These latter have felspar beds on the sieves, and the pistons are worked, as well as in the nut washers, by means of a differential system of levers, used in all the Humboldt washers and ore jiggers, which causes a quick down-stroke and a slow up-stroke of the pistons, and which has been found specially efficient in practice.

The bodies of the washers, or bashes, are made of cast iron, to obtain the greatest possible durability; and the washers are strongly made in all parts.

The two larger sizes of nuts are conveyed in shoots to the screens,

and then fall into the boot of an elevator, which lifts them to storage bunkers, where they can dry further, and whence they are let off by means of special loading arrangements into railway wagons, to be sold according to the requirements of the market. In the majority of cases it is possible to convey the coals away from the washery on a line of rails at a lower level, in which case the nut coals fall by gravity from the washers direct to the storage bunkers, and the elevator is

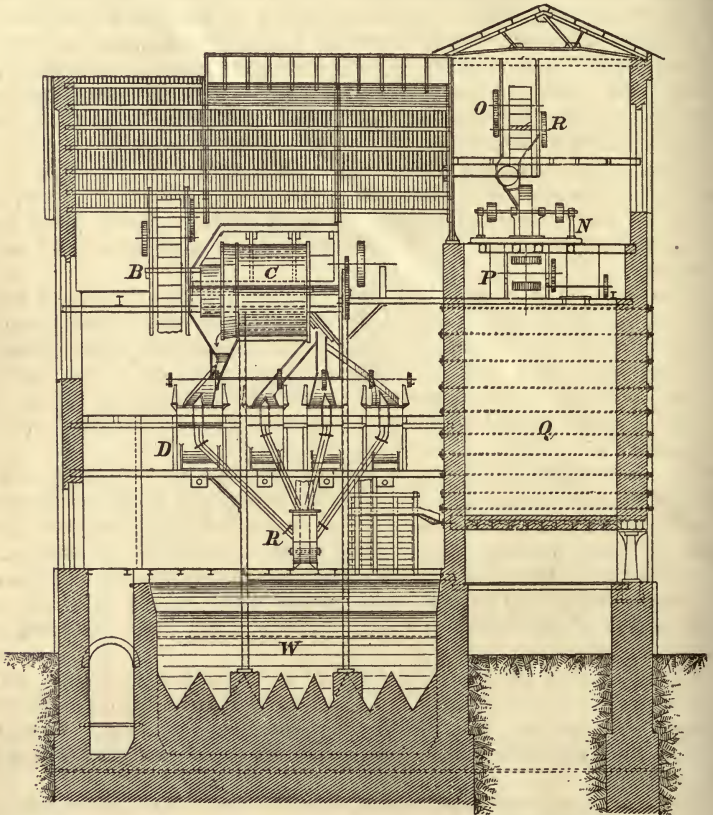

FIG. 84.—POWELL-DUFFRYN COAL WASHERY.

not required. In the case in question the locality would not allow of this arrangement.

If the nut coals are required for coking purposes, they are conveyed with the coals from the other washers to the elevator *J*, which lifts them to a creeper to be distributed in the drying towers or bunkers. From these the coal is conveyed by means of a creeper to the boot of the elevator *O*, which lifts them to the disintegrators *N*, whence they are distributed by means of a creeper to the storage

bunkers for coking coal Q. These have an arrangement for letting off the coal as required into hopper wagons, in which it is conveyed to the Collin's coke ovens. A start was made with 50 of these ovens; this number will be increased to 80, for which the washery is amply large.

The shales or stones from the washers are lifted by means of the elevators R to a bin, from which they are run in small tip-wagons to the waste heap.

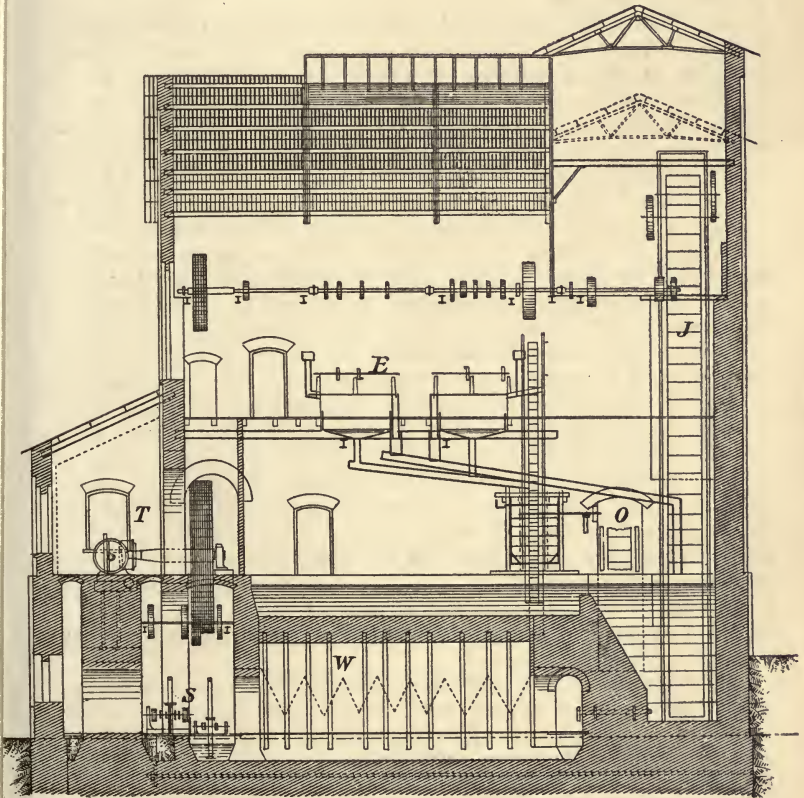

FIG. 85.—POWELL-DUFFRYN COAL WASHERY.

No loss of water, except through evaporation, takes place; the washing water is allowed to clarify itself in the settling pits W, and is pumped back to the washers by a centrifugal pump. There is no stream of dirty water running away from the washery to pollute the neighbouring watercourses, and no settling tanks besides those shown are required. All the slimes are separated from the water and mixed with the coking coal by means of suitable mechanical arrangements.

The whole of the machinery is driven by means of the 160 h.p. compound condensing engine T, which drives the main shaft and the pump shaft by means of hemp ropes from the fly-wheel pulley.

Steam is supplied by water-tube boilers which are heated by means of the waste gases from the coke ovens.

Briquettes.—Of late years there has grown up a very important industry, which aims at utilising coal dust and inferior coal, such as lignite, which in their crude states are not adapted for ordinary grates and furnaces.

It is found that when coal dust is heated up to a temperature of 500°–600° F., it becomes softened, the bituminous portion undergoing a degree of fusion sufficient to cause the small particles to adhere together. Apparently, however, this fact is not relied on in the industrial manufacture of coal-dust briquettes, for recourse is generally had to coal-tar pitch as a cementing medium. Scotch pitch answers well for this purpose, the tar not being distilled to so hard a pitch as in the case of English tar, inasmuch as it is rarely considered worth while to extract from it the small amount of anthracene oil which it contains. In order to adapt English pitch for patent fuel making, it is requisite to soften it by the addition of heavy or creosote oil. This addition is made at the tar-works. Small coal or “slack” received at the works is sifted, so as to separate the pieces of coal from the dust, the former being used as fuel for the furnaces. The pitch is crushed by passing it between a pair of fluted rollers. The coal dust and the crushed pitch are elevated separately by means of a “Jacob’s ladder” (endless band with little scoops or buckets affixed to it) to a platform above, where they are fed, in definite proportions, into the top of the mixing apparatus. The mixer is a vertical iron cylinder about 8 ft. high and 3 ft. wide, having in the centre a revolving shaft or axis provided with arms and made to revolve by gearing above. This apparatus is open at the top. As the shaft revolves, steam is thrown into the lower part of the cylinder, and its effect is to soften the pitch and to damp equably the mixture of pitch and coal dust. The mixture passes out from the lower part of the mixer in the form of a soft damp powdery material.

At some works this material is received upon an iron plate, from which by means of appropriate machinery it is swept into moulds arranged round a circular horizontal revolving table, and kept constantly wetted with water. Each time a mould is filled, a stamper comes down and compresses the material into a brick. The brick of patent fuel thus made is lifted out of the mould by machinery as the table revolves, and is transferred to an endless band, by means of which it is carried away to be stacked. At other works the moulding and stamping are effected by an apparatus which works in a horizontal direction. The mixture falls from the cylindrical mixer into a circular pan from which the stamper is fed, and in order to cool the mixture in this situation a blast of cold air is thrown upon it.

In England we have practically no lignite, but on the Continent annually many thousands of tons of otherwise worthless “brown coal” are converted into excellent fuel as briquettes. Such coal requires no binding agent to be added, as it yields on heating

sufficient bituminous matter to effect cohesion. The whole process comprises three operations:—

1. Crushing and granulating the raw and wet coal;
2. Drying and heating the crushed material; and
3. Compressing the heated coal into briquettes.

The crushing is usually and best carried out between two sets of steel rollers—one with smooth and the other with closely fluted surfaces, and the top set fed with raw and rough brown coal through a spacious hopper and shoot. Underneath the lower set a large square sheet-iron sieve is suspended, with a wire bottom composed of two different meshes, the narrowest above, so as to produce a uniform small corn, whilst the coarser part is subjected to re-crushing or used under the boiler. The sieve measures about 6 ft. 9 in. long, 20–26 in. wide, and the respective meshes are $\frac{3}{8}$ – $\frac{1}{2}$ in. and 1– $1\frac{3}{4}$ in. The sieve is suspended in an inclined position and moved by a crank, making about 300 to 500 rev. per minute. The finer coal from the upper and narrower meshes falls into a shoot, and thence into an elevator, to be raised at once on to a higher floor above the adjoining drying apparatus. If the coal is of a ligneous texture, a second sifting through a second and narrower meshed sieve on the upper platform is required, so as to keep out all the larger pieces of lignite, which otherwise would greatly endanger the subsequent drying and compressing operations by sudden ignition.

The drying and heating process aims at evaporation of the greater part of the water contained in the coal, so as to reduce it to 15 per cent., a percentage found most suitable and necessary for compressing the coal into good briquettes. Swelling and sticky coals cause obstructions, and require more air and less heat.

Granulated coal can safely be more exposed to hot air than coal of a dusty and pyritiferous nature; the latter would easily ignite when exposed to a high temperature. A certain class of coal must be even cooled down before subjected to compression, to prevent stickiness and ignition. The real problem for all drying operations is, not only to evaporate water, but also to induce a uniform liberation of the bitumen; and to these two principal parts of the drying process the greatest attention must be paid, in order to obtain well-prepared and workable coal for the press.

Drying ovens are of very various forms, and may generally be classified according to the heating medium, as follows:—

1. Heated by fire.
2. Heated by steam.
3. Heated by air.
4. Heated by air and steam.
5. Heated by fire and steam.

Of the first class, a typical example is Jacoby's, which generating a great heat, is especially adapted for all sorts of bituminous coal, requiring a moderate or even high temperature for drying. Feeding, heat, moisture, and discharge can be well regulated in it, and it is built now of such a size that two ovens produce a sufficient quantity

of coal for one press. They require, however, in general more than usual constant and careful attention to prevent ignition, and they cannot be always used with perfect safety for drying very dusty, sticky, and swelling coal.

Ovens of the second class, heated by steam passing either through hollow discs or oblong hollow plates, or a perforated shaft surrounded by coal tubes, are frequently adopted, and at some places with marked success. Rowold's disc oven is almost of the same construction as the one first described. Instead of a brick wall the apparatus is housed in a strong sheet-iron round casing, with four large folding doors, and the steam is admitted from two hollow columns or standards, opposite each other, in connection with the hollow discs, through which it passes around from one side to the other, and thence upwards through all the succeeding discs in alternate directions towards the outlet-pipe into the chimney. The movement of the coal from disc to disc by scrapers is the same, as also the discharge. Schulz's tubular drum oven has very simple movements, and is especially suitable and effective for drying dusty or uniformly small-grained coal, if not sticky or inclined to swell.

In the third class the air is heated by waste steam to a temperature of about 140°–160° F. It is easily accessible, has few moving parts, and is well adapted for granulated coal.

By the combination of steam with hot air the drying process is rendered more uniform, and a higher temperature can be obtained.

Ovens of the first and second classes are complicated and expensive in construction, and not likely to find favour where no facilities exist for repairs and alterations. The addition of a spacious re-heating chamber, where the dried coal can be kept at about 160°–170° F. for several hours, has been found to produce a much more uniform fuel. Less compression is required when the coal is coarsely granulated than when it is dusty; on the average it is 45–50 per cent. The water is generally reduced from 50 per cent. to 16 per cent., and the combustibles are increased from 48 per cent. to 74 per cent. The aim of the process is to heat the lignite to the temperature at which tarry matters are formed, and to pass it to the press immediately before they are given off. Briquettes made by the combined steam and hot air process at Zeitz, Prussia, upon analysis gave:—

Moisture	14 per cent.
Volatile matter	44·5 "
Fixed carbon	31·7 "
Ash	9·8 "

These are made of pure lignite, measure 6 in. by 2 $\frac{3}{8}$ in. by 1 $\frac{1}{4}$ in., weigh 11 $\frac{1}{2}$ oz., are not easily broken, and form a good fuel for railway, manufacturing, smelting, or general purposes. Much smaller briquettes are more convenient for domestic consumption.

Coke.—The term "coke" requires no definition; the term "breeze" is equivalent to the term "cinders," it is lighter, looser, and mostly in smaller pieces than coke. Both are solid residues of the distillation or incomplete combustion of coal, and they vary in appearance and quality with the mode in which the distillation or combustion is effected, and with the nature of the coal employed.

Coke consists essentially of carbon and fixed inorganic matter of the coal from which it has been derived; but it contains also hydrogen, nitrogen, oxygen, and sulphur (in the state of iron sulphide). The following analysis of coke is fairly representative:—

Carbon	85·84
Hydrogen	0·52
Oxygen and nitrogen	1·38
Sulphur	0·86
Ash	11·40
								100·00

Half the sulphur in the original coal, or thereabouts, is found in the coke made from it; the iron bisulphide in the coal being converted into protosulphide by the burning of one equivalent of sulphur and the production of sulphurous acid. So that, as the sulphur varies in quantity in the original coal, the quantity of sulphurous acid given off and of sulphur left in the coke will vary.

Of the various kinds of coal (lignite, cannel, bituminous, and anthracite) the bituminous variety is alone applicable to the manufacture of coke or breeze. Bituminous coal is classified into "caking" and "non-caking." The caking much depends on the manner in which the coal is heated and the degree of heat to which it is subjected. Thus, the non-caking coal of South Staffordshire, if rapidly exposed to a high temperature, such as a bright-red heat, in a close vessel, furnishes a pretty solid hard coke. The caking coals, however, are those which are preferred for coke-making. Non-caking coal does very well for making breeze, such as is employed by the nailers and chain-makers of South Staffordshire and the adjoining part of Worcestershire, and it is largely used for this purpose in the neighbourhood of Dudley.

While there are many purposes for which the coke produced in gas-making and in other ways is well suited, such bye-product coke, as it may be called, is not adapted for iron-smelting, yet the chief consumption of coke is in this last-named industry. For the preparation of this special coke, the coal is burned in an insufficiency of air, under control, and by two methods—heaps or "piles," and ovens.

The old-fashioned method of burning in piles is not much adopted now, as the coke produced is softer than that made in ovens, and less fitted for use in iron furnaces worked with the hot blast. For this mode of manufacture a flat space of ground is selected, and on it are raised many piles, made either circular or in the form of an elongated bank, usually about 4 ft. high in the middle, each circular pile being about 8 yd. diam., and coking about 20 tons of coal.

"Breeze-making" in South Staffordshire is effected in two ways: either the non-caking coal of the district is burned in a heap on the ground (locally termed "hearth-coking"), or in ovens. By the first method, a large heap of coal is lighted and allowed to burn away in great measure, and is then quenched with water. In the second method a circular oven standing alone, about 10 ft. diam., is used. It consists of a floor raised about $2\frac{1}{2}$ ft. from the ground, and enclosed in

a domed chamber, which has a chimney opening in the centre and a square doorway on the level of the floor on one side. The process differs from coking in the free admission of air (the doorway being open during the whole time), and in the gradual charging of the oven. The first layer thrown on the floor having ceased to flare, another layer of coal is thrown on it through the doorway, and so on at intervals, the coal is thrown in layer upon layer, until an accumulation to the height of about $2\frac{1}{2}$ ft. has taken place on the floor. The whole charge is then drawn into barrows and wheeled away to a heap on the ground, where it is quenched with water, sifted by hand, and then washed by hand by throwing into a tub of water; the shaly matter sinks to the bottom and the breeze is skimmed off.

The usual method of coking is in specially constructed ovens. The simplest form of coke-oven is a flat-bottomed chamber, arched-roofed, made of firebrick or other refractory material, provided with two openings, one in the roof to serve as an outlet for the volatile products of carbonisation and as an inlet for introducing the coal, and the other in the circumference or wall to serve as a doorway for withdrawing the coke. Such ovens pass under distinctive names in accordance with various minor modifications of form and arrangement. The ordinary "bee-hive" oven is of circular form, covered with a domed roof; the diameter of the floor varies from 8 to 11 ft., and the height of the dome in the centre from 5 to about 8 ft. The "rectangular" oven has an oblong floor, say 14 ft. long and 6 or 7 ft. wide (the dimensions varying however), and arched roof. Sometimes the oven is less than 5 ft. high, and the floor is raised above the level of the ground outside.

Coke ovens may stand separately or in pairs, side by side or back to back; but where coking is carried on to a large extent they are erected many together, side by side in a row, or two rows may be placed back to back, so as to form a block of 30-100 ovens, the doorways of one row being on one side of the block and those of the other row on the other side. On the summit of each row in these cases there commonly runs a tramway to carry slack in wagons for charging the ovens through their roofs. When it is intended to draw the coke in one block by machinery, as is done in the case of some rectangular ovens, the floor rises a little, and narrows a little also, towards the back of the oven. The doorway of a coke oven runs from the floor about half-way up the front of the oven, and its width varies, chiefly to correspond with the mode of drawing the coke adopted. When the coke is to be raked out, the width of the doorway is only 2-3 ft.; but when it is to be discharged in one block by a mechanical arrangement, it extends the whole width of the front of the oven. During the process of coking, this front opening is either bricked up or closed by an iron plate or door; or the door consists of a frame of iron in which bricks are laid, and is raised when requisite by means of a pulley and counterpoise. Beside the door there may be only the central aperture or chimney in the roof; but commonly there is a flue proceeding from the back part of the oven, by which the products of combustion are carried off, the central

opening in the roof being only used for charging the oven. Where the oven is charged by the door there may be no central opening in the roof.

Coke ovens, once set to work, are kept at work until it is necessary to stop them for repairs. As soon as possible after a charge is drawn, and before the walls have had time to cool, the oven is re-charged with coal.

It is customary to use for coking in ovens what is technically termed "slack," that is to say, the dusty coal for which a sale is not so readily found as for lumps of coal. It is also customary, when the coke is to be used for iron furnaces, to wash the slack so as to remove from it shaly matter and some of the pyrites.

It is claimed that "bee-hive" coke is so much better for blast-furnace use than coke from recuperative ovens, that it pays to throw away 40 per cent. of the coal, or whatever else may be the difference between the two systems. This claim was substantiated in a measure, by Sir I. Lowthian Bell, who experimented with several thousand tons of bee-hive and Simon-Carvés coke made in a recuperative oven, and found that the bee-hive coke was about 10 per cent. better than the Simon-Carvés. Sir Bernard Samuelson, however, in repeating the experiment, did not altogether confirm this result. But the experience in France, covering a number of years, is clearly in favour of the recuperative oven; and certainly the loss of 10 per cent. in reducing power, as reported by Bell, is not to be taken as condemnatory of a system that is highly prized elsewhere. In the manufacture of coke there has not been the same scientific and economic progress as in the mining of coal and in the production of pig-iron and steel.

Nearly all the coke in the United States is made in bee-hive ovens, the attempts to introduce other systems of coking not having been successful commercially. As a rule the gases are not consumed; some establishments, however, utilise them for heating purposes. Tar and ammoniacal liquors are not saved, so that the 40 per cent. or 50 per cent. of volatile matter passes off into the air and is wasted.

During the twelve years ending with 1891 the coke production of the United States was 82,806,438 tons, representing 137,458,687 tons of coal.

The following comparison of British, Continental, and American coke, is based on the returns for 1889 and 1890:—

British: 1·65 tons of coal make 1 ton of coke, costing 7s. 11½*d.* per ton of 2000 lb., of which the coal amounts to 5s. 11½*d.* or 74·63 per cent., and the labour to 1s. 4½*d.* or 17·24 per cent.

Continental: 1·327 tons of coal make 1 ton of coke, costing 9s. 6*d.* per ton of 2000 lb., of which the coal amounts to 8s. 5*d.* or 89·28 per cent., and the labour to 9½*d.* or 8·4 per cent.

American: 1·555 tons of coal make 1 ton of coke, costing 6s. 11*d.* per ton of 2000 lb., of which the coal amounts to 5s. 0½*d.* or 73 per cent., and the labour to 1s. 5½*d.* or 21·1 per cent.

EMERY AND CORUNDUM.

WHILE emery and corundum are very nearly allied mineralogically they are sharply distinguished in the trade. Whereas corundum is almost a pure alumina, emery is contaminated by a large proportion of iron oxide, ranging generally between 20 and 33 per cent. Physically also they are distinguished by the following features:—Corundum is variously coloured, commonly grey, but never black; it is much harder than emery, with sharper edges, and cuts more deeply and rapidly; it is, however, more brittle and therefore less durable. Emery is practically always black:

The chief European sources of emery are the Greek island of Naxos and Asiatic Turkey.

The Naxos deposits occur chiefly near Bothis at the northern end of the island, which is principally made up of metamorphic rocks, divisible into gneiss and schist formations, the latter consisting of mica schists alternating with crystalline limestones. The lenticular masses of emery, which are very variable in size, ranging in length from a few feet to upwards of 100 yd., and in thickness from 5 up to 50 yd., are closely associated with the limestones, and follow their undulations; they vary much in position, lying at all angles, from horizontal to nearly vertical. The highest quality of mineral is obtained from two comparatively thin, but extensive deposits, Aspalanthropo and Kakoryakos, which are 435 m. above the sea-level. The mineral is stratified in thin bands 1–2 ft. thick, crossed by two other systems of divisional planes, so that it breaks into nearly cubical blocks in the working. The floor of the deposit is invariably crystalline limestone, and the roof a loosely crystalline dolomite covered by mica schist. The underlying limestones are often penetrated by dykes of tourmaline granite, which probably have some intimate connection with the origin of the emery beds above them. The working of the deposits is conducted in an extremely primitive fashion by about 600 privileged workmen, who have the right of working the mineral wherever and in what manner they think best. The produce is taken over by the Government official at the rate of about 1s. 6d. per cwt. The rock is exclusively broken by fire-setting. A piece of ground about 5 ft. broad and the same height, is cleared from loose material, and a pile of brushwood is heaped against it and lighted. This burns out in about 24–30 hours, when water is thrown upon the heated rock to chill it and develop fractures along the secondary divisional planes in the mass of emery, and so facilitate the breaking up and removal of the material. Sometimes a crack is opened out by inserting a dynamite cartridge, but the regular use of explosives is impossible, owing to the hardness of the mineral, which cannot be bored with steel tools. Only the larger lumps are carried down to the shipping place, the smaller, up to pieces as large as the

fist, being left on the ground. As most of the suitable places for fire-setting at the surface have been worked out, attempts have been made to follow the deposits underground, but none has been carried to any depth, partly on account of the suffocating smoke of the fires, rendering continuous work difficult, but more particularly from the dangerous character of the loose dolomite roof, which is responsible for many fatal accidents from falls. These might, of course, be prevented by the judicious use of timber or masonry to support the roof; but this appears to be beyond the skill of the native miners, and the rapid exhaustion of the forests in the neighbourhood of the mines owing to the heavy consumption of fuel in fire-setting, has been a cause of anxiety to the Government for some years past.

Emery stone is found in nearly all parts of Asia Minor, and not unfrequently in the remote and almost inaccessible regions of the interior, where the natural obstacles are too great to offer any inducement to the miner. The principal mines are confined to the districts of Thyra and Aidin, situated to the southward of Smyrna. When well picked and freed from unsound ore and rubbish, the emery from the Charnaud, Jackson, and Abbot mines is of good and nearly equal quality. The Glyka or Akdere stone is not as much sought after, while that excavated near Milassa, the larger part of which finds purchasers in the United States, is of inferior quality, the grain being smooth and a great deal of magnetic iron entering into its composition. The mines are opened by pits and galleries, and the stone is obtained in most instances by blasting, gunpowder and dynamite being freely used to extract it. The overseers and principal workmen at the mines are Italians, who are paid 3s. 6d. per diem; the native workmen are paid only about half as much. In some cases the mining is attended with difficulty and expense. At the Jackson mine, for example, the stone is procured from a great depth, water necessitating the employment of a steam-pump. At Kourchak not even blasting is required, the emery being dug up from the red argillaceous earth wherewith it is mixed. The coating of the stone varies with the colour of the earth or rock in which it is found—from red to brown, grey, or white; and as a rule no correct judgment of the quality can be formed from its outward appearance. The grain should be hard, bright, and coarse, resembling gunpowder, and varying in hue from reddish black to dark bluish grey. The grain must be tested before one can certainly know its abrasive power, which does not solely depend upon the amount of alumina it contains, but also upon the molecular construction. In the Tchaous concession, near Thyra, a great deal of the emery is not mined, owing to the presence of mica in the grain. The emery is picked daily at the mines as fast as it is extracted, in some instances not one-half the quantity being selected. It is then conveyed by camels to the nearest railway station, and from thence to Smyrna, where it is generally picked again previous to shipment. When the mines are situated on heights inaccessible to camels, the ore is brought down by donkeys. If the pieces are too large to be carried by camels, they are brought to the station in carts drawn by buffaloes. But these very large pieces are broken at the mines with sledge-hammers, after having been subjected to the action of fire to facilitate their breaking.

Corundum has been found in a large number of localities in the United States, but only three places have been actual producers. The emery vein or bed at Chester, Mass., has furnished a large quantity of the mineral; but the chief American source at present is a belt of serpentine that extends from south-western North Carolina into Georgia. It is an altered olivine rock, and has gneiss for its immediate associate, and along the contact of the two are found the veins (or beds) of decomposed rock which have the corundum disseminated through them. Corundum Hill, in North Carolina, and Laurel Creek, in Georgia, are the chief producers. The mineral is crushed, sifted, and washed, and thus comes to market in various sizes. Care is taken to avoid making undue amounts of the finest product, or "flour," for this has less value than the coarser grades.

The usual test of the quality of a sample of emery or corundum, is to compare a weighed sample with an equal amount of the standard grade, or of some well-recognised brand; two weighed pieces of plate-glass of convenient size are then rubbed together with the sample between, and the process is continued until the grit has disappeared and the plates no longer lose in weight from the abrasion. The amount of loss is a measure of the hardness and abrading power of the sample, the better grade giving the greater loss.

The presence of garnet and other hard substances, not equal to emery in abrasive power, is liable to occur in inferior samples. The preparation of corundum is much more costly than that of emery, owing to its greater hardness, hence it commands a higher price (about double), while for many purposes it is not superior. About 9*l.* a ton is the approximate market value of corundum, the production varying around 2000 tons yearly. The annual output of emery is probably 10,000 tons. Pure corundum is crystallised aluminium oxide (Al_2O_3); its hardness is 9, diamond being 10. The gems, ruby and sapphire, have the same composition.

FLUORSPAR AND FELSPAR.

Fluorspar.—Until the beginning of this century, fluorspar was considered indispensable in metallurgical operations. It diminishes the loss of metal, and was long the only energetic means of reducing the melting point of slag from ores carrying high percentages of clay or zinc. Without fluorspar very refractory ores could not be smelted at all.

Gradually, however, as blast furnaces and smelting apparatus were improved, fluorspar was superseded by lime and other cheap fluxes, but of late its use has been reintroduced into nearly all branches of metallurgy.

While the cost of fluorspar is six to seven times greater than that of limestone, 1 part of fluorspar goes farther than 10 of limestone. The former is especially effective in reducing the quantity of fuel; it forms two parts of slag where limestone forms three, and it forms possibly also fluorsilicate, whereby heat is likely to be liberated.

While the rather high price of fluorspar prevents its use in the production of ordinary white and grey pig iron, it has proved a rapid and energetic solvent in blast furnace work, where it is blown in as powder through the nozzles.

In making silicon iron, fluorspar plays a more important part. A ferrosilicon iron, with 10 per cent. silicon, made especially in Upper Silesia, is almost indispensable for works that make very tough, deep-grey castings. This ferrosilicon can be obtained in any ordinary blast furnace from any silicious iron ore if it is only fluxed with fluorspar, and the slag is strongly basic. The fluorspar reduces the silicon energetically; at all events fluorsilicon is formed, which is reduced to silicon by the hydrogen contained in the furnace gases, and possibly also directly by the coke. It does not seem impossible that the greatly increased price of coke will result in a reintroduction of fluorspar as a fuel-saving flux in the manufacture of foundry pig, particularly as even a very small quantity of fluorspar added to the charge at once raises the product to No. 1 deep-grey pig, rich in graphite.

The remarkable property of fluorspar, that it facilitates the reduction of the most different bodies—a property common to almost all the fluorides—makes it a valuable flux in the production of spiegeleisen. It has long been known that fluoride of manganese, as well as a mixture of a manganese combination with fluorspar, can with comparative ease be reduced to metallic manganese by means of sodium. The modern application of this method to the blast furnace substitutes carbon for sodium. A highly basic slag, rich in fluorides, seems nearly indispensable for the production of a rich ferromanganese in the blast furnace.

The property of fluorspar, to carry phosphorus into the basic slag, has never been of special importance as far as pig iron is concerned,

but it is utilised by the Krupp and Rollet methods of dephosphorising pig in the basic-lined cupola-furnace. Whilst, at all events in the blast furnace process, the property of lime fluoride to form an easily melting slag with phosphates is of some importance, fluorspar, in the process of purifying the pig iron, serves probably only as a flux for the highly basic lime-slag saturated with phosphorus.

In the Thomas process too, and even in the Bessemer converter, fluorspar is in recent practice being added in small quantities for the purpose of concentrating the slag and reducing the loss of metal; very great care, however, is needed to prevent such a slag from attacking the acid lining. It is also said that in puddling in the various steel-making methods, and in the Siemens-Martin process, fluorspar is added partly as a slag-forming flux.

In foundry work, it is a fact that limestone, which, because of its cheapness, superseded fluorspar, of late is losing ground to the latter. The limestone flux in cupola-furnace work serves only to slag the ashes of the fuel, the sand adhering to the pig, &c., no chemical effect on the iron being intended. But the fluorspar affects the iron noticeably, keeps it grey and soft by holding the silicon as an alloy, whilst a limestone flux favours the tendency of the silicon to slag. Besides, fluorspar carries some phosphorus and sulphur into the slag. Fluorspar makes it possible to melt inferior kinds of pig iron and a higher percentage of scrap. But practice has shown that too much fluorspar is rather injurious than advantageous, one reason for this being that the manganese contained in the iron is thereby prevented from slagging.

The quantity of fluorspar which is added to 100 lb. of pig iron to be remelted, is $\frac{1}{3}$, or at the most $\frac{1}{2}$ lb. The improvement of the product caused by this flux is specially manifest in the improved cupola furnaces, particularly Herbert's, which has much facilitated the utilisation of inferior iron for soft castings. The property of fluorspar to protect manganese does not seem favourable enough to offset the injury due to its silicon-reducing power. Its use would, at least, require melting in a basic furnace, or as cold as possible.

As the small quantity of phosphorus and sulphur contained in Swedish charcoal iron, is almost entirely carried off in the comparatively acid slag by fluorspar, this is of prominent importance for the treatment of very pure qualities of iron.

Dr. Foehr states that fluorspar was formerly the most important flux for smelting copper ores in the German stack, as well as in the English reverberatory furnace. The Mansfeld copper slate, for instance, was fluxed with up to 10 per cent. of fluorspar, the cost of this being about 8 per cent. of the total smelting cost. The effect of this flux depended essentially on the volatilisation of silica fluoride, whereby the strongly acid slag was reduced in silicon. The introduction of improved and heated blasts in the Mansfeld works has almost confined the use of fluorspar to the blowing in of furnaces; 5 per cent. of fluorspar is commonly added at the start, but the quantity decreases gradually, until after 2 to 5 weeks no fluorspar at all is used. The English reverberatory furnace process fluxed formerly with as much as 10 per cent. of fluorspar, but nowadays this takes place only with ores rather rich in arsenic. Fluoride of calcium, with arsenic metals,

gives very volatile fluoride of arsenic, which, with a reducing flame, easily escapes. The risk of loss involved in the volatile fluoride of copper necessitates the presence of excessive carbon whenever fluorspar is employed in the metallurgy of copper.

While fluorspar is at present of small value in the treatment of copper ores containing sulphur, its property to give fluid combinations with gypsum and barytes may prove an important means to work poor oxides and silicious ores as well as charges containing azurite, malachite, red oxide of copper, atacamite, and earthy red oxide of copper, by reducing the smaller part of the sulphate, and forming a matte very rich in copper, and by forcing its larger part together with the fluoride of calcium into the slag, which thereby becomes thin and very fluid. Equal quantities of fluorspar with gypsum or barytes produce the most fluid slag. A significant point, particularly with poor ores high in silica, is that this slag is poor in copper, a fact on which was based the former Freiberg practice of resmelting the copper slag, together with pyrites and fluorspar, thus obtaining copper matte and poor slag, the intention probably being to enrich the matte in copper and impoverish it in iron.

Fluxing copper ores containing nickel, with fluorspar, is very favourable for the collection of the nickel in the matte, and has been in use in the Reichelsdorf, Grünthal, and Mansfeld works. The chemical process is still entirely obscure, and worthy of study in the laboratory. Possibly, nickel-arsenic is decomposed into volatile fluoride of arsenic and nickel, which latter goes into the matte. Fluorspar is an almost indispensable flux for making tough copper, and, generally, whenever silicon, which makes copper highly brittle, has to be removed. As a means to produce a matte poor in iron in the reverberatory furnace, a mixture of fluorspar, barytes, and quartz is more energetic and rapid than an addition of only the two last named, the proportion of the fluorspar and the barytes being for this purpose as between one and three, whilst the quantity of quartz depends on how much iron the roasted matte contains. Too much fluorspar gives a matte rich in iron. For refining and remelting copper, fluorspar finds a constantly increasing use. Mixed with some soda, it is excellent for remelting copper ingots, and for removing from the metal bath small quantities of arsenic and silicon. The process is kept a secret; the refining slag is, however, reported to be remelted with gypsum or glauber salts and fluorspar.

In composition fluorspar is essentially fluoride of calcium, and consists of 51.3 per cent. calcium and 48.7 per cent. fluorine. It occurs notably in association with lead veins in limestone formations, the British output coming chiefly from Derbyshire, while the American product is exclusively derived from the Rosiclare mines, in Hardin county, Illinois. In the latter case, deposits of fluorspar and galena occur in the limestones underlying the coal measures, in enormous and well-defined fissure veins, the fluorspar being the more valuable portion of the mineral. The British production of fluorspar varies between 100 and 500 tons yearly, and the American between 6000 and 9000 tons, the value being about 25*s.* a ton.

Felspar.—There are many places at which felspar is mined, or

rather quarried, the product being in most instances consumed locally, as the value of the article, about 15s. to 1l. a ton, does not admit of long carriage. The mineral is a common ingredient of granites and syenites, and is generally a bye-product of china-clay works. It is a double silicate of alumina and potash, and contains about 64 per cent. silica, $18\frac{1}{2}$ alumina, and 17 potash. Its principal use is in porcelain-making.

FUEL.

FUELS are of three kinds—solid, the most common form; liquid, the most energetic; and gaseous, the most easily controlled.

By good and proper firing, a utilisation of 66 per cent. of the energy contained in coal may easily be accomplished, and 80 per cent. is not impossible. These figures may usefully be borne in mind when discussing the supposed immense advantages of gaseous fuels. No process can add to gaseous fuel more energy than it derives from the solid coal, in fact a loss of energy must take place in the conversion, and the greater utilisation, taking place in the case of gaseous fuel, is simply due to perfected combustion, incidental to the feed being more readily adjusted and controlled. The consumption of solid fuel is not likely to be affected to any extent by artificially produced gaseous fuels.

Liquid fuel, in other words, ordinary petroleum, is a very valuable heating agent under certain conditions, as it contains much more energy, in proportion to its volume, than any other form of fuel. Its composition is practically 84 per cent. carbon and 14 per cent. hydrogen, so that its energy per lb. is about 20·860 heat-units, or 44 per cent. greater than that of good coal. In addition, it can be burned with less relative waste, so that it really can give about 50 per cent. more duty than coal. But the available supply prohibits any idea of its replacing coal in a general way.

Of gaseous fuels, the least costly per unit of heat is common "producer" gas, in which the oxygen for burning the carbon to carbon monoxide is derived mainly from the air. The associated atmospheric nitrogen dilutes the carbon monoxide, making air-gas the weakest of all useful gases, or the lowest in combustibility. Next in order of heat-energy comes water-gas, in which the requisite oxygen is derived from water-vapour, and hydrogen is liberated; for equal volumes, this gas has more than double the calorific power of air-gas. Third in the ascending scale stands the ordinary illuminating gas distilled from bituminous coal, which carries more than double the heat-energy of water-gas. Highest in the list comes natural gas, the calorific power of which is about 50 per cent. greater than that of coal-gas.

The following table gives the bases for calculating the heat units (British thermal units) developed in the burning of various combustibles:—

Heat-units developed in burning.	For 1 lb. of combustible.	For 1 cub. ft. of combustible.
C to CO	4,400	
C to CO ₂	14,500	
CO to CO ₂	4,325	319
H to H ₂ O	62,000	327
CH ₄ to CO ₂ and water	23,500	1007
C ₂ H ₄ to CO ₂ and water	21,400	1593

In making producer gas, it is possible, by utilising the sensible heat of the gas through close attachment of producer and furnace, and by introducing with the air blast as much steam as can be tolerated without destroying good incandescence, to recover 60 per cent. of the energy of primary combustion. Even counting the sensible heat as lost, and adding radiation and other losses, still the gas should carry 87 per cent. of the heat-energy of the fuel, while if the sensible heat be utilised the figures will reach 93 per cent. The heat which 572 lb. of this gas, derived from 100 lb. of carbon, is capable of generating by combustion is:—

CO burned to CO ₂ , 233·33 lb. × 4,325 ..	1,009,160	heat-units.
H „ water, 4·17 lb. × 62,000 ..	258,540	„
Sensible heat in 572 lb. of gas	85,800	„
	<hr/>	
Solid C burned to CO ₂ , 100 lb. × 14,500..	1,353,500	„
	1,450,000	„
	<hr/>	
Loss in conversion, 6·65 per cent.	96,500	„

In generating gas from anthracite coal, the products will be:—

186·66 lb. CO	807,304	heat units.
5·00 lb. CH ₄	117,500	„
3·75 lb. H	232,500	„
	<hr/>	
Total	1,157,304	„
Total energy in 100 lb. of coal	1,349,500	„
Efficiency of conversion	86	per cent.
Heat-units in 1 lb. gas	2,248	

In the case of a bituminous coal containing 55 per cent. carbon and 32 per cent. volatile combustible matter, the yield should be:—

116·66 lb. CO	504,554	heat units.
32·00 lb. vol. HC	640,000	„
2·50 lb.	155,000	„
	<hr/>	
Total	1,299,554	„
Total energy in 100 lb. coal	1,437,500	„
Efficiency of conversion	90·0	per cent.
Heat-units in 1 lb. of gas	3,484	

As compared with anthracite, the greater energy of bituminous gas is even more than appearance indicates, since the high percentage of hydrocarbons is associated with lower nitrogen. But the 32 per cent. of volatile combustible matter must be volatilised and utilised in its full strength, therefore it should not be suffered to cool below 300° F. before it enters the combustion-chambers or regenerators, and the higher its temperature at the furnace the better.

Though water-gas cannot be produced without entailing great loss of energy in its formation, and therefore enhanced cost per unit

obtained, it possesses qualities which will ensure it a limited application. It is made intermittently by blowing up the fuel-bed of the producer to a high state of incandescence, then excluding air and forcing steam through the incandescent fuel, whereby the water is broken up into hydrogen and oxygen, the former being liberated and the latter combining with the carbon of the fuel. Theoretically, 1000 cub. ft. of water-gas contain 500 cub. ft. or 2·635 lb. hydrogen, and 500 cub. ft. or 36·89 lb. carbon monoxide. The heat developed and absorbed in the operation will be:—

	Heat-units.
2·635 lb. H absorb in dissociation from water	2·635
× 62,000	} 163,370
15·81 lb. C burned to CO develop	15·81 × 4400
	} 69,564
Excess of heat-absorption over heat-development ..	93,806

in addition to the energy consumed in raising the coal from say 60° F. to 1800° F. In practice a further source of loss arises from physical causes. While the generation of water-gas is very rapid and complete for the first few minutes, long before the bed of fuel has lost enough heat to stop the dissociation of water-vapour, the gas will be found to contain a very large percentage of steam, which continues to increase till it is nearly all steam, while the fuel-bed is still at a good heat. It would seem from this that there is a coating of some kind soon formed on the fuel that prevents the oxygen of the water from combining with the carbon, and that does not form at the same temperature when both air and steam are used. Some engineers think this is due to a sort of fusion of the ash, making a thin coating on the surface of the coal, while others charge it more to a rapid cooling of the surface, or both. But W. J. Taylor asserts that when the temperature of the fuel-bed of a producer is too low to make water-gas alone, it is plenty hot enough for making gas with air and steam together. From this it is evident that more water-vapour can be dissociated in a continuous than in an intermittent process, whence arises a richer gas and better utilisation of the energy of the fuel consumed.

So much misapprehension exists among fuel consumers as to the loss of heating power implied by escaping smoke that the following observations recently published by R. R. Tatlock* deserve to be widely made known. This well-known authority declares that the loss of any large percentage of combustible matter, and consequently of heating-power, is quite out of the question. This may be proved in two ways: (1) by calculation of the two sources of heating-power as shown by an analysis of coal or dross used for steam-raising; and (2) by actual analysis of the furnace gases for combustible solids and gases.

On p. 228 are given the results of these two methods of observation, the same dross being analysed and also employed as fuel in a works furnace, from which smoky gases were given off which were tested for combustible matters.

* Chemical News, 1894.

1. Analysis of dross employed:—

	Per cent.
Gas, tar, &c.	37·63
Fixed carbon	49·97
Sulphur	0·40
Ash	2·72
Water	9·28
	<hr/>
	100·00
Heating power (practical) due to gas, tar, &c.	1·16
" " " fixed carbon	6·49
	<hr/>
	7·65

The points to be observed are the relative proportions of heating power represented in the analysis by the number of pounds of water at 212° F. capable of being evaporated to dryness by 1 lb. of the fuel given out respectively by the combustion of gas, tar, &c., and by the fixed carbon. These are calculated according to Playfair's well-known formula, which was practically tested on coals intended for the British navy, and which shows that while 1 lb. of fixed carbon is capable when burned of evaporating 13 lb. of water at 212° F. to dryness, 1 lb. of the gas, tar, &c., will only evaporate 3·1 lb. From these figures it appears that in the coal or dross the gas, tar, &c., only contribute 15 per cent. of the total heat given out during the combustion, and that the fixed carbon produces the remainder, or 85 per cent. In coals with less of the former ingredients and more of the latter, which is commonly the case, the proportion given out by the volatile constituents would be considerably reduced. It is thus perfectly clear that even though the whole of the volatile matters (which can alone be accountable for any loss of combustible material) escaped combustion, there could not possibly be a greater loss of heat than 15 per cent. of the whole, even in such an extreme case as this represents.

2. Analysis of furnace gases given off during the burning of the dross:—

	Gases very smoky. Per cent. by volume.	Gases almost free from smoke. Per cent. by volume.
Carbonic acid	5·0	3·5
" oxide	none	none
Hydrocarbons	trace	none
Nitrogen	79·9	79·9
Oxygen	15·1	16·6
	<hr/>	<hr/>
	100·00	100·00

It has been asserted that carbonic oxide is given off in considerable quantity when much smoke is being produced, but it does not appear in this case; and Hempel, in his work on 'Gas Analysis,' comes to the conclusion that little or no combustible gases are present in furnace gases. He says, "Furnace gases usually contain only carbon dioxide, oxygen, and nitrogen. All other gases are present in but very small amounts. In oft-repeated analyses the author has always found only traces of carbon monoxide, methane, and the heavy hydrocarbons." This is in complete accord with the analyses given above, and it may

be taken for granted that the presence of carbonic oxide or other combustible gases in furnace gases is a most unusual occurrence. This is quite conclusive evidence that no appreciable loss of heat, even when the furnace gases are smoky, can be attributed to the passing away of the products of imperfect combustion in the gaseous form at least.

That there is loss of combustible matter in the smoke is an undoubted fact, but the quantity seems also to be greatly magnified in certain random statements. In the experiment referred to above, the soot was also collected during $1\frac{1}{2}$ hr., with the following results:—

	Grains per 100 cub. ft. of furnace gases.
Carbonaceous matter	30·81
Ash or mineral matter	20·65
	<hr/>
Total soot	51·46

It will be observed that the soot collected consisted largely of mineral or incombustible matter. In several experiments to estimate the soot in furnace gases similar results were obtained, and the average would come very close to the quoted results of this special test.

To find how much carbonaceous matter is actually lost as smoke, it will be necessary to know the number of cubic feet of furnace gases given off by the combustion of, say, 1 ton of the dross. If the percentage of carbonic acid in the furnace gases is taken at 5 per cent., the total volume of these given off from 1 ton of dross would be about 940,000 cub. ft. measured at the ordinary temperature and pressure, and this would contain 41 lb. of carbonaceous matter and 27 lb. of mineral matter. This would represent 1·8 per cent. of the volatile matters (gas, tar, &c.) given in the analysis of the dross; and if from this is now calculated the heating power according to Playfair's formula, it will only come to 0·057. This figure, compared with the practical heating power (7·65) of the dross, goes to show that the solid combustible matter of the smoke can only account for the very small percentage of 0·74 of the total heating power which can be obtained from the coal.

From the results of these experiments it is evident that the loss of combustible matters in smoke is very small indeed, and that the belief in immense loss by this cause is simply a fallacy, and not corroborated by experiment. In adopting methods of removing the smoke nuisance, it must therefore be borne in mind that there is little or no gain in burning smoke, and that other methods of dealing with the problem, such as Dulier's smoke absorption process, ought also to receive consideration.

FULLERS' EARTH.

THIS material cannot be said to possess a definite chemical composition, but in general terms it may be described as an unctuous soft silicate of alumina. Two varieties are distinguished in the trade, one having a blue cast of colour, the other a yellow. Analyses show the following average percentages:—

	Blue.	Yellow.
Aluminous earth	18	11
Silicious earth	42	44
Lime	4	5
Magnesia	2	2
Oxide of iron	6	10
Soda	5	5
Water	23	23

The fullers' earth beds which are worked in Bedfordshire and Surrey occur in the Lower Greensand formation, whereas those encountered near Bath belong to the Oolitic age. There are numerous other occurrences of fullers' earth in various formations in other parts of England, but they have not yet attained any degree of industrial importance, nor does their quality in most instances indicate that such will be likely in the future.

Usually, fullers' earth deposits are worked by stripping the overburden and quarrying the mineral by open cuts, but in the Woburn Sands, properly timbered underground galleries are now driven, replacing the series of little independent pits or "earth wells" which were favoured when the industry was in the hands of numerous small operators.

The mineral as taken from the workings is always mixed with more or less foreign substances, and needs preparation. This consists in crushing and levigating, by which the finest particles (or valuable portion) are carried off in suspension by a stream of water to settling tanks, while the coarser (chiefly impurities) are arrested, quite a great length of shallow trough with slight ribs across the bottom being necessary to effect complete separation. The apparatus is called a "maggie" in Devonshire and Somersetshire. Finally the impalpable mud of fullers' earth is dried, first by standing for a long time in tanks, from which the water is drawn off by degrees from the surface downwards by means of little holes in the sides, stopped by pegs; and lastly by applying fire beneath a very large shallow tank, with a floor of porous tiles, lying over a series of wide flat flues, the heat from the fire passing through all the flues to a chimney, and thus sucking much of the moisture through the porous floor.

Fullers' earth possesses great detergent power, and is much used for cleaning woollen goods from grease, and in refining oils and lard,

quantities being sent from England to Chicago for the latter purpose.

There seems to be much difference of opinion * among consumers as to the respective merits of yellow and blue earth. Probably there is little to choose between them, except that the greater prevalence of iron salts in the blue kinds may be detrimental in some applications. The Woburn earth is less calcareous than that of Bath; and there is more iron in those of Bedford and Surrey than in that of Gloucester. Extensive beds of earth occurring at Rhiwlas, N. Wales, † while possessing almost exactly the same composition as some earth from Nutfield, Surrey, present a great contrast in physical characters, being soft, earthy, friable and dark grey, instead of hard and greasy feeling.

* A. C. G. Cameron, "Geology, Mining, and Economic Uses of Fullers' Earth," *Trans. Fed. Inst. Min. Engs.*, vi. 204.

† P. G. Sanford, *Geol. Mag.*, x. 160.

GEMS.

UNDER this heading are included the few precious mineral products used for personal adornment in the form of jewellery, and comprising chiefly the diamond, emerald, lapis lazuli, opal, ruby, sapphire, topaz, and turquoise. Semi-precious stones such as agate, calcedony, onyx, &c., used in architectural display are embraced under Stone.

Diamond.—In composition the diamond is pure carbon; it has a sp. gr. of 3.515–3.525, its hardness is 10, and its hue varies from colourless transparency to white, grey, brown, red, yellow, green, blue, and even black.

The by far most important diamond fields of the present day lie in Griqualand West, a portion of Cape Colony, chiefly in a radius of $1\frac{1}{2}$ miles around the De Beers mine, in a blue conglomerate.

The diamantiferous or “blue” ground is a hard, dark greenish-blue cement, which requires to be blasted with dynamite. It might properly be called a brecciated rock or cement, since the mass is composed of angular pieces of black shale, irregular pieces of mica and several more or less decomposed minerals, all imbedded in a mass of indurated talc, or rock of that nature.

Large masses of “floating” shale or reef are found imbedded in the “blue,” also basaltic boulders from one foot to many feet in diameter. These are, without doubt, portions of the rock which surrounded the opening or crater before the deposit of the “blue” was made.

Gardner Williams is of opinion that the formation of the diamond-bearing deposits was due to aqueous rather than igneous agencies—possibly to something in the nature of mud-volcanoes. His reasons for this belief are, first, the physical appearance of the mass of diamond-bearing ground, and, second, the existence of the diamonds themselves, the presence of which seems more natural in an aqueous than an igneous deposit.

That the masses of diamantiferous material occupy the craters of former volcanoes, there is but little doubt.

In whatever manner the diamonds may have been formed, they must have been crystallised before they were deposited in the mass in which they now occur. No diamonds have been found either in the shale or in the hard rock surrounding the “blue,” as might be expected if the diamonds had crystallised where they are found. Again, a great many fragments of broken diamonds are found, and the corresponding pieces are not found near them, showing that they are not in their original position.

One fact deserves special mention, namely, the variety of diamonds not only in different mines, but in different parts of the same mine. It requires no great skill to determine from which place

a lot of stones have been taken. The peculiarities consist in colour, size, crystallisation, black spots in the crystals, and the amount of broken or irregularly shaped pieces, called "bort."

In one part of the mine the stones are perfect octahedrons, while in another part the crystallisation is more imperfect; in one part the stones will be white while in another the majority of stones will be yellow.

The original system of mining the Kimberley ground, namely by open quarry, was the best for a depth of say 200 ft., because the mine could have been worked in no other way while the claims were operated by individual owners. But as soon as a greater depth was attained, the removal of the surrounding "reef" and the almost constant covering up of some part of the mine with fallen reef, rendered the cost of mining very great and also prevented the mining of the "blue" for months at a time in the covered parts of the mine.

Two methods are now advocated for working the mine. Many cling with pertinacity to the old open-mine method, and advocate the removal of the shale to an angle of safety, so that it would be impossible for it to cave into the mine. The friends of this method are relying upon the hard rock remaining in place, when exposed for several hundred feet in depth. The enormous quantity of shale (4,679,000 cub. yd.) to be removed makes this method too expensive; and besides, sooner or later the hard rock would give way and the mine be filled with huge masses of exceedingly hard rock. The cost of removing this, should it fall into the mine, would be very great.

The other method of working the mine is by sinking shafts, in the solid ground outside of the mine, and drifting to the "blue" ground. The "blue" ground can then be mined by drifting and stoping. The greatest difficulty in the way of close mining is the scarcity of timber. All timbers and other lumber have to be brought from the Baltic or from America. The ground must therefore be mined with the use of as few timbers as possible.

The depth of the diamond-bearing deposit is wholly unknown, and has not been tested by boring. The blue ground is richer below than it was near surface. The water pumped out yearly is 11-13 million gal., at a cost of 6*d.* per 100 gal.

The diamantiferous "blue" ground is blasted out in the mines, and hauled to surface by large skips working in inclined shafts. The De Beers No. 2 shaft (Fig. 86) is capable of landing 3000 tons a day.

The unit of measurement locally employed is the "load," 1 load, or truckful, weighing 22-25 cwt. Each skip of the pair at this shaft brings up, and automatically dumps into a hopper, sufficient material to make 3 or 4 loads per ascent. A train of empty detached trucks is brought underneath the shoot by which the hopper is discharged, and as truck after truck is filled, it is attached, by means of a Y fork on the top of the truck, to a slow-travelling endless wire cable, which conveys the train along a tramway to the weathering floors. A continuous train of loaded trucks may be thus seen in procession,

separated about 10 yd. apart from truck to truck, and the whole travelling at about the rate of 60 ft. per minute. The number of

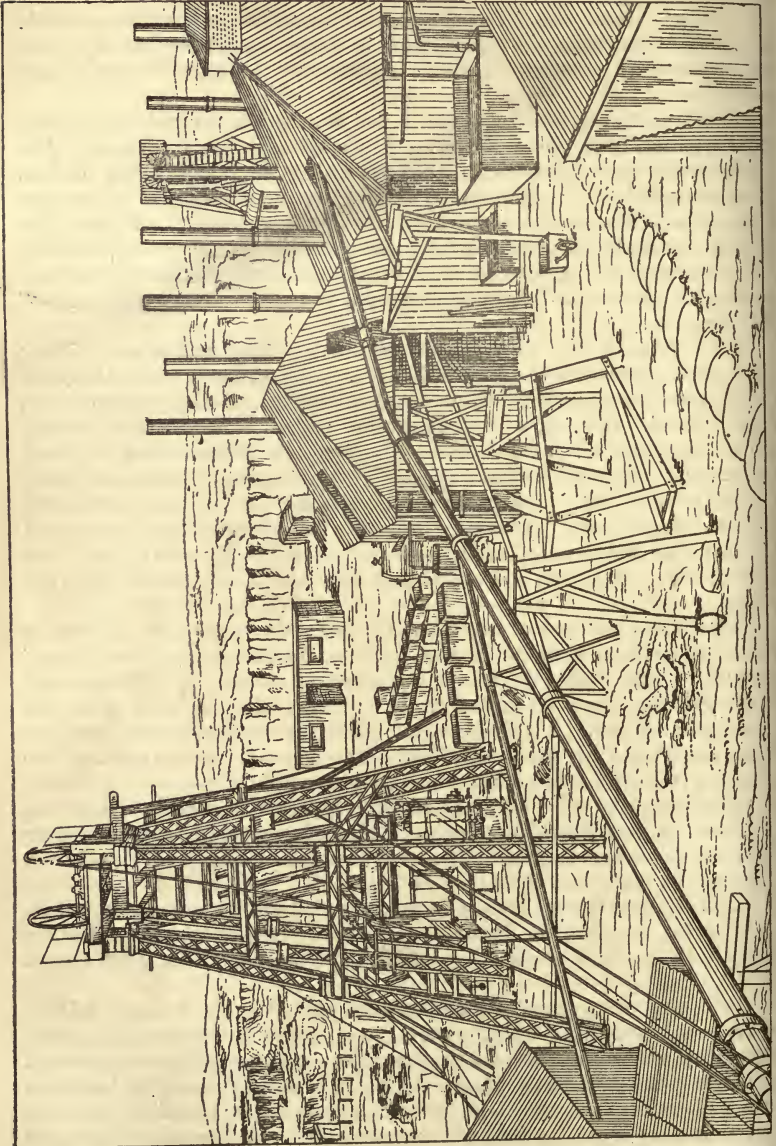

FIG. 80. — Dr. RAMES NO. 2 SHAFT. KIMBERLEY.

loads which pass a given point is automatically registered by a counter of the ordinary revolution-indicator construction—an arm

rom the counter which projects over the tram line, engaging each ruck as it passes. The mining and hauling capabilities of the plant are in excess of the facilities for the subsequent treatment of the "blue ground"; thus, in the first year of the Consolidated Company's operations, while some 950,000 loads were mined and hauled, only some 720,000 loads were washed for diamonds. A reserve of "blue ground" is thus being accumulated, and a longer period can be allowed for its more complete disintegration on the weathering floors before it is washed for diamonds.

The weathering floors are widely scattered over the company's property, and together cover an area which may be estimated in square miles. Upon these floors—which are simply areas of hard rolled ground, moderately level, and free from vegetation—the lumps of "blue ground," in stones measuring from about 9 in. diam. downwards, are spread out in a shallow layer not more than 12 in. deep. The length of time for which the diamantiferous earth is thus exposed to atmospheric influence is generally about one year, but by turning over the lumps, harrowing the stuff, and artificially watering it, its disintegration can be greatly hastened, and the whole made ready for washing after an exposure of 6 months, or even less.

The first treatment of the weathered "blue ground" is conducted in a number of small isolated works, situated for convenience in proximity to the different weathering floors. To all intents and purposes this first treatment is the same as that pursued by those who are engaged in rewashing old heaps, only the plant of the Consolidated Company is in all cases larger, and is actuated by steam power instead of by manual labour. The disintegrated mass, when agitated with an excess of water, yields a fine clay mud, which overflows by a lip on the edge of the pan, to be raised by bucket elevators to the summit of the débris heap, over which it is poured, while the granular residue remaining in the pan is reserved for the second treatment. Owing to the scarcity of good building stone, the retaining walls, to support the débris heaps as they grow higher and higher by the continual addition of waste mud, are constructed of large and heavy sand-bags, flattened out and piled one on top of another. An illustration of one of these establishments is given in Fig. 87.

Near the central works of the Consolidated Company, at which the diamonds are finally separated, there is a washing installation of considerably larger size, but it is worked on precisely the same principle as the smaller ones. It consists of a series of some 10 pans, at different levels, and the waste mud from all of them is run by gravitation to depositing tanks beneath the lowest of the series. From these the mud is discharged by sluice doors into iron box-carriages of about 80 gal. capacity, and these are transported by an aerial wire-rope railway to the summit of a débris heap, 200 or 300 yd. distant, where they are automatically tipped and emptied.

The granular residue from the various washing establishments is now conveyed, for the second treatment, to the central works, known locally as the "pulsators." These pulsators consist simply of a small ordinary ore-dressing plant, such as is universally employed for the

purpose of separating and concentrating poor ores of copper, lead, and other minerals. It comprises two sets of jigs (right-hand and left-

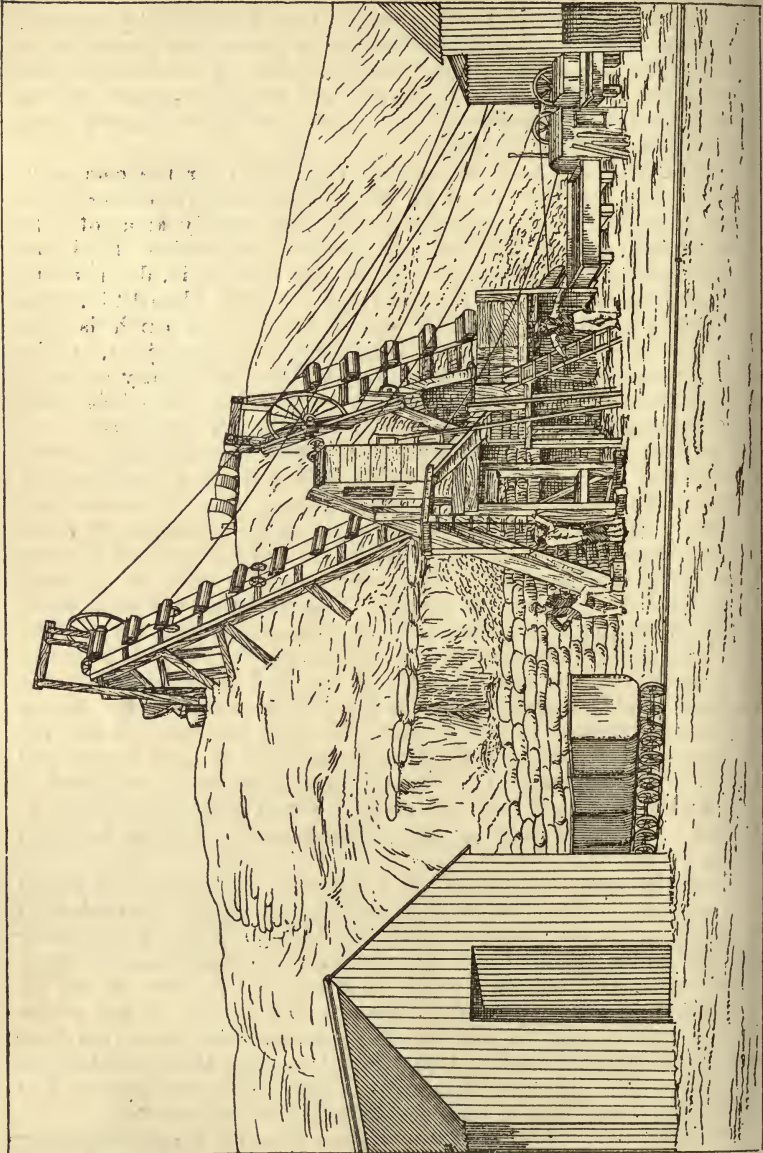

hand) having 4 compartments each, and fitted with the necessary sizing and classifying trommels. The alternating ebb and flow

ovement of the water in the jigs frees the gravel from all adhering mud, and allows the diamonds to be readily detected afterwards. This plant is capable of treating 5000 loads of diamantiferous concentrates a day, this being the product from the washing of 50,000 loads of blue ground."

From the pulsators, the clean, and uniformly-sized gravel and sand of four grades of fineness, is removed to the sorting tables, to be carefully looked over and picked by hand, in the same way as the sands from the re-washed old heaps. The sorting tables are placed underneath a long shed, open in front to a commodious yard, the whole of this department being enclosed by a substantial wall and guarded by sentries. The examination of the coarser gravel is entrusted to white men, either English or Africander. They are paid well, and are not subjected to the ignominy of being searched before leaving work as are the Kaffirs. The finer gravel or sand is scrutinised entirely by Kaffirs, most of them being convicts. Tin vessels, with inverted conical lids having a small hole at the apex and closed by locks, the keys of which are kept by the superintendent of the department, are placed on each sorting table, and every diamond, as soon as it is discovered, must be dropped into this receptacle. Roughly speaking, the average yield of diamonds per load of "blue ground" is 1 to $1\frac{1}{4}$ carat, but the value of the carat is liable to considerable fluctuations. During the first year of the Consolidated company's existence, the realised value per carat was just under 20s., while during the second year nearly 33s. per carat was realised, the total output being 1,608,830 carats, valued at 2,641,558*l.* Very many of the stones are "off-coloured," and do not realise the price per carat of stones from river workings.

A large amount of manual labour is required on the floors in picking and spalling the lumps. A new method of rolling and harrowing the blue ground was introduced by A. W. Davis, the general manager of the Bultfontein Company. This company formerly used rollers and harrows drawn by cattle in the usual manner adopted by other mines. The new method is the adaptation of a 22-ton steam roller, the hind rolls of which are 7 ft. and the front rolls 4 ft. 7 in. diam. The roller covers a 9-ft. track. Steel ribs are bolted diagonally to each roller, and a harrow is attached to the back of the tender. After the blue ground is crushed by the roller teeth, it is turned up for a second crushing by the harrow. This process is continued until the desired degree of fineness is obtained. It dispenses with the costly and tedious method formerly employed, and renders the mine independent of the natives on the crushing floors. Further, it tends to check diamond stealing, as more diamonds have been stolen from the floors than from elsewhere. Although coal costs 8*l.* per ton, the cost of running the roller, inclusive of everything, does not exceed 0*l.* a week.

The washing machine or pan is made of steel, 10 to 15 ft. diam. and $1\frac{1}{2}$ to 2 ft. deep. This is fixed, and from the central shaft the arms, 10 in number, are revolved. On these are fixed several knives or teeth, the object of which is to agitate the material under treatment. These reach to within $\frac{1}{2}$ in. of the bottom of the pan. The

stuff, mixed with water, enters at the outer rim of the pan, and the light waste is taken away at the centre. The tailings are lifted by means of an elevator and banked, the bank in some cases reaching a height of 60 ft. At the top of the elevator the buckets deliver the tailings on a suitable screen on which most of the solid matter runs to waste, while the thick water is led back by a launder to the machine to assist in forming a "puddle" of sufficient density to float the lighter stones in the pan, and allow only the heaviest gravel to accumulate at the bottom. At the end of the day's work the machine is stopped, and the contents of the pan are taken out to be submitted to a cleaning process by means of the pulsator, cradle, or small gravitating machine. It is then brought to the sorting table. Great care must be taken in fixing the pans truly level. To test the efficiency of the machines, it is the practice to put in a few inferior or curiously shaped diamonds which may be easily recognised by the watchers. These are called test stones, and, if the machine is working well, are invariably found again amongst the residue in the pan.

The cradle machine consists of a tier of 2 or 3 square sieves on a pair of rockers. The top sieve is the coarsest and retains the largest stones, whilst the mud and sand are washed through.

The river diggings may be said to be all in alluvium, which consists of a heavy deposit of ferruginous gravel mixed with red sand and boulders. The same, no doubt, was washed and imbedded in the crevices of the rock by floods, as a large number of river diamonds are found coated with oxide of iron, and, if cracked, it will be found that this has penetrated. As a natural consequence the stone is discoloured, and this has a tendency to interfere with its value, but notwithstanding this, they are generally free from faults and flaws.

Sometimes a portion of the old river bed is found, where the stones as a rule are very good. Explosives are seldom used. The boulders and large stones are thrown aside, and the diamantiferous gravel is excavated with pick, shovel, and crowbars in the ordinary way. This gravel varies at various diggings. The average will be found to be in something like the following proportions: one of boulders, which must be thrown away, one of rough stones, to be served likewise, one of fine sand, and finally, the productive gravel which remains to be treated. The following is the chief mode of their working and washing. There is a sifting machine termed "baby" which consists of an oblong sieve, about 5 ft. long, and of very fine mesh. It swings by 4 ropes, or thongs, sometimes by small chains. It is fixed, as a rule, with 4 nearly upright poles, slightly inclined, so that the gravel may roll over it. At the top, or feeding end, a sieve about 2 ft. square is fixed over the baby, and this will admit of small pebbles passing through. The ground taken from the claims is put into the square sieve; the native or boy standing at the head swings it to and fro, and thus makes the separation, the roughs and finest being thrown away as refuse. The medium size gravel which has been caught at the bottom end of the baby, as a rule, contains the diamonds. If there should be a large stone it ought to be immediately noticed by the man who is placed at the head or top of the machine, and whose duty it is to continually throw the rough stones out in order to make room for the other ground to be treated. Any diamond so small as

to pass through the sieve with the fine sand is not worth the trouble of searching for. This process is called dry sorting. In the next ("wet" or "gravitating") use is made of a round sieve, similar to those used in copper mining, with the handles taken off, so that when the serving is settled by its operator, it is taken up out of the water, and turned upside down on the sorting table. If he has managed his work properly, all the heavy deposits will appear on the surface of the mould or bottom contents of the sieve, and consequently, at a glance, the diamonds, if there should be any, would be discovered. To guard against the risk of losing any, he dissects the whole of the contents of the sieve with what we should call a scraper, known to him as a sorting knife. After a careful examination the whole is brushed off from the table to continue the treatment of a fresh supply. An experienced sorter can tell from the appearance of the deposit whether there is a chance of finding or not; finding the heaviest stones that occur in diamond-bearing gravel is a sure sign of the presence of these precious stones. This is particularly the case if a peculiarly marked pebble, streaked with a succession of parallel rings, known by the name of "Banddoo," the specific gravity of which is almost the same as the diamond, is present, and where the former is found the latter may be confidently expected. The average quantity of maiden ground that a man can excavate per day is about 1½ loads of rough gravel and sand, which, after being put through the machine or baby, yields ½ load of pebbles to be washed, costing for picking, sifting, and washing, 2s. 6d. per load of 22½ cub. ft., or thereabouts.

PRODUCTION OF DIAMONDS AT THE DE BEERS CONSOLIDATED MINES.

Year ending March 31st.	Loads Hoisted.	Loads Washed.	Carats Found.	Value.		Carats per Load.	Value per Carat.		Cost per Load.	Loads on Floors, Close of Year.
				£	s. d.		£	s. d.		
89	944,706	712,263	914,121	901,118	0 5	1·283	0 19 8¼	9 10½	476,403	
90	2,192,226	1,325,400	1,450,605	2,330,179	16 3	1·09	1 12 6¾	8 10½	1,576,821	
91	1,978,153	2,105,182	2,020,515	2,974,670	9 0	·96	1 9 6	8 8	1,449,792	
92	3,338,553	*3,239,134	3,035,481	3,931,542	11 1	·92	1 5 6	7 4¾	1,624,803	
1893										

* And Du Toit's Pan and Bultfontein 454,278.

Totals, 7,420,722 carats, valued at 10,148,210l. 16s. 9d. Dividends paid since 1888, 2,849,936l. 15s.

Date.	Dividends Paid.			Equal to per cent.	Capital. £
	Amount.	£	s. d.		
1888	188,329	10	0	5	3,937,050
1889	394,786	10	0	10	3,948,955
	394,895	10	0	10	
1890	394,895	10	0	10	3,948,955
	394,895	10	0	10	
1891	394,895	10	0	10	3,948,955
	493,619	7	6	12½	
1892	493,619	7	6	12½	3,948,955
June 30					



Second in importance among diamond-producing countries is India, where, according to Ball,* are 3 extensive tracts, widely separated from one another, in which the diamond is known to occur; and others where, although the fact of the occurrence of diamonds has been recorded, information in reference to the circumstances connected therewith is less perfect.

The most southern of these tracts, or part of it, has long borne a familiar name, which, however, must be characterised as being, to a certain extent, a misnomer. Golconda (Kala-Kandār), itself, never produced diamonds; it was, in fact, merely the mart where they were bought and sold. The districts included in this southern tract, in the Madras Presidency, where are or have been diamond mines, are Kadapah (Cuddapah), Bellary, Karnul, Kistna, and Godavari.

The second great tract occupies a considerable area between the Mahanadi and Godavari rivers. Although diamonds are known but from two neighbourhoods within it, still it is not improbable that the diamond-bearing strata may have a wide range. The two neighbourhoods referred to are Sambalpur, with the bed of the Mahanadi for many miles above it, and Wairagarh or Weiragud, 80 miles to the south-east of Nagpur. Again, as an outlier to this second tract, are two or three localities within the province of Chutia Nagpur, where diamonds have been found.

The third great tract is situated in Bundelkhand, near one of the chief towns in which, Panna, some of the principal mines are situated; but there are others scattered about in various parts of that province.

At Panna diamonds are only known certainly to occur *in situ* in a conglomerate which is referred to the Rewah group (Upper Vindhyan). There, however, as elsewhere, are numerous workings in alluvial or superficial deposits; but the greatest amount of labour is spent in mining in this the bottom bed of the group, which, though it has a wide extension, has only as yet been ascertained to be diamond-bearing in the neighbourhood of Panna town. Although diamonds have not been obtained directly from any lower group, it would appear that this conglomerate is largely made up of pebbles derived from the lowest or Semri sandstone group (Lower Vindhyan), and since it is stated by the native miners that diamonds are sometimes found in these pebbles when broken up, it would seem that the latter must include an earlier, if not the original matrix of the gem. This point is of great interest, since it brings us to a horizon, the base of the formation, which is strictly comparable with that of the Banaganpilly group (Karnul), which includes the lowest known matrix in Southern India.

The order of succession of the rocks in the Mahanadi-Godavari tract has not yet been fully ascertained; but from the fact of the only known localities where the diamond occurs being situated on the margins of the area, it may with a considerable degree of probability be assumed that the matrix is in a bed close to the base of the formation.

Some interesting remarks by Griesbach have been published upon the correlation of the Vindhyan rocks of India with certain series

* 'Economic Geology of India.'

occurring in South Africa, to one of which the sandstones of the Table Mountain belong. The possibility of the original matrix of the Cape diamonds belonging to a period or horizon directly comparable to that which includes the Indian diamonds, is a subject worthy of future investigation. It is noteworthy that a rock very similar to Indian laterite appears to occur in the same parts of Africa, and that the Gondwana rocks are also represented in that country. A comparison of the geology of Borneo with that of India may also prove productive of interesting results in this respect.

According to King, the quartzites of the Banaganpilly group form a cap, resting unconformably on the denuded surface of a much older set of shales and traps with some limestone bands. The quartzite covering is 20–30 ft. thick, and it is pierced here and there over the Banaganpilly end of the hill by shafts of 15 ft. or less, from the bottoms of which nearly horizontal galleries are run to get at the seams of diamond gangue. The capping is composed of compact grits and sandstones in thickish beds above, and somewhat thinner bedded towards the bottom.

Externally the rocks are hard and vitreous. At the level of the galleries there are beds of coarse pebbly conglomerate, occasionally a breccia, which are sandy and clayey, and with these run seams of more shaly and clayey stuff. There is no trace of the clayey constitution on the outside along the outcrop, nor are there any distinct bands of shales; there are only some sandy shales down at, or near, the bottom of the series.

In the mines the coolies pick out a seam about 6 or 8 in. thick, occurring with thicker and harder beds of sandstone, as the diamond layer; this rock is an easily broken-up, damp, clayey conglomerate, and partly brecciated, of small rounded fragments and pebbles of black, red, green, and pale coloured shales and cherts, and of quartzite with large and small grains of dirty and pellucid quartz. The gangue is pounded up, washed, sifted, and laid out to dry on prepared floors, after which the residue of clean sand is carefully examined in the hand, by the women and children of the working parties, for the gems.

With regard to the origin of the Sambalpur diamonds, the geological structure of the country leaves but little room for doubt as to the source from whence they are derived. Coincident with their occurrence is that of a group of rocks, referable to the Lower Vindhyan or Karnul series, certain members of which series are now found, or are believed to have formerly existed, in the vicinity of all the known diamond-yielding localities in India, and in the case of actual rock-workings include the matrix of the gems.

The fact that the place (Hira Khund) where the diamonds were washed for is on metamorphic rocks, may be readily explained by the physical features of the ground. The rocky nature of the bed there, and the double channel caused by the island, afforded unusual facilities for, in the first place, the retention of the diamonds brought down by the river, and secondly, for the operations by which the bed could on one side be laid bare, and the gravel washed by the simple contrivances known to the natives.

It is impossible to say at present which the actual bed or beds of rock may be whence the diamonds have been derived, as there is no record or appearance of the rock matrix ever having been worked; but from the general lithological resemblance of the sandstones and shales of the Barapahar hills, with the diamond-bearing beds, and their associates in other parts of India, it seems not improbable that they include the matrix.

The diamond stratum at Kamariya, locally called *kakru*, consists of a conglomeratic sandstone made up of pebbles, $\frac{1}{8}$ – $\frac{1}{2}$ in. diam., imbedded in a rather fine matrix, which also includes clay galls. The lower Rewah sandstone here stretches out a considerable distance in front of the scarp, and the pit was just on the northern edge of this terrace, some 20 ft. below the summit, and itself about 10 ft. deep. On the top of the diamond bed was 1 ft. or so of hard thin flaggy sandstone, and about 7 ft. of the same mixed with shale. A little farther to the south and west, on this terrace, was an old pit between 30 and 40 ft. deep, but the bottom was filled with water, so that the rocks immediately above the diamond bed could not be seen; there were, however, certainly 10–15 ft. of shale between it and the lower Rewah sandstone. In all the pits examined there must have been 10–20 ft. of intermediate shale. The Pannas are here very thin, so that this position is not much above the top of the Kaimurs (the lowest group of the Upper Vindhya).

So far as can be ascertained, the Panna mines have never yielded any diamond of remarkable size. But there can be little doubt that vast quantities of diamonds have been produced there which have commanded relatively a higher price than Brazilian and Cape diamonds. The influx of the latter into the Indian market of late years has, however, seriously depreciated the selling value of Indian stones, and but few find their way to the Calcutta market. According to Dr. Hamilton, in his time, 1813, a good many stones were found worth from Rs. 500 to Rs. 1000, and he says that the Raja had one supposed to be worth Rs. 50,000.

It would almost seem that except under a system of slavery the diamond cannot be worked for profitably in India. The present system, though not so called, practically amounts to much the same thing; the actual operatives are by advances bound hand and foot to the farmers of the mines, who are content to wait for months together without any return; their outlay too is very small, no heavy expenditure of capital being involved. But no particular stress, according to Ball, need be laid on the fact that the several attempts in Southern India, at Sambalpur, and at Panna, to work mines under European management have hitherto failed.

In Brazil, diamonds were discovered at Tejuco, now known as Diamantina, in Minas Geraes, in 1746, and at Jacobina, in Bahia, in 1755. The diamonds are found both in old river gravels and in the beds of rivers in whose bottoms numerous pot-holes are found. At San Juan de Chapada the diamonds occur imbedded in clay traversing itacolumite and itabirite (a hydromica-schist containing specular iron). At Corrego diamonds have been found in solid conglomerate. At Tibagy they are found in ancient and recent alluvium, and appear

to have been derived from a Devonian sandstone. In 1772 the Government began to work the mines, but the cost was too great, and in 1832 the monopoly was abolished. Nevertheless the output to 1850 is estimated at over 10 million carats, value 15 million sterling.

Since 1867 the production has rapidly dwindled, and at present does not amount to over 15,000 carats a year, worth about 20,000*l*. The rich placers of Diamantina and of the Ouro and Paraguay rivers became exhausted about 1840; the laws prohibiting the introduction of new slaves and providing for the gradual emancipation of the old ones, caused a scarcity of cheap labour, without which the mines could not be worked; the financial crisis of 1858 in Brazil caused an immense falling off in the value of diamonds, which in turn caused the abandonment of many mines; and the discovery of the great diamond mines in South Africa ruined the market for the smaller stones of Brazil.

A substance known as carbonado, carbonate, or carbon, was discovered at Chapada, Brazil, in 1845. It is an allotropic form of carbon, closely related to the diamond, and is found in small irregular crypto-crystalline masses of a dark grey or black colour. Although its density is not so great as the diamond, it is very much harder; in fact, it is the hardest substance known. It is found in small quantities in Borneo, but has not yet been discovered in the diamond fields of India or of South Africa. At first it was used only in cutting diamonds, but since the invention of the core-drill for boring in rocks it has found a greatly extended use, and is now employed for the so-called "diamond crown" of this drill. In 1850 it was worth only 1*s*. per carat, and the demand was limited; but at present it is worth about 3*l*. per carat, and the production has increased to 20,000 carats per annum. The "bort" of the South African mines finds a similar industrial application, being worthless as a gem.

Emerald.—The composition of the emerald is 65 per cent. silica, 14 alumina, 13 glucina, 3.5 chromium oxide, 2.5 lime; hardness, 7.5; sp. gr., 2.7; colour, rich deep green; somewhat brittle, transparent to subtranslucent. Europe is said to possess emeralds in Norway and Austria. In Asia, they have been found in the Urals and Altai Mountains, in Burma, and on the Siberian frontier of China. African emeralds are found in mica-slate beds in the Sahara, and at the junction of the Harrach and Oued Bouman rivers, in Algeria. The principal modern source of the gem is in S. America, between the mountains of New Granada (Colombia) and Popayan. The mines of Muzo, in the Tunka Valley, about 75 miles from Bogota, the capital of Colombia, and classed by all writers on gems as the most famous mines in the world, were discovered by Lanchero in 1555. Work was commenced in 1568, and although no exact data are to be obtained, it is known that for many years the output of fine stones was so great that they ceased to be rare. The mines were abandoned about 1740, and so remained until 1844, when they were re-opened. Soon afterwards a French company was formed, and the mines were leased from the Government at an annual rental of 1600*l*. This company sent many fine stones to Paris; but the work evidently

did not pay, for the mines were abandoned in 1868. They are now leased by a company paying 5000*l.* annually, the lease to run until 1896.

The gems are found in a bituminous limestone, said to be of Lower Cretaceous age, which lies upon red sandstone (Triassic) and clay-slate. The emeralds occur either in isolated crystals or in geodes with calcite, iron pyrites, and parisite. Streeter describes the great Muzo mine and method of working as follows:—

“The mine has the form of a tunnel about 100 yd. deep, with very inclined walls. Near the mouth are several large reservoirs whose waters are shut off by gates. The overlying barren rock is cut out in benches and falls to the bottom of the tunnel. When this begins to fill, the water is turned on and the rock is carried away through an underground tunnel into a basin below. This operation is repeated until the stratum containing the gems is laid bare.”

Jade.—The jade-producing districts of Burma are partly enclosed by the Chindwin and Uru rivers, and lie between the 25th and 26th parallels of latitude. Jade is also found in the Myadaung district, and the most celebrated of all jade deposits is reported to be a large cliff overhanging the Chindwin, or a branch of that river, and distant 8 or 9 days' journey from the confluence of the Uru and Chindwin. Of this cliff, called by the Chinese traders “Nantlung,” or “difficult of access,” nothing is really known, as no traders have gone there for at least 20 years. Within the jade tract described above small quantities of stone have been found at many places, and abandoned quarries are numerous. The last old quarry of any size is Sanka, situated 70 miles north-west of Mogaung. The largest quarries now being worked are situated in the country of the Merip Kachins. The largest mine is about 50 yd. long, 40 broad, and 20 deep. The season for jade operations begins in November and lasts till May. The most productive quarries are generally flooded, and the labour of quarrying is much increased thereby. In February and March, when the floor of the pit can be kept dry for a few hours by baling, immense fires are lighted at the base of the stone. A careful watch is then kept in a tremendous heat, to detect the first signs of splitting. When this occurs the Kachins attack the stone with pickaxes and hammers, or detach portions by hauling on levers inserted in the cracks. The heat is almost insupportable, the labour severe, and the mortality among the workers is high. The Kachins claim the exclusive right of working the quarries, and there is not much disposition on the part of others to interfere; traders content themselves with buying the stone from the Kachins. All payments are made in rupees, and Burman or Burmo-Shan brokers are employed to settle the price. The jade is then taken by Shan and Kachin coolies to Namia Kyankseik, one long day's journey from Tomo. Thence it is carried by dug-outs down a small stream, which flows into the Tudaw river, about 3 miles below Sakaw, and down the Tudaw river itself to Mogaung. The Sawbwa of the jade-producing tract, Kansi, levies 5*s.* on every load of jade that leaves his country, the local chief at Namia Kyankseik takes another 2*s.*, and the farmer of the duties obtains an *ad valorem* duty of 33 per cent. The Kachins and Chinese-Shan coolies who work in the mines pay to

the Sawbwa, Kansai, 10 per cent. of the price they get from the jade merchants. The farming of the jade duty of 33 per cent. *ad valorem*, for the year ending June 30th, 1888, sold for 5000*l*.

Lapis-lazuli.—The composition of this gem is 45–50 per cent. silica, 30–32 alumina, 9 soda, 6 sulphuric acid, with minor quantities of lime, iron, chlorine, and sulphur; hardness, 5·5; sp. gr. 2·4; colour, ultramarine or fine azure-blue of varying intensity, depending, it would seem, upon the proportion of iron and sulphur. The stone occurs in Asia and S. America. A celebrated mine is in the valley of the Kokcha in Badakhshan; here it is met with in an unstratified limestone, and is extracted by heating the surface of the rock so that it can be flaked off by smart blows till the stone is exposed. Another source is the shores of the Shudank, near the Baikal Lake; also in many parts of China, and reputedly on the Indus. In the Cordillera of the Andes, near the sources of the Cazadero and Vias, tributaries of the Rio Grande, the gem is found in a thick stratum of limestone, accompanied by small quantities of iron pyrites.

The Badakhshan miners distinguish three varieties, called *nili* (indigo-coloured), *asmansi* (sky-blue), and *sabzi* (green). The mines are but little worked now, though at one time they produced hundreds of pounds weight of the gems.

Opal.—Composition, 90–95 per cent. silica, 5–10 water, with traces of iron, potash, soda, lime, alumina, &c.; of various colours and many varieties; the noble or precious opal, the only one to be considered here, exhibits a beautiful play of colour by refracted and reflected light. The only two sources of precious opal are Hungary and Mexico, the product of the former being by far the more valuable. The Hungarian mines are situated at Dubrick and Cservenicza, on the eastern slopes of the Labanka Mountains, the workings and waste heaps stretching for a distance of nearly 1½ miles.

The interstices of the andesite (a trachytic lava that forms the matrix of the precious mineral) are filled up with opal and hyalite. The felspathic ingredient of the rock is mostly in a metamorphosed condition, being changed partly into kaolin and partly into opal. The workings are quite extensive, the total length of the several galleries being about 2 miles. The opal-bearing rock is not disposed in vein or bed form; on the contrary, the precious stone is found in nests or pockets, and it not unfrequently happens that a considerable distance may be passed in workings without showing a sign of an opal.

Although the iridescent variety alone possesses a commercial value, it is of interest, from a mineralogical standpoint, to note the fact that all the varieties, milk opal, wax opal, fire opal, and hyalite, occur here in abundance. The last-named mineral is often found in most graceful stalactitic forms. The origin of the opal by the infiltration of water containing silica in solution, is here demonstrated in the most convincing manner. Large precious opals, it is said, are now rarely found; no specimens of the size of a hazel-nut have been found for a number of years. Formerly the mines were worked by private individuals, but since the year 1788 the proprietorship has been assumed by the Government, and the workings are conducted under Government supervision, affording at present a yearly revenue of about 15,000 florins

(1200*l.*). These opals vary in value from 1*l.* to 5*l.* a carat, and even higher, and are almost the only ones employed by jewellers.

The Mexican and Honduras stones come from Esperanza, Amealco, and Real del Monte, occurring in a porphyritic formation. They are beautiful when new, but soon lose their beauty, and are worth only a few pence a carat. S. Australia is said to afford a few specimens resembling the Hungarian; and some of particular beauty are reported from Beechworth, Victoria. A few have been found near Colfax, Washington, in a much altered basalt.

Ruby.—In composition the ruby varies from almost pure alumina to a compound containing 10–20 per cent. of magnesia, and always about 1 per cent. of iron oxide; hardness, 9; sp. gr., 4.6–4.8; colour, various shades of red. The ruby is essentially an Eastern gem. One celebrated mine is situated about 20 miles from Ishkashm, in a district called Gharan, on the right bank of the Oxus. The formation is either red sandstone or magnesian limestone, easily worked; the stones occur encased in nodules in seams and spots in the rock. Superior gems are found at Mo-gast and Kyat-pyan, 5 days S.E. of Ava, the workings being a monopoly of the King of Burma. Perhaps the finest come from a district between the north-east of Mandalay and the west of the Upper Solween river. Another noted locality is at the foot of the Capelan Mountains, near Sirian, in Pegu, where fine rubies are not rare; also near Kandy, in Ceylon, where good stones are very scarce. One has been found near Mount Eliza, on Port Philip Bay, Victoria; also one in Queensland; and another in New Zealand. Rubies of pure colour and fair size are the most valuable of all gems.

The search for these gems in Ceylon centres around Ratnapura, in a district 20 to 30 miles square, in almost all of which a stratum of gravel 6 ft. to 20 ft. under the surface exists. Throughout this area gem-pits are to be seen near the villages, some being worked now, others being abandoned. The natives work there in companies of 6 to 8, and pay 1 rupee per man per month for the privilege of working a certain allotment, where they begin by marking off a square of about 10 ft. After removing about 3 ft. of soil, the sounding rod, a piece of iron about $\frac{1}{2}$ in. diam. and 6 ft. long, is used to sound for the gravel. If successful, the digging is begun in earnest till about 4 ft. deep. On the second day gravel is taken out by means of baskets handed from one man to another till all within the square is excavated. Should the miners find the soil fairly firm at the bottom of the pit they tunnel all round for about 2 ft., drawing out the gravel and sending it up also to be heaped with the rest, which usually completes the work of the second day, a watchman remaining near it all night. On the third day it is all washed in wicker baskets by a circular jerking motion, which throws out all the surplus light stone and rubbish, till a good quantity of heavy gravel is left in the bottom, which is carefully examined. There is hardly a basketful that does not contain some gems of inferior value, which are usually sold by the lb. for about 9 rupees. Should no valuable stones be found, another pit is sunk, and so on till one or perhaps two or three really valuable gems are unearthed. A lower stratum of gravel is said to be richer in gems,

but is rarely worked on account of the difficulty of removing the water.

In Siam, the method of obtaining the precious stones is identical at all the diggings in the region of Bangkok, and is as follows:—The intending digger, on entering the district, pays 3 ticals (5s. 3d.) to the headman, a Burmese British subject appointed by the British Legation, and responsible to the governors of Battambang and Chantubong, according as the fees received are derived from the Phailin or Krat mines. Beyond this tax there is no further fee exacted. The Siamese Government claim no right to pre-empt gems found, or to purchase at market value all stones above a certain carat weight, as was the case in Burma. The Tongsoo digger's first object is to discover a layer of soft, yellowish sand, in which both rubies and sapphires are deposited. This stratum lies at depths varying from a few inches to 20 ft. on a bed of subsoil, on which no precious stones are found. A pit is dug until this corundum is exhausted, and the soil removed is then taken to a neighbouring canal or stream, one of which runs in the proximity of the mines, both at Phailin and Krat, where it is mixed with water, and passed through an ordinary hand-sieve. In his search for this peculiar alluvial deposit, which is generally free from any admixture of clayey earth, the digger has often to penetrate into the jungle that grows thickly around, and to combine the work of clearing with the occupation of gem-digging. The Tongsoos do not appear to form themselves into companies for mutual assistance or division of profits. They work principally in twos and threes, and if chance lead them to discover a gem of any value, they either undertake a sea voyage to Rangoon or Calcutta for the purpose of obtaining a good price for it themselves, with the dealers in precious stones at these places, or consign their acquisitions to an agent, while they themselves continue to search for more. A process of migration is continually going on amongst the Tongsoos of the different mines, the workers passing from one to the other, according to the reputation of a particular mine at certain periods. No artificial or mechanical processes for the washing of the soil have as yet been introduced, nor have gems been discovered in fissure veins of soft material imbedded in crevices of hard rock, or in crystal form. Rubies and sapphires are found at all the diggings, often deposited side by side in the same layer or stratum of sand. The ruby of "pigeons' blood" colour is rarely, if ever, met with. The colour of the Siam ruby is usually light red of a dull hue. The sapphire is of a dark, dull blue, without any of the silken gloss which is the distinctive mark of the Burma and Ceylon stone. Stones resembling garnets rather than rubies are found in the dried beds of water-courses at Raheng, 200 miles north of Bangkok, and there is every reason to believe that rubies also equal, if not superior, to those discovered in the south-east, exist throughout the Raheng district. Those hitherto obtained are the result merely of surface scratchings by Tongsoo seekers.

Sapphire.—Composition, about 98·5 per cent. of alumina, with oxide of iron and other colouring matter; hardness, 9; sq. gr., 4·6–4·8; colour, from translucent yellow or white to violet. Sapphires of great beauty are found in and near the Iser Mountains, in

Bohemia, and in the bed of the river Iser, mostly in quartz-sand and granite detritus. In Ceylon, good sapphires are not rare. Quite a rush recently took place to the mines of Battambang and Chantubong, in Siam, whence a stone of the finest water, weighing 370 carats in the rough, is credibly reported. Blue and white stones of some value have been found in Dandenong Creek, Victoria; at Ballarat, S. Australia; and in the Hanging-rock caves, near the Pearl River, New South Wales.

Most of what has been said about rubies refers also to sapphires, the two gems being intimately related and generally found together.

Topaz.—Composition, 34 per cent. silica, 57 alumina, 15 fluorine; hardness, 8; sp. gr., 3·5; colours, yellow, blue, and white. In Saxony, is found a pale-violet variety; and in Bohemia, a sea-green. Many occur in the Urals, north of Katharinburg, in granite and albite; and in E. Siberia. In the Brazilian province of Minas Geraes, numbers are met with in the auriferous gravels, especially at Capao. Some fine specimens have been got at Beechworth, Victoria, in Flinders Island, and in Tasmania.

Turquoise.—Composition, 47 alumina, 27 phosphoric acid, 3 lime phosphate, 2 copper oxide, 1 iron oxide, 19 water; hardness, 6; sp. gr. 2·6–2·8; colour, blue to blue-green. The Land of Midian possesses three turquoise mines: one at Aynuneh, a second near Ziba, and a third, known to the Bedouins as Jebelshehayk. But the stones come principally from the mountainous district of Nishabor (Neshapore), in N.E. Persia; the oldest mine is in the Bari Madán *bulúk*, and a second has recently been discovered in the hills to the south, separating Nishabor from Turshiz. Mashhad is the headquarters of the trade. Better stones at lower figures are said to be procurable at Shikapur, in Sind.

The number of small or seed turquoises of light tint found in the Persian mines is enormous. Recently 1½ lb. of the better grade of second-class stones were sold in Teheran for about 7*l.* sterling. Stones of a dark sky-blue tint are comparatively scarce. All the mines of Khorassan are farmed by officials connected with the Government. For this privilege they pay 18,000 tomans annually to the Shah, a sum equivalent to 6000*l.* The best stones are sent to Europe, and there is at present no evidence of exhaustion in the Persian mines.

During the past two years turquoise has been actively mined in New Mexico, at Los Cerillos and in Grant County. The latter mines produce stones having a faint greenish tinge, which is either due to a partial change or metamorphism which has taken place while the turquoise was in the rock, or may be a local peculiarity, but it is claimed by the owners of the mine that they are not subject to a change of colour. Turquoise has always been known as an unstable gem. Even the finest Persian stones are likely to change occasionally with scarcely any warning, the alteration probably being due to the turquoise coming in contact with acid exhalations from the skin, or fatty acids or alkalis in the soap used to wash the hands.

The sale of turquoise during the year 1891 from the New Mexican localities probably amounted to 25,000*l.*

GRAPHITE.

THE mineralised substance popularly known as blacklead or plumbago, and more correctly as graphite, is generally conceded to be of organic origin, the result of the metamorphism of some of the products of destructive distillation of vegetable tissue. It consists essentially of carbon, in mechanical admixture with varying proportions of silicious matter, as clay, sand, or limestone. Geologically it occurs in formations ranging from the Carboniferous back to the oldest rocks, and notably in close relation to gneiss. Sometimes it is found in beds and in true fissure veins, at other times disseminated through schists. Vein graphite is usually associated with calcite and quartz, and less frequently with apatite, mica, and pyroxene. Bed graphite is commonly amorphous.

By far the greater proportion of the yearly product of graphite now comes from Ceylon. Analysis shows the following composition:—

	Per cent.
Carbon	98·817 to 99·792
Ash	·05 „ ·415
Volatile matter	·108 „ ·9

But the quality and commercial value of graphite depend more upon physical structure than upon chemical composition. Thus the crystallised graphite of Ceylon, in which only 1·2 to 6 per cent. of foreign ingredients exists, is not fit for pencils; while the “blacklead” from Borrowdale, in England, with 13 per cent. of impurities, has been found to be very well suited for their manufacture. For the making of pencils, only a compact, grainy kind is suitable; while for crucibles, the loose mould, with graphite appearing in shiny scales, is preferable. This kind generally occurs with an enormous amount of mineral matter, unequally diffused through the mass, and producing thus, even in small hand-pieces, respective differences in its specific weight.

The most valuable kind of graphite is, of course, that which is applicable for the manufacture of pencils; but it is seldom found. A remarkable example was the Borrowdale mine, Cumberland, now worked out. With the diminished supply of Cumberland graphite, which needed next to no treatment, have come improvements in preparation whereby inferior grades have been rendered available. This mainly consists in separating, by grinding and levigating, the hard and impure portions of the rock. The commercial value of a new sample of graphite cannot be appraised without actual trial of its qualities for the specific purposes aimed at. The market values of the article cover such a wide range as from 9*l.* to 5000*l.* a ton. The ordinary product, adapted for crucibles, pencils, stove-polish, bearings, &c., as imported from Ceylon, is divided into four grades. “Large

lump" and "ordinary lump" are worth about 18*l.* to 20*l.* a ton; "chip," about 15*l.*; and "dust," about 12*l.* The exports amount to about 10,000 tons yearly.

A large proportion of the Ceylon graphite, on which the world's supply really depends, is mined by small native owners in a most primitive and wasteful manner.

The influx of water into the workings, even in small quantity, causes a cessation of operations and is soon followed by a caving of the walls and roofs of the tunnels and shafts, whereby in many cases the unworked portion of the deposit is buried from view and probably altogether lost. It is a very great pity that the whole graphite mining industry of the island is not placed under proper control, so that while advantage is taken of the cheap local mining labour, yet that operations may be conducted systematically and economically, and to far greater depths than is possible to the unaided native miner.

Germany possesses several graphite deposits. A variety about equal in purity to that of Cumberland, but somewhat more amorphous and friable, occurs in considerable quantities at Griesbach, near Passau, in Bavaria. It is not refractory, and is therefore valueless for crucible-making, and is of little use as a lubricator; but for pencils it is largely employed, and is imported into England, for making domestic blacklead (stove-polish). In the Adelheids-Glück coal-mine, at Rybnik, Prussian Silesia, an important layer of graphite earth has been found, in thickness exceeding 40 ft. Trials are said to have proved it well fitted for luting, muffles, hearths, &c. A specimen of graphite from Styria exhibited coarsely foliated structure, strong metallic lustre, and sp. gr. 2·1443. Its composition was:—Carbon, 82·4; silica (belonging to the ash), 12·38; alumina, 3·9; iron peroxide 0·53; manganese protosesquioxide, 0·62; lime, 0·02; alkalies, traces. The production of graphite in the Austro-Hungarian Empire is about 20,000 metric tons yearly, half of which is raised in Bohemia. Spain has lately sent some graphite of fair quality to this country. An analysis of Portuguese graphite gave:—Water (including hygroscopic), 10·21; carbon, 38·47; ash, 50·81. A sample from Upernavik, Greenland, hard and of pale colour, useless for pencils, showed:—Carbon, 96·6; ash, 3·4 per cent. An occurrence of graphite with quartz is reported from Arendal, Norway. The mineral has also been found in Finland.

The distribution of graphite in Asia is by no means inconsiderable. A deposit, said to be very abundant, has been discovered in the Bagoutal mountains of S. Siberia, near the Chinese frontier, of which great things are predicted. Seeböhm, in 1879, brought about 20 tons of almost pure graphite from the banks of the Kúrejka. The deposit is leased by a Russian from his Government, and has not yet been the scene of anything like scientific working. Two samples of Siberian graphite from Stephanovsky respectively revealed on analysis the following composition:—Carbon, 36·06, 33·20; silica, 37·72, 43·20; ferric oxide, 4·02, 3·05; alumina, 17·80, 15·42; lime and magnesia, 1·20, 1·06; volatile matters, 3·20, 4·03; sulphur, traces, 0·04. English graphite is said to be imported into Russia, for

admixture with the low-grade native produce. Deposits of lamellar graphite have been found in several parts of India. In 1862 a new mine was discovered at Sonah, near Goorgaon. The mineral is found in masses of variable size, and generally quite detached. In some cases the surrounding rock is impregnated with graphite, mixed with small micaceous particles. It yields on analysis:—Carbon, 78·45; silica and alumina, 12·98; iron peroxide, 3·30; lime carbonate, 0·84; water, 4·35; alkaline sulphates and chlorides, 0·08. Japan produced about 3500 tons in 1889, and 4500 in 1890.

The American production of graphite is almost entirely from the mines at Ticonderoga, N.Y., and its neighbourhood. The output had not much exceeded 200 tons of refined graphite in any year before 1891, when it reached about 700 tons, with an approximate average value of 35*l.* a ton. The old mines by which the place is best known are on a series of elliptical chimneys in gneiss which are filled with calcite and graphite. They were long since exhausted. The present source is a graphitic quartzite or schist in the town of Hague, N.Y., some 5 miles west of Lake George. There are crystalline limestones near Lake Champlain which also contain graphite, and might furnish the mineral. Any rock employed for this purpose must be free from mica, for it is impossible to separate two scaly minerals in the dressing.

A crude graphite, adapted for the manufacture of crucibles, stove blacking, &c., is found in conjunction with anthracite coal in Rhode Island. Graphite is also mined in Pennsylvania, Michigan, and Wyoming. Other deposits are known, but none is worked. Most of the graphite used in America comes from Ceylon.

The rock consisting of about 10 per cent. graphite and the remainder quartz, which is worked at Lake George, is crushed in a battery of California stamps and then washed with buddles and settlers, the percentage of graphite being thus raised to 40 or 50 per cent. This product is further treated at Ticonderoga by a secret washing process, whereby the grade is raised to 99 per cent.

The Styrian graphite undergoes no preparation for market beyond simple screening, which suffices to produce an article containing 73–88 per cent. of the actual mineral, the bulk of the impurity being silica, which renders it refractory and well adapted for crucible making.

The Bohemian article is softer, and is partially sorted underground into three classes. The first and second grades only need hand-picking and drying to be ready for packing in barrels. The third grade, which is harder and less pure, is ground in excess of water, and settled to get rid of the heavy gangue; the graphite slimes are afterwards pumped into filter presses, and the cakes taken from the presses are dried for market.

Graphite is largely used for pencils, and as a lubricant, for both of which purposes it must be soft and of high grade. Lower grades are used for crucibles, stove blacking, foundry facings, and as a substitute for redlead in pipe-fitting. It is also being extensively employed as a paint for covering smoke-stacks, boilers, tin roofs, &c., having been proved to be very durable. Recent experiments have

shown that a graphitic lining for Bessemer converters is specially adapted to withstand the cutting action of acid slag, and a large demand for graphite has come from steel works in consequence, especially in Germany, where this material has been adopted by the Krupp Works. Thus, the imports of graphite into Germany, from Ceylon, are said to have increased from about 3100 cwt. in the year ending June 1, 1889, to 14,215 cwt. in 1890, and 11,000 cwt. in 1891.

GYPSUM.

A VERY common mineral product is the rock known as gypsum or plaster, which occurs in two forms, the more familiar being a hydrated sulphate of lime containing about $32\frac{1}{2}$ per cent. lime, $46\frac{1}{2}$ sulphuric acid, and 21 water, while the other is an anhydrous variety (called anhydrite) consisting of over 41 per cent. lime and 58 sulphuric acid. Both forms are encountered in most geological formations, but are especially prominent in the Triassic salt-bearing series. The mineral is applied chiefly to two purposes—the preparation of plaster or stucco, and as a fertiliser (called “land plaster” in America). For the latter application, all samples may be said to serve equally well, and only require grinding, which, indeed, is often dispensed with. For use as plaster, however, the value of the article depends on its ability, after calcination, to “set” very rapidly on admixture with water, and consequently anhydrite is not applicable, being already free from water. Purity of colour is a desideratum.

The beds of gypsum of most importance in the plaster manufacture occur in the neighbourhood of Paris, in the Lower Tertiary formation. Different beds vary in respect of character and quantity of admixed materials, and in the structure of the gypsum itself. With regard to the first point, some deposits contain a notable proportion of lime carbonate, a fact which under certain circumstances may considerably influence the character of the plaster. In the matter of structure two principal varieties occur: granular and fibrous. Further, hardness of the granular kind varies considerably. These differences of structure in the original material appear to exercise an influence on the properties of the plaster. Thus plaster formed from the granular variety sets more gradually than that derived from the fibrous, and forms a denser mass. The softer kinds of the granular gypsum are those principally used in the production of plaster for the moulds of potteries.

In the old-fashioned process which is still employed for making the common kinds of plaster, the material is exposed to the direct action of flame. Large lumps are placed in the lower part of the furnace, above them smaller lumps, and, after the heating has been carried on for some time, finely divided material is filled in at the top. The outer portion of the larger lumps is always overburnt, and in the upper part of the furnace the presence of shining crystalline particles generally indicates the fact that some gypsum has remained unchanged. Provided that the amount of unburnt and of overburnt material does not exceed about 30 per cent. of the total, the plaster is suitable for many applications.

Both the differences in time of setting and in hardness of the resulting material are affected by the mode of baking. The hardest material is frequently obtained from the quick-setting plasters, but

for certain purposes this rapidity in setting is of great practical inconvenience. The moulder in pottery work must have leisure to fill in every detail of a design, often complicated and intricate, before the material with which he is working becomes intractable. Thus, for many of the more refined purposes to which plaster is applied, extreme hardness in the set plaster is of less vital importance than a convenient period of setting. On the other hand, plasters which set very slowly give, as a rule, too soft a material, as well as being inconvenient in use. Plasters which hit off the medium are alone suitable for the work of the potter. The finer varieties of plaster prepared especially for use in potteries are obtained by a treatment which differs in many respects from that described above for the commoner kinds. In the first place, the direct contact of fuel or even flame is avoided, since this reduces some of the sulphate to sulphide of calcium, the presence of which is in many respects objectionable. Secondly, it is necessary that there should be a better control over the temperature, since if the plaster be not partially dead burnt, it will set too quickly for the particular purpose to which it is to be put.

The arrangement employed in France is known as the *four à boulanger*, or bakers' furnace. The temperature attained in the furnace itself never exceeds low redness. The material preferred is the softer kind of the granular variety of gypsum. This is put in in pieces about $2\frac{1}{2}$ in. thick. After the baking, several lumps are broken up and examined to see that there are no shining crystalline particles, which would indicate that some of the gypsum had remained unchanged. Before use, the plaster is ground very fine. This point is of considerable practical importance. The consistency attained should be such that the material may be rubbed between the finger and thumb without any feeling of grittiness. Should there be particles of a size to be characterised as "grit," these will after use appear at the surface of the mould, with the result that the mould will have to be abandoned long before it is really worn out, i. e. before the details have lost their sharpness.

The quantity of gypsum mined annually in the United Kingdom is 100,000 to 150,000 tons, worth 7s. to 9s. a ton. In 1889 the United States produced over 250,000 tons, about half being raised in Michigan, and one-third of the whole product being calcined to make plaster. Analysis of the Michigan rock used as manure gave $78\frac{3}{4}$ per cent. lime sulphate, over 19 water, and less than $\frac{1}{2}$ each of magnesia and alumina.

INFUSORIAL EARTHS.

UNDER the names of diatomite, fossil meal, kieselguhr, &c., are included a number of infusorial earths, in the form of white, grey, or greenish powder of very low specific gravity, consisting chiefly of the minute silicious shields of diatomaceæ. Large deposits of fossil diatoms have been traced in many parts of the world, and several mines producing kieselguhr are worked in Europe, but the largest, and those yielding kieselguhr of the purest quality and lowest specific gravity, are situated near Naterleuss station, on the railway from Hamburg to Hanover. The kieselguhr is found there from the surface down to a depth of about 150 ft., being covered only by thin beds of diluvial and alluvial origin. The upper stratum of this large deposit supplies the white kieselguhr. This quality contains very little organic matter, but some sand; therefore, after being washed, it gives a very pure and porous product. The second stratum produces grey kieselguhr, containing very little sand, but sufficient organic matter for calcining it, and the product then is kieselguhr of the finest quality. If the exertions of colour manufacturers to make a colour which will really be imperishable under the influence of strong acids are to be crowned with success, this perhaps is the material which might lead to satisfactory results.

The lowest and by far the largest stratum, varying from 50 to 100 ft. in thickness, supplies the green kieselguhr, which contains up to 30 per cent. of organic matter, showing clear imprints and fragments of fishes, well-preserved fir-cones, leaves, bark, and twigs of birch, fir, &c. In order to utilise the immense deposits of green kieselguhr, kilns have been erected for burning or calcining it. When dry, this material glows like turf or peat, and this is utilised in the calcining process. The kilns, simple round furnaces, about 15 ft. high by 6 ft. diam., are filled and lighted at the bottom, no additional fuel being required to keep them going. They are continually replenished with green kieselguhr at the top, and the calcined is taken out from the grates underneath. The product is perfectly free from moisture and organic matter, and has therefore a much higher market value than green kieselguhr. Its reddish colour is due to some traces of oxide of iron.

Kieselguhr has many valuable properties. It consists almost exclusively of silica, and is therefore in its pure state as fireproof as any material in the world. It resists the action of the strongest acids, but it can be easily made to melt after being mixed with an alkali. Even by boiling under pressure, combination may be effected. Silicate of sodium or water glass has been made of it in this way, but white sand is now generally used for this article, because kieselguhr has risen considerably in price, and owing to its low specific gravity,

very large melting pots had to be employed. Its great porosity, although a drawback for this particular industry, makes it very valuable for the manufacture of dynamite.

It is used to a considerable extent in the manufacture of various cleansing preparations, either in the form of powder or so-called soap. There is but a step between the crude mineral and the merchantable articles used for cleansing purposes. To manufacture a polishing powder it is necessary only to clean and grind the crude mineral, the particles of which are loosely adherent, while in making soap the pulverised mineral is mixed with the other ingredients of soap manufacture. The greater portion of the American product is dried in furnaces at the pits, and used for making protective coating for boilers. As an absorbent in the manufacture of dynamite from nitroglycerine, the American product does not possess sufficient absorbent properties; and even the German product has been largely supplanted by wood pulp, which answers the purpose excellently and is much cheaper.

The American output in 1889 was over 3000 tons, nearly all from Dunkirk, Maryland, and valued at about 28s. a ton. The yield fell to 1700 tons in 1893. Various assays gave the following results:—

Ingredients.	From Pope's Creek, Maryland.	From Morris county, New Jersey.	From near Richmond, Virginia.	From Storey county, Nevada.
Moisture	3·47	..	8·37	..
Silica	81·53	80·66	75·86	81·08
Alumina	3·43	3·84	9·88	..
Iron protoxide	3·33
Lime	2·61	0·58	0·29	..
Ferric oxide	2·92	..
Magnesia, soda, potash, sulphur, and organic matter	5·63	..	1·63	..
Loss on ignition	14·01
Water at red heat	18·44
Loss	0·48
	100·00	99·09	98·95	100·00

IODINE.

APART from its wide distribution in the organic kingdoms, iodine is of common occurrence in the mineral kingdom, notably as sodium iodide in many kinds of rock salt, as sodium iodate in the mother-liquor from nitrate of soda works, as calcium iodide in the ocean, and in combination with potassium, sodium, magnesium, and calcium in many springs.

In the *caliche* or raw sodium nitrate (Chili saltpetre) deposits of South America, iodine is encountered in the form of sodium iodate, in quantities varying from mere traces to 50 per cent., and its recovery is conducted on an industrial scale, as described by R. Harvey.*

The *agua vieja*, or mother-liquor, of these works contains about--

	Per cent.
Sodium nitrate, NaNO_3	28
„ chloride, NaCl	11
„ sulphate, Na_2SO_4	3
Magnesium sulphate, MgSO_4	3
Sodium iodate, NaIO_3	22
Water, H_2O	33

The mother-liquor is conducted through the pipe for mother-water to the precipitators, which are constructed of 2-in. tongued and grooved timber, lined with sheet lead, to prevent leakage by warping and shrinking; they are stayed transversely by $\frac{3}{4}$ -in. bolts. The reagent for precipitating the iodine is the run-off from the tanks for acid deposits in sufficient quantity to precipitate the iodine held in solution, which is determined by measuring previous to precipitation. The wings, or fans, which are also of wood, are then turned by hand until the liquor becomes thoroughly mixed with the acid.

This causes most of the iodine to fall to the bottom of the precipitators in slimes and flakes, and some to rise to the surface as a black froth. The iodine on the surface is skimmed off by large wooden spoons and placed in clarifying tanks, and the mother-liquor is then drawn off to the tank for mother-water after precipitation. Thence it is returned to the sodium nitrate department, where it is again used, again becomes impregnated with iodine, and again goes through a similar process.

The deposit of iodine left in the bottom of the precipitators is taken out and placed in the clarifying tanks, where it undergoes a series of washings with pure water. It is then filtered and partially dried in a filter press, whence it is taken and pressed in the forming press, and is removed from the movable bottom of the press in blocks of cheese form, 8 in. diam. by 6 in. thick. The blocks are next placed in a cast-iron retort, to which are attached 8 earthenware receivers, each 3 ft. long by 2 ft. 6 in. diam. The last or end receiver is stopped

* Min. Proc. Inst. C.E., paper No. 1850.

by a wooden end and clay joint. The joints of the receivers are also made of clay. When the retort is charged, the crude iodine is sublimed by a slow fire. After sublimation, the retort is allowed to cool, the joints of the receivers are broken, the receivers are taken down and emptied, and the contents are placed in tarred kegs for exportation.

The crude iodine, previous to sublimation, contains: iodine, 80 to 85 per cent.; non-volatile matter, 6 to 10 per cent.; the remainder being water. The reagent for the precipitation of iodine is the acid sodium sulphite, NaHSO_3 , formed by saturating the aqueous solution of "salnatron" (impure sodium carbonate, Na_2CO_3) with fumes of burning sulphur. "Salnatron" is formed by burning coal-dust with sodium nitrate, thus: $2\text{NaNO}_3 + \text{C} = \text{Na}_2\text{CO}_3 + \text{N}_2\text{O}_3$. Its impurities consist of sodium chloride and sulphate, earthy matters, and unburnt coal; the latter are eliminated by dissolving the salnatron in water, and settling.

The fumes from the burning sulphur are generated in a firebrick oven, and are drawn by an ejector from the oven to the drainer, which catches the particles of partly burned sulphur, and from the drainer to the cylindrical fume receivers, which are charged with "salnatron" solution, and are traversed with perforated pipes for the passage of the fumes.

The steam for the ejector is taken from a small horizontal boiler at the extremity of the building. The building is well ventilated, and is made of wood and corrugated iron. The apparatus employed cost 23,000 dollars Chilian currency. During the months of October and November 1881, there were exported from Iquique 7560 lb. of sublimed iodine, manufactured by this plant.

A method proposed by Thiercelin for use in Chili and Peru is as follows:—The mother-liquors resulting from the manufacture of sodium nitrate are treated with a mixture of sulphurous acid and soda sulphite, in due proportions, and the iodine is precipitated as a black powder. The precipitated iodine is put into earthen jars, on the bottom of which are layers of quartz sand, fine at top and coarse below; from this it is removed by earthen spoons into boxes lined with gypsum, and a great part of the water is thus removed. It is sometimes sold in this impure state, or is further purified by sublimation.

JET.

THIS mineral is nothing more nor less than a species of pitch coal found in detached masses, grained like wood, splitting horizontally, light, and moderately hard. It is often confounded with "cannel" coal, but it is quite distinct. Cannel coal is much harder than jet, has no grain, and splits in any direction. Jet is not easily fused, and requires a moderately strong heat, burning with a fine, greenish-white flame, and emitting a bituminous smell.

In England it is found in greatest quantities in the neighbourhood of Whitby, in Yorkshire. There it is mixed with bitumenised wood and coniferous trees in the Upper Lias or alum shale of the district. In Prussia it occurs in association with amber, and is named by the amber-diggers "black amber." In France large quantities are found in the department of the Aude, where a great number of artisans find steady employment in fashioning it into rosaries, religious beads, and ornamental trinkets when fashion demands them. In Spain, jet is found at Villaviciosa, in the province of Asturias, and is manufactured principally at Oviedo.

Jet is of two distinct species, hard and soft; the latter is of very minor importance.

Hard jet is found in strata known as jet rock which occur in the Lias formation, some 90 ft. above the main band of Cleveland ironstone; it is discovered in compressed masses in layers of very different sizes, being generally $\frac{1}{2}$ - $2\frac{1}{2}$ in. thick, 4-30 in. wide and 4 or 5 ft. long. It invariably tapers away, running, as the miners say, to a "feather edge."

These jet layers are always protected by a skin, the colour making another division; for that found in the cliffs by the sea has always a blue skin, while that discovered in the inland hills has a yellow coating. The jet found in the same mine varies very much in quality; its worst specimens, those which are quite brown and will not take a polish, are termed "dazed" jet.

Soft jet is confined to the Lower Oolite—in the sandstone and shale—some 480 ft. higher than the hard jet, and is undoubtedly of purely ligneous origin, the fibre and the branches of trees being more or less distinctly marked.

The most valuable finds of jet have been washed down by the sea's action, where the jet rock crops out in the cliffs, and on the cliffs, where the seams are exposed. Nearly all the jet now obtained is found inland, and cliff jet is worked with the same mining operations as that lying under the inland hills.

The process is very simple. A mine is commenced by drifting into the face a passage of 7 ft. by 5 ft. A tramway is then laid down, and the shale is tilted from the mouth of the mine; the drift is continued for about 120 ft. at the rate of 2-4 ft. a day; then cross

drifts are started in a variety of directions. As soon as the rock becomes too hard, the miners retire, pulling in the roofs as they recede, for the bulk of the jet is found generally in the falling top rock.

Rough hard jet varies in value from 4s. to 21s. per lb., according to its closeness of texture, direction of grain, freedom from flaws, and breadth for working. Soft jet varies from 5s. 6d. to 30s. per stone. The price of Spanish is about the same as that of English soft jet. The Whitby hard jet is the best, not only for working, but it will take a fine polish, which it will retain for years, and it can be worked up into finer designs on account of its greater tenacity and elasticity.

Great Britain produced 618 lb. of jet, value 124*l.*, in 1889; and 1228 lb., value 245*l.*, in 1890. Spain turned out 55 tons of jet in 1890.

LIME.

LIME is one of the commonest and most widely distributed minerals, and at the same time one of the most useful. As chalk, as limestone, and as dolomite or magnesian limestone, it occurs in enormous beds, belonging notably to the Cretaceous, the Carboniferous, and the Oolitic systems, and easily worked by open quarrying. The composition of some representative limestones is given below.

	Carboniferous.	Oolitic.	Magnesian.
Lime carbonate	86 $\frac{1}{4}$ to 97 $\frac{1}{2}$	95	26 $\frac{1}{2}$ to 45 $\frac{1}{2}$
Magnesia carbonate	$\frac{1}{2}$ " 3 $\frac{1}{4}$	1 $\frac{1}{2}$	18 " 44 $\frac{1}{2}$
Silica	0 " 2 $\frac{1}{4}$..	0 " 51 $\frac{1}{2}$
Iron and alumina	$\frac{3}{4}$ " 1 $\frac{1}{4}$	$\frac{1}{2}$	0 " 1 $\frac{1}{2}$
Organic matter	$\frac{3}{4}$ " 4 $\frac{1}{2}$
Water	$\frac{1}{4}$ " $\frac{1}{2}$	2	0 " 2 $\frac{3}{4}$

The method of working deposits of limestone is influenced chiefly by the relative thickness of the limestone and the overburden, or "tiring," and partly also by the character of the roof formed by the overburden. In some of the underground workings in Scotland* the out-turn of stone per man per day at the working face is 4 tons, which would hardly be exceeded in quarrying. At the open works in N. Wales, after the overburden has been removed, the men are paid at the rate of 7*d.*–9*d.* a ton for getting and loading the rock, finding their own powder, but not tools or sharpening.

For agricultural purposes these minerals undergo no preparation; but for industrial application in the form of quicklime for mortar-making, &c., the chalk and limestone which contain no or very little magnesia, are burned in kilns to a caustic condition. To make 1 ton of quicklime requires about 1 $\frac{3}{4}$ ton of limestone, and consumes 4–8 cwt. of coal.

Lime is burned, similarly to bricks, in either open or closed kilns, and either coal or coke is generally in use as the fuel. The feeding in of material and fuel may be intermittent, each charge being burned and drawn before a new charge is introduced; or the feeding and drawing may be continuous, in which case the material and fuel are fed in at the top, as space is afforded by the drawing of burned lime at the bottom of the kiln. The former method of burning is most in use with closed kilns, and the latter where the kilns are open.

The ordinary form of an open lime-kiln is that of a deep pit, narrowing towards the bottom, and lined with refractory stone or

* J. Morison, "Limestone Mining in Scotland," Trans. Fed. Inst. Min. Engs., vi. 199.

firebrick ; and at the bottom on one side is a shoot or opening through which the burned lime is discharged. The exterior is built square with stone, and where a pair of such pits are placed side by side the discharge is effected into an arched passage constructed between them below. Such a kiln is worked on the continuous system, alternate layers of limestone or chalk and fuel being charged in. Another kind of open kiln used for burning Lias limestone is a shallow pit ; after the pit has been filled, more limestone and fuel are laid on the top so as to form a conical heap, which is finally covered with a layer of earth patted down upon its surface. This kiln is worked on the intermittent system.

The closed kilns in common use are similar to some of the closed kilns used for brick-burning. One of these forms, favoured in the glass-making districts of the north of England, is the "Newcastle kiln." It consists of an arched chamber, having communications behind at the lower part with a flue, and having an opening or doorway in front, which during burning is bricked up. The front part is marked off from the rest of the floor by a low brick ridge, behind which the limestone is built up, yet so as to leave near the floor passages about 18 in. high from the ridge to within about 3 ft. of the back wall of the kiln. The fire is sometimes placed on the floor in front of the ridge, and small air openings are left in the bricked-up doorway ; but in other cases fires are kindled over fire-bars with ashpits beneath : in either case there are openings provided for the feeding in of fuel. The smoke passes into the flue, and is conducted by it from all the kilns in a series to a chimney. This kiln is worked intermittently. Another form of close kiln is essentially an ordinary open kiln covered or domed in at the top, having an opening near the top which conducts smoke, &c., into a flue. At alkali works, where coke is used as fuel, the carbonic acid generated from the combustion is carried into the works by a pipe, and used in the manufacture of carbonate of soda.

At the Harper Works of the Buxton Lime Co., a Hofmann kiln is used. It is of similar construction to that in use for brick-burning, except that there are openings to the flues both on the outer and inner side of each compartment. It has 28 chambers, which are worked, in sets of 14, round and round the kiln. The time occupied in working round the kiln in this way (and therefore the time between charging and discharging each compartment) is 14-25 days, equally good lime being made in any case, whether the kiln be worked quickly or slowly.

The nuisance proceeding from lime-burning is chiefly that of the smoke which issues from the kiln at a low level. The coal burns in a smouldering way, and gives rise to more offensive products than when it burns freely. That which comes off from a row of large kilns is sometimes very abundant, and clouds the air for a very long distance as it floats away near the ground. No smoke and very little obvious vapour, beside watery vapour, arise from kilns in which coke is used, unless the coke has a little small coal mixed with it, or when some coal is used towards evening to keep the kiln going during the night. If cinders are used, with which organic (chiefly vegetable) refuse is mixed, the effluvia are very offensive, the odour being similar

to that arising from the clamp burning of bricks. The burning of Carboniferous limestone gives rise to a particularly offensive fume, due to the evolution of similar products to those which are obtained by the distillation of oil-shales. The gases given off from a burning lime-kiln are poisonous, and may injure the health of persons residing near, if they chance to enter the house in any considerable quantity.

Since the greater part of the nuisance of lime-burning is due to the products of the imperfect or slow combustion of the fuel used, one obvious mode of lessening the nuisance is so to burn as to use as small a quantity of the fuel as is practicable for the attainment of a good result, or to use such fuel as does not emit offensive smoke. At most of the large lime works in Derbyshire, the fuel used is the commonest and cheapest coal obtainable. Some is very largely mixed with shaly matter ("bass"), and the quantity therefore thrown into the kiln with the stone is enormous. The bad quality of the coal necessitates this extravagant use of it, and the result of the burning is commensurably bad. A good deal of the stone introduced is discharged imperfectly burned, and mixed with the lime drawn are clinkers and stony matters, and the lime has to be picked over by hand. Thus two products are obtained, namely, lime and refuse matter, both of which have to be carted away separately. Such a mode of burning is not only a source of nuisance, but is obviously wasteful of fuel, lime, and labour.

Precisely the same kind of stone which is burned at the Grin works at Burbage, is burned in the Hofmann kiln at Harper, with the evolution of scarcely any perceptible smoke, and with the use of no more than 3 or 4 cwt. of coal to each ton of lime made, while the proportion of refuse picked from the lime is most insignificant. Good Bakewell slack is used at the Hofmann kiln.

A form of kiln invented by Spencer, and which is in use at his works at Lothersdale, does good work with but little evolution of smoke, and with great economy of coal. Fig. 88 shows the principle on which the kiln is constructed. The kiln is made in two chambers *a b*, one above the other, with a sufficiently wide communication *c* between them. The limestone is charged in at the top of the upper chamber, and good slack is introduced at small openings or channels *e*, round the top of the lower chamber, access to these apertures being

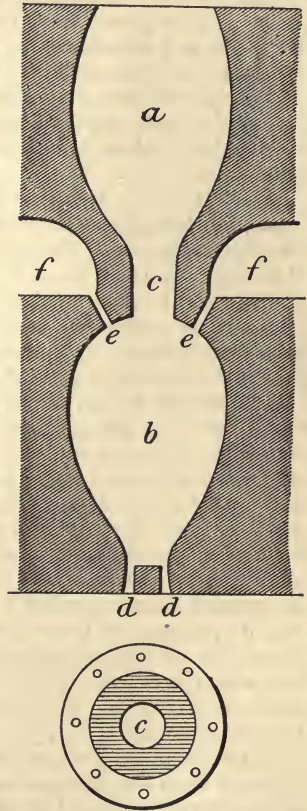

FIG. 88.—IMPROVED LIME KILN.

had by passages *f* constructed in this situation and between adjoining kilns. The feeding of limestone is continuous, and the lime is drawn as usual below at *d*. In this way the combustion of the fuel is caused to take place where it will produce the maximum effect, and the waste heat warms up the stone in the upper chamber before it falls into the lower chamber, where it is burned. Such a kiln is best constructed on the side of a hill for convenience of supplying the limestone at the top and drawing the lime at the bottom.

At the Loan Head works, one of the kilns, which is partially closed at the top, has an arrangement for collecting and condensing the oils, &c., which came off during the burning of the carboniferous limestone. It consists of a pipe or flue leading to a chimney, the draught of which draws off the vapours from the kiln. In the course of the pipe is placed a continuous condenser similar to that in use at oil-works, and this succeeds in condensing some at least of the offensive matters; the condensed oils in this case have a marketable value.

Where ordinary close kilns, such as the Newcastle kiln, are used, the smoke and vapours may be conducted to a chimney which will discharge them at such an elevation as to prevent their becoming a nuisance.

Following is a description of a modern Californian lime-kiln which is supplied with limestone by trucks worked by a gravity pulley from the quarries above. The kiln is an upright circular furnace about 60 ft. high, tapering from a circumference of about 100 ft. at the base, to about 40 at the top; it is surmounted by a smokestack 60 ft. high. This kiln is connected with an outer wall of ordinary brick, and an inner one of firebrick, the space intervening being filled with concrete, altogether forming a wall about 6 ft. thick.

The trucks from the quarry are lowered to the charging platform which leads to the door of the furnace. About 20 ft. beneath the charging platform, the kiln is surrounded by a firing door. On a level with this floor are 3 fireplaces, placed at equal distances in the main body of the kiln. The ashpits beneath the grates of the fireplaces extend directly down through the wall of the kiln, leading separately and directly to the ground or drawing floor, about 20 ft. below. The space in the kiln between the level of the fireplaces and the ground floor constitutes a cooling chamber, the lime being drawn from 3 openings at the bottom of the kiln. This kiln is charged by filling the cooling chamber with waste rock up to the level of the fireplaces, above which 18 truckloads, equal to about 30 tons of limestone, are dumped. The fires are then lighted, being fed with 4 ft. sticks of redwood.

After burning 3 days, a charge equal to 24 barrels of waste rock is drawn from the draw-holes at the bottom of the kiln, just as though it were burnt lime, and fresh limestone is added at the charging door to keep the charge at the proper height in the kiln. After 6 drawings, which now take place in 24 hours, the waste rock is all drawn out, and the lime begins to make its appearance. The lime is sorted and shovelled into raw-hide baskets, and hauled to the depot where it is shipped in bulk. This kiln consumes $4\frac{1}{2}$ –5 cords of wood in 24 hours, producing 160 barrels of lime in that time.

MICA.

THE minerals known as mica are complex silicates of alumina, with other bases (iron, soda, potash, magnesia, and lithia). They occur in small scales, as a constituent of common granite, or in distinct crystals sometimes 3 or 4 ft. diam. The mica minerals are:—

(1) Muscovite, or potash mica, the most common variety, is known as “white mica,” and furnishes the transparent sheets for stove-doors, &c. In thin sheets it is colourless; in thick blocks, white, grey, brown, or wine-coloured. Muscovite is much harder than any of the other mica minerals.

(2) Biotite, or magnesia-iron mica, is very common in Canada, and furnishes what is known as “amber mica.” Even in thin sheets it is only partially transparent, being highly coloured with iron oxide. Biotite is often found in small, very dark, even black, scales and crystals.

Muscovite and biotite are the only varieties of commercial importance. Besides these are phlogopite, or magnesia mica, found mostly in crystalline limestone, and lepidolite, or lithia mica.

Mica (muscovite) in crystals large enough to make merchantable sheets occurs in veins or dikes of very coarse granite, usually in granitic country-rock, gneiss, mica-schist, porphyritic granite, &c. The quartz, mica, and felspar of these veins of granite appear in large crystals or masses. The mica often occurs in regular strings of crystals parallel and near to the hanging or foot-wall. More frequently, however, the mica crystals are found in irregular bunches anywhere in the vein—especially noticeable where a vein “bellies” —or in offshoots.

Mica veins often contain such minerals as beryl, tourmaline, garnet, columbite, samarstite, and cassiterite. In the phosphate districts of eastern Ontario and Quebec, amber mica is found associated with phosphate veins, at times occurring on the walls and at times forming the whole vein filling.

A mica vein is only a vein of very coarse granite, in which the felspar, quartz, and mica have crystallised on a large scale. It differs from ordinary granite chiefly in this respect, that while in granite the crystallising forces have, in a measure, interfered with each other, in a mica vein each has had, so to speak, free play. The crystals of mica in granite seldom attain a greater size than $\frac{1}{16}$ to $\frac{1}{4}$ in. across; a single mica “block” from Mitchell County, Carolina, made two two-horse wagon loads, and could not have weighed less than 2000 lb. A single block of “A” mica from the Mart Wiseman mine in Mitchell County, was 6 ft. long and 3 ft. wide. The crystals of felspar in granite are seldom larger than $\frac{1}{16}$ to $\frac{1}{4}$ in. across. A single felspar crystal from the Balsam Gap mica mine, Buncombe County, weighs 800 lb. Although no large quartz crystals have been obtained from

these mines, large masses of crystallised quartz (generally the darker coloured sorts) are constantly met with. The accompanying small red garnets are generally sprinkled through the quartz, and not through the mica or felspar.

The mica veins in North Carolina are true fissure veins, differing in this respect from the mica veins of New Hampshire, which, according to Shaler, appear to be obscure beds closely following the general run of the apparent bedding that characterises the granites in this part of the country.

Hitchcock ranks the Grafton (New Hampshire) mica veins in the gneissic series, and says that valuable deposits are found only within the fibrolite area (mica schist with fibrolite, one of the supposed divisions of the Montalban Group). This fibrolite area lies between the two great areas of porphyritic gneiss, very well developed between Rumney and Hebron.

Of the influence of the walling on the quantity and quality of the mica, but little is known. Some of the more experienced miners in Mitchell County say that both the quantity and the quality of the mica depend upon the character of the walling and of the vein; but so many accessory circumstances influence the quality of the mica, such, for instance, as the width of the vein, the presence of flat and curved mica, of crystallised felspar, &c., that the time has not yet come for expressing an opinion. These circumstances may depend more or less upon the character of the walling; but if so, it is not known just what the connection is. The same may be said as to the influence of width, depth, dip, strike, and accompanying minerals.

Below the zone of atmospheric influences, rarely extending below 20 ft., and sometimes not below 10 ft., the vein becomes more solid, and the quality of the mica improves. The width of the veins varies much, from 3 ft. to 40 ft., sometimes in the same mine varying from 3 ft. to 20 ft. Nipping of the vein is a common occurrence, occasionally to almost entire obliteration. The "stringers" that make off from the main vein penetrate into the wall rock at various angles, and though narrow sometimes yield fine mica.

The rough mica is hoisted from the mine in blocks of considerable size, weighing 50 to 250 lb., tabular in shape, and more or less contaminated with fragments of felspar, quartz, waste mica, &c. It is the purpose of the dressing to free the blocks from all materials not made use of in preparing cut mica. This is all done by hand, and consists in cleaving a block with thin steel wedges along the planes of lamination, separating it into a number of tabular pieces about $\frac{1}{2}$ in. thick, and as large as the stock will allow. These pieces are then further cleaved until the proper thickness for cut mica is attained, this being, according to the use it is to be put to, $\frac{1}{8}$ to $\frac{1}{16}$ in., or even thinner. The workman doing this also frees the sheets from adhering quartz, fragments of mica, &c., and passes them to the "scriber."

Scribing is an operation demanding a considerable degree of skill and experience. Upon it depends the yield of cut from block mica. It is performed by laying upon the sheet the pattern by which it is to be cut, and marking or scribing around it with a knife or similar instrument. The patterns are pieces of tin, sheet iron, &c., with the

shape and size determined by the order from the mica brokers or dealers in large cities, or by the stove-maker himself. In Mitchell County, Carolina, alone are about 100 different patterns, and their shape and size are constantly varying according to the fashion for stove windows. The size of cut mica was formerly of much greater consequence than at present. Several years ago there was a regular and systematic increase in value with the increase in size, the quality of course remaining the same. This is true to some extent now, though there appears to be a decided tendency towards smaller patterns. The first noticeable change in that respect was perhaps in 1883-84, when the stove manufacturers were compelled by the scarcity of large mica to use smaller sheets. They found the change so advantageous to their pockets that they persevered in it. Not that small mica is as valuable as large mica, but large sheets are not as valuable as they were ten years ago. There is a limit below which it is not safe to go, probably 3 by 6 in. The patterns range in size from 1 by 1 in. up to 8 by 10 in., or as large as the stock will permit, increasing $\frac{1}{4}$ in. each time. As the value of the mica increases at the same time, it becomes necessary to cut from a given rough sheet the largest number of patterns of the highest market value. The price of mica depends not only upon the size, but also upon its freedom from specks, stains, cloudiness, and striations, these governing its quality. Of late, too, a certain "amber" or rum-coloured mica has become fashionable, and fancy prices are sometimes paid for a good lot of extra "rum" mica. The regular colourless or "white" mica, however, commands the bulk of the trade. Certain mines are famous for "rum" mica.

As, after the scribing, the sheets are cut with heavy shears along the lines marked down, it will at once appear that much skill and experience are required of a good scriber. He must be constantly on the alert to furnish from every piece the largest number of valuable cut sheets. With the diversity in patterns and prices, and the variation in the mica itself, this becomes no easy task. A good scriber always commands good wages, for upon his skill depends the yield of cut from block mica. No matter how much block mica is brought to bank, nor how good the quality of it, if the sheets be not properly scribed the yield of cut mica diminishes, and with it the profit. A really skilful scriber will get from a given block twice as much cut mica as a beginner. He sees at a glance just what patterns a certain sheet should yield, he instantly detects flaws, stains, &c., and with a few rapid movements of his marking implement he "scribes" the sheet and passes it to the "cutter," who merely cuts the sheet through along the lines marked. The different sizes are then cleaned of the fine filaments of mica with a stiff brush, wrapped in strong paper, generally in 1 lb. packages, boxed and shipped.

Cut mica is the only product of a mica mine that is sold on a commercial scale. It determines the value of the mine. So much depends on the quality of the blocks and of the rough sheets, whether they are stained, or cloudy, or flawy, or striated; so much depends on the skill of the scriber, and other local conditions, that what is here said is to be taken as applicable to average conditions.

On the average, therefore, 100 lb. of block mica should yield 10 to

12 lb. of cut mica. Instances are not unknown where the yield has fallen to 5 per cent.; it has risen at some mines to 33 per cent., and once to 75 per cent. With the general average of block mica a 12 per cent. yield in cut mica is considered a fair return. These 12 lb. will vary in value according to the quality and size of the patterns, the highest price being 16s. a lb., and the average price not far from 7s.

A 12 per cent. yield with these figures will give an average value of 4*l.* per 100 lb. of block mica.

Mica is now being extensively and very cheaply mined in India, and even a 35 per cent. *ad-valorem* duty has not sufficed to prevent Indian mica from successfully competing with the indigenous article in the United States, especially in the best qualities of cut mica.

The Canadian deposits of amber mica are so large and cheaply worked that they practically supply all demands which do not require transparency. The production varies from 40,000 lb. upward per annum. It is well adapted for electrical applications, in which flexibility and perfect cleavage are essential, while colour is of no moment.

The United States afford some 60,000 lb. annually, but import even more.

In recent years the preparation of ground mica has become an industry of itself. Waste or scrap mica is generally used. The difficulties of grinding are great, owing to the tough and scaly nature of the material. Mills which work well on almost everything else fail utterly on mica. Recently there has been a return to old-fashioned burr-stones, though most of the manufacturers keep their process a secret. The grinding is usually wet.

Ground mica is now largely used for purposes of decoration, as in the manufacture of wall-paper, where the coarsest grades are used to give a frosted and spangled effect, and the finest grades to form a metallic white surface. It is also used in making a lustrous hair powder, &c. Medium sizes of ground mica are used in the manufacture of lubricants for journals and axle-bearings. Some manufacturers grind mica to a very fine powder for "specialties," but the sizes of ground mica usually made are 24, 40, 60, 70, 80, 100, 140, 160, and 200 meshes to the inch, and the prices range from 2½*d.* to 5*d.* per lb. Scrap mica for grinding is bought for about 50s. per ton at the mine. It must be free from rust or specks, which would affect the colour and lustre of the product.

PEARLS.

MANY molluscs line the interior of their shells with a coating formed of alternate layers of animal membrane and carbonate of lime; this, in some species, assumes a nacreous or pearly lustre, and forms the substance known as "mother-of-pearl." A superabundance of this secretion is often produced in drops or tuberosities, adhering to the interior of the shell, or lodged in the fleshy part of the occupant; these form the "pearls" of commerce. The formation of mother-of-pearl is evidently a natural and unvarying process with certain species of mollusc, though little research has been made as to the conditions which favour or retard it. The production of pearls, on the other hand, at least in the case of the true pearl mussel, is accounted accidental (possibly on insufficient grounds), and is generally attributed to disease or injury suffered by the occupant of the shell.

During the summer months, the Arabs prosecute a small pearl-fishery along the coasts of the Red Sea. The captured molluscs are taken ashore and exposed to the sun, when they quickly open; they are then examined for pearls, and thrown away. The headquarters of this fishery is Jedda. The pearl-mussel fishery in the Persian Gulf, principally on the banks of the island of Bahrein, is also in the hands of the Arabs. The best beds are said to be level, and formed of fine whitish sand, overlying the coral, in clear water. About 4000 to 5000 boats are engaged, and the annual value of the harvest may be placed at 600,000*l*. The beds occur at all depths down to 18 fathoms, and probably lower; the chief diving is in 4 to 7 fathoms.

The Ceylon or Tinnevely fishery is situated on the west coast of Ceylon, in the Gulf of Manaar, southwards of the island of that name, and along the opposite coast of the Indian continent, near Tuticorin. The banks lie in groups: the first, opposite the village of Arippu, comprises the so-called Peria-Par, Peria-Par Karai, Cheval-Par, Kallutidel-Par, and Modaragam-Par; facing the village of Karaitivu, is the bank of that name; and off the village of Chilaw, are Karakupanai-Par and Jekenpedai-Par. These banks are 6 to 8 miles from the shore, and $5\frac{1}{2}$ to $8\frac{1}{2}$ fathoms below the surface. They consist of masses of rocky ground, rising from the sandy bottom, and are probably exposed to ocean currents.

After the pearls are collected, they are classified, sized, and valued. The classification is as follows:—(1) *Anie*, pearls of perfect sphericity and lustre; (2) *anathorie*, failing in one of these points; (3) *masengoe*, failing slightly in both points; (4) *kalippo*, failing still more; (5) *korowel*, double; (6) *peesal*, misshapen; (7) *oodwoe*, beauty; (8) *mandongoe*, bent or folded; (9) *kural*, very small and misshapen; (10) *thool*, "seed." The sizing is effected by passing them through a succession of brass cullenders, called "baskets," having the size and shape of large saucers. There are 10 to 12 of these. The first is perforated with

20 holes, and the pearls which do not pass through it by shaking are called "of the 20th basket." The succeeding baskets have 30, 50, 80, 100, 200, 400, 600, 800, 1000, each giving the name corresponding with its number of holes to the pearls that do not pass through. After sizing, the pearls are weighed, and their value is then expressed at a rate "per *chow*," which term embraces all the qualities which have been estimated.

The great Queensland pearl-fishery in Torres Straits is carried on by boats, with Malay divers, in water of 4 to 6 fathoms. The pearl mussels of Torres Straits have a weight of 3 to 6 lb., and even 10 lb.

Diving for pearl is one of the chief occupations of both sexes of natives in the islands of the South Pacific. The mollusc here sought is the mother-of-pearl-yielding mussel, which inhabits the interior lagoons of the great coral *atolls*. It frequents the clean growing coral, where it can attach itself free from sand or drift, and where there is considerable influx and efflux of tide. It is also to be found in great numbers under the breakers that beat upon the outer reefs, and probably at greater depths in the sea beyond.

Pearls of considerable value are sometimes found in fresh-water mollusca, so much so that the search for them is quite a domestic industry in some localities, especially during extra dry seasons. It would seem that seeking for pearls may be rewarded in any creek or river where limestone is the country rock, since the unios have a tendency to secrete nacreous matter wherever carbonate of lime is provided.

For further information the reader is referred to Spens' Encyclopædia.

PEAT.

PEAT consists of the cumulatively resolved fibrous parts of certain mosses and graminaceæ. It gradually darkens from brown to black with increasing age. Judging from Dr. Angus Smith's results, it grows at the rate of about 1 in. a year. A pectinous substance has been found amongst its constituents. As a fuel, it is most economically used at the spot where it is grown. It has been, however, destructively distilled at a low temperature for tar, a branch of industry now scarcely profitable. The process gives a very porous, friable charcoal, possessed of great decolorising power; gas rich in carbonic dioxide is also given off. A ton of good peat may yield more than 5600 cub. ft. of gas. The purified gas contains about 11 per cent. of vaporised hydrocarbides, 37 of marsh gas, 31 of hydrogen, and 19 of carbonic oxide; it is thus (as its mode of formation suggests) less oxygenated than wood gas, but more oxygenated than coal gas. The liquor is rich in hydric acetate, which amounts to about .2 per cent. on the peat; ammoniac sulphate, taken similarly, exceeds 1 per cent. Good peat yields about 3 to 6 per cent. of tar proper, which is comparatively easy to purify by the usual method.

The method of cutting peat in the Highlands of Scotland is very different from that adopted for cutting peat from bogs. In the first place trenches are opened at distances of about 10 yd. apart; and, according to the nature of the ground, these trenches are made 50 to 500 yd. long. After removing the surface sod at the places where the trenches are to be cut, for a width of 3 ft. along the whole line of the trench, the peat-cutter digs out the peat with a peculiar-shaped tool, in slices of about 1 ft. square and 3 or 4 in. thick. As fast as these slices are cut, another man takes them off the peat iron and throws them on the surface, so as to spread them out as much as possible. In this way prisms of peat, measuring 3 ft. in width and depth, are cut out at intervals of 10 yd., and the number of slices cut in each trench are just as many as a man can throw on both sides of the trench without shifting his position except from one end of the trench to the other as the cutting advances.

In succeeding years the peat is cut from the two banks thus formed in each trench, to a width of only 18 in. and a depth of 3 ft. The advantage of this system of cutting is that there is no necessity for removing the peat by barrows to the spreading-ground, a proceeding which is attended with considerable expense for labour. When the peat is cut in this way from a bank 150 yd. long, it will give 75 cub. yd. of wet peat, and the number of slices into which this is divided will be about 8000. Then, as the banks are 10 yd. apart, there are 5 yd. width of drying ground to each bank, or a superficial area of 6750 sq. ft. to each bank of 150 yd. long. Cutting it in this way every year, it would take 10 years to remove the whole of the peat to a depth of 3 ft. As the banks are cut away in successive years the area of spreading-ground on the surface is reduced, and some

of the peat has to be spread at the bottom of the trench, the area of which increases as that of the banks' surface is reduced by the cutting.

The peat cut to a width of 18 in. and a depth of 3 ft. from a bank of 150 yd. long, is what is called an iron's work, and the 75 yd. of peat so cut yields about 10 tons of dry peat, so that to cut 7000 or 8000 tons of dry peat would require 750 irons' work, or banks about 64 miles in length, and extending over an area of about $\frac{1}{2}$ sq. mile. This area of ground would supply 7000-8000 tons every year for 10 years.

The cutting and spreading of peat in this way forms but a proportion of the cost of the dry peat. A far more considerable portion of its cost results from the labour of collecting the dry peat and bringing it to the place where it is to be used. Herein lies one of the greatest difficulties of employing peat on any very extensive scale. Whatever mode may be adopted for collecting the dried peat to one spot for use, the cost of carriage will increase in proportion to the increase in the quantity of peat consumed at that spot.

Another prominent difficulty attending the use of peat consists in obtaining it in a dry state, fit for use as fuel or otherwise. Mountain peat, as it occurs naturally, contains as much as 80 per cent. of water, even when it has been well drained, and bog peat often contains very much more. Consequently, to obtain 1 ton of dry peat, 5 tons of material have to be dug and spread, and 4 tons of water have to be got rid of by evaporation. When mountain peat is cut in slices and spread out on the ground during dry weather, the drying goes on rapidly, the surface of the pieces acquires a kind of skin, which is not wetted again by rain, and the peat, in the course of a week, is sufficiently hardened to be handled; the pieces are then set up on edge, so that the air may play on both sides, and in the course of 6 to 8 weeks they are dry enough to be stacked or heaped up. But peat districts are generally remarkable for a very moist atmosphere and for a great frequency of rain. In the Highlands of Scotland and in the Hebrides, on the average there is rain 4 days out of 6, and it is only the months of May, June, and July that afford any continuance of weather favourable for drying peat. Therefore the peat must all be cut before the end of May at latest. On the other hand, if the peat is cut during frosty weather, and becomes frozen, it crumbles to powder when the thaw comes, and for this reason it is not safe to commence the cutting at all before April or even May. As a rule it might be said that the month of May is the only time available for cutting peat. Once a skin has formed on the surface of the pieces, it may be considered safe, whatever kind of weather follows. It may then remain on the ground, set up in little heaps, till the autumn, and will get the advantage of whatever dry weather there may be. Two men working together, one cutting and the other casting the peat, will, in good weather, get through about one iron's work in a day, equivalent to 10 tons of dry peat. This will still retain 20 to 30 per cent. water only separable by kiln drying. When kiln dried, peat possesses about half the calorific value of coal.

Though attempts have been repeatedly made to produce coke from peat, no real success seems to have attended them.

PETROLEUM, NATURAL GAS, AND OZOKERIT.

Petroleum.—Many theories have been advanced as to the origin of petroleum, but the most important are the chemical theory adopted by several European authorities, and the organic theory favoured in America.* The chemical theory supposes petroleum to have been generated by the downward passage of surface water into regions of the earth's crust where metallic iron in combination with carbon exists in a highly heated state; or by water containing carbonic acid being carried down to strata where potassium and sodium occur in a metallic state. American geologists and chemists agree that petroleum has resulted from the decomposition of fossils in the shales and limestones of the Silurian, Devonian, and Lower Carboniferous rocks, chiefly the remains of animals, but in some cases also the remains of plants; that the gas and petroleum thus formed are stored in porous sandstones and limestones, and are prevented from escaping by a covering of impervious shale.

That the organic theory of the origin of petroleum best explains the facts over the greater part of North America, is beyond question. It probably also serves best for most areas. But the inorganic theory is a possible one for some regions.

As regards the future supply of petroleum, the question of its origin is important. If it has resulted from the decomposition of animal or vegetable remains, the supply, however vast and seemingly inexhaustible at present, must needs be limited, and each area will in time be drained. If, however, it be due to chemical action in the interior of the earth, the supply may be practically inexhaustible in the districts where it is thus formed. The great pressure of the gas and petroleum in many wells has been held to afford evidence of a deep-seated origin; but this pressure necessarily results from the known geological structure of the country in many places.

The general rule in Pennsylvania,† New York, Ohio, Indiana, and Canada, is that petroleum and gas are stored in porous sandstones or limestones, where the rocks have been gently folded into anticlinal ridges; or where, if there is a small and general dip of the strata, the dip is for a space interrupted, forming a shelf of more nearly horizontal rock, after which the strata resume their normal gentle dip. Tracing out the underground range of petroleum-bearing beds beyond the areas in which they are now productive, we find that they rise towards the surface, and contain water. It is the pressure of the

* B. Redwood, 'Petroleum and its Products,' Cantor Lecture, Soc. Arts, 1886. W. Topley, 'Sources of Petroleum and Natural Gas,' Jl. Soc. Arts, April 17, 1891.

† H. M. Chance, 'Anticlinal Theory of Natural Gas,' Trans. Amer. Inst. Min. Engs., xv. 3; C. A. Ashburner, 'Geological Distribution of Natural Gas in the United States,' Trans. Amer. Inst. Min. Engs., xv. 505; C. A. Ashburner, 'Petroleum and Natural Gas in New York State,' Trans. Amer. Inst. Min. Engs., xvi.

water from the outcrop and the higher areas of the porous rock, acting along and down the dip, which accounts for the pressure of the gas and petroleum within the productive areas. When the porous bed containing gas or petroleum is tapped by a borehole, the contents are forced up by the pressure of the water from the outcrop, and the pressure depends upon the relation between the level of the outcrop and the point at which the porous bed is tapped.

According to Prof. McGee, every field in the Eastern States and Canada is a dome or inverted trough formed by flexure of the rocky strata; and in every such dome or inverted trough there is a porous stratum (sandstone in Pennsylvania, and coarse-grained magnesian sandstone in Ohio and Indiana) overlain by impervious shales. These domes or arches vary in dimensions, from a few square miles in some of the Pennsylvanian areas, to 2600 sq. miles in the great Indiana field. Within each gas-charged dome are found three or more substances arranged in the order of their weight; gas at the top, naphtha (if it exists in the field) and petroleum below, and finally water, which is generally salt, and sometimes a strong and peculiar bittern. This order is invariable throughout each field, whatever its area, although in Indiana, at least, the oils are found most abundantly about the springing of each arch, while towards its crown gas immediately overlies brine; and the absolute altitude of the summit-level of each substance is generally uniform whatever the depth beneath the surface. Since the volume of gas or oil accumulated in any field evidently depends on the area and height of the dome in which it is confined, and upon the porosity and thickness of rock in which it is contained, the productiveness of a given find may be definitely predicted after the structure and texture of the rocks have been ascertained.

In all productive fields the gas and oil are confined under pressure. When a gas well is closed, it is commonly found that the pressure at the well head gradually increases, through a period varying from a few seconds in the largest wells to several minutes or even hours in wells of feeble flow; and that afterwards the pressure-gauge becomes stationary. This is the "confined pressure," "closed pressure," or "rock pressure" of the prospector; or, more properly, the "static pressure." When a well is open, and the gas escapes freely into the air, it is found that if the stem of a mercurial or steam gauge is introduced, a certain constant pressure is indicated. This is the "open pressure" or "flow pressure" of the gas expert, and the capacity of the well may be determined from it. The static pressure varies in different fields. In Indiana it ranges from 300 to 350 lb. per sq. in., in the Findlay field it is 450 to 500 lb., and in the Pennsylvania field it varies from 500 to 900 lb.

The cause of this enormous pressure is readily seen in Indiana. The Cincinnati Arch (in which the gas of the great Indiana field is accumulated) is substantially a dome, about 50 miles across, rising in the centre of a stratigraphic basin fully 500 miles in average diameter. Throughout this immense basin the waters falling on the surface are in part absorbed into the rocks, and conveyed towards its centre, where a strong artesian flow of water would prevail were the differ-

ence in altitude greater; and the light hydrocarbons floating upon the surface of this ground water, are driven into the dome, and there subjected to hydrostatic pressure, equal to the weight of a column of water whose height is the difference in altitude between the water surface within the dome and the land surface of the catchment area about the rim of the enclosing basin. Accordingly, the static pressure is independent of the absolute altitude of the gas rock and of its depth beneath the surface, except in so far as these are involved in the relative altitudes of the gas rock and a catchment area perhaps scores or even hundreds of miles distant. Gas pressure and oil pressure may, therefore, be estimated in any given case as readily and reliably as artesian water pressure; but while the water pressure is measured approximately by the difference in altitude between the catchment area and well head, that of gas is measured approximately by the difference in altitude between catchment area and gas rock, and that of oil is measured by the same difference, *minus* the weight of a column of oil equal to the depth of the well. It follows that the static pressure of gas (as indicated at the surface) is always greater than that of oil, particularly in deep wells. It follows also that the pressure, whether of gas or oil, is not only constant throughout each field, but diminishes but slightly, if at all, on the tapping of the reservoir, until the supply is exhausted: and hence that pressure is no indication of either abundance or permanence of supply.

There is no uniformity in the geological ages of the strata which yield petroleum. Even in North America the age ranges from Lower Silurian to Tertiary: both gas and oil also occur in the drifts. Rocks of Secondary age, however, with the exception of the Cretaceous, are not oil-bearing in North America. In Europe, only small quantities occur in Palæozoic rocks. In Hanover it ranges from Trias to Cretaceous. In Eastern Europe it is mainly Tertiary, and wholly so in the Caucasus.

In other parts of the world the petroleum-bearing beds are, so far as is known, rarely of older date than Upper Secondary. Volcanic rocks occasionally contain petroleum, but there is good reason to believe that these cases are generally the result of impregnations into porous reservoirs of volcanic rocks from neighbouring sedimentary strata.

In geological position, the gas and oil-bearing rocks of Pennsylvania, New York, Ohio, and Indiana range from Lower Silurian (Trenton limestone) to Lower Carboniferous. Until the great stores of the Trenton limestone were discovered, the Devonian and Lower Carboniferous strata were the most important sources. The oil-sands of Venango Co., Pennsylvania, are often in lenticular beds, the longer axes of the beds ranging from north-east to south-west. In thickness they range from a thin band up to 100 ft. Their width may be only 1-2 miles, their length sometimes 20 miles. Some of the strata die out before reaching the outcrop, and consequently are known only by borings. When two or more such beds occur in vertical succession, the lowest usually contains most oil or gas. The lenticular nature of the sand may explain how in some cases neighbouring wells affect each other, whilst elsewhere they may not do so. Beneath the

Venango group, other gas or oil-bearing sands were subsequently discovered, the most important of which are the Warren sands of Warren Co., and the Bradford sands of McKean Co. The Berea grit is the most important source of oil in Eastern Ohio.

In all cases these productive sands are underlain and overlain by shales. The underlying shale is the source of the petroleum and gas; the sand is the porous reservoir in which they are stored; the overlying shale is an impervious cover which retains them in the reservoir. When gas and oil are found stored in limestone, they may sometimes have been produced in the limestone itself, but the impervious cover of shale is still required to retain them. The Trenton limestone, the chief source of gas and oil in Indiana, and an important source now in Western Ohio, is the upper member of a series of limestones which have been proved to a depth of 1800 ft. The true Trenton limestone itself is several hundred feet thick. All this thickness of limestone may have produced the hydrocarbons, although they are stored mainly in the upper part of the Trenton. But not always so; it is only when the Trenton limestone occurs in the cavernous condition that it is highly productive; this condition is due to some of the lime having been removed, its place being taken by magnesia.

The storage capacity of the porous sandstone and limestone is very great, and sufficiently accounts for the great yield of the wells. The Waterlime bed, 500 ft. thick, and with a capacity of only 0.1 per cent., would contain 2,500,000 barrels of oil per square mile; 100 sq. miles of such rock would yield the entire production of New York and Pennsylvania up to January 1883. But the capacity for storage is often much more than the figures taken here. Carll has shown that some rocks can contain from $\frac{1}{10}$ to $\frac{1}{8}$ of their bulk in oil.

Referring to the natural gas wells of Indiana, S. S. Gorby* estimates that approximately 30,000 cub. ft. of gas are equivalent to 1 ton of coal as fuel. He declares that the period of exhaustion of the wells has been entered upon. The initial pressure of new wells is now less than 300 lb., whereas it used to be 325 lb., and the boundaries of the field are being rapidly drawn in. He estimates that probably 10 to 15 years will witness the termination of the gas fuel supply on anything like the present scale.

There are some peculiarities which render Kentucky interesting and instructive, as a source of gas. Elsewhere the incursion of salt water into a gas well is the sure precursor of failure, showing that the reservoir is becoming exhausted; but here salt water and high-pressure gas occur together. Some of the wells here, also, have long lives: one, at Moreman, has been producing gas and brine since 1863. Salt has been manufactured here from the brine since 1872.

In California, petroleum occurs mainly in sandstone of Tertiary age. The beds are generally inclined from 30° to 85°, the edges outcropping. High-pressure wells are consequently rare, the oil being obtained by pumping; and the cost of wells is stated to be about three times what it is in Pennsylvania, partly on account of the steep inclination of the beds.

* Eng. and Min. Jl.

Although petroleum occurs all along both flanks of the Caucasus,* often in considerable quantity, the Apscheron Peninsula, on the western margin of which Baku is situated, surpasses all others in value. The most productive wells lie within a small area north-east of Baku, in the Balakhany-Saboontchi district, over the crown of a low anticlinal, which is probably the easterly continuation of the great Caucasus anticlinal. Another, and increasingly important productive area, is on the shores of the Caspian, at Bibi-Eibat, south of Baku, and about 10 miles from Balakhany.

The surface is occupied by loose sand, the rocks below being of late Tertiary date; beneath these probably lie the Cretaceous and Jurassic strata, which form the main mass of the Caucasus, but it is doubtful if any borings have touched these rocks. The oil lies in various layers of sand, separated by clay, &c. This sand is often very loose, and comes up in great quantities, where oil of high pressure is first tapped. Enormous loss of oil often occurs when a high-pressure well is first driven. The Mining Company's well in August 1887, struck oil at a depth of 790 ft., which flowed the full size of a 12-in. pipe for 69 days, 200 ft. above the derrick. The lowest estimate for this well for the 69 days was 3,000,000 barrels, of which at least half were lost. More sand than usual came out of this well; an area of about 10 acres around the well was covered with sand from 1 to 15 ft. thick. So much sand has been carried out by the wells that the surface of the ground sinks, and buildings are thrown out of the perpendicular. Many highly productive fountains suddenly cease; the cause is said to be a collapse of the pipe at the bottom of the well.

The depth of the wells in the Baku area is gradually increasing: in 1882 the average depth was 350 ft.; in 1886 it was 500 ft. Many are now over 700 ft., and at least one is over 1000 ft.

Wells sometimes continue to produce for years, especially when, as in Nobel's works, they are sealed down when not required. The deeper wells as a rule produce the larger quantity and, sometimes, a better quality of oil, of lower specific gravity.

There is difference of opinion as to whether wells affect the production of others in their neighbourhood. As there are several layers of oil-bearing sand, adjacent wells may frequently draw their supplies from different beds.

The most important area of the Caucasus, after Baku, in some respects, is that of Kouban. This lies at the north-western end of the range. The wells here are usually of smaller depth, and are less productive than at Baku, although one well—as far back as 1879—is said to have been bored to a depth of 1020 ft. Here, as at Baku, the heaviest oil sometimes comes from the higher beds.

The third productive area is near Kertch, in the Crimea. The wells here are not deep, and, compared with the two other districts, are not highly productive.

In Roumania, petroleum lies in clays and sandstones of the "Paludine beds" (Miocene). The oil occurs in four horizons, the lowest being the richest. Argillaceous beds, with thick (over 650 ft.)

* B. Redwood, 'Russian Petroleum Industry,' JI. Soc. Chem. Ind., Feb. 1885.

deposits of salt, occur under the Paludine beds. Formerly the petroleum was extracted by shafts more than 600 ft. deep; about 400 such shafts have been sunk in the neighbourhood of Sarata. When drilling was introduced, the beds were pierced to a depth of 1300 ft.

Petroleum and salt are worked in Bukowina.

In Galicia petroleum occurs in the Lower Eocene beds—sometimes, perhaps, in the Upper Cretaceous. The strata are for the most part highly inclined, generally dipping away to the north from the Carpathian highlands, but the beds are often contorted. Borings now go down over 1000 ft.; oil, sometimes with much gas, is chiefly found in beds of sandstone.

In North-Eastern Hungary, along the southern flanks of the Northern Carpathians, petroleum occurs in Neocomian, Middle Eocene, Upper Oligocene, and in more recent strata. To the south-east of Nagy-banya, in the Szatmar country, petroleum is found in a dolomitic limestone, underlying mica-schist. In the Nagy-Banya basin, and also in the Matra range, it occurs impregnating trachytic tuffs of Miocene age.

At Oelheim, on the east of Hanover, the oil is stored in the Gault. There seems, also, to be some in the Wealden beds, and in the Upper Jurassic strata. To the west are Triassic beds; but these seem to be mostly barren of oil, although Piedbœuf believes that the fossiliferous Middle Trias (*Muschelkalk*) is the true source of the petroleum, which has been stored in the overlying beds.

Before describing modern machinery for petroleum well-sinking it will be interesting to study local and rudimentary methods.

In Japan the excavating is done by two men, one of whom digs in the morning from 9 o'clock until 12, and the other from 12 until 3. The one who is not digging works a large blowing machine that sends fresh air to the bottom of the well. The blowing apparatus is a wooden box about 6 ft. long by 3 ft. wide and 2 ft. deep, with a board of the same length and width, turning in it upon a horizontal axis at the middle of each side of the box, and with a vertical division below the board between the two ends of the box. The workman stands upon the board, and walks from one end of it to the other, alternately depressing the ends. At his first step on each end he gives a smart blow with his foot, so as to close with a jerk a small valve beneath the end of the board, the valve opening by its own weight when the end of the board rises. The air is therefore driven first from one end of the box, then from the other, into an air-pipe about .8 ft. square, provided at the top with a small valve for each end of the blowing-box. The air-pipe is made of boards in lengths of about 6 ft., and is placed in one corner of the well. The well is, besides, timbered with larger pieces at the corners, and light cross pieces, which serve also as a ladder for going up and down, though at such a time, in addition, a rope is tied round the body, under the arms, and held by several men above the mouth of the well. The earth or rock excavated is brought out of the well in rope nets, by means of a rope that passes over a wheel 1 ft. diam., hung just under the roof of a hut which covers the mouth of the well. The rope nets are drawn up by three men, one at each

corner of one side of the well, and the third in a hole 2 or 3 ft. deep, and $1\frac{1}{2}$ ft. wide, dug along the side of the well. The wells are about $3\frac{1}{2}$ ft. square, and are dug in the manner described to the remarkable depth of 600 to 900 ft. At this depth there is great difficulty in securing sufficient light to carry on the work, and it is frequently necessary for this reason to suspend work at 3 o'clock. The oil is skimmed from the surface of the water, and drawn up in buckets.

Lyman is of opinion that it would be the reverse of advantageous to introduce the system of drilling with steam power in Japan, on account of the cost of the necessary machinery, the heavy expense of fuel in the locality, and the difficulty of transporting machinery in a country almost wholly without wagon roads. The cost of a well in Echigo, 900 ft. deep. is stated to have been only 200*l.*, which is little more than a third of the expense of drilling to that depth in England or America. Moreover, a dug well can be entered for cleaning or repairing, while a drilled well obviously cannot; besides which, the former description of well necessarily exposes a larger surface for the oil to percolate through, and is also frequently furnished with horizontal galleries extending from the bottom, which largely add to the extent of surface of oil-rock exposed. However, some improvements might advantageously be introduced into the system. Thus the only light obtained is that which is reflected from a piece of yellowish translucent oil-paper, about 5 ft. long by $3\frac{1}{2}$ ft. wide, suspended over the well at an angle of 45° with the horizon, across an opening in the roof of the grass hut that covers the well; and it would be easy to substitute for this primitive reflector a common mirror. A small mirror could also be used at the bottom of the well to reflect light into the galleries, which at present are so dark that they cannot be excavated to a greater length than about 12 ft. A flame cannot be used in the well as a source of light on account of the presence of inflammable gas, but the incandescent electric light, if not too costly, might be employed, and the working hours thus extended. A better system of ventilation might also be adopted; and the use of pumps for raising the water and oil, as well as of a water-tight well-casing, which might be made of timber, to prevent the influx of water, would also facilitate the collection of the petroleum. The small yield of the wells, however, would preclude the employment of any expensive appliances, the total yield of the wells in the oil-fields of Echigo and Shinano being only 11,000 to 12,000 barrels per annum.

In Burma* the wells are dug in the most primitive manner, a native spade for loosening the soil, and a basket for removing it from the well, being the only implements used. The wells are about 60 ft. deep and 5 ft. square, and are planked with split timber. There are generally 3 or 4 men employed in the work of digging, each one taking his turn, and, while working in the well, having a rope fastened round him. Sometimes there is so much gas present that the digger cannot remain in the well more than a couple of minutes, and occasionally a man is drawn up quite insensible. The usual time of remaining down is about 20 minutes, and the

* J. Ball, 'Economic Geology of India,' p. 124.

digger jerks the rope when he wishes to be drawn up. The oil is raised in a bucket attached to one end of a rope running over a wheel fixed above the mouth of the well. The other end of the rope is fastened to the waist of a man or woman, who generally has two or more boys or girls to assist in pulling. As soon as the bucket fills, these persons run down a beaten path, and the bucket is thus drawn to the mouth of the well, when it is emptied by another person.

In Wallachia and Galicia dug wells exist, and in Moldavia are dug wells more than 130 ft. deep, lined with woven sticks.

Most perfectly constructed dug wells exist in Italy, at Montechino, Piacenza; they are perfectly cylindrical in form, and lined with large bricks firmly cemented together. Some of these wells are 240 ft. deep and 8 to 10 ft. diam. They yield 160 to 180 lb. of oil each per day. The oil, which is drawn up in buckets, is of very remarkable character, being so pure that it can be burned in its crude state in suitable lamps, though in consequence of the presence of a large quantity of the more volatile hydrocarbons it is very inflammable, at once taking fire upon the application of a flame. These wells cannot be dug deeper in consequence of the presence of petroleum gas and vapour, several lives having been lost in attempts to deepen them.

The first operation in the sinking of a petroleum well in America is the erection of what is termed a "derrick," a timber structure (Fig. 89), pyramidal in form, and consisting, in the main, of 4 uprights, held in position by the necessary ties and diagonal braces. At the present time the derrick is usually about 70 ft. high, 20 ft. square at the base, and costs about 100*l*.

The height of the derrick has necessarily been increased *pari passu* with the depth of the wells and length of the tools, but where the wells are shallow, derricks not more than 30 ft. high are still employed. The lower part is usually boarded up when drilling is being done in winter, in order to protect the workmen. Immediately outside the derrick stands the "sampson post" *a*, a massive pillar of wood which supports the "walking-beam" *b*. Inside the derrick stands a smaller upright termed the "headache post" or "life preserver" *c*, designed, as its name implies, to save the driller from being struck on the head by the end of the walking-beam in the event of the connection breaking. The end of the walking-beam outside the derrick is connected by means of a rod termed the "pitman" *d*, with a crank attached to the axle of what is known as the "band-wheel" *e*. This band-wheel runs in bearings on a couple of uprights *f*, and is caused to revolve through the medium of a band *g* driven by a steam-engine *h* in an adjoining shed, a rocking movement being thus imparted to the walking-beam. The steam-engine is now usually of 12 to 15 h.p., and steam is generated in a boiler of the locomotive type, fired with natural gas. To the opposite side of the derrick are fixed the bearings of the "bull-wheel" *i*, a windlass of solid construction, used for lowering and raising the drilling tools, the supporting cable passing over a grooved wheel, termed the "crown pulley" *k*, at the top of the derrick, and being coiled on the drum or axle of the bull-wheel. Between the band-wheel and the bull-wheel the "bull-rope," made of 2-in. plain-laid cable, joined by iron couplings,

passes. This rope runs in a groove in both wheels, and imparts motion to the windlass. The latter is provided with a powerful

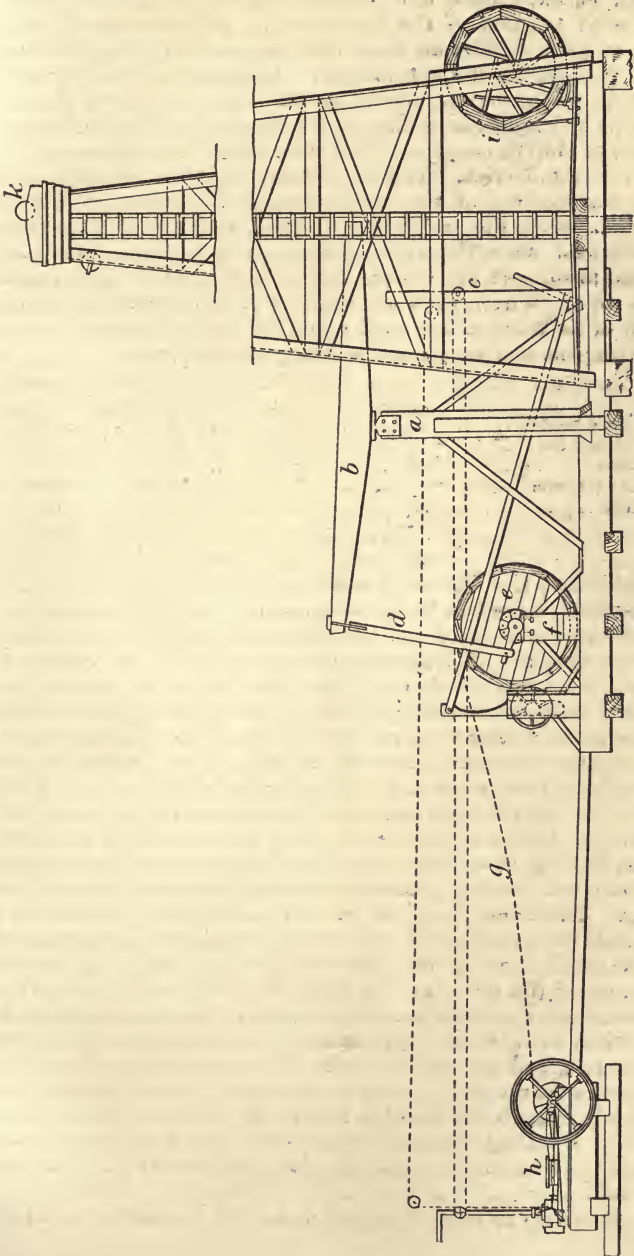

FIG. 89.—PETROLEUM WELL-BORING PLANT.

brake. A second windlass, termed a "sand-reel," is also provided. This smaller windlass, which is used for raising the detritus from the well, is fixed near the band-wheel, and can be brought into contact with the face of the band-reel, by pulling a lever inside the derrick, and the driller can thus from the mouth of the well start or stop the revolutions of the sand-reel. An endless cord, termed "the telegraph," passes round a pulley on the throttle-valve of the engine steam-pipe and a similar pulley in the derrick, so that the driller can also start or stop the engine. The reversing link is also operated by a cord from the derrick. The bull-wheel being, as explained, driven through the medium of the band-wheel, it is necessary to disconnect the pitman when the bull-wheel is used, and to throw the rope off the bull-wheel when the walking-beam is to be set in motion. The cable used to support the drilling tools is a 6-in. (2 in. diam.) untarred Manilla rope. Wire rope is not used, as it is not sufficiently pliable to admit of its being coiled on the shaft of the bull-wheel.

The lengths and weights of a string of tools are:—

	Length.		Weight.
	ft.	in.	lb.
Rope socket	3	0	90
Sinker bar	12	0	400
Jars	6	0	300
Auger stem	32	0	1050
Bit	3	4	140
	<hr/>		<hr/>
	56	4	1980

In addition, the following are required to complete the set:—Temper-screw, large jars, large bits, reamers, and two wrenches.

The tools are made of the best steel and Norway iron. The cost of the complete set of drilling tools is about 200*l.* A "sand-pump," or bailer, to remove the detritus from the well, often consists simply of a plain cylinder of thin galvanised iron, usually about 6 ft. long, but sometimes as long as 15 or 20 ft., provided at the bottom with a valve opening inwards. The valve is provided with a stem projecting downwards, so that, when the filled cylinder is lowered into a trough, the valve is pushed open, and the contents of the cylinder are discharged. A better sort of sand-pump consists of a wrought-iron cylinder, having, in addition to the bottom valve, a plunger attached to an iron rod passing through a stirrup spanning the top of the cylinder. The sand-pump is, in the latter form, suspended from the end of the plunger-rod, and when it reaches the bottom of the well, the slackening of the rope allows the plunger to descend to the bottom of the cylinder; on tightening the cord, the plunger is first raised, and the entrance of the detritus into the cylinder is facilitated; when the plunger has reached the stirrup, the cylinder itself begins to rise, and the valve closes. The rope attached to the sand-pump passes over a small pulley at the top of the derrick, to the sand-reel already described. Besides the drilling tools referred to, a large number of so-called "fishing tools" are employed, when, through breakage of the cable or otherwise, the tools, or any of them, remain in the well.

The first step in the drilling of a well is to sink a "conductor"

through the surface ground to the "bed-rock." When the superficial clays and gravels are not more than 10 to 15 ft. thick, a common well-shaft, 8 to 10 ft. square, is dug to the surface of the rock. A wooden conductor, 8 in. square in the clear, is then set up perpendicularly between the rock and the boarded floor of the derrick, the junction between the rock and the conductor being so made as to keep out gravel and mud. When the depth of surface ground is too great to admit of digging down to the rock, iron piping, termed "driving-pipe," is driven in by means of a "mall," working in guides, as in pile-driving. When 200-300 ft. have to be thus driven, as is sometimes the case, a good deal of skill is required. When the conductor is sunk to the bed-rock, the operation of drilling is commenced. The composition of the string of tools has already been stated. The jars practically divide the string into two parts, the one delivering its blow downwards and the other upwards. The auger or drill which cuts and pulverises the rock, consists of the bit, the auger-stem, and the lower link of the jars, while the function of the sinker-bar and upper link of the jars is to deliver a blow on the upward stroke, so that the "jar" may loosen the drill in case it should have become jammed in the rock. This appliance, which is of the greatest value, may be likened to two flat links of a chain, the cross-head of the upper one passing through the slot of the lower. The length of the slots is such that there is a play of 9 in., though a longer play has sometimes been given. A skilful driller never allows the jars to strike together on the downward stroke. The various members of the string of tools are connected together by male and female screws. The "temper screw," inserted between the walking-beam and the cable, admits of letting out the latter gradually, as the drill enters the rock. The "rope-socket" firmly grasps the cable at the required point, and from it the tools are suspended to the end of the walking-beam.

If the bed-rock is reached at a less distance than about 60 ft. from surface, the drilling of the rock is commenced by the operation termed "spudding," which consists in alternately raising and dropping the tools by tightening and then slackening the cable, which for this purpose is simply coiled 2 or 3 times round the revolving bull-wheel. A sufficient depth having been reached to admit of the regular use of the drilling tools, the cable is properly coiled on the bull-wheel shaft, the bull-rope is thrown off, the pitman is connected, and the string of tools is lowered into the well by releasing the bull-wheel brake, and suspended from the walking-beam. The tools having run to the bottom of the well, and the jars having closed by the slackening of the cable, the slack is taken up by turning the bull-wheel by hand until the cross-heads of the jars come together, this being plainly indicated by a tremulous motion imparted to the cable. About 4 in. of cable being then paid out, the tools are in the right position, and the walking-beam is started. If the vertical motion be 24 in., the sinker-bar first moves 4 in. on the up-stroke; the cross-heads of the jars then come together with a sharp blow, and the auger-stem is lifted 20 in. On the down-stroke the auger-stem falls 20 in. and delivers its blow on the rock, while the sinker-bar goes down 24 in. to telescope the jars. An unskilled workman sometimes closes the

jars (especially if the well be deep and nearly full of water), and works for hours without accomplishing anything, as the tools may be resting on the bottom or remaining suspended; but an expert can tell, by placing his hand on the cable, whether the drill is working properly or not. Before the well reaches a great depth, the movement of the tools can be distinctly recognised by grasping the cable. As the jar grows feeble, it is "tempered" to the proper strength by slightly altering the position of the temper-screw, and thus letting out a little more cable. The best drillers now, however, often drill by the spring of the cable, only using the jars when the bit sticks.

Under these circumstances, the tools are suspended so that the bottom of the bit is from 5 in. to 3 ft. from the bottom of the hole, the distance depending on the length and consequent spring of the cable. The walking-beam being set in motion, the tools rise and fall, and the elasticity of the cable allows them to touch the bottom and bound from it. This operation is termed "bouncing the drill," and the rock is thus cut faster than by the old method. As the drilling proceeds, the driller slowly rotates the temper-screw so as to cause the chisel end of the bit to do its work evenly. When the whole length of the temper-screw has been unscrewed, or the bit requires sharpening, the bull-rope is placed on the bull-wheel, and the string of tools is drawn up. The sand-pump is then lowered into the well, some water being first thrown down if necessary, and the pulverised rock is thus removed. Drilling and sand pumping thus proceed alternately day and night, unless a breakdown occurs, one driller and one engineer working from noon till midnight, and another pair from midnight till noon. At night the derrick is lighted with a primitive form of lamp, something like an iron kettle with a spout on each side, in which crude petroleum is burned. The operation of drilling seldom, however, proceeds very long without the aid of the "fishing tools" being required. Perhaps the cable breaks, or one of the tools becomes detached, and the operation of extraction, which is termed "fishing," is often very tedious. Considerable skill has, however, been expended in devising tools to meet almost all conceivable cases, and there are now hundreds of tools available; from the delicate "grab" designed to pick up a small piece of valve-leather, to the ponderous string of "pole tools" containing tons of iron, by means of which a set of tools can be unscrewed at a depth of 1500 ft., and brought up one by one, or a thread can be cut on the broken end of a sinker-bar or auger-stem.

Every oil-well is naturally divisible into three sections, viz.:— (1) surface clays and gravels, (2) stratified rocks containing more or less water, (3) stratified rocks, seldom water-bearing, including the oil-sands. The first division requires the conductor already described, and the second division requires casing to shut off the water from the third section. The earlier method of excluding the water, by placing a seed-bag round the tubing, has been found unsatisfactory, as the tubing could not be removed for repairs without disturbing the seed-bag, and letting water into the well. Cast-iron drive pipe was adopted as a substitute for the wooden conductor used in the earlier wells. An important alteration was the introduction of $3\frac{1}{4}$ -in. casing as a permanent fixture. This casing extended to the bottom of the

water-bearing rocks, and was furnished either with the seed-bag or with a leather cup, which was forced open against the sides of the well by the pressure of the water. The tubing, of $2\frac{3}{4}$ -in. external diam., and extending nearly to the bottom of the well, was then placed inside and suspended from the casing. To obtain a supply of water for the boiler, a small pipe was often inserted, between the tubing and the casing, into the water-chamber above the seed-bag. Although this well was a great improvement, it possessed defects. Thus the casing being $3\frac{1}{4}$ -in. internal diam., while the uncased part below it was $5\frac{1}{2}$ -in., fishing tools could not be easily introduced, and if it became necessary to deepen the well, only $3\frac{1}{8}$ -in. bits could be used. The modern well has an 8-in. wrought-iron drive-pipe, armed at the bottom with a steel shoe. The pipe is driven down to the bed-rock, and an 8-in., or, strictly speaking, $7\frac{7}{8}$ -in., hole is drilled in the base of the water-bearing strata. At this point, the bore is gradually reduced to $5\frac{1}{2}$ -in., and there a bevelled shoulder is made; $5\frac{1}{2}$ -in. casing, provided at the lower end with a collar to fit the bevelled shoulder, is then inserted, and a sufficiently water-tight joint is thus made. Drilling with $5\frac{1}{2}$ -in. bits is then continued until the required depth has been reached. When gas is obtained in sufficient quantity to furnish fuel for the boiler, it is conveyed through a 2-in. pipe connected with the casing beneath the derrick floor, and passing into the door of the furnace. A $\frac{1}{4}$ -in. steam-pipe, fitted with an elbow and $\frac{1}{8}$ -in. jet, is inserted in the gas-pipe, close to the fire-box, and a blast of steam is thus caused to issue with the gas. The apparatus acts as an exhauster, drawing the gas from the well, and preventing the flame from running back. The cost of a well is about 600*l*.

The "water-packer" is a device to prevent water that may pass into a well below the casing from gaining access to the oil-sand, and to stop the ascent of gas on the outside of the tubing. It is applied round the tubing at any desired point, and its effect is to shut off all communication between the annular space outside the tubing above it and the oil chamber below. The oil and gas are thus confined in the well chamber, and many wells are thus caused to flow that would otherwise require pumping. Under these circumstances the flow is intermittent, taking place when sufficient gas-pressure has accumulated. There are many forms of water-packer, but one of the simplest consists of a band of rubber which, on compression, is forced against the walls of the well. If the well does not flow, the oil requires to be raised to the surface by a pump. The working barrel of the pump is placed at the bottom of the well on the end of the tubing, a perforated piece of casing of proper length, termed the "anchor," being attached to the lower end of the working barrel. To the sucker of the pump the required number of wooden sucker-rods, screwed together, are attached, the upper end of the string of rods being connected with the walking-beam. There is, of course, a valve at the bottom of the working barrel, and in the sucker. The sucker is provided with a series of 3 or 4 leather cups, which are pressed against the working barrel by the weight of the column of oil. The sucker rods are of ash, $1\frac{1}{2}$ in. diam. by 24 ft. to 28 ft. long. When a number of contiguous wells are to be pumped, an arrangement termed a

“grasshopper” apparatus is employed. By this means several wells can be pumped by the action of a single walking-beam.

Most petroleum wells in the United States are “torpedoed” on the completion of the drilling, in order to increase the flow of oil. The torpedo is a charge of nitro-glycerine in a suitable shell, which is lowered to the oil-bearing rock, and there exploded, with the effect of opening fissures into the surrounding rock. The shells, which are of tin plate, are of two kinds. One form is lowered to the bottom of the well by a string that can easily be detached, and rests on what is termed an “anchor,” which is simply a cylindrical tin tube of such length as will bring the torpedo to the required position. To the upper end of the shell is fitted a “firing head” consisting of a circular plate of iron, only slightly smaller than the bore of the well, having projecting vertically downwards from its lower surface a rod on which a percussion cap is placed. Beneath the cap is an anvil. The lowering cord having been detached and drawn up, a cast-iron weight, termed a “go devil,” is dropped into the well, and this weight striking the disc explodes the percussion cap and fires the torpedo. The other form of shell is suspended by a cord, which serves as a guide for a perforated weight running on it. The usual size of the former description of shell is $3\frac{1}{2}$ in. diam. by 10 ft. long, a shell of these dimensions holding 20 quarts of nitro-glycerine. Frequently as large a charge as 80 quarts is used, and it is then usual to employ 4 shells of the dimensions given, the lower end of one fitting into the upper end of another, and only the top shell of the series having the firing head. Shells of the other description are commonly termed squibs. They are of much smaller dimensions, holding only about 1 quart of the explosive liquid, and are now generally used to bring about the explosion of the large torpedo.

The torpedo is usually exploded under about 50 ft. of water. Little or no sound is heard, but a slight quiver of the ground is often perceptible. A few moments after the explosion, however, the fluid in the well is shot into the air with great violence, forming a magnificent fountain, and small pieces of rock are also thrown out. The torpedo and exploding weight are blown into small fragments.

Some authorities are of opinion that the effect of the torpedo is simply to clear the pores of the rock of obstructions, the apparent increase in the yield of oil being due to reaction from the immense gas pressure produced by the explosion. Many wells, however, that produced no oil on the completion of the drilling (technically termed “dry-holes”) have, through the use of the torpedo, been caused to yield abundantly. In Russia the torpedo is never used.

A modification of the rope system of drilling, known as the rod system, is adopted in Canada, Russia, and Galicia. It consists in the substitution of 2-in. ash rods, 16 ft. long, screwed together, for the portion of the drilling cable which passes from the end of the walking-beam to the string of tools. Iron rods are used in Russia. The rods, in some cases, work in guides. The rod system is apparently preferable to the rope system, where the well is not very deep.

In Russia it is usual to commence drilling with a bit as much as 15 to 16 in. diam., but it is generally found necessary to gradually

diminish the size of the bit as the drilling proceeds. The average rate of sinking is 140 ft. per month. In consequence of the extreme pressure of the gas, amounting sometimes to as much as 300 lb. per sq. in., it is found difficult to prevent the oil from escaping between the casing and the ground. This difficulty has been overcome by sinking an octagonal well about 6 ft. diam. and 40 ft. deep, down to the hard ground, and filling in the space round the casing with masonry in cement; or by tamping the space with puddled clay, after the joint between the casing and the hard ground has been caulked with rope-packing.

When wells have ceased to yield oil in remunerative quantity in the United States, it is usual to draw out the iron casing for use in other wells; but as this operation allows surface water to gain access to the oil-sand, and as it has been found that the yield of adjacent wells is prejudicially affected by this "flooding," as it is termed, the Pennsylvania Legislature enacted that abandoned wells should be "plugged" by filling them with sand. The prejudicial effect of the flooding of the oil-bearing strata has been experienced in the Caucasus, the percentage of water in the oil raised in that locality being steadily on the increase.

When the oil has reached the surface, either by flowing or being pumped, it is conducted into a tank, usually of wood, holding about 250 barrels. In America, quantities of crude petroleum are always stated in "barrels" of 42 gal. (5 American gal. = 4 Imperial gal.). In the early days of the industry, the only method of transporting the oil was in oak barrels holding 40 or 50 gal., coated internally with glue; but the small quantity of water present in the oil was found to dissolve the glue, and cause the barrels to leak. The tank car now employed consists of a cylinder of boiler-plate, lying upon a 4-wheeled truck, and provided with a dome similar to that which a horizontal steam-boiler has. The tank is furnished with means of filling at the top, and with a valve beneath by which it can be emptied; it is usually about 24 ft. 6 in. long by 66 in. diam., and holds 4500 to 5000 gal.

Gradually a system of pipe-lines, running from the wells to central stations and thence to loading stages on the railway lines, was constructed, and at the present time there is in the oil regions of the United States a complete network of 2-in. piping connecting the various wells with storage tanks and trunk lines, aggregating thousands of miles.

The first trunk line extended from the lower oil country to Pittsburgh, a distance of 60 miles, and was 4 in. diam. The New York line consists of two 6-in. tubes for the entire distance, with a third 6-in. tube for a portion of the way, and is provided with 11 pumping stations about 28 miles apart; its transporting capacity is about 28,000 barrels a day. The greatest elevation of the pipe between stations above tide-water is 2490 ft. The Philadelphia pipe has a diameter of 6 in. with 6 stations; the Baltimore pipe is 5 in. diam. without a break; the Cleveland pipe 5 in. with 4 stations; and the Buffalo and Pittsburgh pipes 4 in. with 2 stations.

The pipe is made specially, and is of wrought iron, lap-welded.

It is tested to a pressure of 1500 lb. per sq. in., the working pressure being 900 to 1200, or even sometimes 1500 lb. The pipe is in lengths of 18 ft., provided at each end with coarse and sharp taper threads, 9 to the inch, and the lengths are connected with long sleeve couplings, also screwed taper. The line is usually laid 2 or 3 ft. below the surface of the ground, though in some places it is exposed, and at intervals bends are provided to allow for contraction and expansion. At the different pumping stations there are storage tanks of light boiler plate, usually 90 ft. diam. by 30 ft. high, the oil being pumped from the tanks at one station to those at the next, though sometimes loops are laid round the stations, and oil has thus been pumped a distance of 110 miles with one engine. The pumping engines chiefly employed are the Worthington engines, constructed at the Worthington Works in New York, and at each station there is usually a duplicate set. The characteristics of these pumps are independent plungers with exterior packing, valve-boxes subdivided into small chambers, and leather-lined metallic valves with low lift and large surfaces. The engines vary in size from 200 to 800 h.p. The pumps are so constructed that before one plunger has completed its stroke another has taken up the work. The column of oil is thus kept continuously in motion, and the violent concussions which occur when the oil column is allowed to come to rest between the strokes are avoided.

Tankage at convenient centres of distribution is necessary. American tanks usually hold about 30,000 barrels. They are of boiler plate, roofed with wood, covered with sheet iron, the roof being usually slightly conical.

Oil is frequently pumped, in hot weather, when it is most fluid, a distance of 80 miles. At high pressure leaks occasionally occur, and workmen sometimes have their hands cut to the bone by the fine stream of oil issuing from some minute orifice when engaged in stopping the leaks.

A very interesting feature of the pipe line system of transportation is the arrangement adopted for cleaning the pipes, and removing obstructions caused by sediment. The apparatus used (termed a "go-devil") consists in many cases of a brush of steel wire of conical form, fitted, at the base or rear end of the cone, with a leather valve in 4 sections, strengthened with brass plates, and also furnished with long steel wire guides. This instrument is impelled by the stream of oil, and travels at the rate of about 3 miles an hour. Its progress can be traced by the scraping sound which it makes, and it is followed from one pumping station to another by relays of men on foot. It must never be allowed to get out of hearing, otherwise, in the event of its progress being arrested by an obstruction, it may be necessary to take up a considerable length of piping to ascertain its position.

It is by no means uncommon for storage tanks of crude petroleum to be set on fire by lightning, notwithstanding the general employment of lightning conductors, the vapour which the oil evolves readily taking fire, and communicating flame to the oil. When a tank has taken fire, the oil usually boils over, and to prevent this, holes through which the oil may escape are made by firing round shot at the tank from small cannon. Such fires are occasionally of great magnitude,

and, as may be imagined, involve no small danger to surrounding property.

English store tanks of the older form are arranged partly underground, rising to a height of about 4 ft. above ground; this portion is protected by a wall and about 3 ft. of concrete, and the roof is formed of a layer of chalk about 1 ft. thick. In the more modern form of storage tank the covering is arranged so that a current of air can pass over the surface of the stored petroleum. According to practical experience it would seem that a tank open to the air is more suitable for storage than one which is closed; in the latter case, the manholes are protected by a layer of earth. In the one case, the more volatile portions are sealed up ready to take fire, either by the approach of a light, or from a sudden or undue rise of temperature; while in the case of the open tanks the current of air carries off the volatile vapours as fast as they are generated. As nothing is stored but the usual class of petroleum with a fairly high flashing point, the loss by evaporation is not sufficiently sensible to weigh against the greater safety brought about by this system. In Liverpool, the storage tanks are excavations made in the solid red sandstone rock, one side being built with concrete and brick.

The production of crude petroleum in the United States is about 2,000,000 gal. yearly. In 1892 it reached 2,282,469 gal., of which 104,397 gal. were exported as crude petroleum, 16,393 gal. as naphtha, 589,418 gal. as illuminating oil, 34,027 gal. as lubricating oil, 403 gal. as residue, and 69,876 lb. paraffin. The total output of the United States to end of 1888 is computed at 373,000,000 gal., not counting a waste of about 20,000,000 gal. The Caucasus affords about 3,000,000 tons annually, Galicia about 1,000,000 barrels, Japan about 5000 tons, Italy about 200 tons, Canada about 1,000,000 barrels, Great Britain about 35 tons.

Ozokerit.—Ozokerit, ozocerite, earth-wax, mineral wax, or cerisine, is a solid hydrocarbon, usually regarded as a petroleum very rich in paraffin. Its composition has been found to be :

	Moldavian.		Urpeth. Johnson.	Utah. Newberry.
	Malaguti.	Schrotter.		
Carbon	85·75	86·20	86·80	86·15
Hydrogen.. .. .	15·15	13·77	14·06	13·75
	100·90	99·97	100·80	99·90

It is supposed to be composed of several members of the paraffin series which are represented by the general formula C_nH_{2n} , and, perhaps, contains certain of the olefines. Its density ranges from ·850 to ·950, and its melting point from 136° F. to 212° F. Pure specimens resemble resinous wax in consistency and translucency, sometimes with a foliated structure. Its colour is brown or brownish-yellow by transmitted light, and leek-green by reflected light. The poorer qualities, which are black, and are either too soft from abun-

dance of petroleum, or too hard (asphalt-like in character), are used for the production of paraffin. The American mineral is dark brown on the surface, but grows lighter in colour as the deposit is worked. Energetic chemical reagents, such as sulphuric and nitric acids and alkalis, have no action on it. It is odourless and tasteless.

Galician mineral wax is found in Miocene clay shales and clay marls, with intercalated sandstone, and it frequently accompanies rock salt and gypsum. At Boryslaw it is found after a depth of 20 to 70 ft., and some shafts have been sunk 700 ft., where the accompanying rock is strongly impregnated with oil. At Truskawiec there are surface veins of the wax, and the shafts have not been sunk so deep.

Small quantities of ozokerit have been discovered in England, at Binney quarry, Linlithgowshire, at the Urpeth colliery, Newcastle-on-Tyne, and in Wales. It is also found in Moldavia, and in the neighbourhood of Agram, in Croatia, but the most important deposits are in Galicia, at the northern foot of the Carpathian Mountains. The exact localities are Boryslaw, Truskawiec, Dwiniacz, and Starunia; the first named being the most valuable. In America its occurrence is reported about 50 miles north-east of Los Angeles, California; in Texas, and in Utah. The only working deposits are situated near Pleasant Valley Junction and Soldiers' Summit, 114 miles east of Salt Lake City, on the Denver and Rio Grande Railway.

In nearly every case the Galician mineral is raised through vertical shafts or pits, over which a wooden roof is erected. The section of the shafts in the first instance is 32 to 43 sq. ft.; but when the ozokerit formation is reached, an inner shaft 39 in. square is formed of timber, and the space between this and the timbering of the larger shaft is filled with stiff clay. This construction is adopted to exclude the surface water, which is kept down by hand-pumps during sinking. From the bottom of the shafts, levels are driven into the ozokerit ground, the richer portions being raised and the refuse used to fill up the old workings. The softer parts of the marl are dislodged by means of pick or wedge; but where the rock is hard, and the permission of the mining authorities can be obtained, dynamite is used. The mineral is raised by hand, in skips or tubs holding 88 to 110 lb. Hand ventilators are used for the purpose of ventilation, but explosions of gas are not uncommon. Safety-lamps are used in all the mines. The timbering of the shafts requires constant renewal and repairs; in some cases it is almost impossible to keep the shafts perpendicular.

The water is usually raised in tubs, and much difficulty is experienced in getting rid of it after it reaches the surface, on account of the numerous shafts and the broken nature of the ground. The mineral, when it leaves the tubs, is sorted by hand. The waste rock is picked out and tipped to spoil, lumps of ozokerit are specially selected, and the remainder of the rock, containing fragments of wax, is tipped into tanks full of water. On being well stirred, most of the wax rises to the surface, and is skimmed off. The residue still contains 2 to 3 per cent. of wax. The quantity of waste mineral being considerable, and the distance between the shafts small, a special railway has

been built to remove the residues from the immediate neighbourhood of the mines.

Ozokerit is largely used in Europe, especially in Russia, as a substitute for beeswax. Refined ozokerit, or ceresin, is distilled, and the resulting wax is employed for the manufacture of candles, which are especially adapted for use in high temperatures, as they are less likely to gutter and bend than ordinary paraffin candles. Another product made from ozokerit by distillation resembles vaseline, and is used in ointments and pomades. By the action of Nordhausen sulphuric acid it is rendered white, and is consumed in that form by French perfumers as a substitute for lard in the process of *enfleurage*, the almost entire insolubility of the hydrocarbon in alcohol giving it great advantage over animal fat. The residue in the retorts after distillation consists of a hard, black, waxy substance which is used for the manufacture of okonite, a valuable electrical insulating material. The black ozokerit residue is combined with rubber, welded by passing through rollers at moderate temperature, and vulcanised. Okonite is not only a good insulator, but is remarkably flexible and tough.

The annual production of ozokerit in Galicia reached its maximum in 1886, when the figure was 139,254 centners of 100 kilos, or say 14,000 tons. In 1890 the output had fallen to about 6000 tons. The value of best quality is about 30*l.* a ton. The American production was 43,500 lb. in 1888, 50,000 lb. in 1889, 350,000 lb. in 1890, 50,000 lb. in 1891, and 130,000 lb. in 1892. Its value is about 18*l.* to 22*l.* a ton.

PHOSPHATES.

DEPOSITS of phosphatic minerals having different characteristics, in physical appearance and in chemical composition, as well as in the results obtained from them, have been found in nearly every part of the globe. The commercial value of these is chiefly regulated by the percentage of tribasic phosphate of lime they contain. The richer they are in this element, the more valuable they are (*cæteris paribus*) for the manufacture of superphosphates. But, the amount of phosphate of lime in a mineral cannot be taken as the only criterion of its value, for it sometimes happens that a phosphate containing a lower percentage of this ingredient will make a stronger and better superphosphate than a richer one containing more deleterious impurities. The value is very much affected by the amount of lime carbonate, iron, alumina, and calcium fluoride present; also, by its porosity or density, and the facility with which it can be reduced to a fine powder. If not in excessive quantity, lime carbonate is rather an advantage than otherwise in the manufacture of a good conditioned superphosphate, inasmuch as the carbonic acid disengaged from it when acid is applied, makes a mass more bulky and open, and causes it to appear porous or honeycombed when finished.

The presence of a large quantity of iron and alumina in mineral phosphates is objectionable, for they not only absorb acid, but superphosphates made from them have a tendency to "go back," or become insoluble again; therefore, the unit percentage of lime phosphate is worth less in minerals containing a good deal of these, than in others containing only a little. Calcium fluoride, which generally accompanies phosphatic minerals, also reduces their value. It wastes acid, and in becoming lime sulphate, its weight is increased to the detriment of the superphosphate. Silicious matter is a useless ingredient, but a harmless one, except in so far as it causes an unnecessary weight to be moved about, and when in excessive quantity reduces the proportion of soluble phosphate in the superphosphate to such an extent as to make it unmarketable. Ordinary mineral superphosphate contains biphosphate of lime equal to 25 to 28 per cent. of tribasic phosphate of lime rendered soluble; and, as it is well known that good Cambridge coprolites are capable of yielding this of a good chemical composition, and in a dry powdery condition, the analysis of this mineral may be taken as a fair standard upon which to assess the value of others.

Cambridge coprolites come from the Upper Greensand in Cambridgeshire, and occur as small nodular hard masses of a grey colour (supposed to be fossil excrement of animals) or occasionally concretions around bones, amongst which are found fish teeth and some vertebræ. Either from the exhaustion of the better sorts or from imperfect washing, the quality has deteriorated, and there is now some difficulty

in making superphosphate from them to contain more than 25 per cent. of soluble phosphate. Their average composition is:—

	Per cent.
Tribasic phosphate of lime	55 to 60
Lime carbonate	12 „ 18
Alumina and iron oxide	3 „ 5
Calcium fluoride	2 „ 4
Insoluble silicious matter	6 „ 8

Sometimes the iron and alumina reach 10 to 14 per cent.

These coprolites are extracted by washing from a stratum not more than 1 ft. thick. An average yield is 300 tons per acre, and sometimes as much as 300%. an acre has been paid for the right to dig them.

An inferior coprolite is mined at Wicken, in Cambridgeshire, having the following composition:—

	Per cent.
Moisture	1·66
Loss by ignition	2·97
Sand, silica, and pyrites	24·46
Calcium fluoride	2·02
Lime sulphate	1·53
Lime carbonate	10·16
Lime silicate and organate	6·40
Lime tri-phosphate	35·66
Iron oxide	7·56
Alumina	4·07
Phosphoric acid	2·67

In Suffolk, coprolites are found subjacent to the London clay, and consist chiefly of rolled pebbles, with a small proportion of more or less perfect specimens of bones of various animals, as also some fish and crustacea. They were formerly regarded as fossilised excrements of animals, for which reason they were called coprolites; but they are now supposed to be calcareous pebbles, which have undergone a peculiar change, and become impregnated with phosphoric acid by long continued contact with decaying animal and vegetable matter. The name pseudo-coprolite has been given from their resemblance to the Cambridge coprolites, but they are distinguished from the latter by a brownish ferruginous colour and a smoother surface. They are very hard, and generally contain too much iron oxide and alumina to allow them to be used safely in the manufacture of superphosphates. Their percentage composition is:—

	Per cent.
Tribasic phosphate of lime	52 to 61
Lime carbonate	10 „ 17
Alumina and iron oxide	5 „ 10
Calcium fluoride	1 „ 4
Insoluble silicious matter	9 „ 12

Bedfordshire coprolites have an affinity to the Suffolk nodules, and are composed generally of:—

	Per cent.
Tribasic phosphate of lime	50
Lime carbonate	8
Alumina and iron oxide	8
Calcium fluoride	4
Insoluble silicious matter	20

Wales possesses very extensive phosphatic deposits in Montgomeryshire, the mineral averaging about 50 per cent. phosphate of lime, 25 silicious matter, 9 lime carbonate, 7 insoluble iron sulphate, and 1 each of alumina and iron oxide. The rock as mined carries much worthless matter, and to dress it up to 46 per cent. standard costs 3s. a ton. Its colour seems to be prejudicial to its sale, as the industry is languishing.

England produces 10,000 to 30,000 tons of phosphate yearly.

In Russia, coprolites are found in some abundance, but their poor quality is indicated by the following figures:—

	Per cent.
Tribasic phosphate of lime	33 to 48
Lime carbonate	5 „ 6
Alumina and iron oxide	5 „ 6
Calcium fluoride	3 „ 4
Insoluble silicious matter	42 „ 44

Enormous coprolite beds occur in France, notably in the neighbourhood of Boulogne and near the Belgian and Swiss frontiers. The Boulogne coprolites are met with as dark grey nodules, much associated with organic remains. They have been shipped in quantities to England, and used in admixture with richer phosphatic materials. Samples from Pas de Calais showed on analysis:—

	Per cent.
Moisture	0·610
Sand, pyrites, &c., insoluble in HCl	33·340
Silicic acid	1·490
Calcium fluoride	2·100
Lime sulphate	2·487
Lime carbonate	11·360
Lime silicate, &c.	7·360
Triphosphate of lime	29·150
„ of magnesia	2·552
Iron oxide	2·11
Alumina	2·730
Phosphoric acid	5·700

The production reaches about 300,000 tons annually.

Various complete analyses of Boulogne coprolites indicate the average contents to be:—

	Per cent.
Moisture	·79 to 1·74
Water of combination	1·04 „ 3·24
Phosphoric acid	17·69 „ 21·27
Lime	30·41 „ 35·38
Carbonic acid	3·55 „ 5·25
Sulphuric acid	·85 „ ·90
Fluorine	2·08 „ 4·69
Magnesia	·25 „ ·83
Iron oxide	2·89 „ 6·24
Alumina	3·09 „ 5·39
Insoluble silicious matter	23·56 „ 28·45
Tribasic phosphate of lime	38·61 „ 45·97
Lime carbonate	8·07 „ 11·93

In the Ardennes, the beds lie beneath about 200 ft. of clay.

France is particularly rich in phosphate. The south, centre, north, and east in particular are well supplied with it, as it has been esti-

mated that the total amount existing in these districts exceeds 32,000,000 tons. The production of natural phosphates rose in 1886 to 184,166 tons, representing a value of nearly 7,080,000 francs or over 283,000*l.*

The number of quarries amounted to 796, and of workmen to 3160. The most important department was that of the Meuse, from which nearly 52,000 tons of phosphate were obtained, the price of which averaged about 25*s.* a ton. These phosphates, consumed partly in the neighbouring departments, find their way also to Brittany and La Vendée. In the Pas de Calais the production of phosphates, washed and ground, amounted to 30,000 tons, with an average price of about 32*s.* per ton. After these two departments comes that of Lot, in which the production amounted to 26,000 tons, sold in the Midi at about 25*s.* per ton, after grinding. The department of the Gard supplied 13,000 tons of triturated phosphate. In the east of France, phosphate of lime is obtained from the greensand; principally from chalk in the north; and from calcareous soil in the departments of the Gard, Lot, Aveyron, and Tarn-et-Garonne.

The mineral known as Lot or Bordeaux phosphate comes from the departments of Lot and Lot-et-Garonne, in France. It occurs in pockets in fissures in the limestone, and also in thin layers, near the surface. These are covered with an alluvial soil and clay, containing phosphates but much contaminated with iron and other impurities. The pockets, of all shapes and sizes, and sometimes reaching 100 ft. deep, are generally traced and indicated by narrow vertical veins of deposit, which rise from them to the surface, and are mostly found on the highest ground. It varies greatly in appearance, texture, and composition. Occasionally, it is found in snow-white compact masses, breaking with an earthy fracture, and of a moderate degree of hardness. The more ordinary kinds are of a dark yellow or brown, dense and hard; but it is frequently found of a dark agate colour, somewhat resembling the inside of broken flints, of a waxy lustre, stratified and intersected with thin layers of iron oxide. It has the appearance of being an aqueous deposit, and the probable cementing together of lumps of phosphates, bones, &c., with more or less alluvial clay and earth, by the percolation of dissolved phosphatic matter, may account for the appearance, texture, and composition of some portions. The white specimens are generally the richest, some being as high as 85 per cent. with a minimum ($\frac{1}{2}$ per cent.) of iron, &c., but the bulk only contain 70 to 72 per cent., and with 4 or 5 per cent. of iron, &c. Fossil bones and teeth are found in quantity. The surface phosphatic earth finds a ready sale on the spot. Analyses of two sample parcels showed:—

	Per cent.
Tribasic phosphate of lime	55·45 to 67·19
Lime carbonate	8·3 „ 15·31
Iron, alumina, fluorides, &c.	12·86 „ 4·2
Silicious matter	19·13 „ 5·2

The best varieties of these phosphates are well adapted for the manufacture of superphosphate.

German or Nassau phosphate, deposited like the Bordeaux variety

in pockets, is found chiefly in the neighbourhood of the rivers Lahn and Dill, in Nassau. Some of it is of a yellow colour, breaking with an earthy fracture; other portions have the appearance of pieces of phosphate, cemented together with ferruginous clay; and in rare cases it appears in a crystalline form. The richest varieties are of a light yellow colour, and tolerably free from iron, &c.; but the predominating lower qualities are contaminated with much iron ore, clay, limestone, &c. The composition varies thus:—

	Per cent.
Tribasic phosphate of lime	58 to 65
Lime carbonate	5 „ 8
Iron and alumina	10 „ 15
Insoluble matter	10 „ 12

From these phosphates there is no difficulty in making superphosphate quite dry, but they invariably set extremely hard, and they therefore require much breaking up. They cost about 26–30s. a ton ready for market, and are much used locally.

Spanish and Portuguese phosphorite generally goes under the name of Estremadura phosphate, from the province in Spain where it is chiefly found. It is hard, of light yellow colour, crystalline structure, and generally more or less mixed with quartz, and becomes phosphorescent when heated. It is tolerably free from iron and alumina, but contains variable and often considerable quantities of calcium fluoride. Following are some analyses of Estremadura phosphate:—

	Per cent.
Tribasic phosphate of lime	72 to 80
Lime carbonate	0 „ 9
Alumina and iron oxide	2 „ 4
Calcium fluoride	2 „ 4
Insoluble silicious matter	4 „ 18

The production in 1890 was less than 1000 tons. In conversion into superphosphate about 30–33 per cent. of the phosphate is rendered soluble, but the lack of lime carbonate induces a dense and damp product requiring some time for getting into good condition.

Describing the deposits found in a series of caverns in Eocene limestones on the north-eastern flank of the Pyrenees, in the Aude Valley, Armand Gautier* mentions quantities of concretionary phosphorite and other phosphates, both of lime and alumina, varying from 15 to 50 ft. in depth, being estimated to contain from 120,000 to 300,000 tons of phosphatic minerals, which differ in many respects from the ordinary phosphorites of stratified formations. Among these, one of the most interesting is brushite, a hydraulic dibasic calcium phosphate ($2\text{CaOP}_2\text{O}_5, 5\text{H}_2\text{O}$) which had only been known previously as a secondary product incrusting the rock guano of Aves Island and Sombrero in the West Indies. It contains phosphoric acid 43, lime 34, and water 23 per cent., and, as a rule, occurs in crusts upon and filling fissures in the limestone rocks. The bulk of the deposit is, however, made up of mixtures of tribasic calcic phosphate and neutral phosphate of alumina, which vary within rather wide limits, but frequently are in nearly equal proportions, about 24–25

* 'Annales des Mines.'

per cent. of each, containing about $27\frac{1}{2}$ per cent of phosphoric acid, which is mostly all soluble in weak acids. A third, and previously undescribed substance, to which the name of minervite has been given, is a hydrated aluminic phosphate ($\text{Al}_2\text{O}_3\text{P}_2\text{O}_5, 7\text{H}_2\text{O}$) which was found as a white plastic mass, filling a vein 2– $2\frac{1}{2}$ ft. thick.

The geological formation of the South Carolina phosphate belt is made up of Quaternary sands and clays overlying beds of Eocene marls with the phosphate distributed over their surface or mixed up indiscriminately with them. The total area covered by it is said to be 70 miles long by 30 miles broad; the richest and most accessible portion being in the immediate neighbourhood of Charleston. Whether the deposit is continuous or not over the whole of this zone, it certainly varies considerably in depth and thickness. In many places it is 3 ft. thick and crops out at the surface, whereas in others it dwindles down to a few inches, or is found at depths varying from 3 ft. to 20 ft. These two conditions, thickness of deposit and depth of strata, taken together with the richness of material in phosphoric acid, are of course the chief points for consideration in the economic working of the beds on an industrial scale.

In the two kinds of deposits, the "River" and the "Land," the material is of practically the same chemical description. Both have been worked extensively and have proved to be of great commercial value, the first especially so, since it is obtained by the simple and inexpensive process of dredging, and is thus raised and washed from all adhering impurities by one and the same operation.

The rock and nodules are found in very irregular masses or blocks, of extremely hard conglomerate, and of variegated colours, weighing from less than $\frac{1}{2}$ oz. to more than 1 ton. The mean specific gravity of the material is 2.40, and it is bored in all directions by very small holes. These holes are the work of innumerable crustacea, and are now filled with sands and clays of the overlying strata. Sometimes the rock is quite smooth or even glazed, as if worn by water; at others it is rough and jagged.

Interspersed between the nodules and lumps of conglomerate are the fossilised remains of various species of fish, and some animals, chiefly belonging to the Eocene, Pliocene, or post-Pliocene ages.

Very careful analyses of a large number of the samples of "land rock" taken from working pits and made by Wyatt gave, after being well dried at 212°F ., the following average: Moisture, water of combination, and organic matter lost on ignition, 8 per cent.; lime phosphate, 59.63 per cent.; lime carbonate, 8.68 per cent.; iron and alumina (calculated as oxides), 6.6 per cent.; magnesia carbonate, 0.73 per cent.; sulphuric acid and lime fluoride, 4.8 per cent.; sand, silicious matters and undetermined, 11.56 per cent.

The cost of producing one ton of "river rock" in dry marketable condition is generally allowed to be about 5.25 dols. per ton, including 2.00 dols. royalty, and, with a properly constructed plant, well managed land companies with no royalty to pay, place their cost of production at about 4 dols., delivered free alongside vessels in Charleston harbour.

As a raw material of the first class in the manufacture of soluble and available phosphates, South Carolina rock will continue to be everywhere held in the highest esteem. In Europe it is also very popular, and, being of unvarying quality, has yielded results that cannot be surpassed by any other phosphate as an all-round staple, uniform, and reliable article.

No absolute opinion can be expressed as to the probable extent and capacity of the yet untouched or unexploited deposits, but it may probably be safely estimated at about 30 miles. Placing the yield of this area at the present average of 750 tons to the acre, the conclusion would be that the State may still produce about 14,000,000 tons.

The annual production of Carolina phosphate is about 400,000 to 500,000 tons, but in 1892 it fell to 350,000. The selling price in foreign markets has been 6*d.* per unit, which was fixed with the object of killing competition, while it entailed a loss to the producer.

The existence of nodular amorphous phosphate deposits in Florida is not a matter of recent discovery, for they were found in various directions many years ago, but were never believed to be of sufficient importance either in quantity or quality to merit the serious attention of capitalists. The geological formation in which the deposits occur has been very fully described in Wyatt's 'Phosphates of America,' and may be broadly summed up here as being composed of:—

1st. Original pockets or cavities in the Vicksburg limestone, filled with hard and soft rock phosphates and débris.

2nd. Mounds or beaches rolled up on the elevated points, and chiefly consisting of huge boulders of phosphate rock.

3rd. Drift or disintegrated rock, covering immense areas, chiefly in Polk and Hillsboro counties and underlying Peace River and its tributaries.

The work of exploration or prospecting has now extended all over the State in each of these varieties of the formation, and actual exploitation on the large scale by regular mining and hydraulic methods has been commenced at various points.

In several of the mines, notably in those of Marion and Citrus counties, there are immense deposits of phosphatic material, proved by actual experimental work to extend in many cases over uninterrupted areas of several acres. The deposits in each case have shown themselves to be combinations of the "original pocket" and the "mound" formation, and the superincumbent material, or overburden, is principally sand, and may be fairly said to have an average depth of about 10 ft. The phosphate, immediately underlying it, is sometimes in the form of enormous boulders of hard rock, cemented together with clay, and sometimes in the form of a white plastic or friable mass resembling kaolin, and probably produced by the natural disintegration of the hard rock by rolling, attrition, or concussion. The actual thickness of the deposits is too variable to be computed with any accuracy into an average, but it has been known to reach a depth of 50 ft., and a little over 2 acres only has yielded more than 20,000 tons of good ore, without signs of exhaustion. Directly outside of the limits of these combined "pockety" and "mound" formations, the deposits of phosphate seem to abruptly terminate, and to give place

to an unimportant drift, which sometimes crops out at the surface, and which may be followed in all directions over the immediate vicinity without leading to another pocket of exploitable value.

The same geological phenomena are prevalent in nearly every section of the country, with the exceptions of Polk and Hillsboro counties, where they are somewhat modified. We are, therefore, warranted in declaring that the Florida phosphates of high grade occur in beds of an essentially pockety, extremely capricious, uneven and deceptive nature.

Sometimes the pockets will develop into deep quarries, and will probably yield large quantities of various merchantable qualities. At other times they will be entirely superficial, or will contain the phosphate in such a mixed condition as to render profitable exploitation impossible.

In the case of the "pebble" or "drift" deposits this capriciousness is much less marked; in fact an unusual degree of regularity may be said to characterise their occurrence in the extensive area in which they have been found, and which may be roughly said to take its point of departure in Polk county, a little to the south of Bartow, and thence to practically continue with a gradually narrowing tendency to within a very short range of Charlotte Harbour. The country is flat and swampy, and is intersected at frequent intervals by the Alafia, Manatee, Peace, and others rivers, rivulets, and streams.

Pit-sinking is now going on over a wide area, and it has been practically demonstrated that this section of Florida is more or less underlaid with a nodular phosphate stratum of a thickness varying from a few inches to 30 ft., and covered by an overburden that may be fairly averaged at about 8 ft.

The actual chief working centre for "pebble" phosphates is Peace River, which rises in the high lake lands of Polk county and flows rapidly southward into the Gulf of Mexico. Its course is extremely irregular, and its bottom is a constant succession of shallows and deep basins. Lakes Tsala-Opopka and Chillicoatchee and Pains and Whidden creeks are its chief tributaries and the main sources of its phosphate deposits, the pebbles being washed out from their banks and borne along their beds by the torrential summer rains.

Prof. Cox ascribes the Florida phosphate deposits to the mineralisation of ancient guano. They occur in much-weathered Eocene limestone, filling the numerous potholes. The sand which forms the overburden, covering almost the entire peninsula of Florida, has, in Cox's opinion, been blown over from the sea beaches.

The pebbles, when freed from impurities and dried, are of a dark blue colour and are hard and smooth, varying in size from a grain of rice to about 1 in. diam. Their origin is mainly organic, and they are intimately mixed up with the bones and teeth of numerous extinct species of animals, birds, and fish.

The river deposits are said to all proceed from the banks of "drift," situated on the higher lands in Polk county, the pebbles being all of the same size, and differing only in that those of the land are of a lighter colour, and imbedded in a matrix of sand and clay, to which they frequently bear the proportion of about 20 per cent. by weight.

The chemical composition of Florida phosphates and more especially of those known as "hard rock" or "boulder," is irregular and variable. Nor is the physical aspect any more uniform, for while in some regions it is perfectly white, in others it is blue, yellow, or brown. In many instances it is practically free from iron and alumina, but in some districts it is heavily loaded with these commercially objectionable constituents. A large proportion of the land rock is very soft when damp, but becomes perfectly hard when dried.

The following average analyses by Wyatt are presented for the purpose of generally illustrating the composition of Florida phosphates:—

	Phosphate of Lime.	Oxides of Iron and Alumina.	Silica and Silicates.	Carbonic Acid.
	per cent.	per cent.	per cent.	per cent.
Boulders, carefully selected and cleaned (120 samples) }	80·49	2·25	4·20	2·10
Boulders and débris, as mined (237 samples) }	74·90	4·19	9·25	1·90
Soft white phosphate (148 samples)	65·15	9·20	5·47	4·27
Pebble from Peace River, as mark- eted (84 samples) }	61·75	2·90	14·20	3·60
Pebble and drift beds, Polk county, washed and dried (92 samples) .. }	67·25	3·00	10·40	1·70

In mining the hard rock or high-grade boulder deposits, careful selection of the different qualities and accurate sampling and analyses of the different piles before shipment are essential. There is at present no remunerative market in America for the richest grades, and it is therefore probable that for some time to come the major portion will be exported.

Foreign buyers will make no contracts for raw material containing a higher maximum than 3 per cent. of oxides of iron and alumina, and shipments must be made within this limit by miners who would establish a good reputation. This necessitates great experience and perfect harmony between the miners and chemist.

The most rational plan is to first crush the rock to a suitable size as it comes from the mine, say, $1\frac{1}{2}$ in., next to pass it through washers and screens, and finally dry it by hot air, avoiding direct contact with fire. The cost of production under these conditions averages about 5 dols. per ton, delivered on the cars. The actual selling price for Florida phosphates, both "hard rock" and "pebble," in good marketable condition, that is to say with no more than 1 per cent. of moisture and a guaranteed maximum of 3 per cent. of the combined oxides of iron and alumina, is about $4\frac{1}{2}d.$ per unit delivered free on board cars at the mines. The prices paid at the end of 1891, for Florida phosphate delivered f.o.b., were 6 dols. (25s.) a ton for pebble of 60–65 per cent., and 9 dols. (37s. 6d.) for hard rock of 75–80 per cent.

Where the deposits have been denuded or come directly to the surface, it is easy to collect the nodules, and by a slight washing from adhering sand to prepare them for the market. But where the layer

runs deeper, a great quantity of superincumbent earth has to be thrown aside, often as much as 6 ft. in depth. If excavation were not then systematically conducted all profit would be soon absorbed by too much handling of the bulky material. Fortunately the level nature of the country (there is scarcely an elevation of more than 30 ft. in the whole region) allows the easy laying of tramroads into the midst of the fields or woods where mining is done. In open fields this is a regular and simple matter when all other conditions are favourable; but when the rock lies too deep, or not at uniform depths, or is not thick enough, nor rich enough, nor near enough to transportation, the problem becomes more complicated. It costs about 1 dol. (4s. 2d.) a ton to mine. Pits 6 by 12 ft. are dug to the rock, which is then carefully laid aside. The usual price is 25 cents ($12\frac{1}{2}d.$) per vertical foot removed. Transportation and washing cost about 1 dol., and all other expenses of handling, drying, storing, &c., 1 dol. more, making the total cost of rock, clean, dry, and ready for shipment, from 3 to 4 dols. a ton (of 2240 lb.). Good lands yield 500 tons of cleaned rock per acre. The average now mined gives 700 tons, although some spots have turned out 1500 tons per acre.

Where all conditions are favourable, the following regulation system of mining is adopted: A main trunk line leading from the washers (which may be miles away) is laid, dividing the rock field into equal parts on both sides of it. Alternate laterals curve out and run at right angles to the main track as far as the boundaries of the designated field, but conforming to the intermediate ground. The laterals are 600 ft. apart, and the space between any two of them is subdivided by a line ditch parallel to and midway between them. At this ditch two sets of workmen start their lines in opposite directions and at right angles to the laterals. This gives each man a space of 300 ft. long and 12 ft. wide to excavate. Over this path he wheels his "stratum" in barrows to his portion of a platform running at the side of the road. Here his work is sharply scrutinised by a foreman before it is loaded on the cars for the washer. This material furnishes about one-third in weight of clean washed rock. When mining is carried on in wooded land it is difficult to keep the lines straight. Trees are undercut with mattocks and thrown behind upon the high ground, the rock being picked out from between the roots. Dynamite might here be used with advantage. The only tools employed are spades, shovels, and picks.

In undrained territory or old rice fields where the alluvial character of the soil makes deep ditching impossible, steam pumps are employed. Where their use is difficult, or where the water-level is above a quicksand stratum frequently found just upon the rock layer, a struggle ensues between water and workman. The single pit system is then used, each pit being banked against the adjoining one. This method is often employed in marshes which are below the level of tide-water. There is room for improvement in the methods at some mines, where previous thorough drainage would save rock and labour, and allow of operations being carried on in wet and cold weather.

From the mines the rock is carried to the washers in trains of dumping cars holding about $3\frac{1}{2}$ tons each. The washers are always

located near deep streams, if possible, for the sake of easy shipment, and to get an inexhaustible supply of water, and in some cases to allow of the escape of the immense amount of débris carried off in washing. They are raised 20 to 30 ft. above the level of the ground. The cars are hauled up inclines about 100 ft. long, and the contents are gradually dumped into cylindrical breakers armed with replaceable steel teeth. The rock is crushed into pieces about the size of the fist, and falls into half-circular troughs 25 ft. long, resting in frame work set at an incline of 18 in. rise in their length. In each trough is an octagonal shaft, also cased with iron, and set with blades distributed along each face in such a way as to form a screw system with a twist of 1 ft. in 6. These teeth force the rock uphill, while tumbling the fragments about against each other. A heavy stream of water, drawn from the river by steam or centrifugal pumps, pours into the trough and overflows at the higher end near where it enters. On issuing from the water the rock is pushed out upon a screen of $\frac{1}{2}$ -in. mesh. The fine rock is further sized on oscillating wire tables.

The washers are generally in pairs, and each can turn out 40 to 50 tons of clean rock in 10 hours. The loss by abrasion and by clay adhering to the rock varies from 50 to 60 per cent. Much of the débris consists of gravel, but a considerable part of the soft phosphate from the stratum and abraded from the rock is sluiced off. This enormous waste could be prevented by settling tanks, and efforts should be made to save this mud, which may be at least as valuable as the rock itself. The solid portion of the dump is flowed upon adjoining marshes, or is allowed to run directly into the river.

Nearly all the moisture expelled from the phosphate rock by heating (1 to 15 per cent.) is water absorbed in washing. It is very desirable, for obvious reasons, to get rid of it before shipment. About one-half of the rock mined is air-dried. Drying in the open air, however, is uncertain and unsatisfactory, as even the hottest summer weather, owing to the hygroscopic character of the porous rock, will not evaporate all the water, 1 to 4 per cent. remaining, as the surface only of the pile dries out completely. In fact, the rock heap acts like soil, which always contains abundant moisture a few inches below the surface. The advantages of thorough drying are now recognised by both consumer and producer, and all rock is kiln-dried before it leaves the mine works. Burning was sometimes employed, the rock being built up on layers of pine wood, the organic matter of the rock assisting considerably in the combustion. This crude method sintered the porous mass, and was more costly than a drying-shed.

A modern drying plant consists of a Sturtevant blower revolving 2000 times a minute, and drawing air through a wood-burning furnace. The heated products of combustion are carried through a large brick flue 100 ft. long, and pass through regulating dampers to any or all of the drying bins, as may be desired, by means of curved elbow pipes debouching into the perforated cast-iron sectional pipes through which the heated gases are driven.

The following is the method of arranging a drying bin. A bed of rock 18 in. thick is laid on a solid brick floor, intersected at intervals of 10 ft. by open drains, intended to allow the excess of water collected

in washing to flow away before the hot air is applied. Perforated sectional pipe runs from each opening to the branching pipe elbows which are inserted in the flues. Parallel rows of these sectional pipes are laid 2 ft. apart. There are 16 lines of pipe in each drying-house. The rock is dumped from platforms above directly on the levelled pipe, to a height of 10 ft. The sheds are 100 by 400 ft. They contain each about 1300 tons of dried rock, which is never handled again until loaded in vessels directly at the wharf, which touches the sheds.

Powerful "dipper" dredges are used for mining rock in deep water. They differ but little in construction from ordinary harbour dredges. Their lifting capacity is about 100 tons per diem. The rock is picked over to remove marl and oyster shells, and is then cracked and washed in appropriate apparatus.

"Grappler" dredges are preferably employed in Stono River, where the rock is so firmly imbedded as to render the "dipper" dredge of little value. These "grapplers" weigh about 5 tons each, and have 8 claws closed by elliptic steel springs, each with a tension of 14,000 lb., but normally, they are closed with 800 lb. pressure. They surround a central heavy steel drop-chisel for breaking the stratum. There is such an enormous strain on the teeth of this instrument that occasionally they break. An arrangement with replaceable teeth avoids this trouble. The "tube" dredge is of novel construction. It consists of an iron tube 18 in. diam. and 45 ft. long, with a jet arrangement for producing an upward current of water in the tube, supplied by two large expanding low-pressure pumps. These pumps discharge through 4 orifices in the inner surface of the tube, and induce an upward current of about 20 ft. a second, with a lifting capacity of 4 lb. per sq. in.

The "grapplers" are lowered by chains, and it is claimed they can work in 50 ft. of water—an immense advantage over the "dipper," which ceases to be efficient in water over 20 ft. deep.

At the same period, the average cost of winning both these grades and putting them free on board cars at the mines was:—

For the pebble phosphate.. ..	\$2.75 (11s. 5d.) per ton.
For the hard rock „	5.00 (20s. 10d.) „

Exact figures from the books of three of the largest producers of "hard rock," and detailed statements of actual cost from two large pebble-miners, show that 23,000 tons of the former, value 77 per cent., mined, partially washed, dried, and loaded on cars at the mines, including superintendent's and chemist's salary, but without counting interest on capital or allowing for expenses of management, cost 4.23 dol. (17s. 7d.) per ton; and 7000 tons of the latter, average 65 per cent., mined, washed, dried, sifted, and loaded on cars or scows at the mines, including management, but without counting interest on capital invested in lands and in plant, cost 2.80 dol. (8s. 8d.).

The phosphate seams in Hickman County, Tennessee, occur as regular veins underlying a black shale (Chattanooga shale) of Devonian age. They lie almost flat, running in under the shale like a coal seam, but of such colour and texture as to render them easily

distinguishable from coal on inspection, though bearing some superficial resemblance.

The rock is of at least three different colours, and of three different textures:—

1. Blue-black, fine grained, dull looking; filled with rounded nodules, some of them extremely small; shades off into greyish black and sometimes falls to pieces on exposure.

2. Yellowish brown, coarse or fine grained; inclosing a centre of blue-black or greyish black; exterior portion often beautifully stratified, and around the black core is a band of light grey.

3. Light grey; full of impressions of shells, and resembling a piece of air-dried coquina.

The maximum thickness of phosphate rock observed by Dr. W. B. Phillips * was 40 in., black shale above and greyish-blue limestone beneath.

There is a persistent seam of greyish-black, coarse or fine grained phosphate rock underlying the black shale, 12 to 24 in. thick in places carrying 20 to 30 per cent. of phosphoric acid, with 2 to 4 per cent. of alumina, but it cannot be profitably mined, unless it should possibly increase in width under cover.

The black shale above the phosphate is 30 in. to 30 ft. thick, being everywhere capped by what is known as the Harpeth shale, a knarled bluish-grey rock, varying in thickness from 3 or 4 to 200 ft. Between this shale and the black shale there is a persistent stratum of phosphatic nodules, rounded and of the most diverse shapes, but rarely more than 6 in. thick. These nodules are imbedded in a bluish-green matrix and contain 28 to 34 per cent. of phosphoric acid. They would make an excellent material for the manufacture of acidulated phosphate if it were possible to mine them, but it is not.

As to the composition of the rock, Phillips gives some analyses of workable seams, which were sampled by him in person from top to bottom:—

	I.	II.	III.	Top to Bottom of II.				
				12 in.	7 in.	8 in.	6 in.	4 in.
				p. c.	p. c.	p. c.	p. c.	p. c.
Iron oxide ..	3.14	4.96	2.32	0.42	5.94	6.92	6.26	5.26
Phosphoric acid	28.27	29.84	29.81	30.19	26.74	29.26	31.94	31.09
Insol. matter ..	13.24	10.81	6.40	9.80	14.18	13.90	8.64	7.54
Alumina ..	2.71	2.93	4.00	3.00	2.79	7.06	1.74	0.06
Lime	40.50	36.96	43.60	39.50	36.20	29.60	38.20	41.30
Sulphur ..	2.80	..	4.00
Carbonic acid	1.15	..	1.50
Moisture ..	0.50	0.48	0.20	0.60	0.40	0.50	0.60	0.36

Nearly all the samples show a considerable amount of fluorine and all contain sulphur, from the pyrite inclosed. The content of carbonic acid has not exceeded 3 per cent., while the average is about 2 per cent.

* Eng. and Min. Jl.

The presence of pyrite, sometimes in pieces $\frac{1}{2}$ in. across, and distributed irregularly through the phosphatic rock, is characteristic of the black phosphate. It occurs also in the black shale, and the sulphates of iron and alumina resulting from the action of the sulphuric acid (derived by atmospheric oxidation of the pyrite) upon the shale can be seen encrusting the shale at several localities. Several years ago Dr. Phillips made experiments with a crude phosphate containing considerable quantities of iron and alumina, to ascertain if the phosphoric acid could be rendered available, without treatment with sulphuric acid in the ordinary manner. By roasting the finely ground rock with from 3 to 5 per cent. of sulphur a satisfactory yield of "available" phosphate was obtained. There is no doubt but that this method could be applied to a sulphurous phosphate, if at any time the alumina should become objectionable. As long, however, as it keeps below 4 per cent. it will not seriously interfere with the treatment of the rock in the usual way.

Canada produces large quantities of a phosphatic mineral called "apatite," which is derived from veins in the primitive rocks. It is remarkable for containing calcium chloride and much fluoride, but no carbonate. The phosphate-bearing district is not extensive. Taking the city of Ottawa as a base, a glance at the map will show a section of country north of that point, lying between two large tributaries of the Ottawa river, which flow southward through the Laurentian Hills, named respectively the Gatineau and the Lievre. This section, with a belt of 4 or 5 miles in width east and west of each of these rivers, is the true phosphate country; beyond this the mineral is apparently wanting, and here it is where mining is carried on.

The rocks of the mountain range that traverses this district are composed of pyroxene, representing the so-called "spotted gabbro" of Norway, intermixed with quartzite, orthoclase, mica, gneiss, and crystalline limestone. The phosphate itself varies much, according to locality. It is found in crystals sometimes of large dimensions; in masses, varying from compact to coarse granular; in strata of a lamellar texture, and in a friable form. The latter is very abundant, and is known as "sugar phosphate," often so decomposed as to take the appearance of pure sand, soft enough to be dug out. The colours of the phosphate are very varied, consisting of green of different shades, blue, red, and brown of all shades, yellow, white, and cream coloured. Occasionally beautiful crystals are met with, large and perfect at both ends, and enveloped in calc spar, or occasionally a drusy cavity is struck, known in miners' parlance as a "vug," containing sometimes one large or a number of small independent crystals shooting from the sides, or standing erect in the cavity. In one of the mines on the Lievre, crystals of a gigantic size have been met with, some weighing individually as much as 1000 lb.

Professor Harrington, of the Geological Survey staff, says as a rule the apatite-bearing veins of the Ottawa region are characterised rather by a want of regularity or order in the arrangement of their constituents than by any degree of symmetry. Veins with sharply defined walls, as in metalliferous lodes, are rarely seen, the vein and country rock merging into each other. Dana says such a blending of

a vein with the walls is a natural result when its formation in a fissure takes place at a high temperature during the crystallisation of the containing rock. Dr. Sterry Hunt, who has made Laurentian rocks his study for upward of 30 years, regards many of the apatite veins as fissures or cavities which have been filled by the deposition of materials derived from the adjacent strata. One striking feature developed in this mining is the great irregularity of the deposits; but taking into consideration the extremely disturbed character of the Laurentian rocks, this is not to be wondered at.

At the North Star Mine, with a view to testing the depth of the deposits, a test shaft was sunk where the vein on the surface was not more than 3 or 4 in. wide; the shaft was proceeded with till, at a depth of 30 ft., the vein increased to a width of 2 ft., ranging after that from 1 to 4 ft. till a depth of 80 ft. was attained. Here the phosphate almost disappeared, but at a depth of 120 ft. a vein 1 ft. wide was reached, which gradually kept on increasing. At a depth of 165 ft. a body of phosphate was penetrated occupying the whole width of the shaft. Sinking was still continued, and now, at a depth of 266 ft., the entire floor and sides are pure phosphate, and a drift run for some distance at the 200 ft. level shows solid ore.

In addition to the yield of pure phosphate in large masses, it occasionally happens that large quantities of it are mixed with mica, pyroxene, and other foreign substances, and if shipped in that state the value of the whole cargo would be materially deteriorated. To get rid of this extraneous matter a process known as "cobbing" is resorted to, which consists in the separation by hammers of the ore from its matrix, an easy operation, owing to the more friable condition and softness of the phosphate as compared with the intrusive materials. This is done in a hut or cobbing-house, on solid tables or stands. On one side of the building are tramcars or wagons, into which the refuse is thrown as broken off, while the phosphate thus cleaned is thrown into another receptacle on the other side. Boys and old men are employed at this work, which no machinery has yet been found adapted to perform. In spite of every care used, large quantities of phosphate are thrown aside at present which, with an improved system, may yet prove of value.

The composition of Canadian phosphate varies as follows:—

	Per cent.
Phosphoric acid	30·84 to 41·54
Lime	42·72 „ 54·74
Alumina and iron oxides and fluorine..	3·03 „ 13·32
Insoluble silicious matter	·59 „ 13·50
Tribasic phosphate of lime	67·32 „ 90·68

Competition between South Carolina and Florida low-grade phosphate has practically killed Canadian seconds, and the only market now left open for the 70 per cent. grade is in Chicago and the Western States. A sale of 1000 tons for Chicago was recently made at 6·50 dol. per ton for ground 65 per cent. in bags, free on board at Buckingham, P. Q.

The cost of production of Canadian phosphate is estimated at about

12 dol. per ton of 2240 lb., free on board ship at Montreal. The selling prices in 1892 ranged from 13 to 14.50 dol. per ton.

Norwegian apatite differs from Canadian in containing no calcium fluoride. Sometimes the calcium chloride exceeds 4 per cent.

From apatites alone it is difficult to make a dry and powdery superphosphate, but by mixing them with lower grade phosphatic minerals carrying lime carbonate a good result is attained.

Phosphatic guanos from the West Indies and other islands are less abundant now than formerly.

Sombrero rock or crust guano was at one time largely imported into England. It is quarried on Sombrero, an islet about $2\frac{1}{2}$ miles long, $\frac{3}{4}$ mile wide, and not more than 20 or 30 ft. above the level of the sea; it is entirely composed of this phosphatic substance. Fragments of bones are found in the rock, and it is supposed to be a breccia of bones of turtles and other marine vertebrata, coral débris, &c., collected before the elevation of the islet above the water, and cemented together since by the droppings of birds carried down through the mass by rains. It varies in colour and texture, some being porous and friable, whilst other specimens are dense and compact. Later importations contained less iron and alumina and more lime carbonate than formerly, and from this it is inferred that the rock (then worked from under the sea) is mined in close proximity to the coral rock on which it rests. Analyses of Sombrero guano show:—

	Per cent.
Triphosphate of lime	69 to 76
Carbonate of lime	2 „ 16
Iron and alumina	4 „ 10
Fluoride of calcium	1½ „ 1¾
Insoluble matter	1 „ 2

When Sombrero guano is dissolved by itself, it makes a high grade superphosphate of a light yellow colour.

Navassa guano, from the coral island of that name in the Caribbean Sea, is of a reddish-brown colour, and consists of globular grains of phosphate of lime, cemented into hard masses, and contaminated with a good deal of iron and alumina. It is found chiefly in the cavities of the rocks which form the framework of the island. It contains:—

	Per cent.
Triphosphate of lime	55 to 70
Carbonate of lime	4 „ 6
Oxides of iron and alumina	15 „ 18
Iron and alumina (as phosphates)	8 „ 10
Fluoride of calcium	1 „ 2
Insoluble matter	4 „ 5

Superphosphate of lime, when made from Navassa alone, is exceedingly hard and tough, and proportionately low in strength.

Curaçoa and Malden Islands both furnish guanos in which the phosphate of lime is in an unmineralised state, and in a fine state of division; they contain but little carbonate of lime, and are almost free from oxide of iron, alumina, and siliceous matter. They range in quality from 65 to 80 per cent. of tribasic phosphate of lime, the

average being about 70 per cent. The lower qualities are, however, almost as valuable proportionately as the higher, in consequence of there being no oxide of iron, &c., to deteriorate the product, as in the case of most of the inferior phosphates, and they are capable of yielding superphosphates of high quality.

Numerous other phosphatic deposits deserve mention.

The Aves Islands, off the coast of Venezuela, contain immense beds of guano, affording over 33 per cent. phosphoric acid.

Coprolite beds at Santa Maria di Leuca, Southern Italy, afford 35 per cent. of calcium phosphate.

Rata Islands (Brazil) phosphates yield:—

	Per cent.
Phosphoric acid	26 to 33
Lime	26 „ 37
Iron oxide	7 „ 10
Alumina	9 „ 12

In the Gellivara district of Northern Sweden apatite is found intimately associated with magnetic iron ore, in proportions varying from 10 to 60 per cent., but its separation is a difficult problem.

Near Taplow, two bands of phosphatic chalk have recently been found overlying ordinary white flintless chalk. The proportion of phosphate of lime present varies between 18 and 35 per cent.

Tunis and Algeria are reported as containing an enormous deposit of phosphatic mineral lying in Eocene limestone beds, and estimated to have 10,000,000 tons of 60 per cent. phosphate in sight. This phosphate contains less than 1 per cent. of iron and alumina, and very little silica.

The yearly consumption of phosphatic minerals in the manufacture of artificial fertilisers is computed at $1\frac{1}{2}$ to 2 million tons.

PIGMENTS.

THE term "pigments" properly includes all colouring matters used for the preparation of paint, but in this instance it is restricted to those which are derived naturally from the mineral kingdom. They are few in number, but important on the score of abundance, cheapness, and permanency.

Barytes.—Barytes or sulphate of baryta, the most important of the salts of barium, is found native in large quantities, forming the species of mineral termed barites or barytes, and commonly known as heavy-spar, on account of its weight (sp. gr. from 4·3 to 4·7). It is found in Derbyshire and Shropshire, and often occurs in fine tabular crystals. The massive variety found in the mountain limestone of the above counties is sometimes called "cawk"; it is more frequently found in white or reddish-white masses. In Saxony it occurs as the mineral *stangen-spath*, in a columnar form; and at Bologna a nodular variety is found, called Bologna stone, which is notable for its phosphorescent powers when heated.

The pure pigment is a heavy white powder, insoluble in water and nearly insoluble in all other menstrua. It is prepared by heating the native mineral, grinding it to powder, and well washing it, first in dilute sulphuric acid, in order to remove any traces of iron, and afterwards in water. It is then levigated or "floated," the lightest particles being the most valuable, and known as "floats"; the white powder is afterwards thoroughly dried. This process is employed at several works in the neighbourhood of Matlock Bath, in Derbyshire, but much larger quantities could be produced in different parts of the country if the demand for the article rendered its production more profitable. The principal use of sulphate of baryta is to adulterate white lead, and to form the pigment known as *blanc fixe*, or permanent white. For these purposes the native mineral, ground and washed as described above, is commonly employed. The annual production in the United Kingdom is 25,000 to 30,000 tons, valued at about 24s. a ton.

Improvements in machinery and in the process of treating natural barytes have overcome many of the objections which formerly existed to its utilisation, and considerable attention is now being given to the localities in the United States where it is found. The mineral, in order to be available for the uses to which it is put, must be fairly free from quartz grains, the stain of iron rust, and other impurities. If the barytes is stained to any extent, it is practically valueless, as a good white colour is essential to its usefulness. Quartz grains or other hard substances with which it is apt to be associated, injure the machinery in grinding. The purest barytes so far produced in America comes from Missouri (where it is called "tiff"), though a very fair grade is now being mined in considerable quantities in

Virginia. The yearly output in the United States is about 30,000 to 35,000 tons, valued at 21s. a ton in the crude state, and $\frac{1}{2}d.$ to $\frac{3}{4}d.$ a lb. when prepared.

Magnesite (see p. 329) being white, very heavy, opaque, and harmless, composed almost entirely of magnesia carbonate, is becoming a very important pigment as a rival to barytes.

Ochres.—The large class of mineral pigments known collectively as ochres or sienna earths possess considerable importance, notably on account of their remarkable durability and their reasonable price. They all consist essentially of an earthy base coloured by oxide of iron or of manganese, or of both. Some authorities differentiate between ochres and siennas, and ascribe the latter name only to those earths which contain manganese, but this seems to be an arbitrary proceeding, because the term sienna, or more properly Siena, is derived solely from the name of the Italian province in which these minerals are worked. They are of widespread occurrence, both geographically and geologically, and the methods of mining and preparing them are not subject to much variation.

They are chiefly found in large quantities in the communes of Castel del Piano and Arcidosso. The yellow earths and bole found on the western slopes of Monte Amiata are true lacustrine deposits found amid the trachytic rocks, of which it is principally composed. They lie under, and are entirely covered by, the vegetable soil. Varying in compactness and colour, they are termed yellow earths when of a clear ochreous tint, and *terra bolare*, or bole, when of a dark chestnut colour. Each deposit consists for the greater part of yellow earth, beneath which bole is found in strata or small veins. The mineral being very friable, its excavation is easy, and is generally conducted in open pits.

The different qualities are separated during the process, the bole, which has the higher commercial value, being the more carefully treated. After the first separation the bole is further classed into first, second, third, and intermediate qualities—*boletta*, *fascia*, *cerchione*, &c. Its most important characteristic is termed, in commercial language, *punto di colore*, or tint. The value of the bole rises as its tint deepens. Thus bole of the third quality is lighter than that of the second, and the second than that of the first. After the third quality comes the *terra guilla*. The yellow earths, after excavation, are exposed to the open air for about a year, by the pit side, without classification. The bole, on the contrary, is placed in well-ventilated storehouses to dry for about 6 months. This diversity of treatment is owing to the fact that exposure to the elements brightens the colour of the yellow earths, and raises their value, while it would damage the bole by turning its darker tint first into an orange yellow, and, if continued, into an ordinary yellow earth. It also loses in compactness and crumbles up under exposure.

In addition to the *punto di colore*, the size of the pieces influences the commercial value of the bole, which increases with their volume. Thus the classification is *bolo pezzo*, *bolo grapolino*, and *bolo polvere*. The yellow earths are classed as *giallo in pezzo*, *giallo commune*, and *giallo impalpabile*, the impalpable being worth more than the common

yellow. The production of the Siena earths is estimated at about 600 tons per annum, of which amount about 50 tons are calcined, and the rest sold in the natural condition. The value of the trade is estimated at from 4000*l.* to 6000*l.*

The European trade in these earths is very large. Rouen exports some 5000 tons yearly, and Havre about 1500 tons.

Similar deposits occur in America, where they are known as "paint-beds," and the earths are called "metallic paints." A prominent example is the paint-bed at Lehigh Gap, Carbon County, Pennsylvania, which was originally opened as an ironstone mine. The mineral proved valueless metallurgically, but remarkably useful as a pigment, since it contains about 28 per cent. of hydraulic cement, which hastens the drying and causes the paint to set without any addition of artificial dryers, thereby making it eminently fitted for all outdoor application.

Along the outcrop of the paint, the beds are covered by a cap or overburden of clay, and by the decomposed lower portion of the Marcellus slate, which is 50 ft. thick at the Rutherford shaft.

Beginning with the Marcellus slate, the measures occur in the following descending order:—

a. Hydraulic cement (probably Upper Helderberg), very hard and compact.

b. Blue clay, about 6 in. thick.

c. Paint-ore, varying from 6 in. to 6 ft. in thickness.

d. Yellow clay, 6 ft. thick.

e. Oriskany sandstone, forming the crest and southern side of the ridge.

East of the Rutherford shaft the sandstone forms the top-rock of the bed. This is due to an overthrow occurring between the Rutherford tunnel and shaft.

The paint-bed is not continuous throughout its extent. It is faulted at several places; sometimes it is pinched out to a few inches and again increases in width to 6 ft. A short distance south of Bowman's there is a fault striking north-east in the Marcellus slate, which has produced a throw of about 200 ft. The measures dip from 10° to 90°. The dip at the Rutherford shaft is about 79° south, whereas at the tunnel it is 45° north. The ore is bluish-grey, resembling limestone, and is very hard and compact. The bed is of a lighter tint, however, in the upper than in the lower part, and this is probably due to its containing more hydraulic cement in the upper strata. The paint-ore contains partings of clay and slate at various places.

At the Rutherford shaft there are fine bands of ore, alternating with clay and slate, as follows—Sandstone (hanging-wall), clay, ore, slate, ore, clay, ore, clay, ore, slate, ore, cement, slate (foot-wall). These partings, however, are not continuous, but pinch out, leaving the ore without the admixture of clay and slate. Near the outcrop the bed becomes brown hematite, due to the leaching out of the lime and to complete oxidation. Occasionally, streaks of hematite are interleaved with the paint-ore. In driving up the breasts, towards the outcrop, the ore is found at the top in rounded, partially oxidised and weath-

ered masses, called "bombshells," covered with iron oxide and surrounded by a bluish clay. In large pieces the ore shows a decided cleavage.

The method used in mining is a variation of panel-work. Nearly the same system of working is employed by all of the companies who have developed their mines either by means of tunnels or shafts. Tunnels are preferred whenever equally convenient, because they involve no expenses for pumping and hoisting machinery, fuel, repairs to machinery, &c.

The following description of the operation of the Rutherford mines is typical of all the workings in the vicinity.

The Rutherford tunnel is 6 ft. high and 600 ft. long. The gangways are driven along the foot-wall of the cement side, 6 ft. high, and are heavily timbered and lagged at the top and on the clay side. The sets of timbers are $3\frac{1}{2}$ ft. apart, and usually of 9-in. timber. The width at the top is $3\frac{1}{2}$ ft., with a spread of 5 ft. at the bottom, the extra width being cut from the clay. Where the cement-rock is firm, the collar is hitched 6 in. into it and supported by a leg on the clay side. The cost of the timber is 54 cents (2s. 3d.) per set, including the lagging. The monkey gangway, which carries the air along the top of the breast from the air-shaft, is $2\frac{1}{2}$ ft. high, $1\frac{1}{2}$ ft. wide at the top, with a spread of $2\frac{1}{2}$ ft. at the bottom. Wooden rails with a gauge of 18 in. are spiked to the cross-ties.

The gangway is not driven continuously, but after being driven about 55 ft. on either side of the shaft, the breasts are started 25 ft. from the shaft, a pillar being left to protect it. The breast is then opened up to the face of the gangway, and when one ore-breast is worked out, the gangway is driven ahead about 30 ft., and a new breast is opened and worked out before commencing a third. The air-hole is first driven to the surface, then the breast is opened to its full width of 6 ft. The thickness of the bed of ore here varies from 4 to 6 ft. depending upon the thickness of the partings of clay and slate. The clay and slate are left on the bottom, which is made sloping to allow the ore to roll down to the shute; this is 6 ft. wide and 4 ft. long and heavily timbered. Small props or sprags are hitched into the cement, and wedged with a lid on the clay side to prevent falls of rock.

The holes are drilled by hand in the clay-partings. They vary in depth from 1 to 4 ft., and the charge of dynamite is varied correspondingly, according to the amount of ore it is desired to throw down. The loose ore is wedged down with crowbars and picks, and is then freed from any adhering clay and thrown down the shute. It is there loaded into boxes holding about $\frac{1}{2}$ ton each, which are pushed to the shaft on a truck. The ore-boxes have 4 rings at the corners, to which are attached 4 chains, suspended from the wire hoisting-rope. At the top of the shaft the boxes are detached and placed on a truck, which is run to the dump; 30 cars, averaging 15 tons, are extracted in a day of two shifts, the day-shift working 9 hours and the night-shift 11. The pay of the miners is 5s. per shift. The cost of mining the ore averages 7s. per ton.

The ore, as it comes from the mines, is free from refuse, great care having been taken to separate slate and clay from it in the working

places. It is hauled in 2-ton wagons to kilns, which are situated on a hill-side for convenience in charging. The platform upon which the ore is dumped is built from the top of the kiln to the side of the hill. The ore is first spalled to fist-size and freed from slate, and is then carried in buggies to the charging-hole of the kiln.

The slate, when burned, has a light yellowish tint, which would change the colour of the product. Figs. 90 to 92 represent a front elevation of the kiln, and two sections at right angles to each other. The kiln is 22 ft. high and 16 ft. square on the outside. The interior is cylindrical, 5 ft. diam., with a firebrick lining *a* of the best quality. The interior lining slopes from the fireplace *b* to the door *c*, by which the charges are withdrawn; this facilitates the removal of the calcined ore. The casing *d* is of sandstone, 5½ ft. thick, and tied together with the best white-oak timber *e*. When charged, a kiln holds 16 tons of ore, and the kiln is kept constantly full. The heat passes from the fireplaces *b*—of which there are two, placed diametrically

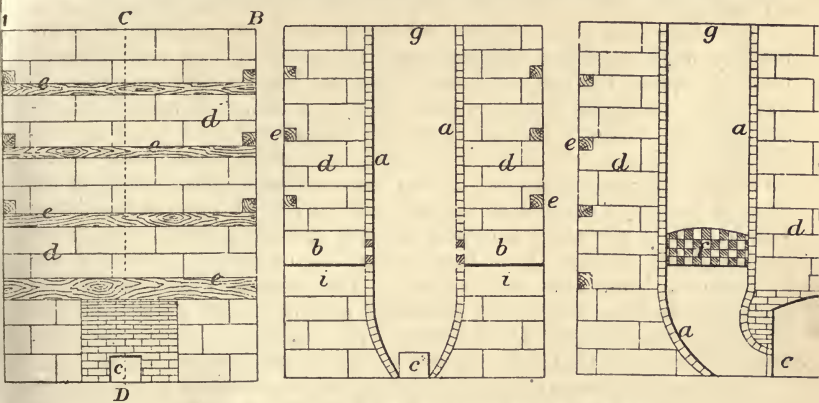

FIGS. 90, 91, 92.—KILN FOR BURNING PAINT ORE.

opposite each other—through a checker-work *f* of brick into the centre of the charge. The charge enters at *g* and is withdrawn by a door *c* in the front wall, 2 ft. long and 18 in. high. The ashpit is at *i*. The fire is kept at a cherry-red heat, and about 1 cord of wood is burned every 24 hours.

The kiln works continuously, calcined ore being withdrawn and fresh charges made without interruption. The ore is subjected for 48 hours to the heat, which expels the moisture, sulphur, and carbon dioxide. About 1½ tons of calcined ore are withdrawn every 3 hours during the day. The outside of the lumps of calcined ore has a light brown colour, while the interior shows upon fracture a darker brown. Great care is necessary to regulate the heat so that the ore is not over burned. When this happens, the product has a black scoriaceous appearance, and is unfit for the manufacture of paint, being extremely hard to grind.

The calcined ore is carried from the kiln in wagons to the mill, where it is broken to the size of grains of corn in a rotating crusher.

The broken ore is carried by elevators to the stock-bins at the top of the building, and thence by shutes to the hoppers of the mills, which grind it to the necessary degree of fineness. Elevators again carry it to the packing-machine by a spout, and it is packed into barrels holding 500, 300, or 100 lb. each.

Ochres owe their colour to hydrated oxide of iron, besides which body they contain clayey matter (silicate of alumina), earthy matters, barytes, carbonate and sulphate of calcium, &c., dependent upon the locality from whence they are obtained; thus Derbyshire ochres contain mostly calcareous earthy matters, barytes, gypsum, &c., while Oxford ochres and French ochres contain clayey matter; Welsh ochres are variable, and usually contain a good deal of silicious matter.

The annual production of ochres (and umbers) in the United Kingdom reaches 10,000 to 20,000 tons, with a value of about 40s. a ton.

The yearly output of ochres (and metallic paints) in the United States is about 40,000 tons, having an estimated value of about 50s. a ton.

Smalts.—This pigment has not maintained its position in competition with artificial ultramarine. Formerly it was very largely used to correct the yellow tone of cottons, papers, and pottery. It has a pale violet-blue tint, which, however, is not constant in artificial light. Being a silicate it is very permanent, and proof against the action of acids, alkalies, and sunlight, besides being inert when mixed with other pigments. It can be used with either water or oil as a medium, but is not a successful paint owing to its weak colouring power. It is virtually a double silicate of cobalt and potash, or a cobalt glass, containing a few impurities, of which the chief are aluminium, iron, and lead oxides. The colour varies somewhat according as these impurities fluctuate, and the finest ground sample is always the palest. It is hardly ever adulterated, and the chief point to secure is that it be ground to the finest possible degree.

Its manufacture is most extensively and successfully carried on in Saxony. The raw materials used are cobalt speiss (an arsenide of cobalt and iron), potash, and sand. The ore is broken up into convenient sized pieces and roasted at red heat in a reverberatory furnace provided with a tall shaft for discharging the sulphurous and arsenical fumes at a high altitude. When the evolution of these fumes has ceased, and the mass begins to assume a pasty consistence, the roasted ore is removed from the furnace, cooled, reduced to a fine pulverulent condition (then known as "zaffre") and passed through a silken sieve. Should it be necessary, the cobalt ore is first spalled and hand-picked to remove the ores of foreign metals which are associated with it; and then reduced to a very fine state in an edge-runner or mortar mill, and freed from earthy impurities by washing. The concentrated ore is then dried and dead-roasted in small charges at a time (about 4 cwt.) in a specially designed reverberatory furnace such as shown in Fig. 93, of which *a* is the hearth on which the ore is spread; *b*, the fireplace, the products of combustion from which pass over the ore on the hearth, and thence into the flues *c*, which repeatedly circle round the furnace so as to provide abundant opportunity for the arsenious oxide derived from the combustion (oxidation) of the arsenic in the

ore to condense; this highly poisonous arsenious oxide is collected in a solid form from the flues at convenient intervals by means of the doors *d*. The ore is charged and discharged at the door *e*. The roasting should not be carried to such a point that the whole of the sulphur and arsenic are removed when making smalts, as by leaving a portion of these substances in the ore at this stage the ultimate purification is better accomplished.

The next stage is to fuse the roasted ore with potash and silica so as to form a blue glass. The proportions in which the ingredients are mixed depend upon the depth of colour in the zaffre operated upon and the tint desired in the finished smalts; hence it is always determined by a preliminary experiment, and is then most carefully adhered to, each material being accurately weighed out. Only the best potash can be used, as it must be quite free from soda, and iron

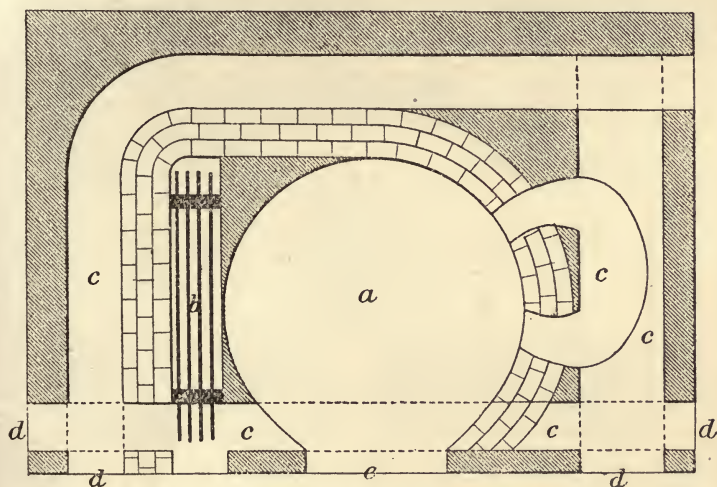

FIG. 93.—KILN FOR ROASTING COBALT ORE.

or other metal; the effect of soda is to render the blue greenish tinted. Quartz affords the requisite silica, and is hand-picked to ensure freedom from alumina, iron, and lime, which import dulness into the colour, and then ground to a fine powder in an edge runner mill. The duly weighed quantities of the several ingredients are intimately mixed in wooden or cement-lined vessels, so as to preclude the possibility of any metallic iron finding its way in; and as a further protection against this risk a little white arsenic is often added so that the iron may be carried down in the regulus which is formed during the fusion in the crucible.

These crucibles are of refractory earthenware quite free from lime, and measure about 18 in. across at top, gradually diminishing to 14 in. at bottom, so that an ordinary charge is about $\frac{3}{4}$ cwt. They are placed in rows in a furnace which generally bears a close resemblance to a glass furnace, the operation being very similar. The

form of furnace common in Saxony, where most of the smalts is made, is shown in Fig. 94. By means of a series of openings *a* in the walls of the furnace, the pots *b* are introduced on to the hearth of the furnace, whereupon the openings *a* are bricked up again and remain closed during the operation. The ingredients are charged into the pots *b* by means of long iron ladles which are introduced through the small square apertures *c*, which can be temporarily closed by a half-brick or other simple article. The fire is then lit in the fireplace *d*, and the products of combustion circulate around the pots *b*, and finally escape at the orifices *e* at the top of the furnace into flues leading to the chimney *f*. After about 8 hours' firing fusion commences in the pots, whereupon the contents are thoroughly stirred by rods inserted through the working holes *c*. The temperature is then increased till a white heat is attained, this being necessary for the formation of a

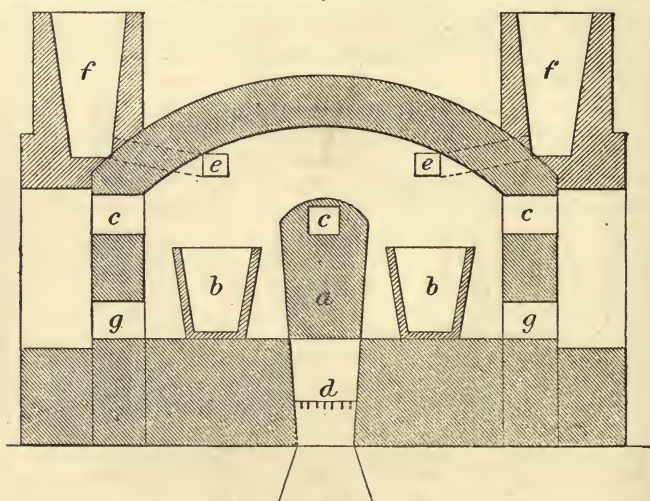

FIG. 94.—KILN FOR MAKING SMALTS.

glass. The fused mass is repeatedly sampled, and when it has become quite homogeneous, and the regulus or speiss containing the iron, antimony, bismuth, arsenic, copper, nickel, sulphur, and other impurities has completely separated itself and collected at the bottom of the pots, the blue glass is ladled out and dropped at once into cold water, by which it is disintegrated and rendered very brittle, ready for the subsequent grinding. The regulus is then drawn off from the pots through holes provided for the purpose, and removed by the orifices *g*, after which the pots are ready for another charge. They ordinarily remain serviceable for about 6 months.

The grinding needs to be done with great thoroughness, and is accomplished partly by stamps and partly by edge-runner mills in the presence of water. The particles as reduced are floated off by the water to a series of settling tanks communicating one with another. The portion which settles in the first of the series is too coarse for

use, and is returned to the edge-runner for further grinding; while the portion in the last of the series possesses such a weak colour that it is rejected, or put into the crucible to undergo a second fusion. The selected portions are dried ready for the consumer.

Umbers.—These form a large class of natural earths of a brown colour, differing widely in the proportions of their chief constituents, but closely allied to the ochres and siennas in general composition, and owing their colour mainly to the presence of hydrated oxides of iron and manganese, the latter prevailing in the umbers to a greater degree than in the ochres and siennas (see p. 314).

Beds or veins of umber of varying thickness and extent are found in many places, especially in connection with magnesian limestone (dolomite). Apparently they are often derived from decomposition of this rock, perhaps due to the infiltration of carbonated water, which has acted upon the calcium and magnesium carbonates in the dolomite, and left the silica and the iron and manganese as oxides, forming the bulk of the umber. Usually these beds of umber are near the surface, though covered by an overburden of vegetable soil, and the operation of working them may be called quarrying rather than mining, being of a superficial and simple character, often only amounting to small pits.

As no umber is a definite body, but rather a mixture of various substances, so the composition of every kind is peculiar to itself, and very wide differences are noticeable. Even the same bed will not necessarily produce always the same class of umber. The following figures show the extent to which the proportions of the several ingredients may vary:—

	Per cent.
Water given off at 212° F.	4 to 65
Water in combination	5 „ 11½
Silica	4½ „ 29½
Manganese dioxide	7 „ 27
Ferric oxide	6 „ 36

Calcium carbonate is sometimes present to the extent of 2½ to 6 per cent., and at other times is quite absent, its place being taken by ½ to 1 per cent. of lime (calcium oxide); some of the English umbers contain about 2 per cent. of calcium sulphate (gypsum) in addition to the carbonate. Alumina may occur to the amount of 2½ to 12½ per cent., or may be wanting altogether. In a sample of Derbyshire umber analysed by Hurst there appears to have been over 30 per cent. of barium sulphate (barytes), which looks suspiciously like adulteration.

Almost every variety of shade may be found in umbers. The darkest and richest in colour—a warm violet-brown—is the so-called Turkey umber, mined in Cyprus, and formerly shipped viâ Constantinople; this is of very fine quality and commands the higher price in the market. A reddish-brown Irish umber, known as Cappagh brown, obtained from the Cappagh mines in Cork county, is much esteemed among artists, both for water-colour and oil painting, and especially for the latter when it has been subjected to a preliminary desiccation at a temperature of about 170° F. Heated to the boiling

point its colour changes to a rich red, resembling burnt sienna. Cornish umbers are of fairly good quality. Derbyshire umbers are poor, and incline to a reddish tint, besides being gritty. Sometimes they are adulterated with a little lampblack, which renders the tone more like that of Turkey umber, and thus deceives the unwary buyer.

There are three conditions in which umbers come into commerce: (1) as raw lump, being the mineral just as it is mined; (2) as raw powdered, when it has been ground very fine and levigated or washed in flowing water, whereby the particles get assorted according to their several degrees of fineness; and (3) as burnt, being the powder after it has been subjected to calcination in a closed furnace. Some umbers are so soft that they can be washed without any previous grinding, but this is not generally the case. The calcination is conducted at a red heat, and by this process the tint is made darker and warmer, but it must not be pushed too far or the pigment will blacken.

While different samples of umber present differences of tone and shade, from a yellowish to a violet brown, they are alike in being very durable and proof against the injurious influences of air, light, and impure atmospheres; ordinary acids and caustic soda have no appreciable effect. They mix well with other pigments without provoking any change, and are equally satisfactory as oil or water colours. They do not admit of much adulteration, except in the substitution of an inferior grade for a superior one, and possibly the addition of barytes as a make-weight.

POTASH.

THE extensive deposits of potash salts at and near Stassfurth, Prussia, which during the last 20 years have created an important industry, were encountered in prosecuting the search for salt, and were long regarded as a hindrance and incumbrance to the development of the rock-salt workings which they overlie. The deposits occur in the Bunter sandstone (Triassic) series, and are illustrated in section in a paper by my friend Mr. C. Napier Hake,* who was for some years connected with the industry.

On referring to the section, it will be seen that rock-salt occupies the lowest stratum. The black diagonal lines which are drawn across the rock-salt region represent thin layers of calcium sulphate (gypsum) 7 mm. thick and almost equi-distant. At the top of the rock-salt and associated with its uppermost portions are thin strata of polyhallite (trisulphate of potash, magnesia, and lime), followed immediately by an accumulation of kieserite (magnesia sulphate), and this again in ascending order by a zone of carnallite (double chloride of potash and magnesia) mixed with some magnesia sulphate and rock-salt. Towards the higher portions of the now inclined strata, this carnallite bed gives place to kainite (double sulphate of potash and magnesia combined with one equivalent of magnesia chloride and intermingled with 40 per cent. of common salt), a secondary product resulting from the action of a limited quantity of water on the carnallite layer. The upper bed of rock-salt, resting on a thick bank of anhydrite, is also a later formation. Almost imperceptible layers of polyhallite are present in this deposit, at greater intervals than those occurring in the lower rock-salt beds; thus it has probably originated from the action of water on the older deposit. Though of comparatively limited extent, the upper salt beds are the more esteemed, as their product is much purer, averaging about 98 per cent. sodium chloride.

The primary minerals afforded by these deposits are seven, viz. rock-salt, anhydrite, polyhallite (K_2SO_4 , $MgSO_4$, $2CaSO_4$, $2H_2O$), kieserite ($MgSO_4$, H_2O), carnallite (KCl , $MgCl_2$, $6H_2O$), boracite ($2Mg_3B_8O_{15}$, $MgCl_2$), and douglasite ($2KCl$, $FeCl_2$, $2H_2O$); added to which are nine secondary minerals resulting from their decomposition, viz. kainite (K_2SO_4 , $MgSO_4$, $MgCl_2$, $6H_2O$), sylvin (KCl), tachydrite ($CaCl_2$, $2MgCl_2$, $12H_2O$), bischofite ($MgCl_2$, $6H_2O$), krugite (K_2SO_4 , $MgSO_4$, $4CaSO_4$, $2H_2O$), reichardite ($MgSO_4$, $7H_2O$), glauberite ($CaSO_4$, Na_2SO_4), schönite (K_2SO_4 , $MgSO_4$, $6H_2O$), and astrakanite ($MgSO_4$, $4H_2O$); but, besides the salt, only three of the

* "Stassfurt Salts and their Mode of Treatment," Jour. Soc. Chem. Ind., ii. 146.

minerals possess industrial importance, viz. the carnallite, kainite, and kieserite.

The carnallite region, which contains a variety of minerals, has chiefly contributed to the fame of these beds. It has an average thickness of about 80 ft., and consists essentially of 60 per cent. carnallite, 20 rock-salt, 16 kieserite, and 4 tachydrate, besides small quantities of magnesium bromide; the several minerals alternating with each other in regular succession, in layers $\frac{1}{4}$ in. to 3 ft. thick. The predominating carnallite contains 26.76 per cent. potassium chloride, 34.5 magnesium chloride, and 38.74 water; when pure it is colourless and transparent, sp. gr. 1.618; it is very hygroscopic and readily soluble in water ($64\frac{1}{2}$ parts in 100).

The kainite region, though less extensive than the others, is yet of vast dimensions. The average composition of the deposit is 34.8 per cent. sodium chloride, 23 potassium sulphate, 15.6 magnesium sulphate, 13.6 water, and 13 magnesium chloride; in the pure state it is colourless and almost transparent, sp. gr. 2.13; it is soluble in water ($79\frac{1}{2}$ parts in 100).

The kieserite region embraces a thickness of about 180 ft., and consists chiefly of 66 per cent. rock-salt, 17 kieserite, 13 carnallite, 3 tachydrate, and 2 anhydrite; when pure kieserite is amorphous and translucent, sp. gr. 2.517, and contains 87 per cent. magnesium sulphate and 13 water; it is slowly soluble in water (41 parts in 100) at 64° F.

The entire accumulations of these Stassfurth beds are supposed to have resulted from evaporation of an inland sea, communicating with the ocean. Concentration would have followed evaporation till the several points of saturation were reached, when each salt in turn would begin to separate. The deposit must originally have been basin-shaped, but has been lifted in the centre by subsequent folding, and the cavity thus created in the crest of the anticlinal has been filled by later deposits of Oolitic limestone. The minerals are won by a system of shafts and drifts, the latter taking the form of huge chambers with large pillars left between them. In a distance of 10 miles along the line of fault there are over a dozen shafts, and the dip of the beds varies from 40° to nearly vertical. A considerable quantity of the salts are sold as mined for agricultural purposes, but an extensive industry has locally grown up in connection with their purification, chiefly by solution and re-crystallisation, as described in detail by Hake. The production of kainite is about 600,000 metric tons, value 400,000*l.*, and of other potash salts 800,000–900,000 tons, value 500,000*l.* yearly.

PUMICE.

WHILE many active volcanoes eject greater or lesser quantities of pumice, these do not afford any appreciable proportion of the commercial supplies of that mineral. Nearly the whole European consumption is derived from the island of Lipari. It is found chiefly in the northern parts of the island, on the slopes of the mountains called Punta della Castagna, Monte Pelato, and Monte Chirica, which appear to have formed part of a great crater, formed of inclined layers of stones and ashes from volcanic eruptions. The stratum containing the pumice is covered with a layer of stones, in some cases reaching 120 ft. thick, and being of a light grey colour, gives a singular aspect to the landscape. These deposits are usually worked by an inclined gallery driven in the hill-side at right angles to the dip; from the bottom of this, a level 6 ft. by 6 ft. is driven along the strike, and, from this, other galleries are driven at intervals following the inclination of the stratum. When one of the galleries has reached the boundary of the workings, it is filled up with rubbish to within 18 in. of the top, and another gallery about 8 ft. wide by 6 ft. high is commenced parallel to the first, leaving a sufficient thickness of material as support for roof. When all the lower portion of this deposit has been worked away, a slice above 6 ft. in height is removed in the same way, and this operation is continued until the roof of this deposit is reached. The pumice is brought to surface on men's backs, the miners taking in turns the excavation and transport of the material. The workings are usually carried on by 8 or 10 miners, who, at the end of their day's work, divide the pumice obtained, and carry it down to the village of Canneto, where the principal dealers reside.

About 240 miners are engaged in this industry, and produce about 25 tons per annum per man. The deposits of pumice chiefly belong to the commune, which levies a duty of 3.25 lire per ton on all exported from the island. Some of the workings belong to private individuals, in which case the miners pay a small royalty.

The sorting and preparation of the material is carried on at Canneto. It is classified according to quality, the best of which is sold at Messina at 40*l.* per ton, whilst the inferior qualities fetch from 25*s.* to 30*s.* per ton. There are also mills at Canneto, and here quantities of ground pumice are obtained. About 6000 tons is annually exported, which, at an average value of 70 lire per ton, represents 420,000 lire (16,800*l.*).

In 1888 a reputedly important mine of pumice was opened up in the Peak of Teneriffe, Canary Islands, but it has apparently not yet afforded any supply.

Some 60 or 70 tons yearly are collected at Lake Honda, San Francisco county, California, and meet the local demand.

PYRITES.

UNDER this head are included only such pyrites as are mined solely or principally for their sulphur contents, and utilised in the manufacture of sulphuric acid.

While there are many deposits of iron pyrites in most parts of the world, they are not always accessible to mining at low cost, and situated so that transportation of the low-valued product is easy and cheap. These primary conditions are essential to the industrial usefulness of any pyrites bed. Further, pyrites containing any earthy carbonates are most objectionable, as they would give off carbonic acid in "burning" and hinder the reactions in the chambers. Another point to be taken into consideration is the physical character of the ore, whether compact or crumbling, as on that will greatly depend the proportion of dust created in breaking, and consequent difficulties or losses in burning.

The ordinary sources of pyrites used in Great Britain are:—

(a) The "coal-brasses" or pyritic nodules found in the Coal measures; they carry up to 36 per cent. sulphur, but average much less, and being contaminated by carbonaceous matters they blacken the acid made from them, but they are low priced.

(b) Irish pyrites, mined in the neighbourhood of Wicklow, where immense beds occur; containing only 30–35 per cent. sulphur.

(c) Norwegian, shipped from Ytteroen, carrying 44–46 per cent. sulphur, and, though often said to be free from arsenic, frequently showing 1·6–1·7 per cent. of that undesirable element.

(d) Westphalian and Belgian, good as to sulphur contents, but also carrying ·9–1·8 per cent. arsenic.

(e) Spanish, differing from all the foregoing in containing some copper, for which the "cinders" are subsequently treated; rich in sulphur and free burning, but contaminated with 1·6–1·7 per cent. arsenic.

Canada produces yearly 40,000 to 70,000 tons of pyrites. An excellent sulphur ore for acid making is mined at Pinney's Island, Newfoundland, and is shipped to the United States. Analyses show it to contain

	Per cent.
Sulphur	52·00
Iron	46·80
Alumina	·10
Insoluble matter	·40
Oxygen, moisture and loss	·70

The ore is firm, burns remarkably freely, is manipulated without trouble, and can easily be burned so that less than ·5 per cent. of sulphur is left in the cinders.

The production of pyrites on a commercial scale in the United States is confined to two States. Massachusetts affords annually

20,000 to 30,000 tons, and Virginia 30,000 to 70,000 tons. The sulphur contents is about 44 per cent., and the cost of production is about 6s. a ton.

A scarcity of brimstone has recently led to greater attention being paid to native pyrites in the United States, especially for the manufacture of sulphuric acid for dissolving phosphates and purifying petroleum, and some very misleading figures have been officially published in this connection. At current prices (January 1892) and at points where consumed, the prices of sulphur contained in several products are thus given:—

100 units of sulphur in brimstone.. ..	\$31·00 (6l. 5s.)
" foreign pyrites ..	18·15 (3l. 15s.)
" Virginian pyrites ..	14·50 (3l.).

These figures seem to neglect the fact that the imported pyrites carries 52 to 53 per cent. of sulphur, and the native article only 44 per cent.

In much greater error are the computations regarding cost per ton of sulphuric acid made from brimstone and pyrites respectively. The nearest approach to the truth is made by W. H. Adams, who bases his calculations on works situated at Atlanta, Georgia. He erroneously supposes (1) that brimstone requires a greater consumption of soda nitrate than pyrites, whereas the opposite is the case; (2) that the same labour will effect the handling (breaking, charging, &c.) of 10 tons of pyrites as of 4 tons of brimstone—a self-evident mistake; and (3) that the wear and tear on the chambers, &c., will be the same with brimstone as with pyrites. Other exponents err to far greater lengths. Adams's figures are quoted below:—

Cost of sulphuric acid from brimstone. (One day's work):—

4 tons of brimstone, including costs of freight, losses in transit, &c.,	} \$96·00
at \$24 per ton	
Nitrate of soda, 6 per cent. of brimstone used, 538 lb. at \$2·50 per	} 13·45
100 lb.	
Labour, 5 men, at \$1·25 per day	6·25
Coal, 2 tons, at \$3 per ton	6·00
Superintendent and office cost	6·00
Wear and tear	10·00

Producing 18 tons of chamber acid, at \$7·65 per ton .. 137·70

Cost of sulphuric acid from pyrites. (One day's work):—

10 tons pyrites, including costs as above, at \$5 per ton	\$50·00
Nitrate of soda, 400 lb. at \$2·50 per 100 lb.	10·00
Coal	6·00
Labour	6·25
Superintendent and office cost	6·00
Wear and tear	10·00

Producing 18 tons of chamber acid, at \$4·90 per ton .. 88·25

A common drawback to pyrites is the presence of impurities, notably arsenic, which prevent the application of acid made from

them to many purposes. Nearly all pyrites contain arsenic, some even as much as 2 per cent. Dr. Drinkwater has described two kinds of sulphur ore or "stone," as it is technically called, absolutely free from arsenic. One was an Algerian, the other a Welsh ore. The composition of the former was:—

Sulphur	44·8
Iron	46·6
Insoluble	5·2
Lead	0·02
Manganese oxide	0·22
Lime carbonate.. .. .	3·1
	<hr/>
	99·94

It also showed traces of nickel and cobalt.

This Algerian ore was of a greenish colour, of a soft character, making a large quantity of smalls, and difficult to burn in the kiln. It made very good acid; but, with the greatest care, at least 4·5 per cent. of sulphur remained in the burned ore.

The Welsh ore is of a different character. It is very hard, and difficult to break. In appearance it resembles the white pyrites of Saxony. It makes very little smalls; burns well and completely in the kilns.

Following is a complete analysis of the Welsh ore:—

Sulphur	48·3
Iron	42·1
Insoluble matter.. .. .	5·8
Alumina	1·4
Lime carbonate	2·5
	<hr/>
	100·1

Another specimen containing some quartz, and not, perhaps, a fair average sample, showed only 45 per cent. of sulphur.

The burned ore sampled from a large bin with great care, only contained 3 per cent. of unburned sulphur. The great hardness would lead one to suspect that more than 3 per cent. would be wasted; but a considerable practical experience has shown this to be otherwise.

There is no difficulty whatever with this ore, to keep the burners up to a full red heat.

The acid produced is certainly of a superior quality for pyrites acid. It is of a good colour, and entirely free from arsenic. In fact, it could not be distinguished, either by physical or chemical tests, from the best sulphur acid.

The Algerian ore has apparently disappeared from the market; but this Welsh ore, raised from the Cae Coch Mine, is superior in many respects, and will, when fully known, be largely used for the production of an acid which might be sold as sulphur acid.

"Recovered" sulphur from alkali waste is always tainted with arsenic.

Dr. Drinkwater examined a number of varieties of pyrites for arsenic, and gives the following results:—

ARSENIC IN PYRITES.

					a	b	c
					per cent.	per cent.	per cent.
Cornish stone93	.56	.5
Irish	2.
Belgian	1.03	.40	.22
Norwegian stone32	.20	..
Spanish stone	1.81	1.65	.89

In addition, most Spanish pyrites contain selenium.

For estimating arsenic, Dr. Drinkwater prefers the fusion method to the oxidation with nitric acid. After fusion, dissolve in water, and precipitate with washed H_2S , redissolving the ppt. in carbonate of ammonia, and again precipitating with acid, weighing on tared filter as As_2S_3 .

As a rapid and accurate method of estimating the sulphur available to the acid maker in a sample of pyrites, J. Cuthbert Welch has published the following in the *Analyst*:—Place .5 grm. of pyrites in a porcelain boat in a combustion tube, heat to redness, pass oxygen* over till combustion is complete, and absorb the gas formed in about 30 c.c. of a solution of bromine in a mixture of equal parts of hydrochloric acid (sp. gr. 1.1) and water, in potash (or preferably nitrogen) bulbs. Wash out the solution into a beaker, boil, precipitate by boiling solution of barium chloride, cool, filter, and wash, dry, and ignite the barium sulphate.

The annual production of iron pyrites in the United Kingdom is 15,000–20,000 tons, valued at 10–12s. a ton. The cinders are deprived of the copper, silver, and gold which they may contain, and the residue of iron oxide is converted into an excellent pigment. In America about 100,000 tons of pyrites residue is thrown aside annually, containing about 55 per cent. iron, 8 silica, 3 alumina, 2 sulphur, 1 zinc, and $\frac{1}{2}$ copper.

* The oxygen should be prepared from pure potassium chlorate in glass vessels, or at any rate in an iron one, kept specially for the purpose, and the gas should be passed through a strong solution of potash in the bulbs, through a U-tube containing calcium chloride, and lastly either through another calcium chloride tube or, preferably, over phosphoric anhydride before use.

REFRACTORY MATERIALS.

(See also Clay, p. 185.)

AN absolute essential in metallurgical processes connected with iron and steel is a refractory material capable of much greater resistance to chemical action, and possessing a far higher melting point than any body which contains silica; because the latter will melt and sweat off in the furnace, even though it be not exposed to bases that form fusible compounds with silica.

Lime and magnesia are in themselves as refractory to heat as the best other materials, not a trace of melting being shown on pieces exposed to the highest temperature of steel-melting furnaces. It is a different matter, however, when lime and magnesia are subjected both to chemical action and elevated temperatures.

Experience has shown that no natural product can be used directly, owing either to uncertainty of composition or to scarcity. The available substances* that may be used in combination or after treatment are bauxite, chrome-iron, lime, dolomite, magnesite—(when it does not contain too much silica, which is seldom),—and artificially prepared magnesia.

Bauxite is comparatively rare, and of uncertain composition; a little silica or an excess of oxide of iron makes it fusible; pure and burned, it is not plastic, and must be mixed with some aluminous material. Thus it cannot be used on a very large scale, and has only been successfully applied to the separation of the basic and acid materials in the basic open-hearth process.

Chrome-iron is used in large pieces for lining the cupolas for burning dolomite, and is generally crushed and mixed with tar to form the junction between the basic and silicious material in the open-hearth furnaces.

Lime and dolomite, alone or together, or magnesia extracted from dolomite by some chemical process, seem to be the only materials available for basic refractory linings. Limestones will answer well, provided they contain a small proportion of clay. If the limestone is pure, it is difficult to burn; if too impure, it is very likely to frit or to fuse. It has been found that 8 per cent. of foreign matters does not affect it seriously, but of this percentage some should be alumina, and as little silica as possible; iron is to be avoided. Dolomite may be used either by itself or simply for the magnesia which is extracted from it. It is impossible to say just how much or how little foreign matter it should contain to be of the greatest utility. Whether it is to be used by itself, or the magnesia is to be extracted from it, the

* T. Egleston, "Basic Refractory Materials," *Trans. Amer. Inst. Min. Eng.*, xiv. 455.

higher its contents in magnesia the better. Dolomite contains generally 2-3 per cent. of silica, 2-3 per cent. of iron, and 30 per cent. of magnesia carbonate. Lime is expensive when burned at the same high temperature as dolomite; and there is very little if any advantage in using it.

Owing to the difficulty of finding a limestone that will answer all conditions, dolomite is generally used, for though the magnesia is not indispensable, a favourable combination of constituents is usually found associated with it. Yet it seems likely to be replaced by artificially prepared magnesia. Native magnesia carbonate is costly, but if it could be had free from silica, it would afford a most useful material after calcination.

Wasum made a number of experiments under the conditions of actual practice on bricks made of dolomite, lime, magnesia, and magnesite, using different binding material and additions, whose action upon the base was to be examined. These bricks were pressed with as little water as possible in iron moulds, dried, and were then exposed to the highest white heat attainable in kilns used for making basic Bessemer brick, the shrinkage being simultaneously noted. A part were kept in the dry air, in order to test their resistance to disintegration.

A second set was heated to redness, when red-hot was cooled in water, and was then kept in the air until it disintegrated; while a third set was treated in the same manner, but, after cooling in water, was again heated to redness, and thus kept till the brick fell to pieces. The crude materials used had the following composition:

	Dolomite. Per cent.	Magnesite. Per cent.
Lime	31·62	1·69
Magnesia	20·19	44·98
Silica	1·70	0·10
Alumina	0·09	0·84
Iron protoxide	1·22	1·63
Manganese protoxide	trace	0·29
Carbonic acid	43·35	50·57
Total	100·17	100·00
		Limestone.
Carbonate of lime		98·80
Insoluble residue		1·07
Total		99·87

The magnesia was prepared by burning the magnesite at a white heat.

Many experiments were carried out with each of these four materials, in order to test the action of clay (with 49·4 per cent. silica), silica, phosphoric acid, oxide of iron, sesquioxide of iron, sesquioxide of manganese, and a basic converter cinder.

The latter had the following composition:—8·14 per cent. silica, 48·25 lime, 4·65 magnesia, 15·84 phosphoric acid, 9·48 protoxide

of iron, and 6.14 peroxide of iron. In the case of dolomite the investigation embraced experiments on the action of protoxide of iron, phosphate of protoxide of iron, and phosphate of peroxide of iron. Wasum tabulated the results, and draws from them the following conclusions:—

(1) Good brick may be made of dolomite, limestone, and of magnesia burnt at a white heat, without the addition of any binding material. This, however, is not the case with magnesite, because the latter, when ground, is not sufficiently plastic. Much finer bricks are obtained when clay is added; and under these conditions, even magnesite yields faultless brick. Unless the new material used for the manufacture of the brick is very inferior, the addition of clay may go as high as 5 per cent. without materially affecting the refractory character of the brick. They must be burned at the highest white heat for a long time.

(2) Dolomite and lime bricks, made without any binding material, will, on an average, last 3 weeks in dry air. By the addition of clay, their durability is materially increased. Bricks made of magnesia or magnesite, with or without clay, last more than 3 months. The temperature at which the bricks have been burned greatly influences their durability. The higher it has been, the better the bricks in this respect. In practice, bricks from the same kiln will show marked differences in regard to resistance to weathering, a fact attributed to differences in the temperature of burning. It is important, therefore, in designing kilns, to have the flues so arranged that the temperature is uniform throughout.

(3) Dolomite and lime brick, cooled with water when red-hot, fall to pieces very rapidly; but this disintegrating process is much retarded by adding clay in their manufacture, in direct proportion to the percentage added. When the bricks are, after cooling with water, reheated to redness, they do not entirely recover their resistance to weathering, but it takes a few days longer for them to disintegrate. Cooling with water has little effect on magnesia and magnesite brick. They had not fallen to pieces after they had been kept a year. More or less all basic brick crack by cooling in water when red-hot, but these cracks are rarely so large that they break at once. When, however, disintegration sets in, the bricks split in the direction of these cracks, generally, in conformity with their form, at right angles to their two axes. In the case of magnesia and magnesite bricks, also, a slight disintegration is noticeable, it being possible, after a few months, to break them by strong pressure of the hand in the direction of these cracks. The surface of these cracks is dull, while the fracture of the brick is otherwise brightly crystalline.

(4) Dolomite, lime, and magnesite bricks, unless made of impure material, shrink about 24 per cent. when exposed to the highest white heat. Bricks made of strongly calcined magnesia shrink only 4 per cent. All substances that tend to decrease the refractory character of basic bricks increase their shrinkage.

(5) Lime and dolomite bricks are equally attacked by the cinder formed in metallurgical processes, while magnesia bricks show much

more resistance. The oxides of iron are the worst enemies of basic bricks, and therefore particular pains must be taken in choosing raw materials, with the view of having them as free as possible from oxides of iron, which make the bricks less refractory without at the same time increasing their durability in dry air. Silica, phosphoric acid, and the oxides of manganese are not so destructive to basic brick.

Summarising, Wasum states that undoubtedly the best material for basic bricks is magnesia preheated at the highest white heat. The bricks made from this material are remarkable for their durability in dry as well as in moist air, for their power of resistance to the action of cinder at high temperatures, and for the small amount of shrinkage.

One great practical drawback to the lime and dolomite bricks is, that they disintegrate in so comparatively short a time, so that it is impossible to manufacture a large stock of them. The heavy shrinkage, too, is disagreeable, leading to the production of very many irregularly shaped bricks, and causing large joints in the masonry, which in turn lead to its rapid destruction.

All these drawbacks disappear with the magnesia brick. But their cost excludes them, and they would be available only, if, at present prices, they would last 3 to 4 times longer than lime or dolomite brick. Practical experience has shown, however, that their resistance to the action of cinder is not much greater.

The compounding of a basic brick from several constituents necessitates the complete pulverising and mixing of the materials, making them up into bricks, and then burning and regrinding them. The material must be calcined so long and at such a high temperature that it will not afterward either slack, except upon long exposure, or contract at any heat to which it may be put in the converter. The calcination must be done with care, since it is desirable that the pieces burned should not split under the influence of heat, and that there should not be a large amount of fine material produced. This consideration is important and affects the cost unfavourably.

Magnesia prepared artificially was used at Hörde for several years, but was found too expensive.

At Hörde magnesia was extracted from dolomite on a large scale, and had the advantage of being perfectly homogeneous and almost pure; it could be stored much longer than dolomite bricks. Two processes were used, equally simple and good. Dr. Scheibler's process consists in burning the dolomite to drive off the carbonic acid, and then making a thick milk of it with water. Into this is poured water containing 10 to 15 per cent. by volume of molasses. The mixture is carefully stirred with a mechanical stirrer. In a few moments saccharate of lime is formed, and remains in solution while the magnesia is precipitated. Put through a filter-press, the magnesia remains behind and the saccharate of lime passes through. This is then treated with carbonic acid (which precipitates the lime as carbonate) and put through a filter-press; the lime after washing is

used or thrown away; and the molasses is used over again. The composition of the magnesia so obtained was :

	Per cent.
Silica, iron oxide and alumina	1.47
Lime	2.18
Magnesia	95.99
	<hr/>
	99.64

The loss in molasses was 5 to 10 per cent., and too large for economical manufacture, though the qualities of the bricks were unexceptionable.

Closson's process is based on the use of magnesium-chloride, a by-product of the manufacture carried on at Stassfurt. A quantity of the Stassfurt magnesium chloride is added to dolomite which has been burned and made into a milk, both being mixed together with sufficient water in an agitator. The reaction takes place rapidly, and when quite complete the tub is tapped from the bottom and its contents are run through an ordinary sugar filter-press. The lime chloride runs out and leaves the pure magnesia hydrate in the filter. This is carefully washed with water, and the lime chloride is collected in a basin. To utilise this material it is carried to a receptacle like that in which blast-furnace gases are washed, except that revolving wheels stir the chloride, making a thorough mixture of the gases and liquid. Two of these receptacles are placed together back to back. A valve which can be reversed sends the gases to either side, and thus keeps up a continuous working. Into this box a quantity of freshly burned dolomite is put, together with the lime chloride. The blast-furnace gases passing through precipitate the lime, have their carbonic acid or a part of it removed, and are thus rendered more combustible. They deposit, besides, a considerable quantity of the solid materials carried off mechanically with them and are thus cleansed. Magnesium chloride is re-formed and remains in solution. The liquor drawn off is filtered; the mud and lime carbonate are thrown away; and the magnesium chloride is used over again. There is a loss of 5 to 6 per cent. of chloride of magnesium. The magnesia obtained by this method is made into bricks and burned. It is then reduced to powder, mixed with a little water, and formed into bricks of any shape in a hydraulic press, which, with 4 men, makes 4000 small bricks a day, two at a time. The same press is used for the tar-bricks. After a few hours' standing in a dry place the bricks are quite hard. The filter-press makes one filtering and washing in 45 minutes, and contains 25 moulds, turning out about a ton of magnesia a day. To produce the ton of magnesia, about 3000 lb. of dolomite and 20,000 lb. of magnesium chloride are required. The total cost is about 4s. per ton. The analysis of the magnesia produced is :

	Per cent.
Silica, iron oxide, alumina	1.05
Lime	1.94
Magnesia	96.90
	<hr/>
	98.99

The difference between the products of the two processes is hardly appreciable, and they are nearly alike in cost. Closson's process is only applicable in the vicinity of works like those of Stassfurt. Scheibler's can be used wherever molasses can be had at a moderate price.

Magnesia is made out of sea-water (which contains about 4 lb. as chloride or sulphate in 1 cub. yd. of water) on a large scale on the Mediterranean coast of France, at Aigues Mortes, with milk of lime. The sea-water is pumped into a tank made of masonry, and milk of lime in the proportion of 1.5 per cent. of lime for every 1 per cent. of magnesia is pumped into it at the same time. From here it flows into two similar tanks, where the two liquids are mixed mechanically, and then filtered into shallow excavations about 1000 ft. long and 16 ft. wide, on the bottom of which is a bed of clean beach-sand. When enough has collected, the stream is turned off, and the precipitate is allowed to dry in the sun, taking 20 to 30 days; in winter it must be artificially dried. The dried material is calcined at white heat, ground, and made into bricks.

Magnesia has great advantages in simplicity of operation and uniformity of product; the amount necessary for a ton of steel is only one-third as much as is required of dolomite, while it lasts much longer in the converter. It can be made into bricks by mixing with water only; and the bricks can be kept much longer, and resist pressure at least as well as the others.

All substances used for the manufacture of basic refractory materials must be calcined at a very high temperature, in order to make it certain that no subsequent change of form by contraction will take place. Of the two general methods of calcination, the first, which is very generally employed, is carried out in the shaft furnace; the second, in some kind of gas furnace, the object in this case being not only to have a very high temperature, but also to avoid the introduction of silica or other impurities which come from the ashes of the coke. It has been found expedient, in most works in England, to burn in cupolas, raising the temperature to a white heat, and then selecting from the product those pieces only which are of a certain colour, rejecting every piece not sufficiently burned, or which shows any kind of agglomeration, and breaking off any adhering silicious material formed by the ashes of the fuel.

Objections to the cupola are, that, as the temperature cannot be regulated, there is danger that the dolomite will not be heated sufficiently to prevent further shrinkage in the converter; that it makes a considerable quantity of fine dust by abrasion; and that the ash of the fuel is likely to form more or less fusible silicious attachments to the pieces. As it is quite impossible to always have a perfectly pure coal, the material will frit and form engorgements in the furnace which after a time force it out of blast. This is partly remedied by having the centre on wheels. But the labour entailed is great.

Continuous regenerative calcining-furnaces use less fuel than the cupola, and are free from the objections just named; so that, by

their use, little of the material is damaged. The hearths only of the furnaces are made of basic material, the sides and roof being silicious. No inconvenience results from this, since the material to be calcined does not touch the sides of the furnace at all. Comparatively little fuel is burned in order to produce the temperature required.

SALT.

COMMON salt, sodium chloride, is one of the most widely distributed minerals, occurring in varying proportions in all sea-water, as well as in enormous beds in strata of certain geological ages.

To commence at home, the features of the remarkable salt beds of Cheshire are of special interest, commercial, domestic, and historical. The formation of the "meres," so peculiar to Cheshire, is believed to have been due to the solution in past ages of beds of rock-salt lying at great depths below the surface. The depth of the water in one of these meres, at Rostherne, has never been accurately ascertained.

The area of the district in which the saliferous marls have been deposited is computed at 700-800 square miles. These marls rest chiefly upon red and variegated sandstones, the exceptions being chiefly south of Macclesfield and beyond the east of Congleton to Odd Rode; and also in part of Lancashire, where they rest upon the Carboniferous formation. Beyond Frodsham, extending in a westerly and then in a northerly direction, the salt deposits in the geological epochs seem to have been formed in what is now occupied by part of the estuary of the Mersey. In the salt districts of Cheshire, outcrops of the saliferous marls and marlstones exist in several localities, as at Acton and Winsford.

No outcrop of rock-salt now remains in the salt districts of the United Kingdom. The depth to the top of the salt-rock, called the rock-head, is 132 ft. at Northwich, and 195 ft. at Winsford, whilst at Middlewich no rock-salt has yet been discovered.

Geologists are not agreed as to the manner in which these enormous beds of rock-salt were formed. There is, however, a leaning by competent observers to the theory that during the Permian age successive subsidences and upheavals of the land took place; that at each depression of the surface the sea overflowed an extensive low-lying area, where eventually a deposit of salt was formed by evaporation; and that by repetitions of this process the vast beds which we now find were accumulated. In a rough way, the thickness of the beds has been averaged at 150 ft., and the extent 20 miles by 12 or 15 miles; but this extent has not been actually proved.

Practically, the deposits are considered inexhaustible. The upper surface of the rock-salt appears to undulate similar to the undulations of the surface of the ground. It is upon the top bed of the rock-salt that the brine called rock-head brine ordinarily lies.

The raising of rock-salt is not now carried on to the same extent as formerly. Brine is abundant, and is more readily converted into the salt of commerce, the "rock" produced by the mines being used almost exclusively in the alkali manufacture. The stores of brine will undoubtedly exist so long as there is plenty of rock-salt to which surface-water, percolating through the superincumbent earth and

marl, can have access. The rock is very readily converted into brine by the simple process of solution, which is ceaselessly carried on under ground by the silent operations of Nature. As soon as it reaches a certain depth, the water finds its way into some one of the innumerable streams which are for ever eating away the rock-head, and flowing, in the form of brine, towards the works where pumping is carried on. These streams are locally called "brine-runs," and have been proved to extend for miles. The law by which they are guided seems only the requirement of a supply of water, and descent. Some of them, as the subsidences show, take nearly straight courses, whilst others twist about in various directions. The course taken will probably be where the resistance is least, or where the rock-salt is softest, or in hollows on its surface.

Our other important salt-field is near Middlesbrough.* For something like 20 miles the river Tees flows through a country, before it reaches the North Sea, belonging, geologically, to the New Red Sandstone formation. Over the salt area this rock is rarely visible, owing to a covering of alluvial matter of great thickness. On the right bank of the river the New Red Sandstone underlies the Lower Lias beds, which form the Cleveland Hills at this point; and on the left bank it gradually rises until it reaches the surface near Hartlepool. After this the magnesian limestone, upon which the Red Sandstone rests, becomes the surface-rock over the eastern portion of the county of Durham.

In 1859, in the hope of obtaining water, a well was sunk to a depth of 1200 ft., during the whole of which the water was found to contain so much sulphate of lime as to be useless. At the depth just mentioned, a bed of rock-salt was struck, which proved to have a thickness of about 100 ft.

The method of raising the salt to the surface is by solution, in such a way that the column of descending water is made to raise the brine nearly as high as the differences of specific gravity between the two liquids will permit. Saturated brine contains $26\frac{1}{2}$ per cent. of its weight of salt, and has a sp. gr. of 1.204; hence a column of such a solution of 997 ft. will support one of pure water having a height of 1200 ft. In other words, a column of fresh water of 1200 ft. will bring the brine within 203 ft. of the surface.

A hole, say, 12 in. diam. at the surface is commenced, and retained of this size as long as it is safe, on account of its weight, to let down a wrought-iron tube something under 12 in. diam. This tube has a thickness of $\frac{1}{4}$ -in., and is used for the purpose of supporting the sides of the hole. The boring is thus continued, and a second length of tube is lowered down the inside of the first, and so on until the bottom of the salt-bed is reached. The portion of this outer or retaining tube, where it passes through the bed of salt, is pierced with two sets of apertures, the upper edge of the higher set coinciding with the top of the seam, and the other set occupying the lower portion of the tube (Fig. 96). Within this tube so placed and secured at its lower extremity, by means of a cavity sunk in the limestone, a second one

* L. Bell, "Manufacture of Salt near Middlesbrough," Proc. Inst. Civ. Engs., paper No. 2260.

is lowered, having an outer diameter 2-4 in. less than the interior diameter of the first tube. This latter serves for pumping the brine. It is secured at its lower end in the same way as the other, and is then provided with snore holes, by which the brine is admitted. The pump itself (Fig. 97) is an ordinary one fitted with a bucket and clack, but, in addition, at the surface is a plunger, which serves to force the brine into an air-vessel for purposes of distribution. The bucket and clack are placed some feet below the point at which the brine is raised by the column of fresh water descending in the annulus between the two tubes.

The rate at which the salt is dissolved depends on the extent of surface exposed to the action of the water. This at first is very slow and the quantity of salt for some months furnished by a well is inconsiderable, and the brine raised is very weak.

When the cavity formed by the water is sufficiently large to admit of a few hours' pumping of saturated brine, the machinery is put in motion, drawing at first the stronger brine, which, from its greater specific gravity, occupies the lower portion of the cavity. As it is raised, fresh water flows in through the holes in the outer tube. The solvent power of the newly admitted water is greater than that of water partially saturated, and being also lighter it occupies the upper stratum of the excavated space. The effect of these two circumstances is, the removal of a much larger quantity of the salt on the upper surface of the seam than at the lower, giving the cavity the form of an inverted cone.

It is obvious that a mode of extraction, which removes the greatest quantity of the mineral where it is most wanted for supporting the roof, must always be accompanied by considerable danger from falls of the superincumbent rock. This danger is intensified in the Middlesbrough district by a layer of 40 ft. of sandstone, lying immediately above the salt, being interstratified with marls, which, being affected by the inflowing water, cause large masses to be detached, as is evidenced by occasional discolorations of the brine.

It has been found that some wells either afford weak brine, or the quantity of strong brine is considerably below the average of other stations. The first source of loss is, in some cases, probably

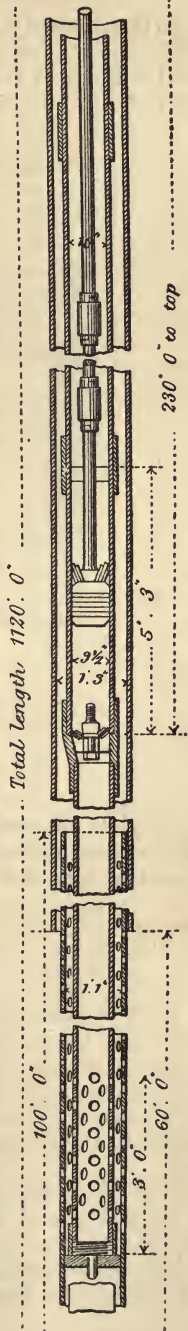

FIG. 96.—BRINE WELL TUBE.

due to the screwed joints of the pump not being tight, or the metal itself of the pipe containing a flaw. Either of these defects permits water from the annulus to enter the pumping-tube, thus diluting the brine, which of course entails extra expense in evaporation. The diminution

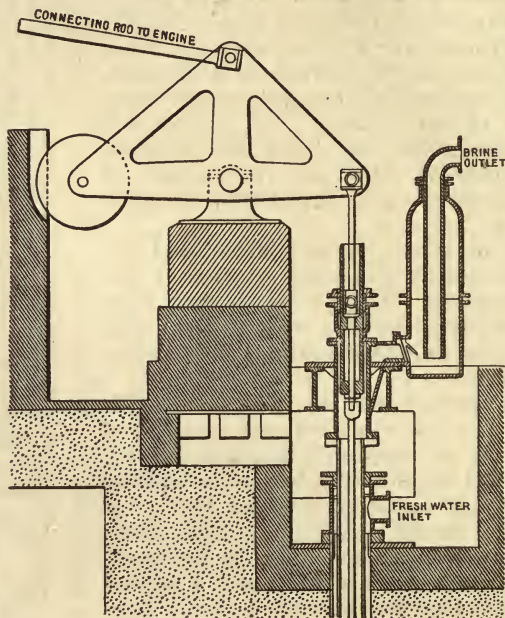

FIG. 97.—BRINE WELL PUMP.

in the yield of strong brine is possibly also due to another cause. The rock-salt contains a good deal of earthy matter, distributed in layers throughout its mass, as exhibited by the following analyses:—

	Salt.	Earthy matter, &c.		Salt.	Earthy matter, &c.
a.	98.42	1.58	d.	45.00	55.00
b.	37.90	62.10	e.	92.50	7.50
c.	45.30	54.70	f.	78.40	21.60

With so much sterile matter to deal with, it is not improbable that the sloping sides of the cavity may get covered with a coating of mud of greater or less thickness, which probably interferes with the action of the water on the salt.

A pump is considered to do good work if it is raising brine 8 hours in the 24, and producing enough to give 250 tons of salt per week.

The Middlesbrough salt field has been proved to cover an area of $7\frac{1}{2}$ sq. miles, and each square mile is reckoned to contain over 100,000,000 tons of salt. But beds of salt are not always what geologists call "conformable," but rather what engineers call "pockety," and uncertain. For instance the rock-salt mines in the island of

Sicily, which occur in a district consisting entirely of gypsum (lime sulphate) mixed with great masses of clay, are very uncertain, and a sinking for rock-salt is quite as likely to find a pocket of sulphur as a pocket of salt.

The consequences of removing 100 ft. of salt over an area of $7\frac{1}{2}$ miles, even from a depth of 1000 or 1500 ft., must necessarily be serious. Another aspect is the injustice of one person extracting salt from another's property by pumping water out saturated with brine, the water finding its way into neighbours' territory, and thus robbing the ground of its solid contents.

Again, the question arises whether economy is obtained by this method of extracting salt as compared with mining salt in blocks. If the sinking of the shafts were a less difficult matter than it has proved to be, and than it appears to be from the nature of the strata to be pierced, the salt ought to be raised by some other process; but if there is a bed of salt 100 ft. thick, of which only a very flattened cone is to be got out round the bore-hole, and then fresh bore-holes are needed at short intervals, obviously a great deal is desirable in point of economy of utilising the deposit. No doubt this method, taken from the district of Lorraine, has certain advantages, and, so far as it has gone, it appears to be very satisfactory; but in Lorraine, the system has been sometimes superseded, by afterwards sinking shafts and working the ground in a miner-like fashion, on finding that by the old system there has been a vast amount of waste of useful mineral. In Middlesbrough, the deposit is so great that it pays better to sacrifice some of the mineral than to incur the increased cost necessary to recover it all. The estimate for sinking a shaft down to the salt has been variously put at 100,000*l.* to 200,000*l.*, while the value of the product is only 5*s.* or 6*s.* a ton.

The German Government saltworks at Schönebeck produce annually about 70,000 tons. The borings extend in a north-west to south-east direction for about 6 miles in the alluvial plain of the Elbe. The salt deposit, which is in two beds between the upper and lower members of the Bunter Sandstone series, is overlaid by the limestone of the Muschelkalk and the New Red Marl, the whole having an irregular dip to the south-west. None of these formations, however, appears at the surface, which is entirely covered by lignite-bearing Tertiary strata, forming the flat ground by the river; so that the discovery has been entirely made by borings extending over a period of more than 30 years.

The arrangements adopted for drawing brine from the borings comprise (1) protection of the purer portions of the bed of salt from those containing magnesian salts, by a coating of sand or concrete; (2) coating the strata immediately above the salt-bed with a casing of concrete, for the double purpose of providing a bearing for the lower end of the wooden lining, and for shutting off all chance of the infiltration of land water from above and the consequent introduction of sand and mud into the brine; (3) protection of the bore-hole by lining-tubes throughout.

The details of one of the borings are given in illustration of these principles. The hole was bored 14 in. diam. to a depth of 326 ft., and

was lined with a 13-in. iron pipe, below which point it was reduced to $12\frac{3}{4}$ in. down to 500 ft., when a diameter of $8\frac{1}{2}$ in. was adopted for the remaining 960 ft. A lower impure division of the salt-bed was then shut off by a packing of sand and concrete, after which a wooden packing was put into the hole immediately above the bed intended to be worked, and the hole was lined for a length of 16 ft. with concrete, or to within $2\frac{1}{2}$ ft. of the lower end of the lining-tube, which space was made secure by concrete put down the hole, in order to get a tight joint. In every case the hole was filled with concrete, which was allowed to set until it was sufficiently hard for re boring. The protection of the sides of the hole from erosion by the descending current of water was effected, in the lower portion, of $8\frac{1}{2}$ in. diam., by copper lining-tubes of $7\frac{1}{4}$ and 7 in. bore, made in lengths of 10 ft., which were jointed by coupling-pieces 8 in. long, and secured by riveting and brazing. At the top they were strengthened by a brass collar, $1\frac{3}{4}$ in. thick, which lay in the shoulder formed by the offset from the smaller to the larger diameter at the depth of 500 ft. The lining of the upper section, in wood, is 10 in. diam. and 1 in. thick for the first 500 ft., being in oak tubing, built up like a cask of staves, 10 ft. in length; the remainder is in pine, bored out from the trunks of carefully selected trees. The brine-lifting pumps are made of brass and copper tubes, whose diameter admits a space of about 2 in. within the lining-tubes for the introduction of the dissolving current of fresh water. This gives a length of about 100 ft. above the free level of the brine column, which in its turn is dependent upon the magnitude of the fresh-water column. The suction column, i. e. the position of the foot valve of the pump barrel, is determined by the density of the brine. The working barrel of the pump is made $1\frac{1}{2}$ time the diameter of the suction pipe, and the suction pipe about $\frac{1}{2}$ in. larger than the latter dimension, so that the pump bucket may be easily withdrawn for repairs when required. When these dimensions have been fixed, the weight of the pump is calculated approximately, and that of the column of brine above the valve accurately, in order to determine the necessary substance of the copper tubes and brass collars, which are so chosen as to be subjected to a working strain of one-fourth of the ultimate resistance. The screw collars of the suction pipes are 5 in. and those of the rising pipes 7.8 in. external diam.; the breadth of the annular space for the introduction of the working current of fresh water is therefore 1 in. in the lower and 1.2 in. in the upper part of the hole.

The results obtained from these borings have not quite fulfilled the expectations of their projectors. A tolerably pure and strong brine, containing $24\frac{1}{2}$ to 25 per cent. of salt, has been obtained from some of the bore-holes, while others only average 21 per cent., and some are often muddy. Experience seems to show that the yield is dependent more upon peculiarities in the bed of salt, than on the power of the pumping machinery; and that in order to obtain brine at a maximum of concentration, the pumping must not exceed a certain speed. This maximum has been attained in a well which yields per minute an average of about 4 cub. ft. of brine, containing 18.4 lb. of salt per foot. When pumped at a more rapid rate the brine is weaker, and not so well suited for boiling down.

The brine as pumped needs further treatment to yield its salt. In this connection the reader may be reminded that most of the substances designated saline are more soluble in hot than in cold water. The ordinary way of obtaining such bodies in the crystalline form, a process employed to free them from any impurities they may contain, soluble as well as insoluble, is first to make a saturated solution in hot water. This is allowed to cool, when the difference in the quantity capable of being dissolved in hot water and in cold is deposited in the form of crystals. The crystals, so obtained, usually contain varying quantities of solidified water, known as the water of crystallisation.

Common salt is one of the few exceptions to the law of relative solubility just named, for it is taken up almost as largely by cold water as by hot. It possesses the further peculiarity of forming crystals free from water of crystallisation. The former property renders an entirely different process necessary for obtaining it in the crystalline form to that usually pursued in such cases. The brine as it is delivered from the wells, is run into a large reservoir, where any earthy matter held in suspension is allowed to settle to the bottom. The clear solution is then run into pans, 60 ft. long, 20 ft. wide, and 2 ft. deep. Heat is applied at one end by the combustion of small coal, beyond which longitudinal walls, which serve to support the pan and distribute the heat, conduct the products of combustion to the farther extremity, where they escape into the chimney at a temperature of 500° to 700° F. On the surface of the heated brine, which for salt intended for the soda-makers is kept at about 196° F., minute cubical crystals speedily form. On the upper surface of these other small cubes of salt arrange themselves, in such a way that in the course of time there will be a small, hollow inverted pyramid of crystallised salt. This ultimately sinks to the bottom, where other small crystals unite with it, so that the ultimate shape frequently becomes completely cubical. Every second day the salt is "fished" out, and laid on drainers to permit the adhering brine to run back into the pans.

This process of evaporation appears very simple, but for its proper performance certain precautions are required. If the water admitted into the brine-well contains vegetable substances, a fine covering, consisting of salt and this extractive matter, forms a pellicle on the surface of the brine which completely stops evaporation, and, as a consequence, the generation of crystals.

For the production of table-salt, the boiling is carried on much more rapidly, and at a higher temperature (226° F.) than for chemical salt. The crystals are very minute, and adhere together by the solidification of the adhering brine, effected by exposure on heated flues. The loaves so obtained require to be pounded, and then afford the fine table-salt in common use. For fishery purposes, the crystals are preferred very coarse in point of size, and to produce these the evaporating process is conducted at a still lower temperature (100° to 110° F.) and much more slowly than when salt for the soda-makers is sought.

As already mentioned, the usual mode of evaporating the brine is

by means of coal burned under the salt-pans. At the Clarence Iron-works more gas escaped from the blast-furnaces than was required for heating the air and raising steam. The extent of this excess having been ascertained, large pans were placed over properly constructed flues immediately behind the steam-boilers. From these, by means of the waste heat, about 200 or 300 tons per week of salt is obtained. At Winsford, Blagg has introduced hot air to the fires, and finds that he can dispense with half his fireplaces, saving fuel and labour, and obviating the discharge of black smoke.

In the mode of evaporating the water by open pans, the amount of fuel used is large. Even when the brine is very strong, 3 times the amount of water has to be evaporated as compared with the amount of salt raised, and when the solution is weaker, of course the proportion of water evaporated is still greater. In some apparatus for evaporating from salt water, in order to get distilled water for drinking purposes, is obtained as high an evaporation as 27 lb. of water for 1 lb. of coal burned, and with another apparatus as much as 45 lb. of water per 1 lb. of coal, which is perhaps 10 times as high as the evaporation obtained by the open-pan process. In the one case it is the water which is required, the salt being thrown away, while in the other case it is the salt that is needed, and the water is thrown away; but the same plant is applicable for both purposes.

In all ordinary pans the salt forms in the hot brine, while the evaporation goes on, and falls on the plates which form the bottom. From time to time the salt is removed by rakes and shovels, but some salt or "pan-scale" is always lying on the bottom, impeding the action of the fire, and by shutting in the heat causing the iron plates to bend and burn. A constant strain and destructive action is thus at work, and it is no matter of surprise that the pans often leak. About once a week they are "dodged" or beaten with hammers and crow-bars in order to loosen and remove the hard pan-scale which adheres to the plates. After this operation, leakages are more frequent. The effect of leakage is that brine dries upon the fire or the heated brickwork below, and it there forms large blocks of salt. Some of this is volatilised as salt vapour and carried away in the smoke, or it is decomposed by the silica of the hot bricks, and also by the sulphurous acid of the coal smoke. When a salt-pan leaks, therefore, the smoke from the chimney connected with it may contain, besides the ordinary coal smoke, and its accompanying sulphurous acid arising from the pyrites in the coal, the vapour of volatilised salt, hydrochloric acid and steam. These facts must be borne in mind when establishing a salt-pan in populous districts, and due provision be made.

For additional information on salt-pans, the reader is referred to Spens' Encyclopædia of Manufactures, art. "Salt."

The yearly output of salt in England is about 2,000,000 tons, value 1,000,000*l.*

In India, the manufacture of salt from the ocean, in pans, either by solar or artificial evaporation, has been carried on since very early times, in various districts and regions which are adjacent to the coast. The industry is restricted to Kutch, portions of Madras, Bombay, the

province of Orissa, in Bengal, and parts of Burma. The artificially evaporated salt, though of distinctly purer character than that which is produced by the heat of the sun, is not used by the stricter Hindus, as they regard it as having been cooked, and therefore impure.

The Runn of Kutch is a large sandy desert for 9 months in the year, and during the remaining 3 is nearly covered by the waters from the Gulf of Kutch, when it becomes a muddy swamp. Below ground, in some places, very strong brine is met with, and this, when properly treated, produces excellent salt. The apparatus used for raising the brine is very primitive, and merely consists of a long teak wood pole, tied at about a fourth of its length to a post which is stuck in the ground. To the shorter end of the pole is affixed a balance-weight, formed of a lump of mud, bound to the pole with coir-line. To the lighter and longer end of the pole is attached a thin rope, and to this is slung an earthenware pot. These machines are generally erected in pairs. A hole in the ground having been dug, the workman pulls down the *chatty*, or earthen pot, into the brine at the bottom of the hole, the depth of which is 8-12 ft. When the *chatty* is full, the man allows it to ascend by means of the balance-weight, and empties the contents into a small channel, formed of earth, a little above the surface of the ground. This channel leads the brine into pans for evaporation by the heat of the sun. The pans consist merely of a rectangular piece of ground, perhaps 200 ft. long by 100 ft. wide, enclosed by ridges of earth 1 ft. high. This process of evaporation and continued supply of brine is carried on until the contents of the pans are reduced to a mass of beautiful large white crystals, some of which are 1 in. diam.

The soil of many parts of India is largely charged with a variety of salts, the concentration of which has resulted from a high degree of atmospheric evaporation, unaccompanied by subsoil drainage. The effect of irrigation on such lands, even with the pure water of the Ganges canal, has, in not a few cases, produced sterility in a manner which admits of a very simple, though not at first sight obvious explanation. It is that the general level of the highly saline subsoil waters has been raised to a level where they can act prejudicially by the deposition of the efflorescent salts, collectively called *reh*. The preparation of salt by lixiviation of such saline earths, though once largely practised, is now nearly extinct.

Saline springs and wells are very abundant in parts of Assam, Burma, and the Punjab. As in other parts of the world, they frequently occur in conjunction with petroleum springs. Wells have been used in many parts of India to extract the above natural subsoil saline waters, from which very large quantities of salt have been, and still are, manufactured.

There are also in India some notable examples of lakes which, having more or less extensive drainage basins but no outlets, deposit salt when, during the heat and drought of summer, the limit of saturation is passed. The principal of these lakes are situated in Rajputana, and among them the Sambhar Lake is the most important. The manufacture of salt, since it came into British hands, has been largely developed, and the total annual outturn now exceeds 100,000 tons.

In the Punjab are two distinct geological formations, which include deposits of rock-salt of enormous extent. One of these, believed to be of Silurian age, is situated in the salt range on both sides of the Indus, while the other, of probably Eocene age, lies wholly trans-Indus in the district of Kohat. The former is worked by means of mines, and the latter by open quarries. The produce of both is sold locally.

The manufacture of salt, which has been carried on in China for a period of nearly 2000 years, is conducted somewhat as follows. By means of a rude iron drill, holes 6 in. diam. and varying from a few score of feet to 5000 ft. or 6000 ft. in depth, are bored in the rock. The boring is sometimes continued for 40 years before brine is reached, and is carried on from generation to generation. When brine is finally found, it is drawn up by bullocks in long bamboo tubes by means of a rope working over a huge drum. In the vicinity of the salt wells, natural gas wells are also found, from which gas is supplied to evaporate the brine in large iron cauldrons, leaving the salt as a deposit. The product in some districts is enormous. There are 24 gas wells and about 1000 brine wells now in operation, producing annually 200,000 tons of salt, valued at about 1,000,000*l*.

The United States possess enormous salt deposits. The salt field at Petite Anse, Louisiana, is about 150 acres in extent, 16 to 25 ft. below the ground, somewhat triangular in shape, and, so far as known, 2500 to 2600 ft. wide. From borings made with a diamond drill some 4 years ago, it was learned that this bed is over 1000 ft. thick. At this depth the borings were discontinued. The most singular fact about this salt deposit is that it stands, so to say, on its edge. The stratification is nearly perpendicular from east to west, indicating an upheaval, and what was its original depth is now its width. It is at present considered to belong to the Tertiary period, though perhaps its true position can only be known with certainty when the underlying formation is reached. The salt occurs as a solid crystalline rock of a saccharoidal texture, the individual crystals being indistinctly aggregated and interspersed with microscopic crystals of gypsum. This salt is very pure, and if it were not for the peculiarity that it "cakes" after being ground, it would years ago have had a much greater and more extended market, especially as a table salt.

The method of mining is peculiar, and consists of a series of galleries. The galleries of the second level are run 80 ft. in width and 45 ft. high, leaving supporting pillars 60 ft. diam. The lower pillars are so left that the weight of the upper ones rests upon them in part, if not wholly, with a thickness of at least 25 ft. of salt-rock between. There are 16 to 25 ft. of earth above the salt-deposit. The contour of the latter conforms nearly with that of the surface. The working-shaft is 168 ft. deep. The depth to the first level or floor is 90 ft.; to the second, 70 ft. farther. The remaining 8 ft. are used for a dump. The galleries of the first level were run, on an average, 40 ft. in width and 25 ft. and upwards high, leaving supporting pillars 40 ft. diam. The galleries cross each other at right angles, and the ground-plan strongly resembles a chess-board.

In running a gallery, the first work is the "undercutting" on the

level of the floor, of sufficient height to enable the miners to work with ease. The salt is then blasted down from the overhanging body. The yearly output is about 50,000 tons.

The salt as it comes from the mine is dumped into corrugated cast-iron rolls, which crush it. Next it goes into revolving screens, which take out the coarser lumps for "crushed salt," and let the fine stuff pass to buhr-stones. These grind the salt, and from them it goes to pneumatic separators, which take out the dust, and separate the market salt into various grades. Taking the dust out is essential to the production of a salt that will not harden, since the fine particles of dust deliquesce readily, and on drying cement the coarse particles together. The drill used in the mine is what is known as the "Russian auger." It is turned by hand and forced by a screw of 12 threads per inch. The holes take cartridges $1\frac{1}{2}$ in. diam.; 2 men will bore 75 ft. of hole per working day of 8 hours; $\frac{3}{4}$ lb. of 18 per cent. dynamite is used per ton of salt mined.

The salt found at Retsof, New York, when taken from the shafts, is of a grey colour, due to the presence of finely disseminated dark grey clay, which, on solution of the salt, sinks, leaving a perfectly clear brine above. The salt is mainly an aggregation of not quite perfectly developed crystals, and when the lumps are broken the cleavage of many of these crystals is very marked; the fracture is conchoidal. Large pieces of the salt show stratification.

This rock-salt bed is in Upper Silurian. It extends east and west, according to our present knowledge, from Madison County to Lake Erie, and north and south from Le Roy to Castile. The salt stratum is over 100 ft. thick. In one well below the Tully Hills, Onondaga County, it had a thickness of 310 ft., and in another well 228 ft. It extends under Lake Erie, and underlies the northern counties of Ohio and Indiana, the entire peninsula of Michigan, and the western part of the Province of Ontario along Lake Huron and the St. Clair river. In some parts of this salt deposit—underlying thousands of square miles—we find the salt occurring in one vein, or even in seven veins, with layers of shales or clay between them of varying thickness, and at different depths below the surface. The phenomena are explained by events at any of the large salt lakes covering many hundred miles of surface. During the hot summer months evaporation is greatly in excess of the water entering the lake. As evaporation progresses, the less soluble salt, viz. the lime sulphate, separates first from the water as gypsum, forming a layer over last year's deposit, followed, as soon as the point of saturation of the salt is reached, by the latter in the form of a deposit, which will continue to increase with the advancing evaporation until a change in the weather takes place. When rain-water descends in large quantities from the surrounding hills, carrying all the loose material in its way into the usually dried-up streams and brooks, they in turn discharge water heavily laden with mud into the lake. The heavier material settles nearest to the lake shore on the lately deposited salt, forming a more or less thick layer, which in time hardens to shale or marl, while the lighter, mechanically suspended particles are carried farther out into the lake, according to the force of the incoming waters. They also

finally settle, forming a much thinner layer. Some parts of the lake, if it is a very large one, may not be reached by the suspended matter, and there no sediment is formed over the salt below. Since the rain-water is much lighter than the saturated brine of the lake, they mix but slowly, the fresh water flowing over the brine. Heavy frosts occur, and soon a strong crust of ice covers the surface of the entire lake. With the returning warm weather, rains again set in, carrying a fresh load of loose material toward and on to the ice of the lake, where the ice keeps it from sinking to the bottom until it becomes too weak to bear the load, and then both disappear below the surface. Thus also considerable quantities of this débris may be carried by the floating ice into places where there was none before. Evaporation, in consequence of the elevated temperature and the ever-moving air, soon causes the lake water to become saturated with lime sulphate, which it dissolves from the soil and suspended material. It separates, forming a new layer over the bottom of the lake in the form of gypsum, to be followed by another layer of salt again as evaporation progresses, and so the process goes on.

There are at present 4 salt shafts in Kansas—two at Kingman, one at Lyons, and one at Kanopolis—with a daily capacity of about 2000 tons. Thus the United States now have 9 salt shafts, with a total capacity of 4500 tons a day. The average Kansas rock salt does not differ materially in appearance from the New York rock salt. Geologically this salt deposit is found at the base of the Triassic.

The great bulk of American sea salt is obtained in California, in the Bay of San Francisco, especially in the county of Alameda, where there are at present over 25 works. In Los Angeles and San Diego counties, bordering on the Pacific, there are also several works in which sea salt is produced. It is all used for home consumption.

The most important salt lake in the United States is the Great Salt Lake of Utah, which is 75 miles long by 30 miles wide. The water is said to contain about 20 per cent. of pure salt and 2 per cent. of other saline matters.

The brines of the United States which serve to-day for the manufacture of most of the salt used for domestic purposes are distributed over a very large territory, and occur in several geological formations, from the Silurian upward. As they come from the bowels of the earth they are often highly charged with carbonic acid gas, and in consequence contain traces of iron bicarbonate and sometimes of lime, both of which will separate almost entirely as soon as the free carbonic acid, the solvent, has escaped, and the iron has become oxidised. Other brines are often charged with carburetted hydrogen to such an extent that the gas has been used as a fuel for their evaporation. Petroleum is found associated with some brines. Among the other impurities, lime sulphate (gypsum) is the most important, since it prevents the continuous manufacture of salt by artificial heat in consequence of its tendency to bake on highly heated surfaces, forming a constantly increasing coating over them. This coating adheres with such tenacity that it is impossible to remove it sufficiently while the works are in operation. Being a very bad conductor of heat, it entails a great expenditure of fuel if the operation is continued

beyond a certain time; hence the necessity of interrupting the process to remove these scales. Several methods have been proposed to precipitate the lime sulphate from the brine before the salt separates, either by superheating the brine or by chemical means; but thus far the expense incurred by these methods has been out of proportion to the benefits derived; hence the practical removal of lime sulphate from salt brines is even now the most important problem in connection with the manufacture of salt by artificial heat.

The manufacture of salt from brines by solar evaporation is carried on in shallow wooden vats, usually provided with movable wooden covers, which serve as a protection during winter and rainy weather. The Syracuse works, the most extensive in the United States, have an evaporating surface of over 12,000,000 sq. ft.

The expense of making salt depends on the strength and quality of the brine employed, on the kind of fuel and its price and quality, on the kind of labour and the cost of the same, on the weather, on the wear and tear and the original cost of the plant, and, finally, on the quality and quantity of the salt made. From these considerations it is evident that the manufacturing price per barrel or ton of salt is different in every locality and individual saltwork. In Syracuse 1 ton of anthracite dust will produce 8 to 10 barrels of salt; in the western part of the State, 13 to 15 barrels. In West Virginia and the Ohio Valley, the product is 5 barrels; in Michigan, 14 to 15 barrels are made with the same coal. To make a barrel of ordinary common fine salt, including barrel, costs in Syracuse 55 c. to 60 c.; in Western New York, 45 c. to 50 c.; in Michigan, 25 c. to 30 c., where wood, which is the refuse from saw-mills, has been used as fuel. For artificial evaporation, anthracite dust, bituminous coal, and wood have served.

The production of salt in the United States has steadily risen from 7,000,000 barrels (of 280 lb.) in 1885 to over 10,000,000 in 1891.

The rig adopted for working American brine wells is a duplicate of that described under Petroleum (see p. 280). The rate of pumping is regulated so that the brine is delivered with 25 per cent. of salt. As it comes up it is full of gas, which is mainly nitrogen with a small proportion of hydrocarbons. The bore-holes are arranged in fours at the corners of a square, with a diagonal of 200 ft. The brine is delivered into a large storage and settling-pond, whence it flows into sheet-iron evaporating pans. 1 ton of salt costs 1s. in labour and 9 cwt. of coal, in addition to $\frac{1}{2}$ cwt. of coal for pumping. By this system, the cost of a brine well 1000 ft. deep, including the rig, is 1000*l.*, and it is drilled in 3 weeks. Some wells bored by the diamond drill, on the other hand, cost 3000*l.* each, and took 3 months to make. The system presents, therefore, great advantages, especially where holes have to be numerous, and where it is not certain how long a well will retain its productiveness. On the other hand, in making preliminary explorations of a new district, the diamond drill is superior, because it furnishes actual cores.

There are many other localities where conditions favour the natural separation of salt from sea-water or brine, but nothing regarding them is of such a special or remarkable character as to deserve description.

SALTPETRES.

Two saline minerals of great utility and limited distribution are commonly known by the one name of saltpetre, though they differ essentially in composition. The more abundant is the South American saltpetre, or sodium nitrate; its Eastern ally is the nitrate of potash.

Soda nitrate.—Often called “Chili saltpetre,” nitrate of soda occurs along a considerable stretch of the Pacific coast-line of South America, not confined to Chili alone. The saline beds so characteristic of the region are later in age than the Tertiary period,* and appear at intervals scattered over the whole of that portion of the western coast on which no rain falls, extending entirely through the desert of Atacama, and stretching more than 550 miles north and south; their greatest development appears, however, between latitudes 19° and 25° S.

They are generally superficial, but occasionally reach to some small depth below the surface, and then may be entirely covered over by diluvial detritus; they always, however, show signs of their existence by saline efflorescence on the surface of the ground, which often covers vast plains as a white crystalline incrustation.

The salts forming these “salinas,” as they are generally termed, are combinations of the alkaline and earthy bases, soda, lime, magnesia, and alumina, with hydrochloric, sulphuric, nitric, and carbonic acids—and occasionally with boracic, hydriodic, and hydrobromic acids—and in combination present themselves as the following minerals in a more or less pure state:—Common salt, epsom-salt, glauber-salt, thenardite, glauberite, soda-alum, magnesia-alum, gypsum, anhydrite, along with calcium chloride, sodium iodide, bromide, carbonate, and nitrate, and in some places lime borate and borax.

With the exception of the boracic acid compounds, all the mineral substances found in these “salinas” are such as would be left on evaporating sea-water, or by the mutual reactions of the saline matter thus left on evaporation on the lime, alumina, and organic matter found in the adjacent rocks, soil, and shell-beds; and bearing in mind the recent elevation of the whole of this coast, and that no rain falls in these regions, it appears very reasonable to suppose that all these saline deposits owe their origin to lagoons of salt water, the communication of which with the sea has been cut off by the rising of the land.

The deposits situated at about 2500 to 3500 ft. above the present sea-level include the important beds of nitrate of soda, showing themselves, according to the configuration of the country, at distances varying from 10 to 40 miles inland.

The first step in the formation of nitrate of soda appears to be the decomposition of the sodium chloride (salt) by lime carbonate (in

* D. Forbes, “Bolivia and Peru,” Proc. Geol. Soc., Nov. 21, 1860.

the form of shell-sand, &c.) with the production of chloride of calcium and carbonate of soda, both of which salts have been shown to be present in quantity in the soil of these nitrate-grounds.

The soda carbonate thus eliminated, when in contact with the mixture of shell-sand and decomposing vegetable matter which may be expected to result from the luxuriant vegetation around a tropical swamp, and from the abundant marine plants in the lagoon itself, would realise the conditions of artificial nitre-beds, substituting only soda carbonate for the potash carbonate there used.

In seeking for nitrate of soda, the searchers always look to the rising edge of such salt-basins, and further judge of the probability of finding the nitrate from a peculiar moist or clammy state of the ground, which is due to the presence of the calcium chloride produced by the decomposition above explained.

The mineral containing saltpetre is called "caliche." Caliche generally lies at depths of 3 to 30 ft. below the surface, and sometimes resembles in appearance loaf sugar, and at others rock sulphur; and again it appears white, crossed with bluish veins. Its sp. gr. varies from that of common salt to sandstone (2.41 average), according to the amount and nature of earthy matters it may be allied with. The valuable mineral is found beneath a covering of calcareous earth, generally assuming the appearance of half-formed sandstone, when it is serviceable for building purposes. A shaft, or hole, sufficiently wide to permit of the passage of a man, is sunk through this cap as far as the under side of the caliche, at which point the underlying earth is dug out in a circle for several feet. The chamber thus formed is charged with gunpowder (manufactured in the district), and on being fired the result is to disengage and throw up to the surface the subterranean caliche, which is picked out by hand and stacked up in heaps at some convenient point, whence it is conveyed in carts, capable of holding about a couple of tons, to the "oficina," or manufactory. Considerable skill is required in selecting the points where to begin mining operations, and it frequently occurs that large sums of money are paid for lands which on being worked prove to be worthless, either on account of the scarcity of the caliche, its bad quality, or its great depth beneath the surface. These losses are sustained on account of the difficulty sometimes experienced in obtaining labour and tools in a country so inhospitable in its resources, and possessing no real indigenous population.

The caliche lies in beds varying from 6 in. to 12 ft. thick. No caliche bed is found nearer to the sea coast than 15 miles, and the farthest beds are distant 90 miles. The Ramirez caliche is plentiful and easy of extraction; it contains 51 per cent. nitrate of soda, 26 common salt, 6 sulphate of soda, 3 sulphate of magnesia, and 14 insoluble.

At the oficina the caliche is broken by hand or by jaw breaker into cubes that will pass a $1\frac{1}{2}$ in. ring. Thence it goes to the boiling pans, which, in all factories under European management, are steam-heated.

Great diversity of opinion exists among saltpetre manufacturers upon the most economical form of "cachucha" or boiling-pan. Some

advocate the closed cachucha, which in every respect may be compared to a steam chest, because they maintain that, the steam being enclosed, there is no waste of heat, and consequently an economy is effected in coal. Their opponents assert that the steam in the cachucha condenses, and thereby weakens the solution, and that it prevents a most important operation—the stirring-up of the matter during the boiling. On the other hand, the open cachucha allows the steam which has passed through the caliche, and done its duty, to escape into the air, and enables the attendants, during the entire boiling, to constantly turn over the caliche, thereby enabling the heat to penetrate into every crevice of the mass. The result is to extract more nitrate from the caliche, and less is thrown away in the ripia or refuse; hence, by this latter system, an economy is effected in caliche, which more than balances the extra consumption of fuel.

In the closed cachucha the caliche is first placed in boxes made of perforated iron plating, which are mounted on wheels, and are pushed along a tramway into the cachucha. To overcome the difficulty of stirring up the mass, boxes have been made of a circular shape, and capable of revolving on their standards when locked to an axle worked by a wheel on the outside. This plan, however, proved a failure, on account of the accumulation of insoluble matter at the bottom of the cachucha, which completely wedged in the boxes, and the attempt to give the latter a rotary motion could only have been done at the risk of breaking the couplings and damaging the boxes themselves. This plan might be carried out by making the plant stronger, and by allowing adequate space for the insoluble matter which escapes from the boxes; but then that would be objectionable, on account of the large steam space it would afford in the cachucha, and the consequent impoverishment of the solution through the condensation of the steam.

There are other forms, known as egg-shaped cachuchas, owing to their similarity in form to an egg placed on its smaller end. These offer great facilities in the operation of charging and discharging the material. The caliche is conducted over a road to their upper part, and shot down. After being boiled, the solution is tapped, and the refuse is allowed to fall into trucks placed beneath, which convey it to the spoil bank. The chief disadvantage of these cachuchas consists in the necessity of having at command considerable height for the approach road.

An ideal English factory is the Ramirez, Northern Chili, built by Robert Harvey, with a productive capacity of over 6000 tons a month. The plant comprises 6 steel boilers, 12 boiling tanks, 90 crystallising tanks, a 5-compartment washing tank, 3 large circular tanks, and 3 crushing machines, as well as locomotives and rolling stock. Owing to the salt and other solvents contained in the soil, great care was bestowed in preparing the foundations for the carrying walls. The caliche is extracted according to Shanks's lixiviating system, and when the solution is at 110° Tw. it is allowed to settle for a short time, and then is run off to the crystallisation tanks at a temperature of 240° F. The crystallised nitrate, after the mother liquor has drained away, is transferred to drying floors, where it becomes perfectly dry in the tropical sun, and it is then filled into sacks for

export. The cost of the machinery, plant, and construction amounted to 110,000*l.*

The total exports amount to about 1,000,000 tons per annum—90 per cent. to Europe, and 10 per cent. to the United States; the value fluctuates somewhat, but averages about 9*l.* a ton. Its principal consumption is as a fertiliser and in sulphuric acid manufacture.

Potash nitrate.—True saltpetre is nitrate of potash, and is found chiefly in India.

The generally accepted conditions necessary for the formation of saltpetre are (1) the presence of decaying organic matter, whose decomposition affords a supply of nitrogen; (2) access of atmospheric air to oxidise the nitrogen into nitric acid; (3) sufficient potash in an available form (such as wood ashes or decomposed felspathic rocks) for the nitric acid to combine with as fast as it is liberated. Given these conditions, the formation of the salt will take place in very varied situations, being most commonly observed in countries where a tropical climate favours the decomposition of organic matters.

In the neighbourhood of Ak Serai and in other localities in Asia Minor, saline efflorescences occur in considerable quantity, usually associated with recent volcanic phenomena, and afford saltpetre which is employed in the local gunpowder factories.

Turning to India, we find that some saltpetre is obtained from the slimy mud deposited by the River Ganges during the flood season. Analysis of a nitrous earth from Tirhût, in Bengal, gave 8·3 per cent. of potassium nitrate, and 3·7 of calcium nitrate, or 12 per cent. of total nitrates. The soil around old buildings in the Punjab is very productive of nitre, which appears as an efflorescence, not to be confounded with the sodium sulphate crust occurring on the *reh*, or barren lands. The deposit is scraped up as often as it is renewed, and submitted to simple treatment for the separation of the nitre from the accompanying dirt by the agency of water and filtration. A small spade is used in collecting the earth, which is taken off to a depth of 1 to 2 in. and piled in heaps 2 to 4 ft. high, where it is left without taking harm till an opportunity arises for transporting it to a spot where water and fuel are available. In the upper part of the Punjab, the extraction process is conducted in a series of wide-mouthed earthen pots, with an aperture in the base, supported on earthenware stands, so as to admit of placing cups beneath the pots. On the bottom of each pot is spread a bed of straw, covered with a layer of wood ashes; above this, the nitrous earth is added till it reaches nearly to the top of the pot. Then water is applied till all soluble salts contained in the earth have been dissolved and carried in solution into the cups below. The straw bed acts mechanically as a filter to hold back insoluble matters; the wood ashes act chemically, affording potash in an available form, so that any calcium nitrate present may be converted into potassium nitrate, the nitric acid in the calcium nitrate exchanging bases with the carbonic acid united to the potash in the wood ashes. The very weak nitrous solution thus obtained is used instead of fresh water for washing through the contents of another series of pots, and thus becomes gradually charged with saltpetre to the extent of 2 or 3 per cent.

The next process is the removal of the water and crystallisation of the salt. This is conducted in elliptical iron dishes, measuring 1 or 2 ft. across and 6 to 9 in. deep, heated from beneath; as evaporation proceeds, fresh liquor is added, during a period of 12 to 18 hours. The scum which rises is skimmed off, and at a certain point of concentration the crude potassium nitrate, with accompanying saline impurities, is abundantly precipitated. This product in some districts is termed *dhouah*, and contains 45 to 70 per cent. of potassium nitrate. The small pans used in the Upper Punjaub give 8 to 16 lb. of crude nitre per shift of 30 to 36 hours. Over 4000 pans are kept working in the Punjaub. In addition, there are over a dozen large shallow basins, called *agar*, where sun-heat is utilised for evaporation.

In the different districts, slight modifications of the process described above are in vogue. Thus, in Mooltan, the liquor, after 20 to 24 hours boiling, is often run into a vat to cool for a night, and next morning the crystals are raked out and washed in a woollen cloth, being then tied up in it, and exposed to the sun till the moisture has been dissipated. Sometimes the filter is made on the ground in an inclined situation, being formed with mud walls lined with stiff clay on three sides, the remaining side being left open for escape of the liquid, but provided with reeds or closely-woven grass mats, with or without a bamboo false bottom; the liquid passes into a reservoir made of pukka masonry. In Guzerat, the nitrous solution is passed through a cloth filter; it is evaporated to about one-fourth its bulk, and on cooling affords an impure crystalline product (*dhouah*) worth about 8s. per cwt.). When re-dissolved, filtered, and re-crystallised, forming *kalmeel*, it is worth 22s. The following table of the average cost per ton of Indian saltpetre is instructive:—

Prime cost of crude material at the factory	£	s.	d.
Salaries, bags, packing, &c.	4	2	0
Freights and expenses from factory to Bombay	1	14	2
Interest on outlay at 9 per cent.	5	17	3
Government licence	0	13	8
Insurance at 7 per cent.	0	2	7
			0 17 1
			<hr/>
Profit per ton	13	6	9
			<hr/>
Selling price at a brisk demand at Bombay	14	7	0

Indian exports of saltpetre reach something like 25,000 tons annually, with a value of over half a million sterling.

Nitrates of potash and lime are of frequent occurrence in Ceylon. Some 30 places might be enumerated where saltpetre is produced and has been prepared for market. The formation of the mineral is apparently confined to caves in dolomitic rocks, the felspar in which contributes the potash base.

An analysis of the most productive nitre rock near Doomberra, in an unfrequented cave, showed 2·4 per cent. potassium nitrate, and 0·7 per cent. of magnesium nitrate. The nitre earth from the great cave in Lower Ouva, near Wellaway, yields 3·5 per cent. of calcium

nitrate, and 3·3 of potassium nitrate. The nitre crop is harvested during 6 months of the year by chipping off the incrustated portions of the walls of the caverns; the fragments are reduced to powder, mixed with an equal portion of wood ashes, and dosed with water. The potassium nitrate present, as well as that produced from other nitrates by the action of the wood ashes, is dissolved by the water, and the solution is evaporated first in pits exposed to the sun's rays, and then to the crystallising point in fire-heated pans.

In the government of Rudokh, Thibet, saltpetre is obtained by digging up the soil, which is put into brass vessels, and treated with hot water. The solution thus formed is decanted into another vessel, and there allowed to cool, that the nitre may crystallise out. By the crude native method, one man can prepare a sheep load (say 20 lb.) in 3 weeks.

Saltpetre abounds in Eastern Turkestan, especially in the hills beyond Karshi (Neksheb), a large town 91 miles south-east of Bokhara. Here, previous to 1875, the Emir had a large powder factory. Other factories existed in Khokan.

On the Rio das Velhas, Brazil, saltpetre is found in quantities at the south-eastern side of the Serrote, in a series of caves. The process of extracting the nitre from the chocolate-coloured earth is one of lixiviation. The earth is put into a bangué or strainer, generally consisting of a square pyramid of boarding, with the base upwards. The poorer people use a hide, supported on four uprights. When exhausted with hot water, the nitrous particles find their way, duly filtered, through a tube leading to a *coche*, or trough, often a bit of old canoe. The *decoada*, as it is now called, is a thin greenish liquid, which must be boiled in a *tacho*, or metal pan, like that used for sugar. This *tacho* is sometimes mounted upon an ant-hill. The nitre is purified by repeating the process, and assumes a yellowish-white colour.

Potassium nitrate possesses a quality which distinguishes it from sodium nitrate, and gives it a greater value, viz., that it is notably less liable to deliquescence in the presence of a moist atmosphere. Its chief use is in the manufacture of gunpowder and fireworks.

SODA.

“ALKALI LANDS,” “alkali dust,” “alkali water,” are familiar terms indicating the presence of various sodium salts (bicarbonate, carbonate, chloride, and sulphate), as incrustations or in solution, and generally condemned as unmitigated evils by the agriculturist, but representing considerable mineral wealth when properly utilised.

Most prominent are the deserts and “sinks” (undrained lakes) of the Great Basin of Western America. Here the salts are mixtures in varying proportions of carbonate, chloride, and sulphate, carbonate generally predominating on the Western side, chloride in the centre (Great Salt Lake), and sulphate on the Eastern side. Dr. T. M. Chatard* has made an interesting estimate of the carbonate of soda contained in only three of the alkaline lakes, based on his analyses of the waters of these lakes, which give the following results stated in grams to the liter:—

	Albert Lake.	Mono Lake.	Owens Lake.
SiO ₂	·232	·0700	·220
K	·538	·9614	1·644
Na	14·690	19·6853	28·500
Ca	·0200	·014
Mg	·0551	·005
Fe ₂ O ₃	} ·0030 {	·014
Al ₂ O ₃		·024
SO ₄	·706	6·6720	7·505
CO ₃	9·486	13·6903	19·398
B ₄ O ₇	·1600	·367
Cl	13·462	12·1036	19·344
H (in NaHCO ₃)	·058	·0522	·063
	<u>39·172</u>	<u>53·4729</u>	<u>77·098</u>

If we unite these constituents into the combinations in which, for all practical purposes, they exist in the water, we shall get these figures:—

	Albert.	Mono.	Owens.
Silica (SiO ₂)	·232	·0700	·220
Iron and alumina (Al ₂ Fe ₂ O ₃)	·0030	·038
Calcium carbonate (CaCO ₃)	·0500	} ·055
Magnesium carbonate (MgCO ₃)	·1928	
Sodium borate (Na ₄ B ₄ O ₇)	·2071	·475
Potassium chloride (KCl)	1·027	1·8365	3·137
Sodium chloride (NaCl)	21·380	18·5033	29·415
Sodium sulphate (Na ₂ SO ₄)	1·050	9·8690	11·080
Sodium carbonate (Na ₂ CO ₃)	10·611	18·3556	26·963
Sodium bicarbonate (NaHCO ₃)	4·872	4·3856	5·715
	<u>39·172</u>	<u>53·4729</u>	<u>77·098</u>

* ‘Mineral Industry,’ i. 421.

If we take the cub. ft. = 28.32 lit., the lb. = 453.6 grm., the acre-foot = 43,560 cub. ft., and the areas and depths of the lakes, we shall get for the amount of sodium carbonate and bicarbonate in these three lakes alone the following surprising figures:—

	Area and Depth.	Na ₂ CO ₃ .	NaHCO ₃ .
	acre-feet	tons	tons
Albert Lake	256,000	3,428,352	1,560,000
Mono Lake	3,264,000	75,072,000	17,936,000
Owens Lake	1,088,000	39,875,200	8,431,000
		<u>118,375,552</u>	<u>27,927,000</u>

These are but three localities. They are the largest, but there are many others. Of these the best known are the two lakes at Ragtown, Nevada, from which alkaline carbonates have been extracted for many years, as is also the case in Long Valley, California. Many of the smaller occurrences are near existing main lines of transportation, and can be made feeders to centrally located refining works. The refining cost at such works must be less, and it should cost no more to produce the crude material at small places than at larger ones. The difference is the increased cost of transportation to the refinery.

All the alkali on the western side of the Great Basin contains sodium carbonate and bicarbonate, and it is upon their property to form a compound more soluble than the bicarbonate but less so than the carbonate that the method of extraction is founded. If we have a solution of the two salts, with or without sulphate or chloride, and expose it to spontaneous evaporation, we shall, at a certain degree of concentration, get a crop of acicular crystals which have the following composition:—

	Per cent.		Per cent.
Soda (Na ₂ O)	41.15	or Sodium carbonate (Na ₂ CO ₃) ..	46.90
Carbonic acid (CO ₂) ..	38.94	„ Sodium bicarbonate (NaHCO ₃) ..	37.17
Water (H ₂ O)	19.91	„ Water (H ₂ O)	15.93

From this we derive the formula Na₂CO₃+NaHCO₃+2H₂O, which has long been known under the mineral name of “urao,” or “summer soda,” its name at Ragtown.

The amount of this salt thus obtained will depend upon the proportion of bicarbonate present, as every 37.17 parts will in crystallising take with it 46.9 parts of Na₂CO₃. If more than sufficient bicarbonate was originally present, the excess will crystallise out before any “summer soda” forms. If too little is present, the excess of carbonate remains in solution.

On evaporating a sample of water from any of the lakes, at a certain concentration point (sp. gr. 1.260 for Owens Lake water) crystallisation will begin. The crystals are crude summer soda. Owing to the presence of so much sulphate and chloride in the solution, the crop becomes more and more contaminated with these salts as the concentration proceeds. Hence to obtain an article of a

fair degree of purity the process must be interrupted at some definite degree of specific gravity, and the mother liquor be drawn off. If the mother liquor be further evaporated, successive crops can be obtained, the earlier ones, in the case of Owens Lake, being principally sulphate, and the later ones chloride; while finally we get a mother liquor rich in potash salts, from which, on cooling to a low temperature, the ordinary "soda crystal" ($\text{Na}_2\text{CO}_3 + 10\text{H}_2\text{O}$) is deposited.

While all these localities can produce summer soda in the manner described, none has enough bicarbonate in its water to give the largest possible yield. It is necessary to increase the proportion of bicarbonate, which can be done in several ways, but most economically, perhaps, by utilising the carbonic acid given off in the process of furnacing the summer soda. This, when heated to a moderate degree, loses its water and excess of carbonic acid, 100 parts yielding 70.35 parts "ash," 9.74 parts gas, and 19.91 parts water. This furnacing must be done in any event to reduce weight and save transportation charges; hence, if the gas can be economically used, there is a clear gain.

At present all the product is shipped in its crude condition to borax works in the vicinity, where it meets with a ready sale at remunerative prices. The present annual output is given as some 2500 tons, while the Ragtown works produce about 800 tons. The cost is sufficiently low to warrant the assertion that there are several places at which ash of very satisfactory quality can be made at a cost not exceeding 1*l.* per ton.

The manufacture of high-grade soda-ash and other products from the natural material divides itself into two stages, each perfectly distinct from the other.

1. Field work, including vat construction and arrangement, pumping and handling of the original solutions and the mother liquors, control of the crystallisation process, gathering of the summer soda, and transportation of it to the refinery.

2. Refining work, in which the summer soda is put into various marketable forms and delivered to the consumer.

The field work is dependent for its conduct and economy on climatic conditions. These, while most favourable for evaporation and crystallisation, produce a scarcity and consequent high cost of manual labour. The amount of this must therefore be reduced to a minimum and be supplemented by machinery. The use of the latter, when steam driven, is limited by the fuel cost, which will always be high. Windmills can be used for pumping, and simplicity of arrangement and various mechanical devices can greatly increase the efficiency of the workmen, particularly in gathering the crop. If in a large plant the vats are properly arranged, accurate control will be made easier and the transportation cost reduced to a minimum by the use of light railways.

The field work can be done on a large or a small scale with probably equal advantage. At the Little Lake at Ragtown in 1886 two men made 300 tons, and could have done much more had the conditions of the locality permitted it. The product of the Big Lake, made

under very adverse conditions, required but little more labour in proportion. The entire product is hauled 16 miles to the railroad and shipped to San Francisco, where it is refined.

Furnacing before shipping to the refinery is not always advantageous. True, the reduction in weight is about 25 per cent., but the saving in transportation will rarely pay for the cost of furnacing when this is done on a small scale. Moreover, refiners will prefer unfurnaced material, and by devoting attention exclusively to the production of summer soda, regularity in composition, which is very important, can be better assured.

During the dry season, the surface of the land in many parts of North China is covered with a white incrustation of salts, called *chien* by the natives, which easily dissolves in water, and therefore disappears during the rainy season. A sample collected in the neighbourhood of Peking, a few *li* to the south-west of the city, contained:—

	Per cent.
Chloride of sodium (common salt)	23·8
Carbonate of sodium (soda)	12·4
Sulphate of sodium (Glauber's salts)	63·8
	100·0

Large quantities of these salts may be obtained by having the ground swept with a broom and lixiviating the sweepings with warm water. Over a third of the material thus collected proves to be soluble matter. It may be separated from the solid residue either by filtering or by siphoning the supernatant liquor and evaporating the saline solution, which shows a strong alkaline reaction on account of the carbonate of sodium contained in it. When sufficiently concentrated, the liquid, on cooling, deposits a large mass of crystalline matter, which mostly consists of sodium sulphate, a part of it, together with the sodium carbonate and chloride remaining in the mother liquor. The latter, on being evaporated, yields a brownish looking substance—the colour being due to organic matter—which, on being treated with vinegar, shows a brisk effervescence. It is to all intents and purposes the same substance as the one called *tzu-chien* by the Chinese, which is an impure carbonate of soda extensively used in dye works. Not only does it serve for the cleansing of textile fabrics, but, owing to its large amount of sodium sulphate, is also used as a mordant, for instance, in colouring cotton cloth with a solution of indigo, &c.

Colour.	Water.	Carb. Soda.	Chloride Sodium.	Sulphate Sodium.	Eng. Com.
K'ou-chien (from Kalgan)—	per cent.	per cent.	per cent.		deg.
1. P'ien chien, yellowish, white ..	45·61	53·00	1·33	traces	31·41
Hsi-k'ou chien (from Shansi)—					
2. Pai chien, white	52·60	45·71	1·07	traces	27·09
3. Tzu chien, first quality, dirty yellow	28·65	41·61	6·29	23·46	24·66
4. Do. second quality, brown	17·30	33·13	18·14	31·27	19·19

Judging from the above, there appears to be an abundance of sodium sulphate in some parts of China which may become valuable

when, with the introduction of foreign industries, such as the manufacture of glass and soap, a greater demand is created.

The table below gives an analysis of each of the four kinds of soda distinguished in trade. The samples were obtained from one of the great depots outside the city. For comparison, the English commercial "degrees" have been added.

At present this substance is extensively used by the Chinese for cleaning purposes, taking the place of soap in foreign countries.



STONE.

THE term stone is here used generically and embraces such widely different substances as marbles, slates, lithographic stones, &c., which, though applied to divergent purposes, are yet similar in origin and mined much in the same manner.

Building Stones.—Perhaps at once the commonest and the most useful kinds of stone are those employed in construction. Geologically they cover a very wide range, and it may almost be said that no period is devoid of beds or deposits of mineral adapted to the mason's needs.

Of far greater importance than their geological horizon is the microscopic structure of stones to be used for building purposes, and great loss and disappointment have followed inattention to these features. But while incipient decay may thus be detected, it is not always safe to assume that because a rock contains a mineral that has already commenced to decompose, as shown by examination under the microscope, therefore this stone is valueless. Occasionally microscopic slides of sandstones will show that the felspar has commenced to kaolinise, but that the decay has been arrested. The decomposition undoubtedly took place in such sandstones (of Triassic origin) previous to the degradation of the rocks which now compose them. When these were ground up, and their elements redistributed to form the sandstone, there seems to have been a cessation of the causes which produced the decomposition; this was arrested, and has not since advanced any further in the rock.

The characters which it is important to observe,* are whether the stone contains minerals which are either already decomposed, or are likely to become so; whether these minerals contain water in cavities in considerable quantities; or whether, either by disintegration or by the looseness of the binding material, the stone contains so many interstices or fissures that it is likely to absorb large amounts of water, which may either attack certain of the constituents, causing them to swell, or may itself, under the influence of a severe climate, have sufficient power, in the form of ice, to disintegrate the stone. The examination of the stone in the quarry should be conducted as a whole, and not with reference to a particular part of it, for it not unfrequently happens that stones composed of exactly the same minerals have entirely different properties, as granite and gneiss, for example, and yet one of them may not be a proper stone for outside construction. The age of the stone, since its extraction from the quarry, may or may not be in its favour. Nearly all stones are weaker immediately after their extraction, while they hold the quarry water, than after they have lost it. Most stones after long exposure, more

* T. Egleston, 'Building Stones.'

especially if they have not been uniformly moist, absorb more water than when they are fresh, and are therefore more likely to disintegrate from frost than when they were younger, or than if they were kept uniformly moist. Certain rocks, exposed to high heat or to severe cold, lose their power of resistance along irregular lines of weakness, and tend to disintegrate, and this effect may be produced by artificial heating as well as by climate. Stones, therefore, which endure exceedingly well in one climate may not stand in another. The particular places where the structure is to be erected, whether in the city or country, is to be considered. In the city there are noxious and corroding gases, coming either from fuels or manufactories; the dryness or dampness of the ground is to be considered, and whether the particular spot chosen is well ventilated or not; in the country, whether the air is humid or dry, or whether there are prevailing high winds carrying sand. All these, and many other circumstances, have great influence on the durability of building stones, and should be carefully considered before expensive structures are undertaken.

Building stones may be divided into three general classes: first, the different varieties of granite and granitic rocks; second, the marbles, which may have a coarse or granular structure, and may be either limestone or dolomite or serpentine; third, the sandstones, which may be composed of material having an organic, an argillaceous, a ferruginous, a calcareous or a silicious binding material. Slates are occasionally used in building, but not frequently. They are subject to peculiar forms of decomposition when they are used as roofing material, about which little need be said, because the decomposition which they would undergo in such very thin sheets would hardly take place when they are used in thick pieces in the construction of an ordinary building. Besides these stones, there are a few others which are sometimes used in the vicinity where they are found, such as various kinds of trap or basalt and serpentines; also steatites, and some other very soft rocks. Their use, however, is not common. Each of these stones is subject to its own particular kind of decay, which may be either chemical or mechanical.

All stones, and sandstones especially, contain, when freshly broken from the quarry bed, varying amounts of moisture, or quarry water, as it is technically called. If exposed to freezing while in this condition, they are, if not actually burst and ruined, at least rendered less tenacious. In many localities it is necessary to flood the quarries with water, or cover them with earth, on the approach of cold weather, to prevent serious damage from this cause.

Experiments made on a number of building stones after freezing and thawing 25 times, showed only six samples which possessed full resistance to such treatment; they included a dolerite, a diorite, and four sandstones. Resistance to fire and to water applied during great heat are every day becoming more important considerations in a building stone, and in these respects the volcanic rocks and the sandstones, when of homogeneous structure, are preferable.

Dolomite (the double carbonate of lime and magnesia), often called magnesian limestone, is of uncertain composition, rarely presenting the true proportions of 54.35 lime carbonate and 45.65 magnesia

carbonate. As a building stone its qualities vary exceedingly. A silicious variety is used with great success in the north of England, but the Houses of Parliament bear testimony to a total failure of another kind to withstand London air.

Limestone proper is well illustrated by the world-renowned Bath freestone, a famous warm-toned stone, which possesses the remarkable qualities of durability and easy working at the same time. The beds of Bath stone are contained in the formation known as the Great or Bath Oolite.

Although, in accordance with geological investigation and deductions, Bath stone should extend over a considerable area, this is found, in practice, not to be the case, the area being a tract about 30 miles long and 10 miles wide, extending to the east of Bath between Chippenham on the north and Trowbridge on the south. But even in this limited area the stone has only been found at a workable depth in certain localities, though innumerable bore holes and trial shafts have been put down to prove the ground. Moreover, the beds, though found almost horizontal where worked, vary greatly, within short distances, from one unbroken stratum averaging 7 ft. thick, to several strata measuring, together, 21 ft. The quality also differs in the several localities, which yield stone adapted to various usages.

The system of quarrying or mining here employed is described below. An average sample of the stone is of 2·2 sp. gr. when dry, 100 lb. of stone absorbing only 9 lb. of water; and in actual practice it will stand a pressure of 70 tons per sq. ft. without cracking. Analysis shows:—Carbonate of lime, 97·2; alumina and iron oxide, 1·6; silica, 1; magnesia carbonate, ·2. Its selling price is 11*d.* per cub. ft.

Marble is generally understood to be carbonate of lime, either white or coloured, uniform or variegated, and pleasing to the eye; the term is also applied to any coloured stone soft enough to easily cut, and hard enough to bear a good polish.

True marble is lime carbonate, composed of carbonic acid and the oxide of calcium, or lime, in the following proportions:—Carbonic acid, 44; lime, 56.

Of all the ornamental and decorative stones, the marbles are the most abundant and varied, and at the same time the most extensively employed. Any rock susceptible of a fine polish is termed "marble" by the stone-cutter; hence we hear of "Connemara marble," which is a true serpentine; and of "Sicilian marble," which is often a brecciated lava. The term, however, should be, and is, restricted by geologists to limestones capable of receiving a polish, and frequently exhibiting a variety of colours in veins and blotches. We have thus uni-coloured marbles, such as pure blacks and whites; and party-coloured sorts, deriving their tints from accidental minerals, from metallic oxides, giving them a veined or clouded appearance, or from shells, encrinites, corals, and other organisms which impart a variety of figure as well as of hue. Every country has its own peculiar marbles. These varieties are almost endless, but the following are a few of the better known and more esteemed varieties, ancient and modern. Carrara: pure white, saccharoid, and semi-transparent; highly esteemed for

statuary purposes; 98·1 per cent. lime carbonate. Parian: of a waxy cream-colour, also crystalline, and employed in statuary. Giallo antico: yellow, and mixed with a small proportion of iron hydrate; used for ornamental purposes. Sienna: rich yellowish-brown, with lighter veins and cloudings. Rosso antico: deep blood-red, less or more veined. Mandelato: light red, veined and clouded. Verde antique: cloudy green, mixed with serpentine, or serpentine itself. Cipolino: a mixture of talcose schist with white saccharoidal marble. Bardiglia: a bluish-grey variety, with bold black veins and cloudings. Lumachello or fire-marble: a dark-brown variety, having brilliant chatoyant reflections, which it owes to the nacreous matter of enclosed shells. Black marbles: like those of Derbyshire, Dent, and Kilkenny, deriving their dark colours from bitumen. Encrinal marbles: like those of Dent in Yorkshire and other Carboniferous districts, deriving their "figure" from the stems and joints of encrinites. Shell marbles: like those of Purbeck and Petworth in Dorset and Sussex, and Kingsbarns in Fife, receiving their "figure" from the component shells of univalves and bivalves. Nummulitic or Verona: creamy to nearly white. Phrygian or pavonazetta: creamy white ground, veined with dark red, pink, or yellow. Equal in beauty to any of the ancient marbles, and surpassing most of them, is the onyx now being mined in Mexico, New Mexico, and Arizona. It weighs about 200 lb. per cub. ft., and can be cut out in blocks of any desirable size, up to 20 ft. by 10 ft.; it is worth 50s. per cub. ft. at the quarries.

The mode of working the underground stone quarries near Bath, above alluded to, is somewhat peculiar, and is thus briefly described by Prof. C. Le Neve Foster.

The dip of the beds is slight, being only 1 in 33. The bed of stone which it is proposed to work is reached by an inclined plane, and then a main heading is driven out, 15 or 16 ft. wide, with "side holes" at right angles as wide as the roof or ceiling will admit with safety, say 20-24 ft., leaving pillars 10 ft. square and upwards. If rock is unsound, it is left as a pillar, and this may cause some irregularity in the plan of the mine.

The first process in removing the stone consists in excavating the "jad," a horizontal groove at the top of the bed, which is cut in for a depth of 5 ft. and width of 20-25 ft. The jad is cut out with a pick, which is not set quite at right angles to the hilt. This form enables the workman to cut right into the corners. The first pick weighs 7 lb., the second 6 lb., and the third 5 lb. This last has a hilt 5 ft. long, so that the man may cut the jad to a full depth. Projecting pieces of roof are broken down by the "jadding iron," a long bar. After the jad has been excavated with the pick, two vertical cuts are made with a saw, and a piece, called the "wrist," is wedged up from the bottom or off from the side. When the "wrist" has been removed, the blocks are simply cut out with saws. These saws are 6-8 ft. long, by 10-12 in. wide. The first saw used in the jad has to be narrower, and is called the "razor saw." The heaviest saw weighs 56 lb., and the handle can be used entirely below the eye when working near the roof.

When set free by sawing on all four sides, the block can easily be detached by wedges driven in along a plane of bedding. The blocks are lifted off by cranes, and either loaded at once on to trucks, or stacked inside the quarry, after having been roughly dressed with an axe or with a saw. A workman can saw 15 sq. ft. of the softest beds an hour. The men work in gangs, and the ganger is paid at a certain rate per cub. ft. of stone delivered on the trolleys at his crane. The men make from 20s. to 28s. a week; the ordinary hours are from 6 A.M. to 5 P.M., with two hours for meals. Good pickers cutting out the jad can earn as much as 1s. per hour while at work, but at this rate they will not work more than 5 or 6 hours a day. Owing to false bedding and other irregularities, a bed of stone 20 ft. thick will only yield on an average one-half of blocks fit for the market.

Ever since blasting has been used in quarrying, efforts have been made to direct the blast so as to save stock. Holes drilled by hand are seldom round. The shape of the bit and the irregular rotation while drilling usually produce a hole with a triangular section. It was observed, many years ago that, when a blast was fired in a hand drilled hole, the rock usually broke in three directions radiating from the points of the triangle in the hole. This led quarrymen to look for a means by which the hole might be shaped in accordance with a prescribed direction of cleavage.

A system used successfully for a number of years comprises the drilling of deep holes 10 to 12 in. diam., and charging them with explosives placed in a lune-shaped canister made of two pieces of sheet tin, with sections, minor segments of a circle, soldered together, and the ends filled with cloth or paper. Earth or sand is filled in around the canister in the drill-hole, so that the effects of the blasts are practically the same as though the hole was drilled in the shape of the canister. Straight and true breaks are made, although the system is expensive, as obviously a larger hole than necessary is drilled.

Another of the older systems of blasting is that known as lewising. Two or three holes are drilled close together on parallel, the partitions between being broken down. Thus a wide hole or groove is formed, into which the powder is charged by being rammed down, or in a tin canister the shape of the trench-hole. This system is confined almost entirely to granite. Then, again, there is the well-known plug and feather system, in which the plugs are driven between the feathers by the blast, and the rock is split. This process frequently results in irregular breaks and damage at the top of the hole.

By the Knox system a round hole is drilled by hand or otherwise, preferably by a machine drill, as it is important that the hole should indeed be round. In sandstone of medium hardness these holes may be situated 10, 12, or 15 ft. apart. Then the holes should be reamed out with an instrument made for that purpose, at least $1\frac{1}{2}$ times the diameter of the hole. This is done to the bottom of the hole. When finished, the hole resembles the shape of the canister. Then the hole is charged with the smallest possible amount of slow-acting powder; dynamite is unsuitable. The cap should be inserted near the bottom of the cartridge. Then the tamping is put in, not

directly upon the charge, as in most systems, but an air-space is left between. The tamping should be placed about 6 to 10 in. below the top of the hole, and placed securely so that it will not blow out. The intervening air-space may be filled with a wad of hay, grass, or paper. The hole is now ready to blast. If several holes are on a line they should be blasted simultaneously by electricity. The effect of the blast is to make a vertical seam connecting the holes, and the entire mass is sheared several inches or more. The explanation of the rationale of the blast is that the gas, acting equally in all directions from the centre, is forced into the two opposite wedge-shaped spaces by a force equally prompt and energetic. All rocks possess the property of elasticity to greater or less degree, and this principle being excited to the point of rupture at the apices of the section of the hole, the gas enters the crack and the rock is split in a straight line, simply because, under the circumstances, it cannot split in any other way. The form of hole is, therefore, almost identical in principle with the old canister system, save that it has the great advantage of a shaped groove in the rock, which serves as a starting-point for the break. It is also more economical than the canister, in that it requires less drilling, and the waste of stone is less.

The mountings for drills in quarry work are tripods, bars, gadder frames, &c. The tripod is the most useful and general form of mounting. Tripods are at the present time made with legs having universal joints, so that they adapt themselves to all the varying conditions of quarry work. It is possible to set up a rock drill mounted on a tripod on rock faces of most irregular form. Holes may be put in from a vertical position to a horizontal one.

But the tripod drill is applied less to dimension stone quarried nowadays than formerly. Quarry bars and gadder frames are now used to better advantage. In broken stone quarries where the surfaces are irregular, and where the quarrying is done by blasting, the tripod is the best form of mounting. No one would think of using anything else for a railroad cut, a rubble stone quarry, or for very deep hole work in granite quarrying. A modified form of mounting, known as the Lewis-hole tripod, has recently become very popular in the New England granite quarries. This is a regular tripod with a slot cut in its saddle by means of which the drill may be moved laterally and in a parallel line, thus putting in 3 holes close to each other without having to move the tripod. The partitions between these holes are sometimes broken down by a broach, and the holes charged with powder for blasting, thus making a break in a manner somewhat similar to that made in the Knox system.

The most useful mounting for a rock drill, next to the tripod, is a quarry bar. This is a horizontal bar made either of pipe or angle iron some 10 ft. long, with end pieces, which rest upon 4 legs. The drill is moved along the bar by means of a rack; thus a number of holes are put in exactly parallel with each other, and without moving the bar. The most popular use of the quarry bar is in sandstone quarries, where it has replaced the old system of digging a trench with a pick for releasing by means of wedges. Since the introduction of the quarry bar, drill holes have been put in, into which plugs and

feathers are inserted for breaking up. The plug and feather process being done by machinery is cheaper than wedging. Another advantage is, that when the splits are made the stone has not the same tendency to "run off." Plug and feather holes vary in depth from 3 in. to 10 ft. Shallow hole work is mostly confined to granite quarrying. Granite possesses a remarkable capacity to break on a true line, hence small holes of about the diameter and depth of one's finger are put in on a straight line, and by means of little plugs and feathers a force is exerted on this line which will break a block even to a depth of 6 ft., leaving a space as true as though it had been channelled.

In sandstone quarries plug and feather holes are usually put in 2 or 3 ft. deep for breaks of two or three times the depth of hole, but in almost every case the depth of a plug and feather hole must be regulated by the breaking capacity of the stone. It is sometimes necessary to run the hole entirely through the block in order to ensure a straight break. In the Tuckahoe marble quarries plug and feather holes are put in about 10 ft. in depth and only $\frac{5}{8}$ in. diam. It has been found necessary to drill entirely through the blocks to prevent "running off."

It is not necessary in every case to use plugs and feathers that are equal in length to the diameter of the hole, but it is sometimes advisable to drill deep holes in order to weaken the block and ensure a straight break. A system in common use in marble quarries is to drill plug and feather holes alternately 2 or 3 ft. in depth—that is, every other hole is a deep one.

Quarry bars are used for putting in bottom holes for "lofting" in the Indiana and Kentucky oolitic quarries. Small sizes known as the "Baby" are sufficient for this work. The largest bars are used in granite for broaching work, where holes are drilled about $\frac{3}{4}$ in. apart and to the full depth of the bed, the partitions separating the holes being afterwards broken down with a broach. This work requires a powerful drill, a strong bar and perfect alignment.

The size of rock drill best suited for the various conditions that exist in quarry work is of importance. The tendency is to get a power drill that is too small for the work. The quarryman wants a light machine. This question of lightness is frequently given more importance than it deserves. The early drills that were put on the rocks in the upper part of Manhattan Island, and which were the first steam drills that were mounted on tripods, were light, handy machines. The inventor evidently had his mind biassed by the opposition of the drill runner to a heavy machine, and in order to get anybody to use it, it was necessary to make it light.

It is a fact that the weights of percussive drills have been gradually increased during the last 15–20 years. That is, for the same kind of work a man to-day uses a heavier machine than was used for the same work years ago.

It is undoubtedly true that lightness is an important consideration in a power drill. It cannot be too light in weight so far as handling is concerned, but it may easily be so light that the work it does is so little in proportion to hand labour that it may hardly pay to use it.

The power of a percussive drill is in direct proportion to its diameter of cylinder. The size of the piston, like the arm of a man, is the gauge of strength. The steam or air pressure is usually uniform, varying from 60 to 80 lb. per sq. in., so that the question of pressure does not come in when figuring on the size of a drill best suited for the work. A rock drill of large diameter of piston strikes a hard blow and has strength to recover from a bad hole, while a drill of small piston diameter strikes a light blow and is easily "stuck" in the hole.

In broken stone quarries, or even in dimension stone where rock drills are mounted on bars, it pays to use big drills. Where holes are put in 15 to 25 ft. deep the diameter of the drill cylinder should never be less than $3\frac{1}{2}$ in. In hard rock, such as that of the Palisades on the Hudson, it pays to use drills of about $4\frac{1}{4}$ in. diam. of cylinder even for holes 15 ft. deep. This has been demonstrated to satisfaction.

Crimmins uses drills of $3\frac{1}{2}$ in. diam. of cylinder for rock work where holes are put in only 8 to 10 ft. deep, and he states that it pays to do so. It would be an easy matter to cite numerous instances of this kind, all of which prove that experience with power drills in rock work leads men to use drills of large size.

In hard rock, where the surface is irregular, it takes more time to put in a hole than it does to move the machine in position for another one. Let us assume that it takes 1 hour to drill a hole 10 ft. deep. There are not many places where an hour is consumed in moving the machine and getting started for another hole. This being true, we should evidently seek to get a machine that has as much power as possible, or in other words, that will drill a hole as rapidly as possible after once having been set up and started. We should rather sacrifice time due to moving a heavy weight than sacrifice time in drilling, because the drilling time is that which is longest.

There are other reasons in favour of large drills, such as power to work through bad places, freedom from breakage, &c.

In dimension stone quarries, where the drills are provided with bars or other forms of mounting by which they can be readily moved, it pays to use machines that are powerful enough to overcome sticking, and to strike a hard enough blow not only to drill the rock when the hole is clean, but to penetrate the mud and muck which is invariably at the bottom of a "down" hole.

The Ingersoll-Sergeant Drill Co. have taken a foremost position with stone quarrying machinery. A representation of their bar channeller at work is shown in Fig. 98. This machine will cut 1400 sq. ft. of channel per month, and to a depth of 10 ft., in stone of moderate hardness. It needs no blasting, and saves all the stone. Completely furnished, it weighs about 3200 lb., and costs 210*l*.

Slate.—The slate most in demand for roofing and other purposes is a clay-rock of great compactness and very fine grain. Originally it was a deposition from water in which it was held in suspension; and, although deposited in layers, it has, under the influence of heat and compression, experienced marked changes, one of the results being that it will not divide along the planes of its bedding, but splits readily on what are called "the planes of slaty cleavage." This facile

cleavage is the essential characteristic of good slate, as it enables the mass to be subdivided into thin sheets with perfectly smooth

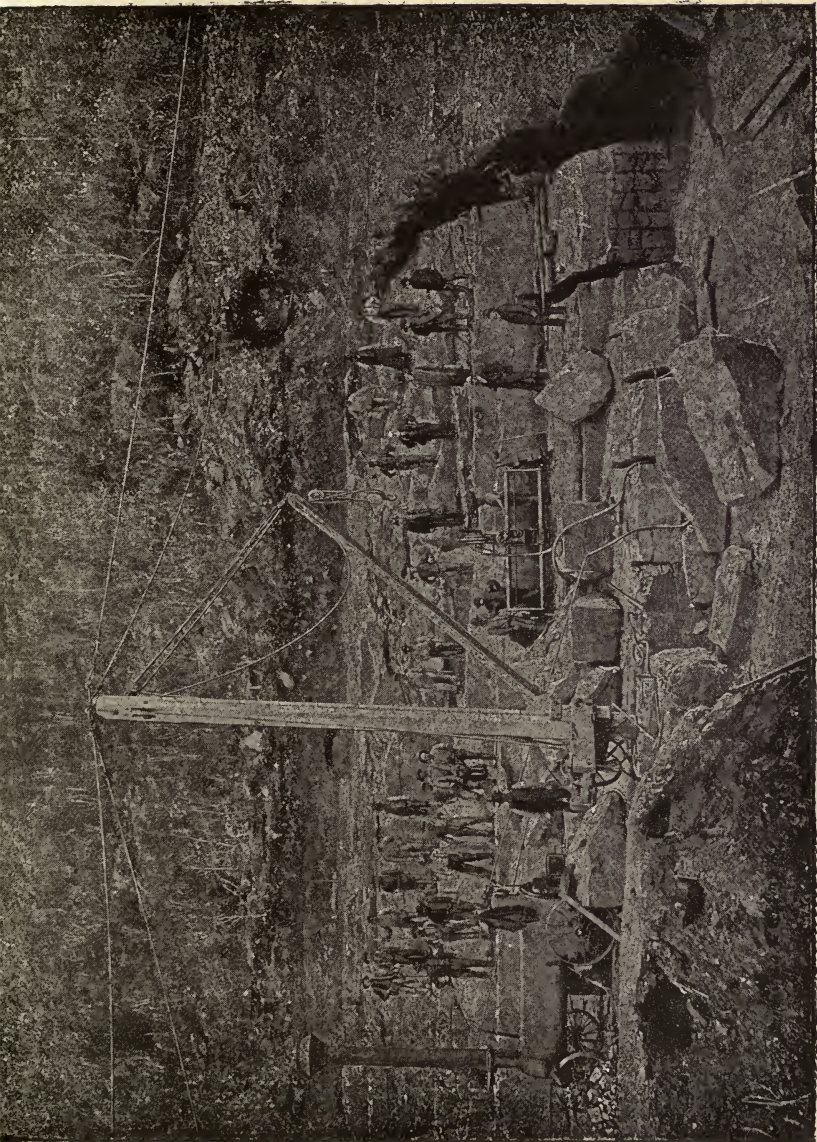

surface, and thus forms a comparatively light and impervious roof covering.

The essentials of the slate of commerce, such as is used for roofing, billiard beds, mantels, blackboards, tilings, urinals, caskets, grave covers, steps and risers, boxes, wainscoting, water tables, sills and lintels, trimmings for buildings, and many other purposes, are hardness and toughness.

When too soft, the stone will absorb moisture; the nail holes of the roofing slate become enlarged, the slates loosen, and require replacement; also, if too brittle, the slate breaks under the weight of a man. When a hole is punched, no tenderness in the material or tendency to enlargement of the opening should be seen. Struck with the knuckles, a good slate gives out a sharp, metallic ring. Colour is not a reliable guide in estimating the durability of a slate. Black varieties are not in favour; the general impression is that they have not the necessary durability. Dark blue, bluish black, purple, gray, and green are the common colours; some of the purple slates carry spots of light green, which, by the way, do not injure their durability, but the grade is lowered by lack of uniformity in colour.

In judging of the quality of a slate by the eye, a great deal of experience is required. The following tests are recommended:—

(1) Weigh the dry slate, then immerse in water for 24 hours; take out, wipe dry, and weigh again; the increase in weight will be the amount of water absorbed.

(2) Place the slate on its edge in water so that half the surface is covered; if it be of poor quality, moisture will creep by capillary attraction into that part of the slate above the water line, but it will not do so in a good slate.

(3) Breathe on the slate, and if a strongly marked argillaceous or clayey odour is detected, it is safe to assume the slate will disintegrate easily under atmospheric influences.

Dark veins running through the slate are objectionable, as they are liable to split along the line of least resistance—nearly always found to be in the course of this vein or streak.

Crystals of iron pyrites should also be suspected (particularly when present as marcasite or white iron pyrite), which oxidise very quickly when exposed to moisture and air.

The ordinary cubiform, brassy, yellow iron pyrites have much greater power of resistance to meteorological influences than the marcasite. They have been found in the atmosphere of Glasgow unaltered after an exposure of 100 years.

The behaviour of slates towards sudden changes of temperature has also been the subject of direct experimental examination. The quality in this respect may be estimated by first saturating the slate in water, by allowing it to remain immersed for some days, and then placing it in a mixture of salt and ice for 24 hours. Its behaviour on heating can also be ascertained by warming a sample at about 500° F. for 5–6 hours, and then suddenly plunging it into water. A rough approximation of the quality of a slate may be obtained by immersing the broken fragments in hydrochloric acid, when a bad quality will at once be recognised by the amount of carbonic acid gas evolved from the limestone present. By heating some chips in a glass tube closed at one end, a sublimate of yellow sulphur and a smell of sulphurous acid will be observed in most inferior kinds of roofing slate.

The tenacity of slate and its power of resisting pressure is very great; on an average it takes 20,000 lb. weight to crush 1 cub. in. of slate; hence its adaptability in thin plates for roofing purposes. The composition of blue Welsh roofing slate (Prof. Hull) is as follows:—Silica, 60·50; alumina, 19·70; iron protoxide, 7·83; lime, 1·12; magnesia, 2·20; potash, 3·18; soda, 2·20; water, 3·30.

That of purple slate (Kerwan) is:—Silica, 48·0; argillaceous matter, 26·0; magnesia, 8·0; lime, 4·0; Iron (Fe_2O_3), 14·0.

The composition of green Westmoreland slate is:—Silica, 55·8; alumina, 25·7; ferrous oxide, 9·5; ferric oxide, 0·3; lime, 4·4; carbonic acid, 3·2; hygroscopic water, 0·2; potash and soda, 0·4; copper, traces.

Blue Westmoreland slate is composed as follows:—Silica, 59·3; alumina, 17·5; ferrous oxide, 3·8; ferric oxide, 2·3; lime, 5·0; carbonic acid, 2·4; sulphuric acid, 3·3; moisture, 0·3; combined water, 5·7; potash and soda, 0·2; magnesia, traces.

Some very practical hints on opening a slate quarry to a given production were published in a paper read before the British Society of Mining Students, from which the following notes are condensed.

The estimate is based on an open quarry to the extent of 6 "bargains," reckoned to produce about 180 tons of slate per month, and developed by an adit.

In front of the slate bed is a layer of hard rock (porphyry) about 40 yd. thick, and as the slate rock on the surface or outcrop to the depth of 5 or 6 yd. is unproductive, it will be necessary to commence the level low enough to allow a depth of at least 20 yd. at the fore-breast. The 5 or 6 yd. bad rock on the top can be removed by means of an open cutting on the top, thus making considerable saving in the distance of transit.

Having cut through the hard rock into slate, the level might be continued a few yards farther, if thought necessary, to prove the rock, although this has, to a certain extent, been done in removing the top rock. The next step is to open communications between the end of tunnel and top floor, by sinking down from that floor, and by opening up from end of tunnel simultaneously. The average dimensions of a slate "bargain" is about 10 yd. wide by 15 yd. high, and as it is intended to develop the quarry to the extent of 6 bargains, we shall require a clear face of 30 yd. right and left of the tunnel. First cut a space sufficiently wide to allow one bargain to work. This cutting is usually done by miners, but after the first bargain has got to work, and more space is available, another staff of men may now be set to work to follow set number one; the miners are no longer required, as the quarrymen themselves, with a little extra price for a month or two, will open their own quarry. The same order is repeated until the six bargains are in full work.

The top floor being in full working order, and the rock turning out satisfactorily, thus encouraging further development, another gallery may now be formed by bringing another tunnel, care being taken to start low enough, in order to attain a good height of slate at the fore-breast.

The width of the galleries ought to be at least 15 yd., more if

possible; if they are narrow, serious consequences may result from falls of rock rolling over into the gallery below.

The cost of developing the quarry just described may be estimated as follows:—

	£	s.	d.
Clearing top rock for No. 1 gallery, 60 yd. × 12 × 6 deep = 4320 cub. yd. = 8640 tons at 9 <i>d.</i> per ton	324	0	0
Driving level 7 ft. × 6 ft., 40 yd. long at 2 <i>l.</i> 10 <i>s.</i>	100	0	0
Sinking shaft, 15 yd. deep × 8 ft. × 6 ft. at 6 <i>l.</i> 10 <i>s.</i>	97	10	0
Opening face on rock 30 ft. × 45 ft. × 4 ft. = 66 cub. yd. at 5 <i>s.</i> per yard	16	10	0

The necessary plant to work the quarry would be as follows:—

6 tons 14-lb. steel rails at 6 <i>l.</i> 10 <i>s.</i> per ton	39	0	0
Sleepers, 500 at 10 <i>d.</i> each	20	16	8
Brobs and nails	3	0	0
20 tram wagons at 7 <i>l.</i>	140	0	0
2 weigh machines and sheds, one for top floor and one for No. 1 gallery, at 20 <i>l.</i>	40	0	0
Powder house	20	0	0
Smith's shop and tools	80	0	0
Sundries	50	0	0
Management and sundry expenses, 2 years	300	0	0

£1230 16 8

837*l.* 10*s.* of this would be spent on the quarry, and remainder on plant and materials.

Taking 30 tons as the monthly production of each slate bargain, the quarry with six bargains would be equal to a monthly production of 180 tons.

When the slate bed crops up to the surface, and promises to be of good quality, the following method of opening out might be advantageously adopted, providing the hill slopes rapidly.

It will require a cutting 60 yd. wide. Of this, at first, a third may be taken, allowing two of the bargains to be working while the remaining two-thirds is being cut. Each bargain being 10 yd. wide, and the distance from the face of one gallery to the face of the next behind being, say, 15 yd., a space of 60 yd. × 15 yd. must be cleared for each gallery, and allowing for the slope of the hill, the rock to be removed would at least average a depth of 9 yd. Each subsequent gallery could be opened in the same manner, care being taken not to cover any good slate rock below with the debris from the gallery above. To avoid this an incline is sometimes made the full length of the quarry, by the aid of which all the good as well as the bad rock is conveyed to the bottom, and the bad rock deposited on unproductive ground. Care should be taken not to fix the incline so as to interfere with the extension of the quarry.

The cost may be estimated as follows:—

	£	s.	d.
Clearing top rock 15 yd. × 60 yd. × 9 yd. = 8100 cub. yd. = 16,200 tons at 9 <i>d.</i> per ton	607	10	0
Incline, with drum and buildings	200	0	0
Cost of plant, &c., as per particulars in estimate for previous quarry, say	400	0	0

£1207 10 0

The produce of this quarry would be equal to the other, viz. 180 tons per month.

Slate quarries are usually deep open cuttings, with sides as rude as imagination can paint. Those situated on hillsides are worked by means of tunnels; but there are quarries worked similar to a coal mine underground.

In the first place it is necessary to blast the rock down from the cliff side. The "docker-up" views the huge blocks, which by means of a hammer and chisel are reduced to more convenient sizes, loaded into trucks, and by means of a water balance or some other convenient arrangement, are hoisted out of the pit and delivered in front of the splitting sheds. The blocks have now reached their final destination previous to being made into slates.

Suppose a block 6 ft. long by 2 ft. wide. This is much too long for the largest slates that are required. To cut it into the most marketable size, making it into two blocks 3 ft. by 2 ft., a small aperture is cut in one side, and by means of a series of heavy blows on the other side, immediately above the aperture, with a large wooden mallet, the block is cut in two; it is now taken into the splitting sheds and there awaits further development at the hands of the splitter. In quarries where machinery is in use for sawing the blocks the mallet is not used.

Two methods of splitting are used in England, but only one in Wales, viz. the mallet and chisel, whereas in England they use both the "chisel" and "hammer."

The "chisel" man arranges his blocks along his left side, and after adjusting himself on a low seat, takes a block which he rests upon his left knee; by placing his chisel on the end of his block and striking it with his mallet, he is able to reduce a thick block into thin slates. The "hammer" man, unlike his colleague, does his work standing; he takes a block of slate and places it on a raised platform in front of him, erected for the purpose; he holds the block with one hand and the hammer in the other, the splitting of the block being accomplished by a series of gentle blows along the end.

The speed of splitting is regulated by the cleavage; when the cleavage is bad, the work of the splitter becomes very slow and tedious, the slates are heavy, rough, and of inferior quality. When the cleavage is good, the work is much more expeditiously done, the slates are more uniform in thickness, finer, and better.

The manner in which the Collyweston slates are made is somewhat novel. Large blocks are dug in the autumn, and being placed in a different position from that which they had in the quarry, the rain insinuates itself between the layers of the stone, and in frosty weather the water, swelling as it becomes ice, splits the block of stone into plates of a proper thickness. The dresser now takes the thin slabs in hand, and with his dressing knife and traverse cuts the slates to proper shape and sizes. To give an idea of the fineness to which good blocks can be split, it may be stated that a block $2\frac{1}{2}$ in. thick can be split into 40 slates measuring 20 in. \times 10 in.

Some queer technical terms are used in connection with slating. Names are used to indicate the sizes of slates. One 10 in. by 13 in.

is known as a "double." Smaller slates are called "small doubles." The next larger size are known as "plantations"; the next size is called "viscountess." Sizes ranging from 8 in. by 12 in. to 10 in. by 16 in. are called "ladies"; from 10 in. by 20 in. are called "countesses," up to 14 in. by 24 in., which are known as "princesses."

In American practice slates run simply by inches, from 7 in. by 14 in. up to 17 in. by 24 in. The thickness of slates ranges from $\cdot 125$ to $\cdot 3215$ in., and their weight varies from 2 lb. to $4\frac{1}{2}$ lb. per sq. ft. A square of slating is rated as any other roofing equal to 100 sq. ft.; the gauge is the distance between the courses, while lap is counted as the distance which each slate overlaps the slate lengthwise next below but one.

Lap varies from 2 in. to 4 in., and a standard lap is about 3 in. As above stated, a good slate roof should have about square pitch, but slates should never be put upon a roof which pitches less than 1 ft. in 4 ft. When it is desired to compute the surface of a slate when laid and the number of squares of slating, subtract the lap from the length of a slate which is taken as distance from nail-hole to tail, and one-half the remainder will give length of surface exposed; this when multiplied by width of slate will give the surface required.

To ascertain the number of slates required for a square, divide 14,400, which is the area of one square in inches, by the surface obtained above, and the quotient will give the number of slates required for one square. For an example, take a slate 12 in. by 24 in. taking a standard lap 3 in., the number required for a square will be found, by subtracting 3 from 24 = 21, and 21 divided by 2 = $10\frac{1}{2}$ in., which, multiplied by 12 = 126 in.; 14,400 the total area to be covered, divided by 126, which equals the area of one slate, gives 114 29-in. slates required for the square.

Slate weighs 165 lb. to 180 lb. per cub. ft., and, in consequence of lap, it requires an average of $2\frac{1}{2}$ sq. ft. of slate to make 1 ft. of slating. When slate $\cdot 125$ in. thick is laid on laths, it weighs 4.75 lb. per cub. ft.; when the same is laid on 1-in. boards, it weighs 6.75 lb. per cub. ft. Slate $\cdot 1875$ in. thick on laths and boards weighs 7 lb. and 9 lb. respectively. A $\cdot 25$ -in. slate weighs 9.15 lb. and 11.25 lb. respectively. The thickest kind, gauging $\cdot 3215$ in., weighs 11.15 lb. and 14.10 lb. on laths and boards.

A slate roof composed of 6-in. by 13-in. slate weighs 1680 lb. per square, and requires 480 slates. A 10-in. by 20-in. slating weighs 6720 lb., and requires 171 slates per square. A 12-in. by 24-in. slating requires 125 slates, and weighs 4480 lb.

The output of slate in the United Kingdom reaches nearly half a million tons a year, with a value of about 50s. a ton.

Millstones.—Stones adapted for the making of mills for grinding grain, seeds, cements, phosphates, pigments, and similar substances to a fine powder are of several kinds, embracing "grits" and "buhrs," which are sandstones of fresh-water origin, as well as certain quartzites (metamorphic), and lavas (volcanic). The qualities desired in such stones are hardness combined with toughness or cohesion, and sufficient porosity to give the grinding surface a good hold. As used in mills, the stones are built up from numerous pieces about 1 ft.

square, clamped with iron bands and backed with a concrete made from chips and fragments. The grinding face is dressed all over with grooves. European supplies come from the Silurian, carboniferous and old red sandstone grits of England, the metamorphic quartzites of Scotland and Norway, and, the best kinds, from the Tertiary sandstones of Seine et Marne, France, and the Tertiary lavas of the Rhine.

The flint and quartz conglomerate from which American millstones are made is found at different places along the Alleghany mountains. In Ulster county, New York, it is quarried under the name of "esopus stone;" in Lancaster county, Pennsylvania, it is known as "cocalico stone;" in Montgomery county, Virginia, it is called "Brush mountain stone," and in Moore county, North Carolina, it is found as "North Carolina grit."

Whetstones.—Much finer grain is required in a grindstone, but otherwise its qualities resemble those of the millstone series—hardness, toughness, and uniformity of texture. They may be all classed as sandstones, varying in fineness of grain. British supplies come largely from the coal measures, but also from the old red sandstone, the oolite, and the greensand beds. Kenton, Gosforth and Eighton Banks (near Newcastle), Wickersley, Haverley, and Congleton (in Yorkshire), Bilston (in Staffordshire), Craigleith (near Edinburgh), and many other places afford a useful article.

The still finer grained stones used as hones and oil-stones are more properly schists and slates of very close and compact texture, in which the silica is in an exceedingly fine state of subdivision. The best known "batts" for whetting scythes, &c., are obtained from the lower carboniferous sandstones of Lomond, Fifeshire, the millstone grit and ganister beds of the coal measures in Yorkshire, and the greensands of the Blackdown hills, Devonshire. The "rag-stones" of Scotland, Norway, and Russia are highly silicious mica schist, the last named being the softest. The most familiar of the European oil-stones are the "Charley Forester," a corruption of Charnley Forest, Leicestershire, the "Water of Ayr" or "snake-stone" of Ayrshire, the Welsh slate and the German novaculite from the slate hills around Ratisbon; but better than any of these are the "Turkey oil-stones" from Asia Minor. Much is also imported from the United States.

Of the important American supply of silicious rock used for sharpening edged tools, Arkansas, Indiana, and New Hampshire furnish the bulk; a small quantity is produced in Vermont. The Arkansas stone is found in the neighbourhood of Hot Springs, and is supposed to have been formed by the action of hot water upon the quartz formations. It is found in two varieties, known as "Arkansas" and "Washita" stone, the grains in the former being smaller and more compact, of a uniform bluish-white colour, and semi-transparent, while the Washita stone is more opaque, and of a pure white colour. In Indiana two varieties also occur, known commercially as "Hindustan" and "Orange" stone, the former being white in colour and the latter of a buff or orange tint. The quarries are all located in Orange county. The quarries in New Hampshire are

located in Grafton county, and the product consists of "rift sandstone" and "chocolate" whetstone. The Vermont quarries are located in Orleans county, and the product is used exclusively for scythe-stones. Some "Labrador" oilstones have in the past been produced at Manlius, Onondaga county, New York, but the factory is now used for the manufacture of oilstones from Arkansas and Washita stone. The output of the different kinds of sharpening stones in 1889 consisted of 456 tons of scythe-stone, 1500 tons of rift sandstone, 15 tons of orange stone, 500 tons of Washita oilstone, 80 tons of Arkansas oilstone, and 100 tons of Hindostan oilstone; total value about 6000*l*.

SULPHUR.

THE following remarks relate exclusively to native sulphur (brimstone). Though the amount of sulphur annually mined in the form of sulphides of various metals (e. g. iron and copper pyrites, galena, blende, &c.) probably far exceeds that obtained in the uncombined state, still, the separation of the sulphur in an unoxidised condition from such compounds is never attempted, for the simple reasons that, in the processes for extracting the several metals from their ores, the first step necessary is the elimination of the combined sulphur, which is most easily effected by a roasting or oxidising operation, whereby the sulphur is at once converted into sulphurous acid, itself a valuable commodity, and, moreover, capable of being readily oxidised one step further to form sulphuric acid, the chief purpose for which sulphur is consumed.

Italy and Sicily together furnish the greater part of the sulphur of commerce, the major portion coming from Sicily. As to the geological history of the sulphur beds of that island, it has been supposed that at the end of the Middle Miocene period the sulphur-bearing area was raised, and lakes were formed in which occurred the deposition of the sulphur rock and its accompanying gypsum, tripoli, and silicious limestone. The sulphur rock is composed of sulphur and marly limestone, the sulphur being sometimes disseminated through the limestone, and at others forming thin alternate layers with it. These sulphur-bearing seams are often separated by layers of black marl, 20 in. to 6 ft. thick, some seams attaining a thickness of 28 ft. The total aggregate thickness of the sulphur seams reaches 100 ft. in one case, but the average total is 10 to 12 ft. only. All the seams are decomposed at their outcrop, and show only an accumulation of whitish friable earth, called *briscale* by the miners, and mainly composed of gypsum. This has resulted from the oxidation of the sulphur to sulphuric acid by atmospheric agency, the acid in turn attacking the lime carbonate, and forming sulphate (gypsum). The most plausible supposition as to the origin of the sulphur seams would appear to be that the lakes received streams of water containing calcium sulphide in solution, this calcium sulphide probably resulting from a reduction of the masses of calcium sulphate (gypsum) by the action of volcanic heat. Gradual decomposition of the calcium sulphide in the presence of water would finally result in a deposition of sulphur and of lime carbonate, in the relative proportions of 24 and 76 per cent. As a matter of fact, much of the Sicilian ore actually has this percentage composition. Whatever the process has been, it is no longer in activity, and there is no growth nor renewal of the beds, in this respect differing essentially from recent deposits due to "living" solfataric action.

The sulphur country lies to the south of the Madonia chain of mountains, embracing nearly the entire provinces of Caltanissetta and Girgenti to the seaboard, and part of that of Catania; in addition to these, there is a group of mines in the south of the province of Palermo. The principal centres of this industry are at the mines of Caltanissetta, Castrogiovanni, Montedoro, San Cataldo, Serradifalco, Sommatino, Valguanera, and Villarosa, in the province of Caltanissetta; Aragona, Casteltermini, Cattolica, Cianciana, Comitini, Favara, Grotte, and Racalmuto in the province of Girgenti; and Lercava in that of Palermo. In very rich lands the veins do not average more than $6\frac{1}{2}$ to 27 ft. thick, with sterile strata, from a few inches to 3 ft. and over, intervening; while in those less productive, the sulphur seams lie separated by barren strata of much greater thickness. The rock containing the mineral is detached from the mass by the use of a sharp pointed pickaxe, weighing about 15 lb., and is brought to the mouth of the shaft, which is like an inclined plane running down the earth with steep steps roughly cut in the rock, forming, almost invariably, the only means of access to the works at the bottom of the mines. The ore is excavated by men, assisted by small gangs of boys working under them, who carry heavy pieces of the rock to the surface, as it is broken up by the miners, and deposit them in localities allotted to each pickman, where the ore is piled up in large heaps preparatory to its being measured, to ascertain the number of "cassa" excavated by each man. The "cassa" is the measure by which the quantity of sulphur ore dug in Sicilian mines is reckoned, when paying the miners for the labour; but it differs in dimensions in different mining districts of the island. The boys employed in transporting the mineral carry 40 to 60 lb., according to their ages, which range from 10 to 18 years, from pits often over 275 ft. deep, making 20 to 40 journeys a day. Water is frequently met with before reaching a seam of sulphur, and up to the present it has been one of the greatest obstacles in the way of mining engineering in Sicily, greatly increasing the cost of working. The depth of 190 ft. is rarely obtained without water oozing through imperceptible fissures in the rock, and this frequently stops all operations by submerging the works.

The richest portions of the deposits are usually found where the beds are arranged in curves, concave with reference to the overlying strata, which previously represented the deepest portion of the original lacustrine basins. Sudden changes, whether of dip or direction on the outcrop, are found as a rule to be accompanied with impoverishment of the deposits.

The total quantity of sulphur considered as likely to be contained in the deposits now known is about 65,000,000 tons, of which 8,353,091 tons were extracted between 1831 and 1885, or since the statistics of production have been kept, and probably about 2,000,000 tons more in times preceding the former date. As the loss in the reduction of the ore is about one-third, the above quantity of sulphur sold represents about 15,000,000 tons of material extracted, which leaves as the stock still to be wrought about 55,000,000 tons.

The exact figures of the statistical returns for the sulphur mines of Sicily in 1885 were as follows. Exclusive of the product of the

solfatarata of the volcano in Lipari, 377,132 tons of sulphur were extracted from 2,548,840 tons of rock, or an average yield of 14.79 per cent. The number of hands employed was 28,744, corresponding to a production of 88 $\frac{3}{4}$ tons of ore, and 13.12 tons of sulphur worth 43*l.* 10*s.* for each person engaged in the work.

The cost of production per ton is made up of the following items:—

Wages	s. d.
Other mining and reducing costs	28 11
	6 10
	<hr/>
Freight to seaboard, warehouse, and shipping charges ..	35 9
	16 0
	<hr/>
Cost per ton free on board	51 9

The annual exports of sulphur from Sicily are about 150,000 to 170,000 tons.

The sulphur workings at Swoszowice, near Cracow, are in the Jurassic formation. There are two layers of sulphur-yielding earth, each composed of a dark-grey marly clay, through which the sulphur is distributed in the form of concrete masses, varying in size from 1 in. diam. to no larger than poppy seed. These beds are separated by a vein of fibrous gypsum fluctating between 3 and 6 fathoms thick. The roof is of clay containing petrifications, and enclosing lumps of sulphur weighing as much as 3 $\frac{1}{2}$ lb. The total depth is about 30 fathoms. The sulphur yield averages 10 per cent. The smelting of the crude mineral is performed in gallery furnaces, the yield being approximately 6 $\frac{1}{2}$ per cent. For some years past the product has been consumed locally for making carbon bisulphide, which is largely employed as a phylloxera cure throughout the grape-growing districts of the Austrian empire.

Iceland has been prominently mentioned as a probable large producer of sulphur. Prof. Geikie has reported from actual measurements that there are in sight at the Krisuvik mines some 250,000 tons of sulphur earth (the term "ore" used by him seems liable to be misconstrued), having an average contents of 57 per cent. sulphur. No commercial success has apparently ever attended the various efforts to develop them, and in the opinion of the author, who spent many months attempting to work the Myvatn mines in N. Iceland, the conditions do not warrant financial venture.

Japan is exporting about 7000 tons of sulphur per annum, collected from the sides of an extinct volcano, and yielding about 50 per cent. of purity.

The most important deposits of brimstone in the United States are found in Utah, at Cove Creek, 22 miles from Beaver, while there are other deposits at a point about 12 miles south-west from Frisco.

The mines at Cove Creek are said to be in excellent condition for continuous production. A system of storage reservoirs, holding 2,000,000 gal. of water, has been put in, and 6-in. pipe laid about one mile, with a fall of 1000 ft., to carry the water to the sulphur beds, to use in hydraulicing the surface earth away. This will greatly reduce the cost of mining, since there is a large lot of earth overlying

the sulphur, which in the past had to be dug and carted away. As far as explored, the sulphur-bed extends at least 1800 ft. by 1000 ft., and the quantity of sulphur contained therein was estimated by Prof. von Rath, at a time when the bed was not as fully exposed as it now is, to be at least 1,300,000 tons. A curved cut has been made through the sulphur-bed near its western end, exposing a vertical wall of rich yellow sulphur, 34 ft. high. From this cut a track leads to the dump above the smelter, a short distance to the west. The sulphur extends up to the surface over part of the basin, but is mostly covered with sand or rather decomposed andesite, and is partly mixed with sand or gypsum. Most of it is of yellow colour, while some of it is dark grey, and is called "black sulphur." The output from these mines in 1891 was 1200 tons.

In Nevada, the Rabbit-hole Springs mines have been worked irregularly since 1880; but the excessive cost of production, transportation, &c., has brought the actual cost at consuming points so near the sale prices of imported sulphur as to limit mining to small amounts.

Large deposits of sulphur are known to exist in Wyoming, California, and Arizona, but none of them is at present available for working at a profit.

Extraction.—The separation of the sulphur from the various earthy matters with which it is naturally associated is effected by the following several means:—(1) Dry heat—roasting the ore in mass; (2) wet heat—melting out by the aid of aqueous solutions of salts, the salts being added to heighten the boiling point; (3) superheated steam; (4) chemical solvents. The great bulk of all the sulphur produced is extracted by apparatus belonging to the first class, and including the *calcarelle*, *calcarone*, and *doppione*.

Calcarelle.—The earliest system adopted in Sicily was the *calcarelle*. This consisted simply of a stack of ore, 6–15 ft. square, built in a ditch 3 or 4 in. deep, with the floor beaten hard and sloped to a single point, permitting the molten sulphur to flow out by an opening termed the *morto*. In building the stack, care was taken to put the largest pieces of ore at the bottom, selecting lumps of gradually diminishing size as the top was approached. The mass was ignited at the summit. The construction of the stack usually occupied two days; on the third day the sulphur escaped by the *morto*, and on the fourth the *calcarelle* was pulled down. The air necessary for the combustion of a portion of the sulphur (to afford the heat required to smelt the remainder), was freely admitted at all sides; only the mineral in the centre of the heap was heated without actual contact with the air, so that its sulphur was melted out instead of being burned (oxidised). Consequently about 6700 lb. sulphur mineral were needed to afford 385 lb. sulphur, or a yield of 5·7 per cent.; as the ore contained 35 per cent. sulphur, the consumption of sulphur as fuel was 1960 lb., in order to extract 385 lb. In addition, the immense volumes of sulphurous acid emitted from the stack caused a terrible destruction of the agricultural crops in the neighbourhood.

Calcarone.—Nearly all the sulphur prepared in Sicily is now extracted by the *calcarone* (or *calcherone*, as it may also be spelt).

This, as is shown in Figs. 99, 100, is formed by building a circular stone wall on an inclined sole. In front is the *morto* or outlet, having a height of 4 to 6 ft. and a width of 2 ft.; over it is erected a wooden shelter for the workman in charge. *Calcaroni* may contain 200–400 *casse* (each *cassa* being equivalent to about 6 tons, and giving 12–16 cwt. of sulphur). The durability of the *calcarone* is governed by the care exercised in its construction; 10 years is not an unusual period.



FIG. 99.—ORDINARY CALCARONE.

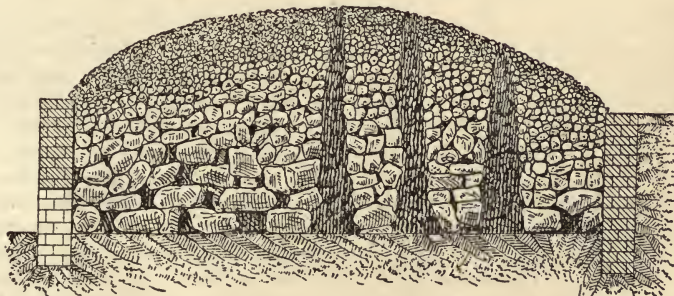

FIG. 100.—ORDINARY CALCARONE.

The charging of the *calcarone* is a matter of primary importance, as on it depends the yield of sulphur. The largest pieces of ore are selected for the first layer, leaving interstices between them; the size of the lumps gradually diminishes as the height increases, care being taken to form the walls of the *morto* with calcareous stones, so as to ensure a passage being maintained for the escape of the liquefied sulphur. In adding the finest portions on the top, narrow channels, about 2 ft. apart, are left for the draught to carry the heat down. The whole is covered with a layer of the refuse

from previous operations. This layer is more or less thick, according to the state of the weather, because the *calcarone* being built in the open air, variations of temperature and wind influence the progress of the operation; consequently means have to be adopted to prevent an undue access of air rendering the combustion too rapid. For instance, during a sirocco (local hot wind) there is danger of the sulphur contained in the ore lying at the side facing the wind being completely converted into sulphurous acid, and thus lost. The employment of a roofed shed would prevent much of the waste occasioned by climatic causes.

When the charging is completed, the *morto* is closed by a stone slab, and fire is communicated to the mass by means of little bunches of dried herbs, dipped in sulphur, which are thrust into the vertical channels before mentioned. Some 6 or 8 days afterwards, a hole is pierced in the top of the *morto*, by means of an iron rod; later, a second hole is made near the floor. By these two openings the sulphur escapes, and is collected in wooden buckets (*gravite*), shaped like a truncated cone, and holding about 1 cwt. of sulphur. These buckets cost over 2s., and serve only for 3 or 4 castings without wanting repairs. The outflow of sulphur lasts for 2 to 4 weeks. Commonly, the *calcarone* is left to itself when once the mass has been ignited, but then the loss of sulphur is much more serious. To ensure good results, many precautions have to be observed, mainly connected with the nice adjustment of the draught, so as to effect the maximum degree of fusion with a minimum of oxidation. When the operation is conducted during winter, the product is less abundant, and of inferior quality. After the charge is exhausted, a new one cannot be introduced till the mass has cooled down, occupying a period of 10 to 30 days, according to the size of the *calcarone*. The discharging has to be done slowly and cautiously, on account of the sulphurous fumes liberated. The consumption of sulphur (as fuel) in the heating is about 50 per cent. of the total amount contained in the ore. Thus, to obtain one ton of sulphur, there is consumed as fuel about another ton, worth, say, 5*l.* and performing a duty which could be much more satisfactorily accomplished by 2 cwt. of coal, costing, perhaps, 5s.

A great improvement in the Sicilian *calcarone* has been introduced by P. Le Neve Foster, and worked with good results, showing an increase of yield of 30 per cent. above the ordinary plan. According to his description, the waste heat from an ordinary *calcarone*, after all the sulphur has been run off, is utilised to heat to the required temperature the charge of ore placed in his kiln, and as soon as the moisture has been driven off and the heat is great enough, the charge is fired from the top. The combustion, fed with hot air containing some sulphurous acid gas, is very slow, hence the loss of sulphur by burning is less than when, as in the ordinary *calcarone*, the ore has to be heated entirely by the combustion of the sulphur. The apparatus, shown in Fig. 101 (prepared from a drawing kindly furnished me by the inventor) consists essentially of three parts:—(1) the flue, or conductor of heat; (2) the kiln, in which the ore is treated; (3) the chamber for the condensation of the sulphur that is volatilised during the fusion, and in which it is collected.

The kiln may be of any suitable form to contain two charges of ore, but a rectangular chamber is found to be most convenient, with floor sloping towards the front. The chamber consists of four walls, preferably not covered with an arch, as affording greater facility for charging and discharging. The kiln communicates by means of a flue *a* with the back of an ordinary *calcarone* *b*, which furnishes the heat necessary for melting the sulphur from the ore contained in the kiln *c*. The upper portion of the *calcarone* should be covered with a layer of *genese* (spent ore), so as to prevent the dispersion of heat by any other channel than that offered by the flue *a*, which is provided with a damper *d*, so as to regulate the admission of heated air by openings *e*, at the upper back part of the kiln. A rectangular opening *f* is left in the front wall of the kiln, from which the melted

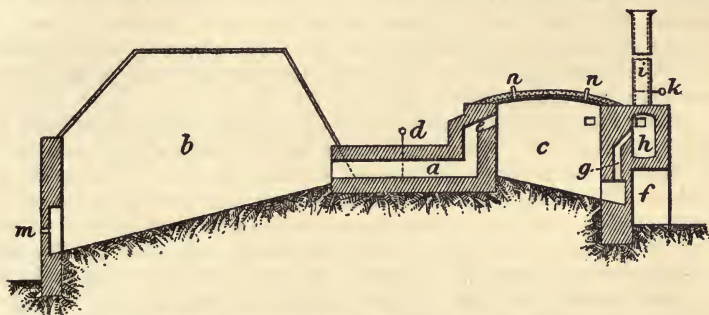

FIG. 101.—FOSTER'S IMPROVED CALCARONE.

sulphur is run. This opening, if of sufficient size, may serve for discharging the spent ore at the termination of the fusion. From the upper part of the opening, and also in the front wall, slightly above the level of the floor, flues *g* communicate with a horizontal passage *h*, which is made large enough to serve as a condensation chamber, on the walls of which the sublimed sulphur collects. At one end of the chamber is a vertical chimney *i*, provided with a damper *k*.

The kiln is charged in the usual way by placing the large pieces of ore on the floor in such a manner as to leave passages for the flow of the liquid sulphur; the small pieces are next filled in, and the finer ore at the top. A few blocks of rough stone, or burnt ore, are placed at the opening in front in such a way as to leave a vacant place for the melted sulphur to collect before being run off. When charged, the ore is covered with bricks laid flat, and on these is put a layer of *genese*, well rammed and wetted, so as to form a nearly impermeable coating, with a slight slope towards the walls, in order that the rain water may run off. The opening *f* in the front wall should be closed with a thin wall of plaster of Paris. The ore in the kiln, which is now ready for fusion, is put in communication with the spent *calcarone* *b*, by opening the damper *d*, and at the same time a small hole *m* is made in the wall that closes the opening in front, from which the melted sulphur has been run off from the *calcarone* *b*. The current of air entering and passing through the incandescent

mass of ore, is thus heated, and enters the kiln at a sufficient temperature. In this manner the heated mass of spent ore in the *calcarone* becomes a regenerator of heat, to be utilised in the kiln for the fusion of the sulphur that it contains. In the upper covering, two or more tubes *n* are placed, and serve not only for observing the internal temperature by a thermometer, but also for firing the mass.

The combustion of the sulphur supplied with hot air, mixed with a considerable proportion of sulphurous acid gas, proceeds slowly in the upper part of the kiln, and the liquid sulphur dropping to the floor, over the already heated ore, cannot solidify and choke the passages, and so prevent the circulation of the heated air and products of combustion of the sulphur to the chimney; in this manner the operation proceeds with regularity. The success of the kiln is principally due to the manner in which it is heated from the top and back towards the front and bottom, imitating, to a certain degree, the manner in which the heating of an ordinary *calcarone* proceeds, with this difference, that the heat is better utilised in the kiln, and, therefore, with less consumption of sulphur as fuel.

When the wall that closes the front opening *f* begins to heat, and the kiln is ready for running, a small hole is made with a pointed instrument, so as to allow the melted sulphur to flow off into wooden moulds. The horizontal flue or condensing chamber *h* should have a sloping floor, and when the temperature in it reaches the melting point of sulphur, the flowers that have been deposited on the sides are liquefied and run off. Towards the end of the operation it will be found prudent to close all the dampers as well as the hole *m*, to prevent the over-heating of the kiln, in which case the sulphur would become thick and difficult to run off, and the yield would consequently be lessened.

The first cost of the structure is slight, as the materials necessary are usually at hand. The yield, too, is much increased; but on the other hand the extra cost in charging, discharging, and attendance, as compared with the ordinary *calcarone*, make a large hole in the increased returns.

Doppione.—It will require little reflection to see that only a small quantity of the finely pulverised mineral, necessarily produced in the operations of mining and breaking down the ore, could be dealt with in the *calcarone*; consequently for a long time the bulk of this portion of the ore was simply thrown away, though it often assayed 70 per cent. sulphur. The *doppione* was one of the earliest successful structures designed to remedy this state of things. As shown in Fig. 102, it consists of a set (generally 6) of cast-iron pots, holding about 30 to 40 gal. each, arranged in a gallery furnace *e*, so as to be completely enveloped by the heated vapours from a fire beneath. Each pot *a* communicates by a long arm *b* with a cooling condenser *c* for the distilled sulphur, placed outside the furnace. The apparatus is generally employed on rich material, or on that obtained from the *calcaroni*, but it is also applicable to ores which are too poor to burn in the *calcaroni*, though the profit in that case must be small. The heat generated in the *doppione* is likely to encourage chemical action between the sulphur and any lime carbonate that may chance to be present in the mineral,

creating a further loss of sulphur. The pots are charged and discharged by opening the lids, which are kept luted during the distillation. The volatilised sulphur is conducted by the cast-iron tube *b*, into the receptacle *c*, over which a small current of cold water constantly flows, reducing the sulphur to a fluid condition; it then

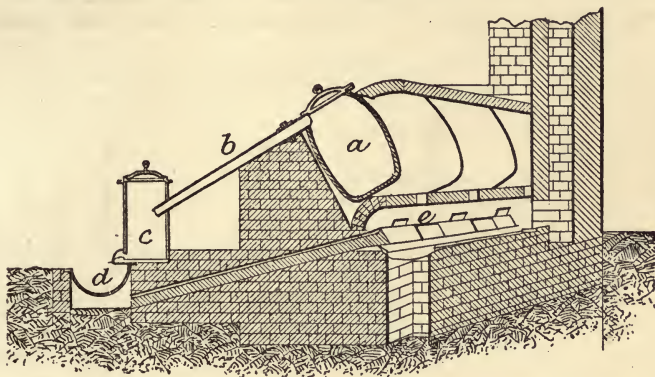

FIG. 102.—DOPPIONE.

escapes into the dish *d* beneath, whence it can be ladled into the moulds. The pots last for about 300 working days, and the furnace serves about the same time with a couple of repairings. The workman is expected to turn out 100 lb. clean sulphur from every 109 lb. *calcarone* sulphur.

Calcium chloride.—The principle underlying the use of calcium chloride is that, while raising the boiling point of water to about 239° F., the melting point of sulphur, it is cheap, and is inert in the presence of sulphur. The water to be used in the melting process is charged with 66 per cent. of the calcium chloride, and heated to boiling, in which state it is run into the vessel containing the sulphur to be melted. No doubt the sulphur is efficiently melted, but the very slight difference in specific gravity between the sulphur and the associated impurities from which it had been melted out practically precludes any real separation taking place. Consequently the process is virtually a failure, as I am assured by those who have worked it.

Steam.—At the Rabbit Hole mines, Humboldt county, Nevada, advantage is taken of the liquidity of sulphur at 232° F. to use steam at 60 to 70 lb. pressure for melting the sulphur out of the gangue. The apparatus employed consists of a cylindrical iron vessel, about 10½ ft. high, divided into an upper and a lower compartment, by means of a horizontal sheet iron diaphragm perforated with ¼-in. holes. As soon as the upper compartment is charged with ore (about 2 tons), steam is introduced for about ½ hour, and the sulphur, liquefied by the heat, flows down through the diaphragm into the lower compartment, kept at the proper heat by injection of steam, and escapes by an outlet, opened at intervals into a receptacle placed outside. When water commences to flow out with the sulphur, steam is injected

at full pressure for a few minutes, to clear out as much as will come, and the solid residue is afterwards removed through a door above the diaphragm. Each charge requires about 3 hours for its treatment.

Carbon bisulphide.—Whilst hot water and steam have no solvent action upon sulphur, but merely change it from a solid to a liquid state by the action of their heat, carbon bisulphide actually dissolves the sulphur and re-deposits it by evaporation. The plant necessary

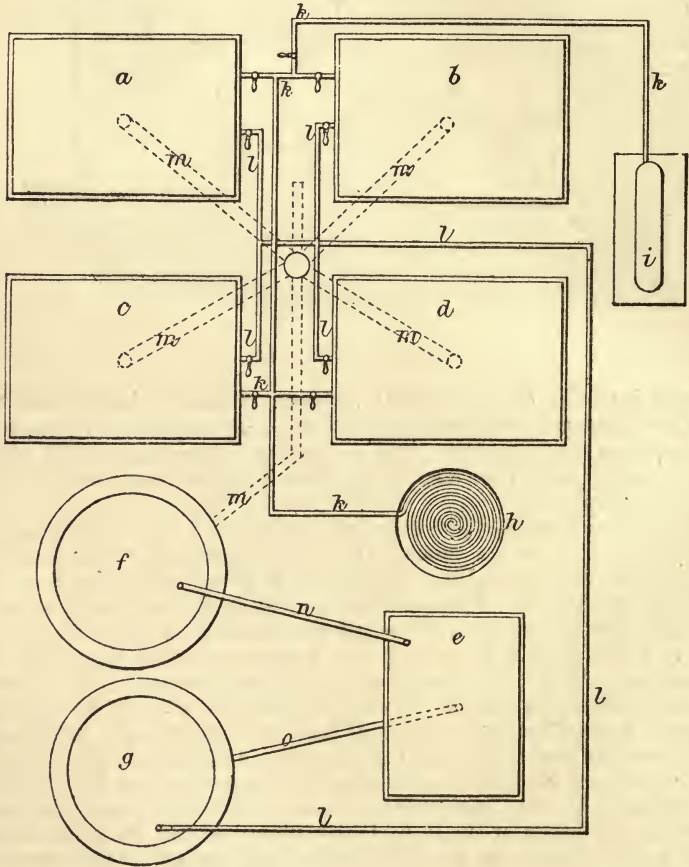

FIG. 103.—SULPHUR-DISSOLVING PLANT.

for carrying out this process is shown in Fig. 103. It is designed of dimensions suitable for dealing with 20 tons raw sulphur mineral per diem, yielding 50 per cent. pure sulphur. The 4 extracting pans *a b c d* have each a capacity of 5 tons, and are made of $\frac{3}{8}$ -in. wrought-iron plate; they measure 6 ft. long, 4 ft. wide, and 4 ft. deep internally; and are fitted with a perforated bottom diaphragm, with connecting pipes *m* leading to the underground solution tank *f*, with another set

of pipes *k* for admitting steam from the boiler *i*, and with a third set of pipes *l* communicating with the store tank *g*. The still *e* is a steam-jacketed "wrought jacket" pan, 6 ft. long, 4 ft. wide, and 4 ft. deep, with cast iron ("loam casting") oval-shaped bottom and ends, $\frac{1}{2}$ in. thick, and provided with a dome-shaped lid, having an inlet pipe *n* and outlet pipe *o*; its capacity is 3 tons. The store tank *g* measures 10 ft. diam. by 7 ft. deep, has a capacity of 10 tons, and is constructed of $\frac{1}{2}$ -in. wrought-iron plates. The worm *h* is a coil of 2 in. pipe. The boiler *i* is of 20 h.p. nominal, and must be placed where it will be impossible for bisulphide vapours to find their way to the fire-hole. Force pumps are required to pump the bisulphide from the store tank into the extracting vats previously charged with the sulphur mineral. When the sulphur has been completely dissolved, the solution is run into the tank *f*, and thence pumped into the still *e*, where by the application of steam in the jacket, the bisulphide is evaporated, and passes into the store tank *g* for future use, while the sulphur forms a deposit in the still, and is collected therefrom. When the extracting pans have been emptied of solution, steam is let in so as to force any remaining bisulphide vapours into the worm for condensation and recovery, thus avoiding waste of bisulphide and consequent risk of fire and explosion by ignition of its dangerous vapours. The bisulphide is allowed to remain all night in contact with the charge. The diaphragm at the bottom of each extracting vat may advantageously be covered with bagging cloth to filter flocculent matters from the bisulphide.

TALC.

UNDER the common name of soapstone or talc are included the whole range of minerals chemically defined as hydrous bi-silicates of magnesia. In this sense talc is a common mineral; but it is generally impregnated with other minerals, such as magnetite, dolomite, serpentine, or epidote, rendering it valueless for technical purposes. Pure talc is recognised by its great softness and greasy feeling. It is highly refractory, and generally of a somewhat flexible, tenacious character, which makes it very difficult to crush. The different talc minerals occur in such a variety of form and approach each other so closely, that it is difficult to classify or define them comprehensively. Steatite, or soapstone, is the most common form. When pure it is a massive, amorphous mineral, generally white, light green, or gray, but sometimes blue or rose-coloured. Schistose modifications are common, and gradually approach rensselearite, or typical foliated talc, which is composed of thin scales of an almost mica-like, pearly lustre, toughness and tenacity. The colour is generally a silvery white or gray. Agalite, or fibrous talc, is found only in a few localities. The following analyses give the composition of the three typical varieties described above:—

	Steatite.	Rensselearite.	Agalite.
	per cent.	per cent.	per cent.
Loss by ignition	5·96
Silica	65·16	52·42	61·28
Alumina	0·25
Ferrous oxide	1·39
Magnesia	27·40	36·24	26·58

Intimately mixed with the talc are often found nodules, veins, and masses of anhydrous silicates, such as hornblende, hexagonite, actinolite, tremolite, and others. The manner in which these minerals invariably appear has given rise to the theory that the talc was deposited originally as hornblende, which gradually has become hydrated.

Steatite has for ages been used for hearthstones, cooking-pots, and other household utensils, for which its softness and refractory nature make it especially adapted. As French chalk it is a familiar article in every workshop. In the United States it was, in the early days of the iron industry, largely used for refractory furnace linings, for bridges in puddling furnaces, &c., instead of expensive imported fire-brick; and up to this day cupola and converter linings in Eastern steel works are frequently built of soapstone. Slabs of the same material are also employed to a limited extent in the building trade.

In powdered form, talc finds a far more extensive employment, entering largely into the composition of mineral paints as a filler, and also as a principal component in fire-retarding paints. In paper manufacture, talc is largely supplanting the more expensive china clay as a weightener and filler. The fibrous and foliated varieties have proved especially valuable for this purpose, as of the talc added to the pulp 75 to 90 per cent. is retained in the paper, as against 30 to 35 per cent. of the china clay similarly employed. The fibrous texture of the mineral also tends to strengthen the paper, and to do away with the brittleness characteristic of paper weighted with clay. The name "mineral pulp," under which this talc is known to the trade, testifies strongly to the value of this feature. For toilet powders, in soap, and as an adulterant for many white, powdery substances, talc is also utilised extensively.

The fibrous variety of talc is mined in the vicinity of Gouverneur, New York. The first mines were opened there about 15 years ago, and have reached a depth of more than 400 ft. The mineral recovered is principally agalite, discoloured near the surface, but turning beautifully white when a depth of 30 or 40 ft. is reached. It occurs in veins, sometimes as much as 20 ft. wide, embedded in strata of granite and gneiss. About 51,000 tons, as nearly as can be learned, were mined in this district in 1892, all of which was reduced to an impalpable powder before leaving Gouverneur. After being broken in two successive crushers, the rock is either run through two sets of buhr stones, a Griffin mill, or a cyclone pulveriser, and is at last finished in Alsing cylinders. For the American market it is shipped in 50-lb. paper bags, while for export it is put up in 100-lb. canvas sacks. The requirements are fibrous nature, freedom from grit, absolute fineness and uniformity of grinding, and opaque whiteness of colour. Gouverneur talc is sold, free on board in New York, for about 50 to 55s. per ton of 2000 lb.

Fibrous talc is also mined and prepared near Wiehle, Fairfax County, Virginia, where the mineral recovered is fully as fibrous as the best varieties of the Gouverneur article, but is slightly discoloured. The deposit worked is of considerable extent, and it is expected that the colour will improve as a greater depth is reached. Fibrous talc cannot be sized by screening, as the particles mat and close the screen openings. This fact explains the elaborate and expensive processes employed to effect a uniform reduction. The supply of this most valuable mineral is very limited.

The principal American centres for the soapstone industry are in the neighbourhood of Easton and Philadelphia. On the Bushkill, near the former place, a number of veins are being worked. The mineral, which is of good quality, is reduced by means of crushers and buhr stones. At Lafayette, a few miles north-west of Philadelphia, soapstone quarries of considerable importance have also long been operated. The stone is trimmed into large slabs for various purposes, while the offal is disposed of to be powdered by buhr stones. The article mined and prepared at Kinsey, North Carolina, is noticeable for purity and colour, and is sold almost exclusively to the drug trade. The entire product of the various grades of talc marketed during 1892

is estimated at about 70,000 tons, of which 51,000 tons were fibrous talc and 19,000 tons were soapstone.*

Soapstone quarries in the Behlaipahari range of Central India have been worked by the natives for over a century. Shafts 4 ft. diam. and 40 to 60 ft. deep are sunk, and from the bottom of them galleries are cut out in different directions following the strata of the stone. Descending these shafts is not an easy matter, and one has to be barefooted to do it. In some, primitive ladders made of wooden poles, the rungs of which are lashed on with the bark of a jungle plant, are used as a means of descent; in others, portions of the rocks are left projecting, the ledges affording places for foothold. Soapstone being lubricant, the descent has to be made with the greatest care. The galleries are barely high enough in places for standing room, and in parts one has to crawl along on all fours. Work at the quarries is in full swing during the cold season, and has to be done by candle-light. In the hot weather lights will not burn satisfactorily inside the quarries, and in the rains work has to be stopped to a great extent owing to the pits getting flooded, so that in the cold weather work goes on night and day.

There are three different sets of workmen employed, and all are paid by piece-work. One set works down in the pit and galleries, and they cut out slabs of the stone about 18 in. diam. and more or less circular in shape, and send them up by women and children to the mouth of the shaft. Then another set of workmen with small mattocks chip and cut the slabs into rough plates, the work being done with astonishing rapidity and accuracy; as soon as a number of these rough-hewn plates are ready, they are sent down to the village by another lot of coolies. At the village a third set of artizans turn the plates on lathes; they soon assume a perfectly smooth surface, and are then ready for the market. A very large number of plates are turned out daily, and are sent to Burdwan and other Bengal districts, where they sell for as much as a rupee apiece. The lessees of the quarries make very large profits by this industry. The cost of a plate, including wages of workmen, carriers, and freight, is about 3 annas, and even locally they sell for 4 to 5 annas each.

In China large quantities of soapstone are produced and used chiefly in paint for both wood and stone.

* A, Sahlin, 'Mineral Industry,' i. 435.

METALLIFEROUS MINERALS.

ALUMINIUM.

THE distribution of aluminium in nature is very wide, rivalling that of iron, yet there are few minerals which serve as sources of the metal. These are: Bauxite ($\text{Al}_2\text{O}_3\cdot\text{H}_2\text{O}$), a limonite in which most of the iron is replaced by aluminium; soft and granular, with 50 to 70 per cent. alumina. Corundum (Al_2O_3), crystalline and very hard, sp. gr. 4, generally quite pure, but too valuable for abrasive purposes to be used as an ore. Diaspore ($\text{H}_2\text{Al}_2\text{O}_4$), hard and crystalline, sp. gr. 3·4, with 64 to 85 per cent. alumina, and ordinarily quite pure. Gibbsite ($\text{H}_6\text{Al}_2\text{O}_6$), stalactitic, sp. gr. 2·4, containing, when pure, 65 per cent. alumina. Aluminite or alunogen ($\text{Al}_2\text{SO}_6 + 9\text{H}_2\text{O}$), sp. gr. 1·66, a sulphate of aluminium, found in large beds, chiefly along the Gila River in New Mexico, containing about 30 per cent. alumina, and easily soluble in water. Cryolite ($\text{Al}_2\text{F}_6, 6\text{NaF}$), sp. gr. 2·9, easily fusible—and when fused its sp. gr. is about 2—containing 40 per cent. aluminium fluoride and 60 per cent. sodium fluoride. All clays contain a large percentage of aluminium, but always in the state of silicate; and the difficulty of removing this silica has so far prevented the employment of clay as an ore of aluminium.

Of the ores above named the most important is bauxite, of which there are vast deposits at Baux near Arles, in S. France; in Ireland; and in Alabama, Arkansas, the Carolinas, Georgia, Tennessee, and Virginia. Following are average analyses of bauxite:—

	Al_2O_3	SiO_2	Fe_2O_3	H_2O	TiO_2	CaCO_3
White from Baux, France	58·10	21·70	3·00	14·00	3·20	trace
Brownish-red from Revest, France	57·60	2·80	25·30	10·80	3·10	0·40
Oolitic from Allsach, France ..	55·40	4·80	24·80	11·60	3·20	0·20
White from Georgia	58·50	5·20	2·30	30·10	3·25	0·30
Reddish-brown from Georgia ..	58·70	4·80	20·50	13·20	2·10	0·45

Other analyses of bauxite from Baux, quoted as typical, differ widely from the above and from each other, thus:—

Alumina	64·24	57·4
Silica	6·29	2·8
Iron oxide	2·40	25·5
Lime carbonate	·55	·4
Magnesia	·38	..
Soda	·20	..
Potash	·46	..
Titanium oxide	3·1
Water	25·74	10·8

100·26

100·00

2 c 2

The mineral from the mines of the Irish Hill Co., in Ireland, carries 44–54 per cent. alumina and 1.15 per cent. iron. About 10,000 tons yearly of bauxite are mined in the United Kingdom (chiefly Ireland), valued at about 6s. a ton.

The Arkansas deposits are said to cover a large area, and to reach a thickness of 40 ft., forming an interbedded mass in ferruginous Tertiary sandstone.

The Alabama deposits are better known, and all occur in the lower part of the Lower Silurian formation; the district has been badly broken up by sharp folds and great thrust faults; and the mineral occurs as pockets in close association with brown iron ore (limonite) and clay. In Cherokee County the deposits appear to be along two parallel lines of outcrop, that run in a general north-east and south-west direction, and are 150 to 200 yd. apart, following the crest of two sharp anticlinal folds. In places the bauxite overlies a white or yellow sandstone, for the most part friable, but sometimes hard and cherty, and underlies an unctuous clay in the upper part of which the brown ore occurs. At one end the bauxite shows as an irregular seam 60 ft. thick. An excavation about 75 ft. deep has been made. To the south-east of Dike's bank, the mineral occurs in two irregular seams, separated in places by a band of unctuous clay 15 ft. thick, but cutting out to a mere selvage. The upper seam is about 30 ft. thick, the lower 20 ft. To the north-east of Dike's bank the deposit has been tested to a depth of 20 ft., and is still good. Half a mile farther toward the north-east is the Warwhoop deposit, tested for 20 ft. and still good. There is no reasonable doubt of the extent of the bauxite deposits in this district; they have been tested over two miles, and have not been found less than 15 ft. thick, and in places 20 to 30 ft. The average composition of the Cherokee County bauxite, as per car-load sample, is as follows: alumina, 56 to 60 per cent.; oxide of iron, 2.75 per cent.; insoluble silicious matter, 7 per cent.; titanitic acid, 2 to 3 per cent.; water, 25 to 30 per cent.

Bauxite for the manufacture of alumina is worth about 2*l.* a ton. It has to undergo purification for the purposes of the aluminium manufacturer. Several methods are used:—

(1) It is chosen as free from iron as possible, and is roasted at a low red heat, and afterwards treated with sulphuric acid, which combines with the alumina present, forming sulphate of alumina. This is readily dissolved by water, leaving the great bulk of silica and iron behind. The solution of sulphate of alumina is allowed to settle, the supernatant liquid is siphoned off into an evaporating tank and evaporated to dryness. The dry sulphate of alumina is calcined at a red heat, driving off the sulphuric acid, leaving as a residue anhydrous alumina.

(2) It is treated, either by fusing it with carbonate of soda and dissolving in water, or by boiling it with a strong solution of caustic soda. In either case a solution of sodium aluminate is obtained, which is filtered from the residue of silica and ferric oxide, and decomposed into aluminium hydrate and carbonate of soda by pumping carbonic acid gas through it. After a thorough washing, the hydrate is calcined at a high heat and the resulting alumina is finely ground.

The ore next in importance, and which long ranked as the foremost, is cryolite, of which there is practically only one productive mine, that at Ivigtut, South Greenland. The mine is worked as a quarry, and has been opened 450 ft. long, 150 ft. wide, and 100 ft. deep, while diamond drills have proved the permanence of the ore for a further depth of 150 ft. The stone broken in the mine is loaded on cars of 5 tons capacity, which are drawn up an incline by means of an endless chain. At the surface the mineral is sorted and piled in heaps between the mine and the shore. In preparing the mineral for shipment, the large masses of impurities, which amount in all to about 20 per cent. of the rock broken, are thrown away, and also the fine particles of the mineral, as only the large pieces are shipped. The contract requires that 90 per cent. of the material shipped shall be cryolite, and in bringing it to this state of purity about 2000 tons are lost annually. The vein appears to widen with depth, but the quality of the mineral becomes inferior. In order to support the walls, pillars of cryolite 8 ft. diam. are allowed to stand at intervals of 30 ft. When the mine is closed for the winter, salt water is run in from the Arsuk Fiord until the pit is filled to about one-third its depth, so that it is necessary to unwater it at the beginning of operations every spring. About 10,000 tons annually are shipped to the United States, valued at about 7*l.* 10*s.* a ton.

While the older processes of aluminium manufacture dependent on the reduction of the double chloride of aluminium and sodium, must always have an academic interest, they have been beaten out of the field of commercial industry by the newer electrolytic methods, which latter therefore alone demand description here. There are four varieties of the electrolytic process. In England and America, Cowles' and Hall's patents are followed; on the Continent, Heroult's and Minet's. They are all virtually modifications of the original Deville-Bunsen process, maintaining fusion by the heat of the electric current.

The experience gained at the Lockport, New York, works with the Cowles process led to some innovations in the more recent English works at Milton, Staffordshire, notably in increasing the dynamo to a capacity of 5000 to 6000 ampères with an E.M.F. of 50 to 60 volts, and in enlarging the furnaces. At Milton, the current from the dynamo is led by the copper bars to an enormous cut-out calculated to fuse at 8000 ampères, and consisting of a framework carrying 12 lead plates, each $3\frac{1}{2}$ in. by $\frac{1}{10}$ in. thick. From this it passes into the furnace rooms. A current indicator is inserted in the circuit, consisting of a solenoid of nine turns. (This was cut out of a cylinder of cast copper by means of a parting tool in a screw-cutting lathe.) In the solenoid is an iron core suspended by a spring. The movement of this is communicated to two pointers, one dial being placed in the engine room and the other in the furnace room. The range of the indicator is such that the entire circle of $360^\circ = 8000$ ampères.

There are two furnace rooms, each containing 6 furnaces. The first room contains the bronze furnaces, in which is carried on the manufacture of aluminium copper and silicon copper. The second is devoted to the production of ferro-aluminium. The furnaces are

rectangular in form, built of fire-brick, the internal dimensions being 60 in. by 20 in. by 36 in. Into each end is built a cast-iron tube, through which the carbon electrodes enter the furnace.

Each electrode consists of a bundle of 9 carbons, each $2\frac{1}{4}$ in. diam., attached to a head of cast iron for ferro-aluminium, or cast copper when cupro-aluminium is made. Each carbon rod weighs 20 lb.

Quite recently it has been possible to obtain carbons 3 in. diam. weighing 36 lb.; these are employed in bundles of five. The "head" of the electrode is screwed to the copper rods of leads which can be readily connected with or disconnected from the flexible cables supplying the current.

Each cable is secured to slides running on omnibus bars of copper overhead, so that it can be brought into position opposite the furnace to be used.

The electrodes are arranged so that it is possible, by means of a handle and screw, to advance or withdraw them from each other in the furnace.

Lining the furnace is the first operation preparatory to smelting; this is done by covering the bottom of the trough with a layer of prepared charcoal. Oak charcoal is used. This is ground under edge runners, treated with milk of lime, and dried, first in a steam-jacketed revolving drum and afterwards on a hot iron plate. Each particle of charcoal is thus coated with an insulating film of lime.

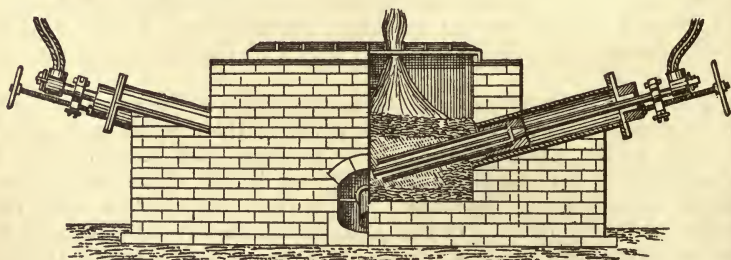
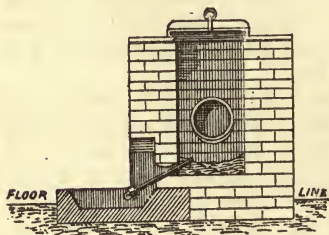

FIGS. 104, 105.—COWLES ALUMINIUM FURNACE.

The electrodes are now arranged in the furnace (Figs. 104, 105) and a "former," consisting of two pieces of sheet iron connected by stirrups arched so as to fit over the electrodes, forming a box without top or bottom (the size being dependent on the charge used), is dropped over the electrodes. Prepared charcoal is then rammed into the space between the iron sheet and the fire-brick walls of the furnace. This done, the charge of ore, mixed with coarse charcoal, and the metal to be alloyed with the aluminium, in form of turnings or "granules," is placed inside the iron box, after which this is carefully withdrawn. Some broken pieces of carbon are arranged so as

to connect the electrodes and start the current. The charge is then covered with coarse charcoal, and the cast-iron cover, having a hole in the centre for the escape of gases, is lifted into place and luted so as to prevent the entrance of air.

The commencing current is about 3000 ampères, gradually increasing to 5000 ampères in the first half hour. The time occupied by a "run" is about 1½ hours. Soon after starting, the gas escaping from the orifice in the cover takes fire and burns with a white flame. This gas consists mainly of carbonic oxide, with small quantities of the hydrocarbons and nitrogen.

On the conclusion of the run the furnace is allowed to cool, the melted alloy collecting in the bottom of the furnace. The next furnace, ready charged, is connected, so that the process is a continuous one, the furnaces being successively charged and connected.

A form of furnace in which the metal is tapped from the bottom has given very satisfactory results.

The energy required to produce 1 lb. of contained aluminium depends, of course, upon the grade of alloy, the average being 18 h.p. per hour.

The crude metal from the furnace is then refined and remelted in a reverberatory furnace, each "run" is sampled, and the percentage of aluminium is ascertained by analysis.

The nature of the reaction that takes place in the electric furnace is not very easy to ascertain. The reduction of the ore takes place in an air-tight box, and in the presence of an enormous excess of carbon. It may be assumed that at the intense heat of the electric arc the ore melts and gives up its oxygen to the carbon—



The presence of copper or iron is immaterial, as the reaction takes place with ore alone, but in absence of the alloying metal the liberated aluminium absorbs carbon and is converted into a carbide.

Prof. Hampe, however, contends that the reaction is in two stages, the first being electrothermic, in which the ore melts; the second, electrolytic, in which electrolysis of the molten oxide takes place, aluminium being liberated.

Supposing an alternating current is used in the furnace instead of the continuous, and that we have a high number of alternations -- from recent experiments with alternating currents we know that very slight or no electrolytic action occurs—if then we get equal results, it would go to prove that the action is thermic, and not electrolytic.

An experiment was made by the Cowles Company, using an alternating current.

The furnace used was 48 in. × 12 in. × 24 in., with current of 900 ampères with E.M.F. of 50 volts, alternations per minute 11,000. At the end of 1½ hours they obtained 45 lb. of 4 per cent. aluminium bronze.

This investigation was purely of an experimental character, and it cannot be doubted that on the larger commercial scale the result would be more satisfactory.

The results obtained were identical with those given by the continuous current in every way, and the resultant slags similar in composition.

The slag from the electric furnace is really only melted unreduced ore, and not a slag in the proper sense of the word. Its approximate composition is Al_2O_3 90, SiO_2 2.00, Fe_2O_3 4.00, CaO 3.9, P 0.10.

The charcoal from the old linings, which has been partially converted into graphite, is recrushed and treated with milk of lime, dried as before, and thus used many times over. The crude metal from the "runs" is remelted with fluorspar as a flux, and tapped from the reverberatory furnace into ingots or plates; the refinery slag is put into a revolving drum for breaking into pieces, and then washed to remove carbon; the entangled particles of alloy are thus recovered, and are worked up with other charges. These operations are carried out in a separate building, the reclaiming house.

When preparing aluminium from cryolite, at starting the carbon cylinders are lowered till they touch the carbon bottom. A poor contact is thus formed, and the ground cryolite, which is then piled around the carbons, is melted by the resistance. When enough has been melted to form a good bath, the carbons are raised, and the melted cryolite carries the current and becomes the electrolyte. The resistance is very high until alumina is added to the bath and dissolved there, when it falls suddenly, and the difference of potential between the electrodes becomes constant at 6 to 10 volts. A sudden rise in voltage indicates, therefore, very clearly when the alumina has all been reduced, and when more must be added. The process is continuous, day and night, seven days a week. The metal which collects in the bottom of the furnace is removed every 24 hours. The metal made by this process is very pure, most of it running above 99 per cent. aluminium, and by using extra-pure materials it may be made to approximate very nearly to 100 per cent.

Hall's process differs chiefly in using a bath composed of aluminium fluoride and the fluoride of a metal more electro-positive than aluminium, passing the current through and adding fresh alumina at intervals to regenerate the salt.

The Heroult process is established at Neuhausen, Switzerland, and at Froges, near Grenoble, France, and by it nearly all the aluminium produced in continental Europe is made.

In the Heroult furnace the melted mass of oxide takes the place of the electrolyte in an ordinary voltaic couple, the reduced metal at the bottom of the furnace being one electrode and a carbon bar inserted from the top the other. Upon a current passing from the carbon bar through the ore to the metal, the ore is decomposed, oxygen travelling upwards and attacking the carbon, whilst the molecules of the reduced metal travel downwards, and are merged in the metal bath. The construction of the furnace will be understood from Figs. 106 and 107, the former being a sectional elevation and the latter a plan. The body of the furnace, or to speak more correctly, of the electric crucible, consists of a block of carbon B contained in an iron box A. In the first crucible made, the iron box was cast round the carbon block in order to obtain a very intimate contact between the surfaces, and thus facilitate the conduction of electricity from the electrodes C to the interior. The

iron, by contraction upon cooling, would securely grip the surface of the box from all sides, thus ensuring perfect contact. This method of construction is, however, only suitable for small crucibles, and the present large furnace is built up of carbon slabs held together by a wrought-iron casing, no difficulty having been experienced in making good contact between the two materials. At the bottom of the cavity

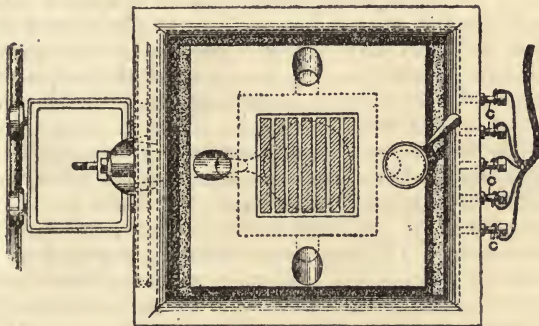
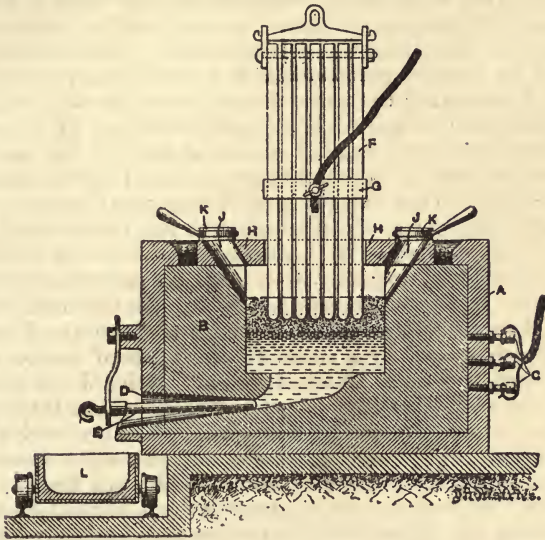

FIGS. 106, 107.—HEROULT ALUMINIUM FURNACE.

in the carbon block is a tap hole D, closed by a plug E, which is withdrawn from time to time to allow the liquid alloy to run into the ladle L, from whence it is cast into ingots. The current enters the crucible by the upper carbon electrode, consisting of a bundle of carbon slabs F suspended by a chain. The chain passes overhead round the drum of a small winch, which is controlled by the attendant, and as the lower end of the electrode is being consumed, the latter is

allowed to descend so as to keep the distance between the surface of the molten liquid in the crucible and the end of the carbon electrode as near as possible constant. This distance is preferably made very small, and should in practice not exceed 3 mm.

The inventor lays particular stress upon the necessity of keeping the distance between the electrodes small. The intervening space, being filled with a layer of badly conducting molten ore, offers a resistance which increases with the distance; and although resistance is necessary in order that the current should produce heat, it is not economical to have more heat than is just sufficient to melt the ore, the work of separating the metal from the oxygen being chiefly done by the electrolytic action of the current, and not by high temperature. The electrode consists of carbon slabs F, held together by a metal clamp G, so as to form one huge compound carbon prism, which, before insertion into the furnace, is 10 ft. long by 17 in. wide and $9\frac{1}{2}$ in. deep. As the slabs are only obtainable in lengths of about 3 ft., the prism is built up of slabs laid upon each other so as to break joint, the whole being held together with stout copper pins, and protected on the outside by copper plates $\frac{3}{8}$ in. thick. An electrode of that size is consumed in the production of about $\frac{1}{2}$ ton of contained aluminium. The crucible is closed by a cover H, also made of carbon slabs, but insulated from the body of the crucible. Holes J are provided in this cover through which the ore and scrap metal are introduced, and these openings can be closed by shutters K. The ore used is alumina, free from silicon and other impurities, and the scrap metal is either iron or copper, according as the desired product is a ferro or a bronze. Bauxite could be used instead of alumina; but as the former mineral contains many impurities, Heroult prefers the absolutely pure though more expensive alumina. The cost of the raw materials is, however, in either case not a very important item as compared with the cost of power, carbons, and wear and tear of plant. The process of smelting is continuous, and need only be interrupted when the upper electrode has been consumed, and then only for the short time required to insert a new electrode. The crucible is periodically charged through charging holes, and the molten alloy is tapped off at D from time to time. The production of aluminium per horse-power hour varies somewhat with the percentage of the metal contained in the alloy, the average being 30 grm. of contained aluminium per horse-power hour, and the maximum 40 grm. Reduced to English measure, this works out to an expenditure of 15 horse-power hours per pound of contained aluminium under average, and 11 horse-power hours under very favourable conditions. The present production of the crucible is 4 cwt. of contained aluminium in 24 hours. The crucible can also be used for the production of silicon bronze, in which case the scrap copper is charged not with alumina, but with clean white sand.

As to the general arrangement of the works, power is supplied by a turbine, to the shaft of which are direct coupled the two dynamos supplying the current to the crucible. These large dynamos are excited by a smaller machine driven by a belt from the turbine shaft; and the speed of the turbine and strength of the main current are controlled by an automatic regulator acting upon a throttle valve placed in the inlet pipe of the turbine. Within certain limits the

main current can also be regulated by hand, for which purpose one of Brown's electrical regulators is inserted in the exciting circuit of the small dynamo. The main conductors are naked copper cables or bars, and no special precautions are employed to insulate them, as in comparison with the huge working current a leakage of 100 ampères, more or less, is too insignificant a matter to trouble about. The current is measured by a large ampère meter. The main current passes once through this circle, in the centre of which is pivoted an electro-magnet, provided with a pointer and counter-weight. The electro-magnet is excited from a primary battery, giving a constant E.M.F., and the calibration of the instrument can be varied by fixing the counter-weight farther from or nearer to the centre of suspension of the magnet, so as to obtain a fairly large deflection for the usual working current. The working current is about 12,000 ampères; but sometimes short-circuiting occurs, when the current suddenly rises to 20,000 ampères and more. These short circuits are generally due to the fact that one or other of the carbon slabs composing the electrode projects beyond the others, and touches the surface of the metal bath in the crucible. The projecting portion is then immediately burned off, but during the time that this takes place the current is considerably increased beyond its normal value. It might be supposed that a short circuit of such magnitude would be likely to damage the electric machinery, but apparently this is not the case. The dynamos do not appear to suffer in the slightest degree from the short circuit, and the only indications of its taking place are a slight sparking at the brushes and a peculiar rumbling noise in the turbine.

The field is of the multipolar type and made in one casting, so that there are no joints of any kind in the magnetic circuits. The armature is of the usual Brown type, with embedded wires, but contains two distinct circuits, each provided with its own commutator. The armature is 38 in. diam. and 24 in. long. The conductor consists on the outside of round copper bars $\frac{5}{8}$ in. diam., and on the inside of flat copper plates placed in grooves planed out of a wood lining, by which these plates are firmly held and at the same time insulated. The current is taken off each commutator by 6 sets of brushes, there being in all 72 brushes on each machine. Although cross connection between equipotential coils on the armature are not absolutely necessary when the number of brushes employed equals the number of field poles, the designer of the machine has thought such connections nevertheless advisable as tending to fairly distribute the work between all the armature wires.

According to A. E. Hunt* of the Pittsburg Reduction Co., the probable cost in the near future of producing aluminium on a large scale will be as follows:—

2 lb. alumina (Al ₂ O containing 52.94 per cent. Al) at 3c.	3
1 lb. carbon electrode at 2c.	1
Chemicals, carbon dust, and pots	$\frac{1}{2}$
22 electrical h.p. exerted 1 hour (using water power)	$2\frac{1}{2}$
Labour and superintendence	$1\frac{1}{2}$
General expense, interest, and repairs	$1\frac{1}{2}$
Total cost of 1 lb. aluminium	10d.

* Mass. Inst. Technology, Boston, 1891.

The total cost of aluminium at the Pittsburg works at the time this estimate was published was much greater than this figure, with an output of 375 lb. a day. Other authorities think the limit of cheapness of production has been nearly reached, and that so far as regards its future, unless it can be made in large quantities, just as lead or copper or zinc, it cannot hope to enter as an important factor in the great industries. It must be smelted in large quantities direct from its ores, or obtained as a bye-product in the preparation of some widely consumed substance, ere it will take in trade the position its qualities command. It is doubtful if the further prosecution of the electrical methods, by which alone aluminium is now made, will bring the cost of it to the point at which it will become a prominent metal, unless they proceed along the line of direct reduction. Even here it is by no means certain that they can make it cheap enough.

The most notable characteristic of aluminium is its low specific gravity—2.6 for castings and 2.74 for wire. No other metal in common use approaches it for lightness. Aluminium is not a rival of steel, and may never replace iron as a structural material; but it is a rival of brass, copper, tin, nickel, and white alloys, and is replacing them in many directions. In tensile strength it ranks with cast-iron, breaking at 15,000 to 20,000 lb. per sq. in., but in malleability and ductility it ranks with the noble metals. Like gold and silver, it hardens very rapidly in working, and rods and wire vary in strength from 26,000 to 62,000 lb. per sq. in. Its elastic limit is about half its tensile strength, and its elongation 10 to 20 per cent. in 1 in.

The electrical conductivity of aluminium is about 50, with copper at 90 and silver at 100. Its thermal conductivity is about 38, copper 73.6, and silver 100. Undoubtedly the conductivity of chemically pure aluminium is much higher, the sample tested containing about 1.5 per cent. impurities.

Aluminium is a little softer than silver, but its ductility allows it to be drawn, punched, or spun into almost any form. A great deal of sheet metal is being used for this purpose, and much more would be used if it were not for the fact that a slightly bluish tint detracts from its resemblance to silver. Practically, aluminium is non-tarnishable; but strictly speaking, after long exposure to the atmosphere, its polish becomes dulled by a very thin film of white oxide, which seems to protect it from further deterioration. Sulphuretted hydrogen has no action on it.

It is inert in most of the acids. Hydrochloric acid and the fixed alkalis are its true solvents. It has been claimed by certain German chemists that aluminium is attacked by almost all vegetable acids, even tea and beer having a solvent action upon it. This statement has repeatedly been proved to be untrue. Even strong brine has been shown to have a very inconsiderable action upon it. The mistake was due to the use of aluminium foil: it is well known that almost all metals when in a fine state of division are attacked by reagents that have no action on them in bulk.

The specific heat of aluminium is very high (0.2253), being about double that of iron; consequently, although its melting point is low, about 1290° F., it takes a long time for it to become fluid, and an

equally long time for it to set. Founders do not usually realise this, and the melted metal appearing rather thick, they generally make the mistake of pouring it too hot.

Aluminium is not volatile at any heat obtainable by ordinary combustion of carbon; but a thin, tenacious film of oxide forms on the surface of the melted metal, which protects it from further oxidation. Aluminium is very sonorous in the form of a bar, but not when cast into a bell. This is probably explained by the fact, noticed by Faraday, that a note is compound, being formed of a tone audible in the longitudinal direction and another in the transverse.

The alloys of aluminium are divisible into two classes—those containing less than 12 per cent. of aluminium and the remainder some other metal, and those containing less than 15 per cent. of some other metal and the rest aluminium. In the first class, aluminium bronze, containing 90 per cent. copper and 10 per cent. aluminium, is the most valuable. Its tensile strength is 90,000 to 100,000 lb. per sq. in., and when a little silicon is also present its strength sometimes rises as high as 135,000 lb. per sq. in. To this class belongs the steel alloy. Greatly increased quantities of aluminium have lately been used by steel workers. A fraction of a per cent. of aluminium is added to the steel, generally for the purpose of obtaining sound clean castings, and it is probable that half the steel castings made at the present day are rendered free from “blow-holes” by the addition of small amounts of aluminium. To the second class belong numerous alloys of aluminium with small percentages of copper, tin, zinc, silver, or titanium added for hardening and stiffening purposes.

In fact, the chief demand for aluminium is at present—and probably always will be—in connection with its alloys. The use of the metal itself will be chiefly for light machinery, fittings for lighting and water supply, astronomical and scientific instruments, and art metal work generally. With copper, aluminium forms a series of beautiful alloys, varying in colour from bluish-white to red-gold and pale yellow, differing very widely in physical and mechanical properties. Those containing 60 to 70 per cent. aluminium are very brittle, glass-hard, and beautifully crystalline; with 50 per cent., the alloy is quite soft; but under 30 per cent. the hardness returns. The 20 per cent. bronze has a whitish-yellow tint, somewhat resembling bismuth. It is very brittle, and can be pulverised in a mortar. The brittleness of alloys above 11 per cent. prevents their use, but from 11 per cent. down to 1 per cent. they are most valuable. Their physical and mechanical properties render them useful for every variety of metal work, and the high price of aluminium has been the only restriction to their use hitherto. In resistance to compression, a 10 per cent. alloy equals the best cast steel; its transverse strength or rigidity is about 40 times greater than that of ordinary brass, and its limit of elasticity equals that of steel of the same tensile strength and elongation. One of the most valuable properties of these alloys is the fact that they are forgeable, and can be worked at a bright red heat as easily as wrought iron; all other bronzes are “hot-short.” The rolling of sheets, rods, bars, and wire is done at a bright heat; only the finishing is done in the cold. A casting which had a tensile

resistance of 60,000 lb. to 65,000 lb. per sq. in. with 20 per cent. elongation, when rolled, showed 83,000 lb. tensile resistance with 30 per cent. elongation. These alloys retain their strength through a high range of temperature, a quality most valuable in a metal. Their resistance to corrosion, which is only a degree short of that possessed by gold and platinum, makes them invaluable to shipbuilders, marine, hydraulic, and sanitary engineers. This quality, combined with their colour, render them far superior to ordinary bronze for art metal work and statuary. The advent of smokeless powder, with its greater corrosive action on ordinary gun-metal and steel, is already causing military engineers to look round for a material to replace these metals in the artillery and small arms of the immediate future, and, in the peculiar combination of properties required, aluminium bronze is unapproachable by any other metal or alloy, and the solution of this question will undoubtedly lead to a great demand for these alloys. The aluminium brasses are made by combining the metal with copper and zinc, yielding close-grain homogeneous and remarkably tough alloys. They are made in two grades, and can be forged hot; their special casting properties, high corrosion resistance, and low specific gravity render them most valuable for hydraulic and engineering purposes. A propeller blade can be made of No. 2 brass at least one-third thinner than cast iron. The high elastic limit, surpassing that of alloys used hitherto for this purpose, would greatly lessen the chance of injury to the blades, in the event of contact with wreckage, whales, &c., at present a frequent source of danger and delay. In these days of fast steaming, the weakening of blades by pitting and corrosion would be reduced to a minimum if made of aluminium brass.

ANTIMONY.

THIS metal occurs in three forms: (1) the oxide, senarmontite, Sb_2O_3 , containing 83.56 per cent. antimony; (2) the sulphide, stibnite, antimonite, or antimony glance, Sb_2S_3 , affording 71.8 per cent.; (3) a sulph-oxide, kermesite, $2\text{Sb}_2\text{S}_3, \text{Sb}_2\text{O}_3$, giving 75.72 per cent.; in addition to some unimportant combinations with silver, &c. Beyond the considerable quantities of oxide coming from Algeria, and of kermesite from Tuscany, almost the entire output is in the form of stibnite; and while it may be said that antimony is somewhat widely distributed in nature, yet, owing to cost and difficulties in extraction, only comparatively few mines, affording a rich ore, can be profitably worked.

Foremost in antimony production stands Portugal, due principally to the mining district of Oporto, and especially to the area lying between the town of Vallongo and the river Douro, where some 100 concessions of 1000 metres by 500 or 50,000 sq. metres each have been taken up.* In 1880 the discovery was made that almost every antimoniferous vein carried also gold.

The geological formations of Portugal are chiefly igneous and old sedimentary. The Oporto mining district lies practically in a basin of granite, the enclosed rocks being Cambro-Silurian, Carboniferous, and Laurentian slates and shales, with occasional dykes of quartzite. The shales course N. 10° W., with a dip towards the east varying from 50° to 80°. The most favourable rocks for good antimony ore are bluish-grey argillaceous Silurian shales. Two main systems of lodes intersect these shales: (1) coursing north-south; and (2) coursing east-west.

The N.-S. lodes in the Gondomar district course practically in the direction of the magnetic needle, with a dip varying from 30° to 70° W., which is opposite to that of the enclosing rock. The richest mineral is found in the E.-W. lodes, the most favourable course being N. 75° E., the dip varying from 50° to 80° N. The lodes generally have well-defined walls, and vary greatly in thickness, from a few inches to as many feet. The mineral in the N.-S. lodes is disseminated through the gangue, whilst that in the E.-W. lodes is condensed into solid bands which run in chimneys dipping about 30° E. The E.-W. lodes are generally bigger. The district is very much cut up by faults, which in some places throw the lodes many feet. The course and dip are very near those of the stratification of the shales. They carry a small amount of antimony ore and quartzose pyrites, the latter often being fairly rich in gold. Occasionally the lodes are bent by faults, which, in the bent part, assume more the

* The information here given is derived from a valuable paper by F. Merricks in 'Trans. Inst. Min. and Met.,' 1893.

character of an elvan carrying much clay, but no mineral. The country rock in this neighbourhood is of a dry and barren-looking nature, and much softer. Fig. 108 illustrates the E.-W., Fig. 109 the N.-S. lodes and faults. The dotted lines represent cross-cuts.

While the greatest depth yet reached is less than 1000 ft., it appears from experience with many of the lodes that good mineral is met with near the surface, which extends to a certain depth and then appears to pinch out. In the case of the Tapada lode, rich mineral has been struck below this apparent barren stratum, and such will probably be the case with other lodes when depth is attained.

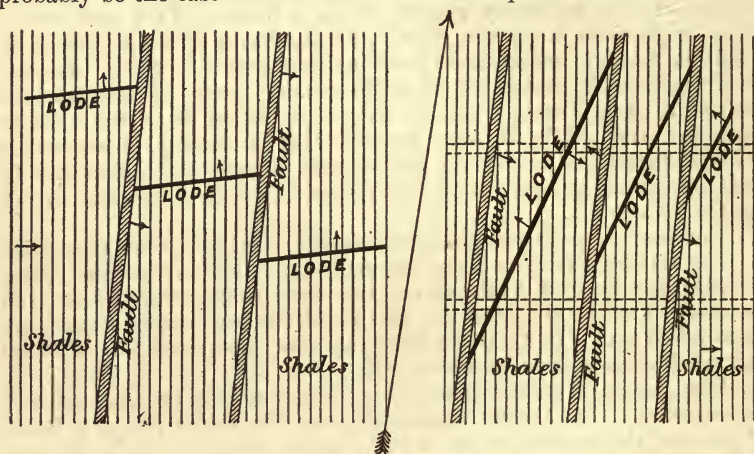

FIGS. 108, 109.—ANTIMONY LODS.

The Vallongo district is practically free from faults. The north-south are the principal and paying lodes, and differ from those of the Gondomar district, in that the ore occurs more in the form of irregular pockets. Other lodes with different directions are not much good and are not worked, the mineral in these being much disseminated.

The principal mineral worked in the Oporto district is sulphide, only occasional pockets of oxide of antimony being met with. The gangue is principally quartz, rarely crystalline, with some iron and arsenical pyrites. Enclosed country rock is also associated with the gangue. Calcspars is often met with, more frequently, however, in the lodes of the Vallongo district. Scheelite was once found in the Tapada lode. Tellurides are sometimes met with.

Among the other European centres of production, the Bohemian mines are in granite and mica schist, the Hungarian in granite (sometimes auriferous), the Styrian in dolomite, and the Turkish also in granite. Victoria, New South Wales and Western Australia are all large producers of auriferous stibnite; at Hill Grove the veins occur in metamorphosed Devonian strata near a granite dyke. In New Brunswick antimony is mined in a quartz and calcite gangue in clay-slates and sandstones of Cambro-Silurian age.

Within the United States stibnite has been found in a number of places, all in the West. At San Emigdio, Kern County, California, it is contained, with quartz gangue, in a vein in granite. The vein varies in thickness from a few inches to several feet, and has produced some ore which has been smelted to regulus and shipped to market. Several other small deposits occur in San Benito County, and elsewhere in California. Stibnite has also been discovered in Humboldt County, Nevada, and in Lander County, not far from Austin, in a quartz gangue. Some remarkable deposits occur in Iron County, Utah, as masses of radiating needles which follow the stratification planes of sandstone and fill the interstices of a conglomerate. No attempts to work these Utah mines have been successful. Stibnite is found in Sevier County, Arkansas, filling veins, with a quartz gangue, in sandstone. An interesting deposit of senarmontite was found in the Mexican province of Sonora, just south of the Arizona line, but the quantity did not prove great.

The vein at San Emigdio reaches 40 ft. in thickness, but the mass of the ore is too low grade to work. Published analyses of the best quality give $62\frac{1}{4}$ per cent. antimony, $6\frac{1}{2}$ bismuth, $12\frac{1}{2}$ silica, $1\frac{1}{2}$ alumina, entire freedom from lead and copper, and 3 to 15 oz. silver per ton. At present the only productive mines in America are in Nevada. The Beulah mine near Austin, from a vein 2 ft. wide, produced 600 tons in 1892, averaging 60 per cent. metal; and the Sutherland, 200 tons at 55 per cent.; the aggregate value being about 10,000*l*. On Erskine Creek, California, a ledge of "quartzite and porphyritic rock" was remarkable for yielding several tons of nodules of metallic (native) antimony, of all sizes up to 300 lb. each.

Borneo is one of the largest shippers of antimony to Europe. Bolivia contains much stibnite associated with gold and silver. One mine in Potosi is turning out 100 tons a month of 65 per cent. grade. It is said, however, that the veins all impoverish in depth.

Though the metallurgy of antimony is simple in theory it is difficult in practice, owing to the ready volatility of the metal. Hence the ore must be extremely pure to admit of profitable mining. Even in Portugal, which is comparatively near the English market (the great centre), crude ores below 45 per cent. were not profitable in 1891. In purification by liquation, in the present stage of the metallurgy, it seems practically impossible successfully to separate the stibnite from the gangue when the ores run below some such extreme limit as 30 per cent. Such considerations are important in their bearings on the value of a new enterprise. Stibnite is poorly adapted to wet methods of dressing, because it is extremely brittle and is usually disseminated through hard quartz in fine needles or blades, which break up into slimes.

At the most progressive of the Portuguese mines, the ore on being raised to the surface is passed over a $1\frac{1}{4}$ in. screen; the smalls from this are conveyed to rolls, trommels and jigs. The stuff passing over is deposited in bins, and thence is gradually drawn on to a table provided with water from a hose, and hand-picked by women, the waste falling into shoots for transfer to the waste-heap. The first quality or practically pure mineral is picked out and put by for barrelling;

the rest is hand-cobbed and separated into three qualities, the best of which goes with the previous selection, and contains 65-70 per cent. metal. Second quality runs from 56 to 60 per cent. metal, and is barrelled separately. The third or last quality is sent to the breaker, rolls, and trommels, and divided into five classes (*a*) that passing through the trommel; (*b*) that passing $\frac{3}{8}$ in. holes; (*c*) $\frac{3}{16}$ in.; (*d*) $\frac{3}{32}$ in.; (*e*) $\frac{1}{20}$ in. The first class is again hand-picked and crushed with the second; the third and fourth are sent to the jigs; while the fifth goes to the settling tanks, pointed boxes, strakes, buddles, &c. Third quality ore carries about 48 per cent. of metal. Only about 10 per cent. of the total lode stuff raised is marketable ore.

The English method of smelting antimony ores has been well described by E. Rodger, from whose paper* the following account is condensed.

The ores must be free from lead and arsenic, neither of which can be eliminated. The ore is ground under edge runners and passed through a coarse screen, the largest pieces which are allowed to pass being about the size of hazel-nuts. After grinding, a sample is assayed to ascertain how much iron is required for reduction. The process of smelting consists in reducing the sulphide of antimony by means of metallic iron, the fusion taking place in crucibles measuring 16 in. high, 11 in. wide at top, tapering to the bottom, and containing 10 per cent. graphite in their composition, which are heated in a very long reverberatory furnace. This furnace consists of a bed 54 ft. long, including the fireplaces, and 7 ft. 4 in. broad (inside size), covered by a low arch which springs almost from the surface of the ground, the bed itself being sunk below. It is heated by a fireplace at each end, drawing into a common flue in the middle of the floor of the furnace. The sides and top of the arch are covered with 1-in. cast-iron plates, the whole anchored in the usual way. The furnace is sunk into the ground, so that it is quite easy to step on to its iron-covered roof.

The crucibles are lowered into their places through 42 circular holes; 14 in. diam. in the arch, 21 on each side. Two 4-in. holes in the furnace roof at each end of the bed are used for removing clinker.

The pair of crucibles nearest the fireplaces at each end is kept for "starring," or refining the crude metal. The charge for each crucible consists of 42 lb. ground ore, 16 lb. wrought-iron scrap, 4 lb. common salt, and 1 lb. skimmings from the next operation, or the same weight of impure slag from a previous melting. These weights vary with every ore, but the above will be true for an ore of 52 per cent. metal.

The scrap must not be cast iron. Tinned scrap is preferred from its convenient form, and the small trace of tin being generally believed to benefit the antimony. Part of the tinned scrap is beaten up into a round ball, large enough to fit the top of the crucible loosely. Such a ball weighs about 13 lb., and one is used for each charge, the remaining iron required being added in the form of turnings or borings, mixed through the ore, along with the salt, in the weighing-

* JI. Soc. Chem. Ind., xi, xii. 1075.

scoop. The mixture of ore, salt, and iron is dropped into the crucible through an iron funnel, the lump of beaten scrap being thrown in last to form a kind of lid; the furnace hole is then closed for about $\frac{1}{2}$ hour, when the crucible is again examined. In the meantime a fresh charge is weighed out ready for the crucible the moment it is empty. As the charge melts, the ball of iron on the top falls down and is gradually absorbed, the iron reducing the antimony to the metallic state, it being itself converted into sulphide. The salt assists the separation of the slag, and tends to promote the fusion of the silicious matters of the ore. The length of time required for fusion and decomposition varies with the position occupied by the crucible. As a rule, about 4 meltings are got from each crucible per 12 hours, so that, allowing for charging and occasional changing of crucibles, &c., a little less than 3 hours may be taken as an average; the richer the ore the shorter the time required to melt it. Opposite to each crucible, except those used for the final refining, is placed a conical cast-iron mould close by the furnace side, large enough to hold the contents of the crucible, and furnished with a cast-iron lid. The crucible is balanced on the edge of the furnace wall, and the contents are poured into the mould, which is at once covered with the lid; the crucible is examined, scraped out if need be, replaced, and at once recharged.

The mould has at the bottom a circular $\frac{3}{4}$ -in. hole. The first portion which reaches the mould chills, and prevents the escape of the remainder. The fused mass, when cool, is knocked out by a hammer and punch. When the mass is removed the reduced antimony is knocked off the slag, which should be quite clean enough to be thrown away. The metal obtained is known as "singles," and contains: antimony, 91.63 per cent.; iron, 7.23 per cent.; sulphur, 0.82 per cent.; insoluble matter, 0.32 per cent. An excess of iron is used to reduce the whole of the antimony in the ore, and the next operation consists in removing this by melting the "singles" with a small quantity of pure sulphide of antimony, the liquated sulphide being used for this purpose.

The charge for the second fusion consists of 84 lb. singles broken small, 7 to 8 lb. liquated sulphide of antimony, with 4 lb. salt added as a flux. Sometimes kelp salt is used in place of ordinary salt in this fusion, and is found to be very suitable. The reaction in this fusion is similar to that in the last operation, the excess of iron in the metal reducing the pure sulphide of antimony to the metallic state, being itself converted into sulphide of iron. The fusion is closely watched; and great care is taken that the metal and the sulphide of antimony shall mix thoroughly; but much stirring with iron tools should be avoided at this stage, as the object is to remove iron so far as possible: When stirring is required, it is done as quickly as possible, in order to expose the iron stirrer as little as may be to the action of the sulphide of antimony. When fusion is complete, the mass is skimmed by means of a cast-iron ladle placed on a long shaft, and the metal is poured into moulds identical with those used in the previous operation. The metal resulting from this melting is known as "star bowls," and each fusion yields a lump of about 80 lb. The skimmings

go to the first operation. An analysis of this second metal showed: antimony, 99·53 per cent.; iron, 0·18 per cent.; sulphur, 0·16 per cent.—total, 99·87 per cent.

The surface of the crystals of this metal is covered with tiny bright specks, which are a certain sign of the presence of sulphur; this appearance is known as “flouring,” metal showing these specks being said to be “floured.” As in the first melting it is necessary to add an excess of iron in order to remove all the antimony, so in this case it is necessary to add an excess of sulphide of antimony in order to remove all the iron, and hence the presence of sulphur in the antimony obtained. In order to remove this sulphur, and finally to purify the metal, another melting is required; and the custom of the trade being that antimony shall be sold in flat ingots, each “starred” or crystallised on the upper surface, it is necessary to take precautions so as to obtain this “star” or crystallised appearance, by means of which the buyer judges of the purity of the metal.

These two results are achieved by melting the metal along with a peculiar flux known as “antimony flux,” a body often difficult to prepare, but easily kept in order. The rule-of-thumb process of making this flux is carried out as follows:—3 parts ordinary American potash are melted in a crucible and 2 parts ground liquated sulphide of antimony are mixed in. When the mixture is complete and the fusion is quiet, the mass is poured out and tried on a small scale to see whether it yields a good “star”; if it does, the ingot of metal obtained is broken, and the metal is examined to judge whether it is free from sulphur. If free, then the flux is considered satisfactory and may be put in use; but otherwise the flux is remelted and more of one ingredient or the other is added as experience dictates.

The process of refining and restarring the star-bowls is as follows:—The lumps of metal when cold are removed from the mould and thoroughly cleaned from the adhering skin of slag by chipping with sharp hammers, this part of the work being sometimes done by women, who become very expert in rapidly and completely removing every trace of slag. Unless this cleaning process is carefully carried out, it is hopeless to attempt to obtain a good star on the finished metal. The chippings are, of course, collected and returned to the second melting. The star-bowls, having been cleaned, are broken small, and a charge is weighed out for refining. The charge used is 84 lb. star-bowls and a sufficiency of the antimony flux. Enough flux is added to surround the ingots completely, less or more according to their shape and thickness—ordinarily about 8 lb. The melting takes place in the crucibles next the fireplaces—that is to say, in those which are hottest and in which the fusion will be most rapid. The charge of metal is thrown into the crucible and narrowly watched, and whenever it begins to melt the flux is added. As soon as the fusion appears to be complete, the furnaceman stirs the mixture once round only with an iron rod, and the charge is at once poured out. The ingot moulds are placed side by side, having between them a wedge-shaped frame of cast iron, called a “saddle,” the edge of which points upward, and upon which the charge is poured, when the stream divides, one half finding its way into each mould. These moulds are

left to cook undisturbed, and as they cool the flux which covers the surface cracks, and when cold can be easily knocked off. The flux is used over and over again, a piece of carbonate of potash being thrown into each fusion when old flux is used. In this way it will be seen that the flux keeps on increasing as a little potash is added and a little sulphur and antimony are picked up at each fusion. The ingots must be completely surrounded by flux; there must be a thin layer of it between the mould and the metal, and also the whole surface of the ingot must be covered to the depth of $\frac{1}{4}$ in. Under the circumstances the metal should always give a good star and preserve a good colour. The traces of flux which adhere are removed by washing in warm water with the assistance of a little sharp sand, water by itself being insufficient to remove the flux, which is practically insoluble in water.

The personnel of such a furnace consists of about 36 men and 3 women, this total being made up as follows:—2 firemen, one each fire, day and night, 4; 8 furnacemen, 4 on each side, day and night, 16; 2 men cleaning metal, day and night, 4; 2 men breaking metal, day and night, 4; 1 man weighing charges, day and night, 2—total, 30. On day shift only there are:—3 men grinding ore, &c.; 1 smith, repairing tools, &c.; 3 women packing and washing; and 1 engine and boiler man—total, 38. This does not include the making of crucibles, but, generally speaking, one crucible-maker and one labourer can make enough crucibles, working during the day only, to keep the furnace going. The coals consumed, including those for firing the kilns, amount to about 22 tons per week, or a little more than $1\frac{1}{2}$ ton each shift. About 11 crucibles are used per ton of refined metal produced, but this might be reduced by careful working. The yield of finished metal from such a furnace, working a 52 per cent. ore, is about $14\frac{1}{2}$ tons per week.

A great deal of volatilisation takes place from the melted metal in the pots, and the fume thus produced is condensed in the flues of the furnace, which are built for that purpose in a winding manner, passing backward and forward under the floor of the crucible drying stoves, so as to dry the pots at the same time that the fume is condensed. The total amount of fume varies very much; the richer the ore the less fume there is in proportion to the antimony produced, although the absolute amount is greater than when a poorer ore is worked. About 10 per cent. of the total antimony contained in the ore is volatilised as oxide, and of this the greater part is condensed in the flues. The fume is whitish, heavy, and rather crystalline, in appearance not very unlike white arsenic. It contains about 70 per cent. to $72\frac{1}{2}$ per cent. of metallic antimony. The smelting of this fume is conducted as follows:—A test experiment is made in order to ascertain the amount of carbon in the form of coke or anthracite necessary to reduce all the antimony present in the fume. This having been found, the fume is mixed by grinding under edge runners with the proper quantity of carbonaceous matter, and of the mixture so produced a few pounds' weight is added to each charge of ore and iron when melting for singles. As the gases given off in the process are apt to cause the mixture in the pots to overflow, the "boiling ore," as the workmen term the mixture of fume

and coke, is therefore looked upon by them with great disfavour: but beyond the mechanical difficulties, there is no trouble whatever in smelting the fume. The flues require cleaning out at intervals, sometimes once every 2 or 3 months. About 3 to 6 per cent. of the metal is lost in the slags.

The ingots, which are known in the trade as "French metal," after being wrapped in straw, are packed in kegs holding about 6 cwt. net.

Continental smelting methods have been described by R. Helmhacker* and by C. A. Hering,* who suggest some improvements.

Where the reverberatory furnace is used without crucibles, a solid hearth is indispensable, as the very fluid metal penetrates all crevices, and where no artificial bed is sufficiently durable, recourse is had to granite or some similar stone, formed into a trough of one piece, and made not from the hardest stone, which will probably crack on heating, but of softer, half-weathered varieties. Unroasted ore and scrap iron may now be placed upon the furnace bed, where the former melts readily and is decomposed. All the metal cannot be thus recovered, since a part volatilises and a part forms a double sulphide with the iron.

In the process by which antimonite is fused with sodium carbonate, the mixture froths very considerably, and is found to attack the furnace.

In the third process, the partially-roasted ore, containing Sb_2S_3 , Sb_2O_3 , and Sb_2O_4 , is charged into the furnace with small coal, scrap iron, and soda (or with coal and soda alone). Where it is possible 8 to 13 per cent. of coal and 9 to 11 per cent. of soda are used without the addition of iron, since with the latter the slags are less fusible and do not entirely cover the bath of metal, and a regulus rich in iron is also obtained. A furnace with a cavity on one of the longer sides, in which to collect regulus during the liquation and metal in the subsequent treatment, is best suited for this purpose.

The great expenditure of fuel and loss by volatilisation in these processes render a method of smelting by the blast furnace desirable. Experiments in this direction have, however, been only partially satisfactory. Helmhacker's early experiments failed, owing to the use of a coke with 12 per cent. of ash and of powdered oxides of antimony. He therefore made up the oxide into lumps with 10 per cent. of sodium sulphate and a little water, and charged into the furnace with 33 per cent. of charcoal. At first all went well, the charges sank regularly down, a fine rain of metallic globules fell into the crucible, and a good red heat was maintained in front of the tuyers; but in about 6 hours a quantity of blackish balls of slag (consisting of Na_2S reduced from the sulphate) accumulated before the tuyers; and from that time the temperature gradually fell at this point, though the heat was maintained and reduction still proceeded in the upper part of the furnace. Apparently the only difficulty consisted in finding a sufficiently fusible slag. Attempts to find a substitute for solid granite hearths have failed: fireclay is more rapidly attacked by the soda; steatite exfoliates under the heat; and magnesite is insufficiently solid.

* *Diagl. Polyt. Jl.*, 1883.

There is still a most attractive field for metallurgists in improving the treatment of antimony ores, especially in connection with the recovery of the gold so largely present.

The marketable metal assumes a peculiar crystalline appearance known as "star," by which its quality is largely judged, though not to the exclusion of proper analysis. In a good sample the "star" should be bold and defined, with the edges of the ridges sharp and straight; the metal should be white and lustrous, and on fracture the crystals should be large and free from specks—the presence of these indicating sulphur, and greatly detracting from the value of the sample.

The chief use of antimony is for hardening alloys. The trade is in few hands, and the market is subject to enormous and sudden fluctuations.

BISMUTH.

THIS metal occurs in a number of forms, but chiefly as native bismuth, as a sulphide (81 per cent. metal), as an alloy with gold (maldonite), and as a carbonate (bismutite).

In England a few cwt. of the metal are yearly produced in Cornwall, but the chief European sources are the Saxon Erzgebirge, where it is commonly encountered with cobalt and silver ores; the Erzgebirge of Bohemia, in connection with silver and tin; the silver ores of Styria and Carinthia; and the gold mines of Cziklova in the Banat and Rezbanya in Transylvania, associated with tellurium, gold, and silver. The yearly production of bismuth ores in Austria is 800-1000 tons, affording 1200-1400 lb. metal. In Norway it occurs with copper. The auriferous deposits of the Yeniseisk, Siberia, contain bismuth. It is associated with gold in Charlotte County, New Brunswick, the rock giving 10 per cent. bismuth and 5 dwt. gold per ton. Bismuth occurs with certain silver ores in the San Juan district, Colorado, where it is produced commercially; and Lane's mine at Monroe, Connecticut, has furnished specimens of native bismuth in quartz. Bismutite has been met with in conjunction with gold at Chesterfield, S. Carolina. The sulphide is found at Cata Branca, Minas Geraes, Brazil. A large deposit of bismuth ore is worked at Quechisla (Chorolque), Bolivia, associated with silver and tin, the monthly output reaching 25 tons. Both metallic bismuth and bismutite are products of the auriferous deep leads of Victoria; and at Nuggety Reef, Maldon, Victoria, both in the neighbourhood of the granite veins and a few inches deep in the granite itself, are encountered quantities of maldonite, the gold from this district being largely alloyed with bismuth. In Queensland, bismuth ore accompanies magnetite, and the mixture, after wet concentration, is passed through a magnetic concentrator, by which the percentage of bismuth is raised from 10 or 12 to 20. Tasmania also affords some bismuth.

The metallurgy of bismuth possesses but little general interest as the industry is a monopoly. Producers of bismuth ore content themselves with concentrating the mineral as efficiently as may be, to save freight, and shipping to London. Nearly all commercial bismuth and bismuth ores carry notable amounts of the precious metals, enhancing their value but complicating their treatment.*

The low fusing point of the metal, 476° F., gives it a value for alloying purposes, and it is employed to some extent as a drug; but the demand is always limited, and the market is closely controlled. Shipments of 20 per cent. ore from Australia have fetched 100*l.* a ton, but probably the gold contents influenced the value.

* Consult E. A. Smith, *Jl. Soc. Chem. Ind.*, 1893, p. 318; E. Matthey, ditto, 1889, p. 286, and *Chem. News*, 1893, pp. 63, 67; and 'Mineral Industry,' ii. 69.

CHROMIUM.

THE mineral chromite, which is a mixture of the oxides of iron and chromium, is the universal source of chromium. Chromite is a member of the spinel series, and resembles magnetite very closely. The theoretical chromite $\text{FeO}, \text{Cr}_2\text{O}_3$, with 68 per cent. chromic oxide, often has magnesia (MgO) replacing a portion of the FeO , and ferric oxide (Fe_2O_3) and alumina (Al_2O_3) replacing a part of the Cr_2O_3 . These other oxides lower the grade of the ore. About 50 per cent. chromic oxide is the general market standard.

Chromite is always found in association with serpentine. This rock has usually resulted from the alteration of rocks consisting largely of olivine, hornblende, and pyroxene; the chromic oxide has separated from these minerals and from a chrome spinel (picotite, $\text{MgO}, \text{FeO}, \text{Al}_2\text{O}_3, \text{Fe}_2\text{O}_3, \text{Cr}_2\text{O}_3$) often found with them. The chromite is thus scattered through the serpentine in irregular masses, which are often of considerable size. Although known as a mineral in many serpentines, chromite has only been produced commercially in Queensland, New Zealand, New Caledonia, Asia Minor, Russia, and the United States. Individual mines are seldom large on account of the pockety nature of the deposit.

Wood's mine, in Pennsylvania, was a notable exception, but it is now exhausted. Certain others in the Bare Hills north of Baltimore were also quite productive in their day. California is at present the principal commercial source of chrome ore in the United States. Great areas of serpentine occur on the flanks of the Sierras and in the Coast Range. These afford chromite in Del Norte, San Luis Obispo, Placer, Shasta, and many other counties of the State, but the four named send the greater portion to market. A mine on Shotgun Creek, in Shasta County, produced in 1889 the exceptional yield of 2000 tons; the general yield is much less. In San Luis Obispo County the mineral is gathered from the surface of the serpentine, where it has been left as "float" by the weathering of the rock. It is also mined underground. At the shipping point an ore with 50 per cent. chrome oxide brought 35s. per ton. No ore less than 47 per cent. chromic oxide is accepted, at present conditions, but ores over 50 per cent. bring higher prices. There is great uncertainty in the mining on account of the irregular distribution of the ore, and because it grows less rich as depth is attained. Traces of nickel minerals frequently occur in connection with chrome ore. The mining is carried on in a desultory manner, the greater part of the ore being quarried by farmers in dull times and sold to dealers in small lots, only one mine being exploited systematically. Much of the chrome ore existing in California assays less than 47.5 per cent. Cr_2O_3 , and has no commercial value at present, while many of the richer deposits are in localities whence the cost of transport to market is prohibitory.

It is stated that no ore with less than 50 per cent. chromic oxide can be sent east in competition with ores from the Mediterranean.

Chromite has been mined at Curpur, in the Shevaroy Hills, India, since 1833. The principal rocks where the mines are situated are hornblendic, micaceous, and talcose schists, penetrated by dykes of basalt and layers of serpentine, which last is intersected by a perfect network of veins of magnesite. The chromite occurs very irregularly in these veins in lenticular masses of various shapes and sizes; one block was said to weigh a couple of tons.

There are many places where chrome ore is produced which are handicapped by transportation charges, and in this connection it is interesting to quote recent figures relating to cost of one month's concentration in California,* where a 42 per cent. ore is crushed by breakers and Huntington mills, and dressed by Woodbury vanners and settling tanks:—

	£
900 tons (2240 lb.) ore at 22s.	990
10,000 bags at 4½d.	180
60 cords oak at 20s.	60
30 cords willow at 16s.	24
1 millman at 16s. a day	24
1 „ at 14s. „	20
5 labourers at 6s. „	45
Miscellaneous expenses	40
	1383

Product: 700 tons (2000 lb.) of 50 per cent. concentrates, costing 36s. 6d. for material and fuel, and 3s. 6d. for labour, total 40s. a ton.

Placet, a French chemist, is said to have succeeded in producing a perfectly pure chromium by means of electrolysis, which will allow of the metal being placed on the market in sufficient quantities to meet all industrial requirements. The pure chromium differs from the metal produced in the ordinary way. It has a beautiful white colour that is unaffected by exposure to the air or by contact with acids, and it has the further quality of being exceedingly tough, and less fusible even than platinum. Until chromium was produced in its pure state its scope as an alloy was strictly limited to the manufacture of chrome steel, as the presence of iron and carbon prevented its being alloyed with other metals. The pure chromium has practically no limit to its application as an alloy. A very small quantity will suffice to give great toughness and malleability to almost any metal, which is also rendered capable of bearing a very high polish. The toughness of copper, for instance, will be nearly doubled by an alloy of 5 per cent. pure chromium; and the possibilities of aluminium are in the same way enormously increased, as any degree of hardness and toughness can be secured by a more or less addition of chromium as an alloy.

* 'Mineral Industries,' ii. 154.

COBALT.

COBALT occurs in many forms, and all cobalt minerals are associated intimately with those of nickel, especially with the arseniate, the arsenide, and the sulphide. The chief ores of cobalt are (1) the arseniate, cobalt bloom, carrying $37\frac{1}{2}$ per cent. cobalt oxide; (2) the black oxide, asbolane, or earthy cobalt, with 24 per cent. cobalt oxide and 76 per cent. manganese oxide; (3) the arsenide, smaltine, or tin white cobalt, giving 18 to 25 per cent. cobalt; and (4) the sulpharsenide, cobaltine, yielding 33 to 37 per cent. cobalt. Mention may also be made of the cobaltiferous wad or "cobalt terra," carrying 3-5 per cent. cobalt oxide, raised in New Caledonia.

Near Rhyl, Flintshire, is the only productive British cobalt mine. Curious irregular cavities called "swallows" here occur in the mountain limestone, and are filled up with a red ferruginous clay, containing deposits of hæmatite, asbolane, and manganese oxide. Samples of clean ore vary from 20 to 37 per cent. cobalt sesquioxide, 6 to 10 per cent. nickel sesquioxide, and 23 to 40 per cent. manganese binoxide; but the mineral as mined does not afford over 1 per cent. cobalt and $\frac{1}{2}$ to 1 per cent. nickel, yet the search is profitable, and has been carried on for some years, yielding 50-150 tons annually, worth about 6*l.* a ton.

Norway possesses important cobalt deposits at Skutterud, where the ore is chiefly cobaltine, associated with arsenical and iron pyrites, in bands of quartz-schist and mica-schist, which Prof. Le Neve Foster defines as beds in altered sedimentary strata, while others describe the formation as gneissic. The bands are nearly vertical, with a N.-S. strike, generally 12-18 ft. wide, and richest where the quartz predominates. In 1882 this mine was producing at the rate of 8000 tons of ore per annum.

The Swedish mines at Tunaberg are similar. The country rock is gneiss, and the vein carries bunches of cobaltine and copper pyrites, with a little galena and limestone. The ore yields 36 per cent. cobalt when sorted and cleaned. Much more important are the Gladhammar mines, a network of veins carrying cobaltine and cobalt bloom associated with copper pyrites, galena, blende, stibnite, molybdenum, and magnetic iron pyrites, in chloritic, hornblendic and micaceous schists.

Other European sources of minor importance are located in France, Germany, Austria, and Spain.

Cobalt is widely distributed in Nova Scotia, and is frequently found in wad (bog manganese), mispickel, copper, and magnetic iron pyrites, but has not been mined commercially.

In the United States it is sometimes associated with the ores of nickel, sometimes with those of copper. At Silver Islet, the mineral macfarlanite, found with the silver ores, yields a small percentage of

cobalt. In Missouri, at Mine la Motte and at the Saint Joe lead mines, cobalt-bearing minerals are found associated with the galena and with nickel in the form of millerite; the cobalt as siegenite, in brilliant octahedral crystals. At the Gap mine, in Lancaster County, Pennsylvania, cobalt is found replacing part of the iron in the pyrrhotite; the percentage is exceedingly small, and the ore could not be worked for cobalt alone. Smaltite occurs in Gunnison County, Colorado, at the mines of the Sterling Mining Company, analysis showing 11.59 per cent. cobalt. Some of the copper ores of western Nevada are also reported to contain cobalt; and it is found in traces in many of the iron ores of Pennsylvania and Virginia. The speiss formed in smelting certain Utah lead ores also contains appreciable quantities of cobalt. But no American ore is worked for cobalt alone, the small amount produced being obtained as a by-product in the reduction of the nickel ores of the Gap mine. These ores are smelted to a matte at the mine, and further treated at the Camden Nickel Works; the small amount of cobalt obtained is worked up into oxide. At Mine la Motte, the cobalt is obtained in a matte produced in smelting the lead ores, the matte being shipped to England and Germany for reduction.

In New Caledonia are found quantities of cobaltiferous manganese ore. Both the cobalt and the manganese occur as hydrated oxides in fragments scattered through a red clay filling pockets in serpentine, the percentage of cobalt in the cleaned nodules being $2\frac{1}{2}$ to 3.

Several methods of treatment are adopted for cobalt ores.

At the Gladhammar mines the ore is hand-picked and then reduced to apple-size in a Blake crusher. After mixing it with slack coal and calcining slowly and at a low temperature for removal of arsenic and sulphur, it is ground very fine in a mortar mill, mixed with alkali, and again roasted at a gradually increasing temperature. When roasted and cooled, it is leached with hot water in a series of tanks. In the uppermost group, the contained iron is precipitated; in the next, the copper is thrown down by adding scrap iron; and finally, the cobalt is removed by powerful filter presses.

Dr. W. Stahl adopts a process which enables him to work up very low grade materials. His method of treatment consists in roasting the powdered ore with salt and pyrites, by which means the cobalt, also copper and manganese if present, are converted into chlorides, whilst the iron is only chlorinated to a very small extent. After the roasting, the ore is extracted with water without any difficulty, and the liquors obtained are treated first with sulphuretted hydrogen, to remove copper, and then from the filtrate the cobalt is precipitated by means of sodium sulphide. The small quantity of manganese and iron thrown down with the cobalt is dissolved from the mixed sulphides by means of a mixture of dilute sulphuric and hydrochloric acids. The following equations represent the changes which take place in the roasting process:—

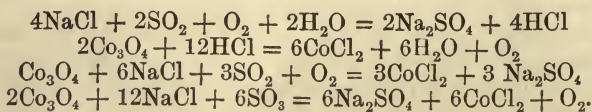

At the works of the Maletra Chemical Company, at Petit Quérilly, near Rouen, France, a new process for the treatment of the cobaltic manganese ore from New Caledonia has been successfully introduced by Herrenschmidt. The composition of the ore, subject to variation in certain of the less valuable constituents, averages: manganese peroxide, 18 per cent.; cobalt protoxide, 3 per cent.; nickel protoxide, 1.25 per cent.; iron peroxide, 30 per cent.; alumina, 5 per cent.; lime and magnesia, 2 per cent.; silica, 8 per cent.; loss in calcination, 32.75 per cent. The operations are entirely performed by the wet way, and the reagents used are to a large extent waste products, arising in the treatment of the ore. The order of operation is as follows:—

The ore, which is comparatively soft, is ground to a fine powder under edge-rollers, and is thrown into large pans containing a strong solution of ferrous sulphate, which is boiled by blowing steam through it. This dissolves manganese, cobalt, and nickel as sulphates, while the whole of the iron, including that in the ore, goes down as basic ferric sulphate together with the silica and alumina. The action continues for some hours, fresh ore being added as required, until the liquor when tested with permanganate is found to be free from dissolved iron. The contents of the pan are then blown over to a settling tank, where the clear liquor is separated from the ferruginous precipitate. The latter is then filtered off, dried, and calcined, giving a powder which is sold as colcothar.

The ferrous sulphate employed in the above operation is prepared on the spot from scrap iron and nitre cake, or the residue (consisting of sodium sulphate and sulphuric acid) obtained in the manufacture of nitric acid. This gives, in addition to the green vitriol, sodium sulphate, which salts are separated by crystallising; the latter may also be utilised at another stage of the process.

The liquors containing cobalt, nickel, and manganese sulphates are transferred to stills made of slabs of the lava from Volvic, in Auvergne, and sodium sulphide is added. This precipitates cobalt and nickel as sulphides, with only a small proportion of manganese, the bulk of the latter metal remaining in solution by reason of the acidity of the liquor. The mixed sulphides when separated are treated with a solution of ferric chloride, which dissolves the manganese, giving a mixture of sulphide of nickel and cobalt nearly free from foreign matters. The manganese in the still liquors is converted into chloride by calcium chloride, and precipitated by lime to be used in the Weldon process.

The sodium sulphide used in this operation is obtained by decomposing the sodium sulphate remaining from the ferrous sulphate with alkali waste in a closed vessel under pressure, the final residue of this operation being calcium sulphate.

The precipitate of mixed sulphides, after the removal of the manganese, is subjected to a very careful roasting in a reverberatory furnace, which, if the operation is successful, results in its complete transformation into sulphates of cobalt and nickel soluble in water.

The product of the last operation, when dissolved in boiling water, is treated with calcium chloride to convert the sulphates into

chlorides, after which the liquor is divided. In one portion (*a*) the metals are precipitated as hydrated protoxides with lime, and after washing to remove the calcium salts, the precipitate is diffused through water and subjected to the joint action of a current of chlorine and of air under pressure, with the result of forming peroxides of nickel and cobalt. A second portion (*b*) of the original protochloride is then added, and the whole is energetically mixed by blowing it up with steam. This has the result of reducing the nickel peroxide in the *a* precipitate, which redissolves as protochloride with the peroxidation and precipitation of an equivalent proportion of cobalt from *b*, so that only nickel remains in solution, while the cobalt is entirely separated. The proportion of *b* is so chosen that the whole of the precipitated nickel is not dissolved, in order to ensure that the liquors contain no cobalt. Further additions of the solution are made in graduated quantities until the cobalt precipitate is completely free from nickel, when it is filtered, dried, and calcined for sale. The various liquors containing nickel are finally collected and treated with lime, the nickel protoxide precipitated is separated by a filter-press, and after drying and calcination is ready for reduction.

The chlorine required in the operation is obtained from a portion of the ore which is used in the stills with hydrochloric acid, in the same way as an ordinary manganese ore. Cobalt, nickel, and iron pass into solution at the same time; the first two metals are recovered, while the ferric chloride is used in the treatment of the mixed sulphides.

The works treat about 150 tons of ore a month and yield about 5 tons of cobalt oxide. The ore being very bulky, it has been proposed, in order to save freight, to convert it into regulus at the mines. Experiments in this direction have been made at the same works, running down the ore with silica and iron pyrites in a water-jacket blast furnace, with the result of producing a regulus with 8 per cent. cobalt, in addition to iron and sulphur, and slags containing all the manganese and only .02 per cent. cobalt. This concentrated material it is proposed to treat in the same way, commencing, however, with the calcination of the mixed sulphide.

The world's production of cobalt is estimated at about 200 tons yearly, New Caledonia alone exporting annually 2500-4000 tons of 3-5 per cent. ore. It is almost exclusively used in the form of black oxide as a pigment, and is worth 9s. to 12s. a lb.

See also Pigments, p. 309.

COPPER.

Not only is copper found in the native state almost pure (a little silver being generally the most important impurity), but its natural combinations are almost endless. Not less than a hundred mineral species may be regarded as copper ores from the practical miner's point of view, i. e. possessing economic value, and there are probably as many more which are not yet utilised. As might be expected, the range of chemical associations is equally wide, embracing sulphides, antimonides, arsenides, oxides, chlorides, bromides, iodides, carbonates, sulphates, phosphates, silicates, arseniates, simple and compound, hydrated and anhydrous, in almost every degree of variety.

In point of richness in copper the most important may be tabulated thus:—

	Cu.	Fe.	As.	Sb.	S.
Copper, native	100
Cuprite, Cu_2O	88
Chalcocite, Cu_2S	79	20
Melaconite, CuO	79
Bornite, Cu_3FeS_3	61	11	25
Malachite, $2\text{CuO}, \text{CO}_2, \text{H}_2\text{O}$	57
Azurite, $3\text{CuO}, \text{CO}_2, \text{H}_2\text{O}$	55
Enargite, Cu_3AsS_4	48	..	19	..	32
Tetrahedrite, $4\text{CuS}_2, \text{Sb}_2\text{S}_3$	36	1	..	26	26
Chrysocolla, $\text{CuO}, \text{SiO}_2, 2\text{H}_2\text{O}$	36
Chalcopyrite, CuFeS_2	34	30	34

But these rich minerals are by no means the most important as regards the commercial supplies of the metal; in fact, in that light they may almost be disregarded so far as affording any considerable proportion of the total yearly output, though, of course, deposits of these rich ores are profitable. The bulk of the world's consumption of copper is furnished by ores of the lowest grade, ranging from little more than $\frac{1}{2}$ to perhaps 5 per cent., though rarely more than 3 to $3\frac{1}{2}$ per cent. For the most part, if not entirely, they may be considered as rocks of sedimentary origin impregnated to a slight degree with particles of native copper or copper ores. Thus the ores (pyritous, arsenical, and silicious) of Devon and Cornwall are worked for $1\frac{1}{2}$ to 2 per cent. copper; those of Cheshire (oxidised copper disseminated in sandstone) for less than $1\frac{1}{2}$ per cent.; those of Mansfeld, Germany (pyritous impregnations in bituminous schists), for little over $2\frac{1}{2}$ per cent.; those of Rio Tinto, Spain (pyrites), for $2\frac{1}{4}$ to $3\frac{1}{2}$ per cent.; those of Maidenpec, Servia (various), for 2 to 3 per cent.; and, overwhelmingly the most abundant producers, those of the Lake Superior region

(native metal scattered through conglomerates and amygdaloids), for as little as .65 per cent.

Formerly the world's supply of copper was drawn from rich ores, containing up to 40 per cent. metal as mined, and further explorations may again reveal in the future similar deposits to replace those now exhausted; but at present and in the immediate future reliance must be placed on the enormous low-grade ore bodies now being worked, especially in North America.

As to the geological conditions under which the various deposits occur, and the manner in which they are worked, it will perhaps be most convenient to adopt a geographical arrangement, in alphabetic order, omitting unimportant cases.

Bolivia.—The well-known mines of Corocoro, worked since time immemorial, are situated in red sandstones of Permian or Triassic age. The mode of occurrence is shown in the sketch section, Fig. 110.* The copper is found as metallic grains or larger masses disseminated irregularly in the sandstone beds, those which are known and worked

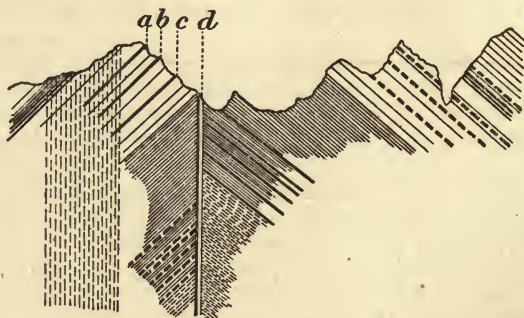

FIG. 110.—COPPER DEPOSITS, COROCORO.

being shown as solid black lines (as: *a*, Veta del Buen Pastor; *b*, Veta de Rejo; *c*, Veta Umacoia), while broken lines represent supposed additional veins. In the centre, a great fault *d* divides the whole metalliferous district into two parts, and has produced both vertical and horizontal disturbance. The fine grained sandstone of the Buen Pastor is impregnated with grains of metallic copper and metallic silver, the latter predominating in value. In the Rejo, the copper is associated with arsenic and sulphur, much of it being as arseniate. On the east side of the line of fault much thinner metalliferous beds ("*ramos*") are found, tolerably constant in strike, but increasing rapidly in dip as the fault is approached.

The ore obtained from the *ramos* is very different and in a much finer state of aggregation than that from the *vetas*; this probably arises from the latter being situated in the midst of much coarser and more porous beds of grit and conglomerates of small pebbles. In both cases the ore is seldom continuous for any great distance, but is found

* After Forbes, Proc. Geol. Soc., Nov. 1860.

scattered through the metalliferous sandstones, in irregular patches or spots of a white or greenish-white colour, full of small grains of metallic copper; the colour of these spots, forming a striking contrast with the deep red colour of the rest of the bed, affords, at first sight, a sure indication of the presence of the metal. This discoloration seems to indicate some chemical change having taken place, apparently connected with the reduction of the copper to the metallic state, and the formation of the sulphate of lime (gypsum) in these beds; and Forbes concluded that this change has been caused by the evolution of sulphurous fumes penetrating into the pores of the strata, at the time of the eruption of the dioritic rocks of Comanche and the Cerro de las Esmeraldas, situated respectively to the north and south of the metalliferous district of Corocoro, and the protrusion of which through these Permian beds caused the fault itself and the accompanying dislocations of the strata. The sandstone he supposes to have been, previously to this disturbance, calcareous, and more especially so in the cupriferous parts, in which he regards the copper as having been present in the state of oxide or carbonate associated with carbonate of lime. Sulphurous acid, by combining with the oxygen of the oxide of copper to form sulphuric acid, would reduce the copper to the metallic state, whilst at the same time the sulphuric acid thus formed, acting upon the carbonate of lime, would produce the sulphate of lime (or gypsum) invariably accompanying these deposits. It is interesting to note that vanadium is present here as in the Permian Kupferschiefer of Thuringia.

The metallic copper is the main object of exploration, and in a state of powder, resulting from the crushing and washing of the cupriferous sandstones, is exported in large quantities to Europe under the name of "copper-barilla." The want of coal or wood in this barren region prevents the ores of copper being worked or concentrated to a sufficiently high percentage for exportation,—the only smelting works being supplied with fuel from the excrement of llamas—it being considered that 100 quintals (each quintal = $101\frac{1}{2}$ lb.) of llama dung will smelt 80 quintals of "copper-barilla"; and the reverberatories are built with two chimneys. The annual product is about 6000 tons of barilla, carrying 66 per cent. copper.

Chili.—While in 1855 Chili was responsible for half the world's production of copper, it now affords about one-fourteenth; the most accessible and richest deposits have been worked out, and mining and metallurgy have not been improved to keep pace with the needs of greater depths and poorer ores. The chief producing districts are Coquimbo, Atacama, Lota, Coronel, Valparaiso, and Tocopilla, in the order named. The principal reduction and smelting works are those of Cousiño & Vattier at Maitenes, of Lambert at Coquimbo, and those of Chañaral, Guaycan, and Tongoy.

Germany.—The chief productive ores are chalcopyrite and copper glance. The pyrites bed in the coal measures of Rommelsberg, near Goslar, in the Hartz Mountains, is a deposit 600 m. long and 80 m. thick, and is composed of copper pyrites, galena, blende, fahlerz, and iron pyrites, with heavy spar, calc-spar, and quartz. It was first worked over 900 years ago.

The most important source of copper in Germany is Mansfeld, on the south-eastern extremities of the Hartz Mountains. The geological formation of this district is exceedingly simple, as, with the exception of an occurrence of melaphyre in the Wepper Valley, the whole region is composed entirely of stratified rocks, of which the "Rothliegende" forms the lowest member, then the "Zechstein," and uppermost the "Bunter Sandstein," which consists of red clay-slates, red sandstone and shales, oolitic beds, and thick masses of gypsum. The Rothliegende forms the base of the "Kupferschiefer" (copper shale). The Zechstein formation consists of two principal divisions, the lower comprehending the "Kupferschiefer-Flötz," or cupriferous seam, and the "Dach," or the Zechstein proper; while the upper consists of "Stinkstein," "Asche," and "Rauchwacke," with gypsum and various clays.

The bituminous marl constituting the copper schist, or shale, lies with great regularity on the Rothliegende. The metalliferous contents of the schist occur as a rule in the form of a "Speise," or very fine particles, which in transverse fracture give a metallic reflection in sunlight. A golden colour shows a predominance of chalcopyrite; a violet, blue, or copper-red colour, the presence of erubescite; more rarely the colour is steel-grey, from copper glance; and sometimes bluish-grey, from the presence of galena. The Speise consists principally of sulphuretted ores of copper, but there also occur argentite, blende, galena, and iron pyrites. Although none of the layers of Kupferschiefer is barren, it is only in a few bands that the ore occurs in workable quantities. The thickness of the productive seam varies from $2\frac{1}{2}$ to 5 in., and contains 2 to 3 per cent. copper with 5 to 10 lb. silver to the ton of copper.

From the report recently issued by the "Mansfeld'schen Kupferschieferbauenden Gewerkschaft" for the year 1891, it appears that the quantity of copper shale mined during the year was 521,696 tons, which included 51,719 tons of "Dachberge" (an inferior quality shale), or a decrease of 14,793 tons from 1890, due to the inability to get rid of the water in the lower levels. They were thus forced to work, at a greater cost, the higher levels, which are much poorer in both copper and silver. The cost of mining amounted to 38.21 marks (about 39s.) per ton, which was 2.29 marks more than in 1890. The total quantity of ground excavated was 1,533,500 sq. m., or 102,600 sq. m. less than in the previous year, which makes 2.94 sq. m. to the ton of shale. At present, of a total quantity of 11,562,100 sq. m. of excavated ground, 3,793,700 sq. m. are under water. The furnaces altogether smelted 512,828 tons of shale, against 543,470 tons in 1890. The black copper production was 39,331 tons, against 40,854 tons in 1890. The yield per ton of shale was 75 *k* (165 lb.) black copper. The copper yield was 30.45 *k* (70 lb.) copper, and .18 *k* ($4\frac{3}{4}$ oz.) silver per ton.

India.—A recent writer* has described extensive copper workings in Singhbhum, Hazaribagh, Kulhari, and Singhana districts, which seem to deserve attention.

Nova Scotia.—At numerous points the sandstones and shales

* 'Times of India,' Oct. 25, 1890.

present irregular bedded masses and layers of copper ores, principally grey sulphurets, with films and coatings of carbonate, and associated with fossil plants, to whose presence their deposition is attributed. Hitherto, attempts to find them in workable amounts have not been successful, though a Permo-carboniferous sample from Carribou, near Pictou, gave 40 per cent. copper, $25\frac{1}{2}$ sulphur, 11 iron, 2 cobalt, 1 lime, $\frac{1}{2}$ manganese. In the Triassic formation, most noticeably at Margaretville, copper ores, principally carbonates with native copper, are found in veins in the trap and ash. These veins have been explored several times without success. No records have been made of the "low-grade" values of these rocks, but there is reason to suppose from the frequent occurrence of copper ores over so wide an extent of territory that, locally, beds may be found carrying the disseminated metal in amounts of economic value.*

Persia.—Copper is very plentifully distributed throughout Persia,† and close to Semnan is a very interesting deposit, where considerable quantities of copper exist, chiefly as carbonate, with a little sulphate and oxide. The ore is found in small veins and disseminated through a clay stone which, in some cases, is still quite plastic, in others is so highly silicified as to resemble agate and jasper. It has clearly been deposited by the action of mineral waters, as there can be seen layer after layer of material permeated throughout by salts of copper. In some cases the little seams or veins of copper carbonate are over $\frac{1}{2}$ in. thick. The workings are very rough and irregular, but go down a considerable depth, and at a fairly steep angle; layer after layer of the copper-bearing stuff being passed through, with comparatively barren ground between. The deposits are very similar to some in the State of Guerrero, Mexico, where the ore occurs in precisely the same class of formation, further proof of the mineral-spring character of the deposits being in each case given by the seams of crystallised gypsum which are found with the copper salts. Average samples gave 2–3 per cent. copper.

Scandinavia.—What will probably prove to be very important copper deposits exist at Sulitelma, but have hitherto been undeveloped owing to transport difficulties. The pyrites carry a small percentage of zinc, but are very free from other impurities, and cement copper made from these is entirely devoid of antimony, arsenic, and bismuth.

Spain.—The celebrated cupriferous pyrites beds of Rio Tinto, San Domingos, and Tharsis occupy a great metalliferous belt, over 100 miles long and 30 miles wide, partly in Spain and partly in Portugal. The country rocks are Upper Devonian slates, striking 15° to 25° N. of W. and with a nearly vertical dip, often much altered into talc schist, &c., by intrusions of quartz, quartz-syenite, granite, diabase, and felspar porphyry. There are four principal "lodes" (? bedded veins), all occurring at or near the junction between the porphyry and the slate, and attaining sometimes to the enormous thickness of 450 to 600 ft. Fig. 111 illustrates the formation: *a*, pyrites vein,

* E. Gilpin, "Geological Relations of Nova Scotia Minerals," Trans. Amer. Inst. Min. Engs., 1889.

† J. Mactear, "Notes on Persian Mines," Trans. Inst. Min. and Met., iii.

worked out at *b*, and capped by gossan *c*; *d*, slates; *e*, porphyry. The minerals composing the vein matter vary continually, and embrace the sulphides of iron, lead, and zinc, as well as most varieties of cupreous pyrites. The mining operations are conducted on an enormous scale, probably the largest in Europe. In the magnesian limestones of Permian age, in Asturias, are very extensive deposits of melaconite giving 75 per cent. copper when separated, and the whole mineral mass assaying over 6 per cent.



FIG. 111.—COPPER DEPOSITS,
RIO TINTO.

United States.—The copper of the Lake region (chiefly Michigan state) occurs native, with some silver, in both sedimentary and interstratified igneous rocks of the Keweenaw system; as a cement, binding together and replacing the pebbles of a porphyry conglomerate; or filling the amygdules in the upper portions of the interbedded sheets of igneous rock; or as irregular masses, sometimes of enormous size, in veins, with a gangue of calcite, epidote, and various zeolites; or in irregular masses along the contacts between the sedimentary and igneous rocks.*

Of the three principal mining districts—Keweenaw Point, on the end of the Point; Portage Lake, in the middle; and Ontonagon, at the western base, Portage Lake is now almost the only producer.

In the Keweenaw Point district most of the mines are on original fissures, which have later become much enlarged by the alteration of the walls. They are usually 1 to 3 ft. broad, but may reach 30 ft. in the looser textured rocks, and these expansions are also richer in copper; the veins stand nearly vertical and cross the beds at right angles, while the metallic masses, both large and small, occur distributed through the gangue. The best known mines are Cliff, Phoenix, and Copper Falls.

In the Portage Lake District the mines are either in conglomerate (Calumet and Hecla, Tamarack, Peninsula, &c.) or in amygdaloidal, strongly altered diabase, certain very scoriaceous sheets of which are known as ash-beds (Quincy, Franklin, Atlantic, &c.). In the conglomerates the copper has replaced the finer fragments, so as to appear like a cement, and often the boulders themselves, or particular minerals in them, are permeated with copper. The metal occupies the small cavities of the amygdaloids, and in the open or shattered rock it fills all manner of irregular spaces, often in fragments of great size; it is associated with calcite, zeolites, epidote, and chlorite.

In the Ontonagon district the copper follows planes approximately parallel to the bedding of the sandstones and igneous rocks, and in one mine at least (National) along the contact between the two; it is quite irregular in its distribution, but has the same associates.

In practice the mines are classed as “mass,” “amygdaloid,” and “conglomerate,” according to the size of the masses of copper or to the character of the enclosing rock. The original source of the copper was thought by early investigators to be the eruptive rocks themselves, and that with them it had come in some form to the sur-

* J. F. Kemp, ‘Ore Deposits.’

face, and had been subsequently concentrated in the cavities. Pumpelly referred it to copper sulphides, distributed through the sedimentary as well as the igneous rocks, from which circulating waters have leached it out as carbonate, silicate, and sulphate. Although the traps are said by Irving to be devoid of copper except as a secondary introduction, it is probable that their basic minerals may be its source.

While the deep explorations on these wonderful deposits, which have now attained a depth of 4000 ft. from the surface, show the copper contents to be well maintained, it is noteworthy that the quality of the metal, at least for electric purposes, is not up to its former high standard. The great reduction in the cost of electrolytic refining and the high quality of the product render the trade less dependent on Lake copper, and widen the field from which high-quality metal can be drawn.

As an example of the low point to which cost of production has been brought on these mines, the following figures (1891) relating to the Atlantic mine are quoted from Birkinbine:—

Total rock stamped	297,030 tons
Concentrates produced	5,089,700 lb.
Refined copper produced	3,653,671 lb.
Yield of copper per ton	12·3 lb.
" per cent.	·615
Gross value of product per ton	\$1·5467 (6s. 3d.)
Cost per ton of mining, selecting, and breaking	\$0·9529
" transportation	\$0·0386
" stamping and separating	\$0·2582
" freight, smelting, &c.	\$0·1847
" construction account	\$0·1107
" total	\$1·5451

The stamping in this case is done by 5 Leavitt steam stamps with 18-in. cylinders. The aggregate product of these stamps is 1000 tons a day. The ore, when it comes up from the mine, is first picked over by hand, to remove barren rock, and then crushed to about the size of broken coal. The cost of treating the ore, from the time it is dumped at the shaft mouth to the time it arrives at the stamps in the concentrating mill, is about 7 c. ($3\frac{1}{2}d.$), so that the total cost from the shaft mouth to the smelting operation is 33 c. ($1s. 4\frac{1}{2}d.$) per ton of rock suitable for milling.

Following is a summary of the Wolverine mine, for 1894:—

Rock hoisted	108,220 tons
" stamped	76,440 tons
Mineral produced	1,852,235 lb.
Refined copper produced	1,611,857 lb.
Yield of copper per ton stamped	21·08 lb.
" per cent.	1·05
Cost per ton of rock hoisted	\$1·145 (4s. 9d.)
" " stamped	\$1·625 (6s. 9d.)
Sinking	279·2 ft.
" cost per ft.	\$11·18 (46s. 7d.)
Drifting	2304·6 ft.
" cost per ft.	\$5·97 (25s.)
Stoping	4587·7 fathoms
" cost per fathom	\$8·89 (37s.)
Rock discarded as poor	31,780 tons
" per cent.	29
Yield of copper from mineral, per cent.	87·02

In the Butte, Montana, copper region, the veins seem to have been originally fissures or shear zones—but greatly enlarged by replacement of the walls with ore—filled with copper sulphides (bornite, chalcopryrite, &c.) in a silicious gangue. Much silver is associated with the copper. At Butte is a north and south valley 6 miles wide between high granite ridges on the east and lower rhyolite ridges on the west, and near the middle of this valley rises the butte of rhyolite which gives the town its name. In the half of the valley east of the meridian of the butte is a very dark basic granite, consisting of quartz, orthoclase, plagioclase, and an unusual amount of mica, augite, and hornblende. In the part west and south of the butte is a highly acidic, light-coloured granite, containing quartz and orthoclase felspar with very little biotite. Quartz-porphry dykes penetrate the basic granite, and rhyolite dykes are encountered in the ore bodies. In the coarse granite east of the butte occur two distinct east-west ore zones: the northern contains silver ores (chiefly sulphides of iron, lead, silver and zinc) in a silicious gangue with much rhodonite; the southern affords argentiferous copper ores (bornite, chalcocite, chalcopryrite, enargite, pyrite) in a silicious gangue. Scarcely any copper is met with in the N. zone, and no manganese in the S. zone (except with zinc in the Gagnon vein), thus presenting the remarkable phenomena of two parallel and adjacent systems of fissures in the same country rock being filled with very different ores. West of the butte in the acidic granite is a later-developed zone carrying silver and manganese. As regards the source of the metalliferous minerals, it is probably to be sought in the eruptive rocks, for Emmons found * .06 oz. silver per ton in the rhyolite and .09 oz. in the butte granite.

The yield of copper from the rock raised in Montana averages about 7 per cent. as against less than 2 per cent. in the Lake region, but wages rule nearly double. The following figures relating to some of the Montana mines, though lacking in detail, are nevertheless interesting:—

Mine.	Tons Ore raised.	Cost of Mining.	Cost per ton.	
			\$	s. d.
Colusa-Parrot	16,640	\$ 32,840	1·97 =	8 3
Elm-Orlu	305	665	2·18 =	9 1
Black-Rock	2,795	13,255	4·74 =	19 9
Parrot	53,155	184,575	3·47 =	14 5
Original	9,405	40,805	4·33 =	18 0
Glengarry	17,000	51,000	3·08 =	12 6
Moulton	940	7,403	7·87 =	32 9

The average is \$3·29 (14s. 8d.) for the mines quoted, and Dr. Ledoux has estimated the mean cost of mining in the Butte district at \$3 (12s. 6d.) per ton.

The Arizona and New Mexico mines have enjoyed an advantage

* S. F. Emmons, "Notes on the Geology of Butte, Montana," Trans. Amer. Inst. Min. Engs., xvi. 49.

in having ores yielding (in 1889) over 10 per cent. copper, and, being oxidised for the most part, they were readily reduced to black oxide.

The Santa Rita mines are found near the contact of a limestone and a large bed of eruptive rock, to all appearances a felsite. The original openings were on native copper, cropping out in the felsite. The copper occurs in small pellets or shots scattered through the mass of felsite, or in small flakes, leaves, or tabular masses, sometimes as much as 2 ft. square, and not generally over $\frac{1}{4}$ in. thick. The presence of these leaves and flakes precludes the idea that the copper is of the same age as the felsite, and an integral part of this eruptive rock. The copper has undoubtedly been deposited subsequently to the eruption of the felsite, and in fissures formed at a later date. The native copper must, therefore, be held * to occur in true fissure veins, although the irregularity of the deposition has been such that no distinct vein can be found, and the copper-bearing rock presents rather the appearance of a *stockwerk*, having, however, a general E.-W. strike and almost vertical dip. In places near the surface, the native copper is altered into a beautiful pure red oxide. Near the line of junction of the felsite and limestone is a parallel series of veins, in which the ores assume an entirely different character (carbonates and oxides) and were formerly profitably mined and smelted, but in depth, the rich oxides pinched out.

The mines of the Clifton district form three classes, occurring in (a) Lower Carboniferous limestone, (b) porphyry, and (c) granite. The ores of a are oxides, primarily the red oxide or cuprite in a gangue of compact hematite, and malachite and azurite in a gangue of manganese ore (wad). The ores of b and c are oxides and oxysulphides on the surface, changing into copper glance at a trifling depth, and into yellow sulphurets in the deepest workings. While in extent and number the veins of b and c are considerably larger than of a, the latter are, by far, the most valuable and productive. One of the most important mines is the Longfellow, which is an almost vertical fissure in stratified limestone, at or near the junction with a dyke of felsite. In places the vein, or branches of it, are at the contact of the limestone and felsite, there forming a true contact-vein. Again, branches of the vein are entirely in felsite, and other branches entirely in limestone. The formation is illustrated in Fig. 112: a, felsite; b, limestone; c, sandstone; d, porphyry; e, deep adit; f, upper adit. On the rise of the vein above the upper adit large chambers of mangiferous ore containing blue and green carbonates of copper were found, averaging in bulk 17.17 per cent. copper, 26.80 SiO₂, 15.29 Fe₂O₃, and 7.49 MnO. Fine bodies of rich oxidised ores have been worked in the porphyry to a depth of several hundred feet, but have always pinched out and got lean.

The ores of classes b and c being found in a silicious country-rock, have a more silicious gangue, and contain more or less sulphur. Their development at Metcalf Hill is shown in Fig. 113; at the surface they form a *stockwerk a* in the porphyry b, while in depth all the

* A. F. Wendt, "Copper Ores of the South-west," Trans. Amer. Inst. Min. Engs., xv. 23.

small branches, covering 100 ft. wide in places, unite to form a single vein *c*, which rapidly deteriorates on sinking.

The Coronado mines, of the same class, are found in a huge dyke of quartz-porphry cutting through syenite and granite, the latter abutting against and being surrounded by stratified limestone. They present an extreme case of rapid depreciation in depth. Average samples at surface gave 6 to 45 per cent. copper, and at 200 ft. the vein is 5 to 15 ft. wide. It is illustrated in cross-section in Fig. 114:

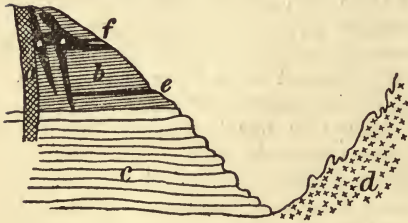

FIG. 112.—COPPER DEPOSITS,
LONGFELLOW.



FIG. 113.—COPPER DEPOSITS,
METCALF HILL.

a, ore; *b*, quartz-porphry; *c*, granite; *d*, granite and syenite. In places the walls are very smooth and striated. Usually they are decomposed and kaolinised for some distance into the quartz-porphry; where not so decomposed, the vein is of inferior quality. Indeed, it can be laid down as a law,* both for this mine and for all others through the south-west, that indications of an extensive decomposition

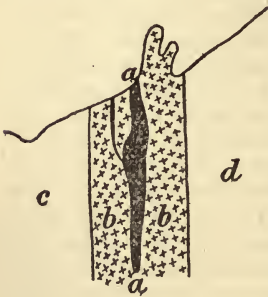

FIG. 114.—COPPER DEPOSITS,
CORONADO.

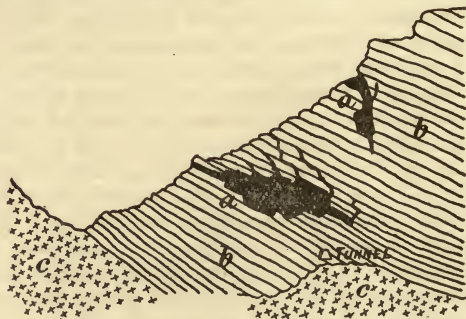

FIG. 115.—COPPER DEPOSITS, WARREN
(BISBEE).

of the country-rock are favourable to the finding of large ore-bodies. From the very nature of things this must be expected, for this decomposition is an accessory to the deposition of the ore. The copper glance in the Coronado mines usually occurs massive. In the Horse-shoe, where the vein is 15 ft. wide, it occurs in minute particles

* A. F. Wendt, *op. cit.*

scattered through the gangue, which is practically a matrix of kaolin with imbedded rounded particles of quartz, undoubtedly in its original form a quartz-porphry. Wherever the copper glance in the Colorado mines has been followed down, it disappears at a depth of 150–200 ft. from the surface, and either the vein becomes barren or the glance is replaced by yellow sulphurets, sparingly disseminated through the gangue. Experimental concentrations of these yellow sulphurets gave assays of 8 per cent. The average composition of the silicious ores is 11–22 per cent. copper, 49–67 per cent. SiO_2 , and 7–9½ per cent. iron.

The mines occurring in granite are few and unimportant. The ore is copper glance in a vein 10 ft. wide, with good walls but very irregular mineralisation.

In the Warren (Bisbee) district, the principal mines are associated with Lower Carboniferous limestone and felsite-porphry. Here, too, a distinction can be made between veins and ores found in the limestone and those in the silicious or eruptive rocks. The ores of the latter are silicious, and within a few feet of the surface change into copper glance and at greater depth into pyrites; the ores of the former are oxidised, and at a depth of over 400 ft. no trace of sulphur has been discovered. All occur in true fissures;* and the two principal producing mines of the district in every particular carry out the description of “bed-veins” given by von Cotta. “The outcrop of the ore starts between the bedding of the limestone; and, as Cotta remarks, the ore-bodies might be mistaken for ore-beds and not bed-veins, were it not for the presence of spurs into the walls.” The spurs in these ore-deposits usually follow the planes of bedding of the limestone. The limestone generally occurs in blocks, and the ore then follows the plane of bedding until it comes to a cross-seam from one bed to the other, when the ore will sometimes jump to the next seam. In places these seams are several inches or even a foot wide, and completely surround blocks of limestone; and the vein then assumes the character of a stockwerk. In other places, what have evidently been vugs and caves in the limestone have been filled by the ore. Fig. 115 illustrates the formation: *a*, ore-bodies; *b*, limestone; *c*, felsite-porphry.

Wendt doubts* whether the ores of this district have ever been sulphurets in their present position. The whole deposition tends to prove that the ores are not a secondary decomposition or alteration of what was formerly sulphurets, but have been precipitated as carbonates from an acid solution which carried them from the depths below. The origin is probably in the eruptive rock, which contains considerable quantities of disseminated particles of pyrites.

The mining of the great ore-bodies of the Bisbee (Warren) district, notably those of the Copper Queen and Copper Prince mines, has been carried out in a very systematic manner, entirely different from that of the Clifton district, where the Mexican system of mining ruled for many years. The plan adopted generally is underhand stoping and timbering in square sets (see p. 86). Sawed Oregon or Huachuca pine, usually 10 or 12 in. square, is used, and the sets are made 7 ft.

* A. F. Wendt, *op. cit.*

high and 5 ft. from centre to centre. Even with this heavy timbering occasional crushing takes place. In 1883 the cost of mining—including all expenses, such as timbering—was about 8.50 dol. (35s.) per ton. The cost of smelting amounted to about 10 dol. (42s.) per ton of ore treated, and the yield of the ore was about 12½ per cent. Since then the yield of the ore has fallen below 10 per cent.; but the cost of mining has come down to 6 or 7 dol., and of smelting to 8 dol., so that the cost of metal on the spot from 10 per cent. ore should not exceed 7½ c. (3¼d.) a lb.

In the Globe district, the Old Dominion mine is in a fissure in bedded sandstone dipping 15°–20° S., the vein striking N.E.–S.W., dipping vertically, and measuring 2 ft. wide, with many barren patches. The sorted ore carries 20 per cent. copper, with considerable arsenic and antimony, and some gold and silver; it is silicious, and requires much flux.

The vein of the Globe mine is in a fissure crossing Carboniferous limestone, near an upheaval of diorite, which forms the footwall of the ore-body in part. Near the contact of diorite and limestone, the rock is decomposed, kaolinised, and very soft and unctuous. When the great ore-body is entirely in limestone, the latter is discoloured. The diorite is undoubtedly eruptive, and the ore found entirely in it (copper glance) pinches out rapidly in depth. Wendt considers it a true fissure vein, of chimney-like form, dipping almost parallel with the contact of diorite and limestone, and pitching 45° S. Timbering

is done by square sets (12 × 12 in.), and dead work is minimised. The mine is illustrated in Fig. 116: *a*, ore; *b*, limestone; *c*, diorite; *d*, incline shaft; *e*, levels.

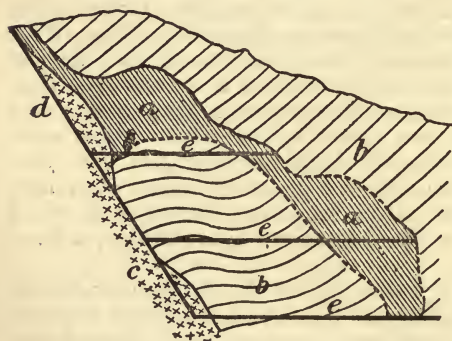

FIG. 116.—COPPER DEPOSITS, GLOBE.

The Black Copper group of veins occur in a belt of gneiss rock, cut by a dyke of diorite, occasionally intersected by a subsequent intrusion of trachyte. The gneiss for a width of some 40 ft. is cut by innumerable small veins and strings of copper-ore, fol-

lowing generally the strike of the gneiss, and dipping, a little faster than that rock, towards the diorite dyke close by. The shaft sunk in the gneiss, shown in Fig. 117, exhibits the system of veinlets very clearly. The ore in the shaft and on the surface is malachite and chrysocolla. The widest of the seams is only 2 in., and the whole mass forms a *stockwerk* too poor to pay for working. Down the hill from this system of veins or *stockwerk*, and below the diorite dyke, a vein of ore is found lying almost horizontally in the drift. Analyses prove it to be a typical chrysocolla. It is undoubtedly of secondary origin, and derived from the veins up the hill near the diorite. It has been

stripped in a number of places, and has been found, by cuts sunk through it, to have a thickness of 4 ft. of pure chrysocolla. The occurrence is remarkable, as showing the formation of a bed of copper ore in very recent times, and in the wash. In Fig. 117, *a* is the shaft; *b*, surface copper; *c*, diorite; *d*, gneiss; *e*, wash; *f*, chrysocolla.

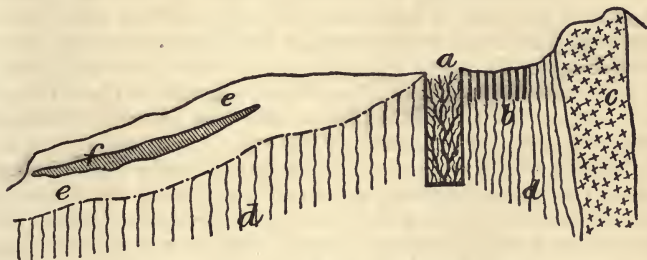

FIG. 117.—COPPER DEPOSITS, BLACK COPPER.

Copper Basin is a region of cupriferous impregnation covering about 40 acres, and geologically simple. The foundation rock is coarse-grained granite and gneiss, with soda-felspar predominating; there are also porphyritic dykes and a large pyritiferous quartz vein. Superimposed on these are horizontal beds of conglomerates, breccias, and sandstones, largely consisting of fragments of the plutonic rocks, and forming repositories for copper ores, which are the cementing ingredient. The ores are azurite and malachite, and they coat the fragments of rock as well as forming the matrix. The beds are 3 to 10 ft. thick, and yield up to 12 or 15 per cent. copper. These copper-depositions are clearly the result* of the gradual percolation of copper solutions (probably sulphate) passing through the porous sand-rock; and the copper carbonate is a deposit of incrustation, not of replacement, for, so far as the sandstones and the conglomerates have influenced the deposition, the action appears to have been mechanical rather than chemical. The surface, rather than the chemical composition of the strata, appears to have determined the deposition. Nor does it appear that the copper carbonate has replaced any calcareous or silicious cement. The absence of a cementing material seems to have favoured the infiltration and distribution of the cupriferous solution, which may have been gradually concentrated by evaporation on the surface of the coarse grains of rock. Now as to the source of such extensive depositions of copper. The granite below the cupriferous beds, and throughout the copper area, is very much decomposed and softened. Numerous veinlets and thin seams of red oxide of copper, accompanied by malachite, and malachite disseminated in small nodular or concretionary masses not much larger than kernels of maize, occur in the soft ferruginous clay resulting from the decay of the granite. These little button-like discs of malachite are so abundant that they could be washed out with profit if water could be led upon the ground. Also considerable quantities

* W. P. Blake, "Copper Deposits of Copper Basin," *Trans. Amer. Inst. Min. Engs.*, xvii. 479.

of red oxide of copper in thin sheets, with malachite on each side, form numerous small veinlets ($\frac{1}{2}$ -1 in.) traversing the granite; the red oxide is in the middle and the malachite on each side next to the granite walls, and the central oxide is sometimes replaced by sulphide.

At Copperopolis, California, large beds of copper pyrites are found in Jurassic slates, showing no trace of gold or silver. At Spenceville, a vein 230 ft. long, 40 ft. wide, and worked to 150 ft. deep, occurs in diabase near its contact with granite. The Tiptop mine is on a series of parallel faults in quartz-porphry; the ore was much oxidised (iron) at surface, and carried 30 oz. silver per ton, but at 80 ft. shows entirely copper pyrites and silicious rock low in silver, with sometimes masses of native sulphur.

In Moleje, Lower California, extensive deposits occur in rock of very recent origin, overlying a bed of trachyte of unknown depth. While the ore-beds extend over a very large territory, the valuable portions cover a comparatively limited area, and the pay-ore occurs in shutes or chimneys in the beds, having a width of 75 to 150 ft., and a general N.W.-S.E. course. The stratum carrying the ore is a soft ferruginous clay, mixed in many places with oxide of manganese, and in others intersected in every possible direction by small seams of gypsum. The foot-wall or floor of the different ore-beds is always a conglomerate. The hanging-wall or roof is either clay or soapstone, or more generally a mixture of both, which readily crumbles when exposed to the air. The ores differ very widely in composition and appearance; in fact, a great many of the ores have not the characteristic appearance of ore at all, but look like yellow clay. True copper ores varying from copper glance to green and blue carbonates do, however, occur. Malachite forms the bulk of the ore; and wad or cupriferos oxide of manganese occurs in the next largest quantity. The thickness of the ore-beds varies considerably, from a mere seam to 3 ft.

At Gilpin county, Colorado, occur veins of pyrite and chalcopryrite, following the cleavage joints of the gneiss (or granite), and replacing the country rock on each side of them; they are highly auriferous, and worked primarily for gold, the concentrates from the stamps being afterwards treated for copper.

At St. Genevieve, Missouri, large beds of chalcopryrite associated with chert occur in magnesian limestone of Lower Silurian age.

In Tintic District, Utah, three great ore belts occur in vertical beds of magnesian limestone, apparently deposited along the bedding planes, though often cutting across them; the productive areas are irregular in size, shape and frequency. (See Silver.)

Deposits at the contact between Triassic sandstone and diabase seem to be always lacking industrial value, and the same remark would seem to apply to contact beds with gneiss and schistose rocks replacing the diabase.

Treatment.—Hardly any copper ores raised now-a-days are so rich as to be at once treated for the extraction of the metal, and all have to undergo a preliminary enriching process by removal of waste.

Concentration.—The character of the ore determines the method and degree of concentration needed.

Hand sorting is simple and effective but rarely applicable. At Vigsnaes it is adopted, boys being employed to separate the ore as raised into three grades:—(a) Clean lump pyrites, carrying 2–2½ per cent. copper; (b) pyrites mixed with waste; (c) waste.

Crushing ordinarily has to be resorted to in the first place to prepare the mineral for separation, and should be so adjusted that the requisite fineness is attained but not exceeded. Breakers and rolls (dry) are generally employed, though fine reduction with stamps is often used on sulphides, but would produce too much slime with the softer (oxidised) ores.

Dry winnowing or “dousting” is useful where the ore is more friable than the gangue, e.g. the chalcopyrite and erubescite at the Cape copper-mines, Namaqualand. The ore is first cobbled and classed into (a) prile, (b) best dredge, and (c) crusher dredge; a is finished product; c is crushed, jigged, and buddled; b is dousted, or, after reducing in rolls to 8-mesh, dry-sifted in fine mesh hand sieves, whereby the bulk of the ore is separated as fine powder, the coarser residue being subsequently re-crushed, jigged, and buddled. About one-third of the 700 tons monthly of 30 per cent. ore there produced is thus obtained.

Wet concentration embraces sizing in trommels and hydraulic separators, jigging, buddling, vanning, &c. In Japan, hand washing in wooden bowls by women at 3½d. a day is found cheaper and more thorough than machine work, but of limited capacity.

At the Lake mines the process followed is briefly this. Dressing really commences underground. On reaching surface, the ore is dumped on to grizzlies or gratings lying at 45°, the bars of 1½ in. iron being 4–6 in. apart. The portion falling through goes to the stamp bins; that passing over is hand-fed into a 14½ in. Blake. Lump copper when encountered must be picked out before entering the breakers. The stamps are fed automatically by a shaking tray, which, however, requires constant supervision. The annexed figures compare results at three of the important Lake mills:—

	Atlantic.	Tamarack.	Calumet and Hecla.
Number of stamps	5	5	22
Pattern of stamp	Ball	Allis	Leavitt
Foundations	Solid and spring.	Solid	Solid
H.P. per stamp, about	140	..	150
Force of blow in foot-tons, about	21	21·4	20
Tons crushed per day per stamp	210	300	..
Character of rock	Amygdaloid	Conglomerate	Conglomerate
Water used per ton	7200 gal.	35–40 tons	..
Life of shoe	3000 tons or 14¾ days	3–4 days worn from 700–200 lb.	5–6 days
Life of screen, about	8820 tons, or 42 days	3–5 weeks	1 month
Character of screen	4 cast steel plates, 9½ × 48 in. × No. 11; slot holes 5/16 in. long.	4 plates steel 9 × 25 × 1/8 in.; 3/16 in. punched holes	Steel plates; 3/16 in. round holes

Three patterns of steam stamps are used at the present time—the Ball, the Leavitt, and the Allis, the first being the oldest. The character of the rock from the different mines varies so much that unless there were various stamps in the same mill, and working on the same rocks, a comparison would be valueless. The capacity of the steam stamps is enormous, and the amount of water required to remove the crushed rock from the mortar is also very large.

The rock is crushed to pass holes varying in diameter from $\frac{3}{16}$ in. to $\frac{5}{16}$ in., depending upon the character of the rock under treatment. Crushing thus fine does not liberate all the copper from its gangue. In fact, it would be almost impossible to crush the conglomerate fine enough to do so. The size of the opening in the screens used at the various mills has been determined by experiment to be the most economical for that particular ore. Crushing finer would, of course, decrease the capacity of the stamp, hence it is best to use as coarse a screen as the ore will permit. The copper that yet remains attached to particles of rock is not lost. A large portion of this material, called the ragging, is caught on the jigs and either returned to the stamps or treated in some grinding machine.

The wear of the shoes, made of chilled cast iron, though it appears very rapid, is actually very small when compared with the amount of work done by them.

As the ore passes through the screens of the stamp it is collected by a splashbox, and drops into a launder leading to the separators. This launder divides the ore stream into 3 equal portions, one being delivered to each of the separators. The separator at the Atlantic mill consists of a V trough about 15 ft. long, 18 in. wide and 18 in. deep. Near the bottom, and at the front of each separator, are 4 small pipes discharging upon the screens of 4 jigs just opposite them. In the axis of the separator and opposite to each outlet is a vertical $1\frac{1}{2}$ -in. pipe, supplied with water from above and opening downward about 2 in. from the bottom of the separator. Between each of these pipes lies a bed of copper, deposited in the regular working, and allowed to remain there. As the ore enters the separator it passes over these beds of copper, coming successively in contact with the rising currents generated by the supply pipes mentioned. The head of water in each successive pipe is less, so that the heavy particles of copper and gangue will fall into the cavity around the first, and pass through the small opening in the front and spread themselves upon the roughing jig. In the second cavity less heavy particles will fall; in the third, still smaller grains. The ore which passes the fourth division of the separator is classed as slime, and goes to the settling tanks. The separation is very incomplete. Following each separator are 4 roughing jigs, each having 2 screens; thus the ore from each separator is treated from a set of 8 screens, each set doing exactly the same work. The hutch-work from the roughing jigs passes to 12 finishing jigs, placed at a lower level, all of which do different work.

The product may generally be classified as 50 per cent. coarse (over $\frac{1}{16}$ in.) sand, 15 medium, 10 fine, and 25 slimes.

The Anaconda mill, Montana (capacity 3000 tons a day), uses 14 steam stamps. The concentrating plant is in a building 262 ft. ×

136 ft., steam-heated by 150 h.p. boilers; it consists of two 20 × 10 in. and four 10 × 7 in. breakers, and three sets of 26 × 15 in. rolls. The pulp is concentrated on Collom jigs, the middlings are re-crushed in rolls, the fines are dressed on double buddles 16 ft. diam., and the slimes go to Frue vanners.

Solution.—Wet methods of extracting copper are applicable when:—

- (a) The percentage of metal is very low.
- (b) Injurious impurities (as antimony and arsenic) are present.
- (c) Associated metals would be lost by smelting.
- (d) Dissolving and precipitating agents are obtainable at low cost.

The first step is oxidation, unless the ore is already a carbonate or oxide. In its simplest form, this consists in exposing the raw pyritous ore in a moist state to the influence of the air, and is often hastened by pumping water with some force (thus carrying entrapped air) into the ore heaps. But the process requires years for its completion with most ores. Considerable copper is recovered from mine waters in which the operation has taken place naturally, the copper contents varying from .08 to .50 gr. per gal. in cases where they are utilised.* Such waters are well adapted for moistening ore heaps. Sometimes about 1 per cent. of salt is added to the heaps, to hasten oxidation, render the copper more soluble, and chloridise small traces of silver; heat aids the operation very much. Adding manganese oxide is a doubtful benefit. Occasionally acid liquors may be used on carbonate and oxide ores contained in rock not attacked by the solvent, and where the acid is a waste product or very cheap, e. g. as recommended by Blake at Copper Basin, Arizona.

Oxidation by heat ("burning") is much more rapid, and is applicable to ores rich in sulphur and poor in copper, the sulphur forming the fuel. It is done in two distinct ways—(a) in kilns, with the object of utilising the sulphurous acid generated, the "cinders" being afterwards treated for their copper; (b) in open-air heaps or *teleras* as at Rio Tinto, by which much SO₂ is wasted and creates a nuisance. The *telera* consists of rude stone flues built on the ground, 15–18 in. high, 12–15 in. wide, extending to stone chimneys at their intersections, and covered loosely with flat stones. Upon these are piled lumps of pyrites progressively decreasing in size as the height grows, till at 12–15 ft. the heap is coated with a layer of smalls. Ignition is produced by lighting brushwood and logs in the flues, and combustion proceeds for 6–12 months. A single *telera* may contain 800 to 1500 tons. The cost of the operation ranges between 1s. 3d. and 2s. a ton, and the product is a mixture of copper and iron sulphates, which are extracted by washing either in the mass or in tanks. By the latter method, $\frac{2}{3}$ of the metal in a 2½ per cent. ore can be recovered at once and the bulk of the rest by repeated washings at yearly intervals.

Maidenpec (Servia) ores are too small, and contain too much

* The most important contribution to recent literature is a paper by J. H. Collins on "Economic Treatment of Low-grade Copper Ores," in *Trans. Inst. Min. and Met.*, ii. 5.

silica and too little sulphur for the *telera* method, but by making briquettes, duly dried and hardened, they can be burned in 300 ton heaps, though consuming more fuel and taking more time.

Open-air burning is only applicable to ores containing a limited proportion of fines, but little rich sulphide (as chalcopyrite), not under 20 per cent. sulphur, and not over 20 per cent. silica.

Chemical methods of hastening oxidation have received much attention, being led up to by observing that ferric liquors obtained by washing burned ore aid in oxidising and rendering soluble the copper in raw ores, on prolonged or repeated contact.

The Joly (Doetsch) process aimed at replacing the ferric liquor from burned ore by (a) calcined sulphate of iron, (b) by saturating spent liquor from copper tanks with condensed fumes of roasted salt and iron sulphate, or (c) by the same operation, only adding manganese peroxide to the roast, the two latter modifications being designed (with small success) to generate chlorine. In its simple form this method is now much used at Rio Tinto, though the action of the liquor is very slow.

Roasting with addition of chemicals (chiefly salt) is best illustrated by the Longmaid (Henderson) method, which is applicable to very silicious (90 per cent. even, when crushed to $\frac{1}{2}$ in. or less) ores and to chalcopyrite. It has been used in Cornwall on ore containing much sulphur, silica, and iron, besides $1\frac{1}{2}$ per cent. copper and 9 per cent. arsenic, with 9 lb. tin, 5 oz. silver, and a few gr. gold per ton. This ore required a preliminary oxidising roast (in reverberatory or Oxland calciner) to remove most of the sulphur and all the arsenic, the latter being condensed and caught in flues (see p. 158). For the second roast, 10–12 per cent. salt is added, whereby any remaining sulphur becomes soda sulphate, and the copper, gold and silver assume the form of chlorides (easily soluble), the solutions becoming very concentrated in due course, and allowing the precious metals to be recovered before the copper is thrown down, while the tin is separated from the solid residues left by the chloride solution.

The Hunt-Douglas process, successfully employed in America on low grade ores, has gone through three stages. In its earliest form, patented in 1869, ferrous chloride is dissolved in strong brine, and by its action with cupric oxide gives rise to a mixture of cupric and cuprous chlorides, the latter, though nearly insoluble in water, being held dissolved by the sodium chloride. The dissolved iron is separated as hydrous ferric oxide, retaining a small portion of ferric chloride. To prevent loss of chlorine, the use of sulphurous acid to reduce and dissolve this iron oxychloride was proposed, but it was found in practice with roasted sulphuretted ores that the ferrous salt formed in the reduction by metallic iron of the cupric sulphate thus obtained renders unnecessary the use of sulphurous acid. In this method with ferrous chloride, the resulting solution being neutral, absence of arsenic is ensured. Any silver contained in the ores is chloridised by the action of the copper salts, and made soluble in the bath of sodium chloride, from which, however, its separation presents considerable difficulties, precipitation of silver by metallic copper in presence of chlorides requiring that the whole of the dissolved copper

present should be in the cuprous form. For the rest, the copper is very readily precipitated from these solutions by metallic iron, with much reduced consumption of iron.

In the second form, beginning with a neutral solution of copper sulphate, there is added so much of common salt or other soluble chloride as will serve to convert the copper present into cuprous chloride (58.5 parts sodium chloride to 63.4 copper). Through the clear, hot solution is drawn or driven sulphurous acid gas, got from roasting sulphuretted ores, which serves to convert the dissolved copper into insoluble cuprous chloride, with liberation of the previously combined sulphuric acid, and the generation of half as much more of the same acid by oxidation of the absorbed sulphurous gas. The clear acid liquid drawn from the cuprous chloride is then saturated with copper from oxidised ores, and the precipitation by sulphurous gas is repeated indefinitely. The insoluble cuprous chloride obtained in this process may be either reduced to the metallic state by iron, under water, or decomposed by milk of lime with formation of cuprous oxide and calcium chloride; the resulting chlorides in either case serving for the chloridation of the further portions of dissolved copper. By the use of a solvent containing only small portions of soluble chloride, any silver present in the ores is chloridised, but remains undissolved in the residue, and may be extracted by solution, by amalgamation, or by smelting; whereas, in the first process it is held in solution, though, from the presence of the two copper chlorides, it cannot be readily separated either as iodide or in the metallic state. It should be further said that by the use of an acid solvent for the copper oxide in the second process there is incurred the risk of bringing arsenic into solution should this be present in large quantities in the ore.

To meet these difficulties a third form has been patented. By attacking the oxidised copper ores with a solution of common salt and ferrous chloride, the latter is decomposed, and the resulting clear and neutral solution, separated from ferric oxide, but containing cupric and cuprous chlorides, is next treated with sulphurous acid gas to convert the former into cuprous chloride with separation of free acid. From such an acid cuprous solution any silver present is readily and completely separated by metallic copper, after which the whole or nearly the whole of the dissolved copper may be precipitated by metallic iron, care being taken to arrest the process before the free acid begins to attack the iron. In this way a solution is obtained containing, besides the regenerated ferrous chloride, a considerable amount of acid. This solution is used to attack a fresh portion of oxidised copper ore, which first neutralises the acid, and then decomposes the ferrous chloride, the ferric oxide from which carries down any arsenic that may have been previously dissolved by the acid. The neutral solution of the copper salts thus obtained is then again treated with sulphurous acid, and the steps, as above described, are repeated indefinitely. A necessary condition is a cheap source of sulphurous acid. The copper produced is very pure and the consumption of iron is small.

When oxidation is accomplished by burning, the next step is to

wash out the soluble copper salts. This is often done in a rough way by watering the ore piles, but much more efficiently and satisfactorily by proper washing in tanks. At Rio Tinto the ore as fast as burned, and while still warm, is conveyed by tip wagons to rough masonry tanks, cemented and asphalted inside, measuring 30 ft. long, 8 ft. wide, and 3 ft. deep, and provided with a false bottom of rough planks, between which the liquors can escape to small partitions in the corners, furnished with pegged holes at various levels. The first wash water is left on for 24 hours, and is followed by others, up to 8 or 10 sometimes, at 12-hour intervals, the whole operation occupying 7 or 8 days. The liquors vary in strength and may contain 100–250 gr. copper per gal. Weak liquors are used instead of clean water for washing new charges. The extraction is about 60 per cent. Spent solutions (after precipitation of the copper) are sometimes used for further washings; at Maidenpec they are occasionally “regenerated” by blowing in air, which precipitates enough iron peroxide (ochre for paint-making) to cover the cost. The consumption of water is in any case large—often 10 tons per ton of ore, or 600 tons per ton of copper produced—but far less than in the Lake mills for mechanical concentration.

Precipitation.—The precipitation (cementation) of the dissolved copper is almost everywhere effected by iron. In the earliest times old scrap iron was used, because it was cheap and produced a clean precipitate; but this has been superseded by pig iron, especially on account of the rapid wasting of scrap by rust when exposed to the atmosphere. The metallic iron being alone useful (all the impurities in the pig lowering the standard of the copper produced) only good qualities of pig iron should be employed, graphite, silica (sand), arsenic, phosphorus, &c., should in no case exceed together 6 to 8 per cent. In Spanish practice it has been found that open-grained No. 3 grey Cleveland pig gives very satisfactory results, better even than iron made at Bilbao from ores of a superior quality; pigs should be free from sand, and either be cast in half-size or be broken in two before use, so as to facilitate handling by a single man, and increase the exposed surface for the deposition of the copper. A very large proportion of the iron used for precipitation is wasted. Theoretically, 100 tons of copper should not consume more than 88 tons of iron; while in the best practice each ton of copper consumes for its precipitation $1\frac{1}{2}$ – $1\frac{3}{5}$ of iron, and in most mines quantities varying from 2 to 3 tons of iron per ton of *casca* or precipitate are consumed. This loss is due to the excess of ferric salts or acids in the liquors when they reach the iron in the tanks or canals; it can be remedied to great extent by application of sulphurous acid vapours to the liquors of lixiviation, or by the action of lime or limestone previous to their entrance into the precipitating plant, always remembering that the liquors must be allowed a slight acidity, without which precipitation and loss of copper would take place.

Two conditions specially favour precipitation: (a) the action of heat, which increases production and hastens the operation; (b) that the copper liquors be run with speed over the iron, which is best

effected by giving a steep incline to the canals in which the iron is charged. The actinic action of the sun is also beneficial. The length of the precipitating canals must be such that the liquors escaping from the lower end shall be practically free from copper. The precipitate obtained from the upper portion of the canals, near their inlet, is much cleaner and purer than what follows, while as the outlet is neared the *cascara* is found to be much mixed, and coated with basic salts of iron, arsenic, &c. It is advantageous to collect the qualities separately. The precipitate should be frequently and regularly collected, so as to offer fresh surfaces of iron to the action of the copper liquors. All the precipitate must be fully and carefully washed in special apparatus as soon as gathered; and as rapidly as possible afterwards it must be carried to artificially heated drying floors, so as to avoid the alteration of the metallic copper into various salts of copper by the action of air and moisture. When dry and cool, the granular copper is put into bags, while the flake copper is placed in separate sacks, all kept under shelter till marketed.

The quality of the precipitate produced at Rio Tinto is: 1st class, 92-95 per cent. copper; 2nd, 74-78; 3rd, over 50.

The whole cost of the cementation processes in Spain, including the wasteful consumption of 1.78 of iron for 1 of copper, is:—

	Reals.
Consumption of iron, 1.78	675.48
Wages	104.84
Stores	9.99
Locomotive service	8.27
Maintenance of railroads	1.73
Repairs	53.63
Add: for salt for lixiviation and various other items ..	60.00
	913.94

This is equal to 9*l.* 2*s.* 7*d.* per ton of fine copper. If to this sum we add 5*l.* 3*s.* for the expenses of lixiviation, we have for the total cost in Spain of a ton of fine copper, by treating pyritous ores holding 0.5 to 2.5 per cent. copper (exclusive of the cost of mining), 14*l.* 5*s.* 7*d.* The net total cost has to be increased by the amount of the cost of the ore delivered to the lixiviation ground, administration, freights, insurance, &c. These items vary greatly, but Deby states that one of the principal mines in the province of Huelva makes copper at the mines at a cost of 21*l.* 7*s.* per ton of fine metal. The production of pig-iron in the midst of the copper region from native ores will lead to a further lowering of cost.

At Maidenpec special precautions are taken to obtain a good precipitate (92 per cent. copper) by working the solutions at a temperature below 65° F., keeping the tanks covered, and stopping the precipitation before the solutions are fully exhausted, the spent solutions being used over and over again for washing the "roast." The cost of plant and erections for treating 10,000 tons of ore per annum is given * at 4000*l.*, the wood, stone, and lime being obtained

* Brenton Symons.

on the company's property. The cost of treating the ore is given as follows:—

Mining cost per ton	s. d.
Transport	2 10
Reduction charges	1 10
Administration	1 11
	2 0
	<hr/>
Total	8 7

Reckoning on obtaining $1\frac{1}{4}$ per cent. copper (from ore averaging about 2 per cent.), the cost of the copper is about 35*l.* per ton; $2\frac{1}{2}$ per cent. ore yielding about $1\frac{1}{2}$ per cent. direct, and the remainder at the rate of .1 per cent. per annum, can be worked to yield copper at about the same cost.

At Copperopolis, California, the saturated leach waters are conveyed to tanks, from which they are charged into a large revolving drum, holding 16,000 gal. at a charge, making about 6 rev. a minute. With the liquor a certain amount of scrap sheet iron is charged; this scrap is obtained in San Francisco and laid down at the works for about 20 dol. (4*l.*) per ton. The drum is supplied with automatic valves in the end, to allow of the escape of the hydrogen gas formed. After a sufficient length of time, which depends on the degree of saturation of the copper solution, the manholes of the drum are opened, and the mass is discharged through wire screens placed over them into tanks immediately below, the scrap iron being detained on the screens. From the tanks, the cement copper that had formed in the drum, after settling, is shovelled on to heated drying floors, and stirred till the moisture is evaporated, when it is sacked and shipped. The sacks are double for this purpose, the inner sack being made of brown muslin.

Sulphuretted hydrogen has been used to precipitate copper as a sulphide, but has many disadvantages. Lime (as a cream) has been employed where the precipitate is required for fluxing, and lime is cheap; but this precipitate is rendered very low in copper by large admixtures of lime and iron salts. Electrolytic deposition offers many advantages, and is applied in refining and on ores which have been first smelted to a matte; but the cost of installation and need of enormous power preclude at present its direct application to any but rich ores.

Smelting.—In some cases both concentration of the copper and recovery of bye-products are better accomplished by raw smelting than by wet treatment. With sulphides a preliminary desulphurising operation is introduced, indiscriminately termed "calcination" and "roasting."

Heap-roasting is the cheapest way of dealing with pyritous ores, and can be used for ores carrying only 15 per cent. sulphur by placing abundance of wood under the pile, and even 8 per cent. by mixing bark, sawdust, &c., with the ore. The chief drawbacks are (a) the slowness of the process where the value of the copper must be tied up for 1 to 3 months; (b) owing to the great size of the heaps, it must be carried on out of doors, whereby much copper is lost by leaching, by blowing away in fine dust, and trampling under foot while loading and un-

loading; (c) the escape of the sulphurous fumes into the atmosphere at a low elevation and in a concentrated form; (d) waste of sulphur.

In calcining ores containing 65 per cent. iron pyrites, a convenient size for the heaps is 20 by 50 ft. and 3 to 5 ft. high. A pile of this size, containing perhaps 250 tons, lighted on the leeward side, well covered with fines, and carefully watched, will burn about 9 weeks and will furnish a product containing 6 to 10 per cent. sulphur. Some weeks before the burning is completed in the very heart of the pile, two-thirds of its contents can be removed without interfering with the process. As the whole advantage of heap-roasting lies in its extreme cheapness (1*s.* 6*d.* to 3*s.* 6*d.* a ton), every precaution should be taken to save expense in handling the ore, e. g. the ore-car from the mine or dressing-house can be brought on a trestle over a long line of roast heaps, while the track which leads to the furnaces runs parallel to these and on a level below the ground. Shaping and firing the pile need experience. The ore should be broken to suitable size, hand labour, when not exceeding 2*s.* per ton, being preferable to a jaw-crusher, owing to the smaller proportion of fines produced—say 12 per cent. as against 20. It is advantageous to pass the broken ore over 2 riddles, thus making 3 sizes: the largest, constituting perhaps 70 per cent. of the whole, should be dumped directly upon the wood, forming the main body of the heap, which should be rectangular, with straight edges and square corners; the next size, called “ragging,” about 20 per cent., is that portion which has been separated by passing through a $\frac{3}{4}$ -in. riddle, and should be built up on the outside of the heap with great care, forming a layer 8 in. thick at bottom, and tapering up to about 2 in. at top; the remaining 10 per cent. consists of fines, separated from the “ragging” by a 6-mesh screen, and should be transported to the heap and arranged in piles at a convenient shovelling distance, none being placed upon the heap until the wood has been kindled, and the strong fumes of sulphurous acid show that the ore is thoroughly ignited. Then the lower portion of the pile is rapidly and evenly covered with the fines, leaving the top still exposed until the heat becomes so great as to warn the attendant that the central portion of the ore is in danger of melting. The top is then covered thinly, and for the first few days careful watching is required to keep the combustion regular and gradually increase the protecting layer of fines. By the end of the fourth day the pile should be burning slowly and evenly, smoking slightly from its entire surface, and no hotter in one part than another. From this time until the process is complete, only careful watching is required; a few shovels of fines scattered in one place or another, as the draught may indicate, comprises all the labour necessary for roasting 200–300 tons of ore. About $\frac{1}{3}$ cord of wood and $\frac{1}{4}$ day's labour per ton of ore will build and burn the heap and load the roasted ore into cars ready for the smelter.

To roast matte in heaps calls for some slight modifications. Owing to the extreme fusibility of this material, and the large amount of copper tied up, the heaps contain only 30 to 40 tons. As matte contains much less sulphur than ore, it is necessary to use a thicker bed

of wood, and after the first burning, which should be completed in 5 days, the pile should be turned on to a new layer of wood, breaking all the clinkers to egg size again, and piling the outside of the heap, which will be found but slightly affected by the first burning, directly upon the new bed of wood; the second burning lasts about 5 days, and a third is usually completed in 4. Matte containing 30 per cent. copper, after 3 thorough burnings, should yield white metal (70 per cent.) when smelted rapidly through a cupola furnace.

Kernel-roasting is a peculiar concentration of copper which always takes place when low-grade ores are calcined without free access of air, even balls of fines yielding kernels in some instances. It is occasionally availed of. Thus at Földal, Norway, a pyrites containing 45 to 48 per cent. sulphur, with 2 to $2\frac{1}{2}$ per cent. copper, and 3 to 6 per cent. insoluble matter, is burned in heaps in the open air as slowly as possible, 3 to 4 months being usually required. After roasting, the kernels, containing, unwashed, only about $3\frac{3}{4}$ per cent. copper, are first washed so as to remove the soluble sulphates, when the kernels are easily picked out from the dried ore, and, as they carry much less adhering oxide scale, assay 12 and even $15\frac{1}{2}$ per cent. The nett proportion of copper obtained in the kernel is only $\frac{1}{6}$ — $\frac{1}{7}$ of the total copper contents of the ore; about $\frac{1}{2}$ the remainder is recovered by washing, and the rest is lost in the burnt residues. The total cost of roasting and hand-picking per ton of crude pyrites is about 1s. 3d. At Agordo, Italy, kernel-roasting on chalcopyrite mixed with iron bisulphide, carrying $1\frac{1}{2}$ —2 per cent. copper, gave kernels assaying 33 per cent.; women and children remove the crusts and wash the kernels, producing a good liquor for precipitation, while the clean kernels go to the blast furnace. Peters tried a similar method on $1\frac{1}{2}$ per cent. pyritous ore at Strafford, Vermont, but failed because only a small proportion of the kernels were so roasted as to admit of ready separation of the iron oxide crust, for which purpose breakers and jigs have proved quite unsuitable.

Stall-roasting being a little more costly than heap-roasting is generally applied only to matte, but is equally suited to raw ores, and reduces the risk of loss by storms, &c., besides working well on a low percentage of sulphur. It is always best to build stalls in blocks or rows of 4 to 12 or more, as a large saving in both brick and iron-work is effected, and the heat retained in so large a mass of masonry, and communicated to continuous stalls, is highly advantageous to the roasting process. It is a great mistake to build stalls without a brick arch over them, as the arch assists in retaining the heat and in forcing the smoke to ascend to the flue. The point of greatest importance in construction, however, is to secure a proper foundation for the brickwork, and to tie the furnaces with strong buckstaves and $\frac{3}{4}$ -in. iron rods, although when the arches are built as semi-circles, which is usually the case, there is no lateral thrust. Still the expansion from heat would soon destroy the brickwork if it were not properly tied, and any undue saving in this direction is always mistaken economy. Ordinary dimensions of stalls are:—Width, 5 ft.; depth, 6 ft.; depth of ashpit, 1 ft. 6 in.; height from grate to spring of arch, 4 ft. 8 in.; thickness of main walls, 1 ft. 6 in.; thickness of

division walls, 1 ft. A stall of this size will hold 5 tons of white metal; an increase of capacity within reasonable limits would lead to a decided saving in fuel and labour, and not be detrimental to the process.

After thoroughly clearing the grate-bars from any fused matte from a previous burning, and plastering the walls carefully, wherever they show signs of wear, with a thick mortar of burned and raw clay in equal parts, about 10 cub. ft. of hard wood, in ordinary 4-ft. lengths, is arranged upon the grate-bars as evenly as possible, and all spaces between the sticks are chinked with small stuff and split logs. Hard wood is much preferable to soft, and a thicker layer of wood should be placed at the front and sides than in the middle. As the stall is gradually filled, pack with chips and brush or small coal both on the front and sides, nearly to the top. The front is built up loosely with fire-brick placed on edge. The matte should be broken to the size of the fist or smaller; and to facilitate this operation the furnace from which it is produced should be tapped on to thick iron plates in such a manner that the matte forms a layer not more than 2 in. thick, which will be brittle, and can be spalled by boys at small expense.

In Japan, stalls for calcination are built of rough stonework, without any chimney, and are usually protected from the weather.

The cost of stall-roasting at Boston is given* at 9*d.* per ton of ore, or 2*s.* 6*d.* per ton of matte, labour accounting for $\frac{2}{3}$.

Kiln-roasting is of several kinds. When the sulphurous acid generated is to be utilised for making sulphuric acid, special forms of kiln are employed, which will be found described in detail in the author's work on sulphuric acid (1872). When the ore is in a dusty condition, choice lies between the old-fashioned brick reverberatory, vertical shelf furnaces, automatic revolving roasters, or hearths with automatic rabblers.

Reverberatories should not be less than 50–60 ft. long, and the working doors should be provided with rollers for carrying the rabbling paddle, and not be situated opposite each other. The bed, but not the arched roof, should rise toward the charging end. A furnace 75 ft. long and 17 ft. outside diam. will require 40,000 common brick (in addition to stone foundation), 8000 fire-brick for lining, and 5 casks fire-clay, besides 5–10 tons iron tie-bars, &c. They are being replaced by mechanical furnaces where labour is dear, but they remain unequalled for producing a really "sweet" roast.

Of vertical shelf furnaces the best is Fauvel's.†

Revolving furnaces bear a general resemblance to the Oxland calciner (p. 157); they are chiefly the Howell White, in which the period of roasting is controlled by the speed of rotation; and the Brückner, in which the ends are contracted, so that the charge can be retained as long as desired. A medium-sized Brückner measures 18 ft. long by 7 ft. diam., takes 6–8 tons at a charge, and weighs about 14 tons. The Anaconda Works use 136 of them; some are gas-fired, 22 ft. long, and roast a 16-ton charge (from 35 down to 3½ per cent. sulphur) in

* T. Egleston, "Point Shirley Copper Works," School Mines Qly.

† C. G. W. Lock, 'Miners' Pocket-Book,' p. 369.

36 hours; they are arranged in sets of 6, and are charged from a travelling hopper. Ordinarily oxidation is far from being completely attained in a Brückner owing to insufficient air-supply, and to overcome this E. M. Clark has added a water-jacketed air pipe fed by a blast, which hastens the roasting, but is very difficult to keep in repair. The best results obtained with Brückners appear to be:— 12 tons of ore to each man employed, consuming 167 lb. coal per ton, reducing the sulphur from 40 per cent. to 7 per cent.; ore at least as fine as $\frac{1}{4}$ in. The Omaha and Grant Company use 3 furnaces, requiring 4 men per 24 hours, to roast 20 tons from 40 per cent. down to 2 per cent. sulphur, consuming $1\frac{1}{2}$ tons coal per charge of 12 tons; they estimate the cost at 90 c. (3s. 9d.) per ton, as against $2\frac{1}{2}$ dol. (10s.) in reverberatories.

Of hearths with mechanical rabblers the O'Hara is the earliest type, succeeded by the Brown-Allen, the Brown, and the Pearce. The Brown-Allen is made with stirrer carriages and a mechanism which moves the ploughs or scrapers outside the roasting hearth. A furnace of average size has a roasting hearth 8 ft. wide in the clear and about 90 ft. long, or, including the lower stage, a continuous hearth 8 ft. wide by 180 ft. long. To take care of a furnace, 1 man only on a shift is required, the whole action being automatic. The cost of roasting, while varying somewhat, according to the cost of material and labour, will average between 3s. and 4s. per ton, including repairs. The capacity of such a furnace is about 35 tons per day, and the results are substantially as follows: When the ore is crushed reasonably fine, and 20 tons per day are treated, the calcined ore averages 1 to 2 per cent. sulphur; 25 to 28 tons a day, 3 to 3.5 per cent.; 30 to 35 tons, 3.5 to 5 per cent.; and if the furnace is pushed to its maximum capacity, 35 to 40 tons of roasted ore, they carry an average of about 6 per cent. The power required is about $2\frac{1}{2}$ h.p. for an average of 35 tons per day. The cost of construction varies somewhat with local conditions, but runs from 1600*l.* to 2400*l.* per furnace, including the necessary stacks. The Brown differs chiefly in having the hearth horseshoe-shaped, with an interval for cooling the rabblers, thus lengthening their lives. The cost of construction is much less than that of the preceding.

The Pearce turret furnace (Fig. 118) consists of an ordinary reverberatory hearth *a* built in a circular form, the centre of the circle being occupied by the central column *b* supporting the radiating arms *c*, which carry the rabble blades *d*. Ore is fed mechanically at *e*, and after traversing the whole circle of the hearth, at any desired speed, falls by gravity into the pit *f*. Air is forced through the pipe arms *c* and discharged against the rabble blades *d*, performing the double duty of cooling the ironwork and furnishing heated air to the roast. Two or more automatically fed stepgrate fireplaces *g* supply fuel. The space beneath the hearth is utilised as a dust flue leading to chamber *h*. The cost of a 36 ft. Pearce furnace is 4000 dol. (800*l.*) for ironwork and erection (Denver figures), with 1500 dol. (300*l.*) royalty. Repairs are confined to renewal of rabble blades every 3–4 weeks. One man per shift can feed fuel and ore, remove roasted ore, and attend to machinery of one furnace. Air supply can be controlled not

Argo works, Denver, and shows the overhead tramway *a* by which ore and fuel are brought, ore feed hopper *b*, and discharge opening whence the ore is drawn and shovelled into wheelbarrows.

Smelting to matte is performed in a variety of furnaces, according to special circumstances.

Perhaps the simplest and crudest is a native Mexican form of shaft furnace, shown in Fig. 120, used at Jalisco.* It consists essentially of a pair of air-channels or long tuyers *a*, constructed in the top of a mass of crude masonry *b*, with a bellows *c* at one end,

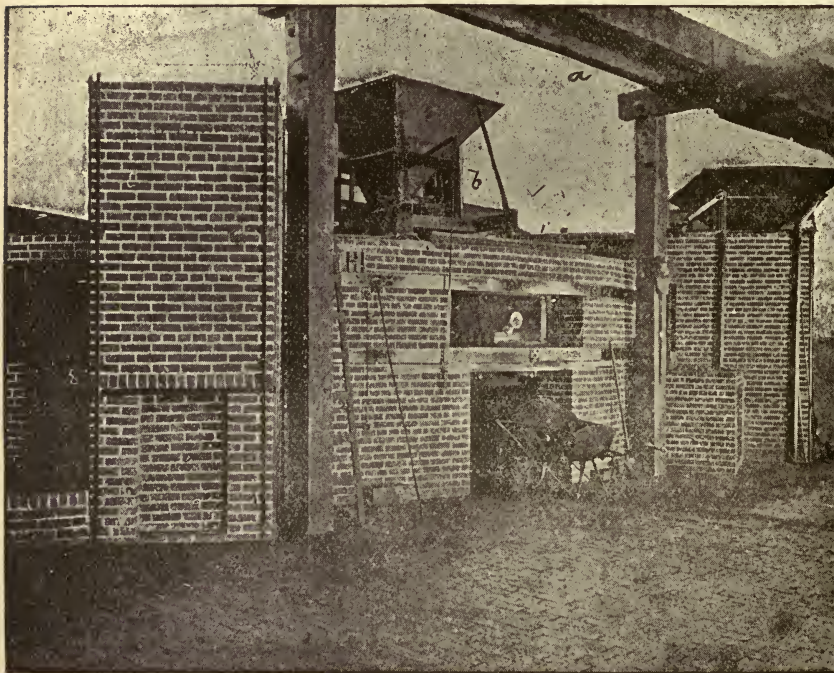

FIG. 119.—PEARCE "TURRET" FURNACE.

and what answers for a crucible *d* at the other. These stone channels are about 7 ft. long, slightly conical, and sufficiently raised at the back to allow free motion for the bellows. The fire ends are terminated by clay nozzles *e*, about 18 in. long and 2 in. diam. at the outlet; their ends come nearly to the edge of a circular basin *d*, about 18 in. diam. and 3 in. deep at the centre, simply a depression in the earthen floor, lined with the ashes of the *encina*, a species of oak, rammed in moist, and formed by a man stamping quickly around with leather sandals on his feet; it is repaired in the same manner. For each tuyer, a round bellows *c*, about 3 ft. diam. is attached

* W. B. Devereux, Trans. Amer. Inst. Min. Engs., 1882.

directly against the stonework; the back of the bellows is fastened to an upright frame, which is hinged at *g*, and is provided with a cross-piece at the top for a handle; it is worked by a man standing on a raised platform *f*, taking a single step backward and forward at each blast. The blasts are given nearly alternately, and the two currents are directed by the nozzles toward the centre of the basin. When smelting is to commence, a green pine pole about 10 in. diam. is laid across the basin in front of the nozzles, the fire end supported by a roller, so that it can be moved up easily. Pine charcoal is piled upon both sides of this over the basin, and plates of foul slag are laid across from the nozzles to the charcoal, securing greater concentration of heat. When the fire is well lighted, ore is placed on that part of the charcoal outside of the log, and coal and ore are afterward added sufficiently fast to maintain the compact character of the pile; thus the blast is prevented from breaking through with force and blowing the ore away, for it is quite powerful, and the flames are constantly tinged with green. The *encina* makes a stronger coal than pine, and

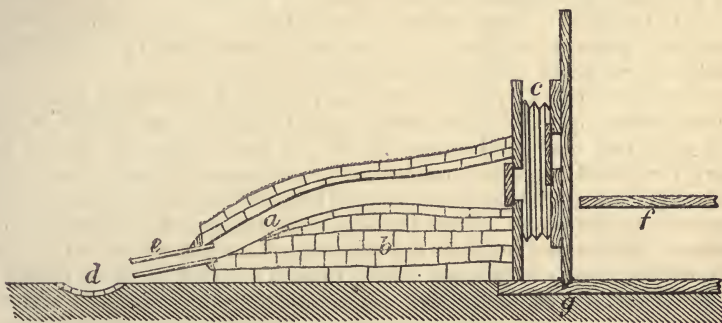

FIG. 120.—MEXICAN SHAFT FURNACE.

better for shaft furnaces, but it snaps too much for this process. By the time the ore has worked down to the bottom of the log, it seems to have agglutinated, and the melting copper and slag commence to drop at once. The whole of the smelting seems to take place before it settles into the basin, as after that the surface is almost constantly covered with charcoal. The log seems to be an essential both for controlling the force of the blast and for supporting the charge so that it is acted upon gradually, but with increasing power. When the basin is nearly full of slag the blast is stopped, and the coal is scraped away. The slag is then removed in plates as it cools, the only implement being a round pole, which is slipped under the edge and then carefully lifted up with the cake balanced upon it. If the cake of copper is not large enough, smelting is resumed: when sufficient has accumulated, the slag is removed as before, the dust is blown off with a bamboo tube, and the copper is allowed to cool in the basin. It is said that 300 lb. of ore can be smelted with one furnace in 4 hours, which seems doubtful. The quartz gangue separated in concentration is used for flux. The slags are very basic, but well

fused, and seem to contain little metallic copper. The copper cakes (40–50 lb.) produced are soft, and seem quite pure. They are melted in a similar furnace once more, however, being treated precisely as the ore was treated, except that no slag is used; scrap and refuse copper are added at the same time. There is no poling or stirring of the copper, the action of the heated charcoal being apparently all that is necessary to produce the proper pitch. This would indicate that oxide is formed during the melting down. No tests are made, but the uniformity of the product is remarkable.

Rio Tinto employs a number of low brick furnaces lined with soft but compact clay-slate, for smelting the calcined ore, kernels, and precipitates, producing a matte with about 36 per cent. copper. Some of these furnaces are now replaced by water-jacket cupolas, with economy. Peters* states the cost of matte smelting in a Herreshoff furnace at 7s. 6d. a ton, with cheap fuel and a fusible ore; and instances a cost as low as 3s. 4d. with large quantities of ore, coke costing 10s. a ton, in a rectangular brick furnace measuring inside 12 ft. by 3 ft. 6 in., and having tuyers on all sides.

At the Tilt Cove mines, Newfoundland, the Austin pyritic smelting process has been adopted, with the object of producing a matte of one-third the weight of the raw ore.

At the Willows Syndicate works, Transvaal, W. Bettel has introduced some important innovations to suit the peculiar conditions, viz. (a) very bad coal containing 18–40 per cent. ash, and (b) an ore carrying chiefly hydrous oxide and antimoniate of iron, with 40 oz. silver per ton, and 4 per cent. copper (blue and green carbonates), with scarcely any sulphur. After investigating the causes of previous non-success, he decided to adopt the following arrangements: (a) to construct vaults as a foundation; over these a number of brick channels (suitably arranged along the whole width of the furnace), covered with bricks (rubbed joints and grouted), communicating with a steam-blast arrangement at one corner of the flue end of the furnace to ashpit at outlets, and, after cooling bridge, to blowpipe jets in bridge and roof; (b) to work the furnace under pressure with closed ashpit, using an ejector arrangement similar to, but simpler than, the Koerting. Thus he could (a) reduce the heat in the grate, making the ash loose and friable, and (b) transfer such heat (as well as heat from furnace bottom abstracted by passage of air and steam through the brick tubes) in the form of hydrogen and carbonic oxide, to the laboratory (hearth) of the furnace where these gases are burned with the hot-blast from roof and bridge, producing an intense temperature similar to that obtained in a Siemens regenerative gas furnace. Having reduced the usual depth between skimming plate and bottom, he smelted the bottom in three thin layers, the first two with sifted sand with which $1\frac{1}{2}$ per cent. lime was intimately mixed, and on this a seasoning charge of sharp slags smelted. The upper layer consisted of sifted river sand only, which, after smelting, was seasoned as before. To smelt the refractory antimonial oxide and carbonate ores (70 per cent. in pieces $2\frac{1}{2}$ –3 in. cube) without sulphides (except in traces) and still produce clean slag, collecting at least 90 per cent. of the copper and

* E. D. Peters, 'Modern American Methods of Copper Smelting.'

silver at one operation in a matte, at a profit, coal being 50s. per ton of 2000 lb., stores generally about 500 per cent. over English prices, and white labour 27*l.* per month (furnacemen), he used as flux a silicious carbonate of iron, lime, and magnesia, containing 5 per cent. and upward of anthracitic carbon. The matte produced is a copper antimonide, thus: antimony oxides fluxed with lime (and magnesia) will dissolve in a bath of basic ferrous silicate, and be reduced by carbon conjointly with copper and silver, forming a fusible and brittle argentiferous antimonide of copper (formula Sb_2Cu_3), provided that the slag does not contain more than 5 per cent. magnetic oxide of iron; otherwise the slag is rich, copper and antimony are lost, and some silver is volatilised. Excess of carbon is avoided, as tending to throw down metallic iron, making the matte coarse and difficult to break. With ores carrying 35 oz. silver, $16\frac{1}{2}$ tons ore (or $27\frac{1}{2}$ tons charge) are concentrated into 1 ton matte; 91.3 per cent. silver is recovered ($7\frac{1}{2}$ –8 per cent. going into slag and remainder volatilising), and the matte contains 52 per cent. copper, 38 antimony, $3\frac{1}{2}$ iron, 2 arsenic, 2 sulphur, $\frac{1}{4}$ lead, and 1.59 silver (520 oz. per ton). Further oxidising treatment in a special, hot-blast, blow-pipe reverberatory gives crude copper (93.55 per cent.) containing 3.26 per cent. silver (1064.9 oz. a ton), 1.31 antimony, and .6 arsenic. Steam (which may be raised by waste heat) at 20 lb. pressure, introduced through two $\frac{5}{16}$ -in. jets, has a marked influence in preventing formation of all except "rotten" clinker, and causes even such poor coal as here used to burn to a clean ash.

Water-jacket furnaces are, however, growing in favour, and assume many forms. Fig. 121 illustrates Stewart's "rapid" smelter, *a* being the crucible; *b*, water jacket; *c*, water supply pipes; *d*, air chamber; *e*, tuyers; *f*, charging door; *g*, tapping spout; *h*, drop bottom. The cost of a single furnace plant complete is about 5000*l.*; its capacity, 30 tons a day; water consumption, 25,000 gal. per 24 hours; power required, 30 h.p.; fuel consumed, 30–40 bush. charcoal per ton of charge (ore and flux) or 13 per cent. good coke. Some smelters prefer the rectangular form, as giving a greater output for the same labour and consuming less fuel. If charcoal is used as

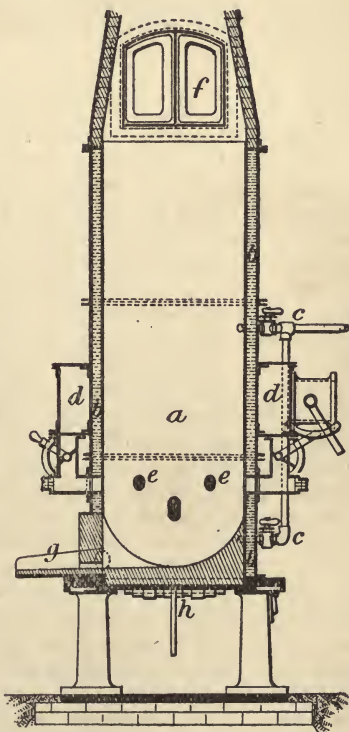

FIG. 121.—WATER JACKET FURNACE.

fuel, it is essential to keep it dry and unbroken. The water leaving the jacket should be as hot as possible short of being steam, and the outlet should be in full view of the furnaceman. When the blower is stopped, all the tuyer holes are at once cut off, to prevent subsequent explosions of inflammable gases. Usually the different materials forming the charge are fed in separately from their respective bins, though some advocate mixing the charge thoroughly before feeding. The removal of chilled slag and crusts should be repeated at short intervals, to reduce risk of injury. An approximate estimate of cost for working a "30-ton" furnace (36 in. diam. at tuyers, taking 35 short tons), on average ore, is:—

	£	s.	d.
5 tons limestone or iron flux at 12s.	3	0	0
5½ tons coke at 6l.	34	5	0
Labour	16	10	0
Fuel for boiler, 2 cords wood at 25s.	2	10	0
Assay supplies, &c.	3	0	0
Cleaning and weighing product	0	10	0
Repairs, &c., at 10 per cent.	6	5	0
	<hr/>		
	£66	0	0

or, on 35 tons, 1l. 17s. 9d. per ton of 2000 lb. With an 80-ton furnace, the cost is reduced to 1l. 10s. 6d.

In smelting the low-grade ores of Torreon, Chihuahua, Mexico, Collins* introduced some innovations with great success. Thus, instead of using the drop-doors in cases of freezing, he raised the furnace stack by screw-jacks placed over the 4 short cast-iron foundation columns, and removed the chilled "bottom" in one piece, breaking it up outside by dynamite. To help prevent chilling when working on poor ores, he walled round the open space below the bottom plate and between the foundation columns with slag bricks laid in clay, so as to shut off circulation of air beneath the furnace. Costly fire-bricks for lining he replaced by local soft refractory trachyte, cut to shape and laid in a mixture of pounded trachyte and clay. With a small low furnace (36-in. circular) no lumps of more than fist-size should be admitted, and a benefit results from breaking all silicious or otherwise refractory lumps to the size of walnuts; but 25 per cent. of fine ore in a 36-in. round furnace gives fully as much trouble as 40 per cent. in a furnace 36 by 100 in. with a bosh. The pieces of coke should not be allowed to exceed 9 sq. in. in sectional area, while pieces smaller than a walnut either get burned up before reaching the tuyers, or enveloped in slag which protects them from the action of the blast. The slags are more free from copper and silver when small charges are employed; but the pile of coke corresponding with each charge must be large enough to spread evenly over the whole area of the furnace, and the best results were got by a charge of 90 lb. fuel, corresponding with 450–520 lb. ore. The consumption of fuel is about 2 cords a day of dry mountain oak, which lasts well and gives a hot flame, proving itself equal to about 1½ ton ordinary western coal, over which—besides

* H. F. Collins, "Smelting Processes for Extraction of Silver and Gold," Proc. Inst. Civ. Engs., Paper No. 2655.

being somewhat cheaper—it offers the advantage of giving better results with inferior stokers. The Torreon ores are docile, and rarely need any flux; 2 classes are produced, the general average of the first class being 13·05 per cent. copper and 14 oz. silver per ton of 2000 lb., and of the second class, 5·3 per cent. copper and 4 oz. silver per ton.

The cost of smelting, with wages at 3s.—6s. a day for workmen, and 15s.—17s. 6d. a day for foremen and mechanics, inferior coke at 57s. 6d. a ton, coal at 44s., and wood at 25s. a cord, is: labour, 5s.; materials, 1s. 3d.; boiler fuel, 1s. 6d.; coke, 10s. 3d.; superintendence, 2s.—total, 20s. per ton of 2000 lb.

At Siemens' copper-smelting works at Kedaberg, in the Trans-Caucasus, the residues from naphtha distillation have been applied both in the calcination and fusion of pyritic ores, the furnaces for both operations being combined into one structure, having a chimney-stack in common. The smelting furnace has a circular bed 18 ft. diam., covered by a domed roof, having a maximum height of 7½ ft. in the centre. The heating is done by two of Leng's pulverising burners placed about 9 ft. apart on the same side of the furnace, with the uptake flue between them. The jets are not quite square to the admission port, so that two eddying bores of flame are produced under the roof, which unite and pass out by the flue over the bed of the calcining surface. The latter is 50 ft. long, with a bed 9¼ ft. wide, and 3 ft. height of roof, which is laid with an upward slope of nearly 1 in 7. The ore, containing 7 per cent. copper, is first roasted in the ordinary way, and then run down to coarse metal, containing 25 per cent. copper; but when the roasting is omitted, the regulus contains only 18–20 per cent. copper. With this furnace, in 33 working days, 938·6 tons of ore were smelted, yielding 368·2 tons of coarse metal, averaging 25 per cent. copper, with a consumption of 185·6 tons naphtha residues, or rather more than 50·43 per cent. of the weight of the product.*

Fines are not so easy to deal with, but they may be “bricked” by mixing with slimes or flue-dust, lime, or even cement, and smelted in a water-jacket furnace with low burden and very light blast, or in a large section blast furnace using a fan blast. Peters describes such a furnace, costing 700*l.*–1000*l.* complete, smelting 30,000 tons of a mixture containing 50 per cent. green fines, yielding a 10¾ per cent. matte, at less than 8s. a ton.

The Swansea method as formerly practised was conducted entirely in reverberatory smelting furnaces. A mixture of sulphuretted and naturally or artificially oxidised ore, containing sulphur enough to concentrate all the copper into a matte of 20 to 30 per cent., and sufficient silica to combine with all the iron that did not enter the matte, and with all other bases, so as to make a clean fusible slag, was run down in a reverberatory furnace. The resulting matte was re-charged, roasted, and smelted again at a low heat, whereby some of the sulphur was oxidised and passed off as sulphurous acid, and the oxidised iron combined with the silica of the furnace lining, unless silicious ore or slag was added. This operation was repeated till all the iron was

* C. Schnabel, “Liquid Fuel in Copper Smelting,” *Zeit. d. Ver. D. Ing.*, 1891, p. 1027.

eliminated, and a pure sulphide of copper, known as "white metal," was obtained. These repeated roastings and fusions produced a good copper, but required an inordinate quantity of fuel and labour. In the modified Swansea method now employed, the ores and slags from subsequent operations are mixed so as to produce a matte of 30 to 33 per cent.; this grade being preferred, because if it be lower in copper an extra fusion would be required, if higher the cost of subsequent operations would not be materially reduced, while the slags would be enriched by the higher tenor of the shots of matte which are unavoidably drawn out of the furnace when skimming. If the ore is fusible, 4 charges of 8000 lb. each can be smelted in a large furnace in 24 hours. When the fusion is complete, the slags are skimmed off, and the matte, if sufficient in quantity, is tapped. But the English practice of limiting the tenor of the first matte to 33 per cent. is not followed everywhere. In the Guayaquil smelting works, Chili, the mixture is made up to 15 per cent. copper, from sulphuretted and naturally oxidised ores, and a matte of 50 to 55 per cent. is made at the first smelting. At the Butte works, Montana, where a roasted concentrate of about 20 per cent. is matted in reverberatories, the product runs from 60 to 65 per cent. Sometimes the 30 to 35 per cent. matte is tapped into water and thus granulated; but most works crush it between rolls previous to calcining it in some suitable furnace. In England, where the law is stringent against polluting the atmosphere with noxious gases, the most highly sulphuretted ores and mattes are calcined in furnaces which yield a gas of sufficient density for acid making; thus, by the use of the Gerstenhöfer kiln, 47 per cent. of all the sulphur is utilised to make sulphuric acid. The matte is roasted so as to leave in the roast about 12 per cent. of the 23 per cent. of sulphur which it contained before roasting, but a still higher proportion of the iron is oxidised. When this roasted matte is again fused, either with a silicious desulphuretted ore or a silicious slag, there is produced what is technically known as white metal, containing 72 to 75 per cent. copper, about 20 to 18 per cent. sulphur, and the balance iron. The product of the last operation, if it be properly performed and has yielded a regulus of over 70 per cent., is now reduced to the metallic state in the blister furnace. It is melted down very slowly, so as to oxidise as much as possible of the sulphur. The slag formed is skimmed off, and air is blown upon the melted mass, the result being the formation of copper oxide and sulphurous acid—the copper oxide coming into contact with unreduced sulphide yields metallic copper and sulphurous acid, which latter being evolved in the body of the mass causes it to swell to much above its normal bulk—

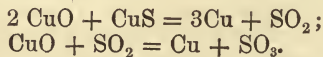

From the extreme density of the fumes evolved they would seem to carry some sulphuric acid, which may be derived from the sulphurous acid, when rising through the mass, reducing an equivalent of copper to the metallic state. The chilled charge when again fused should be ready to tap as "blister" of 98 per cent. copper.

Comparing reverberatory with water-jacket furnaces, it may be said that elimination of arsenic, &c., is more effective in the former, and where wood is very cheap while coke and charcoal are dear or inferior, the reverberatory may hold its own; but generally the water-jacket is much preferable on the score of economy. When ores are basic enough to form their own slag, they may be smelted into bars of over 94 per cent. in circular water-jacketed furnaces 36 in. diam. at the tuyers at a rate of 40 tons per day, at a cost not exceeding 12s. 6d. per ton of ore, if coke can be got at about 1l. per ton; and larger furnaces can be used to still better advantage.

"Bessemerising" is now largely applied to copper mattes. It consists in utilising the sulphur in the ore as fuel for bringing the metal a stage forward in purity. Its first form was the Hollway process (English), followed by the Manhés (French), to which several modifications have more recently been added in America. By it, pyrites containing only $2\frac{1}{2}$ per cent. copper can be concentrated into a 15-25 per cent. matte with a minimum consumption of fuel.

As used at Leghorn in treating the Tuscan copper ores, crude 10 per cent. ore is mixed with a small quantity of roasted lump ore, as it comes from the mines, is run down into a 30-35 per cent. copper matte, and tapped direct from the well of the furnaces into a trough-shaped Bessemer converter. Air is blown through this for 20-30 minutes, the effect of which is to oxidise a little of the sulphur and all the iron, which is converted into a slag at the expense of the silicious lining of the converter. The slag is so fluid that on tilting the converter most of it flows off. What remains is skimmed into a slag buggy, leaving in the converter an almost pure copper sulphide. The converter is then returned to position and the blast is turned on. In about $\frac{1}{2}$ hour the sulphur is eliminated as sulphurous acid and the copper is reduced to 97 per cent. metal. The whole operation occupies a little over an hour. With patching, the lining lasts for 7 charges. While one converter is in blast, another is being relined, and the lining of a third is being dried. The converters in use there produce at each blow about $\frac{1}{2}$ ton 97 per cent. copper, and therefore are so light that they can be tilted by hand. The capacity of the small plant is 5 tons of copper a day.

At Butte, Montana, the matte produced in the blast furnaces is roughly iron monosulphide mixed with copper subsulphide, and runs 48-55 per cent. copper, 22 iron, 26 sulphur. A percentage of iron is often replaced by small quantities of zinc, lead, antimony, and arsenic, which elements are partly volatilised in the converter and partly enter the slag. When the matte has become cold enough to handle, it is broken up by sledges to about the size of a man's fist, and elevated in cars to a high track leading above the mouth of the remelting furnace (Fig. 122), which consists of a simple cupola shaft *a*, the main body supported upon 4 hollow cast-iron pillars *b*, terminating below in a detachable well *c*, made of boiler iron, lined deeply with a mixture of crushed quartz and fire-clay, pounded hard in the well to a thickness of about 12 in., and somewhat deeper in the bottom. The cupola shaft is also lined with the same material, but decreasing in thickness above, and running out entirely near the feed-door. The

well is placed on wheels for convenience in running it out on the iron floor, when it is necessary (every few weeks) to reline it. Tuyers enter the shaft just above the well, and have peep-holes *d*, through which the workmen can observe the level of the molten matte. The junction between the cupola shaft and the well is made by a heavy wall of the lining material, and this is often broken through by the fire, as the iron of the melting matte is very prone to eat it out. When this occurs the man in charge patches it from outside with lumps of composition kept in readiness. The well has a heavy cast-iron lip *e*, by which skimming is performed. The whole furnace is so

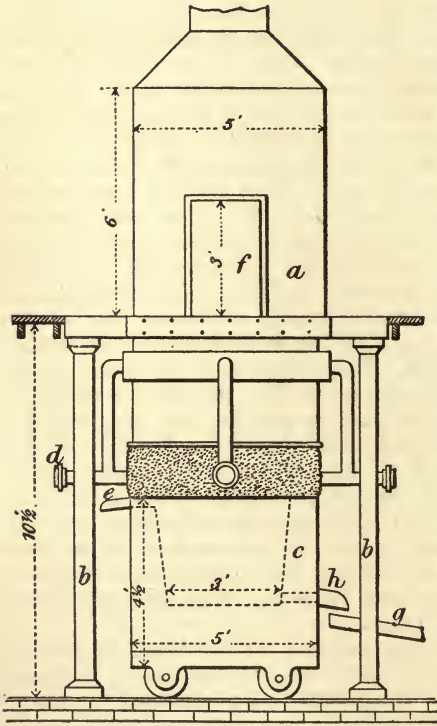

FIG. 122.—REMELTING FURNACE, COPPER.

arranged that the tap hole *h*, at bottom of well, shall be about 2 ft. higher than the mouths of the converters when horizontal. At *f* cold matte is fed in with lime and coke; charges are not weighed, but the coke is about 10–12 per cent. of the weight of matte, the extra consumption over blast-furnace practice being due to the need of high temperature in the matte, otherwise the long run in launder *g* and cold blast might chill it round the converter tuyers, besides which the converter is not always ready for the charge. The remelting requires much skill. Only about .25 per cent. lime is used, to give fluidity to the well skimmings. The melted matte passes below the tuyers and settles in the well to a depth of 30 in. The blast is regulated to keep the matte on a level with the lip *e*, from which slag is occasionally drawn. This slag contains 4–5 per cent.

copper, and is returned to the blast furnace, where it acts as a flux to the charge and gives up its metal. A furnace 5 ft. diam. outside requires 2 men, and will melt about 30 tons matte a day, supplying 3 converters. The launder *g* is of wrought iron, semicircular in section, 12. in. diam., and supported from a swinging crane by chain tackle.

The converters (Fig. 123) are swung on trunnions *a*, one communicating with a wind-chest *b* encircling the converter, and thus admitting the blast. The converter is in 3 sections of $\frac{3}{16}$ in. riveted

wrought-iron boiler plate: the upper section or hood has inside numerous wrought-iron crooks *c*, riveted on, which afford a hold for the lining. The wind-chest has $\frac{5}{8}$ in. holes drilled from outside through its outer shell and on through the side of the converter. The outer hole is kept closed by an easily removable wooden plug, so that the inner tuyer hole can be kept clear from copper incrustation by thrusting an iron rod through the hole into the interior of the converter. The mouth of the converter is about one-quarter the outside diameter of the body, and, when in position, points up into an opening in a brick gallery, which communicates with a dust-chamber and stack. A worm-screw operated by power takes into a cog-wheel 20 in. diam. attached to one trunnion of the converter; it can be worked in either direction by pulleys. The floor all around the converters is formed of iron plates, because of the occasional spitting of matte from the converters, and the slopping over of slag or copper, in pouring and wheeling. On iron, the hot liquid quickly chills; it does not adhere to the plates, and can be quickly shovelled aside.

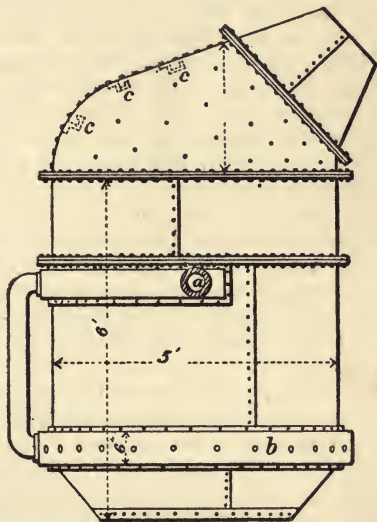

FIG. 123.—COPPER CONVERTER:
PARROT.

When the converter lining is eaten out, the first business is to cool it: it is allowed to rest until the red heat has disappeared, and then water is very cautiously introduced through a rubber hose; after a time the whole interior is filled with water, which overflows, runs over the exterior, and escapes through a trap and drain under the iron floor. When the converter is cool enough, the water is emptied out, and a man goes inside to remove all loose lining and copper nuggets with a pick, or with hammer and gad; it is then turned mouth down and emptied. Frequently more than half the old lining remains undisturbed, and the new lining is placed over it. The lining is composed of ground quartz (98–100 per cent. silica), with sufficient fire-clay to make it stick together; less than 15 per cent. best fire-clay does not satisfactorily keep the lining in its place; grinding is done in a revolving quartz-pan with stationary rollers, and mixing by a machine similar to an old-fashioned clay-mixer for making brick. Composition of lining in bottom and sides: crushed quartz (99 per cent. silica), coarse and fine, 20 parts by bulk; best fire-clay, 3; for converter hood: fine crushed quartz, 6 parts by bulk; best fire-clay, 1; for remelting furnace and well, and for launder, same as for converter bottom and sides. This lining is meant to wear away; in fact, the process depends upon the union of its silica with

the oxide of iron. The linings last generally about 8 hours. When the converters are running, one is cooling while the second is drying out and being heated up, and the third is in full blast, producing metal. In each shift of 12 hours, the lining of the 3 converters is performed by one liner and his helper. When the lining of one is completed, a ladleful of hot slag is poured in, an armful of wood is thrown on it, and on top of this 2-3 bush. coke; a gentle blast is turned on through the tuyer holes, the lining dries out and afterwards gets red-hot, and the converter is ready for charging. A man then shifts the belt, so that the converter turns on its trunnions through an angle of 90° , until its mouth points toward and a little below the tap-hole of the remelting furnace-well. The launder is swung into place, and lowered by the chain tackle until its free end is thrust into the converter mouth. A helper to the lower cupola man holds an iron rod, 1 in. diam. and 5 ft. long, at the tap-hole, while the cupola man drives it with a sledge. This is sometimes quite a task, as the accumulation of chilled metal around the tap-hole may require the rod to be driven in 2 ft. before the liquid metal is reached. When the rod slips in easily, on reaching the liquid metal, the helper hooks a close-fitting iron on the rod close to a knob at its outer end, and a reverse blow of the sledge jerks the rod out, the helper landing it out of the way by means of the hook iron. The molten matte then spurts out with great energy, under the pressure of about 6 lb. to the sq. inch. It is allowed to run along the launder into the converter for about 10 minutes, that is, until about 2 tons have entered. As the converter begins to fill, a light blast is turned on to keep up the heat. At a signal to shut off, the cupola man places a sheet-iron shield over the launder so as to cover it for a distance of 4-5 ft. from the tap-hole downward, in order to protect himself from the intense heat to which he is exposed while plugging the hole. The plugging is done in the usual way, by placing a pyramid of fire-clay on a disc upon the end of a rod and thrusting it into the tap-hole. The launder is then swung out of the way, the air is turned on full blast, and the converter is brought upright with its mouth pointing into the opening in the dust-gallery. A dense cloud of sulphurous acid and other gases pours out of the mouth of the converter with a noise like a heavy waterfall. The air-blast enters under an initial pressure of 8 to 12 lb. per sq. in. (the higher pressure being more desirable). It is produced by a compound direct-acting pumping-blower of the Corliss type.

From this stage onward no fuel is used, the heat being supplied by the combustion of the sulphur in the matte. It sometimes happens, however, either from the initial temperature being too low, or from there being too small a charge, that the combustion of the sulphur fails to keep up the heat toward the end, and in this case a stick of wood is thrown in. The air enters the mass about 6 in. above the bottom of the lining. Its first action is to replace the sulphur in combination with iron by oxygen, and to oxidise this sulphur to sulphurous acid gas. This double reaction is shown in the equation $2\text{FeS} + 3\text{O}_2 = 2\text{FeO} + 2\text{SO}_2$. The iron oxide is brought toward the sides by the action of the currents of air, where it comes in contact

with the incandescent quartz lining, and combines with it to form a bisilicate of iron, which floats as a top layer. This action is shown in the equation $\text{FeO} + \text{SiO}_2 = \text{FeSiO}_3$. The composition of the slag thus formed varies considerably with different charges. It sometimes shows a few per cent. more SiO_2 than Fe, as indicated by the formula, but it usually contains rather more iron than silica, thus showing that there is a small amount of the unisilicate formed. There are also small percentages of the silicates of lime and alumina.

This stage of the process is characterised by dense white clouds, tinged with rose and green. The rose tint first disappears and the white gradually diminishes, while the green becomes more constant. Finally, the close of this stage is indicated by both the white and green changing to a pale blue. When this change has become permanent, it indicates that the iron is entirely combined with the silica.

The blast is now shut off, the slag-pots are run under, and the converter is turned over. While the slag is poured off in a thin stream the skimmer tests the stream by rasping it with a long skimming-rod, which causes the fluid to spatter in all directions. When the behaviour of the fluid exhibits the characteristic jump of white metal, thus showing that some of this is escaping with the slag, the skimmer orders the converter up a few inches, and after lightly skimming the charge, he turns on the blast, and orders the converter straight up as before. Before the converter gets up to its old position, all the white metal obtained from the slag-pots and the scraps of copper swept up from the floor are thrown into the charge. Each of the slag-pots which has just been filled is found to contain when cold a button of white metal near the bottom. These buttons are easily separated from the slag by a blow of the sledge, and are thrown into subsequent charges at the same stage of the process. The slag contains 3-5 per cent. copper, and it is sent back to the blast-furnace in company with the skimmings of the cupola-wells before described. The converter now contains nothing but white metal, as the iron, lime, and alumina have been slagged off, and the lead, zinc, arsenic, and antimony volatilised.

During all the period of blast, the wooden plugs in the wind-chest are extracted one after another, and the corresponding tuyer holes are kept clear by rods, which are hammered into the converter. It is necessary to do this continuously, on account of the rapidity with which noses of copper form over the tuyer holes, especially towards the close. After the blast has again been turned on, and the second stage commenced, a rather scanty blue flame, sometimes mixed with white, comes away from the converter. This colour changes gradually. First the blue and white lessen and a rose colour creeps in, until they disappear. The rose then deepens to red and afterwards to reddish-brown; at the same time its size gradually contracts until at the close only a thin, sharp tongue of flame is to be seen. The precise moment when the sulphur is all gone and nothing but metallic copper left is hard to prescribe, as it is entirely a matter of experience. The colour of the flame often varies in shade, and sometimes entirely disappears at the mouth. The changes from sulphide to copper, and

again from copper to oxide, are so very slight in appearance that the whole charge may actually be oxidising, and give no sign until the copper is too cold to pour. Such a mishap has sometimes occurred, and has created an enormous amount of work; in fact, if such an event happens when the converter is pretty well worn, it would seem most profitable to cut the rivets and take it to pieces. If, when the flame shows the process to be nearing its close, the sparks which are projected against the plate on the farther side of the dust-gallery are carefully watched, it will be seen that some of them stick to the plate, glow brightly, and instantly disappear, while others, of dull colour, rebound from the plate like red-hot shot. When those which stick and glow become few, and those which rebound become numerous, it is time to pour.

If it be an object to get a very high per cent. of copper, it is better to allow a small amount of oxide to form; but care must be taken that the charge remains hot enough to pour easily. On turning down the converter, the colour of the interior will show to the experienced eye whether there is sufficient heat present in the mass. If the sulphur is not entirely gone, the surface will be smooth; but if any oxide has formed, it will be seen floating on top as a blebby mass. This cannot form so long as there is any sulphur remaining. In the pouring process the oxide is kept back by throwing a dam, composed of a few pieces of scrap copper from the floor, across the converter mouth. The copper flows out underneath this dam, and the oxide is left inside the converter. This remaining oxide does no harm, and is not lost; for as soon as the new charge is put in, it is reduced back by the sulphur in the matte.

A great deal of copper and oxide adheres to the lining, so that when a converter is to be lined, the best practice is to wash it out by running into it as much matte as will fill a couple of slag-pots, turn on the blast a few minutes, and then turn out the whole charge into the pots. The clinging particles of copper and oxide are thus changed back into white metal, and as this readily pours, the old lining is left quite clean. This practice, however, is not followed when the converters are crowded with work and the blast-furnaces are not. When the lining has become so eaten that a clean sweep is to be made of it, the entire mass is taken out and distributed among some of the blast-furnace charges. This is done because the copper, silver, and gold work into it for 4-5 in. and would be otherwise lost.

When a converter is ready to pour, a series of removable moulds arranged on a wheeled car are run under it, and 4 men, with long hooks, roll this truck forward or backward to catch the stream in the successive moulds. As the copper shrinks very greatly in cooling, 3 or 4 moulds are first filled, and then the frame is run back and they are re-filled, till each may contain about 200 lb. copper. The moulds are previously daubed with a clay mud to prevent the pigs from sticking to them. A charge produces about a ton of metal. The time occupied varies very greatly with the grade of the matte, initial temperature, and force of blast, but the average time, from filling to pouring, may be put at about 2 hours. With a low-grade matte, after slag has been formed, the converter is sometimes again filled up with

matte to avoid having at the close too small a mass of metal to retain the heat. The pigs rapidly become coated with oxide as they cool, which gives them the name of black copper. The fragments are pounded off from the edges, and they are ready for shipment.

Estimate:—1 ton 51 per cent. matte requires: coke for remelting, 220 lb.; coke for heating converter; 10 lb.; silica, 666 lb.; fire-clay, 111 lb.; lime, 5 lb. A plant of 3 converters and 1 remelting furnace is capable of treating continuously 25 tons 51 per cent. matte a day, and may be crowded up to 30 tons. There are 2 shifts of 12 hours each; day and night shifts change men twice a month; labour required per shift: 1 foreman at 20s., 2 cupola men at 15s., 1 liner at 14s., 1 skimmer at 14s., 7 labourers at 12s.—total, 8*l.* 2*s.* This gives the cost per day of two shifts, 16*l.* 4*s.* If 6 converters are run together with 2 remelting furnaces, the total cost of labour is somewhat diminished, as follows: 2 foremen at 20s., 6 cupola men at 15s., 3 liners at 14s., 4 skimmers at 14s., 28 labourers at 12s.—cost per day, 28*l.* 4*s.* If the capacity of 6 converters be crowded up to 60 tons per day, the force must be increased for both shifts, thus: 2 foremen, 8 cupola men, 4 liners, 4 skimmers, 36 labourers—cost per day, 35*l.* 4*s.* The second case gives the lowest price for labour per ton, but is only possible where the two remelting furnaces are so situated as to allow of one cupola man above attending to both. Labourers act as helpers to all skilled workmen, and shift about as needed, except a few who are assigned to definite duties.

Cost of treatment per ton of matte at Butte: labour, 2.93 dol. (12s. 2*d.*); fuel, 0.98 dol. (4s. 1*d.*); silica and fire-clay, 1.84 dol. (7s. 8*d.*); blast, 0.90 dol. (3s. 9*d.*); total, 6.65 dol. (27s. 8*d.*). To this must be added interest on investment and on the expense account for 30 days, between shipment and marketing; at 10 per cent. per annum this will amount to an additional 13 cents (6½*d.*) per ton; repairs and renewals will add another 13 cents per ton, giving a total of 6.91 dol. (29s. 10*d.*) per ton of matte, or 13.55 dol. (56s. 6*d.*) per ton of copper. The price of fuel is based on coke laid down at 8.50 dol. (34s.) per ton.

The cupola shaft at the Parrot works, Butte, has been water-jacketed: this is a very decided and obvious improvement, readily suggested by blast-furnace practice. The metal-well has also been water-jacketed; this is not so evident an improvement, because the matte, when sometimes kept a long time in the well, owing to some delay in the converters, gets chilled to a great depth about the tap-hole and bottom. The lining of the well, as before practised, would seem to be the better plan.

Converters have been made of $\frac{3}{4}$ -in. cast-iron, in 3 sections, separable when bolts around the edges are removed. These converters are removable from their trunnions, and are handled by a car and crane. When the lining is to be repaired, the converter is removed by running a car under it. The car is provided with 4 adjustable platform-screws, which are screwed up until they impinge upon 4 projections cast upon the side of the converter. The trunnion screws are then loosened and removed, and the converter is run out on a track, where a steam-crane picks it up and sets it on the floor. The 3 sections are

then separated by unscrewing the bolts around the circumference, and the interior, thus exposed to the air, soon cools sufficiently for relining. Meanwhile another extra converter, which has been previously relined, is put up in the place of the one just removed. This arrangement requires a double set of converters, one being worked while the other is being cooled, relined, and heated up again. The cooling is sometimes effected by a blast of cold air passed in through the trunnion, and the same blast heats it up again when a fire is kindled inside. By means of the steam-crane the parts are easily picked up and put together after relining. The arrangement for turning the converters consists of a rack-and-pinion wheel, the latter being attached to the trunnion, and the rack being moved by a piston in a water-cylinder. The water-pressure is furnished by a double plunger-pump and a hydraulic accumulator.

The use of a double set of converters, the preparation of one while its mate is running, the opening of the converter for relining, and the handling of it by a crane are great advantages, but they are partially offset by several disadvantages in the practical method of carrying out the idea. The use of cast-iron is of no advantage; on the contrary, it makes the converter heavy and unwieldy, and the mass of metal absorbs much heat, thus prolonging both the cooling and reheating operations. Again, the cast-iron cracks very soon in every conceivable direction, and frequently 2 weeks' service will find several bolt-holes cracked out. Occasionally, however, one will be found to stand the wear very well. The work of separating the parts, seemingly so simple, is sometimes very arduous, for the reason that the lining bakes together at the junction, becomes continuous, and of a stone hardness. When the bolts are removed, the parts refuse to budge, and much time and hard work are consumed in prying the sections apart, to the frequent injury of the converter. The method of cooling by an air-blast is not so expeditious as that described below. By making the converter in 3 sections instead of 2, more time and strength are expended in separating the lower sections than are compensated for by any advantage gained; hence it is rarely done. The two lower sections had better be in one, and of a different shape, to facilitate the extraction of the old hard-baked lining—the most serious work encountered in handling the process.

Stickney suggests * that this process may be made more productive, at less expense, by certain changes in the machinery and the method of handling it. The most obvious drawbacks at present are: (1) The waste of heat in cooling the matte and again remelting it; (2) the short life of the lining, with the attendant necessity of cooling the converter and heating it up again; (3) the length of time required to cool the converter; (4) the difficulty of separating the parts when held together by the hard-baked lining; and (5) the great amount of hard labour required to extract the old lining.

By arranging the blast-furnace on an elevation above the remelting furnace, the necessity of much handling of the matte will be avoided. In such a case the matte may be run into small moulds the

* 'Mineral Industry,' 1893.

size of bricks, arranged in gangs on one base, and, as soon as they cool enough to set, they may be shot down an incline to a small iron bin, which has a small opening opposite and quite near to the feed-door of the remelting furnace. From this bin the cupola man will feed. The mass of matte will therefore enter this furnace at a little less than melting heat. If the blast is at any time producing more matte than is needed at the remelter, the overplus may be allowed to cool, and, being dumped into another bin, it may be used whenever the blast is producing less than the remelter requires. In this way a large amount of fuel, probably one-third of that now used, may be saved. It must not, however, be forgotten that the temperature of the matte as it enters the converter must be considerably higher than when it leaves the blast-furnace, and hence the remelting furnace cannot be done away with.

The duration of the lining may be greatly prolonged by placing an iron hopper with an air-tight cover above the trunnion of the converter, forming a communication between the hopper and the blast-pipe by a vertical pipe entering the latter at a point near its entrance to the converter. The vertical pipe should have a gate easily closed and opened by the workmen below. The hopper may be filled with perfectly dry and powdered quartz, or with any powdered quartz ore which contains no metals except gold and silver. A very small percentage of copper might not be detrimental. By a judicious regulation of the supply turned into the blast-pipe, so that the quantity shall be slightly below the needs of the oxidising iron in the matte, the lining will be called upon for but little silica, and its life will thus be very greatly prolonged.

The converters may be cooled much more quickly by introducing a cold spray, produced by inserting a small air blast-pipe into a water supply pipe near its end.

But a more important suggestion is to modify the construction of the converter, as shown in Fig. 124.

It is made of $\frac{3}{16}$ -in. steel boiler plate, riveted, the body in one piece and the hood in another, the two being separable by driving out wedges from dogs on the outer rim. The main body tapers downward about 1 in. in 1 ft. False bottom and

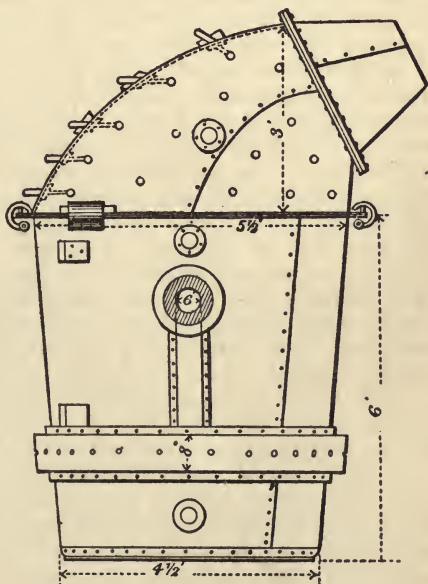

FIG. 124.—COPPER CONVERTER: STICKNEY.

sides are made in pieces of $\frac{1}{8}$ -in. sheet iron. The hood is of the same material, and has no false lining, but pins near the lower edge and at intervals over the inside (kept in place by a small shoulder inside and a wedge outside fitting into a slot in the part of the pin that projects through the converter shell) take the place of the catches and hold the overhanging roof of the converter in place. When it is desired to remove the lining, the outside wedges can be quickly driven out, and the pins driven inward through the lining.

The lining is put in place in the following manner: The false bottom and sides are first polished with graphite and placed in position. The bottom is pounded hard with lining composition to a depth of 18 in. A kettle, which has been made of $\frac{1}{8}$ -in. boiler-iron, $2\frac{1}{2}$ ft. diam. on the bottom, 4 ft. high, expanding at a somewhat greater rate than the converter shell, and perfectly smooth on the outside, with handles at the top, is set on the pounded quartz bottom exactly in the centre of the converter, and the lining is then shovelled in and pounded hard around it. Afterward the kettle is lifted out by a crane, and a cavity is left in the centre of a strong wall lining about 15 in. thick at bottom and 12 in. at top. This wall extends up flush with the top edge of the main body. The top of the wall all around is then sanded with fine dry sand. The hood, having its pins in place, is turned hollow side up and is plastered with lining composition to a depth of 12 in. at the edge, gradually diminishing to 3 in. around the mouth. The hood is then picked up by the crane, turned upright, and placed on the body. The flanged edges are secured together by dogs and wedges, and, after being heated, the converter is picked up by the crane, landed on the carriage, and rolled to its place. When relining is necessary, the converter is landed on the floor, and the hood is detached by knocking out the wedges, when the sanded (or graphite may be used) junction in the wall will give an easy line of fracture. The crane lifts the hood and places it upright on an iron frame 3 ft. high and hollow beneath. The pin wedges are knocked out and the pins are driven inward through the lining with a heavy sledge, by which the lining is broken up and detached. The hood lining lasts a long time, but must be removed when it builds up and chokes the converter.

The body is next turned by the crane on its side, then completely upside down, and suspended at 1-2 in. from the floor. If the whole lining with the false sides and bottom together does not drop out, a few taps on the sides will produce this result. The side and bottom pieces are easily detached separately by jarring, and then the whole lining may be picked up by the crane and placed in an iron mortar, to be broken up by a heavy chunk of iron being dropped on it. The unburned pieces may then be returned to the quartz pan for regrinding and mixing with new composition. The pieces badly coated and impregnated with copper should be sent to the blast-furnace.

The time and labour saved by this construction of converter and its manipulation can hardly be estimated by one who has not witnessed the daily struggles of workmen with hard-baked linings in the old styles of converters. By dumping the old lining while hot,

no time need be lost in cooling by any system, as the thin steel shell may be sprayed and cooled sufficiently for relining in a very few minutes.

Arguing from the great advantages which ensue from the replacement of the ordinary silicious linings of steel-melting furnaces by a lining composed of basic material, when phosphoric pig-iron has to be converted, it might reasonably be expected that the substitution of a basic lining for the silicious lining hitherto employed in copper-smelting furnaces, should also be followed by similarly advantageous results, especially when the cupriferous material to be treated contains any notable percentage of arsenic or antimony. Operations in this direction have been very successfully carried out at a large English smelting works, and described at length by P. C. Gilchrist.* The roaster furnaces have cast-iron bottom plates, underneath which a free current of air circulates; by this means the bottom of the furnace is kept cool; it likewise prevents the possibility of any fusing action taking place between the basic hearth and its support, which might be the case were the basic hearth built directly upon the ordinary silica arch. The basic material is ground and mixed with tar in the usual way, and the furnace bottom is formed by throwing this material into the hot furnace and burning it on in layers, well beating down each separate layer, and giving it fire for some hours before applying a fresh layer. It usually takes 4-5 days to burn on a bottom in this way. When the bottom is properly shaped, it should be seasoned by melting on it some rich copper precipitate or good blister copper. It was at first considered that the basic hearth absorbed less copper than the ordinary sand ones, but there appears to be very little, if any, difference between them, much depending on the way the bottom is formed and seasoned. The tap-hole of the furnace is shut by throwing a little basic material against it from the inside. In other respects the working of the furnace is conducted in the usual way. After each charge any slight repairs that the banks may require are made by throwing some basic material against the place needing repair; the repairs required are, however, very slight in comparison with an acid furnace, the tendency being for the furnace banks to grow rather than to cut away.

The mineral used is arsenical, and although in the crude ore the arsenic is not high, yet when the ore is allowed to oxidise in heaps, and the copper is afterwards precipitated from the solution obtained by lixiviating the ore, arsenic is concentrated in the precipitated copper to a considerable extent, the resulting precipitate usually containing 3-3½ per cent. Very large quantities of this precipitate are treated. It is added to the mixture of slag and metal charged into the smelting furnace, and according to the amount of precipitate so added to the charge, more or less of the product tapped from the smelter consists of impure copper, known as "metallic bottoms." An average analysis of these bottoms gives 83-87 per cent. copper, 5-7 arsenic, 1-3 sulphur, 3-5 lead, ½ each iron and silica. It is in the conversion of these bottoms into blister copper containing under

* Paper read before Soc. Chem. Ind., London section, Jan. 5, 1891.

1 per cent. arsenic that the basic linings have proved so superior, as illustrated by the following example:—

	Basic Lining.			Silica Lining.		
	tons	cwt.	qr.	tons	cwt.	qr.
Metallic bottoms used during 12 weeks	400	10	0	400	10	0
Average analysis 84·52 per cent. copper and 5·91 arsenic.						
59 charges made, averaging per charge	6	15	1	6	15	1
Blister copper produced from same	323	6	2	191	15	0
Average produce per charge	5	9	2	3	5	0
Average arsenic 1·11 per cent.						
Slag made from above charges	102	16	3	221	15	0
Average weight per charge	1	14	3	3	15	0
Average copper percentage	25 per cent.			55 per cent.		
Time occupied per charge, including fettling, charging, &c.	29½ hours			38 hours		

Calculating from the above figures, we find that taking the real copper in the "metallic bottoms" at 84·5 per cent., and the real copper in blister at 98·5, there was obtained in the form of blister 94 per cent. of the real copper from the basic furnace, and 56 per cent. of the real copper from the acid furnace, showing a gain of 38 per cent. in favour of the basic furnace. The real copper in the slag works out to 25 tons 14 cwt. from the basic furnace, and 121 tons 19 cwt. from the acid furnace.

At Deville, near Rouen, for refining arsenical copper, the usual silicious lining is replaced by a basic bottom, for which a basque of lime and tar is employed. Every operation of refining is performed on a false bottom of limestone, mixed with manganese peroxide, on which the ingots are placed. The false bottom gives off carbonic acid and oxygen, and these traverse the half-melted copper, puddling and oxidising it. When the bath is sufficiently liquid, the lime and manganese protoxide rise through the copper and dissolve the arsenic acid, which thus passes into the cinder. About 80 per cent. of the arsenic is removed. To drive off the last trace, the copper is left to become pasty under a current of air, and then again melted with basic fluxes until it is completely purified. The following is an example of an operation on a sample of copper from Rio Tinto:—

	Arsenic.		Iron.	
	per cent.		per cent.	
Copper charged in	0·789		0·320	
After first melting	0·141		0·022	
After second melting	0·113		trace	
After third melting	0·023		none	

This process does away with the roasting of the ore, and the absence of silica diminishes the loss of copper in the cinder.

The "direct" method* of producing refined copper is based upon the well-known reaction between oxide and sulphide of copper

* C. Vautin, Trans. Inst. Min. and Met., ii. 76.

upon their being melted together, sulphurous anhydride being given off, and metallic copper remaining, which is directly refined in the furnace in which it is produced. White metal is the product preferred for the operation, crushed through a $\frac{3}{8}$ -in. screen; part is calcined nearly sweet, mixed with the requisite proportion of uncalcined, and filled into a refinery furnace, melted, skimmed, refined, and ladled into ingots, cake, &c., as may be required; the operation of melting and refining taking the same time as if a charge of pimple or blister copper were operated on. This method has been working continuously at the Cape Copper Co.'s Works, Briton Ferry, since December 1890. The white metal treated is produced in the usual way in Welsh reverberatory furnaces, and averages about 75-76 per cent. copper. The whole is crushed in rolls, and part is calcined in old-type reverberatory calciners, which put through $3\frac{1}{2}$ tons every 36 hours, and in a revolving calciner of the Oxland and Hockin type, which puts through about 10 tons a day, running continuously, and calcining much better.

The calcined metal is sampled, and the sample is mixed with a portion of raw metal, is melted in a crucible, and, from the result of this trial, the proportions of the refinery charge are determined. If the button of copper is covered with slag, then the proportion of raw material must be increased, or, if the button is coarse or covered with regule, it requires more calcining, the pitch aimed at being just below blister copper when the whole charge is melted. The weighed proportions of raw and calcined metal are now mixed for a 15-ton charge, say, 9 tons revolver calcined and 6 tons raw, or 11 tons reverberatory calcined and 4 tons raw. The mixed charge is filled into the refinery whilst it is still hot from the previous lading; the furnace is closed up and fired. In 4-5 hours the charge softens and flattens down, copper forming on the surface, and, as this hot copper penetrates the charge, a gentle yeast-like working takes place, dense fumes of SO_2 are given off, so much so that the furnace flue is often inadequate to carry them off quickly enough, and they force out through every crack, the heat produced by the chemical reaction aiding the reduction. The whole charge is quickly melted down, and very little slag is made. The furnace is now skimmed, when it takes about $\frac{1}{2}$ hour's rabbling to set it, and it is ready for poling as if ordinary blister had been used. Each refinery works a charge of 15 tons metal, making 11 tons copper every 24 hours. Trials made to ascertain the best and cheapest pitch to which the metal should be calcined showed that though, when the metal was calcined to black oxide, it would decompose its own weight of raw material, and when calcined to red oxide it would only decompose about half, yet the cost of extra calcination counteracted the saving. On an experience of 14,000 tons of ingots it is claimed that the direct method gives 36 per cent. more ingot copper and 44 per cent. less slag to be re-treated, whilst the actual cost per ton of ingots made was 13s. 6d. a ton in its favour, besides which the extra product means a saving of a further 2l. a ton of ingots in making white metal. But it is not at all evident that really impure ores or mattes could be satisfactorily treated in this way.

In order to minimise the cost for renewal of slag- and matte-pots, R. H. Terhune has adopted a form with a movable bottom, which overcomes the cracking tendency. The pot is cast with a 6-in. hole cored in the bottom, in which is inserted a flanged bottom, 4 counter-sunk rivets making a tight and permanent joint.

Bye-products.—These are chiefly bismuth, cobalt, gold, lead, manganese, nickel, selenium, and silver; iron oxides, such as ochre and "blue-billy" or purple ore; iron and zinc sulphates; tin oxide; arsenic and sulphur. In many cases, only the copper, say 2–3 per cent. of the mineral mined, is saved, while the remaining 97–98 per cent. is wasted, and this is likely to continue in a great measure, owing to the absence of a market for the majority of the products at the seat of production, and the cost of transportation. But the utilisation of the sulphur and the ferruginous matters is of primary importance, and will surely be accomplished in the near future. An improved method of roasting would enable the sulphur to be converted at once into sulphuric acid, and that again might be used to make sulphate of iron from such of the iron residues as were not fit for paint-making.

Commerce.—The following table shows at a glance the approximate relative importance of the principal copper-producing countries, stated in English tons of fine copper:—

Algiers	120
Argentina	150
Australia—	
Wallaroo	5,200
Other mines	2,500
Austria	1,200
Bolivia	4,500
Canada	4,000
Cape—	
Cape Copper Co.	5,350
Namaqua	1,375
Chili	20,000
England	1,000
Germany—	
Mansfeld	14,700
Other	2,000
Hungary	300
Italy	2,000
Japan	18,000
Mexico—	
Boleo	6,200
Other	1,480
Newfoundland	1,900
Norway—	
Vigsnaes	925
Other	450
Peru	150
Russia	5,000
Spain and Portugal—	
Rio Tinto	30,200
Tharsis	10,800
Mason & Barry	4,400
Sevilla	1,000
Other	200
Sweden	800

United States—						
Lake Superior..	50,000
Montana	70,000
Arizona	20,000
Other States	6,000
Venezuela	3,000
Total						274,900

Thus the United States afford more than half the whole output, and Spain more than one-sixth.

Sampling Copper.—English and American practice are at variance in this important particular. The Cornish and Swansea methods of arriving at the value of a parcel of copper or copper ore are fully described in the author's 'Miner's Pocket Book,' p. 363. In America nothing is left to judgment, everything depends on actual assay of a mechanically taken sample, sampling machines being of various kinds. Most sampling works have now adopted a form of sampler (e. g. the Brunton or the Constant) which diverts the entire stream during a given and definite interval of time. They can be so adjusted that the crushed ore, elevated to a chute immediately above the sampling-machine, descends upon it, and during, say, 10 seconds the descending stream is diverted to the right, and during, say, 20 seconds it is diverted to the left, so that whatever passes during the first 10 seconds, whether it be fine or coarse, rich or poor, light or heavy, is all deflected to a set of rolls. There it is pulverised, and is again raised to a second sampling-device, which again automatically diverts $\frac{1}{3}$ (now $\frac{1}{9}$ of the original lot), the discarded $\frac{2}{3}$ in each case returning to the sampling-floor, where it is bagged and returned to the car. The moisture sample is taken from the discarded $\frac{2}{3}$ at the time when the material is weighed into the car before proceeding on its journey. The sample, now representing, say, $\frac{1}{9}$ of the original lot, which has passed the rolls, is returned to the floor, where upon an iron-covered platform it is mixed together by hand and divided down by quartering, which must be the ultimate termination of all sampling. But there is no selection in this quartering, and it is always proceeded with by the same rule and in the same manner. The sampling of copper bars is performed by boring, say, every fifth bar twice, half-way through on opposite sides. In sampling argentiferous bars of variable composition every bar is bored twice. If they carry gold also in any quantity (and always in the case of anodes), the borings are melted and granulated, or recast into a sample bar, which is again bored. These are the only ways to secure uniformity in the laboratory sample and assays. Electrolytic assay is preferred for reliability, using an Edison current. There are usually considerable differences on returns between American shippers and English buyers. Loss of weight will often average 2 per cent. on matte shipped in sacks, but much less with casks (e. g. old petroleum barrels). With ordinary matte, a common difference in copper assay is $\cdot 75$ to 1 per cent. loss; with argentiferous matte, $1\frac{1}{4}$ – $1\frac{3}{4}$ per cent. copper and $\cdot 3$ oz. silver per English ton. So that importers buying in the United States and selling in England must make an average allowance of 4*d.* per unit to cover such differences. The market value of a parcel of copper ore is

arrived at by reckoning the "settled produce" or fine copper yielded by it (say 4·55 per cent.) at standard or current price of Chili bars (say 70*l.* a ton), and deducting the "returning charges." These latter vary. In Cornwall they are fixed at 55*s.* per ton of ore, whether rich or poor. In Swansea there is a fixed rate of 12*s.* 2*d.* per ton, and an additional sliding rate of 3*s.* 9*d.* per unit of metal in the ore. The presence of antimony, arsenic, bismuth, lead, or sulphur depreciates the value, and a sensible percentage of either element may render the parcel unsaleable.

GOLD.

THE geographical distribution* of gold is very wide. Approximate figures relating to its production in 1891, stated in kilos. (of 2·2 lb.), are given below:—

United States	49,917	French Guiana	825
Australasia	47,245	Japan	775
Russia	36,310	Brazil	670
Africa	21,366	Dutch Guiana	668
China	8,020	Central America	226
Colombia	5,224	France	200
British India	3,754	Italy	150
Canada	2,506	Uruguay	140
Chili	2,162	Argentine	123
Austro-Hungary	2,104	Peru	113
British Guiana	1,693	Bolivia	101
Mexico	1,505	Sweden	88
Venezuela	1,504	Great Britain.. .. .	4
Corea	1,128		

Australian gold is still largely derived from placers (33 per cent. in Victoria), but the bulk of it is obtained from quartz reefs, mainly as free gold. There are enormous deposits of refractory ores which have not yet been developed.

In Queensland, the most notable auriferous deposit is at Mount Morgan, 26 miles S.W. of Rockhampton, where about 75,000 tons of ore up to the end of November 1889, had yielded 323,000 oz. of gold (value nearly 1,332,000*l.*), or over 4¼ oz. per ton, at a working cost of only 17 per cent. on the value. This mine is equally remarkable for the various opinions expressed as to its genesis and geology, the most plausible of which,† founded on features developed by extensive working, seems to be that the ore deposit represents an altered mass of shattered country rock, readily acted upon by mineral solutions, which replaced the basic and felspathic portions by acidic and quartzose auriferous material. Its permeable and quartzose character has saved it from disintegration, and preserved it as an ore mass on the summit of a low hill, as seen in Fig. 125. The "country" consists, in ascending series, of dolerite, quartzite, greywack, and "desert" sandstone, intersected by numerous dykes of rhyolite and dolerite. The deposit itself overlies the quartzite, which is usually very pyritic. The greywack (not seen on the mountain itself) underlies the sandstone in other parts of the district, and is usually so much metamorphosed as to be scarcely distinguishable from a true eruptive rock; the "replacement" probably occurred in this formation.

Surface cuttings show a mass of silicious iron-stained ore, which on the one hand shades off into crushed quartz and on the other into

* A. G. Lock, 'Gold: its Occurrence and Extraction.' † T. A. Rickard.

silicious hematite; the distribution is apparently irregular, except in so far as the different varieties of material are bounded by dykes, which throw off lateral branches, are irregular in direction (with a general N.E. trend), and consist of kaolinised rock which is most probably rhyolite. There is no evidence of regularity in the bedding of the material, nor are the joint planes persistent—the whole mass appears to have been fissured and shattered by the violent dynamic agency represented by the dykes. The outer portions of the ore body show a greater proportion of iron oxides; some portions carry small crystals of pyrites, while the lowest edges lie upon the quartzite, the boundary line being very distinct. Where dolerite dykes form the limit of the deposit, the contact is also well marked. The large masses of highly pyritic auriferous quartzite suffice to account for the richness in gold. It is reported that the ground in immediate contact

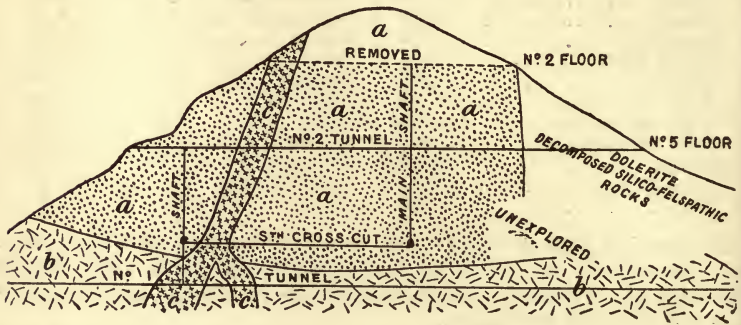

FIG. 125.—GOLD DEPOSITS, MOUNT MORGAN.

with the dykes is frequently poor, while a few feet away it may be richer than usual, and the idea has suggested itself* that the dykes, in coming up in a molten condition, may have had some influence in volatilising the gold and depositing it at a little distance. In Fig. 125, *a* is the ore body; *b*, pyritous quartzite; *c*, dykes. After the kaolin of the ore has been mechanically removed, the gold in the silicious residue is almost chemically pure.†

On the Moondilla goldfield, it would seem that incoherent masses of debris formed of the waste of the Desert Sandstone were consolidated by intrusions of silicious waters during the Newer Tertiary volcanic activity, these silicious waters carrying gold in solution.‡

In the Charters Towers district is an immense area of granite, intersected by porphyry and diorite dykes, and adjoining an area of schists. The members of the lowest portion of the schists are micaceous and hornblendic, much traversed by dykes and sheets of granite; the uppermost beds are hard quartzite. Numerous gold mines are worked in both the granite and the schists, the reefs being very rich in shoots near the surface, but the shoots are very narrow and become very poor at shallow depths, often totally barren on entering the

* R. L. Jack.

† G. H. Irvine.

‡ R. L. Jack.

hard undecomposed schists. At Cocoa Creek, the lodes occur in slates, greywacks, and quartzites, most probably Permo-carboniferous, and carry much stibnite and quartz, both auriferous.

In Victoria, dark-grey mineralised laminations are characteristic of the best and most permanent auriferous lodes.* Brown inclines to the belief that "all auriferous reefs have been deposited in the first instance at the time of fracture, and have in many instances been enlarged by fresh eruptions of auriferous silica." E. J. Dunn describes the occurrence in wash of small, white sandstone nodules, with a ferruginous kernel, and containing exceedingly minute particles of gold disseminated through them, so that the average yield from many tons was $\frac{3}{4}$ -1 oz. gold, and massive beds of soft sandstone, which furnished the nodules assay up to 9 dwt. Dunn quotes another instance where fractures in sandstone and slate beds of Silurian age have been filled with quartz, forming a reef dipping from 30° to nearly 60° E.; in some places in a horizontal displacement of 2 ft., besides a nearly vertical fault. The quartz occurs in the reef fault in an unusual manner, only being found under the sandstone beds of the hanging wall, and along the strike of these beds even it makes as irregular lenticular masses, ranging from 2-3 in. up to 2 ft. in thickness. Under the slate beds no quartz exists. Strike of the bedding planes, N. 36°-48° W.; dip, nearly vertical. In some portions of the sandstone, thin veins of quartz are present, and a great deal of pyrites (arsenical). Gold in small quantities is found in such stone. The pyrites obtained in crushing the stone yields 2-3 oz. gold per ton.

As to permanence there is abundant evidence that quartz does not necessarily get poorer as one descends: richer and poorer zones may be encountered, as shown by the following figures relating to the Railway Tribute mine:—

Depth.	Tons.	Yield.		Average per Ton.	
		oz.	dwt. gr.	oz.	dwt. gr.
200-300 ft.	782	846	16 0	1	1 17
1000-1200 ft.	10,057	8487	10 0	0	16 21
2025 ft.	7,329	8740	6 0	1	3 20

In the Sandhurst district, two mines working below 2000 ft. are getting excellent ore, thus:—

Width of Reef.	Depth.	Tons.	Yield.	Average per ton.	
ft.	ft.		oz.	oz.	dwt. gr.
7	2025	2506	3970	1	11 16
6	2290	289	429	1	9 16

* R. A. F. Murray.

The subjoined table is interesting as showing the relations of depth to yield in a number of Victorian mines:—

Width of Reef.	Depth at which Quartz was got.	Quantity Crushed.	Average Yield of Gold per Ton.		
		tons	oz.	dwt.	gr.
ft. in.	ft.				
3 0	1400	368	0	13	15
3 6	1520	3848	0	13	22
..	1000	4014	0	11	9
30 0	390	1214	0	4	9
16 ft. to 20 ft.	1140	5815	0	10	11
2 0	200	84	0	10	11
1 6	216	6	1	11	11
2 6	800	70	0	3	10
1 ft. to 1 ft. 6 in.	282	210	0	5	8
5 6	150	121	0	18	3
4 0	180	20	0	15	0
30 0	140	596	0	1	0
1 3	64	40	1	0	0
2 ft. to 12 ft.	2000	1060	1	1	20
2 in. to 2 ft.	1820 to 1920	410	1	1	8
7 6	2025	1229	1	0	9
3 in. to 2 ft. 6 in.	1780	1729	0	12	18
..	1340	5926	0	12	1
1 6	1194	1519	0	10	16
..	1000 to 1200	91	0	10	5
1 6	65	19	4	5	22
1 0	65	16	0	18	0
0 6	200 and 300	98	1	0	3
7 0	570	38	0	2	16
6 0	880 to 1030	3335	0	9	10
5 0	400	40	0	2	14
3 ft. to 10 ft.	630 to 700	5019	0	8	10
2 ft. to 8 ft.	630 to 770	2803	0	8	15
1 3	315	1455	0	19	7
..	310	781	1	0	13
1 0	600	115	1	15	20
5 ft. to 8 ft.	500 to 670	1385	0	11	7
6 ft. to 17 ft.	680 to 740	1036	0	15	17
4 6	900	1960	0	11	12
4 0	800 to 1200	2650	0	19	1
5 0	132	400	0	5	8
4 0	300	310	0	6	18
1 0	337	162	3	1	17

Some very rich parcels of quartz (9–10 oz. per ton) are got from "squibs," or undefined reefs consisting mainly of small leaders of quartz mixed with slate and sandstone.

At Mount Doran (Fig. 126), the country rock *a* is a soft white sandstone, in which run bands of fine, soft slaty rock *b*. A quartz leader *c* runs with the slaty rock; it is about 4 in. wide, strikes N. 15° E., and dips 80° W. Where it intersects the sandstone, it is barren, but where it crosses the slaty belt it is very rich in gold.*

Fig. 127 illustrates a series of flat veins in granite, at Wood's Point: *a*, quartz veins or reefs; *b*, soft granite; *c*, hard granite; *d*, slate walls.

* E. J. Dunn.

On the terraces between Loyola and Kevington, the lodes have a westerly strike nearly parallel with that of the enclosing strata (slates and sandstones). The lode track is along the axes of an anticlinal curve in the strata, and the quartz *a* forms a sort of saddle reef, or as it is locally termed "boiler" reef (Fig. 128), while in other places it forms a massive segregation close to the axes and slightly parallel to one side (Fig. 129). The quartz is milky white, and in parts glassy, with darker lineations of fine slate and pyrites. Along the lode track, brownish - grey quartzitic sand-

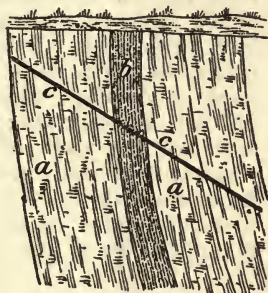

FIG. 126.—GOLD DEPOSITS, MOUNT DORAN.

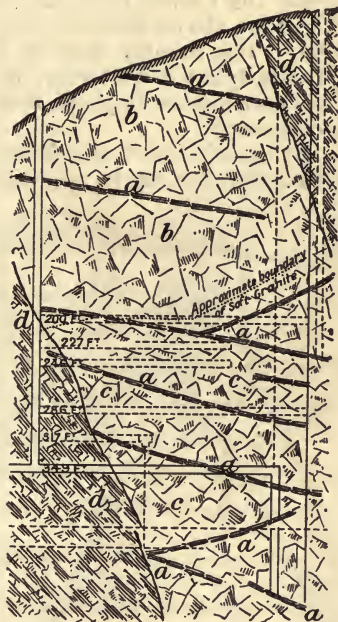
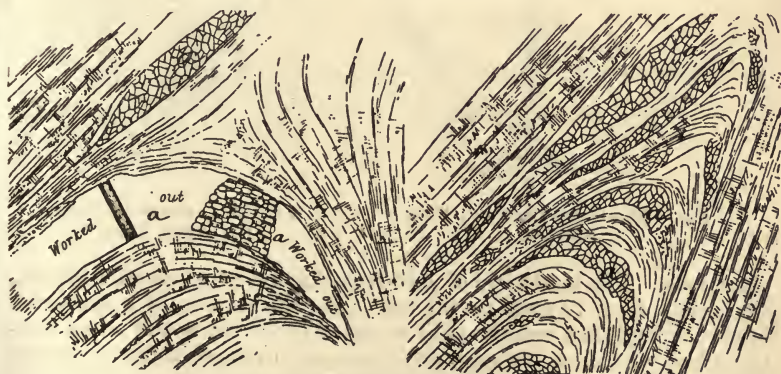

FIG. 127.—GOLD DEPOSITS: WOOD'S POINT.



FIGS. 128, 129.—GOLD DEPOSITS, LOYOLA.

stones alternate with slates; it is generally between the slate and sandstone walls that the richest quartz is found, and not where the

quartz seems reticulate through the sandstones or slates; the latter is frequently carbonaceous.*

On the Clunes field, the Port Phillip mine carries many lodes (Fig. 130), the off-shoots in many cases proving richer than the main lodes. The country rock is Lower Silurian. *a*, basalt capping; *b*, diorite dyke; *c*, west vein; *d*, Robinson's vein, having west branch *e* and east branch *f*; *g*, old man vein; *h*, east vein; *i*, welcome vein; *k*, offshoots.†

At Fryer's Creek, the richer (sometimes very rich) workings have been confined to depths ranging from 100 to 200 ft., and below 400 ft.

nothing payable has been struck. On Collyer's reef, Fig. 131, are no clearly defined leaders, but a series of very narrow veins (rich), intersecting the natural strata at all kinds of angles, and soon worked out. The rock formation comprises very hard sandstone, which is difficult to excavate; and, although the yield of gold was extraordinarily good so far as the workings extended, there appears to be little or no probability of further ex-

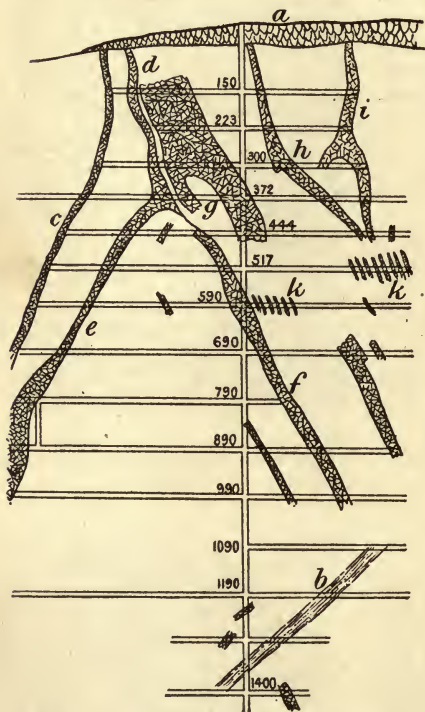

FIG. 130.—GOLD DEPOSITS, PORT PHILLIP.

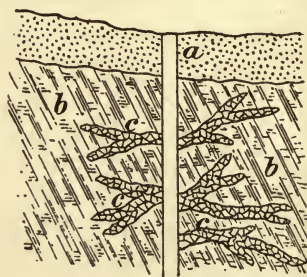

FIG. 131.—GOLD DEPOSITS, COLLYER'S REEF.

plorations. The total yield of gold from 22 tons of stone was 107 oz., averaging 4 oz. 17 dwt. to the ton. The quartz was of a brownish colour, ferruginous, and the gold occurred in the joints and small fractures, and was very fine and pretty equally diffused throughout; no foot or hanging walls. The crushing stuff was of a conglomerated character, 1-4 in. thick. *a*, auriferous alluvial; *b*, sandstone; *c*, quartz. At Specimen Hill, thousands of ounces were got from less than 40 ft. deep; at 300 ft., nothing. The Mosquito, Fig. 132,

* J. Stirling.

† R. Allan.

has proved remarkably rich down to 162 ft.; the general run of quartz bears N. 14° W., and comprises flat leaders and a saddle formation; at No. 11 shaft (*a*) is a conglomerated mass of quartz, slate, and flucan, with detached portions of floating sandstone, nearly all being payable; the gold is both heavy and fine, and generally associated with galena, iron and arsenical pyrites, and blackjack; *a*, No. 11 shaft; *b*, slate; *c*, sandstone wall; *d*, quartz; *e*, rich quartz.*

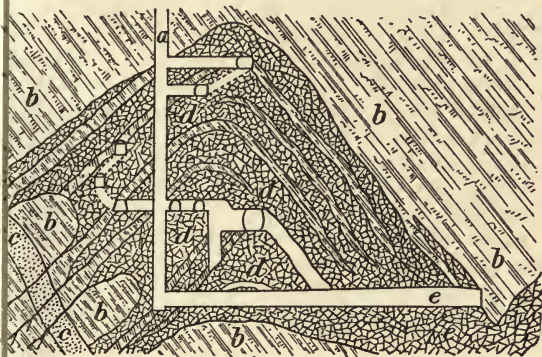

FIG. 132.—GOLD DEPOSITS, MOSQUITO.

At Maldon, dykes or "bars" of granite *a* (Fig. 133) cut the quartz reefs *b*, and generally at these intersections the lode is increasingly rich.†

On some of the Sandhurst mines, the strata have been bent and contorted into anticlinal axes and synclinal troughs, in places (as at *a*, Fig. 134) so sharply that the hard sandstone beds are arched with



FIG. 133.—GOLD DEPOSITS, MALDON.

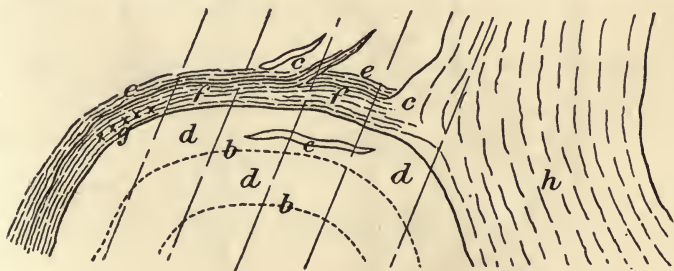

FIG. 134.—GOLD DEPOSITS, SANDHURST.

a radius of 14 ft. only. The anticlinal axes are locally called "centre country"; their general direction is a few degrees W. of N., and, together with the "pitch," determines the strike of the reefs; the latter as a rule conform to the bedding planes *b*. Veins of quartz *c*

* M. Amos.

† E. J. Dunn.

intersect the sandstone *d* and slates *e* in many places, and are known as "spurs"; there are two sets: those dipping S. are barren; those dipping N., auriferous. A width of 30 ft. of slate and sandstone is payable. At *f* occurred much galena, iron pyrites, and mispickel; at *g* the reef was sprinkled with gold the size of currants, through its whole width of 2 ft.; and at *h*, it was 18 ft. wide, and carried 10–15 dwt. gold per ton.*

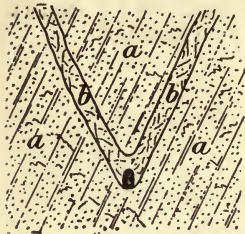

FIG. 135.—GOLD DEPOSITS, RUSSELL'S REEF.

In Russell's reef, Fig. 135, the "legs" are inverted; *a*, sandstone; *b*, reef.

In the Ballarat East mines, Fig. 136, are several vertical lodes *a*, but they are not well defined or regular, in some places being of great width, and then pinching out to very small dimensions. These vertical lodes have so far proved to be scarcely payable (except in one case where they have apparently made into one lode below the 300-ft. level).

Nearly the whole of the gold won has been obtained from flat or diagonal veins *b*, which vary from the horizontal to a dip of 45° E., and in thickness from 1 in. to 10 ft. The slate country rock *e* is nearly

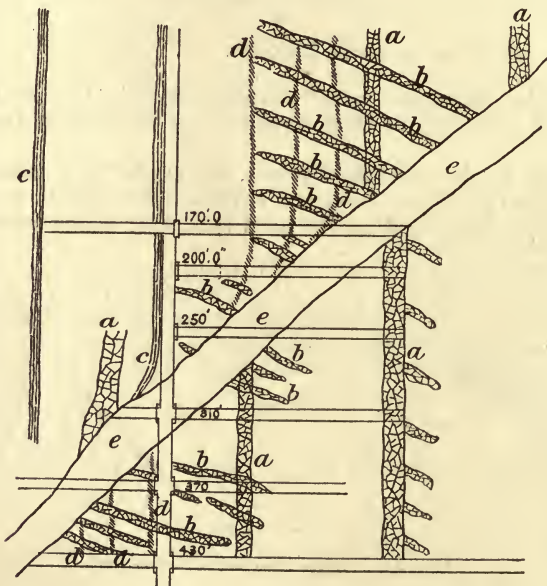

FIG. 136.—GOLD DEPOSITS, BALLARAT EAST.

vertical in the upper levels, but takes a westerly underlay in the deeper ones, and in the lowest levels is about 1 ft. in 6. There are

* E. J. Dunn.

several "indicators" running with the strata, and where these intersect the quartz veins large quantities of gold have been obtained, including nuggets up to 225 oz. These indicators (which are for the most part thin veins of pyrites) continue through the whole length of the belt. In some cases, the flat veins have faulted the indicators and country rock, which would point to the conclusion that they are of more recent date. *e* is a heavy slide.*

At Wedderburn, the country rock is of yellow and grey soft sandstone and clayey beds, having a strike of N. 5° W., dip 60°–80° E. One of the beds of rock is of dark-grey to black colour, and 5–7 in. wide, made up of thinly laminated unctuous clay. This is known to the miners as the "indicator." At intervals of a few inches to several feet apart, are flat leaders of quartz, $\frac{1}{4}$ in. to 1 ft. thick, dipping to the N.W. at angles ranging from 20° to 30°. Where they intersect the "indicator," the latter is generally displaced a few inches. At and near the intersections the quartz leaders become auriferous, and often richly so, the gold occurring in coarse nuggety pieces, and frequently of crystalline character. The leaders are barren, except at the intersections with the indicator, or of nearly vertical thin quartz veins, called "droppers" by the miners.†

Western Australia is likely soon to materially increase the Australasian gold output. As to its geological formation, A. F. Calvert states that the general character of the auriferous country is a series of belts following in the south the coast line which is a little W. of N. and E. of S. The gold reefs traverse the lower Devonian schists, which are more or less altered by the action of the dioritic bosses which have distorted them in many places. These schists lie directly upon the granite, which has lifted them to an angle of 30° to 45°. The granites do not appear in a mountainous form, but take the shape of low ranges, which in many districts have not outcropped more than sufficient to give the country an undulating character. It is these N. and S. belts where the diorites and sometimes trachytes have played their part, which are of importance from an auriferous point of view.

Austria's small product of gold comes chiefly from Rathhausberge, in Salzburg, and from the antimony mines of Kuttenberg, in Bohemia, the gold being recovered as a bye-product. In Schemnitz and Kremnitz, the auriferous quartz lodes occur in eruptive rocks of Tertiary age, chiefly in greenstone-trachyte (prophyrite), porphyries of various kinds, diorite, and granite; a reddish quartz characteristic of the district is impregnated with blende, galena, and pyrites and is locally called *sinopel*. Some of the Transylvanian ores are highly telluriferous.

Canadian gold mines in the Lake of the Woods country are associated with pyrites, mispickel, and galena, the country rock being gneiss, syenite, and diorite.

The gold of Nova Scotia occurs in Cambrian rocks—compact quartzites and sandstones (locally called "whin"), frequently felspathic, rarely calcareous, associated with argillaceous slates (sometimes magnesian or chloritic).

* R. Allan.

† E. J. Dunn.

Gold quartz in Nova Scotia* is distributed through thousands of feet vertically, but the workable deposits commence at about 2500 ft. below the graphitic slates and cease at about 8000 ft., thus leaving an undulating productive belt of 5500 ft. Only those portions of the truncated crests of the foldings which upheaval and denudation have exposed can be approached by the gold seekers; consequently, nearly all the mines are found to be in connection with anticlinals, and no prospecting is attempted outside these productive rocks. Some of the best mines happen to be on the dome-like masses caused by intersection of E.W. and N.S. anticlinals, and, although other good mines are not so situated, yet it may well be that renewed igneous action favoured continued segregations of gold in longer disturbed areas. Most of the gold is got from bedded veins (locally called "leads"); they are intercalated with the quartzites and slates, and follow both their strike and dip. They conform to the foldings of the undulations, and lie at every angle with the horizon; as, however, the productive lodes are found at the anticlinals, the portions mined usually dip at a steep angle. These lodes affect a grouping arrangement, and usually the leads are numerous, though small in size, varying from 1 to 12 or 18 in. Sometimes, and especially in the slates, they are so closely grouped that they can be worked as one large lode, the intervening "whin" being picked out. In an anticlinal assemblage there is often a principal, or very persistent, lode, carrying much visible gold in flakes and grains, which varies from 8 to 12 in. average size. The veins are closely grouped in slate belts, but are not continuous; they squeeze out in length, and are again found farther on, whilst parallel to the squeeze, and in close proximity, another "lead" is developed. These branches vary from $\frac{1}{4}$ to 12 in. in width. In some districts are immense lodes of quartz which are only faintly auriferous. The walls of the bedded lodes when in dioritic quartzite are fused into the quartz, so that it is difficult to separate the waste rock, and this makes extraction of such quartz expensive. Often some slate found on or near the wall ameliorates this. The walls are definite in quartzite, and irregular in slate. Sometimes the lodes are corrugated or wrinkled ("barrel quartz") remarkably, probably by pressure during folding, and the leads associated with these wrinkles are often rich, especially in the broad part of the quartz corrugations. A few gash veins are met with, often well defined and usually rich, but local, and recognised by containing lime carbonate. True veins occasionally occur, sometimes rich, but not persistent. The gold of the bedded lodes is always visible, and no vein is considered worth prospecting that shows no "sights"; it occurs in nuggets, large leaf-like flakes, small grains and strings in the quartz, but "leads" with much fine gold are rare. In nearly all the lodes portions of the vein are rich in gold, whilst between them the quartz is worth but little. These shoots of ore are sometimes 300 ft. long, but are often much shorter. The gold streaks are usually richest in the middle, dwindling irregularly towards the margin. The gold occurs in translucent or milky quartz, the richest quartz possessing a characteristic leaden

* Brenton Symons, "The Gold Fields of Nova Scotia," Proc. R. Geol. Soc. Cornwall.

hue, due to metallic sulphides—mundic, mispickel, galena, blende, chalcopyrite and molybdenite. The presence of sulphides seems essential to a productive lode, and the miner always considers the presence of galena and yellow ore an infallible sign of approaching visible gold. Arsenical pyrites is very plentiful in most lodes, and varies in value from a few pennyweights to several ounces of gold per ton.

Germany's gold comes from the argentiferous galenas, notably near Freiberg.

In India,* schistose rocks, superimposed on gneiss or other metamorphic rocks, are the great gold carriers. Chloritic, talcose, hematitic, micaceous and argillaceous schists are the prevailing forms of the schistose series, and of these the chloritic and talcose varieties have been found most favourable for gold. Hitherto gold has only been encountered in workable quantities in a quartz matrix. Quartz reefs are seen traversing the schist and the underlying gneiss, but it is only in the schists that they have been found commercially productive, although a little gold has been met with in the reefs traversing the gneiss. In South India the gold-bearing rocks are known as the Dharwars; in North India, as the sub-metamorphics. Dykes of diorite and dolerite are met with on most of the gold fields, cutting through the schists and reefs, and displacing or faulting the latter. In many parts of the country, the schists are covered over for miles with a coating of trap rock. On the Kolar field the quartz is of a bluish colour, and very hard and compact. A ribboned or laminated structure is apparent near the walls. The field is much cut with dykes of diorite, some of these being of great size; the main dyke, running N.S., is over 200 ft. thick in some places, and has been traced for 10 miles. Granitic cross-courses, running E.W., also occur. So far the Champion lode alone has been found remunerative, and has yielded over 2,000,000*l.* worth of gold within the last few years. It has been traced about 4 miles, and varies in width from a mere thread to massive "makings" of quartz 20–30 ft. wide. Its average width may be set down at 3 ft. The strike of the reef is nearly N.S., but within this general direction its course may be said to be serpentine, and in places even to double back on itself, so that what may appear from surface outcrops to be two distinct N.S. reefs and E.W. caunters, are really portions of the same reef. The "makings" of quartz, too, are extremely irregular, and there is no uniformity in the width of the lode in successive levels. The strike of the reef is also faulted by trap dykes and granitic cross-courses. The main run of the dykes appears nearly parallel with the strike of the reefs—i. e. N.S., and a trifle more easterly than the reefs. The ore is free-milling, there being very little pyrites present, so that crushing batteries and amalgamators (plates and pans) suffice to secure the bulk of the gold, but there is great difficulty in securing the finer particles of gold which are disseminated throughout the gangue. Owing to the intensely hard nature of the quartz and country rock, and irregularities in the strike and make of the lode, mining has been an expensive item, and averages for 1892 about 1*l.* 4*s.* 6*d.* per ton; milling costs

* Mervyn Smith, "Gold Mining in India," *Trans. Inst. Min. and Met.*, i. 313.

9s. 6d.; and treatment of tailings about 5s. The entire outlay including administration and home charges brings up the cost per ton of ore to 2l. 6s. 8d., or about 41 per cent. of the yield per ton. About 90 per cent. of the assay value of the gold is recovered.

South Africa derives much of its gold from a "cement" or conglomerate locally called *banket*. The geological formation in the Witwatersrand field consists chiefly of sandstones, shales, quartzites, and cherts, tilted into a nearly vertical position (and more or less metamorphosed in places) by the intrusion of a mass of granite. Between the strata of sandstone, &c., come the auriferous beds of conglomerate, attaining a total thickness of 200 ft. sometimes, and extending for many miles in length. Above water line the rock is reddish; below, bluish, due to undecomposed pyrites.

On the Dekaap fields* are found large granitic areas, flanked by schistose and shaly rocks, containing auriferous beds. Dykes of true diorite occur all over the country, penetrating the granite, the tilted schists, the shales, and the sandstones, and influencing the auriferous character of the deposits. A most remarkable feature is the almost entire absence of lime. Quartz not only predominates as a constituent of the granite but occurs among the slaty rocks as segregated masses, interbedded with and replacing them to some extent, often indeed assuming such dimensions as to constitute the larger part of the whole country-rock. Their shape is irregular, but roughly lenticular; they are generally connected by very thin seams; or succeed one another at fairly regular intervals, either in a straight line or on both sides of, and at no great distance from, such a line, which can be termed the axis of their strike, and which coincides with that of the enclosing rocks. Many are auriferous, and they are individually far more persistent in depth than in length. Another class of interbedded quartz-deposits, which may be termed segregated quartz-veins, also occur in these rocks, as a rule extending for considerable distances along their line of strike. They are often very auriferous, and have proved continuous to a limited depth; their width, however, is very variable. These and the large lenticular bodies are generally composed of a dark-blue and homogeneous (never distinctly crystalline) quartz, which sometimes resembles quartzite, from its granulated appearance; where the quartz is milk-white, it shows traces of crystallisation. The associated minerals are all sulphides, usually pyrite or pyrrhotite, more rarely chalcopyrite and arsenopyrite; galenite in one or two places only. Samples from some distance below "water-level," entirely undecomposed, often show large quantities of free gold on being washed. The sulphides are very rich, never, when free gold also occurs, containing less than 5 oz. gold to the ton; 30-50 oz. are not uncommon, and in one instance 760 oz. The shales or schists enclosing these veins are generally decomposed near the surface for some distance on either side, and are often found to be as rich (even richer) in gold as the quartz itself. This decomposition is due to that of the pyrites, as below "water-level" auriferous pyrites are found to be disseminated for a limited distance on both sides of the veins. Throughout these tilted rocks are numerous interstratified

* W. H. Furlonge, Trans. Amer. Inst. Min. Engs.

beds of quartz-rock or quartzite, generally of large size, and continuous for very long distances. Locally, they are termed "bars." The quartz composing them is never crystalline, but compact and amorphous, or gradually passing to roughly granular. In colour, it varies from black to pure white. Very often the whole bar has a banded structure, dark and light ribs alternating, the dividing line corresponding to the strike of the enclosing rocks. Most of these "bars" are due to the replacing of the shales or schists by silica; others probably were originally strata of sandstone, rendered homogeneous by solutions which permeated them and dissolved their component parts, redepositing gelatinous silica. The "bars" of quartzite have a very important practical value, inasmuch as the principal gold-deposits are found in, or immediately adjoining, them, though never without there being also some eruptive rock in close proximity. The gold may occur:—(a) in the body of the bar itself, in "shutes," or evenly disseminated through the whole of it, more sparingly. (b) Where the "bars" have been fissured or fractured, another variety of quartz has been deposited in the cracks and crevices, often differing but little from that composing the bar, but easily distinguishable, being of a different colour and texture, and more pyritiferous. (c) Instead of these deposits of auriferous quartz, in and alongside the "bars" are others, of great extent, of iron oxides, containing 30–40 per cent. iron; all this ironstone carries gold. At surface, the iron-ores consist generally of limonite and hematite, with some magnetite; in depth, the limonite disappears, and the ore then consists of hematite and magnetite, the former always predominating; pyrite also is found in quantity. The gold contained in these ferruginous deposits varies from "traces" to 3–4 oz. per ton, and in the more extensive of the paying ones may be averaged at 18–20 dwt. per ton. The amount which can be extracted by ordinary milling and plate-amalgamation usually does not exceed 7 dwt. The ferruginous deposits are not confined to the "bars," but are also found amongst the slaty rocks, and are known as "burnt leaders" (from their colour); they often "pan" well, and assay better, but are neither large nor continuous enough to be worked with profit. Many beds of argillaceous material, enclosing small "stringers" of quartz, and (from the decay of previously-contained pyrite) now a ferruginous red clay, contain paying amounts of gold. The beds of conglomerate which are enclosed in the tilted strata are to a large extent impregnated with pyrite. In some instances, the whole bed, when oxidised, shows by washing a paying amount of "free" gold; and, when pyritous, often assays over 1 oz. gold to the ton. The auriferous pyrite, and, consequently, the "free" gold, are evidently of later date than the beds themselves, and neither of them is ever found in the quartz pebbles; they are entirely confined to the cementing material. The so-called "alluvial" of these fields is really not alluvial gold at all, in the proper sense of the term. It is usually found on the tops of rounded hills, and in a position where it could hardly have been placed mechanically. Examination almost always shows that the soil is simply a decomposed felsitic rock, probably a diorite in situ, which contains the nuggets, with generally a large

amount of quartz fragments also. There can be but little question that these quartz fragments constituted originally the secondary quartz which filled the cracks and crevices of the more decomposed volcanic dykes.

Of the United States, California is foremost in gold production. Its veins of auriferous quartz are usually described* as segregated veins, in slates and other metamorphic rocks, and more or less parallel with the bedding. The quartz contains auriferous pyrite, free gold, arsenopyrite, chalcopyrite, tetrahedrite, galena, and blende, but pyrites is far the most abundant. Some tellurides have been noted by Silliman at Carson Hill, Calaveras County. The veins approximate at times a lenticular shape, which is less marked in California than in some other regions, and which shows analogies of shape with pyrites lenses and magnetite lenses. In such cases the fissure-vein character is somewhat obscure. Californian veins occupy undoubted fissures in the slates; the largest and best known is the so-called Mother Lode, a lineal succession of innumerable larger and smaller quartz veins running parallel with the strike, but cutting the steep dip of the slates at an angle of 10°. It was doubtless formed by faulting in steeply dipping strata. The wall rocks of Californian veins are serpentine, diabase, diorite, and granite, as well as slate. The serpentine is probably a metamorphosed igneous rock, while the diabase and diorite form great dykes. Considerable calcite, dolomite, and ankerite occur with the quartz, and very often it is penetrated by seams of a green chloritic silicate, which is provisionally called mariposite, as it is probably not a definite mineral, but rather an infiltration of decomposition products. The quartz veins vary somewhat in appearance, being at times milk-white and massive (locally called "hungry," from its general barrenness), at times greasy and darker, and again manifesting other differences, which are difficult to describe, although more or less evident in specimens. The richer quartz in many mines is somewhat banded, and is called "ribbon" quartz. In rich specimens, fluid or gaseous inclusions of what is probably carbonic acid are abundant.† Some quartz shows evidence of dynamic disturbances. The walls of the veins are themselves impregnated with the precious metal and attendant sulphides. The rich portions of the veins occur in shutes to a large degree. The great Mother Lode extends 112 miles in a general N.W. direction. It is not strictly continuous, nor is it one single lode, but rather a succession of related ones, which branch, pinch out, run off in stringers, and are thus complex in their general grouping. It is regarded as a great series of veins along a fissured strip. The veins are often left in strong relief by the erosion of the wall rock, and thus are called ledges or reefs. The gold in the pyrite in most cases is native metal mechanically mixed, and not an isomorphous sulphide. The veins are younger than any of the igneous dykes with them. They may have been filled, as thought by Whitney, during the metamorphism of the rocks attendant upon their upheaval in post-Jurassic time. Certain it is that a very extensive circulation of silicious solutions was in progress.

* J. F. Kemp, 'Ore Deposits.'

† W. M. Courtis.

In the Summit district of Colorado are a number of rich mines where the gold occurs native in quartz on the contact between a rhyolite and trachyte breccia and andesite. The deposits are probably due* to a silicification of the rhyolite along those lines; oxidation and impoverishment of the upper parts led to bonanzas below.

In the Black Hills, South Dakota, gold occurs† under diverse conditions:—(a) in Quaternary and Recent placers, from the degradation of *b* and *c*; (b) in ancient gravels, cemented, obviously due to marine action on the exposed edges of the veins *c*, and only found in juxtaposition to them; (c) in bedded veins of pyritous quartz in the tilted (almost vertical) Archæan schists, forming an enormous ore body several miles long and often 50–200 ft. thick, locally known as the “free-milling belt”; (d) in silicious impregnations which have replaced the calcareous cement of the Potsdam sandstones over an area of about 30–40 square miles, sometimes still pyritous, sometimes oxidised, always associated with “porphyry” dykes and sheets, and constituting the “refractory belt”; (e) as an ingredient of argenteriferous galena, limonite, and iron pyrites, in beds of Carboniferous limestone; (f) in the porphyry itself.

The free-milling ores are very low grade, seldom exceeding 10 dwt. to the ton, but, being in gigantic bodies, admit of mining and milling on a grand scale, and profitably. The major part of the annual output of 150,000 oz. is from this source, and mainly the product of one group of mines. The recent placers are practically exhausted. The cemented gravels are limited in area, and afford an average of only about 3 dwt. per ton, which, however, they yield readily. The Potsdam beds are exceedingly irregular, being very much faulted and jointed, making systematic mining a matter of cost and difficulty, and necessitating much expense for prospecting; moreover, the degree of auriferous impregnation is most erratic, always decreasing more or less rapidly on leaving the fissures through which the infiltration entered (“verticals” of the local miners), so that a great portion of each ore body uncovered is not worth removing, the gold assay ranging from traces up to 2–3 oz. per ton. They require treatment by chlorine or cyanide for extraction of the gold, so that nothing below 12–15 dwt. rock can be dealt with, while there are millions of tons ranging between 5 and 10 dwt. Almost all the porphyry dykes yield traces of gold on assay, and occasional samples go very high (5–10 oz. and more per ton), but they cannot be said to afford any encouragement for industrial mining.

Montana possesses remarkable quartz veins with auriferous pyrite on the contact between limestone and granite, near Bannack; bodies of gold quartz in gneiss, porphyry, or limestone, in Jefferson County; and auriferous silver ore in a true fissure vein in granite, near Phillipsburg.

In Utah, limestones regarded by Blake as Carboniferous, and other sedimentary rocks, have been broken through by great outflows of granite, andesite, hypersthene-andesite, &c. The ore bodies appear

* R. C. Hills.

† C. G. Warnford Lock, “Gold Mining and Milling in the Black Hills, S. Dakota,” *Trans. Inst. Min. and Met.*, iii.

to be contact deposits in limestone near igneous rocks, and carry much free gold.

In the Southern States, segregated veins occur in metamorphic slates, talcose schists, &c., of late Archæan or early Palæozoic age, with numerous associated trap (diabase) dykes; also auriferous beds of slate, gneiss, felspathic and hydromicaceous schists, and limestone. Gold has even been found in a trap dyke.* It is generally in pyrite, and the rock, where productive, is heavily charged with that mineral. The trap dykes have exerted an important influence; at the Haile mines, South Carolina, the rock is rich only near them. They have probably stimulated the ore-bearing solutions. The country rock in the unglaciated regions is often covered to a great depth by the residual clays and other products of its alteration, as much as 100 ft. in places. This material is sometimes called laterite, and where the original rocks have been auriferous, it has furnished loose material for panning and washing, essentially different from ordinary placers, and called "frost drift."† The ores of the Southern States are generally low grade.

In the metamorphic rocks of the Lake Superior iron country, several good auriferous quartz veins have been opened.‡

Douglass Island, Alaska, is remarkable for the Treadwell mine. This is located in a boss or dyke of granite 400 ft. wide, piercing Triassic slates§ and impregnated with auriferous pyrites. The ore body consists in great part of a mass of quartz, felspar, calcite, and pyrite, and is supposed || to have been originally a hornblende granite afterwards subjected to solfataric action, which introduced the gold.

Placer mining.—The formation and peculiarities of placers and the various appliances used by the alluvial miner have received full treatment in an earlier volume,¶ and the following remarks must be regarded only as supplementary.

The prohibition of hydraulic mining in California has led to a great extension of drifting, or tunnelling and breasting on the pay-streak, thus obviating the removal of vast quantities of superincumbent poor or valueless material. In river mining, the common practice on the Klamath is to build wing-dams of rock-filled cribs of poles, faced inside and out with 1-in. planking. Some 10,000–30,000 sq. ft. of the river bottom is thus enclosed, and the water is removed. Then a pit is sunk in the exposed river bottom, the top gravel and sand containing no gold are stripped away by derricks down to pay-gravel, and the latter is washed. In this connection the "stratum tester" shown in Fig. 137 is a simple and efficient machine. It comprises an "Invincible" portable centrifugal pumping engine working in connection with a hydraulic disintegrator. The latter is placed at inlet of suction pipe of centrifugal pump, and its function is to break up the ground in such a manner that it will readily pass through the pump, which is of the same type as those used for dredging. The disintegrator is very simple in construction, and is provided with a series of small jets, from which water under pressure acts upon the stratum to be broken up. A telescopic pipe is provided in the suction

* F. A. Genth.

† W. C. Kerr.

‡ C. D. Lawton.

§ G. M. Dawson.

|| F. D. Adams.

¶ C. G. Warnford Lock, 'Practical Gold Mining.'

main, so that the disintegrator can lower itself automatically as the work proceeds, and, to enable the appliance to work over a certain area, a ball-and-socket joint is fixed in the same pipe. When the material is broken up, it mixes with a quantity of water, is then passed through the pump, and deposited at any convenient site, the water being allowed to return to the pit for use over again. The "Invincible" centrifugal dredging pumping engine is employed in raising auriferous river and sea sand; the operation is much the same as explained in regard to the stratum tester, but the plant is, of course, fitted on board a barge or other suitable craft, and, if necessary, the

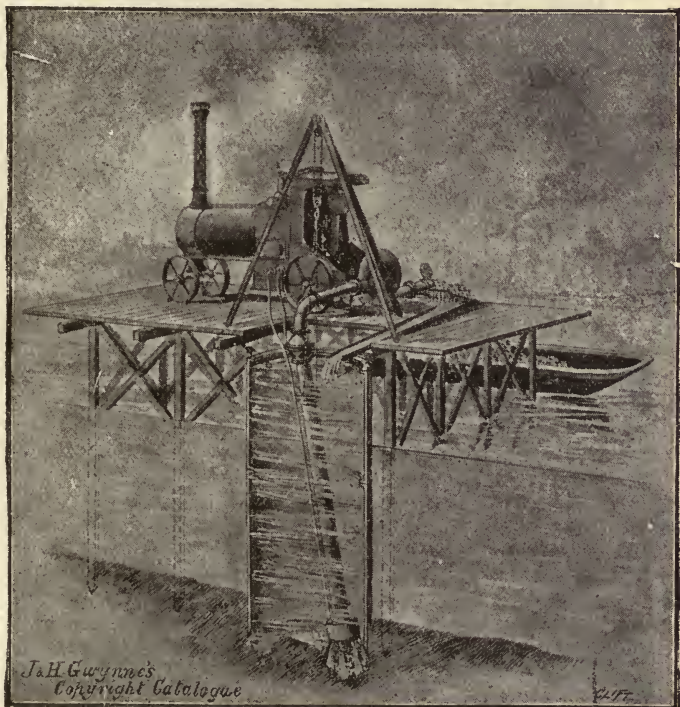

FIG. 137.—GWYNNE'S STRATUM TESTER.

dredgings are forced ashore through pipes. In dealing with sand gravel, or other loose material, no disintegrator is required, and nothing whatever is used beyond a specially designed mouthpiece for inlet of suction. Fig. 138 represents one of these appliances at work delivering ashore, as explained. The great trouble experienced by mining engineers in finding pumps suitable for moving such material, as well as tailings in some instances, is avoided to the utmost by these centrifugal dredging pumps, which are designed and constructed in such a way as to minimise the unavoidable friction. Both appliances just described are made by John and Henry Gwynne, of Hammersmith Iron Works, and 89 Cannon Street, London.

In the milling of cemented gravel modern practice is discarding the stamp battery in favour of the simpler and cheaper arrastra. The

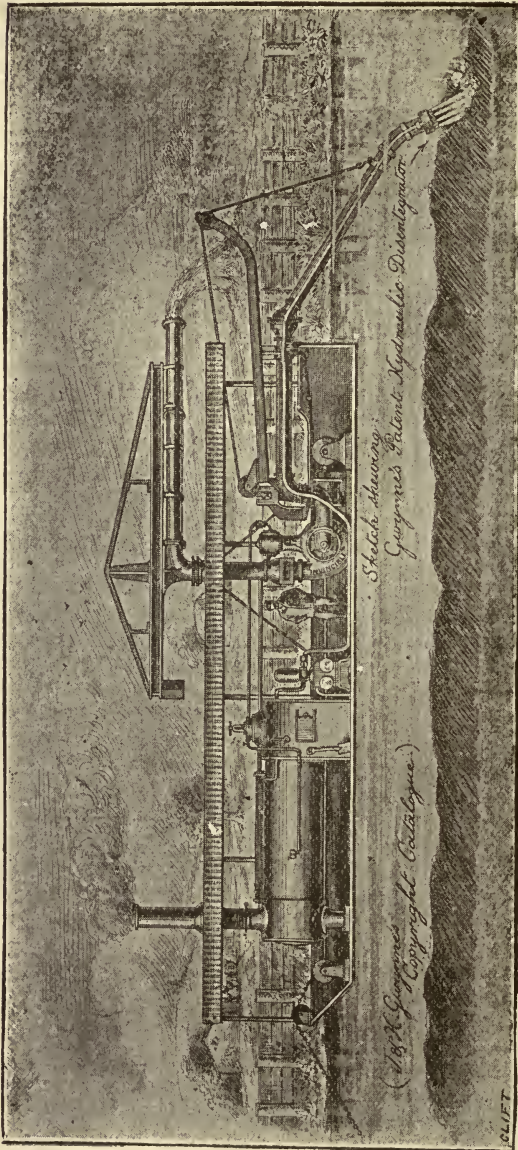

FIG. 138.—GWYNNE'S HYDRAULIC DISINTEGRATOR.

arrastras in use at Smartsville and Mooney Flat contain the principle of the original arrastra, adapted to its operation and handling by

water or steam power. They are 12 ft. diam. and 3 ft. deep; bottoms paved with hard rock roughly dressed, and in such manner as to present as even a surface as possible, and laid in cement, the paving being 16 in. deep. The post in the centre is 14 in. square and 18 in. high, carrying the mast with 4 arms, to each of which a heavy drag is attached. The motive power is transmitted either by means of a large horizontal pulley, through whose centre the mast passes and upon which a belt runs; or by means of a toothed gear fixed in a circle around the mast, and into which a pinion works—a preferable arrangement. The drags are heavy blocks of diabase hung to the arms by means of chains and clamps, and so arranged that all portions of the pit are traversed by them when they are rotated; they weigh 600 to 1200 lb. To charge the arrastra, gravel is run in from a car, or, better, from a shute; 5 to 9 tons constitute a charge. While the charge is being introduced, the speed is lowered, water being added from time to time in order to prevent the charge from caking. A large quantity of water is taken up, and the charge finally has the consistency of thin paste. The arrastra is speeded up to 14 rev. a minute; in the case of hard cement this is kept up 1 hour. It is discharged by opening a gate in the arrastra, which empties directly into the sluice containing the riffles. The charge runs itself out, water being added to facilitate the discharge. By a judicious mixture of "sharp" or crushed gravel and the ordinary gravel that has gone through the grizzly and has not required crushing, it is remarkable what a thorough grinding and pulping the gravel receives from the process. About one tablespoonful of mercury is added to each charge, the loss falling below 10 per cent. The sluice run is nearly 200 ft. long, the boxes containing for the most part ordinary longitudinal riffles. The sets nearest the arrastra, however, have cross riffles, and likewise the last sets in the run. The sluices are cleaned up once a week. Almost the whole of the amalgam will be found in the first cross riffles near the arrastra, very little getting farther down the sluice. When running off the charge, about 30 "inches" of water is required. Drags last 6 weeks, and cost about 5 dol. (1*l.*) apiece. A new bottom costs 40 dol., and lasts about 6 months. The capacity of one arrastra on hard cement is 50 tons per day; on soft "top gravel," 75 to 90 tons per day. The advantages of this process consist in the low first cost of the plant, in its simplicity and that of its mechanical devices, in the extreme cheapness of the cost of treatment, and in the apparent effectiveness of the process itself. When suitably arranged, as in the Wheaton plant in Mooney Flat, the gravel is dumped upon the grizzlies, the coarse going through the Gates crusher, which is superior for this work. The "sharp" and "dull" gravels are then in two separate bins, centrally situated, from which they can be dumped into the arrastras by means of shutes. One man per shift can thus fill, run, and discharge 4 arrastras, being the only man in the mill, with the exception of a rock-breaker. The cost amounts to but 3*d.*-4*d.* per ton.

Quartz reduction.—The pulverising of auriferous rock is governed in general by the same conditions and principles involved in the reduction of any other mineral, with these essential differences:—

(a) that the material is not homogeneous, the richer portion being often more pulverulent than the barren rock; (b) that amalgamation of the metal is often made a simultaneous operation with the reducing. After passing through some form of coarse breaker, as already described (p. 121), the rock is conveyed either to rolls for dry crushing, or to stamp batteries for wet crushing. Fig. 139 illustrates the latest type of stamp battery as made by Robey and Co., Lincoln. It is in 2 sections of 5 heads each working in one mortar box, mounted on one frame, driven independently by a pulley on each side. Its special

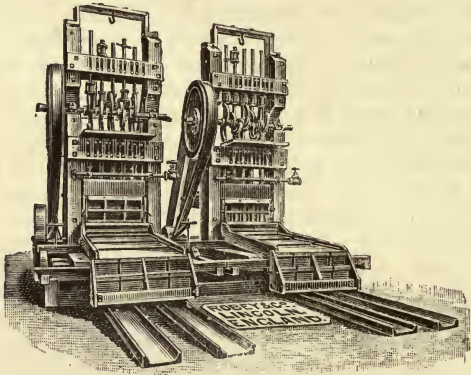

FIG. 139.—STAMP BATTERY.

feature is lightness combined with strength, the form of framing lending itself well to bracing and staging. All bearings are provided with automatic lubricators, preventing leakage of oil into the pulp. Abundant room is provided for access to working parts, everything is made handy and well-fitting, and the materials selected are in accordance with most recent experience in various climates.

The free gold contained in the pulp is caught by mercury applied in various forms of amalgamating apparatus; and the gold enveloped in pyrites and other refractory bodies is recovered by chlorination, cyanide, &c.

IRIDIUM.

THIS scarce metal is quite widely distributed geographically,—in California, Oregon, Russia, India, Borneo, South America, Canada, Australia, and in certain parts of France, Germany, and Spain. The principal sources of supply are Russia and California; it is nearly always associated with either platinum or gold, is recovered as a bye-product, and is always found in small grains or fine powder, the largest pieces being about the size of a grain of rice. In nature it is generally alloyed with other metals, most commonly platinum and osmium; the platinum alloy is called *platin-iridium*, and the osmium alloy *osmiridium* or *iridosmine*. *Platin-iridium* grains are sometimes found as small cubes with rounded edges, while *iridosmine* usually exists in the form of flat irregular grains, and occasionally as hexagonal prisms. The Russian supply of the metal is generally obtained from platinum mines, in the Ural Mountains; while in California it is found principally in the placer gold-washings. The ores of iridium are a source of great annoyance when mixed with gold-dust, on account of its specific gravity being nearly the same as that of gold; consequently, it is impossible to separate the gold from the iridium by washing, though it may be made either by the amalgamation of the gold (as neither iridium nor its ores combine with mercury), or by dissolving out the gold in *aqua regia*. In the mints, these metals are frequently separated by melting the gold-dust, and allowing the molten mass to remain in the crucible for some time, during which the iridium slowly settles to the bottom, as it does not alloy with the gold under such circumstances. The gold is then poured off from the top, and the dregs in the bottom of the crucible are found to contain the greater quantity of the iridium; the gold therewith is then dissolved, and the iridium is found in the residue. In Russia it is contrary to law to possess or deal in iridium ore, because it has been used to adulterate gold-dust, with disastrous results to the coining machinery, owing to its great hardness. Iridium possesses a white lustre, resembling that of steel; its hardness is about equal to that of the ruby; in the cold, it is quite brittle; at a white heat, it is somewhat malleable. It is one of the heaviest metals, having a sp. gr. of 22.38. Heated in the air to redness, it is very slowly oxidised. It is insoluble in all single acids, and in the massive state even *aqua regia* does not attack it. Its leading application has been for pointing gold pens. The iridium point consists simply of a small grain of *iridosmine*, selected by first removing from the ore, with a magnet, the magnetic oxide of iron which always accompanies it, and then dissolving out, by means of acids, the other impurities which may be present; the ore is then washed with water, dried and sifted in order to remove the fine dust, and the sifted ore is then ready for the selection of points, by an operator who rolls the grains of iridium

around with a needle point, examining them under a magnifying glass, and selecting those which are solid, compact, and of the proper size and shape. These points are usually selected in three grades—small, medium, and large—depending upon the size of the pen for which they are intended to be used. The grain of iridium having been soldered on to the end of the pen, it is sawed in two (which makes the two nibs of the pen), and ground up in the proper shape.

By heating the ore in a Hessian crucible to white heat, adding phosphorus, and continuing the heating for a few minutes, perfect fusion ensues, and the metal can be poured and cast, but the presence of $7\frac{1}{2}$ per cent. phosphorus is an obstacle in the way of its use for electrical purposes. On heating the metal in a bed of lime, the phosphorus is completely removed. In this operation, the metal is first heated in an ordinary furnace to white heat, and finally, after no more phosphorus makes its appearance, it is removed and placed in an electric furnace with a lime crucible, and there heated until the last traces of phosphorus are removed; the metal which then remains will resist as much heat without fusion as the native metal. For mechanical applications, where the metal is not subject to great heat, it is melted with phosphorus and cast into the shape desired, and then ground or worked, as the application may require. Its hardness is now finding it many useful spheres, both in the solid form and in plating.

IRON.

THIS metal is one of the most abundant and widely disseminated elements of the earth's crust, its distribution being materially aided by the fact of its forming two oxides of different chemical quantivalence. Apart from the accumulations of the metal in the form of ores, more or less pure, it is found in large proportions in many igneous and metamorphic rocks, notably as oxides in basalts (12–20 per cent.), diorites and diabases (4–16 per cent.), andesites (3–15 per cent.), porphyries (0–14 per cent.), rhyolites (0–8 per cent.), and granites (0–7 per cent.). In the sedimentary rocks it is less marked, but all limestones and sandstones may be said to contain it, as well as sands, clays, and gravels. The industrial sources of iron are the following ores:—

Magnetite, or magnetic iron ore, Fe_3O_4 —72 per cent. iron.

Hematite, in two forms, red hematite, and specular iron ore or iron glance (also micaceous iron ore), Fe_2O_3 —70 per cent.

Limonite, or brown hematite (also bog ore, lake ore, and black brush ore), $2\text{Fe}_2\text{O}_3, 3\text{H}_2\text{O}$ —60 per cent.

Siderite or spathic iron ore (also clay ironstone, sparry iron, clay band, black band, coal measure iron, argillaceous iron ore), FeCO_3 —48 per cent.

Pyrite, pyrites, or mundic, FeS_2 —46 per cent.

These percentages refer to pure ores, but they never occur pure in large quantities. The best known output of magnetite was 40,000 tons averaging $68\frac{1}{2}$ per cent., while the Lake Champlain mines afford much at 63–65 per cent. when dressed, but as low as 50 per cent. when mined. The specular hematites of the Lake Superior mines reach 60–65 per cent., and the red hematite of New York about 44 per cent. The limonites vary between 40 and 50 per cent.; and the crude spathic ores reach as low as 20 per cent., or even less, being largely contaminated with clay and bituminous matters. The usual impurities of all iron ores are the common elements or oxides that enter most largely into rocks, and those which make up the walls of the deposit are usually the ones that appear most abundantly in the ore. Silica (SiO_2), alumina (Al_2O_3), lime (CaO), magnesia (MgO), titanium oxide (TiO_2), carbonic acid (CO_2), and water (H_2O) occur in large amounts, and determine to a great extent the character, fluxing properties, &c., of the ore. With these, and of superior influence, are smaller amounts of sulphur and phosphorus. The last two and titanium chiefly decide the character of the iron which is yielded in the furnace, and are the first foreign ingredients considered. The sulphur is present in pyrite, the phosphorus in apatite. For Bessemer pig irons, which command the best market, the extreme allowable limit of phosphorus is .1 per cent.; thus a 65.3 per cent. ore should

not have over .065 per cent. phosphorus to be ranked as Bessemer, and if, combined with sufficiently low phosphorus, the gangue is highly silicious, even low grade ores may be of value, though remotely situated. Thus the lump magnetite of the Chateaugay mines, affording but 50 per cent. iron, is mined and transported over 400 miles to the furnaces; it has 18.44 per cent. SiO_2 and only .029 phosphorus and .052 sulphur. A moderate amount of phosphorus is not only no drawback for ordinary foundry irons, and such as are to be subjected to tool treatment, but it is a prime necessity; excessive amounts are desired only for weak but very fluid irons. Considerations like these help largely to determine the value of a deposit of iron ore.

The annual production of iron ores in the United Kingdom is about 14 million tons, classified approximately as 8 million carbonate, $3\frac{1}{2}$ brown ironstone, $2\frac{1}{2}$ red hematite, and 150,000 tons aluminous hematite. The Cumberland ores give 53-60 per cent. metal in the furnace, and the N. Lancashire 51-55.

For all practical purposes, our home production of ore may be divided into the two categories of hematite and lias, the former represented by Cumberland and Lancashire, and the latter by Cleveland, Lincolnshire, and Northamptonshire. The three latter districts produce more than 50 per cent., and the former 18 per cent. of all the iron ore raised in the United Kingdom. Of the lias iron ore there is practically an unlimited supply. Of hematite, however, the quantity available is more uncertain; and although it has recently been proved by new discoveries to be more abundant than was at one time supposed, it is doubtful whether the present annual output of about $2\frac{1}{2}$ million tons could be largely augmented or indeed be quite maintained. As it is this description of home ore that is insufficient for our requirements, the sources of external supply become not only an important but a pressing question.*

The clay band deposits of N. Staffordshire are a valuable source of supply for blast furnaces, and contain only traces of phosphorus and sulphur. Some of them yield 90 per cent. metal after calcination at the mine mouth.

The iron ores of the United Kingdom are mined under more advantageous conditions, as regards cost, than those of most other countries. According to official returns, the average quantity of iron ore produced per miner is about 631 tons per annum in Luxemburg, 559 tons in England and Wales, 352 tons in France, 228 tons in the United States, and 213 tons in Germany. If we take into account the fact that the average quality of the iron produced in England is much higher than that of Luxemburg, these figures would indicate that we have the cheapest iron ores of all the great iron-producing countries, even when allowance has been made for differences in the rate of wages. Nor is our position less favourable as regards cost of transport: in general, the iron ore mines are less than 30 miles from the place at which they are smelted; in Continental countries, and in the United States, no similar advantages exist.

The only two countries in Europe other than our own that appear

* J. T. Smith.

to possess any considerable deposits of iron ores adapted for the making of high-class Bessemer iron are Spain and Sweden.

Spain has two districts that are unusually rich in ores of high quality. Up to the present time, Bilbao has turned out about 40 million ton of ore; and an estimate made in 1884 put the total quantity of unworked ore in the Sommorostro district at 50 million tons, which would be reduced, if it still held good, to less than 30 million at the present time. Farther inland are large virgin fields of ore, which are computed to add another 40 million tons. This would meet the present demand, along with the ores of Sommorostro, for perhaps 20 years. The ores of the South of Spain are virtually untouched, although, so far as can be ascertained, they are of at least as high a quality, and probably can be worked fully as cheaply, as those of the North. Between Malaga and Carthagená there are some large and easily-worked deposits of high-class ores, a few of them running up to as much as 65 per cent. iron, and at least one or two of them within 20 miles of the coast. The ores of the South of Spain are well adapted for the Bessemer and open hearth processes, and it is a general characteristic of these ores that they contain considerably more manganese than those found in the North, reaching up to as much as $4\frac{1}{2}$ per cent., and averaging in some districts $3\frac{1}{2}$ –4 per cent.; while they exist both as hematites and as magnetites, the former occasionally running more or less into spathic ore. It has been found that ores of this class are admirably adapted for mixing with other high-class ores, such as the hematites of West Cumberland and Lake Superior. The mining of these ores has at present hardly commenced; but labour is very cheap in the South of Spain, being little more than one-half of what it costs in the North. On the other hand, there is the drawback of greater cost of transport.*

The rocks associated with the Bilbao iron ore belong to the Cretaceous formation. Blue limestone and shales are found above it, and limestone and schistous grit below it. The latter is recognised as the floor of all the deposits. The ores are classed as follows:—*rubio*, a brown hematite or hydrated ferric oxide ($\text{Fe}_2\text{O}_3 + \text{H}_2\text{O}$), which forms the great bulk of all now produced; *campanil*, a red hematite or ferric oxide (Fe_2O_3), containing a somewhat less quantity of water in combination; *vena dulce*, also a hydrated ferric oxide (Fe_2O_3), found in veins, is of a soft and porous nature, and is more or less intimately mixed with both of the above kinds; spathic ore, siderite or ferrous carbonate (FeCO_3). The upper portion of the deposits generally consists of *rubio*. It is full of cavities, some of which contain earth and clay; and, consequently, it requires more careful selection than the other kinds. It has always a honeycombed appearance. Brown hematite and spathic ore are sometimes found mixed in broad bands, locally called *pedrisco*. The deposits are all of aqueous origin.

The quality of the Bilbao ores for smelting purposes is exceedingly good; in other words, they are easily fused. *Rubio* contains on an average about 50 per cent. metallic iron, as delivered in cargoes, and *campanil* a little less. Down to a certain depth in the mines the quality seems to improve. Reduced metallic yield generally arises

* J. T. Smith.

from want of care in selection, or from wet weather at the mines, when the mineral is so coated with muddy water that it is difficult to detect impurities. In the annexed table are average analyses of the four kinds of Bilbao ore, compared with good Cumberland hematite and the best ore raised in the Forest of Dean.*

In examining these analyses the following points seem noteworthy. Rubio and campanil do not differ much in richness; but in the former case the allied minerals consist more largely of silica and combined water, and in the latter case of lime and carbonic acid. Vena is richer in iron and manganese, and freer from silica, than either of the two kinds previously named. In lime and carbonic acid it is on a par with rubio, and in freedom from combined water it is more than equal to campanil. It is, therefore, the richest and purest of the three kinds. Good Cumberland hematite ore excels rubio and campanil, in the proportion of iron it contains, also in freedom from combined water and moisture; but it has considerably more silica and alumina, and somewhat more sulphur and phosphoric acid. The best ore obtained from the Forest of Dean is considerably richer in iron than rubio and campanil, and almost equal to vena; and if there was only sufficient of it, and it could be cheaply raised, there would be much less need to import from abroad than is now the case. Spathic ore has less iron, and more silica, combined water, carbonic acid, and sulphur, than any of the others named. If calcined, however, it loses 25 per cent. of its original weight, and then becomes nearly as rich and pure as rubio.

Constituents.	Rubio. Brown Hematite.	Campanil. Red Hematite.	Vena. Purple Red Hematite.	Spathic. Ferrous Carbonate or Siderite.	Good Cumberland Ore. Red Hematite.	Best Forest of Dean Or Brown Hematite.
	per cent.	per cent.	per cent.	per cent.	per cent.	per cent.
Peroxide of iron, Fe ₂ O ₃ ..	80·71	78·426	85·71	..	82·280	83·50
Protoxide of iron, FeO	0·90
Protoxide of manganese } 77½ per cent., MnO ..	0·92	1·303	0·419	0·09
Peroxide of manganese } 69½ per cent., Mn ₂ O ₃	3·50
Alumina, Al ₂ O ₃	1·22	1·130	0·95	..	3·060	0·72
Lime, CaO	0·31	3·55	0·35	1·18
Magnesia, MgO	0·10	0·18	0·16	..	0·180	0·65
Silica, SiO ₂	7·50	5·48	4·70	11·68	10·525	2·52
Carbonic acid, CO ₂ ..	None	4·50	0·20	..	0·600	1·45
Sulphur, S	Traces	Traces	Traces	1·09	0·050	0·01
Phosphoric acid, P ₂ O ₅ ..	0·03	0·02	0·02	..	0·042	0·05
Combined water, H ₂ O ..	9·00	4·60	4·15	..	2·204	8·90
	99·79	99·189	99·74	..	99·360	99·97
Loss by calcination	25·00
Moisture	11·00	11·00	14·00	..	5·80	..
Metallic iron, dry, Fe ..	56·50	54·90	60·00	..	57·60	59·15
Iron in damp ore	50·29	48·87	51·69	40·00	54·25	54·25
Iron in calcined ore	53·33

The mining consists in the removal of ore by cutting away in levels or steps, 30–60 ft. high, and a considerable length. In some cases a tunnel is made at or below the lowest level of the ore, and is driven in as far as the working face. A shaft and side entrances are made down to it, and through these the ore is shot and loaded into trucks. The quarry levels are worked gradually down to and even below the tunnel. But in the latter case a shell of unworked mineral is retained round it, to protect the rolling stock from the results of blasting, &c. It is customary to drill deep holes into the working faces with a succession of jumpers, longer and larger ones being employed until a depth of nearly 30 ft. is reached. A small charge of dynamite is then inserted, and fired by a fuse. This enlarges the end of the hole into a chamber, into which is introduced a larger quantity of dynamite, and the explosion of this brings down a considerable quantity of mineral. No machine drilling is in use. About 2000–3000 tons are the largest quantities usually brought down by a single blast. Vena ore can be easily got with a pick. After disintegration by blasting, the fallen masses are immediately attacked by men and boys with hammers, wedges, and crow-bars, and split up into pieces of a portable size; impurities are here separated, and taken to the spoil heap. The cost of quarrying and selecting varies considerably, according to circumstances. In a few campanil mines it is as low as 1s. per ton; but in rubio mines, where more selection is necessary, it goes up to 2s. Of this, $2\frac{1}{2}d.$ – $4\frac{1}{2}d.$ per ton is for explosives and tools, and the rest for labour.

Two kinds of aerial tramways are used: about 20 miles of Hodgson's and 2 miles of Bleichert's. In Hodgson's system an endless steel wire rope is made to travel by means of an engine fixed at the lower end. The buckets are hooked on to the rope at intervals, and move with it, passing over the pulleys as they come to them. The full buckets travel in one direction, which is generally down hill, and the empty buckets in the opposite direction on the return rope. At either terminus they are switched on to an outer rail, to be loaded or tipped, then run round on two rollers attached to the hanger, and finally entered on the return rope. At each "angle" for changing the direction of the route they are switched by hand. Stretches must not exceed 2 miles each; there may be several endless ropes on each set of trestles, but two is the most usual. The quantity conveyed is about 2000 tons per rope per week of 72 hours. Each bucket holds 4 cwt., and one passes every 26 seconds, which is equivalent to 28 tons per hour. The place where the hanger bears upon the wire rope is furnished with a seating of rubber, which acts as a spring, and grips the rope without damaging it. The system will not do where the inclination exceeds 1 in 4, as then the hangers slip upon the rope in wet weather. To obviate this difficulty, Bleichert's system was introduced. In this the main rope is stationary, the buckets travelling on it, as on a rail, and being hauled by a subsidiary rope; when the gradient exceeds 1 in 4 the traffic becomes self-acting. But it is more costly in construction and in maintenance, and it is not capable of duplication on the same trestles. The two ropes only last a single year, as compared with one rope lasting two years in Hodgson's

system. The relative costs of construction are—Hodgson's, about 2000*l.* per mile, single line; Bleichert's, about 4000*l.* But the latter system is capable of conveying nearly one-half more than the former per annum. The cost of transport is about the same in each case, viz. 7½*d.* to 1*s.* per ton per mile. In both systems a powerful brake is required to regulate the speed, and tightening apparatus to keep the rope in uniform tension. In addition, there are a number of self-acting rope and drum inclined planes, built by the Consett Iron Works, near Durham. These operate at a cost of 3*d.*–4*d.* a ton.*

Sweden and Lapland possess enormous iron ore deposits. The Swedish ores are remarkably free from phosphorus, Dannemora containing only .003 per cent., Persberg .004–.005 per cent., Stora Bisberg under .01 per cent.; but in Grangesberg, and in Gellivara, Kirunavara, and other places in Lapland, the percentage reaches 4–6, or even more.†

The Gellivara and neighbouring deposits are of gigantic proportions, and official surveys report of them:—(a) that the ore is all more or less magnetic, the metallic iron contained being in the condition of protoxide, peroxide, or magnetic oxide, or a combination of these; (b) that it is found in lodes or veins, which, together with the bedrocks in which they lie, appear to have had an intrusive origin, and are usually more or less distorted; (c) that the lodes are associated with gneiss, quartz, felspar, granite, hornblende, and mica schist; corundum, fluor-spar, calc-spar, actinolite, adamantine, asbestos, epidote, and garnets are also found in or about them; (d) that the phosphorus is in the form of apatite ($\text{Ca}_3\text{P}_2\text{O}_4$), and can to a great extent be separated by hand-picking; (e) that ore sufficiently free from phosphorus for acid steel purposes is but a portion, say one-fifth, of the whole.

The deposits of limonite now in process of formation in some of the Swedish lakes, and from which they are periodically dredged, are geologically interesting, but not economically important.

The iron ores of the island of Elba, once deemed so important, embrace specular ore, hematite, limonite, magnetite, and spathic carbonate. The veinstuff is quartz, and the ores generally contain titanium and manganese. The deposits are ascribed to ferruginous thermal springs.

The United States produce some 16 million tons of iron ore yearly. The relative importance (in tons) of the different kinds in 1880 and 1890 is shown in the following figures:—

	1880.	1890.
Hematite	2½ million	10½ million
Magnetite	2½ "	2½ "
Limonite	2½ "	2½ "
Siderite	1 "	⅓ "

Pennsylvania leads in limonite, Michigan in hematite, New York in magnetite, and Ohio in siderite, mining no other kind. The most famous iron-ore mine in the country is that at Cornwall, Pennsylvania, which has been in operation since 1740, and has yielded more

* J. Head, Brit. Assoc.

† H. Lundholm.

than 10,000,000 tons of magnetite. The production of limonite is more widely extended than that of any other variety; it is raised in 24 States, hematite in 17, magnetite in 13, and siderite in 8. The average contents of metallic iron in the ores of the United States was 51.07 per cent. by the census of 1880, and 51.27 per cent. by that of 1890. The richest ores (60 per cent.) are mined in Minnesota, and the poorest (40.7 per cent.) in Georgia and North Carolina. With the exception of the Cranberry mines in North Carolina, which in 1892 produced 18,433 tons, no Bessemer ore of any moment is mined in the Southern States.

Wherever the Clinton stage of the Upper Silurian outcrops, it almost invariably contains one or more beds of red hematite, interstratified with shales and limestones. These ores are of extraordinary persistence. In general, the Clinton ore is characterised by a high percentage of phosphorus, and is seldom, if ever, available for Bessemer pig; it is chiefly employed for ordinary foundry irons, the percentage of iron varying much. These hematites have undoubtedly originated in some cases by the weathering of ferruginous limestones above the water level. The unaltered limestones at the bottom of a mine at Atalla, 250 ft. from the surface, contained but 7.75 per cent. iron, while the outcrop afforded 57.52 per cent.; in another case there was a gradual increase of lime from a trace at the outcrop to 30.55 per cent. at 135 ft. Geologists have explained these beds as due to the bringing of iron in solution into the sea of the Clinton age, and to its deposition as small nodules, or as ferruginous mud, forming an oolitic mass, as in the modern Swedish lakes. The structure of the ore varies: (a) it is a replacement of fossils, such as crinoid stems, molluscan remains, &c. (fossil ore); (b) small oolitic concretions, like flaxseed (flaxseed ore, oolitic ore, lenticular ore); (c) elsewhere it is known as dyestone ore. In many places it is really a highly ferruginous limestone, and below the water level in the unaltered portion it often passes into limestone, while along the outcrop it is quite rich.

The important Lake Superior deposits are bodies of hematite, both red and specular, soft and hard, in metamorphic rocks; they vary widely in shape, although at times are quite perfectly lenticular; and are usually associated with jasper and chert, having for a footwall a relatively impervious rock of some sort. Magnetite is at times present. They are of varying physical structure and associations. The five principal ore-producing belts or districts (also called "ranges," as they follow ranges of low hills) are the Marquette, the Menominee, the Gogebic or Penoque-Gogebic, the Vermilion Lake, and the Mesabi (Mesaba). The geology of these districts has been a subject of much controversy. The ore bodies were in earlier years generally regarded as true beds of greater or less extent, and often of great irregularity. They approximate a lenticular shape in the simplest development, as is shown in the less disturbed districts, but in the Marquette region this is at times obscured by the excessive disturbances. They often follow the foldings of the walls, particularly in synclinal troughs. Later developments have brought out the fact that the ore bodies are associated with some underlying rock that is relatively impervious. The favourite one is the so-called "soaprock,"

an altered igneous intrusion that is chiefly in dykes. Beds of jasper seem to play the same rôle. Van Hise notes 4 deposits: (*a*) on the contact of a quartzite conglomerate (the base of the Upper Marquette) and the ore-bearing formation; (*b*) on soaprock, which grades into massive diorite; (*c*) on dykes of soaprock, which follow along or cut across the ore-bearing formations; (*d*) interbedded in the jasper or chert. On the east the soft hematites (limonites) are first met; then in going west the red and specular hematites; and then the magnetic character increases, until at the western end of the district the magnetites are most abundant.

In the Menominee district, the geological section immediately associated with the ore involves (*a*) 1200 ft. of silicious ("Norway") limestone; (*b*) 1000 ft. of the Quinnesec ore group, consisting of limestone, silicious or jaspery slates, hydromica schists and slates, and ore bodies; (*c*) the Lake Hanbury slate group, overlaid unconformably by Potsdam sandstone. The ore occurs along two or three planes of deposition in *b*, and not far from contact with *a*. Fig. 140 illustrates* the general structure: *a*, silicious (Norway) limestone; *b*, Quinnesec ore group; *c*, Lake Hanbury slates; *d*, Potsdam sandstone; *e*, red ore; *f*, blue ore.

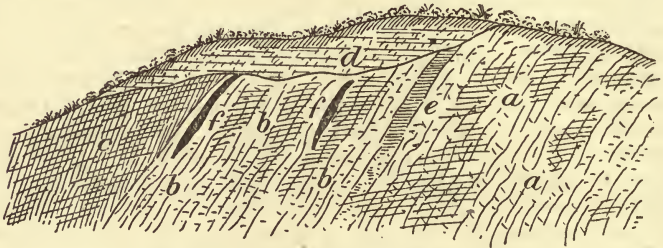

FIG. 140.—IRON DEPOSITS: MENOMINEE.

In the Penokee-Gogebic district the rocks are less metamorphosed. The strata run E.-W. with a N. dip of 60° - 80° , and with no subordinate folds; they consist of cherty limestone at the base, followed by quartz, slates, quartzite, iron ore, and ferruginous cherts, and finally slate and schists; and are traversed by dykes. The ore is a soft, red, somewhat hydrated hematite, with more or less manganese, which is often considerable, and is most abundant in the southern mines; hard specular is rare. Van Hise has proved the ore bodies to be in the troughs formed by the intersection of northerly dipping compact quartzites, and southerly dipping trap dykes. He has traced the iron to a source in the layers of cherty carbonates, parallel with the quartzites and above them. From this it has been leached out by the percolating water, and has been deposited in the apices of the troughs, where it has replaced the original carbonate rocks.

The ores from Tower and Ely, in the Vermilion Lake district, are high-grade Bessemer, and are produced in great quantity.

In the Mesabi district,† the ore lies under the black slates

* J. Fulton, Trans. Amer. Inst. Min. Engs., July 1887.

† J. F. Kemp, 'Ore Deposits.'

(Animikie) and over the quartzite (Pewabic); the ore bodies are all south of the granite ridge called the Giants' range. Upon the southern slopes of this range lie the green schists of the Keewatin, unconformably overlain by the Pewabic quartzite; on this rests the ore-bearing rock, jaspery quartzite ("taconite"); over this, in order, come greenish silicious slates and cherts, black slates (Animikie), and great masses of gabbro. On the flanks of the Giants' range the dip is steep, but it flattens out nearly to horizontality away from the granite. The ore bodies lie on the southerly slopes of low hills, and are found immediately below the mantle of glacial drift, which varies up to 100 ft. in thickness. The ore is (a) soft, blue, earthy, and sandy hematite, and (b) hard specular; with these are limonites and paint ores. The sections show at times 50 ft. and more of excellent hematite, which may be of exceptional purity and far below the Bessemer limit of phosphorus, or which may slightly exceed it, but in general it is quite high-grade, silicious, low phosphorus ore. The ore bodies may be directly on the Pewabic quartzite, as seems usual,

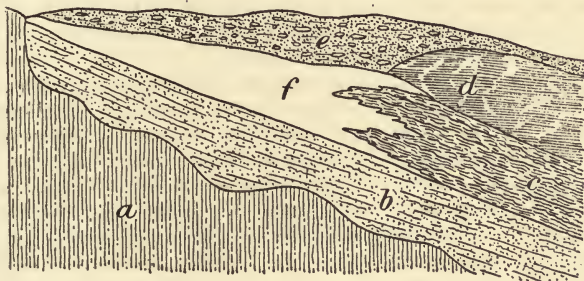

FIG. 141.—IRON DEPOSITS: BIWABIK.

or else entirely in the taconite. They fade out into the latter along the dip. They are regarded as having originated by replacement of the taconite. This rock sometimes contains calcareous streaks, that have perhaps aided in furnishing the carbonic acid, which, it is thought, has dissolved the silica of the quartzite (taconite) in the replacement process. Fig. 141 illustrates a section at the Biwabik: *a*, green schist; *b*, quartzite; *c*, banded ore and taconite; *d*, slates; *e*, glacial drift; *f*, ore. When the surface is stripped off, the ore is found in flat deposits, covering 60 or more acres, and 20–90 ft. thick. Test pits are sunk in places 117 ft. deep by pick and shovel, without a single drill hole or blast of powder. In other spots there may be 20 or 30 ft. in a pit which is too hard to pick. This can be thrown down in large quantities when there is once a face on it, and can then be loaded by hand or steam-shovel. Where no blasting is required, the expense of loading cars by hand labour will not exceed 25 cents (1s.) per ton; by steam shovel it may reach 10 cents (5d.). Where the ore is hard enough to blast, the expense of excavating and loading on cars may reach 40 cents (1s. 8d.). When the surface is removed, the ore is practically in a huge stock-pile, containing, in some instances,

several millions of tons. At the maximum cost of mining this by hand, and in hard ore, the cost of stripping and placing ore on cars is 48 cents (2s.) per ton. The minimum cost is 11·2 cents. ($5\frac{1}{2}d.$). The average is about 29·5 cents (1s. 3d.). But as there is more soft ore than hard, the average may be expected to be about 25 cents (1s.). The average quality of 145 samples from 12 mines gives: iron, 61·05; silica, 6·18; phosphorus, ·0544. Manganese was found in 54 of these samples varying in amount from ·06 to 1·657 per cent., and with an average of ·667. Of the 12 mines the Biwabik makes the best showing, giving as an average of 60 samples: iron, 63·70; silica, 3·46; phosphorus, ·0455.*

Iron Mountain, Missouri, consists of felspar porphyries, more or less altered, and seamed with one large parent mass of ore, and innumerable minor veins that radiate into the surrounding rock. Upon the flanks of the porphyry hill rests a mantling succession of sedimentary rocks, that dip away on all sides. The lowest member is a conglomerate of ore fragments, weathered porphyry, and residual clay left by its alteration, and now the principal source of ore. It is mined underground, hoisted and washed by hydraulic methods, like those employed in the auriferous gravels of California, and then jigged. The apatite has largely weathered out of it.

Beds of magnetite, often lenticular interstratified with Archæan gneisses and crystalline limestones, are extensively developed in the Adirondacks, in the New York and New Jersey Highlands, and in western North Carolina. Titanium is often present in such amounts as to render the ore valueless; and apatite is always found, although it may be in very small quantity. Chlorite, hornblende, augite, epidote, quartz, felspar, and a little calcite are the common associated minerals. The Adirondacks are very largely knobs of a rock, which is chiefly labradorite, with some hypersthene and other bisilicates, and variously called labrador-rock, norite, hypersthene-rock, anorthosite, &c. Associated with it, especially in the foothills, are gneiss and crystalline limestones, in the former of which occur the magnetite deposits now wrought; but there are also large bodies of magnetite in true igneous gabbros. The Chateaugay ore body is really a bed of gneiss very rich in magnetite, rich enough in places to afford a merchantable ore; great part of it, however, requires concentration. Commercially the Adirondack ores are divided into (a) high in phosphorus but low in sulphur; (b) low in both phosphorus and sulphur; (c) pyritous; (d) titaniferous. Under *d* come numerous beds which are worthless, but which, if the titanium could be neutralised, would be very valuable. Mineville is by far the most productive region (400,000 to 500,000 tons yearly); Chateaugay and Hammondville are next.† Similar lenticular beds occur in the Archæan gneiss and crystalline limestone in New York, New Jersey, and Pennsylvania, and are more regularly distributed. The Tilly Foster mine is typical and important. The Chaffee county, Colorado, lenses are in syenite (Silurian age); the ores average 57 per cent. iron, ·1–2 sulphur, and only ·009 phosphorus. Immense beds of soft magnetite occur at Cornwall, Pennsylvania, associated with green slates, Cambrian lime-

* H. V. Winchell.

† J. F. Kemp, 'Ore Deposits.'

stones, and Triassic sandstones, pierced by dykes of Triassic diabase. The ore is mined in enormous quantities by open cuts. In Iron county, Utah, are beds of magnetite and hematite bearing evidence of being metamorphosed limonite, in limestones of questionable Silurian age, and associated with eruptive rocks described as trachyte. The limestones have been much upturned, metamorphosed, and pierced by dykes and eruptive masses. The ore forms great projecting ridges and prominent outcrops, locally called "blow-outs," of the usual lenticular shape. Magnetite sands are concentrated on many seabeaches, but the proportion of titanitic acid generally present is a bar to their use on account of its destructive action on the furnace linings.

Limonites, in their simplest form as bog iron, are not often practically available, on account of low percentage in iron (due to sand and silt washed in) and frequent large amounts of sulphur (pyrite) and phosphorus (vivianite). Sometimes much chromium is present, when the ore has been formed by leaching serpentine. Beds resulting from basalt occur in Ireland and Hesse. An oolite or limonite sand forms in some Swedish lakes at the rate of about 1 ft. in 20 years. Colorado limonites are found in cavities in Silurian limestone, and are used as flux in lead smelting, while a similar use is made of limonites encountered in Carboniferous limestones in Utah. Sometimes (in Massachusetts, &c.) limonite forms geodes, or "pots," pipes, stalactitic masses, cellular aggregates, and smaller lumps, from which the barren clays and ochres can be removed by washing. The ore is but a fraction of the material mined, occurring in irregular streaks through the clays, &c., and is mostly obtained by stripping and open cuts. Limonites are commonly formed by the weathering of ferruginous limestones. They are not generally Bessemer ores.

Siderite or spathic iron ore often contains more or less calcium, magnesium, and manganese. When concretionary, embedded in shales, and containing much clay, the ore is called "clay ironstone;" when the concretions enlarge and coalesce, so as to form beds of limited extent, generally containing much bituminous matter, they are called "black-band," and are chiefly developed in connection with coal seams; when in beds, it is sometimes called "flagstone" ore; when broken into rectangular masses by joints, "block" ore. The so-called "ferriferous" limestone of Pennsylvania affords beds of carbonate known as "buhirstone" ore, which is largely altered to limonite—a common feature with siderites. They are especially found in the Carboniferous, sometimes in Jura-Trias, and rarely in Cretaceous beds.

The Cuban iron ore deposits, found in the Sierra Maestra range, are one of the most important groups of Bessemer iron mines in the world, and are operated by Philadelphia smelters. The ore can be mined with great facility by open cuts. Analyses show $67\frac{1}{2}$ per cent. iron, 1.4 silica, .026 sulphur, and .014 phosphorus, on delivered cargoes.

Pyrite beds are not valuable for their iron in a crude state, as the sulphur must first be removed. This is usually done in sulphuric acid works, by which the sulphur is utilised. The "cinders" are afterwards available for iron-making or for mineral paints.

Of importance in connection with iron ore deposits are the recent

studies * of the distribution of phosphorus along certain ("isochemic") lines in the beds, by a knowledge of which it is possible to keep more valuable Bessemer ore distinct from less valuable.

Concentration.—The enrichment of iron ores is accomplished by washing, screening, and jigging, to remove clay, sand, and similar impurities; roasting, to eliminate water, sulphur, and carbonic acid; and magnetic concentration.

Dry screening to remove an excess of earthy matter and sand has given fair results in cases where the ore has simply been mixed with these constituents; but it causes a waste of the very fine ore, and of material useful for paint-making, while it leaves both stones and scoria behind, and unless the ore averages 45–47 per cent. metallic iron in the first instance, there is much difficulty in getting it up to the necessary 50.

Another system has been adopted for removing the sand from somewhat adhesive furnace ores, though it causes the loss of ore under 2.75 mm. in size, and any greasy metal. The apparatus consists of a cylinder of boiler plate 12–16 ft. long, having an internal angle iron screw to carry the ore forward as it is scoured. At the end of the barrel a hood is fixed, the circumferential edge of which is composed of perforated steel plate, through which the finer portions of the mass escape, and the large parts, which consist of comparatively pure ore, is lifted by buckets and pitched on to a trough which delivers it into wagons. Water and crude ore are put into the back end of the barrel, which works on friction rollers, the barrel revolving at about 100 ft. per minute. Some 10–12 tons of crude ore per hour can be dressed in this manner, but the waste is great, and is generally composed of that portion of the ore which is richest in metallic iron. Really this hooded cylinder is only fitted for the removal of silica when it is in the form of sand, and of such matters as will be broken up and removed by the water. Stones, scoria and other waste too large to pass through the perforated hood, and which cannot be seen by the pickers in the wagons, will of necessity remain, and where gravel and pebbles are anyway abundant, the sample of dressed ore will be poor.

Aluminous ores can be treated by the wet process, and will give two products, one of which is very rich in metallic iron for blast furnace or annealing (puddling) purposes; the other, which consists of aluminous earth and a proportion of iron ore, being fit for paint-making. Magnetite can also be treated by the wet process, but where ores are already magnetic, or can be made magnetic by roasting, magnetic concentration is a cheaper and better way of handling them. In the Green and Kennedy arrangement, the crude ore is passed into a revolving barrel or cylinder placed at an angle, and having an angle iron screw or worm along its length to propel the ore forward. About 3 ft. of the upper end has perforations $\frac{7}{8}$ in. diam. through which the finer parts escape, and are carried to the revolving sizing screens and water classifiers, which deliver the fine ore to jigs and buddles where it is separated and cleaned. The large ore from the barrel is taken on to a table which swings to and fro with a jerking motion, and while

* D. H. Browne.

on this table it is hand-picked to remove all waste and rubbish as far as possible. The whole of the concentrated ore is then delivered into wagons or hoppers. Clay is sent to a disintegrator. The cost of dealing with the ore is high, and even with a free sandy ore too many hands are needed to secure the greatest economy. However, these plants have raised crude ore from 35 per cent. to 51 per cent. metallic iron with a corresponding loss in silicious insolubles. With an average analysis of 36.90 per cent. metallic iron, 39.03 silicious insolubles, and 7.94 moisture, in the crude ores, an average result in the concentrate when treating over 11,350 tons of crude ore, was 51.11 metallic iron, 20.31 insolubles, and 3.65 moisture. The highest possible result to be had with the ore treated would be 54.10 per cent. metallic iron, 19.24 insolubles, and 1.30 moisture, this being obtained from especially selected hand-picked samples. The loss in bulk of crude ore was practically 43.32 per cent. The average amount of ore treated was 360 tons per week of 48 hours, and the cost of treatment was just over 8*d.* per ton.*

At the Champion mine, Marquette, hand sorting is so effectually performed that 4 grades are obtained, giving respectively 66½ per cent. and upwards, 63½-66½, 60-63½, and 57-60. With wages ruling at 7*s.* a day, and a man's average capability being 7 tons crude, the cost for labour is 1*s.* 7*d.* a ton on the 5 tons selected.

In all systems of concentration, the comminution and sizing of the material to be treated are of primary importance; the degree of fineness to which an ore will be crushed for separation, and the special machinery employed, is affected by (a) the size of the grains or crystals in the crude ore; (b) the foreign matter which is to be eliminated, and its physical condition; (c) the purpose for which the concentrate is to be used; (d) the condition of the ore and the method employed for separation. If the ore to be treated is a magnetite with large crystals, or if the object of separation is to remove silicious material only, a coarser sizing can be employed than in other cases; for practically, complete elimination of silica is not at present essential, and in some ores a system of mechanical sorting or cobbing, treating pieces from fist to walnut size, may be practicable. If, however, the ore is dense, and the crystallisation or granulation fine, or if apatite is to be removed, the reduction of size must be carried further, so as to separate, as far as practicable, each particle of magnetite from the other materials. In dephosphorisation by mechanical means a few hundredths of 1 per cent. phosphorus will determine whether the ore will be in or outside the Bessemer limit, and hence influence its commercial value. The extent to which an ore is to be crushed will also be influenced by the demand for certain sizes or by the objection to others. The condition of the crude ore will materially influence the machinery to be employed, a dry or a thoroughly wet ore being easier to manage than one which is damp or partially saturated with moisture. The problem, therefore, is to be determined specially for each ore to be treated.†

At the mines of the Chateaugay Co., New York, the ore, a magnetite containing 30-40 per cent. iron, mixed with fragments of

* W. J. May. † See Mynard and Kunhardt, in *School Mines Qly.*, ix. 2.

quartz, felspar, hornblende, mica and trap is concentrated in a modified Conkling jig. It is first crushed to 2 in. or less by two large Blake crushers. The material from these crushers passes by a shute lined with screens, having holes $\frac{3}{4}$ in. diam., to a second set of 4 crushers, set so as to close to 1 in. The product from this set of crushers, together with that which passes through the screens in the shute, is then taken by an elevator to the top of the mill, and passed through a revolving screen perforated with $\frac{1}{4}$ -in. holes. The ore which passes through the screen goes to the jig-hoppers; that which passes over goes to a third set of 6 crushers, set to $\frac{1}{4}$ in. These are of the Blake multiple-jaw pattern, having 3 jaws. The product from these third crushers is again screened through a double revolving screen having holes $\frac{1}{4}$ in. diam. That which passes through goes to hoppers; what passes over goes to a fourth set of crushers. These are of the Blake multiple-jaw pattern, having 6 jaws, set so as to close to $\frac{1}{4}$ in. The product from these last crushers is again screened, and the grains which are still too large pass again through the final crushers. All the material which passes through the $\frac{1}{4}$ -in. holes goes to the jigs without further sizing. The ore is crushed dry, and goes to the jigs in that state. The jig has a capacity of treating 5 tons of ore per hour, requiring 135 gal. water per minute, or 1620 gal. per ton treated. One man or boy is sufficient to attend to two jigs, his duty being to see that the jig is properly supplied with material to secure a uniform depth on the screen; that the water is flowing in the proper quantity (a depth of $\frac{1}{4}$ – $\frac{3}{8}$ in. over the collar being sufficient), and that the concentrates are free from gangue. If there is too much gangue in the product, the attendant lets out a hole in the strap from the spring-pole to the lever-beam, to make the shock less violent. The loss in the tailings amounts to 23 per cent., principally in two forms: very fine ore or "slimes," and small particles of ore imbedded in the larger pieces of gangue. The causes of this loss may be summed up as follows:—(a) the fine ore, almost dust, is carried over into the tail-race on the surface of the water; (b) the ore, being friable, is crushed finer than the gangue; hence, without sizing, there is not sufficient difference in the falling-time between the fine ore and the coarse gangue to produce a good separation and fine ore goes over with the gangue into the tailings; (c) the material is not crushed fine enough to free the ore from the gangue.*

The various inventions for separating iron ores by magnetism may be grouped under two general heads:—(a) those which have permanent magnets; (b) those which have a fixed or an alternating current of electricity passed through magnets from a dynamo. These groups may again be classified into such as receive the ore on tables or belts which pass under or over, or which are traversed by magnets; those which consist of magnetic rolls or drums either receiving the ore on their surface or revolving over the ore; and those which by magnetic influence draw the magnetic portion from a falling mass, altering its trajectory so as to separate it from the gangue material. They may be further subdivided into those which treat the ore dry and those which immerse the material for concentration in water.

* F. S. Ruttman.

While in some ores satisfactory and economical concentration is possible, in others the physical structure and the magnetic properties of some of the impurities may interfere so as to reduce or even outweigh the advantages.

Ferrous sands have been concentrated by passing the material between rolls, the adjacent portions of which were in a magnetic field, while the opposite parts were without this field. The iron rolls revolved on journals carried on insulated standards wound with copper wire. By connecting these wires with a battery (latterly with dynamos) the standards became electro-magnetic, of opposite polarity, and the rolls were charged thereby, making a magnetic field between the rolls. The ore being fed on the rolls, which revolved towards each other, was carried around the magnetic portion, adhering until it passed beyond the magnetic influence, while the non-magnetic particles fell between the rolls. The Buchanan machine, Fig. 142,

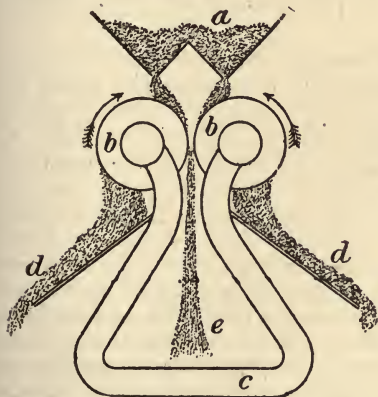

FIG. 142.—MAGNETIC SEPARATOR:
BUCHANAN'S.

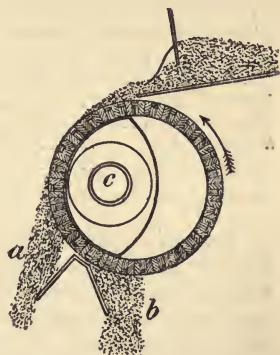

FIG. 143.—MAGNETIC SEPARATOR:
WENSTRÖM'S.

was of this type: *a*, feed hopper; *b*, rolls; *c*, magnet; *d*, concentrates; *e*, tailings. It has been used in America and New Zealand for beach sands; and at the Croton mines, New York, it treated magnetite crushed to 16-mesh, bringing the iron from 31–38 to $62\frac{1}{2}$ – $64\frac{1}{2}$ per cent., and leaving $4\frac{1}{2}$ –13 per cent. in the tailings, as against plunger jigs which lost 14–22 per cent.

The Wenström machine, Fig. 143, has a stationary field magnet and an armature barrel consisting of a number of soft iron bars, separated from one another by a non-magnetic material—in this case strips of wood. The whole is bound together by non-magnetic end rings. The bars are cut away alternately on the inside to make one bar project only towards the north poles of the magnet and the next only to the south poles. This gives each succeeding bar opposite magnetism. On each of the 4 sections of the magnet are wound 15 lb. of copper wire. An Edison dynamo furnishes a current of 10 ampères and 33 volts. The ore is fed to the barrel by means of a hopper, the cylinder turning in the direction of the arrow. The

magnetite adheres to the bars of the barrel and is carried past the first delivery shoot *a*, where the tailings fall, until, on passing beyond the influence of the magnet *c* it drops off at *b*. In Sweden, these separators are used at the iron mines for extracting from old and new dumps of waste material the good ore which has been missed in hand-picking, or was too fine to be picked out in that way. They are also applied to the ore now being mined, which in former times was selected by hand. The larger of the two sizes made treats 6-7 tons of material per hour, and the magnetism is strong enough to support pieces of ore up to 7 lb. in weight, and separate them from the rock. The smaller size treats 2-3 tons per hour of finer material, below $\frac{3}{4}$ lb. in weight of single pieces. The cost of hand-picking at Dannemora, previous to the introduction of this machine, was 1s. 4d. per ton. It now costs 5d. per ton, and 30 per cent. more ore is obtained from the same material; the separated ore averages 59 per cent. iron for the coarse, and 45 per cent. for the fine. Results obtained in America are:—

Mine.	Crude Ore.	Concentrates.	Tailings.
Beach Glenn	53.73	61.53	3.25
Chateaugay	40.99	59.80	1.62
Port Henry	41.6	64.0	15.10
Do.	59.1	61.8	14.3

The principles of the Conkling separator are shown in Fig. 144. The ore is fed from a hopper *a* on a belt and carried along under a series of belts, running at right angles to the first. These cross belts pass between the magnets *b* and the ore lying on the distributing belt, and may be placed at varying distances from the latter. As the ore, reduced to the proper size, passes along on the distributing belt, the

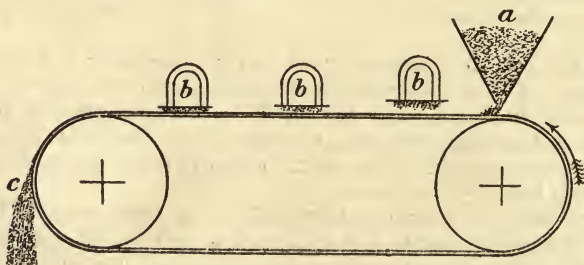

FIG. 144.—MAGNETIC SEPARATOR: CONKLING'S.

magnetic belts, which may be influenced by magnets of different powers, pick up and carry to one side the magnetic particles of the ore, while the non-magnetic portion of the gangue is carried off at *c*. It is used on the waste dump material at the Tilly Foster mine, New York, where the metal is so widely and finely disseminated through the ore that it has been necessary to resort to fine crushing.

This (water being used in the separation) increases the proportion of slimes, which carry off mechanically small particles of mineral. Finally, the lean character of the ore calls for the handling and conveying from the mill of a large bulk of tailings. The process includes crushing the ore by a Blake rock-breaker on the dump; removing it in train-loads to the bins in the mill; passing it under two Ball stamps, provided with screens of $\frac{5}{16}$ -in. mesh; elevating it to the Conkling electrical separating belts; and delivering the concentrates to the cars and the tailings to the settling reservoirs. The following results were obtained in 1890: * —

Ore used per month	3009 tons
Concentrates made	1039 "
1 ton of concentrate from	2·89 "
Cost of labour per ton concentrates	5s.
Total cost per ton concentrates	9s.
Iron in crude ore	27·39 per cent.
Iron in concentrates	49·14 "
Iron in tailings	10·21 "

Unless under exceptional conditions it will not pay to treat waste dump material carrying less than 25 per cent. iron.

The Edison unipolar non-contact separator differs from the forms described in that all parts of the apparatus are fixed. It consists simply of a hopper, a magnet, and a partition to separate the concentrates and tailings into different receptacles. The ore, properly crushed and sized, is placed in hoppers, from which its discharge is controlled by bars closing slots which extend the length of the hopper. These slots are made adjustable to suit the size of the ore. The magnet is a mass of iron 6 feet long by 30 in. wide and 10 in. thick, weighing 3400 lb., and wound with 450 lb. of copper wire, the coil being connected with a dynamo consuming $2\frac{1}{2}$ h.p. and requiring a current of electricity of 16 ampères and an electromotive force of 116·5 volts. The material falling from the hopper passes the face of the magnet, but does not touch it. The distance of the magnet from the vertical plane of the falling material is so chosen that its attraction causes the magnetic to separate from the non-magnetic particles sufficiently to alter their direction. By reason of the force of gravity, this deflection of the trajectory, while sufficient to draw the magnetic particles away from the non-magnetic, does not draw them against the magnet, but should any ore accumulate on the magnet it can be instantly dropped by breaking the current. The exact distance, however, is maintained so that none can stick to the magnet. Owing to the altered trajectory, the magnetic ore falls upon one side of the partition, while the gangue material drops upon the opposite side. An intermediate grade called "mugwump" (mixed concentrates and tailings) may be returned to the hoppers or passed before a second magnet. A series of magnets may be arranged so that the concentrates, mugwumps, or tails are each subjected to repeated magnetic influence. With a hopper 6 ft. wide, and arranging the slot to pass readily ore crushed to pass a 10-mesh screen, each side of the magnet will separate conveniently about 150 tons of material daily, making the capacity of the two-face machine 300 tons a day.

* F. H. McDowell.

Magnetic concentration has attained a high state of efficiency * at the Croton mines, New York, where the presence of 2 per cent. sulphur demands economic roasting. This is achieved in the Davis-Colby furnace, using 3.6 gal. oil fuel per ton of raw ore, at a cost of $1\frac{1}{2}d.$ per gal., labour costing $1\frac{1}{2}d.$ The average roasting temperature is 1250° F. The roasted ore is ground to 12 mesh in Sturtevant mills, entering them at about 350° F., having been cooled by a water bath during conveyance.

Under these conditions the ore is quite friable, and there is no difficulty in grinding 22 tons per hour with the 20-in. mill, and 16 tons in the same time with the 15-in. mill. One set of Sturtevant mill bushings will grind 4000 to 6000 tons of ore, according to the depth of the chill in the bushing, the cost of each set being 3*l.* The screen-blocks for this amount of ore cost 2*l.* This is less than one-half the cost of renewal on any other machine formerly used. At 22 tons per hour the 20-in. mill required 94 h.p. to drive it; but the product is finished. The 15-in. mill requires 70 h.p. The ground ore is elevated from the discharging nozzles of the Sturtevant mills to the several screens, covered with slotted steel plates; slots are $\frac{1}{2}$ by $\frac{1}{2}$ in. in some plates, and $\frac{1}{2}$ by $\frac{3}{8}$ in others. The slotted plates are easily removed, and when the requirements are exacting as to phosphorus, $\frac{1}{4}$ mesh is used on two of five screens. Two sizes of screen plates, three sets coarse and two sets fine, will prepare ore containing .426 phosphorus for a separation having .036, with two passes on the magnetic separators. Ordinarily, the phosphorus in the Croton ore runs from .1 to .3; when higher than .6, three sizes of screen plates should be used, delivering to three receiving bins, and each size should be treated separately on the magnetic separators. Using 18-mesh screens, and with ore prepared for this grade, will produce continuously, with two passes, concentrates showing 70.6 metallic iron, .018 phosphorus, and .22 sulphur. The latest Hoffman separator, using 12-mesh screen, and making two passes, produces concentrates showing 70.93 metallic iron, .017 phosphorus, and .231 sulphur; 18-mesh screens give 71 per cent. concentrates with one pass on this machine, which is illustrated in Fig. 145. In operation the material fed upon the belt is carried along by the latter to the field of the magnet *a*, where the particles, subject to magnetic influence, are attracted toward the nearest pole and at the same time are carried along by the belt past the succession of opposite poles. As the particles pass the successive poles of the magnet they do not follow the line parallel with the belt *b*, but assume positions, under the influence of the magnetic lines of force, which are in the forms of curves from the end of one pole to the end of the nearest pole of opposite polarity. By following these curves and at the same time being moved along by the belt, the material to be separated assumes a rising and falling or wave-like motion, which causes an expulsion of the slightly magnetic or non-magnetic material and that of least specific gravity toward the top of the mass on the belt, and results finally in a stratification of the substance to be separated, the most magnetic and heaviest portions being brought closest to the belt, and the lighter and non-magnetic or slightly

* W. H. Hoffman.

magnetic particles farthest from the belt. The particles forming the upper stratum will, under the horizontal motion imparted to them by the belt, leave the magnetic stratum in a trajectory as the belt begins to follow around the periphery of the drum *c*, and will be assisted in separating from the magnetic stratum by the lifting and wedging action of the upward current of air following along between the periphery of the drum and the upper portion of the partition *d*. The magnetic stratum follows the path of the belt around the periphery of the drum, by reason of the attraction to the magnet *e*, and its wave-like motion is continued, constantly gathering the more highly magnetic particles closer to the poles, and consequently to the belt. During its passage around the periphery of the drum, a scouring action is kept up upon the surface of the mass by the opposing current of

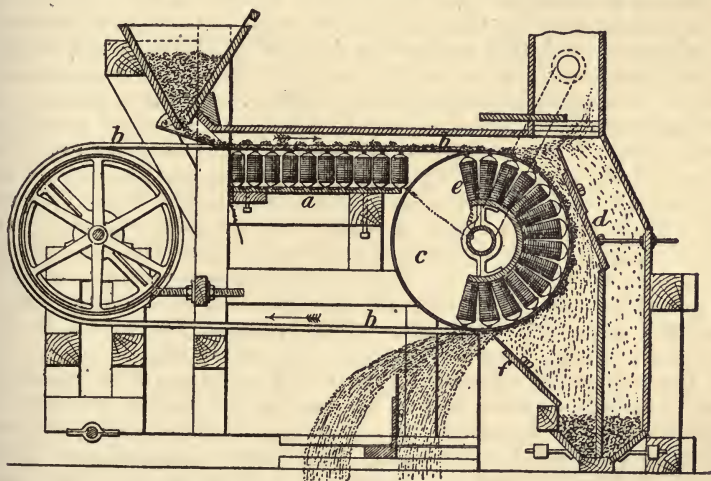

FIG. 145.—MAGNETIC SEPARATOR: HOFFMAN'S.

air and by the agitation of the mass, which effectually brings all the particles into contact with the air current. After passing the partition *f*, the less magnetic material continues first to fall from the belt, while the more magnetic is still carried forward, and finally leaves the belt after the latter has carried it beyond the holding force of the last pole of the magnet. The power required is $\frac{3}{4}$ h.p. mechanically and 2 h.p. electrically.

At the Friedrichseger (Oberlahnstein) argentiferous lead mine, where much mixed blende and spathic iron ore are produced, magnetic separation has long been successfully applied.* The initial step is roasting, to render the ore magnetic, by converting the ferrous carbonate into magnetic oxide. The larger lumps are roasted in kilns, charged alternately with coke screenings in the usual way. Owing to the large amount of sulphur in the ore, the consumption of fuel is very small, being only 1 cwt. per 8 tons daily put through the kiln,

* O. Heberle, Berg. u. Hüt. Zeit., xliii, 509.

which is served by two men. The cost of kiln roasting is about $9\frac{1}{2}d.$ per ton. The roasted ore is reduced by breakers and rolls to particles of 5 mm. maximum size, which are fed mechanically to the magnetic machines. Fine-grained products are calcined in long flat-bedded reverberatory furnaces for about $1\frac{1}{2}$ hour. The cost both for fuel and labour is much higher than in the kilns, and is computed at $2s. 6d.$ per ton. The roasted ore is spread out on a floor to cool, separated from sintered lumps, and passed through a sizing drum to remove particles above 4 mm., which are returned to the crusher, while the finer siftings pass to the magnetic machines. Thus rough stuff carrying 12–15 per cent. zinc and 20–22 iron is made to afford zinc ore of 33 per cent.; and iron ore of 36–38 per cent. iron and 10 per cent. manganese.

In order to prepare the "clay-band" ironstone, which is the ore most largely raised in this country, for being smelted, it is necessary to calcine it; and this calcination is usually, although not always, done in the locality of the mine, even when the ore has not to be used there. The reason of this is that the bulk of material is lessened and its transportation is thus facilitated. Clay-band ironstone consists in great part of iron carbonate, the other largest constituents being silica and alumina, but it also contains small quantities of lime and magnesia, with a little phosphoric acid and sulphur. What is termed the "black band" is black in colour from containing coaly matter mixed up in it. The object of the calcination is to drive off carbonic acid, to raise the iron protoxide with which it was united to the state of peroxide, and by altering the physical condition of the ore, to render it more easy of reduction in the furnace. Two modes of calcination are practised, namely, in "clamps" and in kilns.

In clamp calcining ordinary grey clay ironstone, it is customary first to spread a layer of coal in lumps upon the ground, and on this to raise the heap of ironstone, interspersing coal occasionally, and then to cover the surface of the heap with slack. In calcining "black band" it is not necessary to use any coal, there being sufficient carbonaceous or coaly matter in the stone itself, and often also adhering to the surface of the lumps, to furnish the necessary combustible material. The heaps thus formed are built about 6–8 ft. high, sometimes much higher; they are made of variable extent, up to so large as to cover $\frac{1}{2}$ acre of land, and the calcined stone may be removed from one end while the heap is being freshly made at the other. The heap is ignited, and burns through in a smouldering way, emitting a good deal of smoke, a little flame breaking through the surface also in places. An ordinary sized clamp takes about 3 weeks to become thoroughly calcined, and at the end of this time its bulk is found to be reduced to about half.

For calcining in kilns an ordinary open kiln, like a common egg-shaped lime-kiln, is sometimes used; but for the most part iron cup-shaped kilns, made of iron plates lined with firebrick, are used. They are about 24 ft. high, and are so arranged that while the ore and fuel can be fed in continuously above, the calcined ore is discharged at the bottom either upon a raised platform or directly into the wagons that are to carry it away. The kiln being once ignited, all that is necessary is from time to time to throw in a layer of coal on the top

of a charge of stone; each calcining kiln is constructed to hold about 250 tons of stone, and the quantity of coal used is about 7 per cent. of the weight of stone calcined.

The calcining of ironstone in clamps is often a very great nuisance, from the large quantities of sulphurous smoke emitted during burning. Of course smoke of the same suffocating character issues from the open tops of calcining kilns, but it is very much less in amount, and is delivered into the atmosphere at a higher level; not more than one-tenth of the quantity of coal is used that is used in clamp calcining. Whenever the nature of the stone permits of kiln calcining, this method ought to be pursued; but there is a limit to the use of the kiln. It is applicable to the ordinary grey ironstone with which coal has to be used for calcination, since, if the quantity of coal be not excessive, that is to say, if it be not used in greater quantity than is necessary to effect the calcination, the calcined stone falls out from the kiln in separate pieces; but it is not applicable to the black-band ironstone or the "red shag" of North Staffordshire, inasmuch as these stones become partially fused during calcination, and run together into large blocks and masses which require a pick-axe to break them down, and would not run out from the kiln.

For desulphurising iron ores, heap roasting, after the manner described under copper, was first adopted, to be followed by several varieties of kiln. The rules* which govern the roasting of pyritic ores are mainly that: (a) heat alone, without access of air, can remove, at best, only one-half the sulphur present; (b) atmospheric oxygen is absolutely necessary; (c) even at a low heat, ore is properly desulphurised if air can gain access freely to the FeS_2 in it; (d) iron sulphate can be decomposed by heat equally well with or without air; (e) if the residuum of sulphur in roasted ores is to consist, so far as possible, of sulphates, the roasting must be done under free access of air; (f) fusion or sintering of ore is likely to prevent any further desulphurisation; (g) sintering does not allow much of the remaining sulphur to be in the form of sulphate; (h) fusion should never occur in roasting except after continued heating in air at a lower temperature; (i) ores cannot be properly desulphurised in the upper part of the blast furnace; (k) an efficient roaster must allow easy control of heat, abundant access of air to the hot ore, and rapid removal of the products of combustion.

The Davis-Colby gas-fired kiln is perhaps the most popular. It consists in general, Fig. 146, of two concentric shafts *a* of brick-work, enclosing between them an annular space *b* 18–24 in. in section, to contain the ore. The inner shaft is continued above the top of the roaster to form the draft stack, or it may be covered, the products of combustion being carried downward and out through the flue *c* to a separate chimney, allowing utilisation of the fumes. A cone-covered top *d* permits of more convenient charging, as ore dropped from carhoppers upon it gets an even distribution. In the outer wall are shutles *e*, fire-arches *f*, gas flues *g*, and poking holes and air flues *h*. Openings *i* in the inner wall admit the fumes and products of combustion to the draft-stack or to the flue *c*, and are placed higher or lower, according to the necessities of the ore under treatment. With

* S. G. Valentine.

dense hard magnetites, the height of the kiln is increased for the purpose of giving the ore a longer exposure to heat; and the fire-arches are put at a greater vertical distance apart, so that the ore may

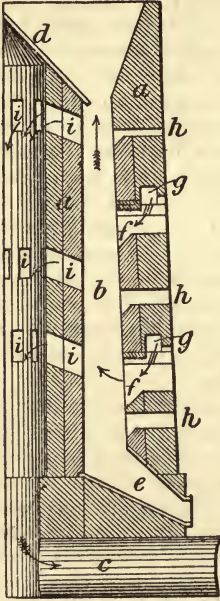

FIG. 146.—DESULPHURISING KILN.

partially cool after its first heating, and be cracked or fissured, thereby exposing the remaining sulphur more thoroughly to the action at the second fire-arches. Generally the gas used is surplus gas from the blast furnace but producer gas is much preferable. When properly charged, as much as 30–40 per cent. of fine ore can be used; but fine and coarse should be thoroughly mixed in filling, as a solid mass of fine ore before a fire-arch chokes off the gas and prevents the heat and air from penetrating the ore. Their capacity is 75–100 tons of a reasonably porous ore in 24 hours. Of course, a hard dense ore requires a longer exposure and the output of such ore is somewhat less. The roaster at the Katahdin furnace, 20 ft. high and 15 ft. diam., roasts about 40 tons a day; those at the Colebrook and Cornwall furnaces, 75–90. Clinkers cause little difficulty in working; they seldom extend beyond the bounds of one or two fire-arches, and as the annular space is narrow, and widens downward, they are readily reached and broken up while hot; with proper attention, there is no reason why they should form at all. The upper fire-arches should generally be kept at a somewhat lower temperature than the second set, gradually

raising the heat, so that if clinkering does take place it is only after long heating at a lower temperature, and after atmospheric oxygen has had full play on the reasonably hot ore. The cost per ton of roasting varies with circumstances, and is greatly affected by the method of breaking and filling the ore, and by the use of furnace-, or producer-gas. New kilns with a capacity of 75–100 tons a day are built by contract, for 600*l.*, including royalty; but the system can be adapted to any ordinary Gjers kiln, the expense varying with the size and shape of the original roaster.

Smelting.—The impure metal in the shape of ores is brought back to a relatively pure state by the process of smelting in furnaces supplied with fuel and continuous blasts of heated air. The furnaces are fed with ore and coal, in the proportion of about 3 parts fuel to 1 of ore, and with a certain proportion of limestone as a purifier or flux for the removal of the earthy matter of the ore. The metal, being the heaviest, drains to the bottom when fused, and is run off into moulds, when it becomes “pig-iron,” and is ready for use in foundries but it has taken up too much carbon from the fuel to be available at once for the manufacture of “wrought” iron, and must, therefore, be subjected to various further purifying processes. Until coal came into general use, these further processes were not separated from the

smelting, and "malleable" iron was produced direct from the ore with charcoal fuel by continuous working. The iron was not actually rendered molten, but was separated out and made to coalesce into a solid lump whilst in a pasty condition, and was taken out sufficiently free from carbon to be at once malleable—the Catalan process, followed by many native races all over the world. The furnace may be described as a rectangular cavity or hearth, of various dimensions, within a building. Three sides were formed mainly of iron and clay, and the fourth of stones luted with clay, while the bottom consisted of a flat or slightly hollowed refractory stone, such as granite. On one side the tuyer passes through a small arched opening about 18–19 in. from the bottom. There was no chimney, but a hole was left in the roof. A Catalan forge employed 10 men in France. The ore is first crushed under a hammer and sifted. The furnace is heated with charcoal, which is packed almost as high as the bottom of the tuyer, when alternate layers of ore siftings and charcoal are piled up so as to form a ridge, one slope of which is covered with moistened charcoal breeze, beaten well down with a spade. The blast is turned on, and the level is kept up by additions of ore and charcoal. At the end of about 6 hours the iron has coalesced into a solid lump at the bottom, which is lifted over the edge of the furnace by levers, and is ready for hammering.

The blast furnace is only a magnified Catalan, increased in size to take larger charges, with forced draft to burn inferior fuel, and incapable of producing a malleable iron owing to the percentage of carbon combined with the metal. It has gone through many changes, and will probably continue to be modified. In its earlier forms it was capable of making either malleable or cast iron at will. The usual dimensions in Britain for furnaces working on Cumberland, Cleveland, Scotch, or Spanish ores are 70–75 ft. high and 18–20 ft. diam. at the boshes, using good coke, anthracite, or splint coal. American practice offers important contrasts.*

The conversion of pig iron into malleable iron is effected by oxidation in a "puddling" furnace, the oxygen being derived from iron peroxide provided in the "bull-dog" or "fettling" used for lining the furnace. To produce steel, the decarburising is not allowed to proceed so far. Malleable iron is converted into steel by heating with charcoal in a "cementation" furnace. The introduction of "regenerative" heating made it possible to produce steel from pig iron in the "open hearth" or reverberatory furnace, either using pig-iron and ore (Siemens process) or pig and scrap iron (Siemens-Martin); and from pig-iron alone in a "converter" (Bessemer); while the phosphorus is eliminated by using a basic instead of a silicious lining in the converter (Thomas-Gilchrist), and a valuable fertilising material containing 25 per cent. phosphoric acid is obtained as a bye-product. Owing to the multiplicity of forms which these several furnaces have taken, and the number of modifications of working introduced in consequence of the variety of ores, fuels, and fluxes dealt with, no one example can be considered representative or really instructive, and available space quite prohibits a proper description of the various examples necessary to do justice to the

* W. Colquhoun, at S. Wales Inst. Min. Engs., Nov. 1891.

subject. It is therefore deemed better to refer the reader at once to the recognised works on the metallurgy of iron. Moreover, a small installation of iron smelting plant is an industrial impossibility, and a large one is only to be undertaken with abundant capital and the services of experts, so that a synopsis such as could be given here would fulfil no useful purpose.

Cost.—An important element in the cost of producing iron is the transportation of the raw materials, and in this respect the United Kingdom is well situated. Several of our iron-producing districts are also seats of large coal industries, and the works are situated on the coalfield itself. In the district of Cleveland, the coal is only separated from the ironstone by about 30 miles; whilst Lancashire and Cumberland possess deposits of ore and limestone in the vicinity of their furnaces, the coke for which is, however, obtained from Durham, about 80 miles away. These facilities, although not entirely absent in the United States, are not of so frequent occurrence. The deposit at Cornwall, in Pennsylvania, is within 40 miles of anthracite coal, and accessible to coke at rates which leave nothing to be desired. When we pass to the south, we find in Alabama that the coal and ore are usually within 25 miles of each other, and sometimes to be found lying one over the other upon the same property. In connection with the Lake Superior ore mines, however, a large proportion of the produce of which is transported to Pittsburgh, the ore is carried for 790 miles, and this appears to be a feature which characterises the northern states in contradistinction to the southern.

The geological formations of the seams containing the ore is, in addition to geographical situation, a controlling factor in the supply of iron ore, and one which influences the miner more directly than does the former. In the United Kingdom the general conditions of iron-mining are concomitant with a large output, although there are some districts—as South Staffordshire and some parts of Cumberland and Lancashire—where, through natural causes, the workings are restricted. In Lincolnshire the ore is very accessible, as it also is in Northamptonshire and in places in North Staffordshire, deposits occurring in the Carboniferous formations. In Scotland, the miner on an average cuts about $1\frac{1}{2}$ tons, whilst in South Staffordshire such a great quantity of shale has to be excavated that the miner only attains about $1\frac{1}{4}$ tons a day. Judging from the statistics which are available in respect to the United States on this subject, the largest individual output noticed is that of Alabama, where the ore is of a soft nature, and where an individual production was made of 509·68 tons in 1889. The lowest outputs per employé registered were in Ohio (157·95 tons), Virginia and West Virginia (209·87 tons). These statistics, taken in connection with other information, prove that the ore in the above-mentioned states is difficult of attainment. It is noticeable, too, that in Pennsylvania over 1000 employés are at work above the number engaged in Alabama, although in the latter case the production exceeds that of the former by over 10,000 tons. It is notable that in districts where the highest-valued ore is won, the average profits per ton have also been largest, although the average output per man has been amongst the smallest. These are the districts also in which the highest remuneration has obtained, but where

the outputs of ore have been of small extent. In these states, therefore, the ores have been easily worked, and mining machinery has probably extensively been in use. Cleveland, Scotland, Cumberland and Lancashire are the districts of the United Kingdom where the high-value ores are found, and here, it would seem, the miners are the best paid. In all these districts, too, unlike those of the United States, the outputs are the largest in the kingdom. The highest-valued ores, and the production thereof, are given under:—

United Kingdom.

	Production.	Value of Ore
	Tons.	per ton.
		s. d.
Cumberland	1,594,461	11 11 $\frac{3}{4}$
Lancashire	1,021,990	8 8 $\frac{3}{4}$
Yorkshire (N.)	5,728,314	10 9
Scotland	1,061,734	9 3 $\frac{1}{2}$

United States.

Idaho and Montana	24,072	27 6
Colorado	109,136	18 7
New Jersey	415,510	13 5
New York	1,247,537	12 0

The value of the red hematite ore worked in Michigan is pretty well on a par with that of our own derived from Cumberland. In the former, the value is 11s. 3d. per ton, whilst in the latter it is priced at 11s. 11 $\frac{3}{4}$ d. per ton. In both places the ore is generally worked without very much difficulty.

The average cost of grey forge iron in Great Britain is given at 32s. a ton, as compared with 36s. on the Continent, 43s. in the Southern States, and 56s. in the Northern States, the chief difference between the Northern and Southern States lying in the cost of ore. The average cost of Bessemer iron is given as 41s. in Great Britain, 47s. on the Continent, and 61s. in the Northern States, none being produced in the South; and the figures for spiegeleisen are 44s. in Great Britain and 60s. on the Continent. These figures refer to the period 1887-90, and are given only for comparison between the great producing centres.

The detailed cost of producing a ton of pig-iron in a Sequachee Valley furnace in 1888, using its own local ore and coal and buying soft ore, are thus given:*

Hard ore at 30 per cent., 2750 lb. at 3s.	s. d.
		4 0
Soft ore at 50 per cent., 2325 lb. at 9s.	10 6
Add 10 per cent. for waste, moisture, &c.	1 6
Ore per ton (2000 lb.) iron.		16 0
Coke, 2750 lb. at 8s., plus waste	12 0
Labour, on a daily make of 85 tons	7 0
Stores, &c.	1 0
Freight on coke	1 0
Depreciation	1 0
Interest	0 9
		£1 18 9

Or, on the English ton £2 3 6

* W. M. Bowron.

The annexed figures * refer to Birmingham, Alabama, where conditions are exceptionally favourable.

(1) Furnace, 75 × 17 ft.; brick stoves; 8 tuyers 6 in. each, blowing 21,000 cub. ft. air per minute; making 160 tons a day, 80 per cent. foundry; burden:—

	lb.
Coke (86·27 carbon, 11·22 ash, 2·51 volatile matter, 1·55 sulphur)	9600
Hard red ore (39·47 iron, 32 lime carbonate, 8·17 silica, 3·47 alumina)	8600
Soft ore (51·57 iron, 1·02 lime carbonate, 16·62 silica, 5·05 alumina)	5000
Limonite (51 iron, 8 silica, 4 alumina)	2500
Silicious red ore (34·7 iron, 1·79 lime carbonate, 42·84 silica, 4·03 alumina)	1200
Limestone (86·26 lime carbonate, 7·50 magnesia carbonate, 3·78 silica, ·75 alumina)	2070
Dolomite (55 lime carbonate, 42·9 magnesia carbonate, 1 silica, 1 alumina)	2070

(2) Furnace, 75 × 18 ft.; brick stoves; 8 tuyers 7 in. each; 12 ft. hearth; 22,000 cub. ft. air a minute; averaging 193 tons a day of high silicon iron, over 80 per cent. foundry; burden:—

	lb.
Coke (89·15 carbon, 10·33 ash, 1·27 sulphur, ·52 volatile matter) ..	5600
Hard red ore (37 iron, 28 lime carbonate, 10 silica, 2 alumina) ..	6800
Soft ore, as in (1)	2650
Limestone, as in (1)	620

Slag: 42 per cent. lime, 38 silica, 14 alumina.

(3) Furnace, 75 × 20 ft.; brick stoves; tuyers and blast as in (2); 11 ft. hearth; averaging 200 tons a day, 85 per cent. foundry; burden:—

	lb.
Coke, as in (2)	5600
Hard ore, as in (2)	6800
Soft ore, as in (1)	2740
Limonite, as in (1)	2740
Limestone, as in (1)	1320

Slag: 45 per cent. lime, 36 silica, 14 alumina.

The cost of the coke at the different furnaces varies from 7s. to 9s. a ton; limestone, 3s. 9d.; hard ore, crushed, f. o. b. mines, 2s. 6d.; freight, 7d.—1s.; soft ore, f. o. b. mines, 1s. 6d.; freight, 9d.; Irondale soft ore (51 per cent. iron) at furnace, 4s. 6d.; limonite (50 per cent. iron) at furnace, 4s. 9d. On a month's production of 12,000 tons from two furnaces, the figures of cost of 1 ton (2000 lb.) pig-iron are:—Coke, 9s. 3d.; ores, 8s. 7d.; limestone, 8d.; labour, 3s. 4d.; incidentals, 3s. 11d.: total, 25s. 9d.

Production.—The approximate yearly production of pig-iron and steel in the principal countries is:—

* E. C. Pechin, En. and Min. Jl., July 14, 1894.

	Pig Iron.	Steel.
	tons.	tons.
United Kingdom	6,000,000-8,000,000	3,000,000
Germany	3,000,000-5,000,000	2,000,000
France	2,000,000	600,000-800,000
Belgium	600,000-800,000	200,000-250,000
Austro-Hungary	750,000-950,000	400,000-500,000
Sweden	400,000-500,000	100,000-200,000
Russia	600,000-900,000	200,000-300,000
United States	7,000,000-9,000,000	3,000,000-4,500,000
Other countries	400,000-600,000	150,000-250,000
Total	24,000,000-28,000,000	10,000,000-12,000,000

Bye-products.—Taking the weight of the slag produced at $1\frac{1}{2}$ tons per ton of pig iron, we may assume that the vast heaps of this comparatively refuse bye-product are increasing in this country alone at the rate of upwards of 18 million tons annually. Not only do these heaps cover many thousands of acres of land, rendering the same barren and unprofitable, but in some cases, where sufficient vacant ground cannot be obtained near the works, manufacturers are compelled to rid themselves of the slag by conveying it away to considerable distances, or by casting it into the sea, at a very heavy annual expenditure. Slags in immense quantities are produced also in the new processes of steel manufacture. Hence the utilisation of slag* is an important question. Large quantities are used for making paving setts and as road metal, and, in a very finely powdered condition, for cement manufacture. Puddle slag and heating cinder have been recently utilised at Boonton, New Jersey, for paint. The process involves crushing the slag to an impalpable powder with a Cyclone pulveriser, and then settling it with some sorting action in air chambers. Used directly and alone, it affords a dark olive-green paint, which also makes an excellent body for other and brighter shades. In making reds, the coarser crushed material from the first treatment is mixed with sulphuric acid and allowed to sweat, as it is called, for 4 days. This changes the slag from silicate to sulphate of iron. It is then calcined to afford the oxide, and reground. The mill is making 5-6 tons of paint stock daily. Basic slag contains roughly 17 per cent. phosphoric acid and 60 per cent. lime. While not a suitable fertiliser for all soils (calcareous ones for instance), yet for sour, peaty, and clay soils it is of great value, as is shown by the fact that all the 600,000 tons a year made in England are sold at 20-30s. a ton at the works. It is interesting to note that the phosphoric acid is combined with the lime in a different way from what has been found in nature, and instead of being a tri-basic phosphate it is a tetra-phosphate, readily soluble in water, and thus only requires very fine grinding in order to be utilised by plants. At first the attempt was made to treat it by various chemical methods, the same as super-phosphate, but it was not successful until applied simply in the ground state. Prof.

* G. Redgrave, "Utilisation of Slag," Soc. Arts JI., Jan. 31, 1890.

Scheibler's ingenious process for extracting the phosphoric acid is therefore but little used. He first calcines the slag in an oxidising flame, then pulverises and sifts it. The powder is dissolved in hydrochloric acid, and the solution is saturated with milk of lime. In this way a substance is produced which is said to contain 35-37 per cent. phosphoric acid, under the form of bi-basic phosphate of lime. A second calcination is reported to afford a product containing as much as 45 per cent.

LEAD.

WHILE the distribution of lead ores is wide, both geographically and geologically, it has been asserted * that the period of their formation has had considerable influence upon the amount of silver associated with them. The principal ores and their content of lead when pure are:—

	Lead. Per cent.
Galena, sulphide, PbS	86 $\frac{1}{2}$
Cerussite, carbonate, $PbCO_3$	77 $\frac{1}{2}$
Anglesite, sulphate, $PbSO_4$	67 $\frac{1}{2}$
Pyromorphite, phosphate and chloride, $Pb_3P_2O_8, PbCl_2$..	75

In addition, various mixtures of these and limonite (iron oxide) are worked.

The chief centres of lead production are Cumberland, Cornwall, and Derbyshire in England; Puy de Dôme and Bretagne in France; Saxon Erzgebirge, Silesia, Harz and parts of Rhenish Prussia in Germany; Carinthia in Austria; Linares and Cartagena in Spain; Siberia, Ural, and the Caucasus; the Rocky Mountains and Upper Mississippi Valley; and recently, Broken Hill, Australia.

The production in the United Kingdom shows a steady decline from about 100,000 tons of ore worth 10*l.* a ton in 1870 to only 45,000 tons value 8*l.* 10*s.* a ton in 1890.

The plumbiferous region † of Puy de Dôme is, roughly speaking, an undulating plateau of crystalline schists, ranging from chloritic schist to gneiss. The age of the lode formation is placed by Lodin between the Miocene and Pliocene. Eruptive rocks are present in great variety, two kinds especially:—(a) acidic, usually occurring as dykes, and of age anterior to the lode formation; (b) basic, generally as lava flows, of age posterior to the lodes, whose croppings they often cover. The acidic type is represented for the most part by granulite or pegmatite, sometimes rendered porphyritic by the presence of large crystals of felspar. The dykes of this rock are very numerous. Their strike is usually between N.N.E. and N.N.W., and their thickness varies from a few inches to more than 60 ft. Their general course coincides with that of the mineral belt. In addition to these there are others of porphyrite, far less considerable in number, and of an age later than the lode formation. The connection between the lodes and the granulite dykes is most marked. The veins of ore consist of a barytic and quartzose filling, containing blende and galena, occurring in streaks of varying regularity in the midst of the dyke rock, which is sometimes brecciated and crushed, sometimes solid and unbroken.

* F. C. von Petersdorff.

† T. A. Rickard, "The Lodes of Pontgibaud," *En. and Min. Jl.*

When the dyke diminishes in size, the streak of ore decreases in width; when the lode fracture ceases to be accompanied by dyke rock, and penetrates the enclosing gneiss or schist, then the vein-filling narrows and becomes barren of ore.

Numerous veins of argentiferous galena occur in Devonian rocks in the vicinity of Brilon, Müsen, and Siegen, in Rhenish Westphalia. In the sandstone of Bleiberg, in the Eifel district of Düren, are large deposits of lead in the form of nodules or *Knotten*, and the rock to which they belong is known as *Knotten-sandstein*. The nodules consist chiefly of galena, and more rarely of cerussite. They are spherical concretions, usually smaller than a pea, and at Bleiberg constitute 4 to 10 per cent. of the whole of the bed. The total production of lead ore in these provinces in 1890 was 82,400 tons; and of this total the district of Commern-Gemünd (where the Meinerzhagener Bleiberg mine Mechernich is the chief producer) yielded 43,440 tons. In the Harz, lead ores occur in the Devonian and Lower Carboniferous rocks of Clausthal and Zellerfeld; in the Devonian rocks of Rammelsberg; and in the Silurian rocks of St. Andreasberg and Haizgerode. The Rammelsberg deposits consist of lenticular masses of ore chiefly composed of iron pyrites, copper pyrites, and galena. The production of concentrated ore in the Harz for 1890 was: Clausthal, 7233 tons; Lautenthal, 1683; Grund, 4635; Andreasberg, 239; Rammelsberg, 34,818. In the Erzgebirge the lodes occur in crystalline schists and in igneous rocks. The chief district is Freiberg, where there are about 90 lodes, chiefly in gneiss, both red and grey, which toward the west is overlain by mica schists and clay-slates. The schistose strata are traversed by eruptive rocks, some of which have become converted into serpentine. The output of ore in the Freiberg district for 1891 was 31,502 tons. The deposits of Upper Silesia containing zinc and lead are enclosed in beds of the lower "Muschelkalk." Galena occurs in the form of grains or in seamlike deposits in dolomite; the thickness of the beds is not more than 12 ft. The produce for 1891 was 27,616 tons. The production of lead ore in Prussia in 1891 amounted to 140,112 metric tons.

The lead mines of the Spanish provinces of Murcia and Almeria* exist in various geological formations. The north group, that of Mazarron, occurs in typical trachytes, which are traversed by a network of powerful lodes of galena, often accompanied by blende and pyrites; the Sierra of the Lomo de Bas has numerous small veins in clay slates, probably of Devonian age; the groups of the Baladre and Charcon, and Jarabia, contain galena, blende, pyrites, and some spathic iron; in the Sierra Almagrera the mines are very numerous, and many have proved highly remunerative from their considerable percentage in silver, but they are worked under great difficulties, on account of the intense heat underground, and from the large influx of water in the deeper workings. The Sierra Almagrera is formed by slates and schists, more or less metamorphic and non-fossiliferous being probably Silurian. At the foot of this mountain mass, in the plain below, at the Herrerias, is found an immense deposit of ironstone, a portion of which is manganiferous, and furnishes an excellent

* J. Deby, "Argentiferous Lead Mines of Spain," *Industries*.

ore of iron; while another portion contains sand, gravel, and fragments of barytes, and also silver, both in the native state and as a chloride. Further south, the Bedar and the Reforma mines are worked in a remarkable formation, consisting of a conglomerate, or rather breccia, constituted by fragments of limestone united by coatings and strings of galena, and which often attains a thickness of 150 ft. This rests upon Tertiary dolomitic limestone, which in turn lies unconformably on mica schist. In some places the galena is replaced by the blue and green carbonates of copper. The production of the conglomerate is no doubt due to the intrusion in the neighbourhood of an immense body of basaltic rocks. The approximate total production of lead in Spain during 1892 may be fixed at 160,000 tons, of which one-third only is argentiferous.

Galena is common in many parts of India, but Cuddapah and Karnaul are probably richest in the ore. In Cuddapah, at the village of Judgumrazpilly, close to the Nallamallay Hills, old lead workings are conspicuous. A sample of ore from these regions yielded 78 per cent. lead and 22 oz. silver to the ton of lead. Both these and the Karnaul mines would probably repay scientific exploitation handsomely. Three analyses of ore from the latter yielded, respectively, 374 oz., 175 oz., and 165 oz. silver to the ton, which would render them well worth working. In Bengal galena has been found in the Sonthal Pergunnahs and also in Bhagalpore. An analysis of ore found in the latter district showed 78 per cent. lead and 103 oz. silver to the ton.

In the United States the chief sources (80–85 per cent.) of lead in late years have been argentiferous ores, and considerable from zinc ores, but a notable exception is found in S.E. Missouri,* where galena accompanied by nickeliferous pyrite is disseminated through magnesian limestone of Cambrian age. The Mines are at Bonne Terre, Mine la Motte, and Doe Run. The strata lie almost horizontal, and are known to carry lead through over 200 ft. in thickness. The productive places fade out into barren rock, and appear to be local enrichments of the limestone, of which the galena forms an integral part. At Bonne Terre, they are of enormous size, one working running 3000 ft., and being 100–200 ft. broad and 25–60 ft. high. No zinc, however, occurs with the lead, and the silver contents are very small, being about 4 oz. to the ton of lead. At Mine la Motte some copper is found, and considerable nickel and cobalt. Pyrite accompanies the galena, and carries the nickel and cobalt, which is obtained as a bye-product in the lead smelting. All the ore bodies are crossed by small faults, adjoining which the rock is invariably barren. Knobs of Archæan granite, containing diabase dykes, crop out near the mines, but never penetrate the limestone, and were evidently intruded before it was laid down. The ore must have been deposited with the limestone, or have been introduced since the latter was formed, and by the percolation of ore-bearing solutions through the rock, with no marked fissure vein development. It is a curious fact that as the ore bodies are followed up to the faults they invariably become lean or run out. Their place of formation has apparently

* J. F. Kemp, 'Ore Deposits,' p. 158.

some connection with low folds at right angles to the faults. The ore bodies favour the anticlinal bends. This whole region of Cambrian and Lower Silurian rocks, over nearly 3000 sq. miles, contains lead. The ore affords an average of about 8 per cent. galena. Except at Mine la Motte, lead was also once obtained from small gash veins, but the workings were never commensurate with the present mines of disseminated ore.

The gash veins and horizontal cavities ("flats") of Wisconsin* are limited to the Galena and Trenton limestones, and contain galena, blende, pyrite (or marcasite), calcite, barite, and residual clay. The Galena limestone is a dolomite, 250 ft. thick; under it lies the Trenton, 40-100 ft. thick, in two portions—an upper, blue, non-magnesian, and a lower, buff, magnesian. The ore beds specially favour the shallow synclinal depressions in the E.-W. folds, and occur in crevices, which are alternately barren and productive. Lead ores predominate in the Upper Galena; zinc ores in the Lower Galena and the Trenton. The upper deposits are mostly in vertical gashes; the lower in "flats," which dip down at the ends ("pitches") and often connect with another flat. The ores were probably deposited with the limestones.

The Missouri deposits occur in the Keokuk or Archimedes limestone of the Lower Carboniferous, in "runs," 100-300 ft. long, 10-50 ft. wide, and 5-50 ft. high; and even larger. As a general thing the ore is in interstices of brecciated chert, but it is also in limestone and dolomite, and associated with a silicified form of the insoluble residue left by the solution of the limestone, which Dr. Jenney calls "cherokite." All the ores require concentration. Galena usually occurs near the surface, while blende is more abundant in depth. Cadmium is at times present in the blende in notable amount.

In Wythe county, Virginia, are similar strata in limestone or dolomite, impregnated with lead and zinc.

Of by far the greatest importance are the Leadville (Colorado) bodies of oxidised silver-lead ores, passing in depth into sulphides, in much faulted Carboniferous dolomitic limestone, associated with dykes and sheets of porphyry. The ores are chiefly earthy lead carbonate, with silver chloride, in a clayey or silicious mass of hydrated oxides of iron and manganese. Sometimes silver chloride occurs without lead. Some zinc is also found, and many rare minerals. Where the ore is in a hard, silicious, limonite gangue, it is called "hard" carbonate; but where it is sandy and incoherent, it forms "soft" carbonate, or "sand" carbonate. All the mines produce small amounts of gold, occasionally of more importance than the silver. A few ore bodies are found at other horizons than the Carboniferous. They also run in instances as much as 100 ft. from the contact, and may likewise be found in the porphyry, doubtless replacing included limestone. According to S. F. Emmons, the ore bodies were deposited from aqueous solutions, and originally as sulphides, at a great depth below the rock-surface (probably 10,000 ft.); by subsequent dynamic movements and by erosion, they have been brought to their present position near the surface; through secondary alteration

* T. C. Chamberlain, Wisconsin Geol. Survey, iv. 367.

by surface-waters, they have been changed to oxides, carbonates and chlorides; that the process of deposition was a metasomatic interchange between the minerals brought in in solution and the limestone—that is, they were not deposited in already existing open cavities, but gradually replaced the limestone, from the channels through which they reached it outwards; the solutions or ore-currents reached the present *locus* of the deposits directly from above, and not from below; and whatever may have been the ultimate source from which the mineral components of the deposits came, the observed facts point to the neighbouring eruptive rocks as the immediate source.

On Aspen Mountain* the ore bodies favour the contact between the blue limestone and the brown dolomite. The former is very pure, while the latter contains 20–28 per cent. magnesium carbonate. The ore replaces and impregnates the blue limestone, often with very little change in its appearance, but it fills the numerous cracks in the more broken dolomite, coating larger and smaller blocks. The ore occurs also in minor fissures. On Smuggler Mountain the ore especially follows the fissure veins.

At Red Mountain, Ouray county, oxidised silver-lead ores, passing into sulphides below, are met with in large and small cavities in knobs of silicified andesite.

In the Cœur d'Alène, Idaho,† are very important and productive bodies of galena and subordinate alteration products, in a mineralised zone having a well-marked quartzite footwall and an impregnated, brecciated hanging wall of the same rock. The ore is in large shutes, which fill innumerable small fractures in the rocks—quartzite and thin beds of schists, much folded along east and west axes, by which they became faulted and shattered, and in the principal mineral belt afforded an opportunity for the ore to deposit; the gangue is siderite.

Most of the Utah argentiferous lead deposits are in blue limestone. At the Horn silver mine is a great contact fissure vein between a rhyolite hanging wall and a limestone footwall. At Carbonate mine a fissure vein occurs in hornblende-andesite. At the Cane mine, chambers in limestone carry limonite and oxidised silver-lead ores (5–7 per cent. lead), chiefly valuable for fluxing.

The mines of Eureka, Nevada, are in Cambrian limestone.

The total production of the United States is 150,000–200,000 tons annually, and Mexico, 25,000 tons.

The most remarkable mines in the world are the Broken Hill group,‡ New South Wales, which have yielded metal to the value of about 10 million sterling in less than 10 years, and still afford weekly 600–800 tons lead, and over 200,000 oz. silver. The geological features are metamorphosed clay-slates and talcose mica-schists, traversed by masses and dykes of granite and diorite, generally N. E.–S. W., but sometimes forming networks. The schists locally pass into gneiss, and that into porphyritic granite. The rocks strike generally N. W., and dip N. W. about 63°, but the formation is much disturbed in parts.

* J. F. Kemp, *op. cit.* † J. E. Clayton, *En. and Min. Jl.*, Feb. 11, 1888.

‡ M. B. Jamieson and J. Howell, "Mining and Ore Treatment at Broken Hill," *Min. Proc. Inst. Civ. Engs.*, Paper No. 2609.

The lode appears to be a mineralised bed without regular and well-defined walls. There is evidence of the existence of anticlines at various points, and the whole may come together again beneath, although it is quite as probable that the lode now being worked is only one of a series of "saddle reefs." The surface outcrop consists of masses of manganese oxide, gossan, altered schist, garnet-rock, quartz, and quartzite, with some felspar; rich specimens of iodide, chloride, and chloro-bromide of silver also have been found on the surface in some places. Lead carbonate did not appear in any quantity at the surface, but underneath both carbonate and phosphate were found in great quantities, containing silver in a variety of combinations. The small quantity of iron pyrites in the mine does not account for the presence of the large amount of ferrous oxide in the upper portion of the lode by the decomposition of iron sulphides. The ore bodies, classed according to the methods of treatment applicable to them, are:—(a) suitable for blast-furnace treatment, chiefly lead carbonate and ferrous oxide, carrying silver; (b) concentrating, both oxidised and sulphide, carrying lead and a high percentage of silica; (c) containing silver in combination with chlorine and bromine, which, after chloridising and roasting, are suitable for leaching; (d) fit for amalgamation, containing silver as chloride, chloro-bromide, and metallic, associated with a small quantity of lead; (e) argentiferous lead and zinc sulphides requiring concentration, and which, of low grade, exist in enormous quantities below the permanent water-level. Another classification is:—(a) iron and manganese oxides, containing 22–160 oz. silver per ton; (b) lead carbonate, containing 10–55 per cent. lead, and 7–110 oz. silver per ton; (c) kaolin, containing 12–700 oz. silver per ton, usually metallic, or as chloride, iodide, chloro-bromide, or bromide, with or without a small percentage of lead as cerussite; (d) copper carbonate and oxide, containing lead in the form of silicate and carbonate, with 30–200 oz. silver per ton, frequently associated with massive silver chloride and native copper; (e) garnet rock, being crystals of manganese-iron garnet, carrying 8–70 oz. silver per ton, and a small amount of lead; (f) sulphide ores, chiefly of lead and zinc, with 7–80 oz. silver per ton, and an average of about 30 per cent. silica and garnet, about 26 per cent. lead, and 21 per cent. zinc. The ore-bodies vary much in size, the greatest width yet disclosed being 316 ft., least 15 ft., and average about 105 ft. Manganese-iron ore may be said to form the capping of the lode throughout, and the greatest depth to which the iron ore may be said to exist exclusively is 300 ft. from the surface, although it has been discovered at 400 ft. Underneath the iron, the greatest extent of ore exists as lead carbonate and masses of kaolin; copper carbonate is found in a horizontal seam within the lead carbonate and kaolin ore-bodies. Underneath the lead carbonate and kaolin lie enormous bodies of sulphides. At several points, at varying depths, the lode is split into two legs by "horses" of barren rock, more or less continuously throughout its length. In places the lode stands almost vertical, but, on the whole, the greatest dip is to the west. The average level of the sulphide zone is about 300 ft. from the surface; the nearest point to the surface at which sulphides have been found

is about 110 ft., whilst the greatest depth at which oxidised ores have yet been found is about 515 ft. At some places thoroughly oxidised and almost pure sulphide ores are found side by side to as great a depth as 200 ft.

Dressing.—The process to be chosen for extracting the lead from its ores will depend upon several conditions—the composition and yield of the ore, character of gangue, influence of foreign matters, flux and fuel supplies—but practically all ores require to be first dressed, both to remove undesirable impurities, and to enrich the ore in metallic contents. Chief among the foreign substances is silver, which all lead ores contain, but only those which afford it in quantities sufficient to repay extraction are called argentiferous. While silver facilitates smelting, and adds value when abundant enough, it often complicates the dressing process, especially when its combinations possess less specific gravity than the lead ore. All other metalliferous foreign matters may be regarded as injurious—zinc blende, stibnite, iron, copper, and arsenical pyrites—must be removed, so that dressing becomes a highly important operation. Generally speaking, lead dressing follows the principles and employs the appliances already described under Concentration (pp. 133–52), and repetition is not needed here; but a few typical installations merit attention.

As an instance of the application of simple methods, reference may be made to the rectangular inclined plane made of wood lined with sheet iron (in Wales), or of stone (in Persia), on which, by some degree of skill, zinc carbonate may be washed away from lead carbonate by simply raking the mixture against a steady stream of water. But ores amenable to such easy treatment are rare.

The ores treated at Clausthal, in the Harz, consist of low-grade argentiferous galena, somewhat finely scattered through a gangue of calcspar and baryta, and mixed with both copper and iron pyrites, marcasite, and zincblende. The works are among the largest and most extensive in the world, their capacity being about 650 tons a day. In erecting and arranging the works, advantage has been taken, in the usual way, of the slope of the hillside, the ore entering upon its course of treatment on the highest, and leaving it on the lowest level. The water used for dressing, and for driving a part of the machinery, is brought by a ditch to the place where it is first needed, whence it descends; after having been used on the higher level, it is allowed to clear in tanks before being used again on the next. In its downward course it passes through several series of revolving screens, settling boxes, jigs of all classes, stamp-batteries, buddles, tables, &c.; it also drives several turbines and one overshot wheel before it finds rest in the slime pits on the lowest level. It sometimes happens that all the water available is necessary for the dressing operations, when the water used for driving machinery is replaced by steam.

Under ground the ore is separated from absolutely barren gangue and wall rock. Arrived on the surface, it begins its course of treatment in the second storey of the breaker house, where it is dumped on bar grates, which separate it into two classes, above and below 64 mm. The fine stuff drops through the grates into a revolving

screen, where it is screened wet. The coarser particles remaining on the grates are pushed down an incline into the feeder of a Blake crusher, and broken to the required size of 64 mm. and under, and fall into a revolving screen to be screened dry. These screens divide the ore into two sizes—above and below 32 mm. All the larger size is taken to the picking houses. The ore from the breaker screens is kept separate from that from the grate screens throughout these operations. The products of the first picking are:—(a) crushing ore containing coarse particles of galena; (b) stamping ore containing finely-disseminated grains of galena; (c) copper pyrites; (d) iron pyrites; (e) zincblende; (f) marcasite; (g) barren gangue and wall rock. Of these, the pyrites and marcasite are turned over to copper and iron smelting establishments, also belonging to the Government, while the zincblende is disposed of in open market.

The now partly purified ore, of 32 mm. and under, descends to the coarse separating house on the fourth level, where it is parted in the wet way into 8 sizes; the largest, over 17·78 mm., is once more picked over in the second picking house on the same floor, when the same products are obtained as in the first picking. The other sizes resulting from the coarse drums are:—17·78 mm., over 13·44 mm. and under 17·78 mm., over 10·00 mm. and under 13·44 mm., over 7·50 mm. and under 10·00 mm., over 5·62 mm. and under 7·50 mm., over 4·22 mm. and under 5·62 mm. These 6 sizes are next treated on coarse jiggers. The particles less than 4·22 mm. go through the holes of the last screen of each set, and are caught in a funnel. The turbid water, carrying with it particles of ore under 1 mm. in size, flows off to a settling box, from where the fine sands are taken to the auxiliary washing house, while the coarser sizes up to 4·22 mm. are drawn off from the funnels to a series of fine sizing drums, which produce the following 7 classes:—4·22 mm., over 3·16 mm. and under 4·22 mm., over 2·37 mm. and under 3·16 mm., over 1·78 mm. and under 2·37 mm., over 1·33 mm. and under 1·78 mm., over 1·00 mm. and under 1·33 mm., and material of 1 mm. and smaller, which is caught in a funnel below the last screen of each series. The same sizes are also obtained in the middle and fine crushing house, where the products of coarse jigging are crushed and sized. The sizes from 4·22 to 1 mm. are next treated on fine jiggers. The intermediate products from these and the stamp ore resulting from the different pickings are taken to the stamp mill for further treatment. The slime produced by the stamp battery is conducted through a classification apparatus, consisting of a number of boxes of increasing size, in which the particles are deposited according to gravity. The water flows from the last box through a settler, where it deposits its fine slimes. The sand is drawn off from the boxes, jigged, if necessary rejigged, and buddled. The turbid water from each set of jiggers runs through an adjoining labyrinth, having a circulation of 25–30 m., where the slimes carried by it in suspension are deposited into cleaning tanks outside. The slimes in the settlers are conveyed by means of a rising stream of water to the upper one of two overlapping buddles, on which pure slime and enriched sand is obtained. The latter is passed on to the lower buddle. The remaining intermediate

products of the sand jiggers are treated on tables, and the slimes are from time to time removed from the pits and labyrinths, and buddled. The slimes from the settlers attached to the coarse separating and crushing houses are dressed in a similar manner and on similar apparatus in the auxiliary washing house. It is one of the characteristics of the method adopted in these works that the jiggling and sizing are carried out to the extreme limit, and that all purified ore is obtained from jiggers, buddles, and tables, and none by hand picking.

The machinery in use is in no way peculiar. The coarse crushing rolls are set 18 mm. apart, and make 24 rev. a minute, having a capacity of 5-7½ tons per hour and pair. The middle and fine crushing rolls are set to 6 and 2 mm., respectively, and have a capacity of 2½-3 tons per hour and pair, and 60 rev. a minute. The sizing apparatus consists of revolving screen drums of perforated sheet iron; those having holes of 1 mm. are of sheet copper. Those used for washing and sizing grate smalls are conical in shape, with horizontal axes, about 9 ft. long and 2 ft. 8 in. to 3 ft. 6 in. diam., and have 32 mm. perforations. Their capacity is 2½-3½ tons an hour, and they make 12 rev. a minute. Those used for breaker smalls correspond, except in length, which is 6 ft. The screens, with perforations from 17.78 to 4.22 mm., have the same length, but vary in diameter; the larger being 3 ft. and smaller 2 ft. These drums make 12 rev. a minute, and have a capacity of 3½-5½ tons per set of 3. The drums for fine sizing, that is, those having holes 3.16-1 mm., respectively, are arranged in sets of 5, having about the same capacity as the last. They make the same number of revolutions, and are 6 ft. long by 2-2½ ft. diam. The jiggers are continuously working, have stationary sieves, and receive their jiggling action from the upward impulse, given by a succession of strong jets of water, to the ore placed on them, produced by pistons, one for each jigger, placed in a compartment behind the one in which the sieve is fixed, separated on top, but connecting below. The buddles are arranged in sets of 3; 2 are fitted on one shaft, and the third on a separate one. The uppermost is concave, and about 9 ft. 10 in. diam.; the next, convex, and 12 ft. diam; the lowest, on a separate shaft, is also convex and about 14 ft. 9 in. diam.

The Laurenberg works,* on the Lahn, Nassau, treat a very mixed ore—galena, blende (the black variety predominates over all other ores), spathic iron ore, grey copper, copper pyrites and a small amount of iron pyrites. Culling is done dry and on the ground, three classes being selected: blendiferous, galeniferous and spathic ores (i.e. those containing a large amount of siderite), and each kind is subsequently treated separately in the concentrator. The ore selected is run down in cars by gravity to top of concentrator building. The wash dirt is delivered to a screen with holes, 35 mm., 15 mm., and 8 mm., and the coarsest is delivered to and picked on a round culling table, while the 15 mm. and 8 mm. go to the 3- or 4-compartment jigs. They are driven by eccentrics, and discharge through vents on one side of the box (the newest style have no vents). Fine sand jigs of the usual form are used, and rotary and Rittinger tables. The latter do not give satisfaction, while the rotary tables, with the modifications made

* J. W. Meier, En. and Min. Jl.

by Schranz, the mill superintendent, are doing well. One of these modifications is to run the pulp on to the table at two points, and to finish washing when the ore has travelled half-way round. The table thus does double the amount of work. Another modification is to have sprinklers delivering water in a very thin sheet. To a large sprinkler pipe is attached a sheet-iron skid, against which the water is thrown from numerous nozzles, and runs down from it on to the surface of the table in a thin sheet. The rotaries have a covering of hard cement 2 in. thick, held around the periphery by a wrought-iron band. The floor on which this cement is laid has iron beams to support it. These tables furnish clean lead and clean blende. Salzburg tables are used very extensively. They produce clean galena, and blende with only 2-3 per cent. lead. For crushing wash dirt and middlings the mill has a modification of the Blake crusher invented by Schranz, rolls, and Schranz mills. The total output of the works per month is 606 tons (2000 lb.), blende with 38 per cent. zinc, and 165 tons galena with 65-75 per cent. lead, and containing on an average 32 oz. silver per ton. Tailings of this mill at present carry .3-.4 per cent. lead and 7 per cent. blende; the work may therefore be called very good.

At the Werlau mill* in the same district, the ores are argentiferous galena, blende, copper pyrites, iron pyrites and siderite, but no grey copper; the gangue is quartzose and slaty. The coarse ore is delivered to a Blake crusher. The screen has large square holes in the bottom; a sprinkling pipe supplies water, and the ore falls through on to a culling table, where the crushed ore is also delivered. Culling is done by 2 boys, who throw the waste into a central opening, and put clean blende and galena into boxes; a scraper deflects all the remaining ore into a large screen, with holes of several sizes (3, 8, and 14 mm.), and the rejections over 14 mm. diam. pass to a second culling table, attended by 6 or more boys, at 9d. a day. A scraper clears this revolving table, and passes the ore to rolls, whence it goes to a long screen with 3, 4, 5, and 6 mm. holes. Rejections pass to other rolls, until everything traverses 3 mm., when it goes to pyramidal boxes. All the jigs discharge through the bed (punched boiler plates or sheet iron, with square holes 2 mm. larger than the ore being jigged), by which it is said the beds never foul, and more rapid and clear discharge is secured. There has always been difficulty in getting clean blende from the slimes. The most recent apparatus employed consists of Lührig vanners and Salzburg tables. The blende from the Lührig is not free from galena and pyrite, nor are the tailings clean. The blende from the first Lührig passes to a novel feeder, consisting of a wooden conical basin, which receives a slow revolving motion from bevel wheels and pulley placed below it; a box hangs suspended over the cone, and receives the pulp, while water is added from a pipe. The revolving cone carries with it the required amount of pulp, which passes through an opening to the distributing apron of a second Lührig. The tailings from this go to Salzburg tables, of which there are 4 in the mill. Each of these has a wooden or iron hopper, into which pulp is shovelled; sufficient water is added from a pipe, and the pulp is fed by a screw conveyor. The Salzburg tables work in two pairs: the

* J. W. Meier, En. and Min. Jl.

first treats certain sands carrying lead—they are first washed for a while on one of the tables, then the table is shovelled off and the upper portion is worked a second time on Salzburgs, while the lower portion goes to stamps and thence to sandjigs. The other pair of Salzburgs is used for the washing of middlings from the second Lührig. There is one difficulty which may interfere with successful treatment—i. e. the middlings running off the lower edge of the first vanner are very liquid, and if the sprinklers on the second vanner add much more water, there will be an excess, the cloth will be washed clean, and no concentrates will remain. This new concentrator saves largely in labour and fuel. The old Werlau concentrator in 24 hours cleaned 20,000 kilos of wash dirt, employing 90 labourers and burning 28,000 kilos of coal. The present cleans 40,000 kilos in 10 hours, with 45 labourers and 1600 kilos of coal. The tailings are lean; coarser sizes carry at most 2 per cent. zinc and a fraction of 1 per cent. lead oxide. The assays of tailings from slimes could not be obtained. The wash dirt carried 9.26 per cent. galena and 18.96 per cent. blende. Concentrates have 64–65 per cent. lead oxide, 41–42 per cent. zinc, and 11 oz. silver.

The dressing mill at the Arranyes mine, near Linares, Spain, has lately been completely equipped by the Humboldt Engineering Works, at Kalk, near Cologne, to treat 500 tons galena, containing 20 per cent. lead, per day of 10 hours. The proper utilisation of the natural situation, the efficient and thorough dressing of the medium products, and the careful treatment of the slimes, have contributed materially to make this an exemplary ore-dressing mill. The plant is arranged stepwise in 4 departments. In the first department, which consists of the picking shed and first washery, all the crude ore, that is 50 tons per hour, is tipped into 4 masonry bins, whence it slides on to grids with 30 mm. square holes, one to each bin, which serve at the same time as picking tables. On the 4 picking tables, the crude ore is separated into pure lead ore, steriles (gangue), and medium products. The small ore, under 30 mm., which falls through the picking tables, descends into the lower part of department 1, and is classified in 2 systems of trommels, consisting each of 4 trommels, and, except the fine grains below 4 mm., is then enriched in 16 jiggers. The medium products or middlings from the picking tables and from the jiggers are forwarded to department 2 to be dressed, the former being lowered by means of brake platforms to the lower level. The wash water of the jiggers in department 1 is allowed to settle in pits on the same floor, and then forced back by a centrifugal pump. This department is driven by a separate condensing engine. In department 2 the following machinery is erected:—2 stone breakers, 2 classifying trommels, 2 roller crushers, 2 revolving picking tables. The middlings from department 1 are first broken in the stone breakers, the product then passes the classifying trommels, the large pieces are sorted on the picking tables, from which the poor passes to the roller crushers. The reduced product passes on to department 3, where it is classified in two sets of 4 trommels each, and then enriched in the 16 fine jiggers. Together with the reduced product, the grains below 4 mm. from the trommels in department 1 are passed

through these trommels in department 3. The water from the 16 jiggers is clarified in settling pits on the same level, and pumped back. The middlings from the fine jiggers are passed on to fine roller crushers, and the reduced product, after passing the guarantee trommels (one to each crusher), reaches department 4, the slime washery, to which the finest grains from the trommels of department 3 also slide. Department 4 contains :--1 classifying apparatus, 1 pyramidal box, 4 slime jiggers, and 4 Linkenbach tables or rotary buddles, 6 and 7 m. diam. respectively. The coarse grains from the classifier are conveyed to the slime jiggers, and the thickened slimes from the pyramidal boxes run on to the buddles. The three lower departments are driven by a horizontal compound condensing engine, and steam for the whole mill is supplied by 3 Lancashire boilers on the level of department 2. The pumps for elevating the clarified wash water in the various departments are centrifugal pumps or piston pumps, according to the height to which the water has to be lifted.

The extensive dressing works at Neuhof, near Beuthen, Germany, are also constructed by the Humboldt Company.

A detailed and illustrated description of the galena and blende dressing works at Sentein, in the Pyrenees, fitted by George Green, Aberystwith, will be found in the author's 'Mining Machinery,' p. 384.

In Missouri and Kansas,* the ore is found in many different forms and with a number of gangues, such as chert, limestone, calcite, iron pyrites, and mud sediment. Here a 5-sieve jig is used to advantage when the gangue is heavy, such as black chert or baryta.

The dressing works of the St. Joseph Lead Co., at Bonne Terre, † Missouri, have a capacity of 500 tons a day. The mineral yields on an average about 7 per cent. non-argentiferous galena, and 1 per cent. or more of cobalt and nickel-bearing pyrites; the gangue is magnesian limestone. The ore is crushed by jaw-crushers and rolls, and screened dry through a 6 mm. screen. The sands passing through the screen are thoroughly mixed with water, elevated by centrifugal pumps to distributors, and divided among Parsons jigs, without any previous sizing or classification. The tails ("chats") after passing over the two sieves of these jigs receive no further treatment, and are conveyed by launders to the "chat-tanks." Coarse galena and raggings are skimmed by hand from the jigs at intervals, leaving always a sufficient bed to ensure good hutchwork. The hutchwork which comes through the sieves of the Parsons jigs passes through a series of pyramidal boxes. The heavy galena, mixed with some sand and slime, settles in the first box of the series, from which it is fed to a trunking-machine. The pure galena from this machine falls into railroad cars and goes to the smelting-works. The tails from the trunking-machine, together with the sands settling in the second box, are elevated by centrifugal pumps and divided between Harz 3-sieved jigs. The tails of the Harz jigs receive no further treatment, going directly to the chat-tanks. Galena and pyrites are skimmed from the sieves of these jigs; a bed of galena is, however, maintained on all, so as to

* G. T. Cooley, En. and Min. JI.

† H. S. Munroe, Trans. Amer. Inst. Min. Engs., 1888, p. 659.

ensure a rich hutchwork. The hutchwork of these finishing-jigs is nearly pure galena, and goes to galena-boxes on the lower floor, which are emptied from-time to time, and the galena is loaded on cars to go to the smelting-works. The fine slimes settling in the third and fourth boxes are united and raised by centrifugal pumps to the distributors feeding the first row of Parsons-Rittinger tables. The middlings from these tables are treated on the second row of tables. The tails from all the tables flow into the chat-tanks, and the heads run into galena-boxes on the lower floor from which they are loaded into cars. The raggings, containing 12-20 per cent. lead, which are skimmed from the Parsons jigs, are recrushed by fine rolls, and elevated without screening to a line of Harz 3-sieved jigs. These raggings contain considerable pyrites.

The mill is a two-storey structure. On the main floor are the ore-bins, roughing-jigs, finishing-jigs, and tables. There is nothing to intercept the light falling on the jigs and tables, and the roof is a mere umbrella of corrugated iron, with light iron trusses, and supported on slender columns. The arrangement in two floors is unusual, but permissible under the conditions, as, after passing over the roughing-jigs, 600 tons of waste sand go at once to the chat-tanks. Of the remaining 200 tons, 74 tons are mineral and raggings, and 20 tons escape with the overflow of the boxes, leaving only 106 tons to be elevated again. The average lift is less than 30 ft. If the mill had been arranged in steps, it would have been necessary to deliver the ore at a level 40 ft. higher, involving a much more expensive building, and increased cost of hoisting the whole 800 tons, to save the elevating of 106 tons a second time; moreover, both the wash-water and feed-water for the different machines would have to be raised about 20 ft. higher, and as 29 tons of water are required to treat 1 ton of ore, this additional lift would be a serious matter. In round numbers, the saving amounts to over 20 h.p. Of the ore coming from the mine, nearly 40 per cent. is as fine as if it had passed through the jaw-crushers, 15.5 per cent. is as fine as though it had passed through the rolls, and 8 per cent. is fine enough for the jigs. This latter portion is very rich, carrying over 20 per cent. lead. The distribution of sands or slimes is performed by a feeder divided by partitions into a number of radial boxes, ensuring uniformity. Sands and slimes are treated together on the same jigs, and though the loss of galena in the very finest slimes is large, yet the method has advantages, notably in allowing very much finer material ($\frac{1}{8}$ mm. and less) to be treated successfully, and in the large proportion of sands finally disposed of by the roughing jigs alone. Thus, out of 800 tons a day, only 136 tons require further treatment—viz. 30 tons raggings, crushed and treated on the 3-sieve jigs; 66 tons fine sand, also treated on 3-sieve jigs; and 40 tons slimes, treated on side-bump tables. The disadvantage lies in the difficulty of forcing all the very finest slimes to go through the jig-sieves. The material treated on the finishing-jigs is very rich, containing about 25 per cent. lead, and the losses are quite large; it is also very fine, over 90 per cent. being less than $\frac{1}{4}$ mm.; the losses are confined to the stuff below $\frac{1}{20}$ mm. For the year ending May 1, 1887, the yield of the ore treated was 5.65 per

cent.; the loss in tailings, about 2·13 per cent., or 27·4 per cent. of the total in the ore; and the cost, 1s. 6¼*d.* a ton, about ⅓ being for labour and ¼ for fuel.

Smelting.—While the metallurgy of lead may be said to consist simply in reducing the metal from its ores, the reactions which take place in the operation are most complex, and probably not yet completely understood. Besides the usual text-books the student will do well to consult a recent paper by J. B. Hannay.* Practically all methods hitherto successful rely on roasting or calcining (to remove sulphur) and smelting. The ores arrive at the smelter more or less “dressed,” and the proportion of lead in the ore varies from a very low figure in some richly argentiferous ores (smelted more for their silver than their lead) to 80 per cent. or more. The foreign substances present in different proportions are chiefly antimony, arsenic, copper, gold, iron, silver, sulphur, and zinc. The characters (chemical and physical) of the ore, and cost and kind of fuel and fluxes, principally determine the method followed.

Reverberatory furnace practice may be conveniently dealt with first.

In England, the so-called Flintshire method, adopted in Wales, Yorkshire, Shropshire, and Derbyshire, employs a furnace such as shown in Fig. 147. On each side are 3 openings, capable of being closed by iron doors; those on one side *a* are used by the workman for manipulating the charge. The central opening *b* on the other side has an iron pot *c* outside it, into which the lead is tapped off when the operation is completed. The remaining two openings *d* are used for removing slag. The charge is introduced by a hopper in the crown. Under the whole length of the furnace runs an arched brick vault, open to the air at both ends, and supporting the working bed proper. This is formed of “grey slag” from a previous operation, broken small, and fed into the furnace when the latter is at red heat; it melts and forms a pasty mass, which is spread in a layer 6–18 in. thick, hollowed in the middle towards the tap-hole *b*, and allowed to solidify, about 5 tons of slag being required. The fireplace *e* is at one end, and has an ash-pit which contains water; the flue openings *f* at the opposite end communicate with the shaft *g*. The charge of ore, usually 21 cwt., is introduced by the hopper and spread over the floor, care being taken, however, that none of it shall lie on the most depressed part near the tap hole. The process of the smelting may be described as having two stages, the first being calcination of the ore, and the second the melting down and reduction of the metal. During the first stage, which lasts about 1½ hours, the doors are left open, or are only partially closed, so as to allow of access of a sufficiency of air, and the heat is regulated by keeping down the damper considerably. During the whole process of calcination a workman repeatedly rabbles or turns over the charge so as to expose all parts of it to the action of the air and heat. The doors farthest from the furnace are then closed, and the fire is urged so as to bring about the commencement of the second stage of the operation, when reduction begins to take place, and lead to trickle down into the well. At the

* “Metallurgy of Lead,” Trans. Inst. Min. and Met., iii. 171.

expiration of about 2 hours the doors are all closed, the damper is fully raised, and the whole charge is melted down into the well, which then contains lead at the bottom and slag at the top. A shovelful of lime is thrown upon this and mixed with the slag, with the object, it is said, of thickening it, and the slag is with any unreduced portions of ore pushed back on to the bed of the furnace and remelted. When it has all run down, more lime is added, and the thickened slag is again pushed back to drain the lead out. The lead is then tapped

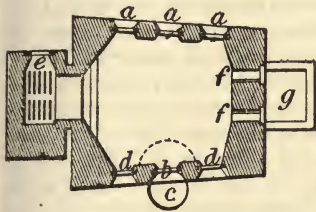

FIG. 147.—FLINTSHIRE FURNACE.

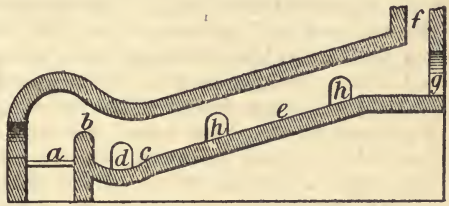

FIG. 148.—MEXICAN SERPENTON.

through a hole made by driving an iron bar into the well through the clay stopping in *b*. The slag, known as "grey slag," is then raked out. The time occupied in working off a charge is about 5 hours. Ignited coal with slack is thrown upon the surface of the lead in the pot, and subsequently skimmed off with the scoriæ and thrown back into the furnace for more lead to sweat out.

The Derbyshire ore carries much barytes, which necessitates the addition of fluorspar or calcspar. The slag in that case (called "run slag") is chiefly tapped off before the lead, for which purpose the furnace is provided with two tap-holes instead of one.

The Cornish method requires two reverberatory furnaces. The first, with a flat floor, is used for calcining the ore, which, after calcination with the addition of a little lime to prevent clotting in the early stage, is drawn out and introduced into what is termed a "flowing furnace." This is a reverberatory furnace similar to that used in the Flintshire process, but the charge, mixed with culm (small anthracite) is introduced not by a hopper in the roof, but through the doors opposite the tap-hole. The charge is at once melted down with closed doors and strong heat. At a certain stage of the smelting, 5 per cent. scrap iron is introduced into the well of the furnace. The products, which are all run at one time from the tap-hole, are first lead, then a regulus or matte (consisting chiefly of iron protosulphide, but containing other metals such as copper or silver present in the ore), and lastly a slag which contains only 1-1½ per cent. lead, and is thrown away. This method is used on ore yielding 60-70 per cent. lead, composed of galena, blende, spathic iron, grey and black copper ores, quartz and fluorspar.

The *serponton* of the Sierra Mojada, Mexico,* is a reverberatory furnace, built of adobe, with a stone lining to the chimney and the inclined part of the hearth. The fire-box *a* (Fig. 148) is 3 ft. long

* R. E. Chism, Trans. Amer. Inst. Min. Engs., xv. 560.

and $1\frac{1}{2}$ ft. wide, vaulted over, and at the inner end has a fire-bridge *b* about 1 ft. high. The basin *c* is about 36×18 in., lined with refractory clay and well fettled with slag, the lowest point being beside the tap-hole *d*. Behind the basin, and sloping upwards at about 10° , is the hearth *e*, 12 ft. long by 18 in. sq. section, floored and partially lined with refractory stone; it opens directly into chimney *f*, which rises 16 ft. above the highest part of the hearth *e*. The charging door *g* has the same sectional area as the hearth; the latter is arched over in its entire length, and is provided with working doors *h* about 8 in. square at intervals. The charge is 10 arrobas ore with 1 of litharge and 3 of lead scum from the remelting furnace, thrown in at *g*, each shovelful of charge being mixed with 4 shovelfuls of charcoal dust. Metallic lead and litharge are soon formed, making a slag with the small amount of silica present, and forming a crust on top of the ore layer. This being the case, the charge is skimmed, the crust being moved downward on the hearth towards the fire-box in fragments, while the under portion of the charge is rabbled, so as to be better exposed to the action of heat. These operations are repeated in succession, fresh ore being charged whenever necessary, and the former charge being moved downward until, in 3-4 hours after charging, the basin is full of melted lead, on top of which floats a highly basic slag, only made fusible by the large quantity of lead (sometimes 35 per cent.) which it contains. The lead is run off from time to time into a basin or receptacle dug in the ground at the side of the furnace, and cools into rude slabs. The furnace lining is continually used up to provide silica for the slag. The slabs need remelting and moulding. The cost is stated* at 28s. a ton. The product is an excellent lead, carrying over 90 oz. silver to the ton. The slags carry 30 per cent. lead, the object being a large saving of silver at lowest cost for reducing and cupelling the lead.

The Carinthian reverberatory for galena slimes is 10 ft. long, 5 ft. wide, and contracts towards one end, sloping also uniformly in the same direction, and ending in a narrow gutter which conducts the reduced metal to a well just inside. The fireplace runs parallel to the longer axis, and is provided with air holes; the grate is of stone, if for wood fuel, and of iron bars if for brown coal. The hearth bed is 6 in. thick, made of a mixture of fireclay, old beds, poor slimes, and slags, all fused into a mass. The complete treatment of about 750 lb. of ore occupies 21 hours; about 11 cub. ft. of wood are burned per cwt. of charge; and $2\frac{1}{2}$ per cent. lead is lost. Blast furnaces are supplanting this method.

A great variety of ores are smelted at Freiberg, mostly in the form of slimes, and containing (*a*) galena mixed with arsenical and iron pyrites, blende, calcspar, barytes, quartz, and brownspar; (*b*) also a silver ore carrying much earthy matter and a little pyrites and galena; (*c*) and a copper ore carrying silver; (*d*) as well as a fluxing ore giving pyrites, blende, calcspar, galena, copper, and .03 per cent. silver. The galena *a* is divided into 1st and 2nd classes, according as it does or does not carry 30 per cent. lead. The preliminary step is roasting in the reverberatory (Fig. 149) in which the flames pass from

* J. N. Judson, op. cit., xv. 587.

the fireplace *a* over the lower bed *b*, up to and over the upper bed *c*, and carry the sulphurous acid through the flue *d* to a condenser. The charge, consisting of 50 per cent 1st class *a*, 30 per cent. 2nd class *a*, and 20 per cent. *b* or *c*, is introduced on to the upper bed and gradually pushed towards a hole communicating with the lower bed, through which it falls, and is raked forward; it is thus exposed to gradually increasing heat till fusion is reached. The charge is renewed continuously at each move forward, 1 ton of ore requiring 8–16 hours. The metals are mostly oxidised, but 4 per cent. sulphur remains. The roasted and agglutinated ore is smelted with 5 per cent. lime and some roasted matter in a blast furnace; and the regulus is roasted and resmelted several times till rich enough in copper for special extraction of that metal. Lead slags, and poor dry ores, are smelted in other reverberatories (Fig. 150); charges of 20 cwt. lead slags, 5 cwt. raw ore, 5 cwt. roasted ore, and 2 cwt. quartz, are intro-

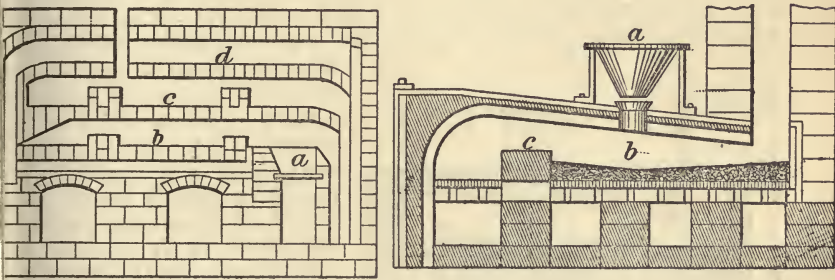

FIGS. 149, 150.—FREIBERG REVERBERATORIES.

duced by the movable hopper *a*, and uniformly spread over the hearth *b*, making the layer somewhat higher near the fire-bridge *c*. Smelting is conducted without air for about 3 hours; when the almost fluid mass is stirred and exposed for 20 minutes to a still higher temperature, after which the slag is drawn off. When 2 or 3 charges have been smelted, the regulus is tapped off into moulds and cooled, and finally smelted again in a Pilsz furnace.

At Clausthal the preliminary calcining to remove sulphur used to be done by piling ore and pine logs in heaps, igniting, and leaving them to burn for 3 or 4 weeks, after the manner of the *telera* at Rio Tinto (see p. 431). The oxides and sulphates thus formed are afterwards smelted in blast furnaces. Pile roasting has also been common in Utah, using the lighter woods (piñon pine gives too much heat), at a cost of 2s. 6d. a ton for raw ore, and 9s. a ton for matte.* At Las Trojes, too, Michoacan, Mexico, the highly pyritic ore is calcined in open heaps called *caleras*, but the operation is only partially performed in wet or windy weather, and occupies a long time, so that stalls are coming into favour as a substitute, notably on account of the reduced loss of silver.

In France, highly silicious ores are roasted in a reverberatory like

* R. H. Terhune, "Ore and Matte Roasting in Utah," Trans. Amer. Inst. Min. Engs., July 1887.

the Flintshire furnace, except that it is filled to the level of the working doors with black slag, so as to form a flat hearth. The operation is made intermittent, rabbling taking place alternately with periods of heating with closed doors. When sufficient sulphur has been driven off (in about 6 hours), the heat is forced till the charge runs together, when it is drawn out on the floor, and cooled ready for smelting.

In the south of France an effort is made to get uniformity in silver contents by weighing out and spreading in equal layers, one on top of the other, the required quantities of the several ores and mattes to form a roasting bed of about 20 tons, and this stratified bed is cut down vertically into 1 ton charges of equal composition. If very silicious, a little coke dust is added; the matte serves as flux, and is usually about 10 per cent. of the whole. The furnaces measure about 40 ft. long and 15 ft. across widest part, built of lava or stone, and lined with firebrick. The ore is dropped from a hopper at the farthest end from the fire on to the drying bed, where it is stirred for 6 hours; then pushed nearer the fire for another 6 hours, and finally raked on to the fluxing bed, next the fire, and a few inches below the

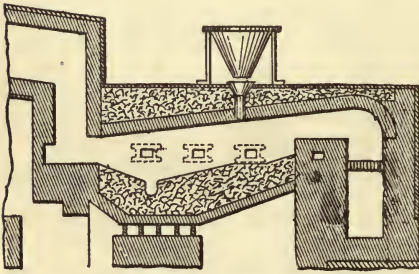

FIG. 151.—FRENCH REVERBERATORY.

level of the other two beds, till a further 6 hours' heating results in fusion, when it is drawn. The work is made continuous by adding a fresh charge as each is moved on, and thus 8 tons are roasted and fluxed in 24 hours at a cost of 2 tons coal. The flux is 6 per cent. lime and 7 per cent. iron slags. Pure ores are treated in the reverberatory shown in Fig. 151, about 11 ft. by 9, the hearth resting on iron supports and formed of firebricks on edge, with the usual slag covering. The tap-hole and lead well are placed near the flue end to reduce loss by volatilisation. The aim is to convert about one-half the sulphide into sulphate or oxide first, and then, by increasing the temperature, to get a reaction between the oxidised and unoxidised portions. The furnace being red hot, the charge is dropped from the hopper and evenly spread over the bottom. The heat is slowly increased, and air is freely admitted to cause oxidation. Whenever a crust of oxidised material forms on the surface of the charge, a new surface is exposed by rabbling. Cinders are used for firing in preference to coal at this stage of the operation, as they give a steadier heat, do not yield any gaseous hydrocarbons to interfere with oxidation, and cost less. After 4-5 hours, the charge will be sufficiently desulphurised, when the temperature is slowly raised by adding coal to the fire, and the second stage of the operation (smelting) is commenced. Care has to be taken that the heat does not become too high, as that would cause loss of lead by volatilisation. To prevent fusion, lime is thrown on the mass whenever it shows a tendency to liquefy,

and is thoroughly worked into it. The consumption of lime in this operation amounts to about 2 per cent. of the charge. The reduced metal, which first appears in globules on the surface, drains down the slope of the hearth into the lead well. After about 3 hours enough will have collected to justify tapping. The lead flows into a pot under which a fire burns to keep it liquid. The dross is skimmed off and thrown back into the furnace. Coal dust, cinders, and powdered lime are stirred into the lead, and the impurities are once more skimmed off, when the lead is ladled into moulds. When as much lead as possible has been extracted from the charge, the heat is increased in order to completely oxidise the remaining material, but not sufficiently to fuse it. After this object has been attained, the pot skimmings, consisting chiefly of cinders and sulphides, are thrown on the charge, when a further yield of lead is tapped off, and the slags are raked out through a door at the back of the furnace. The entire process requires about 5 hours. Before introducing the next charge, the furnace bottom has to be thoroughly examined, and, if necessary, repaired, as it is of great importance to keep it perfectly smooth and sloping evenly towards the tap-hole. About 40 per cent. of coal is required. The total loss amounts to about 3.5 per cent., mainly caused by volatilisation, but a considerable portion of this is recovered from the flues in which it condenses. The slags retain about 20 per cent. of the original amount of lead, and are resmelted in a blast furnace, when the greater part of this is also recovered.

The Spanish *boliche* (Fig. 152) as used at Linares, is built of rubble and clay, and lined throughout with refractory clay. The fireplace *a*, 5 ft. 6 in. long and 2 ft. 2 in. wide, has no grate, and is fed with brushwood by the door *b*. The hearth *c* measures $7\frac{1}{2}$ by 6 ft., and connects by flues *d* with a chamber *e*, which is regarded as highly

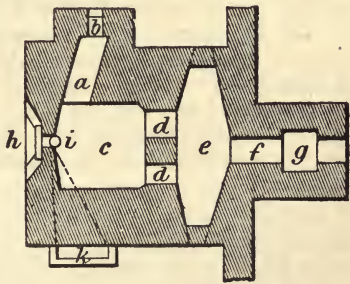

FIG. 152.—SPANISH BOLICHE.

important in controlling the draft, and certainly serves to retain some mechanically suspended mineral. The flue *f* leads to chimney *g*, about 30 ft. high. The bottom of hearth *c* slopes gently towards the working door *h*, immediately within which is a well *i* for collecting the molten metal, connected with a receptacle *k* outside. The charge is thrown into the furnace, evenly spread on the hearth, and frequently rabbled for $1\frac{1}{2}$ hours, during calcination. Then the temperature is raised and the charge is smelted, yielding about 80 per cent. of the metal in the ore, while the grey slags contain 40–50 per cent. and are resmelted in a blast furnace.

A sort of intermediate between the reverberatory and the blast furnace is the ore hearth (Fig. 153). It affords one of the simplest lead smelting methods, and recommends itself by its small consumption of fuel, quick operation, and inexpensiveness in general, as compared with the reverberatory and blast furnace processes. It also

permits an interruption of the operation at any stage without great loss of temperature; and peat or wood may be used as fuel where coal or coke is not obtainable.

These reasons recommend the hearth furnace in places where another kind might otherwise be used, and particularly to small smelting establishments. Very pure galena may be treated direct in the hearth furnace; impure ores have generally to be roasted previously. In the Scotch hearth, a cold blast is used; in the American, a saving of fuel is effected by using a hot one.

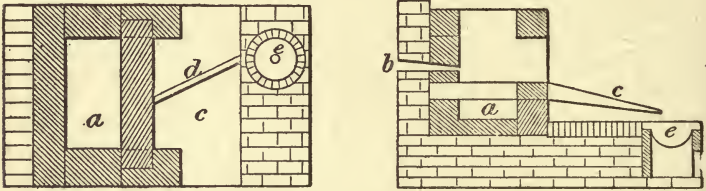

FIG. 153.—SCOTCH ORE HEARTH.

It consists of an oblong cast-iron tank or well *a*, about 2 ft. 6 in. wide, 2 ft. from front to back, and 1 ft. deep, capable of containing about 2 tons of lead, with which it is filled to the brim, the surface of the lead forming, in fact, the floor of the hearth. The floor thus formed is enclosed at the sides with blocks of cast-iron, and another block of cast iron is placed behind, and is perforated for the passage of the tuyer *b* that conducts the blast into the furnace about 2 in. above the surface of the lead in the well. A shaft of brickwork proceeds upwards from the hearth to the flue, and there is behind it a blind flue or pit into which the "hearth ends," or dusty matter which comes off with the fume, may fall, and from which it is removed as requisite. The front opening to the hearth is sometimes provided with a sliding shutter, which by means of a counterpoise can be raised or let down in its groove so as nearly to close in the front of the hearth. Extending forwards from the front of the hearth, and inclining downwards at an angle from it, is a plate of iron *c* called the "forestone," in which there is a groove *d*, that leads towards an iron pot *e*, kept hot by a little fire beneath. The ore is fed in either from the front or through a hopper at the side. A fire of coal being made upon the hearth, and heaped up chiefly behind, a moderate blast is put on and the ore (sometimes previously calcined) is thrown on, and if there be a shutter this is put down. After the lapse of a few minutes, the workman introduces a poker and stirs up the fuel and ore, and from time to time repeats the above process with fresh small quantities of ore, adding fuel as it appears requisite. At intervals of a few minutes he raises the shutter and draws forward a portion of the charge on to the forestone and picks out from it portions of "grey slag" which he pushes aside, and ultimately throws off on to the floor of the workshop at the side of the hearth. As the lead forms, it runs into the well, and overflows along the channel of the forestone into the pot *e* set to receive it, from which it is ladled into the moulds. It is a process

which requires constant manipulation of the charge, two workmen being continually occupied in adding ore or fuel, poking up the charge, &c., at intervals of a few minutes. Lime is used, as in the Flintshire process, to thicken the slags.

The favoured type of reverberatory (or "roaster") in America* is the "4-hearth," so called because the length of the hearth is roughly 4 times its width, though the slope may be continuous from end to end, and no step may mark the division between the hearths. To each "hearth" belong 4 working doors, 2 on each side, generally opposite, but better alternating. A furnace with 4 hearths, each 14-16 ft. square, should deal with 8-10 tons ore a day if only roasting; but if the charge has to be fused or slagged in addition, the quantity will not exceed 6 tons, and the expense is proportionately increased. The fusion hearth is nearly circular in plan, the radius being 10 ft. 8 in. From the last calcining-hearth to the bed of the fusion-hearth is a drop of 26 in., the object being to get the end of the arched roof of this portion of the furnace below the level of the calcining-hearths, so as to ensure the flames being completely reflected upon the mass undergoing fusion, before being spread over the wider calcining hearths beyond. The vaults beneath the calcining hearths are best filled solid, and should be used as dust chambers only when lack of space compels it. Under the fusion hearth an air space is necessary. The object of fusion is to obtain a slagged mass in lumps that can be handled, and will help to keep the blast furnace open. But while in simple roasting the lead loss does not exceed 5 per cent.—say 2 per cent. on a 40 per cent. galena—in fume, half of which should be recovered, and the silver loss is not more than 1 per cent. (unless much chloride is present), in fusion, on the contrary, the lead loss will be 15-20 per cent. and the silver loss 3 per cent., under ordinary conditions. Hence it is advisable to use the maximum of roasted ore which the furnaces will bear, and to fuse only enough to keep the charge open, selecting ores low in lead and fine in size, such as concentrates from gold mills and antimonial, arsenical, and zinciferous parcels.

The Mexican *horno castellano* † or upright furnace (Fig. 154) is an exceedingly simple structure, being little more than a niche in an adobe wall, more or less completely lined with refractory stone. It is always of approximately square section, about 14 in. on each side at the mouth, and tapers gradually from the mouth to the tuyer-level, where the section is about 12 in. on each side. It is about 3½ ft. high, from the mouth to the tap-hole. The single tuyer *a*, about 1 in. diam., is 5-7 in. above the tap-hole, and the bottom of the furnace has a slant forward, commencing just below the tuyer and ending at the tap-hole. The tap-hole is some 2½-3 ft. above the floor of the casting-

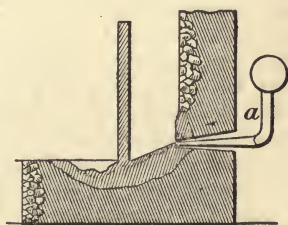

FIG. 154.—MEXICAN HORNO CASTELLANO.

* H. F. Collins, "Smelting Processes," op. cit.

† R. E. Chism, op. cit., p. 555.

room, and a sort of bench of stone and dirt, with a rude basin in its centre, is formed in front of the furnace, to receive the molten products and give them a chance to separate before going farther. When the furnace is to be operated, the lower fourth of the shaft or niche is dug out to a depth of 3 in., lined with refractory clay mixed with charcoal-dust, and well rammed. The bottom is made of the same material, and the fourth or open side of the niche is closed up from top to bottom with adobes luted with clay, leaving the tap-hole about 2 in. diam. The charging of the furnace is done at the open mouth, the feeder carrying the materials and fuel in a little tray, and mounting up on the bench just mentioned to throw them in. Two furnaces are built side by side, with an interval of $4\frac{1}{2}$ ft. clear between them. The slag is led off on the side of each furnace farther from the centre-line; but the lead from both furnaces runs towards the centre into a rough, oval depression in the floor of the casting-room, where it consolidates into a rough slab. The tuyers, one to each furnace, are poked through the refractory lining, and wedged around with refractory clay. Generally, each furnace is supplied with wind by a large blacksmith-bellows, worked by hand-power through a system of levers, which allows the weight of the men to do most of the work. Sometimes a Sturtevant blower is used. On beginning to work with a new or newly-lined furnace, the shaft is slowly heated up by a small charcoal or wood fire, without blast. When the whole structure has thoroughly dried out, more charcoal is thrown in, the blast is turned gently on, and a small charge of slag and lead scum from the remelting furnaces is exhibited. The charges are gradually increased in size and mixed with ore, until the full burden of the furnace is reached.

The Castilian blast furnace measures about 8 ft. high and 3 ft. diam., and is constructed of firebricks moulded into the shape required, the shaft thus constructed being surmounted by a box-shaped hood, in the sides of which are the flue and feeding door, and on top an arch of brickwork laid in clay forms a dome. The breast is formed by an iron pan, having on its upper edge a lip to allow the slag to flow off, and on one side a long narrow slot for tapping or drawing off the reduced metal. The bottom of this furnace is made in the following way:—A mixture of fire-clay and coke-dust is slightly moistened and stamped or beaten into the hearth bottom until it reaches the top of the breast pan. This is hollowed out in the usual way to form a cavity for the collection of the reduced metal, and allowed to dry thoroughly before the apparatus is used. The blast is applied by 3 tuyers having a diameter of $5\frac{1}{2}$ in. at the receiving ends and 3 in. at the nozzles. The blast is conducted to them through brick channels placed under the floor of the furnace house. The structure is secured by iron bands encircling it, and the hood is supported by iron columns. In working, the charge should never contain over a third of its volume in lead. If richer ore is to be treated, it must be reduced to this proportion by the addition of poor slags. To prevent the walls from getting too hot, and preserve the bricks from burning or melting, care has to be taken in charging to throw the fuel towards the centre and the ore towards the walls. Attention has to be paid to the proper

regulation of the temperature, as a too high degree of heat will cause loss of lead by volatilisation. As long as the slag flows liquid and readily, the cooler the furnace is kept the better. Some ferruginous ore is usually added at intervals during the operation. The slag flows continuously into cast-iron wagons, from which it is dumped after having cooled down. The advantage of this is that if at any time the furnace should run lead or matte, it can easily be recovered. Extensive condensing apparatus should be provided, as a considerable amount of lead volatilises even when every precaution is taken.*

The typical European blast furnaces are the Pilsz and the Raschette, differing little but in shape, the former being circular or octagonal and the latter an elongated parallelogram in section. The Pilsz has 7 tuyers, and its upper portion is sustained by a cast-iron mantle, so that the interior portion, composed of firebricks, can, when burnt out, be easily removed without disturbing the superstructure. The section of the furnace widens upwards towards the feed doors, which arrangement is exceedingly advantageous, in view of the fact that the charge becomes compacted as it descends towards the smelting zone. The gases as they ascend to the upper parts of the stack have an opportunity to expand, thus diminishing their velocity, and for this reason the amount of flue dust is very considerably lessened. The Raschette is particularly applicable to smelting both lead and copper ores, and as originally constructed, had two working fronts, and was proportionately very much longer than it was wide. It was found that this furnace put through in 24 hours 40–50 per cent. more ore than the round furnaces. The upper portion was, like the Pilsz, supported upon an iron mantle resting upon iron columns. It has formed the basis of modern improvements. To prevent the loss of time, labour, and temperature occasioned by the frequent burning through of the lower portion of the furnace, the brickwork in that part has been replaced by a so-called "water jacket," an annular cylinder of iron about 3 ft. high, which is kept cool by a constant stream of cold water running through it.

The essential features of a typical lead smelting furnace of to-day are shown in Fig. 155. The water jacket *a* is either cast in one piece or constructed of $\frac{1}{2}$ -in. boiler plate. The position and number of the tuyers *b* is a matter of importance. The usual number is 5, which pierce at equal distances the lower third of the water jacket and converge towards the centre of the furnace. By reducing the number of tuyers, or placing them farther from the breast, the water would cool the interior of the jacket to such a degree as to interfere with the regular descent of the charge. The water enters through an inlet pipe at the bottom of the jacket, supplied with a valve to regulate the supply, and leaves on the opposite side near the upper edge of the jacket. The arrangement shown in dotted lines at *c* can be recommended, as the workman may readily estimate the quantity and temperature of the water as it falls from the outlet pipes into the funnel *c* communicating with the drain, and regulate the cold water supply accordingly. The upper part of the furnace is frequently encased in sheet iron, strongly riveted together, to strengthen it and

* See J. Déby, "Argentiferous Lead Mines of Spain," in *Industries*.

to prevent the escape of gases. A sheet-iron hood *d* is placed over the fore hearth *e*, and carries off lead fumes escaping from the breast, and thus prevents them from injuriously affecting the health of the charger above. When necessary, this hood may be pulled up, by means of a chain and pulley *f*, so as not to interfere with the work. The charging is done at the top, which is preferable to charging from the side or rear, as less atmospheric air enters the flue. The bottom of the furnace is made of brasque, and hollowed in the usual way to form a cavity for the collection of the melted lead. At *g* is the automatic or siphon tap or lead well invented by Keyes and Arents.

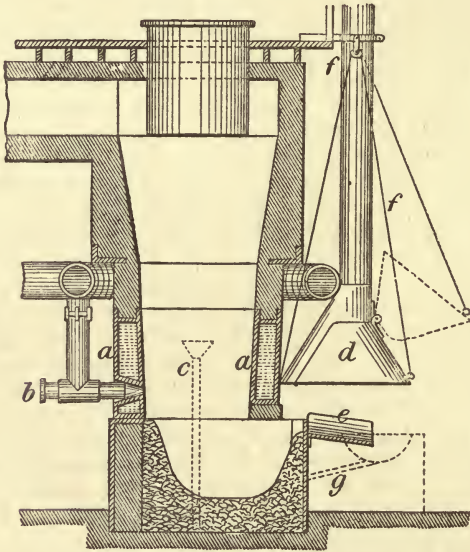

FIG. 155.—MODERN BLAST FURNACE.

It should be so constructed that a bar inserted from the outside will readily pass to the bottom of the furnace, an angle of 35° – 45° being best. Some further points which Keyes* thinks would be improvements are:—(*a*) that the interior walls of the furnace, instead of proceeding directly upward, should expand in the form of a letter V, the lower portion being towards the hearth; (*b*) a forward rake of the tuyers towards the hearth or slag discharge of the furnace would drive the slag as formed towards its natural exit, the slag door; (*c*) provision of two spouts, one 2 – $2\frac{1}{2}$ in. higher than the other for the discharge of the slag, the lower being intended for discharge of matte or speiss, if either or both should be formed. His ideal furnace would have a hearth area of $8\frac{1}{2} \times 3\frac{1}{2}$ ft., with 11 tuyers, 5 on each side and 1 in the back wall, nozzles 4 in. diam., and inserted 10 in.

* W. S. Keyes, "Notes on Western Lead Smelting," Rep. State Mineralogist Calif., 1888.

above upper edge of hearth plate. Furnace to be 13 ft. high from centre of tuyers to feed door; and crucible 26 in. deep below edge of hearth plate. Blowers should be in engine room under supervision of engineer, and drawing air from outside through a brick conduit. As to wood charcoal, it is necessary to study the characteristics of different kinds before adoption: thus Keyes found the "mountain mahogany" charcoal crush to impalpable powder after combustion and actually put out the fire. He also instances an experiment in making aluminous slag when silicious flux was wanting, employing clay slate for the purpose with success.

Circular furnaces are giving way to oblong,* because their smelting capacity is limited by the diameter at the tuyers, which practice has fixed at 42 in. maximum, commonly 36 in. The oblong furnace at tuyer level is 86–120 in. long and 30–42 in. wide, the two figures for width representing the views of opposite schools, low pressure ($\frac{3}{4}$ –1 in. mercury) and high pressure (2–2½ in.) blasts. The strength of blast determines the height between tuyers and feed floor (12–18 ft.). A furnace 100 × 33 in. at the tuyers, with 5 tuyers ($\frac{3}{4}$ in.) on each side, and 12 ft. active height, at 1½ in. pressure, will smelt 60 tons of medium charge. It is an improvement to have the lead well enclosed by the crucible castings and not bolted to them; and cast-iron tuyer-boxes bolted to the jackets are superior to sheet-iron tuyer-pipes. Hofman believes in the possible "replacing of the water jackets wholly or in part by a suitable refractory material," as the cooling water consumes a large amount of heat, e.g. a furnace 36 by 92 in. at the tuyers, requires per minute 11 gal. water, the temperature of which becomes raised from say 60° to 160° F. The desired refractory material may prove to be coke-brick. The fuels used range from charcoal and coke to bituminous and anthracite coals. In America the long double hearth reverberatory 14–16 ft. wide is preferred, the ore from the roasting hearth falling vertically 22–24 in. on to the slagging hearth. As low as 10 per cent. ores are worked. A furnace 60 × 14 ft. will slag-roast 2–3 tons of charge per 24 hours. Recovery reaches 94 per cent. of the lead in poor ores, and 95 per cent. of the silver in almost all. Cost is approximately 8s. a ton for calcining, and 28s. a ton for smelting, assuming a furnace to take 48 tons ore per 24 hours, using 33 per cent. flux (16 tons at 12s.) and 18 per cent. fuel (coke at 48s., and 3 cords wood at 24s.), and labour, &c., amounting to 25*l.*

At Broken Hill, the charge consists of 51½ per cent. lead ore, 1½ iron ore, 47 silicious iron and kaolin, 18 coke, and 32 limestone. The limestone, broken to 4 in., and guaranteed 94 per cent. lime carbonate, is delivered at 18s. a ton. English coke is used, costing heavily and suffering much from handling. Total cost of smelting is about 32s. a ton, including 20s. for fuel, 7s. 6*d.* for fluxes, and 7s. for labour; and the grand total cost of mining, reduction, and realisation is about 3*l.* 14s. a ton.

The usual plan for preparing the smelting mixture is to lay down a large number of tons together with the proper fluxes, and to weigh

* H. O. Hofman, "Treatment of Argentiferous Lead Ores," Mineral Industry, i. 321; ii. 427.

out the charges at the feed door. Where the ores are of a different size and different character, it may be better to have the feeder weigh out directly the charge, or half charge of ore and fluxes, just before putting them into the furnace. This requires more labour, but is often sufficiently advantageous to warrant the increased expense.

All ores are either acid, basic, or neutral, the last so seldom that it may be left out. The principal constituents to be regarded in the matter of preparing admixtures for the formation of a proper slag are: (a) silica, representing the acid; (b) iron, lime, magnesia, and the alkalis. Alumina is sometimes present and acts either as a base or as an acid. It is usually considered as equivalent to silica and reckoned as such. Magnesia and baryta when present are reduced to lime in the ratio of their molecular weights, and entered in the calculations as calcium oxide: thus, $MgO \times 1.4$, $BaO \times .4$, and, by some smelters, $ZnO \times .7$. The alkalis being usually in small proportion, may be disregarded or allowed for amongst the bases. In order to calculate the constituents of a slag at all, it is necessary to have full and complete analyses of the ore and fluxes. Knowing the composition of both the ores and fluxes, the head smelter can proceed to the combination of a slag which will meet, not only the metallurgical, but the economical conditions of his locality. The principal slags are the following:—

(a) Sub-silicates, where the oxygen of the base is to the oxygen of the silica, the acid, as 2 to 1; chemical formula, $4Ro, SiO_2$.

(b) Singulo-silicates, in which the oxygen of the base is to the oxygen of the acid, the silica, as 1 to 1; chemical formula, $2 Ro, SiO_2$.

(c) Bi-silicates, in which the oxygen of the base is to the oxygen of the silica, the acid, as 1 to 2; chemical formula, $RoSiO_2$.

In practice these slags are mingled both mechanically and chemically in various proportions, and of such admixtures the following 5 are of common occurrence:*

(a) 1 mono-silicate of iron plus 5 bi-silicates of lime; chemical formula, $(2FeO, SiO_2) + 5(CaOSiO_2)$; percentage—46 SiO_2 , 18 FeO , 36 CaO . Such a composition is advisable when iron is scarce and silicious ore plentiful.

(b) 1 mono-silicate of iron, 1 bi-silicate of iron, with 2 mono-silicates of lime; chemical formula, $\{2FeO, SiO_2, FeOSiO_2\} + 2(2CaO, SiO_2)$; percentage— $35\frac{1}{4} SiO_2$, $31\frac{1}{4} FeO$, 33 CaO .

(c) 1 mono-silicate of iron plus 1 mono-silicate of lime; chemical formula, $2FeO, SiO_2 + 2CaO, SiO_2$; percentage—32 SiO_2 , $38\frac{1}{4} FeO$, $29\frac{3}{4} CaO$.

(d) 1 mono-silicate of iron, 1 bi-silicate of iron, and 1 mono-silicate of lime; chemical formula, $\{2FeO, SiO_2, FeOSiO_2\} + 2CaO, SiO_2$; percentage— $35\frac{1}{2} SiO_2$, $42\frac{1}{2} FeO$, 22 CaO ; this is, as a rule, the best type or the common run of ores.

(e) 3 bi-silicate of iron, 1 bi-silicate of lime, plus 3 mono-silicate of iron and 1 mono-silicate of lime; chemical formula, $3FeOSiO_2, CaOSiO_2 + 3(2FeO, SiO_2), 2CaO, SiO_2$; percentage—37 SiO_2 , 50 FeO , 13 CaO ; this was first extensively used by A. Eilers, and is particu-

* Rep. State Mineralogist Calif., 1890, p. 829.

larly to be commended when the ore is of a highly ferruginous nature (as it requires little quartz and lime), also for use when zinc-bearing ores are to be reduced. In all these slags some allowance has to be made for the alkalis. Slags rich in lime will carry and neutralise a greater percentage of silica than those of iron, without taking up too much oxide of lead. Basic slags cause overfire or flaming at the throat, and have a tendency to corrode the brickwork of the furnace, and to cause loss of metal owing to the rapidity and ease of their formation. A too acid slag, on the contrary, retards the fusibility of the furnace mixtures, and hence the furnace runs too slow. The ore, as received, of course contains moisture, and in calculating the charge it is necessary to make the proper modification, for the reason that the ore and flux analysis is based upon a steam-dried material. It is further to be observed that 31·05 iron requires 34 silica (SiO_2) for its neutralisation, and that 16 sulphur requires 28 metallic iron. Having the analyses of the ore, flux and fuel, the metallurgist can proceed to calculate the percentages required either to supply what is lacking in the ore, or to render harmless an excess of acid or sulphur; it becomes simply a question of mathematical proportion. As to the amounts of lead and silver in the respective charges, the smelter must be governed by circumstances and his practical experience. About 100 oz. silver to the ton of lead appears to be the most desirable proportion to "cover" the silver and prevent loss.

The conditions laid down by Collins* are somewhat different. He insists that:—(a) the slags must never average above 40 per cent. SiO_2 , and, if fluxing ores are available, especially those with large iron excess, it is better to aim at a slag with only 32 per cent. SiO_2 ; (b) the amount of lead in the charge should be such as to yield 10 per cent. of the weight of the latter as lead bullion, irrespective of the small amount contained in the matte; (c) the bullion should not run much above 300 oz. silver per ton. Special cases often arise in which it becomes necessary to use for a time slags of 42 per cent. SiO_2 , or to work with a bullion-yield of only 8 per cent., or to produce bullion of upwards of 400 oz. per ton; but such conditions are always detrimental.

The basis of calculations for slags is that the most fusible of all iron silicates is the mono-silicate ($2\text{FeO}, \text{SiO}_2$), or 70 per cent. ferrous oxide and 30 silica; and though the most fusible of the calcium silicates is the bisilicate (CaO, SiO_2), or 53 per cent. silica and 47 lime, yet the mono-silicate is preferable because the extra lime helps carry off sulphur as calcium sulphide in the slags. Therefore, all the iron is calculated as $2\text{FeO}, \text{SiO}_2$, and all the lime as $2\text{CaO}, \text{SiO}_2$; excess of silica being reckoned separately, and neutralised with limestone, unless argentiferous iron ore can be got.

In valuing an ore for smelting its composition has to be carefully considered. The presence of over 5 per cent. zinc in sulphuretted ores and over 10 per cent. in oxidised, entails a reduction of about 2s. a unit for all excess per ton. For barytes beyond 10 per cent., a charge of 7–8*d.* a unit is made. When the ores are calcareous or highly charged with iron oxide, a reduction is often made in the

* H. F. Collins, op. cit.

charge for smelting. As regards the lead, some smelters require a certain minimum, and an extra charge is made for each unit of lead below such minimum. It is usual to deduct 5 per cent. for loss of silver in ore, but if the ores are dry or silicious, a still further deduction is made, often as high as 10 per cent. for 100 oz. ore, and less for the higher grades. The usual charge for smelting dry ores in Colorado is 2*l.* 10*s.*–3*l.* and even 5*l.* a ton. Gold beyond $\frac{1}{10}$ oz. is paid for at 95 per cent. When lead goes less than 5–10 per cent. no payment is made for it. Excess of silica is charged at 5*d.* per unit. Copper is not paid for in lead ores nor lead in copper ores.

Purification.—Lead as delivered by the various smelting processes contains generally, in addition to silver, some proportion of antimony, arsenic, copper, iron and zinc, which may be in such amount as to interfere with recovery of the silver. The first step therefore is their more or less perfect removal, by which the lead is “softened” or “improved.” The operation consists in melting the crude lead (“work lead” or “base bullion”) and exposing it to the oxidising influence of the atmosphere until all impurities have been removed as scum, and a pure lead-silver alloy remains behind. The apparatus required consists in a melting pot and an oxidising pan, both made of cast iron. The oxidising pan is generally 10–12 ft. long, 5–6 ft. wide, and about 10 in. deep, and will hold 12–13 tons of lead. At one end is a tap-hole through which the purified lead-silver alloy is drawn off. The time required for complete purification depends upon the proportion of metallic impurities in the lead, and consequently varies. At the temperature when lead melts (626° F.), the copper, iron and zinc will readily separate and float on the surface as a pasty mass. Antimony and arsenic require a higher degree of heat, and sometimes the application of a blast to cause them to oxidise or volatilise. The heat must not be increased unnecessarily, as in proportion to it is the loss of lead. The dross has to be skimmed off frequently to permit free access of air to the surface of the metal. To assist in the separation of mechanical impurities, wood shavings, dry leaves, or brush wood are mixed with the lead by stirring, when a development of gases takes place which causes them to rise to the surface.

Liquation is sometimes used either by itself or supplementary to the operation just described. It is conducted in a reverberatory furnace, the bed of which slopes steeply from the fire bridge to the flue end, where it ends in a gutter leading to the lead pot. The base bullion to be softened is piled on the highest part and exposed to a temperature near the melting point of lead, when that metal will gradually separate and run down the incline into the lead pot, while the metallic admixtures, having a higher smelting point, are left behind.

Desilverisation is effected by cupelling (rapid oxidation of the lead without affecting the silver), by crystallisation (Pattinson’s process), and by the action of zinc (Parkes’ process).

The English cupelling furnace is a reverberatory with movable bottom, Fig. 152. The frame, of iron, and strongly bound by $4\frac{1}{2}$ in. \times $\frac{1}{2}$ in. iron bands, is about 4 ft. wide in front, 3 ft. in rear, and $5\frac{1}{2}$ –6 in. deep, and is filled with moistened bone ash firmly pressed in,

after which a cavity is scooped out, leaving a lining 2 in. thick at the rim, increasing to 3 in. at the bottom. Into the front end, 3 holes are drilled, to serve in succession as outlets for the litharge during the operation. After the first one of these has become too much corroded to be any longer serviceable, it is closed, and one of the remaining two is opened. A fire bridge *a* 14–18 in. high separates the test *b* from the fireplace *c*; the fumes and products of combustion escape through two openings *d* into the main flue *k*. To prevent the test from cracking, it is necessary to heat it gradually and cautiously to a bright red, when part of the charge, previously melted in the iron pot *e*, is introduced through the gutter *f*. At first the metal becomes covered with a grey dross, which melts when the temperature increases; then the blast is turned on through the nozzle *g*, and forces the litharge towards the front, where it escapes and falls into a shallow cast-iron pot running on wheels. Fuel is added through the door *h*, while the one at *i* is used for watching the operation. A flue carries off the fumes collected by a hood. In cases where the lead is introduced into the test without previous melting, openings are provided in the back wall near the tuyer through which the pigs may be charged. In proportion as the metal in the test diminishes, fresh lead is added. When the charge has become sufficiently enriched to render its transfer to the refining furnace desirable, a hole is drilled into the bottom of the test and the alloy is tapped into a pot placed on wheels, after which the hole is plugged up and a new charge is introduced. The final refining is conducted in a furnace of similar construction, in which the enriched alloy is treated as above until the last traces of lead have become oxidised, and the brightening of the silver indicates the termination of the process; then the blast is turned off, the fire is raked out, the silver button is allowed to set, and the frame containing it is lowered into a small car and wheeled away to cool off. About 4–5 cwt. bullion per hour are thus refined, with a loss of 7 per cent., and a fuel consumption of 6–7 cwt. coal per ton of lead.

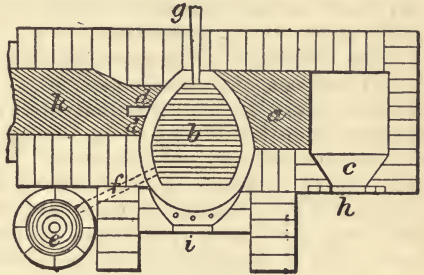

FIG. 156.—ENGLISH CUPEL.

In America, the English cupel is in universal use, but has undergone changes in construction and manner of operating. The test has been in some cases increased to 6 ft. by 3 ft. 8 in.; the original wrought-iron hoop has been in many instances replaced by a cast-iron ring, or, if wrought-iron has been retained, either water-cooled coils have been added to counteract the corrosion of the litharge, or the ring has been replaced on 3 sides by wrought-iron jackets and at the front by cast-iron jackets of different constructions. The support of the test has in many cases been made so that during the process it

can be moved up and down and sideways. The filling material has been replaced by a limestone-clay mixture, by pure cement, or by a mixture of coarsely ground firebrick and cement. The working is now generally divided into two operations: concentrating the retort-bullion to 60-80 per cent. silver in one furnace, and finishing the operation, including the fining of the silver, in another. By this means the concentration in water-jacketed tests, an easy operation, has been made continuous; the finishing, requiring special skill, being done only at intervals.

The Pattinson process is based on the fact that when argentiferous lead is cooled from a molten condition with constant agitation, the lead has a tendency to separate in crystals from the silver, which latter thus enriches the portion remaining fluid. The plant employed in the operation consists of a series (10-12) of iron pots, about $5\frac{1}{2}$ ft. diam. by $2\frac{1}{2}$ ft. deep. At one end of the row is a pot having about two-thirds the capacity of the others, called the "market pot." Each pot is provided with a separate fireplace, and heated by a circular flue ending in a main flue running under the level of the floor parallel with the line of pots. Each pot holds 6-10 tons of bullion, the charging being done by cranes. Supposing the lead about to be desilverised to contain 20 oz. silver per ton, the bullion is placed in pot No. 6, where it is melted; the "pot dross," or covering of oxide which forms on it, is skimmed off, and the fire is withdrawn. To assist the cooling, water is sprinkled on the lead, and while the temperature is gradually decreasing, it is constantly stirred with an iron rod, thus causing the formation of crystals. These are removed with a perforated ladle and allowed to drain into the pot whence they have been taken, after which they are placed in pot No. 5. This is continued until $\frac{7}{8}$, $\frac{3}{4}$, or $\frac{2}{3}$ of the contents of pot No. 6 have been transferred to No. 5, according to whether the method adopted is by eighths, quarters, or thirds. The lead remaining in No. 6 will contain about 40 oz. silver per ton, and is ladled into pot No. 7, while the crystals, transferred to No. 5, will only contain about 10 oz. A fresh charge of lead being worked in No. 6, the crystals are again passed to No. 5 and the enriched "bottoms" to No. 7. Each pot, as it becomes filled by crystals from the one side or by bottoms from the other, is in its turn crystallised. In this way the crystals, as they approach the market pot, become gradually poorer in silver, while the pot bottoms, passing in the contrary direction, increase in richness. The various pots in the series may, from time to time, receive lead yielding the same amount of silver as the metal which they severally contain. During these operations a quantity of oxide is produced, and when the charge in each pot is melted down, it is always carefully skimmed before cooling. The amount of dross from working lead containing 20 oz. silver per ton may be estimated at 25 per cent. of its weight. The enrichment attains its limit when 700 oz. per ton are reached, and further concentration by these means becomes impossible. The lead in the market pot should not contain more than $\frac{1}{2}$ oz. silver per ton.

Modifications of Pattinson's process are the Laveissière, in which the stirring is effected by wheels instead of by men wielding iron

rods; and the Marseilles, which relies on steam blown in for agitating purposes.

Pattinson's process cannot generally compete with the zinc method, but it has survived at Freiberg in consequence of certain special peculiarities in the lead there smelted: (a) it contains too much copper, nickel, cobalt, tin, antimony, arsenic, and bismuth to be fit for the zinc process without preliminary liquation and softening; (b) the silver contents being mostly large (60–120 oz. per ton), the concentration for the refinery is nearly as rapidly effected by one method as by the other; (c) production of flake litharge, for which there is considerable commercial demand, is notably diminished when zinc is used; (d) the recovery of bismuth from the lead, which is one of the profitable operations of the works, can only be effected by the older process. A combination of the two methods has been developed which presents notable advantages over crystallising alone. Lead containing 33 oz. of silver and upwards, after previous liquation and softening when necessary, is crystallised by the method of thirds into rich and poor portions, the former with 650 oz. going to the refinery, while the latter, containing at most 33 oz., and practically freed from bismuth, is finally desilverised by zinc. This is generally effected by three additions, each of which occupies about 5 hours, and as a similar time is required for melting down and cleaning the surface of the lead, the total period of working one charge is about 20 hours. The charge, consisting of 20 tons, of lead requires about 4 cwt. or 1 per cent. of its weight of zinc for complete desilverisation; 220 lb. being used in the first addition, 165 lb. in the second, and 88 lb. in the third. About one-half of this quantity is subsequently recovered in the distillation of the rich lead-zinc and silver alloy. The zinc removed after the first addition is sufficiently rich for the liquation pot; but that of the second and third additions is put aside to be used in subsequent operations with fresh quantities of lead. By liquation, the former product is divided into rich scum for distillation, and argentiferous zinc-lead, which, together with the poorer zinc skimmings, is returned to the desilverising process. The removal of the zinc from the desilverised lead is effected in the softening furnace at a red heat, oxidation being achieved either by a blast of air or by the chimney draught alone. The crust first formed on the surface, consisting of zinc and lead oxides, must be drawn with a rabble, but the proportion of the latter gradually increases until pure litharge is produced. The refining operation lasts 9 hours; the proportion of zinc in the lead diminishes from .75 per cent. at starting to .16 per cent. in 3 hours, .01 in 5 hours, .0008 in 7 hours, and .0002 in 9 hours. The latter quantity corresponds to 1.3 dwt. per ton. When the refining is finished, the softened lead is tapped into a cast-iron pot, from which, after skimming the final dross, it is cast into moulds for sale. The rich scum in which the precious metals are concentrated contains in addition to 4.05 per cent. silver, and .0153 per cent. gold, 53 per cent. lead, 40 zinc, and somewhat more than $2\frac{1}{2}$ copper. The zinc is removed by distillation in a plumbago crucible with a domed head and lateral discharge pipe. The condenser is a cast-iron box about 20 in. high, of rectangular horizontal section, diminishing upwards, the capacity

being about $\frac{7}{8}$ cub. ft. About $4\frac{1}{2}$ cwt. of the alloy with 1 per cent charcoal powder is charged upon a layer of lumps of charcoal placed at the bottom of the crucible. When the latter is filled, the dome is luted with clay, and the space inside is packed with a further quantity of alloy introduced through the hole upon which the discharge pipe is finally adjusted. The crucible is placed on a square wind furnace heated with coke, which requires to be twice filled with fresh fuel during the period of distillation, lasting 8-9 hours. When completed the zinc is collected in a lump of the shape of the condenser, while the lead remains in the crucible, covered by the unconsumed charcoal and any unreduced dross. This, when cleaned by skimming with a colander, is ladled out and passed to the refinery. The cost of working lead with 300 oz. silver per ton by the combined process is about 13s. per ton, or about 18 per cent. less than by the simple Pattinson process. With poorer lead (150 oz. to the ton) the saving is larger and amounts to about $21\frac{1}{2}$ per cent.; moreover the precious metals are rather more completely recovered.

The zinc process (invented by Parkes, but since modified in many ways) is based on the observation that when molten zinc-lead is cooled slowly, the zinc solidifies first in a crust and carries nearly all the silver with it. In operation, the silver-lead is melted in a cast-iron kettle, 3- $3\frac{1}{2}$ ft. deep, and of a diameter to hold the contents (15-30 tons); some American kettles hold up to 50 tons, but in that case they are oblong with rounded ends. Heat is raised till zinc fuses in the bath. The latter metal is added in 3 successive portions of $\frac{2}{3}$, $\frac{1}{4}$, and $\frac{1}{2}$. After the first addition the fire is kept up and the mass is well stirred with a perforated ladle for $\frac{1}{2}$ hour, when the fire is reduced, and the kettle is allowed to cool. When the zinc crust is firm enough it is removed with all particles adhering to the sides of the kettle, and the surface is skimmed till the lead commences to crystallise, when the heating is renewed, and the second instalment of zinc is added, stirring and skimming being repeated as before. Finally, the third and last quantum of zinc goes in, and the treatment is concluded. The quantity of zinc is proportioned to the silver in the base bullion, thus:—

9 oz. silver per ton require	$1\frac{1}{4}$ per cent. zinc. ;
18	$1\frac{1}{3}$ "
36	$1\frac{1}{2}$ "
54	$1\frac{2}{3}$ "
108	2 "
144	$2\frac{1}{4}$ "

A percentage of lead accompanies the silver in the zinc crust; this is recovered by liquation in two iron pots, one of which is placed higher than the other and is connected with it by a pipe cast on its bottom. The zinc skimmings are strongly heated in the upper pot, and the liquated lead flows into the lower one through the pipe, while the argentiferous zinc remains behind. The lead carries with it part of the silver and zinc, which, after cooling, is skimmed off. The liquated and purified lead is put with the original metal before the last addition of zinc.

The output of metal by the Parkes process is good: silver, not

under $99\frac{1}{2}$ per cent.; gold, 98–100 per cent.; lead, $99\text{--}99\frac{1}{2}$ per cent. The cost of operating in America is about 20–25s. per ton of base bullion. At Broken Hill the cost is 35–40s. per ton of bullion, and the working losses amount to 4 per cent. lead and 2 oz. silver per ton of bullion. Practically all the gold, 3·4 dwt. per ton of bullion, is caught.

Flach's modification is conducted in 3 cast-iron pots, set in brick-work at a convenient height above the floor, and heated by separate fireplaces; 2 hold about 6 tons each, while the third has a capacity of 20 tons. Desilverising is conducted in the larger pot, and the argentiferous zinc crust is removed to one of the smaller pots by means of perforated ladles. When one pot has become full, it is subjected to liquation, and the other one serves as a receptacle for the skimmings. The liquated lead is added to the metal in the desilverising pot at the same period as in the former case. The argentiferous alloy is in both cases smelted in a blast furnace to separate the last particles of lead, which is finally cupelled. The lead remaining in the larger vessel is ladled into the pan of an improving furnace, and kept at a red heat for about 12 hours, during which it is frequently skimmed; at the expiration of this period it is cast in moulds, and forms market lead.

In Cordurié's method the lead is brought to a red heat, and superheated steam is forced through it, when the oxygen contained in the latter causes the zinc to oxidise, while the lead is but slightly affected; the zinc oxide rises to the surface and is skimmed off. The zinc-silver alloy may be treated in the same way, when the zinc will oxidise and separate from the argentiferous lead alloy. The latter is finally cupelled to obtain pure silver and litharge.

By another way, the alloy is kept at a moderate temperature under a cover of chloride of lead for about 24 hours and continually stirred, when the metallic zinc is converted into zinc chloride and the lead chloride into metallic lead.

Schnabel's process consists in the digestion of the argentiferous zinc and lead oxides with a hot solution of carbonate of ammonia under pressure in gas-tight vessels. The zinc oxide dissolves and is converted into zinc carbonate, and a silver-lead alloy is obtained in a suitable state for refining. The ammoniacal solution is distilled to recover ammonia, and the basic zinc carbonate is converted by calcination into the oxide, which is used as paint.

Balbach and Faber du Faur employ a retort furnace as shown in Fig. 153: *a*, fireplace; *b*, grate; *c*, fuel door; *d*, retort; *e*, flue. It is fired with charcoal or coke, and when the retort is red-hot the charge is introduced, consisting of a mixture of finely broken zinc crust and charcoal smalls, and varying according to the size of the furnace from 250 to 400 lb. zinc crust, and 3 to 5 lb. charcoal. Then a condenser is placed over the mouth of the retort, and the temperature is at once raised to white heat. Should it be neglected to maintain this high temperature uniformly, a crust of chilled alloy will form on the metal, under which zinc fumes accumulate, causing an explosion if the temperature is once more raised. The metallic zinc collects in the condenser, from whence it is from time to time removed, remelted,

and cast into thin plates, to be used again in desilverising. In this way 60–80 per cent. of the zinc is recovered, 40–50 per cent. in the metallic state, and 20–30 per cent. as oxide. The latter collects around the mouth of the condenser; it is scraped off, packed into suitable

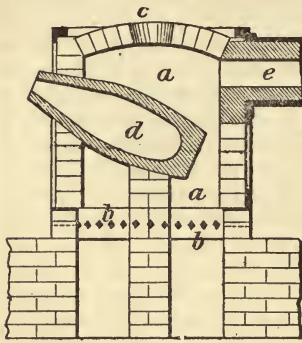

FIG. 157.—REFINING RETORT.

vessels, and taken to zinc works for reduction. The argentiferous lead remaining in the retort is tapped off, cast into thin plates, and cupelled in an English furnace. The entire operation requires 8–10 hours, according to the percentage of zinc in the alloy. This furnace has found most favour among zinc distillers, because it is easy to keep at a uniformly high heat, and the retort can be quickly emptied, cleaned and refilled for a fresh operation, and endures longer. In America the size has been increased up to 1000 lb.

In the Rössler-Edelmann process operated at Hoboken, near Antwerp, the addition of a little aluminium to the zinc produces a rich zinc-silver crust, free from lead, and avoids production of bulky scums. An alloy of .5 per cent. aluminium with the zinc does not oxidise at desilverising temperature; thus desilverisation is made possible at one operation, without much stirring, and with much less zinc. In practice, the zinc-aluminium alloy, previously prepared, is thrown upon the lead bath, when the latter has acquired the necessary temperature, varying with the contents in silver, but about 750°–900° F. Then the whole is stirred and allowed to cool, whereupon the molten lead, which at the low temperature is no longer capable of holding the zinc, gives it up again. The free zinc, having in the meanwhile taken up the silver, rises to the surface of the bath, whence it, together with some lead, is ladled off. In order to get rid of the excess of lead, the alloy is charged into a cast-iron pot with an outlet at the bottom, and slowly heated, liquating and drawing off the greater part. Subsequently the temperature is raised to red-heat, for melting the zinc-silver alloy, as well as for separating it from the remainder of lead present, the former floating on top of the latter, whence it is ladled, care being taken not to touch the lead underneath, which is drawn off afterwards. The zinc-silver alloy consists of 20–40 per cent. silver, according to the richness of the silver-lead treated, 5 per cent. lead, 2–4 per cent. copper, and 60–70 per cent. zinc. It amounts to about 2 per cent. of the silver-lead treated, while by the old process about 15 per cent. zinc scum, consisting of 4–6 per cent. silver, 70–80 per cent. lead, .5 per cent. copper and 10 per cent. zinc was produced. For working up the zinc-silver alloy there are two ways. The first is to treat the granulated alloy by hydrochloric or dilute sulphuric acid, whereby the zinc is got as a salt, and the silver in the shape of slime. The second way is by electrolysis, whereby the spelter is obtained as a metal of high purity, consisting of .0099–.0044 per cent. iron, .0114–.0210 per cent. copper, .0341–.0500 per cent. lead

from a trace to .0020 per cent. silver, and 99.9446–99.9226 per cent. zinc. This metal, of course, commands a much higher price than that of ordinary spelter, the gain nearly covering the cost of electrolysis. The electrolyte consists of a solution of zinc chloride in magnesium chloride. Its sp. gr. is about 1.2 to 1.27. The cathodes are vertical circular sheets of metallic zinc fixed upon a horizontal spindle, the latter revolving just above the surface of the bath. The spelter is thereby obtained in sheets. The residue of the anodes, got in the shape of slime, after the electrolytic extraction of the zinc, contains about 75 per cent. silver and 12 per cent. lead. A small quantity of chloride of silver is also formed. The oxides of copper, zinc and iron are dissolved in very dilute H_2SO_4 , while the chloride of silver is reduced at the same time to the metallic state by iron shavings. The silver slime now contains nearly 15 per cent. lead, some copper, and 80–85 per cent. silver. It is smelted upon a cupel, whereby the remainder of the lead is oxidised and separated as litharge. About 450 lb. silver slime are refined in 8 hours, and it is possible to refine 3 charges in 24 hours. Cupellation is done away with, and with it the reviving of litharge and other bye-products. In lieu of it there is only the short refining process on the cupel. As there is only a very small quantity of litharge produced, practically the whole of the silver-lead is worked at once into refined lead, so that no subsequent desilverisation of the revived bullion, as hitherto, is required.

Utilising Heat of Slag.—Careful measurements* at Broken Hill, with a view of determining the true values of the heat wasted in the slags, show that, although a comparatively small proportion only of the total heat produced by the combustion of the coke supplied to the furnaces is contained in the slags (the remainder being found in the chemical reactions of the ores and fluxes in the furnace or passing up the flues with the gases), the amount is still large enough to be of considerable importance, and its utilisation for steaming purposes capable of effecting an important economy. The following are the principal data determined by the measurements: sp. gr., 3.8; temperature of exit from furnace (average), 2000° F.; specific heat, 25; latent heat per lb. (probably), 120 heat-units; total heat per lb., 620 heat-units; average output of slag from one furnace, 112 in. by 60 in., 4400 lb. per hour; theoretical mechanical equivalent of slag from one furnace, 1064 h.p. As in the case of steam production from the combustion of coal, only a small portion of this waste power can, by any known method, be utilised for mechanical work. Direct contact methods were discarded on trial for a method of imparting the heat to the water through the medium of a metallic casing, the practical result being that with a comparatively small and inexpensive boiler, the whole output of slag from one 112 × 60 in. silver-lead furnace can be readily utilised, with a production of over 60 h.p.

Furnace Bye-Products.—(a) The term “speiss” is applied to substance consisting essentially of iron in combination with antimony or arsenic, containing besides varying proportions of valuable metals, as well as some sulphur, lime, silica, copper, lead, molybdenum, zinc, &c.

* J. Howell and E. A. Ashcroft, Trans. Austr. Inst. Min. Engs.

A practical attempt to utilise speiss at the Richmond works, Nevada consisted in tapping the molten speiss into pots having a lining of clay and limestone, and at the same time adding a sufficiency of lead or litharge to collect the precious metals. The carbonic acid set free by the heat of the molten speiss serves to keep the contents of the pot in ebullition, so that the lead gradually sinks to the bottom of the vessel, carrying the precious metals with it. As a result, there was extracted about 67 per cent. of the value. This process was improved upon by L. W. Davies, who adds about 25 per cent. molten lead to the molten speiss, in a metal converter under an air pressure of 17 lb. The converter is cylindrical, and has a lining of $2\frac{1}{2}$ in. of firebrick. The economic results obtained have been favourable; the percentage of silver extracted is reported at 83.50, and of gold 89.28.

(b) "Matte" is chiefly compounded of iron and sulphur, some lead, copper, gold, and silver being also usually entrapped in it. It is re-roasted (to remove sulphur) and re-smelted, the copper becoming concentrated thereby and carrying the precious metals.

(c) "Slag" contains the gangue and waste matters of the ores and fluxes, and should not afford more than 1 per cent. lead or 1 oz. silver per ton. Rich slags are re-smelted. At most works, each potful of slag is separately hand-picked. As soon as the pot is cool, its contents are deposited on the surface of the dump, where, when quite cold, the cone is broken up and carefully examined for a cake of matte, which is generally found at the point of almost every cone, in addition to which there is often a smaller cake of speiss below the matte, and sometimes a button of lead at the extreme point of the cone. The matte contains practically all the copper contents of the original ore besides a considerable amount of silver; but the speiss is generally very poor in precious metals, and is generally thrown away.

A very small quantity of zinc renders both the matte and slag so pasty that perfect separation is impossible; in that case, each potful of slag is allowed to cool for 10 minutes after being filled, or until a solid "shell" has been formed $\frac{3}{4}$ -1 in. thick all round against the iron; the still liquid interior is then poured, either by pricking the top crust or by piercing a clay plug in the bottom. Practically all the suspended globules of matte collect in the "shell," which weighs 10 per cent. of the whole potful; this is re-smelted.

At Leadville, Colorado, a separate furnace is employed for re-smelting * slag, being, in the case described, merely an old 36 by 80 in. lead-furnace, having its crucible filled with well-tamped sand covered by a course of firebricks. The rich slag averaged 5.3 oz. silver per ton, and 3107 tons were smelted in one month, together with 402 tons pyritous copper ores averaging 10 per cent. copper and 11 oz. silver per ton. The matte produced averaged 20 per cent. copper and 93.3 oz. silver per ton, while the clean slag averaged only $\frac{3}{4}$ oz. per ton; the loss of copper was insignificant, averaging only $\frac{1}{2}$ per cent. or less. The fuel-consumption was 1 to 10 of charge (as against 1 to 5 for the original ore-smelting), and the total expense per ton of material smelted was only 6s.

Flue dust and Fume.—Flue dust consists essentially of fine particles

* H. A. Keller, Trans. Amer. Inst. Min. Engs., 1892.

of ore and fuel carried over by the blast, while fume is lead oxide and sulphate deposited on cooling. The two are of necessity intimately mixed and must be dealt with together. The material often aggregates $2\frac{1}{2}$ –3 per cent. of the dry ore charged. Its composition is never definite. While containing much partially oxidised lead, there are sure to be also many impurities, notably zinc, arsenic, and antimony. The essential element of condensation or collection of the fume is a very long flue, in the construction of which it is well to make provision for retardation of the current of gases through it on their way to the chimney. Such provision may be made by giving a large capacity to the flue; by giving it an angular or zigzag course; by interpolating large chambers, which are best placed at the far end of the flue, or at zigzags in its course; by introducing baulks or mid-feathers here and there, against which the current may impinge; or by hanging within the flue such things as iron hooping, bushes, old nets, &c., upon which the solid matters may be deposited. These various contrivances are adopted at different works. But while the solid element of the fume can be arrested in this way, long flues have no influence in arresting the escape of sulphurous acid from the chimney, and ordinary modes of washing with water fail to remove more than a moderate proportion of it. This sulphurous acid creates a serious nuisance, and its escape unutilised is a considerable loss. By Wilson and French's method, the cooled furnace gases are forced through water in such a way that the water and fume are brought into very close contact and thoroughly mixed; the solid element is thus effectually wetted and retained in the water, and the soluble gases are, as far as the dissolving power of the water permits, dissolved. The solid matters have to go back to the smelting furnace, but are always troublesome to treat. Moistening is only a temporary expedient for making it cake into a solid form. A better procedure is to mould it into bricks with milk of lime; or, better still, if obtainable at a moderate price, to bind it together with a solution of iron sulphate. When thus compacted, it may be added to the charge and treated as ore.*

New Processes for Zinc-Lead Sulphides.—The flue dust and fume difficulty is enormously increased in the case of zinc-lead sulphide ores, which are daily becoming of more importance as the mines reach greater depths and the (more or less) oxidised surface ores are exhausted. Enormous quantities of such ores are now exposed, and contain notable proportions of the precious metals, but cannot find a ready market, because their zinc contents occasion great loss and inconvenience in ordinary smelting operations: if it be attempted to flux off the zinc, volatile metal rises to the throat of the stack and is there oxidised, forming hard, infusible lumps, and compelling frequent stoppages, while the great heat necessitated in the lower part of the furnace involves considerable loss of lead and silver by volatilisation; if the mixed ore be smelted for zinc, the associated lead forms a fusible compound with the silicious materials of the retorts, and precludes successful results. Something may be done by mechanical separation of the two ores, blende and galena, as already described (p. 521); but

* See T. Egleston, "Collecting Flue-dust at Ems," Trans. Amer. Inst. Min. Engs., 1883.

when both are argentiferous and fine grained, such a method is impracticable. Modified smelting, and chemical treatment (wet) in several forms have attained some success.

(a) In the Lewis-Bartlett process,* the smelting aims directly at causing volatilisation of the zinc, special means being adopted for catching the zinc oxide and lead sulphate fumes, while the residual matte and slag contain the iron, some lead, and most of the silver and are fit for charging the ordinary smelting furnace. The collected fumes are sold as white pigment.

At the works of the Picher Lead Co., Joplin, Missouri, the process has long been used on rich galena. The ore is first roasted in a modified Scotch hearth (called a Jumbo or Moffet), producing in pig-lead about 60 per cent. of the lead in the ore, and a large quantity of lead slag and lead fumes. The Jumbo or Moffet ore hearth has a hollow cast-iron back perforated with 5 or 6 holes, the single back serving for both sides of the furnace. The lower part is a dam of cast iron, which reaches to the bottom of the basin, except where it is cut away at one corner, to allow the metal to be drawn off from one side. Being hollow, this dam is always filled with molten metal. The air supplied to this hollow back is made to pass through the side walls of the hearth, in order to heat it. The basin is only 8 in. deep, and the lead running out of the overflow is drawn from the bottom of the bath by a tapping pipe reaching nearly to the bottom of the basin. The ore is fed on to the hearth, mixed with coal and lime: to 1 ton of ore, $\frac{1}{4}$ cwt. lime and 1 cwt. coal. The blast is supplied by a Baker blower, and as the lead is melted it runs over into a receiver, from which it is cast into pigs, which are afterwards desilverised. The peculiarity of this process is that it makes comparatively little difference whether the lead is obtained in this or in a subsequent operation. A hot and strong blast can therefore be used, and labour is greatly economised; 4 men, 2 on each side, can smelt 7 tons of ore in 8 hours; or 12 men, working 3 shifts, can put through 21 tons in 24 hours. An additional man can bring all the coal and lime required. By the Scotch hearth, a similar yield would have required 32 men. Less skilled men may be employed. The slag and fumes, together with considerable second-grade ore, are treated in the pigment furnaces, water-jacketed low cupola blast furnaces. The charge produces in these furnaces a portion of metallic lead, and a large quantity of lead sulphate volatilises. The vapours are oxidised, and drawn by a fan through conducting pipes into bag condensers. This sublimed white lead consists mainly of an amorphous sulphate and oxide of lead incidentally containing 4-5 per cent. zinc oxide. The production of this material grew from $3\frac{1}{2}$ million lb. in 1890 to 8 million in 1893.

The process has lately been established at Cañon City, Colorado, on argentiferous zinc-lead sulphides, carrying 2-30 per cent. lead, 12-28 zinc, 10-38 iron, 0-10 copper, 5-38 silica, and 4-29 oz. silver.

* Prof. W. Ramsay, "Lewis-Bartlett Process of Lead Smelting," *Industries*; E. W. Hawker, "The F. L. Bartlett Zinc-Lead Process;" F. P. Dewey, "Lewis-Bartlett Bag Process for catching Lead Fumes," *Trans. Amer. Inst. Min. Engs.*, xviii. 674.

The requisites for success are:—(1) Cheap flaming fuel—e. g. bituminous coal; (2) iron ore either as oxide or pyrites, the latter being especially desirable if it contains silver; (3) copper ore containing about 3 per cent. copper for the formation of copper matte to collect the silver.

Ores containing 25 per cent. zinc and over are crushed to pass a 4-mesh screen, and mixed by an Archimedian screw with an equal bulk of fine coal. The mixture is moistened and charged in lots of 600 lb. into a furnace, of which the grate consists of perforated plates, the charge being spread on the grate in a layer about 4 in. deep. Air is forced through the charge from below at a pressure of about 2 oz. per sq. in., and a sufficient quantity of air is also forced through openings in the sides of the furnace above the layer of the ore to prevent the formation of sulphuric acid with the hydrocarbon vapour. The burning is completed in about $4\frac{1}{2}$ hours, when the charge, which has not been touched during the operation, is in the form of a sintered mass, ready to go to the blast furnace, containing the silver and other non-volatile metals and some zinc. All the lead, and most of the zinc, is volatilised, and collected in the form of fume, out of which the pigment is made. Iron pyrites, when necessary for a flux, is charged into a somewhat similar furnace and treated in a similar manner, except that only enough slack coal is used to start the pyrites burning, their sulphur contents being sufficient to supply the requisite fuel heat, while a higher blast (4 oz. per sq. in.) is used, the burning being completed in $\frac{3}{4}$ -1 hour. Sinter from the zinc ore is mixed with the burned pyrite, copper ore, fluxes, and fuel in the requisite proportions, and is smelted at a high temperature in a water-jacketed furnace of a greater proportional length than that of the ordinary blast furnace. Most of the zinc left in the charge passes off in the form of a fume, which is saved, while the copper matte which collects the silver runs into an outside crucible with the slag, and is tapped from time to time.

Ores containing about 22 per cent. zinc or less are smelted directly in a special furnace with the proper mixture of copper ore, fluxes, and fuel. This furnace is water-jacketed, and has two rows of tuyers on each side, the upper ones being about 10 in. above the lower. The lower blast is supplied under a pressure of about 2 lb. per sq. in., and is preferably a hot blast. The upper blast is cold, and run under a light pressure. The ore and fuel are fed together continuously in a thin layer 12-18 in. deep. For fuel, a mixture of coke and coal screenings is used, amounting to $\frac{1}{4}$ the weight of the ore. The blast from the lower tuyers plays upon the bath of molten matter, scorifying it, and volatilising all the lead and most of the zinc, which pass off, through the thin layer of the unmelted portion of the charge, in the form of fume. The upper tuyers deliver a blast at the top of the charge, thus serving to keep up the necessary combustion, and preventing the condensation of the volatile compound rising through it. The copper matte which collects the silver, as in the first method, runs into an exterior crucible with the slag, and is tapped occasionally.

The matte contains as much as 65 per cent. copper and 250 oz. silver per ton. The slag contains 6-10 per cent. zinc and $\frac{3}{4}$ - $1\frac{1}{2}$ oz. silver per ton of ore treated, no lead, and only a trace of copper.

The fumes from all the furnaces, consisting of the zinc, lead, and other volatile elements, are drawn forth into chambers by means of exhaust fans, and then forced through iron cooling conduits into long bags hanging from the roof of a building at some distance from the smelters. The gases pass through the bags, where the solid contents of the fumes are caught, from time to time shaken down into cars, taken to the refinery, and subjected to a low-red heat in a closed tube containing a screw, which keeps the material in constant motion. By this means all the deleterious volatile elements are removed, and the product is a marketable white pigment containing 35-40 per cent. oxysulphate of lead and 55-60 per cent. zinc oxide.

Some ores lose silver heavily and others hardly any, ores containing copper or iron pyrites losing much less than others. As much as 95 per cent. has been recovered, but generally the salvage is between 70 and 85 per cent. Theoretically, the loss of silver should be confined to that in the pigment and that in the slags, i. e. in the former about 1 oz. and in the latter $1\frac{1}{2}$ - $2\frac{1}{2}$ oz. per ton of ore treated; but there is a variable loss somewhere between, which has never been discovered. (Later returns show the silver loss to be under 2 oz. per ton of ore treated, while there was a gain in the lead and gold over the assay of the raw ore). The cost of treatment at Cañon City is 20-40s. (average 25s.), including the production of the pigment and matte. The price of slack coal delivered at the works is 2s. per ton; of coke, 20s. per ton at Cañon City. The cost of a plant to treat 250 tons of ore per day, producing about 20 tons of pigment and 40 tons of matte, is 50,000*l.*

(b) The Parnell process was successfully worked for some years near Swansea. It depends on the fact that when blende is roasted with access of air, the zinc is converted partly into oxide and partly into sulphate, both amenable to lixiviation, the former with water and the latter with dilute acid. The following operations are entailed:—roast at low heat; leach with water; heat residue with dilute sulphuric acid in revolving lead-lined pans; leach with water and add liquor to previous one; precipitate copper by scrap iron; evaporate liquors down to a moist paste; add $\frac{1}{2}$ of its dry weight of finely powdered blende; dry; calcine in muffle; smelt residue of zinc oxide. The leached ore after calcination makes an argentiferous iron-lead suitable for ordinary smelting. The sulphurous acid escaping from the blende roaster and from the sulphate calciner is utilised for making sulphuric acid. The yield was 80 per cent. of the zinc in a metallic form, with a loss of 4 per cent. each of the lead and silver. The cost is about 25s. a ton in Wales, where the sulphurous acid is utilised.

(c) The West process* has found successful application on zinc-lead sulphides from the Silver Valley mine, North Carolina. The operations are:—roast; cool; moisten with water; place on a layer of pebbles in a false-bottomed tank; force the sulphurous acid from the roaster with a jet of steam through the ore in the tank, thus converting the oxide into sulphite and ultimately sulphate; remove the ore to a separate tank; leach with water; pass gaseous ammonia into

* S. H. Emmens, "Treatment of Zinc-Lead Sulphides," Mineral Industry, 1893.

the liquor, thus precipitating zinc hydrate; transfer liquor (ammonium sulphate solution) to a still, add lime, and heat, regenerating ammonia; dry the leached ore (containing the iron, lead and precious metals) on an iron floor heated by the roaster, when it can be smelted in the usual way. The process is much too complicated and costly for wide application, and only affords 80 per cent. of the lead and 70 per cent. of the zinc (as oxide) at best.

(d) Electrolysis (with a carbon anode) may be applied to the zinc solution for liberating the zinc as metal, and the acid solution may then be used for treating fresh quantities of zinc oxide, thus making the consumption of acid almost nominal. This feature has been taken advantage of in the Létrange, Siemens-Halske, and other processes, but is not yet developed in a practical and economical form, the plant being too costly for a limited output.

MANGANESE.

THOUGH manganese is very widely disseminated, it is often only as gangue matter possessing no value; its combinations and associations in this character are exceedingly numerous. On the other hand, its industrially useful ores are very few and not commonly encountered in great bulk; they are confined to oxides and (rarely) carbonates. Of oxides and hydroxides there are also a number possessing no commercial value. Practically the only ores sought and mined are as follows:—

Pyrolusite, or peroxide, MnO_2 , with 63 per cent. manganese.

Braunite, or sesquioxide, Mn_2O_3 , with 69 per cent. manganese.

Psilomelane, of indefinite composition, containing barium and other impurities.

Manganite, or hydrated sesquioxide, $Mn_2O_3 \cdot H_2O$.

Diallogite, or carbonate, with 45 per cent. manganese.

The ores are rarely found in such a state of purity as to be deemed specific minerals; they are rather mixtures in all proportions of the several oxides with ferrous and ferric oxides, silica, phosphorus, &c. Sometimes an attempt is made in the trade names to distinguish the quality of the ore: thus—"pyrolusite" when the assay gives nearly 80 per cent. peroxide (MnO_2), "black oxide" when it runs below 75 per cent., and "manganiferous iron ore" when the percentage is very low; but these distinctions are arbitrary and useless. Manganese occurring with silver ores is sacrificed to the more valuable metal. Manganiferous iron ores have a usefulness in making spiegeleisen even when low in manganese; and a similar application is found for the manganiferous zinc ores of Franklin and Sterling, New Jersey, after extraction of the zinc, the residue being known as "clinker."

The British home production of manganese ore is now so ridiculously disproportionate to our consumption—about 800 tons as against a yearly importation of over 100,000 tons—that but little interest attaches to it, and apparently it is dying out. The greater part by far is mined in Merionethshire, and is of very poor quality except in freedom from phosphorus, giving 30 per cent. manganese, 24 silica, 2 iron, and .02 phosphorus.

The French mines at Las Cabesses,* Pyrenees, are remarkable producers and geologically interesting, the exhaustion of the surface deposits of black oxide (pyrolusite) having led to the discovery of lower accumulations of impure carbonate (diallogite), containing 45 per cent. metal. The geological formation is shown in Fig. 158: the lower beds *a* are Silurian schists, overlaid unconformably by calc

* C. A. Moreing, "The Manganese Mines of Las Cabesses, Pyrenees, France," Trans. Inst. Min. and Met., iii. 250.

schists *b* (Lower Devonian), which pass imperceptibly in places into mixed strata of *griotte* or spotted marble and limestone *c* (Middle Devonian), followed by a bed *d* of pure *griotte* (Upper Devonian), and this by the coal measure shales *e*. The manganese deposit is concentrated at *f*, but all the Devonian beds contain a percentage of the metal. The rich deposit *f* has been opened for a length of 200 ft., a width of over 150 ft., and a depth of 230 ft. The strata strike E.-W., and dip regularly N. about 72°. The formation of the deposits is attributed* to metasomatic interchange between the limestone and manganese solutions; their distribution is very irregular, and well-defined boundaries are wanting. The output is now about 100 tons a day.

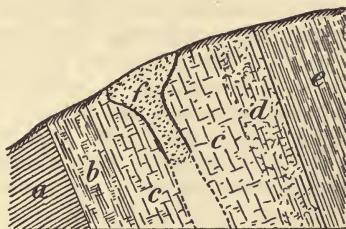

FIG. 158.—MANGANESE DEPOSITS,
LAS CABESSES.

Spain possesses important deposits† of manganese as lenticular masses, situated along lines of weakness, and probably consisting originally of carbonate which has subsequently been altered by silicious solutions, and the outcrops oxidised by atmospheric agencies. The surface workings are on black oxide, changing in depth to carbonate (diallogite) and silicates (tephroite and rhodonite). The average contents are 40 per cent. manganese (raw), 12–20 silica, and .1–.2 phosphorus. The silica can be to some extent reduced by hand-picking; and the black oxide and carbonate ores do not exceed .08 per cent. phosphorus.‡

Very important deposits of high grade ore, carrying 56–62 per cent. manganese, and only .83–2.30 silica, and .74–1.85 phosphorus, are now being energetically worked at Covadonga, and will probably soon have an influence on the market. The mineral can be delivered in an English port at a cost of little more than 30s. a ton.§

The Caucasian deposits are very extensive, forming a vein 2–3 ft. thick which outcrops on both sides of the river Kwirila, near a town of that name on the Baku-Batoum railway. Mining and transportation are in the crudest state, and only about one-third the product comes to market. Assays show about 55 per cent. manganese, 1½–6½ silica, and .15–.2 phosphorus.

Sweden affords a small quantity of ore showing about 47 per cent. manganese, 16 silica, and .01 phosphorus.

Indian manganese ores average 49 per cent. manganese, 3 silica, and .13 phosphorus.

Japanese shipments go high in metal (52 per cent.), but carry 9 silica and .1 phosphorus.

* E. Hooper.

† G. E. Collins.

‡ W. G. Bowie.

§ See J. A. Jones, "The Covadonga Manganese District and its Mines," and F. Johnson, "The Manganese Deposits of Huelva," in Trans. Inst. Min. and Met., March 1895.

Most of the manganese ore of the United States* is produced in the States of Virginia, Georgia and Arkansas, mentioned in the order of the quantity of ore raised; while smaller amounts are derived from Leadville, Colorado, San Joaquin County, California, and the Lake Superior region of Michigan. The Crimora mine, Virginia, is the largest in the country. The containing clay bed is over 300 ft. thick. The ores occur in pockets, which as a maximum are 5-6 ft. thick and 20-30 ft. long, and of lenticular shape. Other irregular stringers and smaller masses run through the clay, which preserves the structure of the original rock. Potsdam quartzite underlies it. According to C. E. Hall,† black oxide of manganese occurs in the Potsdam sandstones of this region in greater or less amount. It is often noticeable as a black stain on the rocks or as minute specks or particles throughout the mass, but no workable bodies have been found within the Potsdam sandstone. He concludes that the ore originates from the Potsdam sandstone, where it exists disseminated throughout the rocks. The water draining from the mountain area east of the clay basin carries the mineral with it in minute quantities, and redeposits it in the clay which fills the basin. The largest and best deposits of ore have been discovered directly beneath the course of the brook and immediately upon its entrance to the clay area. The ore is found in irregular bodies in various parts of the clay mass. Clay seems to be essential to its formation or redeposition. It is seldom found in sandy ground, and, when it is thus found, one is led to the belief that clay originally formed part of the mass, and has been subsequently washed out. A piece of sandstone imbedded in clay will sometimes become so much impregnated with the black oxide of manganese as to be in fact a silicious manganese ore. To Hall's mind it appears that the water, laden with its particles of manganese minerals, becomes retarded upon reaching the clay mass, and a separation takes place more or less rapidly. The high-grade ores contain $48\frac{1}{2}$ - $50\frac{1}{2}$ per cent. manganese, 10 silica, and $\cdot 09$ - $\cdot 1$ phosphorus.

Other similar bodies occur at Lyndhurst and elsewhere in the Great Valley of Virginia. Less important deposits are found at higher horizons. Cartersville, Georgia, is second to Crimora in production. The ores again occur in pockets in a stiff clay, and are associated with quartzite, which may be Cambrian (Potsdam) or Upper Silurian (Medina). They contain 34-44 per cent. manganese, 7-16 silica, and $\cdot 05$ - $\cdot 16$ phosphorus.

The manganese deposits of the Batesville region, Arkansas, occur in an area of Silurian and Carboniferous rocks. The ores are found in a red clay, which has resulted from the decay of a crystalline Silurian limestone (St. Clair), called by the miners "grey rock." The deposits are usually capped by a mass of broken chert 1-60 ft. thick, of Lower Carboniferous age; it represents the remains of a solid stratum which originally overlaid the St. Clair limestone. When the limestone decayed, the chert sank down on the residual clay left by the limestone, and became distorted and shattered. The

* R. A. F. Penrose, 'Manganese: its Uses, Ores, and Deposits,' 1890.

† "Notes on the Manganese Ore Deposit of Crimora, Virginia," Trans. Amer. Inst. Min. Engs., June 1891.

ore in the clay occurs in much the same way as it did in the original limestone; that is, in irregular pockets, masses, sheets, or as scattered nodules. Sometimes the clay is barren of ore for considerable distances; at other times the ore is abundant. In some places, where the limestone has not decayed, the ore can still be seen in it *in situ*. The ores contain 50–53 per cent. manganese, 1·7–2·9 silica, and ·16–·35 phosphorus.

At Leadville and vicinity, considerable quantities of manganese and manganese iron ores, obtained from the silver deposits, are used as a flux in silver-lead smelting, or as a source of spiegeleisen and ferro-manganese. These ores contain 25–40 per cent. manganese.

Quite productive deposits are found in pockets at Markhamville, King's County, New Brunswick, in Lower Carboniferous limestone. Some thousands of tons have been shipped. Other mines are situated at Quaco Head. At Tenny Cape, in the Bay of Minas, Nova Scotia, is another deposit in Lower Carboniferous limestone, which has furnished several thousand tons of ore. Others less important occur on Cape Breton. The Nova Scotian ore contains 47 per cent. manganese, 7–8 silica, and ·01 phosphorus.

The Virginian and other clay deposits are worked by shafts and drifts, the loose character of the ground necessitating much timbering. The clay ore is usually washed in an iron-ore washer, or in revolving cylinder screens, or (the smalls) in jigs.

The Cuban * manganese ores are chiefly pyrolusite and psilomelane, though wad is found in some quantity. The deposits most occur associated with jasper and in vertical veins, which in places have undergone decomposition into clay. In the latter case it sometimes happens that several hundred tons of excellent ore are found in one body, but for the most part the ores occur as lumps of various sizes, more or less mixed with clay and fragments of jasper. The large lumps can be hand-sorted, but the small ones can be saved only by washing. In some of the mines the amount of "waste-ore" appears to warrant the erection of a plant to reclaim it. The quality of shipped ore is good, averaging 45–53 per cent. manganese, 4–9 silica, and ·03–·1 phosphorus. Much of it can be mined in open cut with pick and shovel, costing 6s. a ton for mining and 6s. packing, freight and charges bringing up the total to about 50s. a ton in Philadelphia.

Chilian † manganese mining is concentrated in two centres, Coquimbo and Carrizal. The beds worked in the province of Coquimbo are chiefly surface deposits, requiring no expensive or scientific mining. The cost, therefore, of producing the ore is trifling; the ore runs in ridges, the tops of which are visible, the ore being extracted chiefly by crowbar and sledge. The great expense, however, is the cost of transportation. The ore from this district contains considerable peroxide, and is softer than that from the Carrizal district. The latter is found in nearly vertical lodes of a few inches to about 10 ft. wide or more, but the common width is about 3 ft. There were heavy outcrops on the surface forming walls or dykes 10 ft. or more high. These were worked as open quarries, but now the ore is usually worked underground as mines. The walls of the lode are not well

* E. J. Chibas.

† J. D. Weeks.

formed, nor is there any natural cleavage between the ore and the walls; the manganese is not regularly continuous for any great distance; there are sudden "faults" or disappearances of the ore, it having been pushed to one side or other, making it difficult to find the lode again. The ore is hard and brittle, with a glassy fracture, and has no soft powder-like deposits as some of the Coquimbo manganese. Every pound of it must be taken out by blasting. Assays of Chilean manganese show 50-53 per cent. manganese, 4-7½ silica, and .02-.06 phosphorus. A very large proportion relatively of the metal is present as protoxide. Next to the calcined carbonate of Las Cabesses it is the most highly prized product for the steel maker.

Australian samples of manganese ore have given 48 per cent. manganese, 3 silica, and .3 phosphorus; and New Zealand shipments, 53 per cent. manganese, 8 silica, and .07 phosphorus.

Treatment.—The carbonate ore of Las Cabesses is calcined in kilns similar to those used for roasting iron carbonate, consisting (Fig. 159)

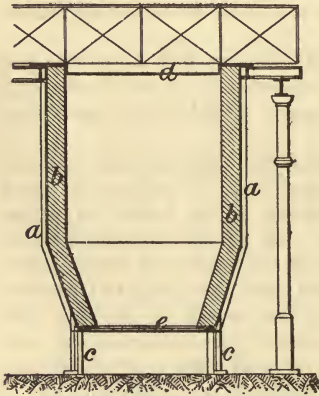

FIG. 159.—MANGANESE CALCINING FURNACE.

of a cylindrical sheet-iron shell *a*, open at both ends, lined with fire-brick *b*, and resting on iron standards *c* about 3 ft. high. The kiln proper is about 15 ft. high and 10 ft. wide at the mouth *d*, with a capacity of 45 tons; under the kiln bottom *e* is room for 10 tons calcined mineral. The charging is performed thus:—about 10 tons mineral (preferably calcined) is fed into the space between *e* and the ground, covered with a layer of about 18 in. of firewood, then 18 in. of coke, and finally 18 in. of ore. The wood is ignited from below, and when the wood and coke are well alight, a further 9 in. of coke is added, then 7-8 in. of ore, and another layer of coke. This is allowed to burn at a good heat for about a day; the second day the

charging goes on, one layer of ore and one of coke alternately, till about one-third of the kiln is filled; the third day the charging is continued in the same manner to fill up another third of the kiln; and on the fourth day the material is drawn down a little in order to bring air into the kiln, and prevent the mineral becoming slagged into lumps. After having thus begun to draw the ore and fuel down, the kilns are filled to the top with layers of coke and ore alternately. When charging the kilns for the first time, only big pieces of ore are chosen, so that the draught may not be interfered with; once the kilns are in operation, the layers may consist alternately of large and small. The whole must be arranged so as to keep a constant draught. The third day after the kilns are filled, drawing is going on; that is to say, the bringing down of the ore at regular intervals, and fresh ore is added on top. When the kiln is in full operation—say after the sixth day—there are 3 drawings a day and 3 at night, every 4

hours regularly; and by this means 8–10 tons calcined ore are drawn out of each kiln in 24 hours. When the kilns are properly started, the working only requires care, and drawing and filling at regular intervals. The ore is broken for the furnace to pieces not larger than 4–5 in. square, and the smallest stuff put in is of the size of walnuts. The proportion of the different materials introduced are:— 14 wheelbarrows of large ore, with 8 of small stuff, to 2 of coke. The layers follow each other regularly, and are arranged so that in the centre of the kilns, as well as at the sides, there is always big stuff, whilst the small ore occupies the intermediate space; the large pieces of ore allow the air to circulate, and form a kind of chimney, while the coke is spread out as regularly as possible, and forms a thin cover over each layer of mineral. The proportion of coke used is $2\frac{1}{2}$ –3 per cent. by weight, of the raw mineral. The loss in weight of ore by roasting is 32 per cent. on the average, which may be regarded as a very good result, as the mineral contains 33–36 per cent. carbonic acid.

The ore as broken in the mine contains much marble or barren matter; consequently cobbing and hand-picking, both before and after calcination, are resorted to. The picking ore before calcination is insufficiently done, owing to lack of water and mechanical appliances. Most of the ore of "walnut" size is not assorted at all, but goes direct to the second class kiln. All large stuff is tipped on a platform and washed by hand pump or syringe. When the ore is of good quality, the sterile rock and second class ore are picked out, the remainder going direct to the first class kilns. When of lower grade, the barren rock and first class ore are picked out by hand, the rest being second class. All mineral having a preponderance of "smalls" is tipped on an iron grizzly (having spaces of 2 in. between bars), and the small stuff which passes between the bars is then classified by a trommel (holes $\frac{3}{4}$ in. square), worked by hand, from which the "coarse" goes direct to the second class kilns without assorting, and the "fine" is loaded direct into waggons and sold as "raw product." The larger pieces which fail to pass through the grizzly are hand-sorted into firsts, seconds, and waste. After calcination, the ore from the first class kilns (except the larger pieces, which are picked out and loaded into waggons direct as firsts) is tipped on to inclined floors and assorted—i. e. all that is waste, or doubtful, or insufficiently calcined is picked out. The smaller stuff (maximum size, hazel nut) is put to second class, the balance going to first class. The ore from the second class kilns, after being watered in order to slake the lime that it contains, is dumped on to another part of the inclined floors, and the slaked lime and fines are taken out of it by a trommel. The ore as divided for market purposes is: "1st class calcined," 50–54 per cent. metallic manganese; "2nd class calcined," 43–45 per cent.; "raw product," 33–36 per cent. The silica is 6–9 per cent.; phosphorus, .041–.048 per cent.

Commerce.—The manganese ore trade has undergone great changes in the last few years. Until recently, its chief application was in the manufacture of chlorine, when the value depended * on (a) the available peroxide; (b) the absence of carbonates (of calcium, &c.), which

* Private letter from F. Claudet, Assayer to the Bank of England, Oct. 5, 1891.

would consume hydrochloric acid, and would evolve carbonic acid—which latter has a most deleterious effect in the manufacture of bleaching powder; (c) the physical condition, hard ores requiring excess of acid and steam for their solution. Now the consumption of manganese in the chemical trade is quite paltry compared with the quantity absorbed in making manganese steel. In this case, the whole manganese contents are available, and the impurities to be avoided are silica (English smelters demand under 7 per cent.), and phosphorus (not exceeding $\frac{1}{5}$ per cent.). In the United States prices are based on ores not containing more than 8 per cent. silica and 1 per cent. phosphorus, and deductions are made of 7*d.* per ton for each unit of silica above 8 per cent., and of $\frac{1}{2}$ *d.* per unit of manganese for each $\frac{1}{50}$ per cent. in excess of .1 per cent. Ores are bought as low as 12–16 per cent. manganese, at say 7 $\frac{1}{2}$ *d.* per unit; at each 4 per cent. advance in manganese the price per unit rises 1*d.*, up to 40 per cent. above that it advances 1*d.* for each 2 per cent. additional, up to the maximum of 49 per cent.

Covering the last 5 or 6 years, statistics show the production of manganese ores to be exceedingly irregular, and approximately as follows:—

	Tons Yearly.
Caucasus	50,000–135,000
Chili	20,000– 50,000
United States	4,000– 30,000
France	500– 25,000
Cuba	1,500– 16,000
Japan	0– 15,000
Greece	400– 15,000
Great Britain	800– 13,000
Spain	3,000– 10,000
Australia	800– 9,000
Turkey	200– 8,000
Portugal	2,000– 6,000
Sweden	1,000– 5,000
Bosnia	0– 4,000
India	0– 2,500
Italy	0– 1,600
New Zealand	0– 1,100
New Brunswick	0– 1,100
Holland	0– 1,100
Nova Scotia	0– 200
Total	150,000–250,000

MERCURY.

MERCURY (quicksilver) is found to a limited extent in the native form, but most commonly in association with sulphur. The ordinary sulphide, cinnabar, HgS , contains about 86 per cent. mercury and 14 sulphur. There is also a black sulphide, called metacinnabarite, found in one locality in California; and, in California and Mexico, a sulphoselenide named guadalcazarite ($81\frac{1}{2}$ per cent. mercury, 10 sulphur, $6\frac{1}{2}$ selenium) is sometimes encountered. Antimony is also a frequent companion, but not in chemical union. Cinnabar is virtually the only ore of industrial importance. It occurs as impregnations of porous rocks (especially sandstones) of various ages, apparently owing its origin to the influence of basaltic or andesitic intrusions.

Mercury is not a widely diffused metal, and its commercial production is somewhat restricted. Approximately, the world's annual consumption is supplied as follows, the figures referring to flasks of $76\frac{1}{2}$ lb. each:— Spain, 48,000–52,000; Austria, 16,000; Italy, 10,000–12,000; United States, 23,000–33,000; total, 95,000–110,000. Some additional quantities are obtained from Servia; Russia, the Caucasus, Borneo, and Mexico. Peru was at one time an important contributor, but has long ceased to furnish any.

Spain's yearly product is almost entirely derived from the celebrated Almaden mines, situated on the northern slope of the Sierra Morena. The metal occurs as the common native sulphide (cinnabar) impregnating sandstone beds of Silurian and Devonian age. The principal deposits dip nearly vertical and have been proved on a length of 600–700 ft. and a width of 40 ft. From nearly 20,000 tons of mineral raised in 1892, the yield was 8 per cent. of metal. The ore of the El Porvenir mines at Mieres only affords 1 per cent. from its yearly output of 5000–6000 tons. The workings on the Almaden are now at a depth of over 1000 ft.

At the Imperial mines of Idria, Carniola, Austria, the cinnabar occurs in rocks of Triassic age both in veins and as impregnations of the beds of shale, conglomerate, and dolomitic breccia. The mines cover an area of over 100 acres. Much of the ore is hand-picked before being crushed in breakers and stamps ready for calcination.

The Russian mines near Bakhmont, Ekaterinoslav, consist of mercurial impregnations of permeable sandstones. They produce some 20,000 pouds (of 36 lb. each) annually. Considerable discoveries are reported from Daghestan, Caucasia.

American mercury deposits are found in workable quantities almost solely in the coast range of California, where they seem to have followed great basaltic and andesitic eruptions of post-Pliocene age. At New Almaden, cinnabar occurs in a gangue of

crystallised and chalcedonic quartz, calcite, dolomite, and magnesite forming a "stockwork" in shattered metamorphic rocks (sandstone, serpentine, pseudo-d diabase, and pseudo-diorite). The two main fissures form a sort of V, with a wedge of country rock between; and the ore is found in both fissures and wedge, associated with much attrition clay and bitumen. A rhyolite dyke runs parallel to the fissures and is thought by Becker* to be responsible for the deposits.

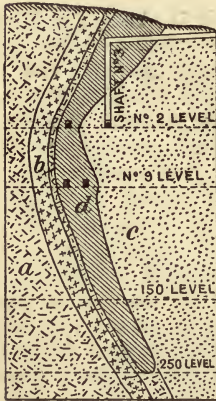

FIG. 160.
MERCURY DEPOSIT,
CALIFORNIA.

At New Idria, the ore is deposited in shattered metamorphic rocks of Neocomian (Lower Cretaceous) age, and in overlying Chico beds and is accompanied by bitumen. Other mines have been opened in regions of metamorphic and unaltered sedimentary rocks pierced by basalt and andesite. Fig. 160 shows a section of the Great Western mine: *a*, serpentine; *b*, band of black opaline mineral called by the miners "quicksilver rock"; *c*, slightly altered Neocomian sandstone; *d*, ore body. At Steamboat Springs, Nevada, cinnabar accompanied by many other minerals is still in actual process of formation. Granite is the principal rock, overlaid by metamorphic Jura-Triassic deposits, with much andesite and basalt. Becker attributes the ore to the granite, whence it has come up in solution with sodium sulphide.

New Almaden is a striking example of the irregularity of the deposits. It has often occurred in the history of the mine that there was no ore, or scarcely any, in sight, and looked as though the mine must of necessity have been shut down; it has only been by most careful and continuous prospecting that it was possible to keep up the production. Very frequently large bodies of ore will almost completely run out, and there will be visible in the face of the works only a slight colouration of vein matter, but by following out this little string of ore very carefully it may lead to a large deposit. At New Idria the mine timbers decay in an unusually short time, and two men are kept constantly employed in replacing the old ones by new. This rapid decay is more marked during sultry weather, when the draft in the tunnel is almost nil, and the atmosphere oppressive. Timbers immersed in water, or kept constantly wet, do not seem to be so affected. Dry, seasoned wood lasts longest. Timbers, after having stood in place for only 36 hours, accumulate a mildew 1 in. thick.

Statistics of American† mercury production show that the yield has decreased from 36 per cent. in 1850, to 20 in 1860, 10 in 1866, 5 in 1870, 3 in 1880, and 2 in 1890. The 11 mines working in 1889 obtained from .74 to 2.3 per cent. mercury per ton roasted, the average being only 1.088 per cent. on 93,000 tons ore roasted and

* G. F. Becker, "Quicksilver Deposits of the Pacific Slope," Monograph XIII. U.S. Geol. Sur.

† J. B. Randol, Census Bulletin No. 10.

26,500 flasks mercury produced. The average cost of mining per ton roasted has grown from about 32*s.* in 1880 to nearly 60*s.* in 1890; while the total cost per ton roasted has fluctuated between 50*s.* and 72*s.*; and the cost per flask (76½ lb.) has risen from 48*s.* in 1880 to 6*l.* in 1889-91, and 9*l.* 10*s.* in 1892.

Mexico possesses considerable resources in mercury, not yet developed. Near Arichivo occur five seams of cinnabar in porphyry. The Guadalcazar deposits occur mainly as layers in limestone, but irregular networks of vein, or "stockworks," are also found. Much of the ore is said to yield 11-12 per cent. The chief ore is cinnabar, often hepatic, and sometimes accompanied by the seleno-sulphide (guadalcazarite). Calcespar and fluorspar are the gangue minerals. In the state of Guerro, cinnabar deposits are worked on a small scale at Huitzucó, about 50 miles north of Tixtla. The deposits here are pockets of various dimensions and layers; veins, however, are known to exist in disturbed metamorphic slates and limestones. The deposit of Teposcolula is a vein between metamorphosed limestone and slates. The ore, which is also argentiferous, is livingstonite, a sulphide of antimony containing mercury.

In Queensland and New South Wales, alluvial deposits of cinnabar occur, those at Kilkivan* in the former colony being profitably worked. The "lodes" which have furnished these alluvial "leads" exist variously in mica and chlorite schists; in beds of sandstone, carbonaceous shale and conglomerate; in coarse grained granite, and not far from the junction of the granite and an altered porphyritic rock. Sometimes there is a regular "stockwork" of veins, the richest of which run about N.W.-S.E. Some of the veins have little or no matrix, but consist of small bunches of ore in the granite. Others contain a matrix of quartz and calcite. In one shaft, 30 ft. deep, is a distinct lode 2½-3 ft. wide, consisting of a granitic material with calcareous clay veins running through it. Near the surface were very rich patches of high-grade ore—that is to say, ore containing about 50 per cent. mercury—in bunches up to 6-7 in. wide. The ore is highly crystallised. The mercurial wash-dirt before alluded to consists of a granite drift, with large pebbles of the altered porphyritic rock; it contains small waterworn pieces of cinnabar throughout it, and occasional pieces of over 1 lb. in weight. The wash-dirt is about 4 ft. thick. Drives have been put in across the drift for a distance of 25 ft., and cinnabar has been obtained throughout. While the dirt will not pay to carry away for treatment, it can be profitably sluiced. In 1891, 1½ tons of mercury was obtained from 28 tons veinstone mined in the coarse-grained granite, or a yield of 5.3 per cent.

Treatment.—The separation of the mercury from the associated sulphur is effected by roasting in kilns and condensing the mercurial fumes, effective condensation and prevention of loss in escaping vapours being the most troublesome operations. Furnaces of many forms and designs have at different times been introduced, and the most recent model used at Almaden is shown in Fig. 161. Two are employed, one for rock up to 2 cc., and the other for mineral not exceeding 10 cc. The hearth is an inclined plane constructed of fire-

* W. H. Rands, Queensland Geol. Reports, 1886, 1892.

brick, $7\frac{1}{2}$ ft. wide by about 24 ft. long, the grade of which is equal to or a little steeper than the natural slope of the fines. At every 13 in. this floor has a rise of 1 in. It is divided by partitions, 10 in. high, into 12 channels 4 in. wide, in which the ore runs; these vertical partitions are of firebrick. Transversely in the channels, and supported on their partitions, are placed some bricks called *tacos* ("stoppers") which are above the floor of the hearth about $1\frac{1}{2}$ in., this being the thickness of the ore in each channel. Arranged in the same way are others situated immediately at the bottom of the rises and at the same distance from the hearth as the "stoppers," which serve to break up the fine ore on them so as not to present invariably the same surface to the action of the heat. On the lower part of the hearth is another inclined plane *a* at right angles to it, from which, at the point where it commences, it is situated as many centimetres as the thickness of the covering of ore; this is also divided into channels, but is smooth. The ore, already calcined on the first

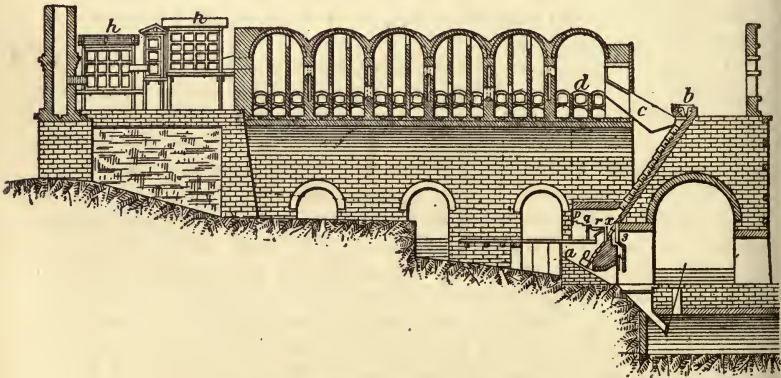

FIG. 161.—MERCURY FURNACE, ALMADEN.

plane, travels to the second, at the end of which a boy is placed, whose duty is to make it run over the hearth. A little above the second plane, and facing the first, but separated from it by the bridge *x*, is placed the fireplace, the grate of which is divided equally by a partition which rises to the arched roof of the fireplace. The fire-grate is formed of two systems of bars, *p*, *q*, and *r*, *s*, the first placed lengthwise and irregular in height, and the second crosswise. The air for combustion passes in by the ashpit to the fireplace, having traversed certain passages, *e. g.* where its temperature has been raised by the heat taken from the walls of the furnace.

By means of the hopper *b*, the channels are filled with ore, and when it has been sufficiently exposed to the heating and reducing action of the gases, the boy withdraws a portion of the ore placed on the lower edge of the second inclined plane. The charge descends gradually, transmitting the motion as far as the hopper, by which a new supply of ore enters, equal to that which the boy withdrew. The

ore remains subjected to the action of the heat about 4 hours; for the charge being made at 2.30 p.m., it passes in front of the bridge at 6.40, and leaves the second plane at 7.45 p.m., the capacity of the channel admitting about 950 lb. The fines, now calcined, are ejected by a hopper to a passage, whence they are taken out in cars. They do not now contain more than .02-.04 per cent. mercury.

The condenser is formed by two series of chambers, the first of which communicates with the furnace by a throat *c*, in the shape of a truncated pyramid of iron plate protected with brick. The 6 chambers *d* which constitute this first series are of brick, with thin walls, and are divided by partitions which have openings arranged for the passage of the fumes, so as to run in double zigzag. The bottom of each division is formed of two inclined planes, whose intersection has a small incline towards a channel common to all the chambers, in which is collected the mercury condensed in them. The bottoms are of iron plate in the 3 chambers nearest to the furnace, and of slate in those farthest away, this arrangement being in consequence of the iron being attacked by the mercury in the latter. The last part of the condenser is formed of wooden chambers *h* with glass, divided into 4 parts by vertical partitions. These chambers, like the former, are arranged so that the air can circulate below and around the sides, and allow of observation in case of any filtration of mercury through the bottoms. The temperature of the fumes observed at different points is shown to be, after travelling 350 ft. in the brick chambers, and those of wood and glass, the lowest possible in relation to the temperature of the surrounding air; consequently the condensation is effected under the best possible conditions, so that almost all the mercury is deposited from the fumes in the chambers. The cost of calcination is about 1s. a flask (Spanish) or $1\frac{1}{2}d.$ a lb., half being for labour and half for fuel.

The New Idria furnaces are fashioned after those at Idria in Austria, being square, about 30 ft. high, 10 ft. wide, and 12 ft. long, fed at the top by a drop-hopper at the rate of 1 ton an hour, and holding 24 tons when full. They employ 2 men per shift of 12 hours on each furnace, and consume 1 cord of wood (manzanita and oak, costing 26s. delivered) every 24 hours.

At the Gipsy works in Merced County, the old-fashioned retort system is in vogue, treating 1200 lb. per 24 hours of 6 per cent. dressed ore.

A great many new forms of furnace have been introduced at various times in California, the main features in which have been arrangements to secure automatic working and the substitution of fans or blowers for tall chimneys. The operation demanding most attention, however, is condensation, a loss of 10-15 per cent. taking place even in well-equipped works through inefficient condensation of the mercurial vapours. It has been laid down as an axiom that the ratio of condenser volume to the furnace volume shall be as 24 to 1, but it is difficult to see the value of such a formula, as much must depend on the heat at which the vapours leave the furnace, the speed at which they flow, and the opportunities provided for cooling them. By controlling the draft with a fan instead of a chimney it is possible

and obviously advisable to prolong the condensers as long as they catch anything.

Among the most successful American furnaces is that of R. J. Knox, a shaft furnace with fireplace at the side, shown in Fig. 162. It is 39 ft. high, rectangular in shape, with the fireplace $17\frac{1}{2}$ ft. from the bottom. At top it is 2 ft. square, but widens to 7 ft. at a depth of 4 ft., and at the fireplace the section is 7 ft. by 2 ft. Towards the drawhole, the area is contracted till it is only 2 ft. The fireplace is fed with hot air. The walls are built 6 ft. thick, and tied. The cubic contents of the furnace equals 75 tons of ore, of which 1 ton per hour is drawn out, so that each ton is in the furnace 3 days, during part of which time it is cooling ready for being drawn. Feeding is done by an automatic car holding a ton, which removes and replaces the lid on the charging hole *c*. The flue *d* for exit of gases is of cast iron, 18 in. diam., and 16 ft. high where it enters the condensers *e*. The calcined ore is drawn into cars that run on the rails *f*, and the mercury flows into the receptacles *h*. Two furnaces are usually built

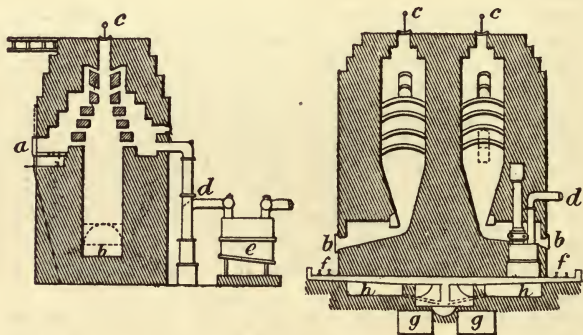

FIG. 162.—KNOX FURNACE.

together, as shown. The draft is produced by Root's blowers. The labour required is as follows:—A single furnace treating 24 tons a day requires 6 men; a double furnace treating 48 tons needs 8 men; a quadruple furnace treating 100 tons employs 10 men. The condensers are connected together by iron pipes from the top. Their floors are inclined at an angle of $15\text{--}20^\circ$. They are of cast iron, 8 ft. long, $2\frac{1}{2}$ ft. wide, 5 ft. high at one end and 6 ft. at the other, set on wooden frames on a cement floor; they are in 3 pieces for ease of transportation, &c. The top-piece is 36 in. deep, and is clamped to a projection on the piece below the top; its sides $1\frac{1}{2}$ in. high hold cooling water. A manhole gives access for cleaning when necessary. The acid liquors which condense flow to the pits *g*. From the end of each set of condensers clamped wooden box flues 1500 ft. long and 30 in. square conduct the remaining vapours to a chimney 15 ft. high and 4 ft. square filled with stones over which water descends. The solid soot collected from the condensers and flues carries 30 per cent.

of the mercury recovered, and is treated with lime in retorts 9 ft. long, 30 in. wide, and 18 in. high. The total cost of calcining ore in the Knox furnace at the Redington mine, on a 2 years' run with a double furnace, including repairs, was about 3s. 9d. a ton. The cost of the double furnace and condensers was about 12,000*l*. The cast-iron condensers were afterwards replaced by wooden (1½ in. plank) structures of the same pattern but double the size, at much less cost, and were found equally efficient.

At the Abbott mine in Lake County the furnaces used are a Knox-Osborne of 6 tons capacity for coarse ore and a Hughes of similar capacity for fines. The dimensions of the Knox-Osborne furnace are approximately 14 by 20 by 31 ft. The firedoors, one of which is situated at each end, are about 15 ft. below the charging floor, and the discharge for the roasted ore is about 15 ft. below the firing doors. This furnace consumes only ½ cord of wood in 24 hours, the heat being maintained to a great extent by the roasting ore. The vapours pass into an iron-lined, brick condensing chamber, wherein a large amount of soot accumulates, and thence into 6 iron and 2 wooden condensers, cooled by water. Most of the mercury is caught in the first 3 condensers. The cost of a 12-ton Knox-Osborne furnace is about 2000*l*. In the Hughes furnace the fine ore descends an incline of about 45°. The flame from a fireplace at each end passes over the surface of the ore. The roasted ore is discharged from a shute in the side between the fire-doors. This furnace consumes about 1¾ cords of wood a day, and is not considered satisfactory. The vapour passes into an iron-lined dust chamber, where the soot principally collects, and thence into 4 iron and 2 wooden condensers, cooled by water. A Root suction blower, running slowly, draws the vapours of both furnaces from the condensers into a 50-ft. wooden flue, the escape pipe of which extends about 60 yd. downhill at an angle of about 60°. The soot, some 60 per cent. of which is finely divided quicksilver, is worked with caustic lime, which causes the tiny globules to collect. The residue is returned to the furnace.

At the New Almaden mines, the ore is brought from the mines to the reduction works in cars run by gravity pulleys, and is dumped into shutes, where screens set at an angle of 45° separate it into three sizes—"granza," coarse ore; "granzita," medium-sized; and "tierras," fine ore. The last grade was formerly made into bricks, and treated in an intermittent furnace together with coarse ore. A great economy is now effected by working the fine ore alone, in the tierras furnaces. Such ore as needs drying is dried either by spreading out and exposing to the sun, or in an upright chamber, heated by the vapours and hot air passing from the tierras furnace. The dry ore is discharged at the bottom of the drying chamber, and is elevated to the charging floor by means of a water hoist, a tank of water being made to balance a car full of ore.

The dry fine ore is run by trucks from the elevator to the top of the tierras furnace, where it is dumped into a hopper, the throat of which closes with a slide-valve, which sustains the charge of the ore hopper until needed, and shuts off any vapours which might otherwise

escape from the heated ore below. When this slide-valve is opened, a charge of ore drops into the throat of the furnace, which, when filled with ore, naturally assists in keeping down the vapours. From here the ore falls upon a series of tiles, set one above another in the brickwork of the furnace, each one inclined toward the one below at an angle of about 45° . Each hopper feeds two sets of such tiles, and each furnace is partitioned off into 3 compartments. The firing floor is about 12 ft. below the charging floor. Here a fireplace runs across one side of the furnace, being fed at both ends with 4-ft. sticks of oak, pine, or redwood. The flame reverberates on the arched roof of the fireplace, and passes through holes in a wall, which divides the fireplace from the main body of the furnace. Crossing the ore-laden tiles to the opposite side, the flame enters a chamber, the arched roof of which again causes it to reverberate across the furnace. This reverberating process is repeated a third time. Each reverberation heats a separate tier of ore-laden tiles. The vaporous product of the furnace passes by means of an air pipe through the hollow walls of the drier into the condenser. Each double set of inclined tiles terminates in "boshes," in which the roasted ore collects, to be finally discharged from 3 openings, regulated by a shaking table at the bottom of the furnace.

The *granzita* resembles the *tierras* furnace, except that the tiles are a little farther apart, and there is no shaking-table at the base. The cool roasted ore is raked out from the places of discharge at the bottom of the furnace.

The hopper of the *granza* furnace, which protrudes above the charging floor, is covered with a lid closing with a water-tight joint, the rim of this lid being submerged in a circular trough surrounding the hopper, to prevent the escape of vapours. Through this lid passes a rod connected with a plug, so fitted to the bottom of the hopper that by depressing the rod the plug is lowered, and the contents of the hopper emptied, and by elevating the rod it is tightly closed. This furnace is charged by lifting the air-tight cover and dumping 1600 lb. of ore into the hopper. The cover is then let down, the plug at the bottom of the hopper is lowered, and the charge is admitted into the furnace. The body of the furnace is modelled after the *cupola*. Below the charging floor the furnace is encircled by a pipe, with which smaller pipes, or delivery tubes, leading from inside are connected. The mercurial vapours ascend in the furnace, through the delivery tubes to the outside conducting pipes, and thence to the condensing chamber. About 20 ft. below the piping is the firing floor, where 3 fireplaces lead into the body of the furnace, and are fed with wood 4 ft. long; 12 ft. beneath the firing floor is the ground floor and point of discharge; between it and the firing floor the body of the furnace constitutes a cooling chamber for the roasted ore, which is from time to time raked from three points of discharge at the base of the furnace. This furnace, which is principally used for the highest grade ore, has a capacity of 19,200 lb. in 24 hours.

The condensing chamber attached to the *tierras* furnace will serve as a representation of those in use at these works. This chamber is 35 ft. long, 20 ft. high, and 20 ft. wide. The interior is

cooled by 11 pipes the length of the chamber. Any uncondensed vapours which may pass through the chamber are conducted into a flue where, by the aid of a fan, they are conveyed a distance up an incline 900 ft. to a brick stack 80 ft. high.

The chief consumption of mercury is in metallurgical operations for recovering precious metals. The English trade is in few hands and controlled by powerful capitalists. The market value is about 2s. a lb., but is not constant.

NICKEL.

BOTH geographically and mineralogically nickel is a wide-ranging metal, yet commercial supplies are drawn from restricted areas. The principal ores of nickel are :—

Millerite, sulphide, NiS	containing	64 per cent.	nickel.
Niccolite, arsenide, NiAs	”	44	”
Pentlandite, sulphide, (NiFe)S	”	34 $\frac{1}{2}$	”
Annabergite, hydrated arseniate	”	33 $\frac{3}{4}$	”
Gersdorffite, sulph-arsenide, Ni(AsS) ² ..	”	32 $\frac{1}{2}$	”
Siegenite, cobalt pyrites	”	29–30	”
Garnierite (noumeaite), indefinite silicate	”	7–26	”
Nickeliferous pyrrhotite and chalcopyrite	”	3	”

Previous to the New Caledonian discoveries, Cornwall produced some nickel ore from the Pengelly, the Fowey Consols, and the St. Austell Consols mines. The ore then realised 80–84*l.* a ton; now it is only worth 15–20*l.* In Scotland some nickeliferous pyrrhotite carrying 3 per cent. metal was raised at one time.

In Germany, nickel ore has been discovered recently in the Schleifsteinthal, Upper Harz, in spiriferous sandstone of the Upper Devonian formation. In the fault fissure, which is plainly marked by selvages, and also in the adjacent country rock, are found streaks and veinlets of nickel ore. The width of these veinlets varies from 1 to 12 in. The vein matter consists of fragments of the country rock, calcite and pyrite, together with the nickel mineral, which is a sulph-arsenide. Galena and blende, which occur in the other veins of the district, are wanting. The proportion between mineral and vein matter is variable, but not infrequently the whole of the streak is solid mineral. The clean ore carries 30 per cent. nickel. The clay slate and mica schist district near Schneeberg, Saxony, contains numerous lodes in a zone 6 miles by 2.

In Sweden, nickeliferous pyrrhotite is found in some abundance, notably at St. Blasien, Klefra (Smaland), and Sagmyra (Dalecarlia). These mines have long been worked, the ore affording $\frac{1}{2}$ –2 $\frac{1}{2}$ per cent. nickel and some cobalt. The production of metallic nickel 20 years ago was 60–80 tons per annum, now it is only 10–15.

Norway* produces yearly 5000–7000 tons of nickel ore (pyrite and pyrrhotite), principally at Moss, Ringerige, Snarum, and Tragerö. In some mines, rich ore has been found, though in small bodies, e. g. 7 per cent. at Beiern, and 5 $\frac{1}{2}$ per cent. in other places; but while in the best mines first-class smelting ore up to 3 $\frac{1}{2}$ –4 per cent. can be sorted out, the bulk is much lower. In 1870, a yield of .8–1.3 per

* J. H. L. Vogt, Zeit. f. Prakt. Geol., 1893, p. 143.

cent. from ore assaying $\cdot 9$ – $1\cdot 5$ per cent. was satisfactory ; now dressing is resorted to so that the yield from the smelter is $1\frac{1}{2}$ – $2\frac{1}{2}$ per cent. In the best mines, the cost of producing 1 metric ton of 2 per cent. ore varies from 6*s.* to 12*s.*, and averages about 9*s.*

The Canadian mines at Sudbury, Ontario, were originally worked for copper, which, though present in somewhat greater proportion than the nickel, has an inferior value. The nickel and copper bearing mineral deposits apparently in most instances form portions of igneous masses, consisting of diorites, diabases and their corresponding altered forms. The name "greenstone" is commonly applied to the group. These masses are usually extremely irregular in surface outline, but in the main appear to be conformably bedded with the crystallised sedimentary strata, quartzites, schists, greywackes and clay slates of the Huronian masses, and the gneisses of the Laurentian masses. Granite, syenite or felsite frequently intervenes between the greenstone and the Laurentian gneisses, and again massive quartzite is in immediate contact. The nickel and copper-bearing greenstone, as indicated by surface exposures, is chiefly included in Huronian strata, frequently in the vicinity of the contact with Laurentian masses, and also, apparently, to a limited extent occurs within the Laurentian strata. It has not been determined by developments thus far whether the character and quality of the deposits vary materially according to their position. Large and small deposits and relatively high grade and low grade mineral aggregates, occur within relatively narrow confines, under the several conditions. The richest ores, however,* as determined by analyses of average samples, have been derived from deposits in the vicinity of the irregular contact between the Huronian and Laurentian formations.

The mines may be roughly divided † into 3 classes:—(a) those which are composed of extremely massive pyrrhotite, and are of such enormous extent that as yet no idea of their boundaries has been obtained ; (b) those which contain more rock material, and which are less extended in size, though much richer in both copper and nickel ; (c) those which are not only as extensive as (a) but nearly as rich as (b).

As an example of class (a), the Stobie mine may be cited. Before being opened at all, it simply appeared to be an immense rounded hill of red gossan. As to the length, the outcrop shows it to continue in a more or less unbroken condition for some miles. Upon removing this gossan, which consists of a brown iron ore in regular stratified layers (the product of the decomposition of the pyrrhotite), the unaltered pyrrhotite in a massive condition is encountered within 2–6 ft. of the surface. At intervals limited bands of rock occur, and occasionally considerable masses of diorite or of mixed ore and rock ; but as a rule the ore is massive pyrrhotite, with occasional pockets of very pure chalcopyrite, and not infrequently rounded and even angular ocluded masses of diorite, from the size of a chestnut up to boulders weighing many tons. The position of the ground is

* E. R. Bush, "The Sudbury Nickel Region," *En. and Min. Jl.*

† E. D. Peters, "The Sudbury Ore Deposits," *Trans. Amer. Inst. Min. Engs.*, xviii. 280.

favourable for open-cast work, and miners are at present simply taking the whole hill down as they go, on a level with the valley. They have in some places already cut over 100 ft. across the ore, thus obtaining a fine face for blasting down in great quantities (several hundred tons at a blast), by putting 8-10 air-drilled holes, 10 ft. deep, and firing with a dynamo. Besides the open cut, two tunnels have been driven a further 60 ft. across the body, always in massive ore.

Class (b) is represented by the Copper Cliff mine. The ore here is sometimes much intermixed with diorite, and occurs in irregular masses of several thousand tons each, situated apparently between two cleavage-planes in the country rock, so that new deposits are found by drifting. Although there are absolutely no stringers of ore or veinlets of quartz to connect these ore-bodies, the country rock in their vicinity is usually speckled to a greater or less extent with ore, and this is often the only indication of immediate proximity to a large ore-body. The shaft is down 700 ft. on a slope of about 40°, and the ore still continues.

The ore delivered to the smelting furnaces from the whole district averages about two-thirds the gross weight hoisted from the mines; and after this hand-picking the mean assay is 1½-3 per cent. nickel and 1-4 per cent. copper, with minute quantities of gold and platinum.

The genesis of these ore bodies has been much debated, and while the earlier opinions were based on the eruptive igneous theory, later investigators have found reasons for believing in a possible aqueous origin.* So also, the question whether the nickel is a constituent of the gangue or of the pyrrhotite has received different replies, and as this has a bearing on the method of dressing the ore, it will be referred to subsequently.

In the United States, lenticular masses of nickeliferous pyrrhotite, imbedded in gneisses and schists, have been found in many places, assaying up to 3 per cent. nickel, but not contributing to the industrial supply. The only important mine is the Gap, in Pennsylvania, the output of which is rapidly declining. Here the ore (millerite, pyrrhotite, chalcopyrite, siderite, &c.) occurs as a lining on and superficial (6-30 ft.) impregnation of an enormous lenticular mass of hornblende enclosed in micaceous schists, adjacent to a great trap dyke. The ore, originally only worked for its copper, carries 1-3 per cent. nickel. Other American localities may be briefly mentioned as follows:—Millerite at Benson, Arkansas; arsenide and sulphide associated with cobalt, at the Gem mine, Colorado; nickeliferous pyrrhotite at Dracut, Massachusetts; siegenite with pyrite in the lead ores of Mine La Motte, Missouri; niccolite and annabergite in veins permeating a ledge 30 ft. wide, at Cottonwood, Nevada; garnierite in connection with serpentine, at Webster, N. Carolina; pyrrhotite, chalcopyrite, and garnierite, at Riddles, Upper Dad's Creek, and Rock Point, Oregon.

New Caledonia ranks second in importance for production of nickel, and so widely is the metal distributed that mining concessions covering over 7000 sq. miles are said to be in actual operation, though

* E. R. Bush, op. cit.

Garland,* as late as 1892, places the number of mines at that date at 324 (of which only 80 were working), comprising an area of over 120,000 acres. The nickel deposits occur exclusively in the predominating common massive serpentine, almost invariably in elevated positions, and capped with ironstone carrying 4–8 per cent. chromium sesquioxide. The nickel ores occur, as a general rule, in irregular veins and strings in the fissures and joints of the rock, ramifying in every direction, and forming a stockwork or network of small veins. Occasionally they are met with as persistent veins extending some hundreds of feet in length and to a moderate depth, and in these cases partaking of some of the characteristics of a regular lode. Veins occur 2–3 ft. thick, with good regular walls and a regular dip, and taking at times a lenticular form 4–5 ft. thick. It is generally held, however, by the French engineers, that these are not true fissure lodes. At a depth of about 300 ft., the garnierite gives way to magnesia silicate exclusively—no nickel. As to their origin, it would seem that they are segregated veins, and inasmuch as the enclosing serpentine carries .25–.75 per cent. nickel, there can be little doubt that the filling of the veins and joints has been caused by lateral secretion, or the leaching out of the metal from the serpentine and its subsequent deposition. The ore is exclusively garnierite (hydrated silicate of nickel and magnesia), no trace of arsenide or sulphide having been found; and while two varieties, a green and a brown (called “chocolat”), are distinguished, investigations by A. C. Claudet prove that the latter owes its colour to associated limonite.

The methods of working the deposits are by regular mining, when the ore bodies are fairly persistent and of good width; and by open quarrying, when they are less than 6–12 in. wide, and when stockworks occur. Sometimes both systems come into operation in different parts of the same deposit; and often, when underground mining is pursued, the irregularities and crossings of the veins render the workings very intricate. Quarrying is done in terraces from the top downwards, each terrace having a wide floor on which the rock is blasted down, and where the ore is prepared for market. Each quarry has a face of nearly vertical rock, 30–40 ft. high, and a floor 60–120 ft. wide. Deep holes are drilled by “jumpers” in the face of the quarry, and blasted with dynamite. The rock, being very jointed, breaks down in large lumps or blocks, which have subsequently to be reduced by heavy hammers or shot-holes to a convenient size for setting free the veins and strings of ore, and for easy removal of the dead rock in waggons or barrows. Roughly speaking, every joint and fissure of the rock is filled with ore, the veins thus ramifying in every direction varying in size from a knife-blade thickness up to 6 in. or more, but the smaller are the more common and numerous, and hence, to secure all the ore, it becomes necessary to blast down the whole mass of rock. Occasionally these small veins have a white filling of magnesia silicate only. Transportation to depôt is accomplished by ropeways, of an exceedingly rudimentary description where the distance is small—a single wire rope with tough forked sticks in lieu of pulleys;

* J. Garland, “Nickel Mining in New Caledonia,” *Trans. Inst. Min. and Met.*, iii. 121.

and the cost of a double installation 1968 ft. long, with 2 steel cables 1 in. diam. and hemp guide ropes, carrying a load of 4 bags or 500 lb., is given at only 200*l.* The cost of ore mined, dressed to about 7–8 per cent. nickel (6 per cent. is the minimum marketable), and delivered on ship-board, varies from 6*s.* to 40–50*s.* a ton, 40*s.* being perhaps about the average.

Treatment.—Practically the whole world's supply of nickel is furnished by the pyrrhotite of Canada and the garnierite of New Caledonia, and it will be appropriate to discuss the preparation of the metal from each of these sources first.

As to the nickeliferous pyrrhotite there comes the initial question of how the nickel occurs. Dr. S. H. Emmens has asserted* positively that the nickel is not as a constituent replacing part of the iron in the pyrrhotite, that magnetic separation will give a rich nickel concentrate, and that the nickel is possibly an essential constituent of the gangue and not of the pyrrhotite. On the other hand, it is shown † that for several years the Canadian Copper Company has been sorting its ores, making four grades of the mine output, by boys, who, judging by the eye alone, separate:—(a) the average mixed copper-nickel ore; (b) the copper pyrites; (c) the pyrrhotite or nickel ore; (d) the rock or diorite. What results are obtained will be seen by the following averages:—

	Cu.	Ni.	Total CuNi.	Cu in total CuNi.	Ni in total CuNi.
	p. c.	p. c.	p. c.	p. c.	p. c.
Copper Cliff mixed ore	5·69	4·75	10·44	54·5	45·5
Stobie mixed ore	2·21	2·28	4·49	49·2	50·8
Evans mixed ore	2·60	4·0	6·60	39·3	60·7
Copper Cliff picked Cu ore ..	14·13	2·74	16·87	83·7	16·3
Stobie picked Cu ore	15·71	1·28	16·99	92·4	6·6
Evans picked Cu ore	13·86	1·34	15·20	91·9	8·9
Copper Cliff picked Ni ore ..	0·80	8·12	8·92	9·0	91·0
Evans picked Ni ore	0·49	5·36	5·85	8·4	91·6
Average diorite rock	0·8	0·7	(contained as shots of ore)		

The fact that in the picked pyrrhotite or nickel ore from the Copper Cliff mine the nickel is 91 per cent. of the total copper-nickel contents, while in the same mine before sorting it is only 45·5 per cent. of the two metals, shows very conclusively that nickel is not a constituent of the diorite, but that it always accompanies and is found in the pyrrhotite, whether it be an essential mineralogical constituent thereof or not.

Before hand-picking, the ore is broken by sledge-hammers to suit a Blake breaker, and from the latter it passes through revolving screens which separate it in 3 sizes—4 in., 1 $\frac{3}{4}$ in., and $\frac{3}{4}$ in. Metallurgical treatment commences with pile roasting, to remove the sulphur and oxidise the iron as much as is practicable. The roasting-yard is nearly $\frac{1}{2}$ mile long and 100 ft. wide, so that the length of the

* Can. Min. and Mech. Rev., Aug. 1893.

† D. H. Browne, En. and Min. JI., Dec. 2, 1893.

piles is limited by the width of the ground. After allowing space to get around them and for drains, about 80 ft. is left for the length. They are about 40 ft. wide, and, as the ore is piled about 7 ft. high on the wood, hold about 800 tons. They are built in the usual manner, about 30 cords of wood being sufficient to kindle a pile. After the main body of the pile is built up of coarse ore, a layer of ragging or medium ore is put on, 6–12 in. thick, according to the supply on hand, and this is covered in the usual manner with fines. By interposing a layer of rotten wood and chips between the ragging and fines, both these smaller sizes are roasted more perfectly than usual. In general, the whole heap is well enough oxidised to take it direct to the smelter without re-roasting any portion. A heap of 800 tons burns about 60 days if properly managed. Very great care has to be exercised, or the combustion becomes too rapid, and a great part of the sulphides in the ore melt down into a solid matte, which is most difficult to break up, and which carries far more sulphur than is permissible. Almost the entire success of the smelting process depends upon a good roast. If the sulphur is not properly removed, a great quantity of low-grade matte is formed, into which the iron goes, leaving the silica without sufficient flux, and making the furnace run slowly and badly. If it is reduced to the normal amount of 7–8 per cent. sulphur in the roasted ore, a rich matte is formed in comparatively small quantity, thus lessening freight and treatment charges. The iron which was combined with the sulphur is thoroughly oxidised, and is thus in a condition to combine at once with the silica, forming exactly the flux required, and making a rapid, clean and fluid run in the furnace. The importance of this process cannot be exaggerated. The roasting is done by contract at a very small figure, both for fuel and labour. By a second contract it is dug out of the heaps, which are frequently so fritted together as to require light blasting. A very successful method of heap-roasting is to build two heaps in the ordinary manner, allow them to burn out about one-half, and become thoroughly cooled on the sides, and then build a third heap in the passage-way between them. A bed of wood on the bottom, and a single layer on the sloping sides of the two lateral heaps, provide ample fuel to start No. 3, which not only undergoes a thorough burning itself, but also sets the unroasted sloping sides of the two adjoining heaps on fire again, and thus roasts something like 50–100 tons of material that ordinarily is nearly raw. This method, besides greatly lessening the percentage of unroasted ore, also adds some 60 per cent. to the capacity of an ordinary roast-ground. Practically the same plan is followed at Rio Tinto (see p. 431). The roasted ore goes to the smelting furnace, a steel water-jacket of the Herreshoff pattern, rectangular, with rounded corners, and a slight convexity all around, so that it really approaches an oval; its section, at the tuyers, is 3 by 6 ft., and it has 11 $2\frac{1}{2}$ -in. tuyers, 5 on each side and 1 at one end, the discharge-opening being at the other end; it is 6 ft. high from tuyers to charge-door, and is an unbroken water-jacket the entire distance from the cast bottom-plate to the charging-door. Above the threshold of this opening is a housing of boiler-iron, lined with fire-brick, which lasts as long as

the furnace does. The charge-door is situated at one long side of the furnace, while the flue opening is opposite to it. The entire flue, as well as the iron charging-platform, rests on a series of girders and I-beams, supported by the stone walls of the building and by three iron columns. The flue enters into a series of zigzag dust-chambers outside of the building, connected with a stack 60 ft. high and 5 ft. square inside from bottom to top. The water-space in the furnace is only 2 in. wide, instead of 6-8 in. The chief peculiarity is the front connecting-reservoir or "well." It is a circular, cast-iron, water-jacketed vessel, mounted on 4 stout wheels, and so designed that its hole in one side connects directly with the outlet-hole of the furnace. This forms a connecting channel, a few inches in length, thoroughly protected by water-cooling, through which the molten slag and matte flow out of the furnace as rapidly as they are formed. They thus escape the influence of the blast; and any possibility of the formation of the great bugbear of copper-smelters, masses of metallic iron ("sows" or "salamanders"), is completely avoided. The slag and metal separate very perfectly in this quiet, spacious reservoir, and the slag flows in a continuous stream over the jacketed lip at a height of 10 in. above the outlet-hole of the furnace. This ingenious arrangement completely traps the blast, and prevents foul slag. The matte is tapped at intervals of 10-20 minutes through a separate bronze water-cooled tap-hole casting, which is bolted to one side of the well, and which is plugged with clay in the usual manner. Owing to its proximity to the hot stream of molten matter from the furnace, the tap-hole never chills. When the operation of tapping takes place, the furnace-man simply drives a $\frac{1}{2}$ -in. steel bar through the clay plug with a few light taps of a carpenter's hammer. The matte flows quietly into a slag-pot, and the small tap-hole in the casting is closed, without any chance of failure, by a clay plug as usual. There is no interruption of the blast. For the better preservation of the cast-iron plates which form the floor of the building around the furnace, a circle is cut in the plate just where the stream of slag naturally falls, and into this is introduced a shallow cast-iron basin. The slag drips into this without injuring the plates, and is taken out from time to time by the fork, and thrown into the slag-pot. The basin stands two months or more before it is destroyed, and is replaced at a cost of 3s., and without loss of time to the furnace.

Ore and fuel are accurately weighed, and sampled; the matte produced is daily sampled, as well as accurately weighed, before it is dumped from the pot, and the slag is sampled from every potful and assayed once every 24 hours. By properly mixing the three different ores, flux is dispensed with. The fuel used is Pennsylvania coke of the best quality, 1 ton of which smelts 7-8 tons of ore. The capacity of each furnace is about 125 tons per 24 hours. The matte or regulus produced carries 27-30 per cent. copper and 15-19 per cent. nickel.

The refining of the matte is performed in two ways:—

(a)* The matte is bessemerised in converters with a silicious lining, the latter uniting with the oxidised iron to form a slag, while the copper and nickel remain as sulphides. The enriched matte is

* S. H. Emmens, *Mineral Industry*, 1893, p. 352.

next calcined in a reverberatory furnace to remove most of the sulphur, afterward roasted with salt, and the copper chloride is extracted by lixiviation. If much iron remains with the nickel, the lixivated material is dried, mixed with a little pyrite (or other sulphur compound) and sand, and fused in a reverberatory furnace so as to slag off the iron and leave almost pure nickel sulphide, which is then converted into oxide by calcination.

(b)* The matte, having been roasted, is treated repeatedly with hydrochloric or dilute sulphuric acid, to dissolve the nickel and copper, and cobalt, lead and bismuth, if present. Any iron that may have gone into solution is precipitated by lime, having previously been converted into ferric oxide by the addition of lime chloride. The temperature of the solution is then raised to 158° F., and the copper is precipitated by calcium carbonate, milk of lime, or a solution of soda. When all the copper has been thrown down, the cobalt is precipitated by the careful addition of a solution of calcium chloride to the perfectly neutral, hot, and not too dilute filtrate. The nickel is finally precipitated as hydrate by calcium carbonate, milk of lime or soda. The nickel hydrate is filtered off, dried, heated with sodium carbonate to decompose any calcium sulphate that may be present, washed with acidulated water, dried again, and finally reduced by carbonaceous materials to the metallic state. This process, being dependent upon the fractional precipitation of the several metals in the ore with the same reagents, is subject to slight alterations of procedure in various works.

The preparation of garnierite for the market is of the simplest description. The crude ore having been reduced by spalling to a suitable size, a portion consisting of mixed ore and rock is separated by cobbing, the cobbled ore being always of high grade. The remaining portion, consisting of the fine ore, a good deal mixed with stone, is all carefully collected and screened in hand sieves of $\frac{1}{2}$ – $\frac{5}{8}$ in. holes; the fine which passes through is not further treated; the coarse which remains in the sieve is hand-picked, the useless stone being rejected. The picked ore is next mixed with the fines and cobbings. The crushed mineral has a sp. gr. of only 3, which is so near that of the serpentine gangue that wet concentration is impossible. If the cobbled and hand-selected portions only were utilised as a marketable product, the percentage of the ore would be something like doubled; but the crude smalls which form the bulk of the ore, and which do not admit of concentration at all, are mixed with the richer portions, and thus the percentage of the metal is reduced to the average of about 7–8. In this state it is shipped to Europe. The further treatment consists in smelting in a low-blast furnace with coke and gypsum (or alkali waste or salt-cake), to remove silica, magnesia, &c., as a slag, and produce an iron-nickel regulus. This latter is then subjected, in a reverberatory furnace, to a series of alternate roastings and fusions with sand, whereby the iron is gradually slagged off, and almost pure nickel sulphide is finally obtained; this may be converted into oxide by calcination. Sometimes the first roasting and fusion of the blast-furnace matte is replaced by bessemerising.

* W. R. Ingalls, En. and Min. JI.

The bulk of the Canadian matte is treated by the Orford Copper Co., by the following* method:—The metals in the matte are reduced by a preliminary treatment, either by the Bessemer process or by ordinary calcining and melting in a blast-furnace, to a point where the metals are present substantially as subsulphides. The matte is then melted with an alkaline sulphide (in practice with salt cake, i. e. sulphate of soda, which in the blast-furnace is reduced to soda sulphide), and a reaction follows in which the copper and iron take the sulphur from the soda. By adding the proper proportion of salt-cake, the bulk of the iron and copper are converted into sulphides and mixing with the soda, make a very fluid mass, from which the nickel subsulphide separates by gravity, and, on cooling, leaves in the tops the bulk of the copper and iron and the soda, and in the bottoms the bulk of the nickel. On exposure to the weather, the soda in the tops is converted into caustic soda; mixing these tops with matte and remelting, the caustic soda is converted into soda sulphide at the expense of the nickel, leaving the latter in a semi-metallic state, and again a top and bottom is formed with copper and iron in the top and nickel in the bottom. By properly balancing these various treatments a pure nickel sulphide is at last obtained, which by calcining is converted into oxide. This oxide is said to be superior to metallic nickel for the steel-maker's purpose.

The reduction of the pure nickel oxide is brought about by mixing it intimately with charcoal, and heating it to whiteness in graphite crucibles, where it assumes the metallic condition. When molten, it is granulated by pouring into water. To produce it in coherent close-grained masses, the oxide is mixed with finely-powdered wood charcoal, or with flour or starch made plastic with molasses, and the mixture is moulded and packed in crucibles with charcoal, the heat applied being just short of that required for fusion.

According to Rickard,† in New Caledonia the ferro-nickel process is now being adopted, as follows: The ore is smelted in a 40-ft. blast-furnace to obtain ferro-nickel, which is then ground and decarbonised in a reverberatory furnace, and in subsequent treatment the iron, the silica, and the manganese are slagged off, and the product is sent to be refined; the refining is, however, very costly.

Some of the leading proposed modifications not yet adopted may be mentioned.

From researches on the magnetic qualities of the several minerals in the Sudbury ores, J. T. McTighe and T. A. Edison have separately claimed to be able to effect magnetic separation. Seeing that the mineral must first be reduced to a very fine state of division (at considerable cost) before admission to the machine, and that clean separation is impossible, in view of the fact that it is dependent only on comparative degrees of magnetism between the nickeliferous and non-nickeliferous portions (even supposing that to hold good in all cases), it hardly seems a feasible project.

Macfarlane proposes to treat nickeliferous pyrrhotite by a modification of Henderson's chlorination process for copper pyrites thus:—

* R. M. Thompson, *Mineral Industry*, 1893, p. 357.

† Discussion on Garland's paper.

(a) roast to burn off the greater part of the sulphur; (b) mix the roasted ore with about $\frac{1}{8}$ its weight of common salt (sodium chloride) and reduce the mixture to powder; (c) calcine the mixture at a low-red heat; (d) lixiviate with hot water; (e) add a small quantity of caustic soda to precipitate any iron; (f) add sodium sulphide to precipitate any copper; (g) add caustic soda to precipitate the nickel as hydrate.

Probably the most important modification of present methods will follow from the discovery of Dr. S. H. Emmens* that the nickel in pyrrhotite is easily dissolved by a solution of ferric sulphate, even if the ore be in a raw state, but it is greatly accelerated by a preliminary low-roast. He therefore proposes to replace the ordinary roast-heaps and smelters by weathering-floors, a low-roasting furnace, and lixiviation tanks; the product being obtained and shipped to the refineries in the shape of either crystallised nickel sulphate or precipitated nickel hydrate. The simplicity, economy, and high concentration power of such a method are obvious, and will certainly claim attention for it.

The Mond process looks very attractive as a laboratory operation, but it is not free from difficulties. It is based on the discovery that carbon monoxide (CO) brought into contact with finely-divided nickel below 300° F. forms a readily volatilised compound of 1 molecule of nickel and 4 of carbon monoxide. This "nickel-carbon-oxide," $\text{Ni}(\text{CO})_4$, is a colourless liquid boiling at 110° F., and its vapour, when heated to 356° F., becomes decomposed into metallic nickel and carbon monoxide. As applied to pyrrhotite, the mineral is first pulverised, then dead-roasted to complete oxidation (not easily attained); next the oxide is reduced to a finely-divided metallic state by the action of hydrogen at 660°–750° F.; this metal is subjected at 120° F. to a current of carbon monoxide, which carries off the nickel as $\text{Ni}(\text{CO})_4$, leaving all other metals behind (except some iron which also volatilises); finally the vapour is passed through tubes heated to about 356° F., when the nickel separates out in coherent metallic masses. The finely-divided metallic powder soon loses its energy in the presence of carbon monoxide, and requires revivifying by heating up to 570°–660° F. in a current of carbon monoxide or hydrogen, and cooling down again; and an enormous amount of carbon monoxide free from oxygen or halogens will be required in practice.

Commerce.—The output of nickel ore fluctuates greatly. Thus the New Caledonia exports were over 10,000 tons in 1884, under 1000 in 1886, 8500 in 1887, dropped to 6500 in 1888, and reached 35,000 in 1891. The metal production in 1891 is estimated at over 10 million lb., of which New Caledonia furnished more than half, Canada about $4\frac{1}{2}$ million lb., Scandinavia about 160,000 lb., and the United States 120,000 lb.

It has been computed† that the cost of Canadian pyrrhotite delivered at the breaker is not less than 20s. a ton, and the costs of succeeding operations are given as follows:—breaking, 1s. 3d.; heap-roasting, 2s.; cupola smelting, 9s.; bessemerising, 8s.; reverberatory calcining, 5s.; reverberatory fusion, 14s.; refined sulphide roasting,

* Mineral Industry, 1893.

† Emmens, op. cit.

20s.; chlorination and lixiviation, 16s. From this it is deduced that the cost per ton of nickel oxide carrying 76 per cent. metal will be:—

(a) From pyrrhotite: breaking, 35s.; heap-roasting, 58s.; matte smelting, 15*l.*; bessemerising, 40s.; first calcination, 13s.; chlorination and lixiviation, 40s.; second calcination, 9s.; second fusion, 25s.; pulverising refined sulphide, 2s.; first sulphide roast, 20s.; second pulverising, 2s.; second roast, 20s.; total, 28*l.* 4s.

(b) From garnierite: smelting for matte, 76s.; first calcination 10s.; first fusion, 28s.; second calcination, 9s.; second fusion, 25s.; pulverising refined sulphide, 2s.; first roast of refined sulphide, 20s.; second pulverising, 2s.; second roast, 20s.; total, 9*l.* 12s.

Assuming the oxide to be sufficiently pure to require no intermediate refining, and to be reduced direct to granulated metal, the cost of this operation is calculated at 4*d.* per lb. of nickel made. Reckoning also that the extra richness of garnierite is counterbalanced by greater freight charges, and that the nickel in the ore costs about the same whether it be in pyrrhotite or garnierite, viz. 5*d.* a lb., then the ultimate cost per lb. of metallic nickel will be:—

(a) From pyrrhotite: mining and transport, 5*d.*; conversion into oxide, 4½*d.*; reduction into metal, 4*d.*; loss in working, 2*d.*; total 1*s.* 3½*d.*

(b) From garnierite: mining and transport, 5*d.*; conversion into oxide, 1½*d.*; reduction into metal, 4*d.*; loss in working, ½*d.*; total 11*d.*

It is to be noted, however, that the calcinations and fusions of the matte in the case of garnierite may amount to five, thus increasing the cost; but the metal is completely free from arsenic.

Market prices fluctuate considerably, as the refining trade is in few hands, but 2*s.*–2*s.* 6*d.* a lb. for 98–99 per cent. fine metal is about the average.

The great consumption is for nickel-steel armour-plates; also for coinage, domestic articles, and plating.

PLATINUM.

THIS metal* is quite widely distributed geographically, but usually in very small quantities. Geologically, not much is known about the conditions of its existence, because it is almost entirely encountered in alluvial formations. Recently, however, during explorations on Mount Solovieff, which lies at the head of the platiniferous gravels of the Urals, a piece of rock over 1 ft. diam. was encountered, consisting of chrome iron and serpentine in alternate bands, associated with a small quantity of dolomite, and some disseminated angular fragments of country rock. Visible grains of native platinum could be distinguished by means of a lens, but even the rock in which no platinum grains could be seen was found to contain 0.0107 per cent. of that metal. The platinum is therefore present in microscopic accumulations. The country rock of Mount Solovieff consists of angular grains of olivine, cemented by clear green serpentine, and besprinkled to a small extent with grains of chrome iron; it may be regarded as the variety of peridote known as dunite; this is sometimes massive when in contact with the including rocks, and at other times shattered and penetrated by the latter. Moreover, the richest alluvial deposits are found lying on serpentine. In California, the placers containing platinum are always in close proximity to serpentine. In Canada, it is associated with nickeliferous pyrrhotite in the "greenstone" group of diorites and diabases. The platiniferous alluvials of Colombia consist largely of diorite, carrying chromic iron; and the alluvial platinum found in British Columbia is associated with chromite in deposits resulting from the erosion of diorite. In New South Wales, it is found *in situ* in ferruginous felsite and granite, and in gravels largely composed of serpentine. Mineralogically, platinum is nearly always alloyed with iridium, osmium, palladium, rhodium, or ruthenium, in the metallic form; but a notable exception is its occurrence as an arsenide, sperrylite (containing $52\frac{1}{2}$ per cent. platinum, 41 arsenic, $4\frac{1}{2}$ tin oxide, $\frac{3}{4}$ rhodium, $\frac{1}{2}$ antimony, and .07 iron), in the nickeliferous pyrrhotite of Canada.

Present commercial sources of platinum are all alluvial, though the vein matter of the Macdonnell mine, Ontario (which carries as high as .53 per cent. platinum sometimes), and the nickel oxide prepared from the Sudbury ores (which averages .25 per cent. platinum), will probably soon be made to yield their quota. In order of importance come the placers of Russia, Colombia, British Columbia, California, Brazil, Borneo, New South Wales, New Zealand, &c.

* See C. Bulman, "The Platinum Group of Metals," Mineral Industry, 1893, p. 373.

Russia virtually supplies the world's demands. The diggings now worked are at Goro-Blagodot (Government) and at Nijni-Tagilsk (Prince Demidoff), neither being auriferous to any extent; also at Bogoslowk, Miask, and New Jansk, where gold predominates. All the platinum-bearing streams of the Nijni-Tagilsk district descend from Mount Solovieff, and the country around is covered with rounded boulders of serpentine and peridotite rock. As these boulders decompose under the action of the air, they form a sand or gravel from which the metal can be profitably extracted. The platinum of the alluvial deposits occurs in grains, or sometimes in nuggets, of which one at least has been found of 22 lb. weight. The gravel often contains $\frac{1}{2}$ oz. per ton of platinum, but can be profitably worked for $\frac{1}{10}$ oz. The deposit near the banks of the River Martiane rests on a serpentine conglomerate, and is 12-15 ft. thick. Above is a thickness of 70 ft. of barren ground, chiefly clay. Most of the alluvial auriferous deposits in which platinum is found are in the neighbourhood of peridotite rock or of serpentine rock formed by the partial alteration of the peridotite. Thus the river Miass takes its source from a mountainous district mainly composed of serpentine rock, and accordingly the auriferous deposits near the head of the river are rich in platinum, but farther down stream, as the serpentine formation is left behind, the gold becomes less platiniferous. The richest deposit of the Nijni-Tagilsk district is that of Avrorinski, extending for a length of $\frac{1}{2}$ mile, 20-60 yd. wide, and of a thickness of 4-5 yd. Here the platinum is found to the amount of $4\frac{1}{2}$, 5, and sometimes even 9 oz. per ton. The metal contains a small proportion of gold, about .26 grm. per kilo., which is separated by amalgamation. The crude platinum left contains about 90 per cent. pure platinum. From October 1886 to August 1887 the production at Avrorinski was 40,475 oz.

On the mines of Prince Demidoff,* the platinum-bearing sand is found at a depth of 6-40 ft., the "pay-streak," which is 6-10 in. thick, resting directly upon serpentine bedrock. When the overlying gravel is not too thick, it is thrown to one side, and the "pay sand" is then scraped up; but, as a rule, shafts are sunk to the bedrock, and the sand is removed by drifting. This work is done during the winter months, the sand being piled to be washed during the summer. The sand to be washed is carted upon an elevated platform from which it is fed with water into a revolving conical screen, the platinum and fine sand passing through into the sluice below, while the coarse materials are discharged at one side and carted away. The sluice consists of an outer and an inner compartment, the latter being kept locked, and opened only once every 24 hours by a government inspector. The tailings from the first compartment, in which most of the platinum settles, enter the second, where they are puddled and raked by women, the coarse part being thrown to one side to be carted away, while the fine sand passes into a tail sluice. The machines run continuously, are driven by steam, and attended by men and women working in shifts of 12 hours each, with a rest of 4 hours. Each machine has a capacity of about 400 metric tons of

* G. F. Kunz, *Mineral Industry*, 1893, p. 379.

sand per 24 hours, yielding over $5\frac{3}{4}$ lb. of metal, or a total daily output of $17\frac{1}{2}$ lb. During the summer months, 3000–3500 men and women are employed; during the winter but 1000. The cost of washing at the Demidoff mines is as follows:—40 carts and drivers at 3s. 9d. = 7l. 10s.; 16 men at 2s. 3d., 1l. 16s.; 4 women at 1s. 3d., 5s.; total per machine per day, 9l. 11s., not including cost of fuel, engineer, shovellers, interest, depreciation, &c.; this would make the cost of washing about 2d. per metric ton of sand washed. Sand containing less than 3 grm. per ton cannot be profitably worked, although a few instances of sand containing only 2.5 grm. per ton and worked at a profit can be cited. These costs probably do not vary much from those of the northern or Government district. In the Goro-Blagodart district the Government has granted 70 concessions, and the output is considerably larger than in the southern district. All the platinum produced pays a tax of 3 per cent. in kind to the Government. The average yield of the Demidoff estate during 1891 was, according to Kunz, 6.55 grm. per metric ton. The report of the Russian Department of Mines, 1892, states that during 1890 the total amount of platiniferous sand washed in the empire was 773,153 tons, yielding 2836 kilo. of platinum, an average of 3.8 grm. per metric ton; and on the Demidoff estate, 283,200 tons, yielding 865.7 kilo., being an average of 3.06 grm. per ton.

In Colombia the chief and the only washings of importance are found in the Province of San Juan, Department of Cauca, forming the southern part of what is known as El Choco. The principal localities are the districts of Sipi, Tamaná, Condoto, Iro, and San Juan, in all of which the metal is found associated with gold. Platinum is also found in the Atrato and its tributaries, in Antioquia, and in the district of Barbacoas. The bulk of the product is from the *caliche* beds, which Bulman * asserts to be glacial drift, and in which diorite detritus is very common. The deposits are ground-sluiced in a rudimentary manner, and the heavy sand is scraped up and washed in bateas. The gold and platinum are placed on a porcelain plate, and separated by gently and regularly tapping on the edge. Nearly all the *caliche* deposits were found by Bulman to yield $\frac{1}{2}$ –1 grm. per cub. metre, and many of them could be worked by hydraulicing. The present yield is about 250 lb. yearly, but it used to be very much larger, and could easily be increased by systematic working.

In British Columbia, important deposits of platiniferous gold gravels are found on the Similkameen River and its tributaries, especially the Tulameen. It is also found in the Frazer River district, near Lillooet. Hitherto it has not been diligently sought for, but is simply recovered as a bye-product of the gold washings. The output is 60–120 lb. per annum.

In California, platinum frequently occurs, associated with iridosmine, in the auriferous gravels; in Humboldt County it is found in the auriferous sands of the Gold Bluff Beach, near the mouth of the Klamath River. The yield from the gold placers of this State and Oregon constitute the total production of the United States, which is approximately 20–40 lb. yearly.

* En. and Min. Jl., April 2, 1892.

In Brazil, native platinum occurs in the auriferous gravels of Minas Geraes, associated with iridosmine, platiniridium, and an alloy of palladium and gold; in grains in the auriferous veins of the Boa Esperança in the Province of Parahyba do Norte; while the gold of the Gongo Soco *jacutinga* of Minas Geraes is frequently found alloyed with platinum, and occasionally with palladium. The platiniferous deposits of Brazil are further distinguished by two very rare native alloys—porpezite, a palladium-gold alloy occurring at Porpez, and rhodium-gold. The annual production is now very small.

In Borneo, platinum is found in certain auriferous gravels of which little is known, although some years ago it was reported that 600–800 lb. a year were being extracted from them. The rare mineral laurite (ruthenium sulphide) occurs there in small quantities with the platinum.

In the Australasian Colonies, platinum has been found in the sands of the Richmond and Tweed rivers, and in the Broken Hill ores, New South Wales; and in the sands of the Tayoka river, the quartz of the Queen of Beauty mine, and in considerable quantities at Hokitika, New Zealand. Broken Hill ore carrying 2·78 grm. platinum per ton was concentrated up to 15–28 grm. per ton on Frue vanners, but not with commercial success.

Treatment.—The preparation of pure or partially pure platinum from its ore and alloys is an industry which is practically a monopoly and which demands very large capital; it is virtually controlled by Johnson, Matthey and Co., London, and needs but brief description here. The method pursued by them is, in outline, as follows. The crude metal is treated in a reverberatory furnace with an equal weight of galena. When the platinum has formed an alloy with the lead, reduced by the iron in the ore, ground glass and borax are added as fluxes. The osmiridium does not alloy with lead, and gradually settles to the bottom by virtue of its high specific gravity. The sulphur is then oxidised by the addition of litharge. Finally the slag is skimmed off, and the metal is run into ingots, which upon cupellation yield platinum containing some iridium and rhodium. Such metal is well adapted for ordinary uses, and the cost of the operation is given at about 6*d.* a lb. when working on 200 lb. lots. If greater purity is demanded, this metal is melted with 6 times its weight of chemically pure lead, which is then granulated and treated with nitric acid diluted with 8 parts of water. Part of the lead, and the copper, iron, palladium, and rhodium are dissolved, leaving a black amorphous powder containing platinum, lead, and small quantities of the other metals present; the iridium existing as a brilliant crystalline substance insoluble in nitric acid. This residue is treated with dilute aqua regia, which dissolves all the platinum and lead, but not the iridium. The solution of the chloride is evaporated to a small bulk, and sulphuric acid is added to precipitate the lead. To the filtrate, ammonium and sodium chlorides are added, precipitating the platinum as potassium-platinum chloride. The whole is heated to 176° F. and left to stand for some days. The sodium chloride is added because the double chloride is more insoluble in a solution of it than in a menstruum of ammonium chloride. The rhodium present

remains in solution as a double salt. When the precipitate has completely settled, it is washed repeatedly with a solution of ammonium chloride and finally with water. As some rhodium may still be present, the chloride is dried and mixed with potassium bisulphate containing a small quantity of ammonium sulphate, and the whole is then heated in a platinum dish until the platinum is completely reduced. The rhodium remains as a bisulphate which can be removed by water, leaving behind pure platinum sponge. This is melted in a lime-furnace consisting of two cylindrical pieces of quicklime hollowed out to receive the charge of metal, then fitted together, and the whole encircled by bands of iron. The roof is slightly arched, and has a conical opening through which is passed the tube by which the fuel is introduced. The hearth is flat, and the sides are curved to meet the arch above; it should be of such a width that the melted metal will have a thickness not exceeding 3-4 mm., and in the lower part is provided with a lip which serves as a vent for the flame and as a tap-hole for the metal. The fuel used is illuminating gas mixed with oxygen in order to obtain the highest possible temperature. Hydrogen was formerly used instead of illuminating gas, but, although giving a greater heat than the latter, its use has been abandoned on account of its greater cost. In this furnace the platinum is both melted and refined, any iron or silicon present being absorbed by the lime, while osmium is volatilised as oxide. The cost of preparing crude metallic platinum is variously stated at 1s. 3d.-2s. 6d. an oz.

Commerce.—The qualities which render platinum so valuable are its resistance to oxygen, simple acids, and sulphur (but not to alkalies), and its infusibility; it is largely employed in chemical apparatus, standards of measurement, &c., dentistry, and latterly most extensively in electric lamps, telegraphic instruments, non-magnetic watches, stylographic pens, photography, and many other minor applications. The market value of the prepared metal fluctuates between 30s. and 2l. an oz. approximately, but is always uncertain. Besides the figures of production incidentally given, it may be mentioned that Russia's output amounts to 5000-10,000 lb. yearly, according to official returns, but probably one-third more evades being taxed and recorded.

SELENIUM.

ALTHOUGH selenium* does not occur in great abundance, it is widely distributed over the globe. Native selenium occurs as riolite at Culebras, Mexico. Mixed with sulphur, it is found as selen-sulphur in Volcano, one of the Lipari islands. Of the native selenides, naumannite, a selenide of silver, occurs in the Harz, and at Tasco, Mexico. Eucairite, a selenide of silver and copper, in Sweden, Chili and in the desert of Atacama. Crookesite, a selenide of copper and thallium with a little silver, comes from Norway. Zorgite, a selenide of copper and lead, from the Harz at Glasbach. Lehrbachite, a selenide of lead and mercury, from the Harz. Clausthalite, a selenide of lead, from Zinken and Clausthal in the Harz, Reinsberg in Saxony, Rio Tinto in Spain, and from Mendoza in South America; it contains 28·11 per cent. selenium, 70·98 per cent. lead, together with a little cobalt. Some selenites have also been found native. The iron pyrites which is used in the manufacture of sulphuric acid contains a small percentage of selenium, and the selenium found in the chambers comes from this source.

To prepare the selenium of commerce, the deposit from the sulphuric acid chambers, which contains besides selenium, sulphur, arsenic, zinc, tin, lead, iron, copper and mercury, is mixed with nitro-hydrochloric acid, heated, and allowed to stand for a day. Dilute sulphuric acid is now added, which precipitates the lead; this is filtered off and hydrogen sulphide is passed through the filtrate, which precipitates the selenium, copper, mercury, tin and arsenic as sulphides. The yellowish precipitate is washed, and then boiled with nitro-hydrochloric acid until everything except the sulphur is dissolved; the solution is again filtered, the excess of acid is driven off by evaporation, and the copper, tin, and part of the mercury are precipitated with caustic potash. The liquid is then filtered, evaporated to dryness, and ignited to expel the rest of the mercury. The residue, while still hot, is mixed with ammonium chloride, and the mixture is heated in a retort till the ammonium chloride is all volatilised. Some of the selenium sublimes in the upper part of the retort; the greater portion remains with the saline mass in the bottom of the retort. This is all placed on a filter, and the saline matter is washed away with water. Selenium remains behind on the filter.

Another and quicker method of isolating the selenium from the seleniferous deposit is to dissolve the deposit in hot caustic potash and allow it to stand in contact with air for 6-7 hours. Potassium hyposulphite is formed, and selenium is precipitated.

* A. J. Simons, "Selenium and its Compounds," Pharm. Jour., June 15, 1889.

To prepare selenium from clausthalite, Simons powdered the mineral and treated it with hydrochloric acid to free it from the chalk and other carbonates with which it is associated in nature, then roasted the residue with burnt tartar and charcoal in a hessian crucible, placed the mass on a filter, and washed it with water until the filtrate was colourless; the washings were exposed to the air, when the selenium separated in the form of a crust on the top of the liquid.

SILVER.

THE "white metal" is very widely distributed, and in many forms, chiefly as follows:—

	Per cent. Silver.
Native silver containing	100
Argentite, silver glance, Ag_2S	87
Cerargyrite, horn silver, AgCl	75
Stephanite, brittle silver, $5\text{Ag}_2\text{S} \cdot \text{Sb}_2\text{S}_3$	$68\frac{1}{2}$
Proustite, light ruby silver, $3\text{Ag}_2\text{S} \cdot \text{As}_2\text{S}_3$	$65\frac{1}{2}$
Pyrrargyrite, dark ruby silver, $3\text{Ag}_2\text{S} \cdot \text{Sb}_2\text{S}_3$	$59\frac{1}{2}$

The ores are thus essentially sulphides, arsenides, antimonides, and chlorides; and while large masses of such ores are found, yet the bulk of the silver produced is won from mixtures of these silver minerals with the ores of copper, iron, lead, manganese, and zinc.

Australia's phenomenal silver mine, at Broken Hill, New South Wales, is an illustration of the complexity of argentiferous ore deposits. It has been described under Lead (see p. 515). The oxidised surface ores are much richer in silver than are the unaltered sulphides found at lower levels. Occasionally ore assaying 1000·oz. silver per ton is met with, but about 40 oz. is near the average, and much does not exceed 20 oz. About half a million tons of the upper ores treated gave a mean yield of 42·6 oz. silver per ton. According to the well-known geologist C. S. Wilkinson, the silver-bearing lodes occur chiefly in mica schists in the vicinity of granite dykes, and this statement is apparently confirmed by the equally prominent scientist Robert L. Jack. At Boorook, New South Wales, rich and extensive silver-bearing reefs are found in belts of felspar-porphry alternating with beds of altered fossiliferous shales of Upper Devonian age. The argentiferous minerals are much disseminated through the reef rock, and are chiefly argentite, with some cerargyrite and proustite.

Bolivia has been a silver-producing country for many centuries, and the most conservative estimate makes its total output up to 1890 exceed 1000 million oz. The workings of the Spanish conquerors reached a maximum depth of 1700 ft. from the outcrops, with absolutely no other means of raising the ore and water than the backs of their enslaved Indians. All the principal mining camps in Bolivia* appear to be in either rhyolite or dacite (the "trachyte" of David Forbes), generally the latter. Such is the case with the great Huanchaca mine, and also with the no less remarkable mines of

* A. F. Wendt, "The Potosi, Bolivia, Silver District," Trans. Amer. Inst. Min. Engs., Sept. 1890.

Colquechaca; while the Oruro mines are also probably in dacite, although some of the specimens seem to leave a doubt, and possibly there has also been an eruption of rhyolite. Fossils prove that all the eruptive rocks of this part of S. America are post-Tertiary, and not post-Jurassic and pre-Tertiary, as supposed by Forbes. The most remarkable silver deposit in Bolivia lies in the conical mountain Cerro de Potosi, a section of which is shown in Fig. 163: *a*, argentiferous veins; *b*, rhyolite; *c*, shales; *d*, sandstones and shales. At the summit, thermal action has so changed the rhyolite that it is a practically pure quartz (95 per cent. silica), the felspar having been dissolved out. It has been long supposed that the veins of Potosi were of great length but much faulted, whereas Wendt's investigations prove that the veins constitute a stockwork, with, as a rule, fairly well defined footwalls, but no precise limit of ore towards the hanging-wall, nor indeed any real hanging wall. What few faults do exist have a general N.E.-S.W. strike, dip slightly N., and are very plainly marked, but never throw the veins more than 4-5 ft., and are no serious hindrance in mining. The percolating waters which brought in the silver salts in solution evidently passed through a

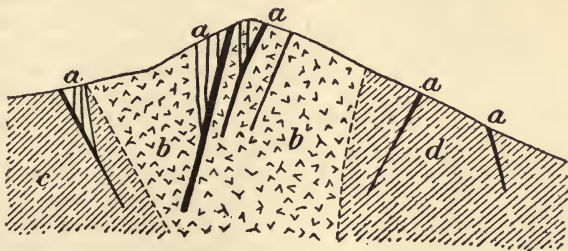

FIG. 163.—SILVER DEPOSITS: CERRO DE POTOSI.

mass of shattered rock and not a simple fissure. The stockworks have been extracted bodily in areas over 100 ft. across. In depth, the great veins of the mountain have, in Wendt's judgment, remained just about the same as they were on the surface, with this notable difference, that whereas on the surface the various ramifications formed a stockwork which could be worked at a profit, such a condition of things has ceased to exist in the harder and denser rock 2000 ft. below the top of the mountain. The fissures still continue, but only the strong veins, that is, those of sufficient width to be worked by themselves, can be made profitable. Furthermore, the ores being "negrillos" or dense sulphurets of iron, are more expensive to mine and reduce. There should be an enormous body of ore where the E.- and W.-dipping veins form a juncture, when that depth is reached. The surface-ores ("pacos") were wonderfully rich, and composed principally of chlorides mixed with native silver. They were also much more silicious than the deeper ores. With depth or penetration the "pacos" become "mulattos," containing iron oxide and sulphur (e. g. 24 per cent. silica, 18 iron, 4 sulphur), and eventually "negrillos," compact, hard iron pyrites, carrying a little copper pyrites, and

sometimes zinc-blende, and rarely galena. The silver occurs as tetrahedrite, yielding about 700 oz. silver per ton. An almost constant accompaniment of the silver ores of Potosi, and of a great many of the silver ores of the plateau of Bolivia, is tin, in the shape of grey or yellow oxide. Some of the silver veins are very rich in tin oxide, notably so the Tajo-polo and the Veta Estano. Formerly, the old miners left the tin standing in the veins; but of late years a profitable tin industry has been based upon the occurrence of these ores. The following average analysis of the pay-shute in the Cotamitos mine gives a fair indication of the character of the ores:—Iron, $44\frac{1}{2}$ per cent.; sulphur, 32; silica, 18; tin, $3\frac{1}{2}$; copper, $2\frac{1}{2}$. The approximate average assay in silver is 60 oz. a ton, bearing also a trace of gold. It seems as if the whole mass of the mountain of Potosi had been subjected to thermal action, and it is difficult to find any mineral in the mountain that does not contain a trace of silver; the hard quartz rock at the top all contains a few (generally under 3) oz. to the ton; the pyrites crystals disseminated through the rhyolite commonly assay $\frac{1}{4}$ oz. to the ton. A cross-cut driven 50–100 ft. anywhere in the mountain will be sure to cut a number of veins more or less wide. Any of these veins, if followed a sufficient distance, will connect with others that will as surely lead to some pay-shute or bonanza. This great multiplicity of veins, branches, and spurs is the bane of the miner, for it is extremely difficult to determine where and when to stop the work of prospecting. But it is noteworthy that when the veins leave the rhyolite they become poorer in silver. The present product from one vein only is about 400,000 oz. yearly.

The Colquechaca* veins are fissures occurring in dacite and rhyolite, the main lode being traceable a distance of over 2 miles. It dips into the mountain from about 75° to nearly vertical. The vein splits in the Aullagas mine, but is undivided throughout the others. Both branches of the split have carried rich ore of the same character as the main vein, and no enrichment has been noted either at or below the junction. It is a pocket fissure, and, as is usual in such veins, the ore is very irregular in value. The thickness varies generally between 2 and 12 in., the richer ore occurring in zones or belts separated by ground either nearly barren, or carrying lower grade ore. These variations occur both horizontally and vertically; in some places the irregularities are abrupt and frequent, forming successions of pockets 1–3 ft. or more wide. The vein matter is usually banded in structure, often containing cavities or “vugs” lined with beautiful crystals of pyrrargyrite and quartz with wire silver. It is clearly defined, and breaks away easily from the country rock. Slickensides and clay gouge are of frequent occurrence. Two classes of ore are distinguished: “broza-guia,” or first class, and “broza,” or second class. The first consists mainly of pyrrargyrite, native silver, and argentite, sometimes accompanied by high-grade tetrahedrite. Associated with these minerals are sphalerite and a little galena. Masses of blende and galena, with ruby, and interlaced with filigree silver, and large pieces of native silver ore, in wire and filigree form, are of common occurrence. The greater part of the value of the ore is carried in

* R. Peele, “The Silver Mines of Colquechaca, Bolivia,” *En. and Min. JI.*

pure massive, crystalline, ruby silver. Large and perfectly terminated crystals of pyrargyrite are often found. The second class consists of the poorer ore associated in the pockets with the first class, and of the lower grade material carried by the vein in the portions lying between the pockets. The values of the two classes vary greatly; the rich ore may be said to run from 500 to 5000 oz., and the second class from 100 to 200 oz. per ton.

Honduras* possesses a remarkable argentiferous deposit known as the Rosario vein, San Juancito. As seen in Fig. 164, it lies partly in sedimentary rocks *a* of Triassic or Jurassic age, and partly in eruptive rock *b* which is a compact rhyolite composed of crystals of oligoclase in a felsitic matrix. In the vicinity of the vein there is no such definite contact between the slate-shales and intrusive rhyolite as exists to a much greater extent in other parts of the mountain. Here, the two interlock in a sort of fringed edge, the rhyolite penetrating between the strata and raising them. The stringers of slate-shales pinch out, however, as depth into the mountain is attained. This argillaceous shale frequently shades into slate on and near the surface, showing all its characteristics except that of cleavage; but with depth it becomes a typical black shale, somewhat baked through the influence of the near eruptive rock.

The regular course of the vein through the sedimentary and eruptive rock shows its origin to have been somewhat later than the upheaval of the latter. The vein is classed as a "diaclyse-" or "fissure-fault," cutting through sedimentary and eruptive rock alike, and traceable for over 6000 ft. It strikes N. 74° 30' E. for more than three-fourths of its length, and despite numerous local curves and bends, its average course is very constant. Its average dip is N. 63°; and this it holds with great regularity as distance or depth is attained. The vein pinches and widens: in some places it is only 2 ft. wide, at others (usually in ore-bodies) 16 ft. between walls; its mean width may be placed at 4½ ft. The walls are well-defined, but seldom equally hard and firm. The foot-wall usually, though sometimes both, is much decomposed and broken in the wider stopes, and a clay parting often runs a foot or two inside of this wall parallel to the

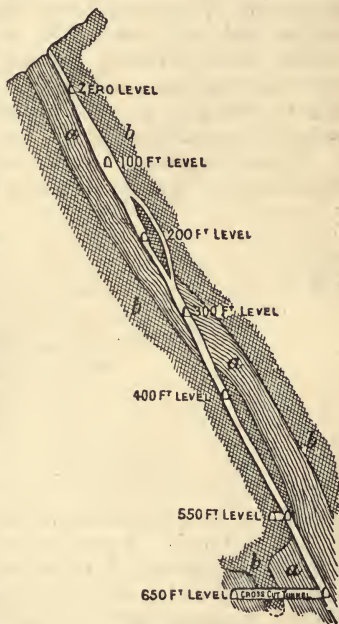

FIG. 164.—SILVER DEPOSITS, SAN JUANCITO, HONDURAS.

* T. H. Leggett, "The Rosario Mine at San Juancito, Honduras, C.A.," Trans. Amer. Inst. Min. Engs., xvii. 435.

vein, necessitating close stulling till the stope can be filled with waste. The vein presents most of the characteristics of a "true fissure" lode, in some places giving beautiful instances of banded structure. Its chief peculiarity is a tendency to split into two distinct veins in the more barren ground, and unite into one consolidated vein where the ore-bodies occur. Here its width is often further increased by the joining of feeders, that usually enter from the hanging-wall. The ore extracted is chiefly from the oxidised zone, and is a thoroughly decomposed sulphuret-ore, carrying much native silver and chloride with free gold and frequent streaks of argentite and other rich silver sulphides. The lower levels show the unchanged sulphides of iron, copper, lead and zinc. The gangue is quartz, carrying in the ore-bodies occasional clay streaks, heavily stained with the hydrated oxides of iron and manganese. Other accompanying minerals, found less frequently, are polybasite, embolite, pyromorphite, wulfenite, cerussite, malachite, azurite, limonite, manganite and pyrolusite.

The mining belt of Peru* is made up of rocks of Jurassic and Cretaceous ages. The great silver region is in the Cerro de Pasco, and

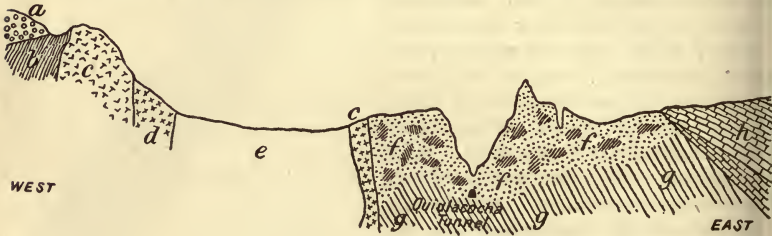

FIG. 165.—SILVER DEPOSITS: CERRO DE PASCO.

limestones bound the argenticiferous formation on the N., and E., and in part on the S. A general section is shown in Fig. 165: *a*, limestone conglomerate; *b*, slates; *c*, unaltered andesite; *d*, altered andesite; *e*, covered by bog; *f*, argenticiferous formation, highly metamorphosed; *g*, slates, sandstones, and limestones of argenticiferous formation very much less metamorphosed; *h*, limestone. In the Cretaceous limestone are numerous veins, some striking N.-S., and some E.-W., reaching 6-10 ft. wide, and carrying rich tetrahedrite and other sulphides. The eruptive andesite is composed essentially of distinct crystals of plagioclase and biotite. The argenticiferous formation lies between the limestones on the E. and the andesites on the W., with an area of $1\frac{1}{2} \times \frac{3}{4}$ mile. Following current phraseology, it may be divided into "surface-deposits" or ground above the water-level, and "deep deposits" or ground below the water-level; and the dividing line between these two classes may be taken roughly as occurring near the general level of the Quiulacocha tunnel, which, driven with varying grades and now caved in places, imperfectly drains many of the mines. This tunnel does not reach the northern or eastern districts, and the "deep deposits" occasionally rise nearly to the surface.

* A. D. Hodges, "Topography and Geology of the Cerro de Pasco, Peru," Trans. Amer. Inst. Min. Engs., xvi. 729.

Above the water-level, the formation consists of a highly metamorphosed and greatly oxidised material, of constantly varying structure, colour, and composition. It is everywhere very silicious, always yields a considerable percentage of slimes when crushed wet, and everywhere contains at least traces of silver, of pyrites and of carbonate of lead (and of lime). Very rarely is the silver visible, even with the aid of the magnifying glass, and then principally in small native scales in connection with quartzite. Very hard and very soft rocks often adjoin, and large bodies of solid pyrites in a chalcedonic matrix are found at varying depths, and generally in close proximity to greatly oxidised material. The rock along the western slope is rather harder, more quartzose, more ferruginous, and on the whole more uniform in its silver contents than elsewhere, and forms what may be called the "cascajo zone," the term *cascajo* being applied broadly to those ores which are worked by the *patio* process. East of this zone the silver is more concentrated in pockets; the percentage of lead carbonate is somewhat greater, and coppery ores are more frequent. But the formation is very much richer in copper in the district southerly and southwesterly of Yanacancha; and the lead-ores occur chiefly at the north-east.

A typical analysis of large masses of cascajo is:—72 per cent. silica, $13\frac{1}{2}$ iron peroxide, $6\frac{1}{2}$ alumina, 2 iron sulphide, $1\frac{1}{2}$ lime and magnesia carbonates, $1\frac{1}{4}$ lead carbonate, .55 manganese peroxide, .5 iron protoxide, .4 zinc, .3 sulphur, .25 antimony, .05 copper, traces of arsenic, and from traces upwards of silver. A hard pyritic ore from deeper deposits shows 40 per cent. silica, $26\frac{1}{2}$ iron, $26\frac{1}{2}$ sulphur, $2\frac{3}{4}$ copper, $2\frac{1}{2}$ antimony, .13 silver, and traces of arsenic and nickel. Gold and thallium are faintly present. Of the silver, 50–85 per cent. is metallic, the remainder occurring as sulphides or antimonides, or with lead carbonate; argentite and sternbergite occur now and then. The pyrites are iron pyrite, chalcopyrite, rarely bornite and mispickel, often a mixture of two or more of these varieties. Pure pyrite is usually poor in silver, but not always. The pyritic material is often associated with silver sulphides, and passes into tetrahedrite, which occasionally is very rich. The sulphurets of silver, copper and iron just mentioned are common to the formation both above and below the water-level, and to the veins in the limestone. Rich masses occur in pockets of greater or less size and irregularly disposed. The common idea that the deposits consist of three great parallel veins does not seem to be borne out, and Hodges regards them as much broken and altered sedimentary rocks (slates, sandstones, and limestones) metamorphosed by andesitic eruptions, and impregnated by subsequent silicious and metalliferous solutions.

The United States have many productive silver-mining districts. In Arizona, the Silver King mine is a central mass or chimney of quartz, with innumerable radiating veinlets of the same, carrying rich silver ores and native silver, in a great dyke of felspar porphyry, with associated granite, syenite (Blake), porphyry, gneiss, and slates, all of Archæan age. The veinlets ramify through the strongly altered porphyry, and form a stockwork, which furnishes the principal ores. In the region are also Paleozoic strata, whose upper limestone

beds are referred by Blake to the Carboniferous. The minerals at the mine are native silver, stromeyerite, argentite, sphalerite, galenite, tetrahedrite, bornite, chalcopyrite, pyrite, quartz, calcite, siderite, and, as an abundant gangue, barite. In the Tombstone district, a great porphyry dyke up to 70 ft. wide, cutting folded Paleozoic strata, and itself extensively faulted and altered, carries above the water line, in numerous vertical joints or partings, quartz with horn silver, free gold, and a little pyrite, galenite, and lead carbonate. Connected with other fissures parallel to this dyke, are bedded deposits in the limestone.

At Calico,* California, most of the ore-deposits occur in liparite (rhyolite) or in its tufas, as veins along fractures and dislocations of a more or less regular character; as simple, once open and subsequently filled fissure-veins; as impregnations along complex fissure-systems, or filling and cementing more or less extensively fractured zones. The gangue is predominantly barite with jasper; the present ores are haloid salts of silver, hydrosilicate and carbonate of copper, resulting from primary rich silver sulphides and copper pyrites. Another class, closely connected with the former, occur as irregular surface-deposits in tufa or (rarely) in liparite, in the former case often approximately following planes of bedding. Still another class of little-investigated deposits are found as veins in the Pliocene sandstone or on its contact with a liparitic breccia. They differ from the rest in carrying a larger quantity of lead-ores. The principal deposits are genetically connected with fractures and dislocations, and their origin is that of usual fissure-veins formed by precipitation or deposition from aqueous solutions. The smaller, irregular surface-deposits, usually occurring in the tufa, carry exactly the same ores as the fissures and are rarely, if ever, found far from them; always, too, on a lower level. The only difference between the two classes of deposits is that the latter carry little or no barite. The most natural explanation is to consider them as having been deposited by the solutions filling the fissures and overflowing from them. The ores are almost exclusively chloride and chlorobromide of silver, usually accompanied along the fissures by a gangue of barite. Calcite is not very frequent; manganese minerals (pyrolusite, &c.) are common; finely distributed rich sulphides occur sparingly. Small masses of a black sulphide of silver, copper and lead have been found. There is a remarkable absence of base metals, and the bullion is usually very fine. A black earthy mass, locally called "black oxide," proves to be a mixture of barite and chloride-ore stained with manganese. The cerargyrite and embolite mostly occur as thin coatings on joints and cracks, but often also imbedded in the barite. In almost all the mines the ore has grown poorer or disappeared before any great depth has been reached; in none of the few exceptions from this rule have the explorations extended more than 200 feet below the surface. On the other hand, the gangue continues apparently without diminishing or changing. Fig. 166 illustrates the formation: *a*, andesite; *b*, sandstones and clays; *c*, liparite tufa; *d*, liparite; *e*, ore deposits.

* W. Lindgren, "The Silver Mines of Calico, California," Trans. Amer. Inst. Min. Engs., xv. 717.

The ore deposits of Ouray County,* Colorado, are either in the Tertiary eruptives or, confined to a relatively narrow zone, in the sedimentary beds just beneath them. The ore-deposits in the igneous formation would be classed as fissure-veins. In addition to these, however, there is a form of fissure locally called "chimneys." In the sedimentary formation, the ore-deposits are either fissures, usually along fault-planes, or intercalated beds between limestone (foot-wall), and a quartzite or shale (hanging-wall). The ore-body of greatest commercial value occurs in the Carboniferous crystalline limestone, at its contact with the overlying pink quartzite. The minimum thickness of the vein material is 3 ft.; but it extends downward into the limestone for a very variable distance, being nearly 100 ft. thick in some workings, and even reaches nearly to the base of the limestone. The greatest longitudinal extent of these bodies of vein-material is in a direction parallel with the strike of the enclosing rocks. The rich ore-bodies in the vein-material are very irregular, and the line of demarcation between rich ore and low-grade vein-material is exceedingly indefinite. There is, however, an apparent tendency of the richer argentiferous iron-ores to assume a horizontal position, while the light-coloured kaolin bands with which the lead-values are associated assume a position nearer vertical along the original fracture-planes of the limestone. The pyrite and the great mass of the vein material is low grade in silver, containing from traces up to 20 oz. per ton. The silver exists as sulphide, rarely native, and masses of sulphide are found almost pure (over 20,000 oz. silver per ton). Fig. 167 shows the formation: *a*, andesite; *b*, upper quartzite; *c*, pink quartzite; *d*, limestone; *e*, lower quartzite; *f*, vein matter.

The Aspen mining district,† Colorado, exhibits an impregnation or mineralisation of the country rock in place, either blue limestone or dolomite, in the neighbourhood of stratified or faulted contacts. The method by which the mineralisation has been produced differs in the cases of the two rocks. The dolomite does not seem to have been more readily decomposed by the mineral-bearing solutions, but owing to its



FIG. 166.—SILVER DEPOSITS: CALICO.

* G. E. Kedzie, Trans. Amer. Inst. Min. Engs., xvi. 570.

† W. E. Newberry, "Geology of the Aspen Mining District," Trans. Amer. Inst. Min. Engs., xviii. 277.

short structure, and many cleavage planes, it has been more readily permeable by them, so that much of the brown limestone ore consists of small cubes of nearly unaltered dolomite, with the valuable mineral deposited mainly in its cleavage-planes. The dolomite has, however, in many cases, thoroughly lost its structure, and is often reduced to the condition of a dolomite sand, impregnated with valuable mineral. The mineralisation of the blue limestone seems to

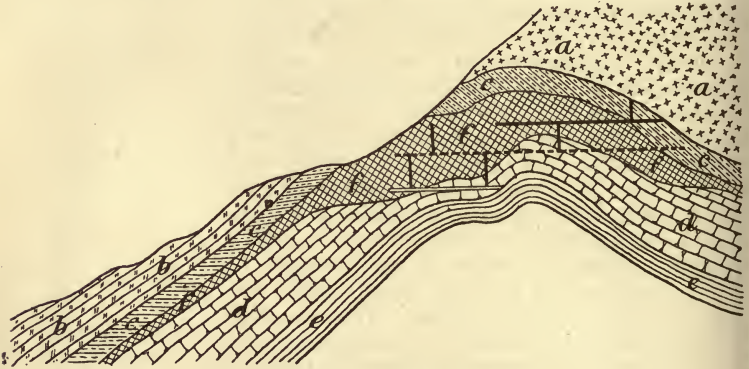

FIG. 167.—SILVER DEPOSITS: OURAY.

have been accomplished by the replacement of a portion of the calcite without materially altering its structure. In many cases the rock retains its appearance, and the mineralisation can only be discovered by assay. Even in such cases the rock usually appears more crystalline and porous than when barren. The faulted contact is characterised by a steeper pitch than the stratified contact, and by the great quantity of wall-rock contained by it, and the strong evidence of motion. There seems to be a general system of ore-shutes in these limestones, having a southerly direction, often interrupted by faults, but probably in many cases continuous along the fault-planes. From the developments so far made, the trend of these ore-shutes seems to be about S. 65° W., swinging slightly to S. with increased depth. The gangue of the Aspen ores is generally either limestone or sulphate of baryta, or both, passing from ores containing as high as 90 per cent. carbonate of lime, to others containing 70 per cent. sulphate of baryta. The amount of silica in the ores is generally small, rarely running over 20 per cent. The bulk of the ore is very low in lead, that containing 25 per cent. being a rarity; an average would contain not far from 55 oz. silver per ton, with less than 5 per cent. lead, and 12–15 per cent. sulphate of baryta.

Custer County, Idaho, contains several well-known mines. The Ramshorn is in metamorphic slates on a fissure vein that has rich shoots of high-grade silver ores in a siderite gangue. Other mines have veins in porphyry, with quartz gangue; and others again are in granite areas. Enormous masses of ruby silver sometimes occur.

At Silver Islet, Lake Superior, is a fissure vein carrying native

silver, argentite, tetrahedrite, galena, blende, and some nickel and cobalt compounds in a gangue of calcite, in flags and shales of the Animikie (Cambrian) system, and cutting a large trap dyke, within which alone the vein is productive. Silver Islet is or was originally little more than a bare rock some 90 ft. square, lying off the north shore of Lake Superior just outside of Thunder Bay, and within the Canadian boundaries. Native silver was detected outcropping beneath the water. The vein was productive to a depth of 800–1000 ft., but below this it yielded little. The trap dyke has usually been called diorite, but is pronounced to be norite by Wadsworth and gabbro by Irving. Some 600,000*l.* was obtained from the mine, yet the expenses were so great in keeping up the surface works against winter gales and ice that but little profit was realised. The vein has been traced 9000 ft., but is nowhere else productive. Considerable graphite has been found in the workings; and according to W. M. Courtis,* the silver deposits of the district are found only where the country rock contains carbon in some form; and the absence of the carbonate spars in the barren parts of the veins seems to indicate that carbon or hydrocarbons played an active part in the deposition of the silver and the formation of the veins. Some of the vugs, both at Silver Islet and the Duncan, contained hydrocarbon gas under great pressure.

Montana is one of the richest silver producing states, notably in the Butte city region. In the basic granite, and north of the copper zone, is a belt carrying sulphides of silver, lead, zinc, and iron in a silicious gangue, but abundantly associated with manganese compounds of various sorts, especially rhodochrosite. No manganese is known in the copper belt, nor any copper in the silver belt—most striking phenomena in veins in the same wall rock. There are as many as 4 distinct veins. All the mines show that the ore and gangue have replaced the granite along a shattered strip, for cross sections exhibit alternations of quartz with ore, rhodochrosite, crushed wall rock, residual clay, occasional horses of granite, &c. In the more silicious granite west of the butte is another silver belt with the same ores. Fig. 164 shows a cross section † of a vein 40 ft. wide: *a*, granite country; *b*, softened granite full of quartz veinlets; *c*, clay wall with decomposed granite; *d*, quartz, broken and seamed; *e*, quartz and manganese spar—"curly ore"; *f*, quartz and ore—"hard vein." The cross-veining of the granite by quartz seams is very extensive, especially at the 300 ft. level. The veinlets intersect each other and form a network, enclosing blocks of granite 1–3 ft. diam. or more. The central portions of all these blocks are hard, dark-coloured, and compact unchanged granite, not affected by the veins, while the rock next to the veins and seams is softened and partially kaolinised, turning a light grey colour. The veins seem to have affected the rock on both sides. These narrow veins extend for many feet with an even width, and do not fault or throw each other at the intersections. The vertical veinlets, 1–6 in. thick, are filled

* Trans. Amer. Inst. Min. Engs., xv. 673.

† W. P. Blake, "Rainbow Lode, Butte, Montana," Trans. Amer. Inst. Min. Engs., xvi. 65.

with sulphides, while the highly inclined or horizontal seams are nearly barren. Below 200 ft., the quartz in the lodes is white, and the metalliferous contents are bright and glancing, giving a brilliant metallic ore, carrying iron pyrites, galena, zinc blende, and sulphide of silver. All these minerals are disseminated in the quartz in a granular, sub-crystalline condition, and in general are in close mixture and association, the exception being the iron pyrites, which is frequently disseminated in the gangue, a little apart from the galena and blende. Wire-silver occurs not only in the quartz vein-stone, or with the well defined ore, but sometimes in the granitic rock of the horses or divisions of the lode, apparently disconnected from any vein-stone. Masses of the "blue ores" are often covered with such filaments and wires of silver, so thickly matted and curled over the surface, as to resemble a woolly covering. These filaments are often several inches long. They are, in general, not much thicker than horse-hair; but specimens have been taken out which exhibit



FIG. 168.—SILVER DEPOSITS: BUTTE, MONTANA.

the silver in curled masses $\frac{1}{8}$ in. thick. Gold is always associated with the native silver. There are some good reasons to support the opinion, that the silver and gold are not disseminated in the bulk of the ore, but chiefly in certain layers or portions of it, and in a comparatively free state, not enveloped or combined with the baser metals or their sulphides. This suggests the possibility of working the ores without roasting. Some of the massive sulphides of lead and zinc, almost free of quartz, contain but little silver. Other portions are extremely rich.

In Deer Lodge County, Montana, are very rich silver deposits in fissure veins in eruptive granite. The pay shoots do not reach within 100 ft. of the surface. A broad zone of mineralised limestone follows the edge of the granite, and contains large bodies of manganese ore carrying more or less silver. The Drumlummon group of veins are on the contact between a granite knob and the surrounding metamorphic schists.

In Nevada, the ores are in general silver-lead in limestone, or veins with sulphides in quartzite and granite. At Hamilton, White Pine County, the ore bodies occur, according to Arnold Hague, in four forms, all in Devonian limestone:—(1) in fissures crossing the anticlinal axis; (2) in contact deposits between the limestones and

shales; (3) in beds or chambers in the limestone parallel to the stratification; (4) in irregular vertical and oblique seams across the bedding. The ore is chiefly chloride of silver in quartz gangue. It is thought by Hague to have probably come up through the main cross fissure, and, meeting the impervious shale, to have spread through the limestone in this way. The ore bodies of the Reese River district are in a hill of biotite granite pierced by a rhyolite dyke. At Tuscarora, the veins lie in decomposed hornblende-andesite.

The great Comstock Lode* is a fissure vein, 4 miles long, forked into two branches above, along a line of faulting in eruptive rocks of the Tertiary age, chiefly andesites. In the central part of the vein, the displacement has been about 3000 ft., shading out, however, at the ends. The ores are high-grade silver ores in quartz, and occur in great bodies, called "bonanzas," along the east vein. Over 60,000,000 lb. in gold and silver has been extracted, in the ratio of two of the former to three of the latter. This remarkable vein strikes N.-S., dips E. about 43°, and is usually 20-60 ft. thick, swelling to several hundred feet in places. The ore bodies are soft and irregular; and the temperature of the workings is excessive (air 126° F. and water as high as 170° F.).

Some of the Utah silver mines have been mentioned under Lead. The Ontario mine,† in Summit County, is on a vein 4-23 ft. (average 8 ft.) wide, in quartzite, which has been worked on a length of 6000 ft.; the best parts of the mine have quartzite walls; the ores are silver glance, grey copper, galena, blende, &c. Similar veins occur in the neighbourhood. In Piute County are a number of mines in quartz-porphry or between limestone and quartzite. At Silver Reef are encountered deposits of native silver, argentite and cerargyrite impregnating Triassic sandstones. Above permanent water line the ore is horn silver; below, argentite. The impregnation is probably due to igneous outbreaks subsequent to the deposition of the sandstone. Even where no silver is visible in the rock it may amount to 30 oz. per ton. The formation exhibits much irregularity and faulting, as seen in Fig. 169: *a*, impregnated sandstone (ore); *b*, barren sandstone.

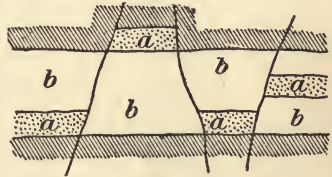

FIG. 169.—SILVER DEPOSITS:
SILVER REEF, UTAH.

Treatment.—The extraction of silver from its ores and combinations is effected by a number of processes, which may be grouped under three heads:—(*a*) Amalgamation, in which the silver is caught in mercury; (*b*) Smelting, where a lead or copper bath is the receptacle of the silver; and (*c*) Lixiviation, or solution in alkaline liquors. Sometimes a combination of two or more processes is employed.

Amalgamation is only adapted to the free-milling ores, generally those found near the surface, and which are free from sulphur. If sulphur is present, it must be removed by a preliminary roasting, which is accomplished in furnaces of several types. The older forms

* J. F. Kemp, 'Ore Deposits,' p. 233.

† Ibid., p. 225.

are the long hand-worked reverberatories (see p. 439), the Howell-White and Brückner revolving cylinders (see p. 439), and later the Stetefeldt shaft, to be now described. More recently, we have Pearce's turret furnace (see p. 440), and others of that type.

The Stetefeldt furnace, Fig. 170, consists of a contracting shaft *a*, heated by two fireplaces *b*; the flue *c* which carries off the waste gases and dust is heated by a supplementary fireplace *d*. The charge is admitted by the iron hopper *e*, provided with a draw-valve *f*, and surmounted by a complicated mechanism for regulating the feed.

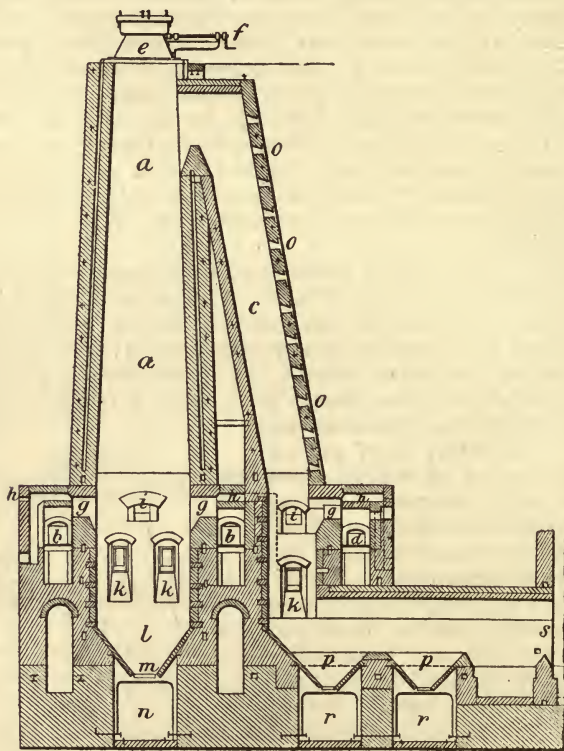

FIG. 170.—STETEFELDT FURNACE.

The fire gases from *b* enter the shaft *a* at *g*, and a supply of free air is admitted at *h* under proper control. These ascend together and meet the falling stream of powdered ore (30–40 mesh). At *i* are peep-holes, and at *k*, openings for the insertion of tools to remove slagged ore from the furnace walls if any should form. The roasted ore collects in the pit *l*, and is drawn away at *m* into cars *n*. The dust flue *c* has a number of working doors *o*, and delivers its accumulations into the pits *p*, which discharge into cars *r*. The fire gases from *d* play over the contents of *p*. Common dimensions are: shaft, 30–35

up to 50 ft. high, and 4-5 up to 6 ft. square; walls, of brick, 8 in. thick and 3 in. apart, the interval being filled with sand or ashes to conserve the heat. In working silver ores it is usual to give a "chloridising" roast, salt being mixed with the ore before charging; it decomposes in the furnace and attacks the silver, forming an artificial chloride. This reaction is favoured by the greatest heat permissible short of sintering the ore, and is prolonged by keeping the ore hot after it has been drawn from the furnace. When running under a strong draught, the capacity of the furnace is large, and fully half the ore passes over into the dust flue *c*, about 80 per cent. falling in the first pit *p*; the usual total amount of dust is 30-50 per cent. By leaving the dust for a long time (some days) in the flue, chlorination is perfected. At *s* the gases pass to a chimney, which should be 50-100 ft. high and 4-5 ft. square, and is best built on high ground. The capacity of the furnace varies chiefly with the ore, say from 30 tons per 24 hours with compact sulphurets to 65-70 tons with loose oxidised ores. The loss of volatilised silver (augmented when antimony, arsenic, or zinc is present) is said to be much less than with reverberatory hearths. The consumption of salt varies much, and can only be determined by experiment in each case. A sufficiency should always be used; but where its cost is very high, it will form a serious item. The Butte ores require 15 per cent., which has amounted to 10s. per ton of ore chloridised. The labour for a furnace treating 25 tons per 24 hours is 1 fireman and 2 feeders per shift. The fuel consumption varies with the ore, but averages $2\frac{1}{2}$ cords good dry wood per 24 hours for 20-25 tons; it may be as little as $1\frac{1}{2}$ cord for very oxidised ore, and as much as 5 cords for sulphides. A furnace to treat 40-100 tons per 24 hours will require 5000 firebrick, 250,000-275,000 common brick, 3000-4000 cub. ft. of stone, and about 20 tons of ironwork. Ores varying from 30 to 800 oz. silver per ton are roasted in this furnace, and the chlorination effected ranges from 85 to 95 per cent.

The "Freiberg" process is also known as the "barrel" process of amalgamation. The following description supposes its application in conjunction with the reverberatory hearth. Points to be kept in view are:—(a) The ore must not contain more than 4 per cent. lead or 1 per cent. copper. (b) There must be 34 per cent. iron pyrites present. (c) The ore is mixed with 10 per cent. salt and very carefully calcined; a double-bedded furnace is the best, being of such construction that the mineral can be gradually raked from the coolest portion of the upper bed to the hottest, and thence through a hole on to the coolest portion of the lower bed, and ultimately to the hottest portion of the lower bed; the heat should be very carefully applied, so as to avoid the clotting of the ore, a mishap to which it is liable on account of the large amount of sulphur present; it should also be borne in mind that at a strong red heat silver chloride volatilises. (d) The calcined ore must be carefully sifted, so as to separate the clotted portions, if any; these latter being crushed and recalcined with a fresh charge of ore. The sifted portion should be intimately mixed with 2-3 per cent. salt, and again calcined. (e) The twice-calcined ore is ground, and passed through a fine sieve. (f) Then

put into the barrels, the charge for each barrel being 10 cwt. calcined ore, 3 cwt. water, and 80 lb. wrought-iron scraps in pieces as small and regular as possible. In charging, the water is introduced first, then the ore, and finally the iron. The barrels are now set rotating, and a thorough incorporation of the mass is attained; this is one of the most important points of the process, as the iron reduces the silver chloride (formed during the calcining) to metallic silver, a process which otherwise the mercury, subsequently added, will have to perform with much loss of mercury in the form of calomel (mercury chloride); after having been rotating for about 2 hours, the contents of the barrels are examined, and a proper consistency is arrived at by adding more water or calcined ore, as the case may be. (g) 5 cwt. mercury is added, and the rotation is continued for about 18 hours, the barrels revolving about 16 times a minute; the contents are then examined, and if amalgamation is found to have taken place satisfactorily, the barrels are filled up with water, and after being rotated slowly for about 2 hours, the amalgam is drawn off, and subsequently the slime, the latter being carefully washed to collect small globules of mercury that may be disseminated through the mass; the matter washed away should be passed over a slime table. The rate of rotation should be neither so rapid as to cause the mercury to stick to the sides of the barrels, nor so slow as to allow it to collect in the lowest portion.

The Patio (Mexican), the Cazo (Chilian), and the Fondo (Bolivian) processes * are virtually one, and are the basis of the practical metallurgy of silver in all Spanish-speaking countries; yet they present some differences worth noting. The ore is usually first hand-sorted according to its richness or to the gangue, and sometimes undergoes a preliminary pile-roasting to remove excess of sulphur; it is then pulverised in stamp batteries, Chilian mills, rolls, or breakers. It next passes to the *arrastra*, a rude yet efficient machine, consisting essentially of a shallow circular space 12–14 ft. diam., paved with slabs of hard stone, and having stone walls 20 in. high, and furnished with a central post carrying 4 arms, each of which drags a heavy hard stone as it rotates, driven by mule, water, or steam power. The duty varies from 500 to 1200 lb. per 24 hours, sufficient mercury being added to amalgamate all the free gold and silver present, and water to make a pulp. The rubbing in presence of mercury renders this a most effective machine, though slow; and the absence of iron-work eliminates one of the sources of trouble encountered in modern machines designed to replace it, when working on acid ores.

Amalgamation in the *arrastra* is only used when the ore carries free gold or silver, or bromides, chlorides, or iodides of the latter. Otherwise, it is simply a fine grinding process in preparation for the *patio*. This is a large court with a paved and slightly inclined floor, on which the liquid pulp from the *arrastra* is spread to dry till it has a thick muddy consistence, when it is piled in extemporised enclosures of 15–150 tons each, called *tortas*, in a bed about 10 in. thick; and 4–5 per cent. salt is evenly scattered over it, and incorporated by spading and more particularly by a laborious process of treading by

* T. Egleston, 'The Patio and Cazo Process of Amalgamating Silver Ores.'

mules, which no machinery has efficiently superseded. The next step is to add the *magistral*, an uncertain mixture of copper and iron sulphates and oxides with many impurities, obtained by calcining copper and iron pyrites, but the efficiency of which depends solely on the copper sulphate present. The quantity of *magistral* used will vary with its quality, but is commonly $\frac{1}{2}$ –2 per cent., depending partly, also, on whether the ore contains antimony, arsenic, sulphur, or zinc; it is applied as a hot solution. Mercury at the rate of 6–8 times the silver contents is introduced by squeezing little showers through canvas bags at intervals, and the whole mass is most thoroughly incorporated—ore, *magistral*, and mercury—by further mule treading. Temperature and correct proportions of *magistral* largely influence the result, excess of either causing an exceptional loss of mercury, which is normally equal to the silver extracted. The operation is very slow, occupying 2–3 weeks in summer and 6–7 weeks in winter. The theory of the process is much debated, but seems to be as follows:—The mercury acting on the copper chloride makes sub-chlorides of both; the copper chloride absorbs oxygen, which acts on the silver sulphide, makes sulphuric acid, and leaves the silver in a metallic state to be absorbed by the mercury; the sulphuric acid set free acts on the sodium chloride, and forms soda sulphate; chlorine is given off, combines with the sub-chloride to make copper chloride, which is again decomposed, and so on. The action of the chemicals in the pile is especially slow if silver sulphide is present, in which case the loss of mercury is also very large; when the whole of the silver is in the state of sulphide, a large part of it, up to 40 per cent., is lost. The mercury transforms the copper chloride into sub-chloride, which, like silver chloride, is soluble in an excess of salt; the sub-chloride in this state acts more energetically on the silver sulphide than the chloride; copper sulphide is formed, while the silver is precipitated, and the copper chloride is formed again by giving up half the copper, which becomes a sulphide. This advantage is gained only at the expense of a very large quantity of mercury.

Test samples are repeatedly taken, and when they show that not less than 75 per cent. of the silver is amalgamated, the mass is washed as quickly as possible, either in a *tina* (mechanical settler) or in a *lavadero* (box settler). The latter (Fig. 171) is built directly on the edge of the patio *a*, the walls *b* being of stone, lined with cement; it measures 6 ft. long, 3 ft. deep, and $1\frac{1}{2}$ ft. wide, and has a platform *c* from which it is fed, and a front of plank *d*, perforated by 6 holes *e*, $1\frac{1}{2}$ in. diam., closed by wooden plugs, which let off the slimes into a vertical partition *f*, whence they pass to the inclined trough *g*, furnished with a series of mercury traps *h*. The material is carried up to the platform *c* by means of the stairs *i*, and is fed slowly into the settler, with a stream of water, while two men get into the settler

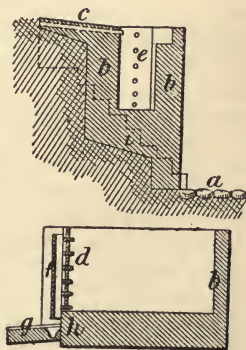

FIG. 171.—LAVADERO.

and keep the contents agitated by their feet, the fines flowing off by the various holes *e* as fast as the water runs in. Much skill is needed to prevent loss of floured mercury with the slimes, and the work is done more quickly and easily by the modern mechanical settling pan. The heavy valuable portions (amalgam, mercury, and unattacked sulphurets) collected in the settler and in the traps are concentrated in various contrivances, and the silver is recovered by retorting the amalgam as usual. The whole process is much more wasteful than the Freiberg barrel, and is only adapted to hot dry climates, but it needs no capital to speak of.

The Cazo or Fondo process is very simple and rapid, and consists in boiling the argentiferous matters, with addition of salt, copper sulphate and mercury, under constant agitation, in order to effect amalgamation. Originally the cazo or cauldron was entirely of copper, but now the sides are generally of wood. Water is added in sufficiency to make the pulp thin, and it is brought to the boiling point before any salt is added; 5–15 per cent of the latter is used. Constant agitation to prevent adhesion to the copper bottom is most essential. Sometimes large pieces (over 1 cwt.) of copper are suspended in the cazo and rotated as mullers. The loss of mercury is only about 2 per cent. Silver sulphides are not acted on, and any present will be found in the tailings. When the ore contains much bromide or chloride, lead to the extent of 25 per cent. of the weight of silver present is first added to the mercury, and thus, by its greater affinity for bromine and chlorine, saves the mercury from attack, and reduces the loss of mercury from 150 per cent. down to 25 per cent. on the weight of silver extracted.

The working of the process of chloridising-roast and amalgamation at the Colquechaca mines,* Bolivia, is as follows:—The rich ore, above 300 oz. per ton, is shipped to Europe; the rest is treated locally. A battery of 11 400-lb. stamps crushes 8 tons per 24 hours in the wet season and 4½ in the dry. Single-hearth reverberatories roast 6 charges, and double-hearth 7 charges, of 400 lb. per 24 hours; and 12½ per cent. salt is added 2½–3 hours after the ore. Fuel is yareta or taquia, 350 lb. for each charge, costing 9*d.* per 100 lb. Labour costs 1*s.* 6*d.* and salt 1*s.* 8*d.* per charge. The fondos take 150 lb. ore and 50 lb. salt every 3 hours; labour costs 1*s.*, fuel 1*s.*, and salt 1*s.* 8*d.* per charge; and 10–12 lb. mercury are used for each 250 oz. silver in the ore, the loss being ½ oz. per oz. silver produced, or 8 lb. mercury, costing 30*s.*, per ton of ore. Wooden barrels sometimes replace the fondos, and take a charge of 600 lb. ore and 200 lb. tailings, requiring 6–8 hours for 120–150 oz. ore, and 15 hours for 250 oz. upwards; each barrel has 25–30 1½-lb. copper balls to mix the charge; salt used per charge, 125 lb., costing 4*s.*; mercury, 1–1½ oz. per oz. silver in ore; labour costs 1*s.* 6*d.* per charge, fuel 5*d.*, salt 3*s.* 9*d.*; total cost, including mercury loss and wear and tear, 7*s.* per 600 lb. The ore generally carries 250–300 oz. silver, and the loss in tailings is 25–33 per cent. The actual cost per ton of 2000 lb. is approximately:—

Crushing: labour, 6*s.*; repairs, 3*s.*; total, 9*s.*

Roasting: labour, 7*s.*; salt, 8*s.*; fuel, 12*s.*; repairs, &c., 2*s.*; total, 29*s.*

* R. Pecke, *op. cit.*

Barrel amalgamation: labour, 5s.; salt, 12s.; fuel, 1s. 6d.; mercury loss, 14s.; repairs and copper loss, 6s.; total, 38s. 6d.

Fondo amalgamation: labour, 13s.; salt, 21s.; fuel, 12s.; repairs, 2s.; mercury loss, 30s.; total, 78s.

Retorting, &c., 5s.; superintendence and office expenses on 150 tons a month, 12s.; general expenses and interest, 8s.; total, 25s.

Grand total with barrels, 5l. 1s. 6d. per ton; grand total with fondos, 7l. 1s. per ton.

Francke's *tina* process is simply a fondo heated by steam and agitated by steam power. The fondo extracts* 80–85 per cent. of the silver in the very base (galena, blende, &c.) Bolivian ores, while the *tina* does better; and the cost of the fondo process at Potosi, running the stamps by water power, is not quite 8l. a ton (2000 lb.). Wendt replaced the local form of calcining furnace by lump-roasting kilns, using no fuel, and reduced the cost to 1s. 8d. a ton, attaining also volatilisation of the antimony and arsenic, and rendering subsequent stamping a very easy matter, but unpleasant owing to excessive dust. Pile-roasting removed more sulphur, but less antimony and arsenic. The sweet ore then goes to the chloridising roast. Rotary roasters gave 10–15 per cent. loss by volatilisation, while 3-floor gas-fired reverberatories reduced it to 5 per cent. Complete oxidation before chloridising is the remedy. Dealing with the 75–80 oz. ores of Potosi, Wendt got an extraction of 80 per cent. (10 per cent. lost in roasting and 10 per cent. in the tailings) silver, 900 fine, costing, on 8 tons a day, about 3l. a ton. The tin oxide encountered in the ore is mostly washed out and concentrated for market before charging into the fondos; it carries some silver when smelted.

At many mines there is considerable ore that is too low grade to justify smelting or preliminary roasting, and not free enough to amalgamate raw. Concentration may then be advisable. As an example of this, the figures obtained at Black Pine,† Montana, may be quoted. The concentrates, 20 into 1, contained 82½ per cent. silica, 9 lead, 8¼ copper, 1·19 sulphur, ·81 zinc, and ·54 silver. A year's working to May 31, 1889, gave 9062 tons crushed; average per stamp, 2·612 tons per 24 hours; average assay of ore, 22·67 oz. silver per ton; concentrates produced, 542 tons; average assay, 136·17 oz. silver; percentage saved, 83·45; total cost per ton, 17s. 6d., viz. 10s. 2d. for labour and superintendence, 2s. for mercury, 1s. 7d. for castings and iron, 1s. 3d. for salt and other chemicals, 10d. for fuel, 5d. for lubricants and illuminants, and 1s. 3d. miscellaneous. The escaping slimes from the mill were found to be carrying 52 oz. silver per ton, or double the contents of the ore going into the battery. This was partially remedied by using the slime waters in the battery instead of clean water, and at the heads of the concentrators. The best size to crush to was found to be 40 mesh. Pan amalgamation is used, the most suitable charge proving to be 50 lb. salt, 2 lb. sulphuric acid, and ½ lb. potassium cyanide, with 100 lb. mercury strained in after the pan has been running 4 hours; the pulp is steam-heated to

* A. F. Wendt, op. cit.

† C. W. Goodale and W. A. Akers, "Concentration before Amalgamation, &c.," Trans. Amer. Inst. Min. Engs., June 1889.

180° F., and the charge is run at 65 rev. for 8 hours; settlers are run 14 rev., and give good agitation with 3-in. shoes.

The ores of the Tombstone district,* Arizona, contain much manganese, the "milling" ore carrying 43 oz. silver per ton having 41-74 per cent. manganese peroxide, and the smelting ore worth 23.3 oz. silver, 47.7 per cent. manganese. Free milling after hand sorting to remove as much manganese as possible only gave 60 per cent. silver recovery with a loss of 7 lb. mercury per ton. Opinions differ as to the precise action of the manganese on the mercury. Goodale says that only the earthy oxides of manganese are troublesome, and that hard granular pyrolusite is harmless; that expulsion of water of composition from wad and psilomelane in roasting destroys their earthy character, and with it their tendency to "foul" mercury. This would indicate a mechanical effect only. Pearce believes that MnO_2 may have an oxidising action on mercury, as the flouring can generally be avoided by adding metal (lead, copper, &c.) more oxidisable than mercury, and per contra, that when amalgamating base silver ores, addition of manganese oxide helps to prevent reduction and amalgamation of the base metals and produces a finer quality bullion. Further, Clark, at the Moulton mill, found that whenever much zinc was present in the ore, loss of silver by volatilisation was greatly reduced by plentiful admixture of oxidised manganese ore. The iron of the pan plays a most important part in pan amalgamation, and great losses may occur in the tailings if for any reason (such as a coating of oxide or slimes) the iron of the pan cannot be attacked by the charge, so that sometimes wrought-iron bands are added inside the pan to ensure a sufficient supply of iron. Lead occurring as carbonate or sulphide was not found (by Church, at Tombstone) to debase the bullion from the pan, but tellurides had a marked effect. With freely amalgamating ore, the pan charge was $5\frac{1}{2}$ lb. salt and 1 lb. bluestone per ton, with a consumption of 1 lb. mercury; as the ores became more sulphuretted, 5.22 lb. salt and 1.2 lb. bluestone, and 1.258 lb. mercury. Subsequent re-working of tailings showed that the mercury was consumed mainly by chemical combination, and was finally lost. Lime in excess, while not preventing reduction and amalgamation of silver chloride, does interfere seriously in pan amalgamation, and the use of lime to prevent amalgamation of base metal will cause loss of silver in the tailings.

In the Boss process, handling of the pulp is avoided, as it flows successively through all the pans and settlers. Obviously this is possible only with pulp which can be worked very thin. At the Garfield mill, Calico, with very free milling ores, the plant consists of a battery of 15 stamps (weight 850 lb., fall 8 in.), fed by the usual Hendy feeder, and the pulp discharged through a 30-mesh screen; 2000 gal. water are used per ton of ore, and about 33 tons are crushed a day. Hot water is used in the battery. From the battery the thin pulp is conducted directly to the first pan. The pans and settlers are all on the same level, and are so connected that the pulp may flow freely from one to another. All are driven directly from the

* C. W. Goodale, "Argentiferous Manganese Ores of Tombstone," *Trans. Amer. Inst. Min. Engs.*, xvii. 767.

main shaft by means of bevel gearing and friction clutches, so that any pan may be thrown out, if repairs, &c., are necessary. In that case connection is established between the others, so that no interruption of the work takes place. The pulp in the isolated pan is then pumped out by means of a siphon-shaped steam-injector. There are 8 pans, $5\frac{1}{2}$ ft. diam., and making 65 rev. a minute; also 3 settlers 8 ft. diam., making 20 rev. a minute. A little mercury is added in the first pan; the muller is let down, and the pulp is ground. Experiments have been made with grinding in the second and third pan also. Exhaust-steam is introduced from below into the false bottoms and cones of all the pans, and a thermometer is attached giving the temperature of the pulp. In the third pan copper sulphate and sodium chloride are added—of the former about $1-1\frac{1}{2}$ lb., of the latter, 8–15 lb. per ton of ore. This is done by means of a self-feeder: a slowly revolving disk with about 10 small buckets filled with bluestone and salt, which are automatically discharged in the pans at certain intervals. In the third pan, the last portion of the mercury is added. In the fifth pan a little caustic lime is fed—also by a revolving automatic feeder—in order to clean the mercury. From the last of the pans, the pulp flows into the settlers, where the remaining amalgam is collected. Sprays of water from pipes, radially arranged, aid the settling. About 95 per cent. of the amalgam is drawn from the first three pans. It is estimated that the purest chloride ores are worked up to 90–95 per cent. of the assay-value; baser ores do not yield more than 75–80 per cent.

Smelting is resorted to when the silver is accompanied by much lead or copper. Indeed, in the United States, where by-products of silver-bearing ores, such as arsenic, bismuth, sulphur and zinc, are disregarded, smelting is the most popular method of treatment for all except the free milling ores, no matter what the gangue. The operation is really a concentration of the precious metal in metallic lead or copper matte, and has been fully described under the respective heads of copper (p. 415) and lead (p. 515). A suggested * modification of the copper process is to concentrate the precious metals in pure copper instead of matte. The extraction is said to be quite as good as with metallic lead, and no loss arises from volatilisation; but the loss of copper in slags is a more serious matter by reason of its greater value ($2\frac{1}{2}$ –4 times that of lead), though this is partly neutralised by the fact that concentration may be carried further (20 to 1 as against 10 to 1), so that charges can be dealt with carrying only 5 per cent. copper as compared with 10 per cent. lead. The method, however, can have but limited application, being adapted only to the uncommon non-amalgamable ores free from lead and containing less than $1\frac{1}{2}$ per cent. sulphur.

The smelting of tailings from the pan-amalgamation mills working on manganese-silver ores at Tombstone,† Arizona, is of special interest. Concentration was effected by trommels, jigs, and buddles; the last-named gave exceedingly good results on the fine, slimy tailings, which Frue vanners quite failed to treat. The buddles were

* H. F. Collins, "Smelting Processes for the Extraction of Silver and Gold from their Ores," Proc. Inst. C.E., Paper No. 2655.

† J. A. Church, op. cit.

15 ft. diam., turned 105 times in 100 minutes, and had a slope varying from 7 in. in $7\frac{1}{2}$ ft. for coarse slimes to $4\frac{1}{4}$ in. for fine slimes, the bed being covered with Akron cement; water jets were used entirely instead of brushes. They treated a ton an hour each constantly, and saved $77\frac{1}{2}$ per cent. of the lead, $55\frac{1}{2}$ of the gold, and 53 of the silver, in addition to which the slimes flowing from them, after settling, gave 8–10 per cent. lead and 12–15 oz. silver per ton, at a total cost of about 5s. a ton of tailings, using steam power and hand labour. The concentrates were made into bricks by binding with pan slimes containing 85 per cent. quartz, 2–3 per cent. clay, and some calcite, manganese, iron oxides, various sulphides, and lead carbonate. The flux used was manganese ore, which presented two peculiarities. The fluidity of the slag allowed less fusible impurities to settle rapidly and completely out of it, and the furnace would accumulate crusts in the hearth with great suddenness. This tendency was increased by the absence of matte-forming materials. The manganese sulphide is dissociated readily by heat, and the small quantity of iron, copper, nickel, and antimony present were just sufficient to make a speiss with the arsenic present. Usually the speiss ran out with the slag; but if anything occurred to stop the flow of materials through the hearth, even for a short time, a crust was almost sure to form, and once formed it was very hard to melt. When the charge was strongly basic, the furnace would melt 50–55 tons a day, but there was a strong tendency to accumulate crusts. With a more acid charge, the work was much more regular, and the furnace melted about 40 tons a day. Though the composition of the slag varied daily, owing to the unfavourable conditions for fluxing, the slags were always very clean and remarkably free from combined lead and silver. Their extreme fluidity and the tenacity with which manganese retains its oxygen, and the readiness with which it gives up sulphur, are probably the causes which contribute to this freedom from lead. The experience obtained indicated that manganese would form an excellent flux in matting-furnaces. The charges consisted of 35.2 per cent. concentrates, slimes, and flue dust, 13.1 ore, 41.1 manganese, 1.4 limestone, 9.2 slag and cleanings; fuel, chiefly American coke, 21.33 per cent.

At the Kelsey mine, California, the assorted ore contains 1000–1400 oz. silver per ton, 7–15 per cent. cobalt, and 2–3 nickel. Dr. Endlich adopts the following method:—The ore is crushed through a 20-mesh sieve, mixed with sufficient litharge to produce an 8 per cent. charge, and enough borax is added to take up the gangue (quartz, heavy spar, lime carbonate, magnesia, and iron). Soda carbonate and flour are mixed with the charge. If the percentage of arsenic in the ore is sufficiently high to produce speiss, none is added; otherwise some metallic arsenic is mixed in. Some sulphides in the ore and reduced sulphur from the heavy spar are utilised to produce mattes. The mixture is melted in large Dixon crucibles; the slag is poured off, and the metallic product is allowed to cool. The bars obtained are composed of lead, silver, cobalt, nickel, arsenic, and sulphur, principally; the lead being in the form of sulphide, the cobalt and nickel in the form of arsenides. The bars contain 4500–7000 oz.

silver per ton. The slag contains a trace of silver, and averages about .75 per cent. cobalt, which can be worked over by arsenising, if desired, and the cobalt obtained in the resulting speiss.

A Mexican method, applicable when the ores contain much sulphur and are easily fusible, consists in liquating the ores in an adobe furnace 10–15 ft. long, with an inclined chimney. A cord of wood will liquate several tons of ore. These chimneys are surrounded with clay to retain the heat. When the fluxes are easily fusible, the furnace is built as a square chimney 10 ft. high and 8–10 in. wide at the base, with a small hole at the bottom for the bellows, and a tap-hole on the opposite side. The charging hole is about 5 ft. from the ground. A quart of ore and 2 quarts charcoal are thrown in alternately until the furnace is full. The furnace is lighted, and soon acts like a blow-pipe on a large scale. An iron bar to skim the slag from the metal is the only tool necessary. The metal is run out into clay moulds. The furnaces have a capacity of about 5 tons a day, and cost 6*l.* for charcoal. A plant of this size can be constructed for about 60*l.*

The ores treated at Las Trojes,* Michoacan, Mexico, are of a class generally deemed unsuitable for smelting, their composition being approximately: 15–30 per cent. silica, 18–25 sulphur, 10–30 iron, 2–12 zinc, and traces of alumina, antimony, copper, lead, and lime. Ore carrying less than 28 oz. silver per ton is not considered worth mining. Heap-roasting as a preliminary loses considerable silver, and leaves 5–8 per cent. sulphur in the ore. The smelting mixture consists of 40 per cent. roasted ore, 35 slag, 10 roasted matte, 8–10 litharge, and 5 lime; or 15–20 oz. silver per ton, 12 per cent. lead, and 2–8 per cent. zinc. A charge is 600 lb. mixture and 80 lb. fuel. The lime costs 19*s.* 6*d.* a ton. The fuel is 31 per cent. coke costing 62*s.* a ton, and 69 per cent. charcoal (principally pinewood, very inferior, and only 50–70 per cent. serviceable) costing 21*s.* 7*d.* a ton. The furnace products are:—(a) “base bullion” carrying .4 per cent. silver, or 75 per cent. of the silver in the original charge; (b) iron matte containing 20 per cent. of the original silver, or 20 oz. per ton, which is heap-roasted and re-smelted; (c) waste slag holding the remaining 5 per cent. of original silver, or 1–1½ oz. per ton. The total cost, including refining base bullion, is 16*s.* per ton of mixture, or 37*s.*–46*s.* per ton of ore.

At Casapalca,† Peru, the great elevation (nearly 14,000 ft.) involves the condition that owing to lessened density, the available air (and oxygen) is only 54 per cent. of what it is at sea-level. Hence roasting furnaces have only half the normal capacity, and smelting furnaces require double the blowing power. Most of the ores carry antimony, arsenic or sulphur, and need preliminary roasting, which is universally done in reverberatories when amalgamation is to follow. Lead does not pay to ship so far, so the silver is extracted by cupellation.

A kind of pyritic smelting is sometimes adopted, e. g. at Mineral,

* J. W. Malcolmson, “Erection of Silver-Lead Smelting Works in Mexico,” Proc. Inst. Civ. Engs., Paper No. 2583.

† A. L. Pearce, “Mining in Peru,” Trans. Inst. Min. and Met.

Idaho, on an ore resembling that of Las Yedras, Mexico (25 silica, 46 calcite, 9·8 iron, 12·5 sulphur, 2·5 arsenic), except for the excess of lime carbonate. According to H. Lang, this ore can be run down at one operation into a high-grade matte at less than the cost of the salt for chloridising-roasting, and the matte can then be refined and its total silver extracted at an additional cost not exceeding that of the chemicals used in Russell leaching. Lang uses no flux, and about 7 per cent. fuel, adapting the furnace and blast so as to burn off most of the sulphur and arsenic, and slag off the corresponding portion of the iron and zinc, utilising the heat of combustion of the elements named.

Wet ways of extracting silver are founded on the solubility of the metal and some of its salts in certain reagents. Experience has shown that the best results are obtained when the silver is present chiefly as chloride, hence a chloridising-roast almost always precedes lixiviation. But highly oxidised ores, where salt and fuel are very dear, may economically be treated raw, though the extraction will be less complete; and in other cases an oxidising-roast (without salt) may be admissible. As a general rule, however, very efficient chloridising-roasting is an essential to high extraction, even more so than when amalgamation is to follow, as in the latter event metallic silver will be taken up by the mercury.

All forms* of furnace have admirers, showing that much depends on the character of the ore. In rotating cylinders and reverberatories the operation cannot be hurried without great loss. Ores which ball badly are not adapted to cylinder furnaces. Moreover, in this form of furnace, as pointed out by Aaron,† the air admitted to the cylinder is not only largely deprived of its oxygen in passing through the fire, but is still further rendered inoperative by the fact that owing to its lightness it will lie above the stratum of heavy vapour (sulphur dioxide, &c.) immediately resting upon the roasting ore; and the admission of cold air below the flames from the fireplace has been proposed as a partial remedy, and proved effective, reducing consumption of fuel and increasing capacity of furnace. The volatilisation and loss of silver in chloridising-roasting is a matter of temperature and duration. In this respect choice seems to lie between reverberatories and the Stetefeldt: in the former, the operation progresses slowly and regularly, avoiding excess of heat at any time; in the latter, the heat is intense but momentary, and the completion of chloridation is effected in the pit under moderate heat. Overheating may also decompose some of the chloride formed.

The most recent development of the Stetefeldt furnace in this connection is the application of gaseous fuel. At the lixiviation mill of the Holden Co.,‡ Aspen, Colorado, coal gas is used for fuel in both drying and roasting. The gas plant consists of Taylor revolving-bottom producers, one 6 ft. diam. for the driers, and one 7 ft. diam. for the Stetefeldt, using local inferior coals. The drying plant con-

* G. J. Rockwell, "Chloridising-roasting and Lixiviation at Yedras Mine," *En. and Min. J.*, Feb. 1888.

† C. H. Aaron, "Notes on the Hydrometallurgy of Silver," *Rep. State Mineralogist Calif.*, 1888, p. 847.

‡ Willard S. Morse.

sists of 4 Stetefeldt double-shelf driers, each fired by 2 gas-burners, $3\frac{1}{2}$ being used for ore and the other $\frac{1}{2}$ for salt, the average moisture being 6·13 per cent. in ore and 1 per cent in salt. The gross coal consumption, at 12s. 6d. a ton, for drying, was 72·22 lb. per ton drier, or $5\frac{1}{2}$ d. a ton; for roasting, 117·44 lb. per ton, costing 9d. The gas is supplied to the furnace by 3 burners, 2 in the shaft and 1 in the flue. Trouble was encountered by condensation of tar in the gas-pipes, and Blauvelt suggests lining the pipes with fire-clay, so that they could readily be burned out, at the same time prolonging the life of the iron pipes. The average composition of the ore chloridised to January 1893 was: 21·64 per cent. SiO_2 , 20·92 BaSO_4 , 10·99 CaO , 10·02 Fe , 8·10 S . 4·24 MgO , 2·85 Zn , 2·27 Pb , and 27·91 oz. silver per ton; after roasting, ·2 per cent. sulphur remains as sulphide.

The lixiviation processes are chiefly as follows:—

Augustine's: roasting the ore to drive off sulphur; grinding the roasted ore; roasting with salt to form chlorides; dissolving out the chlorides with a saturated solution of salt; precipitating the silver by copper; compressing and melting the silver. It is mostly employed on copper mattes.

Ziervogel's: roasting mattes to produce sulphates; decomposing all sulphates except silver; dissolving out silver sulphate in hot water. In practice, it is very difficult to determine the exact moment when all the other sulphates are decomposed and none of the silver is; and to avoid loss by decomposition of silver sulphate to oxide, some is incurred by stopping short of complete decomposition of the other sulphates, whereby some silver is precipitated, and mostly recovered afterwards by Augustine treatment of the residues.

Von Patera's: roasting to drive off sulphur, &c.; leaching with hot water to remove any soluble salts; roasting with salt; dissolving chlorides by sodium hyposulphite (thiosulphate: these salts are commonly called "hypo" in everyday language); precipitating silver by sodium polysulphide; reducing silver sulphide.

Kiss's: same as Von Patera's, but using calcium hypo and polysulphide instead of the sodium salts.

Russell's: roasted and washed ore is leached with sodium hypo and with sodiocuprous hypo; metallic silver and various silver salts likely to occur in imperfectly roasted ores are soluble in presence of the copper salt, and hence a certain source of loss is avoided. Among lixiviation processes this has by far the widest application, and is the most satisfactory. In many cases it would compete successfully with amalgamation on free-milling ores, in cost of plant, cost of working, and percentage of extraction, besides avoiding the heavy dead capital represented by the stock of mercury; and is well adapted for dealing with tailings either from amalgamation or previous lixiviation. The Russell process is, in fact, a modification of or supplement to the Patera and the Kiss processes. In these methods, the extraction of the silver is based upon the fact that silver chloride is easily soluble in solutions of sodium or calcium hypo, and that silver is precipitated from such solutions by an alkaline sulphide, with regeneration of the hypo salts. In case the ore contains lead, a portion of the latter is also dissolved, lead sulphate being soluble in hypo solutions. If, at

the same time, copper is present in the roasted ore in the form of cuprous chloride, the sulphides precipitated from the lixiviation solution contain silver, copper, and lead. From auriferous silver ores, gold is obtained together with the silver, but the percentage of its extraction varies, and depends upon many circumstances. A high chloridation of the silver cannot always be obtained, especially in case the ore contains calcspar, which is converted by roasting, in part, into caustic lime. The caustic lime not only reduces silver chloride to metallic silver, but also greatly diminishes the solubility of most silver compounds in hypo solutions. Finally, though sodium or calcium hypo solution dissolves (besides silver chloride) silver antimoniate and arseniate, and, more or less, metallic or native silver, it does not attack at all either silver sulphide or silver glance, or the group of silver minerals known as antimonial and arsenical sulphides, like polybasite, stephanite, ruby silver, and fahl ore. But these are attacked by Russell's sodio-cuprous hypo. The character of the ore determines the strength and temperature as well as the order in which the two hypos—the simple sodium or calcium hypo, called "ordinary solution," and the compound or cuprous hypo, called "extra solution"—are used. The compound hypo is made as required for each charge of ore by dissolving 1 lb. bluestone (copper sulphate) to 2 lb. crystallised sodium thiosulphate in water. Further, it is known that caustic alkalies in leaching solutions render insoluble certain compounds of silver, and these are apt to occur in all calcareous ores, besides which, if sodium hypo is used, part of it will be converted into caustic soda. The remedy is an acidulated wash before leaching. Russell uses sulphuric acid when his solution contains caustic soda. If an ore containing much antimony or arsenic has been roasted so as to have formed antimoniate, &c., acidulation may be dispensed with, as these compounds are more soluble in caustic solutions. Carbonated alkali is said to be harmless. Neutralising caustic by addition of soda bicarbonate may hinder recovery of lead. Roasted ore is cooled before leaching, moistened to lay the dust, and sifted if lumpy; but it should not be quenched while red hot, or some of the chloride may be reduced to the metallic state by generation of steam.

Russell's method of applying the cuprous hypo is to cause it to pass through the ore in the vat several times, by means of an ejector, after which the liquid is passed to the precipitating tubs, and the ore is washed, first with sodium hypo, in some cases hot, and then, as usual, with water; there are cases, however, in which the cuprous hypo is allowed to stand on the ore during 12 hours. The cuprous hypo is compatible with the Kiss process. Russell discovered that while either hypo extracts the lead from lead sulphate in the roasted ore, they do not dissolve lead carbonate; consequently, sodium carbonate precipitates the lead from such a solution, leaving silver and copper dissolved. The same discovery was made by Aaron and Beardsley, in 1882. But sodium carbonate would also precipitate lime from a calcium hypo; hence the necessity for using the Patera process when this part of Russell's process is to be employed: although, even when sodium hypo is used, it sometimes happens that lime is present (dissolved from the ore), and then it must contaminate the

lead carbonate; in fact, the lead process is not applicable in such cases. This part of the Russell process necessitates an extra set of precipitating tubs, in which the lead carbonate is allowed to settle, after which the liquid is transferred to other tubs in which the silver (and copper) is precipitated in the usual manner. It is claimed that the lead carbonate obtained in this way is nearly free from silver, and otherwise pure in the absence of lime in the ore.

In working the Kiss process, the lead may be thrown down by milk of lime, as hydroxide, and this is done at the Mount Cory Mill, but the product seems to be very impure and to contain much silver. It is contended by advocates of the Kiss process that the precipitated sulphides of silver, &c., settle much better than when sodium polysulphide is used. It is probable that the precipitate might settle badly in an alkaline solution, and the sodium hypo seems much more liable to become strongly alkaline than the calcium hypo, because of the much greater solubility of caustic soda than of caustic lime, and of the complete insolubility of calcium carbonate. It is not easy to make sodium polysulphide quite free from caustic; and, where the precipitant is caustic, the hypo becomes so necessarily, unless means are taken to counteract that effect. It may be that some of the difficulty experienced in the Patera process was due to excessive alkalinity of the solution. Certainly the less liability of the calcium hypo to becoming strongly alkaline is a point in its favour. The choice of a hypo for practical work resolves itself into the choice of a polysulphide. Sodium hypo is easily procured, and one of the strongest arguments in favour of the Patera process is that the sodium polysulphide is made with the expenditure of vastly less time, labour, and fuel than the other. Also, in the use of calcium sulphide, about 3 times as much sulphur is consumed in recovering a given quantity of silver as when the sodium sulphide is used. The choice must depend mainly on the price and purity of the substances used, but the many advantages of sodium sulphide will compensate a considerable difference (to its disadvantage) between the price of caustic soda and that of lime.* The hypo can be used over again, indefinitely almost, as, though it is decomposed in dissolving (and decomposing) silver chloride, it is reproduced in the precipitation of the dissolved silver by the polysulphide. Without this result the hypo would be weakened every time it was used, a portion of it being converted into silver hypo; but when the silver is removed by combination with sulphur from the sulphide, the sodium or calcium from the sulphide takes its place, thus regenerating the original hypo.

A brief account † of the practical operation and plant of the Russell process will sufficiently illustrate the conduct of all lixiviation methods. All crushing (raw or roasted ore) should be dry. Fineness has varied from a maximum of 8-mesh on raw ores to a minimum of 150-mesh in tailings; experiment must determine in each case, and the maximum size be adopted, for economy sake in crushing and facility

* C. H. Aaron, *op. cit.*

† For most minute details see paper by Ellsworth Daggett, "The Russell Process in its Practical Application and Economic Results," *Trans. Amer. Inst. Min. Engs.*, xvi. 362.

of leaching. All charges must be accurately weighed. Rate of leaching is not diminished by increase in depth of charge in tanks; deep charges are most economical, using less water and less salt in solution, as well as less labour. The consumption of hypo will vary between about $1\frac{1}{2}$ –4 lb. a ton for alkaline and arsenical ores, and 3–7 lb. for acid ores; of bluestone, from $2\frac{1}{2}$ lb. a ton raw to $5\frac{1}{2}$ lb. roasted, and from $4\frac{1}{2}$ lb. a ton alkaline to $6\frac{3}{4}$ lb. acid; of sulphuric acid, 1–2 lb. a ton. The use of soda ash as a precipitant for lead saves chemicals in precipitating the precious metals, produces purer bullion, and affords lead carbonate as a marketable bye-product. The first wash-water is admitted to the tank either above the ore (if little silver is extracted by it, or if a larger extraction is not objectionable), or below it (if water is scarce, or if silver extraction is to be kept down), the consumption being 25–40 per cent. less in the latter way; the average is about 40 cub. ft. per ton of ore. The application of water to roasted ore above 150° F. results in solution of about 3 times as much silver as when the ore is below 120° F.; as the wash-water runs to waste, it is highly essential to secure perfect precipitation of all silver it may contain—the other solutions only circulate. This precipitation is often accomplished by iron and acidulation (1–2 lb. acid per ton), heating the water first to about 175° F.; it is thorough, but occupies 12 hours; sodium sulphide acts more quickly but makes a bulky precipitate; dilution with water is simple but uncertain. The second wash-water is only to restore the volume of stock solution; it averages about $5\frac{1}{2}$ cub. ft. per ton. The stock solution is usually made up with $1\frac{1}{2}$ per cent. hypo (94 lb. per 100 cub. ft. water), the amount required for 100 tons (3500 cub. ft.) being 3281 lb.; for 50 tons (2000 cub. ft.), 1875 lb.; for 25 tons (1500 cub. ft.), 1406 lb. The strength can generally be reduced 25–50 per cent. after some experience with the ore. The strength of the cuprous solution varies from .7 to 1.1 per cent. bluestone, and from 1.5 to 2.3 per cent. hypo. The treatment of roasted alkaline ores only needs 4.5 lb. bluestone and 2.9 lb. hypo, while acid ores take 6.1 lb. bluestone and 4.9 lb. hypo on the average.

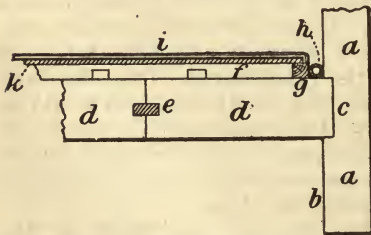

FIG. 172.—LEACHING TANK DETAILS.

The leaching and storage tanks (Fig. 172) are of wood, with straight sides; 3-in. staves *a*, dressed to sweep of tank, and long enough to allow a 6-in. chime *b*; gaining *c* 1 in. deep, done by hand; bottom planks *d* 3 in., grooved and joined with tightly-fitting tongue *e*, $\frac{5}{8}$ by $1\frac{1}{2}$ in.,

plugged with white lead; no nails or screws permissible; painted inside and out; must be tight enough to withstand not only weight of charge, but also pressure of ejectors used to hasten leaching, and of heat applied to wash-waters. False bottoms are wooden slats *f*, $1\frac{1}{2}$ in. high, 1 in. wide, and 1 in. apart, fastened by screws embedded in thick white lead, and leaving an annular space $1\frac{5}{8}$ in. wide all round the tank, which is partially occupied by a ring

of bent wood *g*, 1 in. wide, and the balance by a $\frac{1}{2}$ -in. rope *h*, which secures the filter cloth *i* in place. The latter is of No. 8 canvas duck, cut 6 in. wider than the inside diameter of the tank, to allow for wedging down by the rope, and lies immediately on a sheet of stiff coconut matting *k*. The outlet is in the centre of the tank, and consists of a threaded cast-iron flange bolted to the bottom, all bolts and heads being embedded in white lead.

The working cost of running a Russell plant on 100 tons per 24 hours of pulverised and roasted ore is given by Daggett as follows:—

(a) Maximum.—	Per diem.			Per ton.	
	£	s.	d.	s.	d.
Labour, 13 men at 12s.	7	16	0	1	7
Fuel, $3\frac{1}{2}$ cords wood at 24s.	4	4	0		10
Chemicals	20	0	0	4	0
Repairs, 90l. a month	3	0	0		7
Assaying	1	12	0		4
Total	36	12	0	7	4
 (b) Minimum.—					
Labour, 11 men at 12s.	6	12	0	1	5
Fuel, $2\frac{1}{2}$ cords wood at 16s.	2	0	0		5
Chemicals	11	4	0	2	4
Repairs, 30l. a month	1	0	0		$2\frac{1}{2}$
Assaying	1	8	0		$3\frac{1}{2}$
Total	22	4	0	4	8

Various actual costs per ton of ore are given as below:—

Cusihuiriac, Mexico: including crushing, roasting, re-fining sulphides, &c.	48s. 4d.
Parral, Mexico: on roasted ore at 10 tons a day	36s. 7d.
Do. tailings, 10 tons a day	10s.
Silver Reef, Utah: raw tailings, 40 tons a day	6s. 7d.
Do. raw ore do.	12s.—16s.
Lake Valley, New Mexico: total expenses, 60 tons a day	18s. 7d.

Blue Bird, Butte, Montana: from May 24 to December 8, 1893, treated 15,797 tons (dry) of tailings, the cost being:—Hauling from pits to tanks, 1s. 6d.; labour, 1s. 5d.; chemicals, 1s. 10d.; pumping water, 3d.; superintendence and miscellaneous, 1s. 4d.; total, 6s. 1d. The plant was designed for 60 tons roasted ore daily, and treats 100 tons tailings; cost 4000l. to erect; tanks $17\frac{1}{2}$ ft. diam., $9\frac{1}{2}$ ft. deep, charge 70 tons (dry).

Broken Hill, New South Wales: concentrating mill recovers most of the lead at a total cost of about 10s. 6d. a ton of crude ore; tailings contain much silver, as native, chloride, chloro-bromide, and iodide, often enveloped in silica, which hinders action of leaching fluid; $\frac{3}{4}$ – $1\frac{1}{2}$ per cent. sodium hypo used, with and without bluestone, giving, to May 31, 1892, 304,798 oz. silver from 40,794 tons, at a cost of about 6s. 1d. a ton. Estimated that crushing, chloridising-roast, and leaching will amount to 20s. a ton.

Hofmann's proposal* to replace tanks by troughs for the lixiviation

* Ottokar Hofmann, "Trough-Lixiviation," Trans. Amer. Inst. Min. Engs., xvi. 662.

tion with hypo solutions was based on the observation that speed of extraction is in direct proportion to rapidity of movement of the solvent through the ore. But the benefit thus arising appears to be neutralised by the stratification which ensues in the tanks, a layer of slimes forming on the top and resisting the leaching filtration; besides other objectionable features.

Commerce.—A few statistics concerning the cost of producing silver (1891–92) may be interesting.

Small Hopes, Colorado: total mining cost per ton, 28s. 11d.; do. per oz. silver sold in the ore, 2s.

Alice, Montana: total mining cost per ton, 41s. 6d.; milling, 28s. grand total cost per ton mined, 69s. 6d.; do. per oz. silver produced 4s. 0½d.

Elkhorn, Montana: total mining cost per ton, 42s. 8d.; milling, 37s.; grand total cost per ton mined, 80s. 10d.; do. per oz. silver produced, 1s. 8½d.

Granite Mountain, Montana: total mining cost per ton, 40s.; hauling, 10d.; milling, 39s. 3d.; grand total cost per ton mined, 80s. 1d.; do. per oz. silver produced, 2s. 6½d.

Daly, Utah: total mining cost per ton, 91s. 6d.; hauling, 3s. 6d.; milling, 27s. 7d.; grand total cost per ton mined, 115s. 9d.; do. per oz. silver produced, 2s. 10d.

Ontario, Utah: total mining cost per ton, 69s. 6d.; hauling, 2s. 4d.; milling, 35s. 9d.; grand total cost per ton mined, 108s. 8d.; do. per oz. silver produced, 2s. 3½d.

The world's production of silver in 1891, stated in kilos (of 2·2 lb.) was estimated as follows:—

United States	1,814,642
Mexico	1,275,265
Bolivia	372,666
Australasia	311,100
Germany	180,000
Peru	74,879
Chili	72,185
France	71,117
Spain	51,502
Austro-Hungary	50,613
Central America	48,123
Japan	43,282
Colombia	31,232
Argentine	14,680
Russia	13,847
Canada	12,464
Great Britain	9,075
Italy	8,108
Norway	5,539
Sweden	4,180
Total	4,464,499

SODIUM.

UNTIL the introduction of Castner's process in 1887, the manufacture of sodium was conducted as follows:—An intimate mixture of 30 parts soda carbonate, 13 charcoal, and 7 lime is calcined at red heat, to render the mass more compact, thereby also expelling much carbonic oxide. The calcined mixture is then introduced into wrought-iron cylinders of small diameter, and heated to a temperature of about 2550° F., whereby the alkaline metal is reduced and distilled from the cylinder containing the charge, through a small tube provided for the gases and vapours, into the receptacle known as the condenser. Through a variety of causes, not more than 40 per cent. of the metal contained in the charge is obtained, and in the manufacture of potassium very much less. The wear and tear on the metal cylinders is enormous, and forms a large proportion of the cost of manufacture. To carry out this process and arrive even at these results, requires—(a) most careful grinding and mixing of ingredients; (b) addition of lime to prevent fusion; (c) excess of carbon to ensure contact between the particles of soda and carbon in the refractory charge; (d) previous calcination to make the charge less bulky; (e) wrought-iron in constructing the cylinders is the only practical metal that will stand the high temperature; (f) cylinders must be of small diameter, so as to allow the heat to penetrate to the centre of the refractory charge; (g) exit tubes from cylinders to condensers require most careful attention to keep them open, owing to formation of a black compound by the action of carbonic oxide upon the vapour of the alkaline metal, which combination takes place at about the condensing point of the metallic vapour. This is one of the most serious obstacles in manufacturing sodium, not only causing a large loss of metal, but interfering generally with the operation. In making potassium, the formation of this compound, which is exceedingly explosive, and which is produced even more readily than when making sodium, is the chief reason that potassium costs almost 10 times as much as sodium. The approximate cost of producing sodium by this method is 4s. a lb., the chief items being wear and tear, 2s.; materials, 1s.; labour, 8d.; fuel, 4d.

The reactions by which sodium and potassium are prepared in Castner's method* vary somewhat, but may be generally expressed by the formula

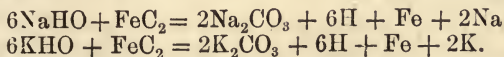

In place of using an actual chemical compound of iron and carbon, as expressed in the above equation, a substitute or equivalent is prepared

* J. Mactear, "The Castner Sodium Process," Soc. Chem. Ind., Mar. 7, 1887.

as follows:—To a given quantity of melted pitch is added a definite proportion of iron in a fine state of division. The mixture is cooled, broken up into lumps, and coked in large crucibles, giving a metallic coke, consisting of carbon and iron, the proportions of each depending upon the relative quantities of pitch and iron used. This metallic coke, after being finely ground, provides a substance having the iron and carbon in a like proportion to an iron carbide, and from which neither the iron nor carbon can be separated by mechanical means. The fine iron is conveniently prepared by passing carbonic oxide and hydrogen, in a heated state, as obtained from an ordinary gas producer, over a mass of oxide of iron, commercially known as “purple ore,” heated to a temperature of about 930° F.

In producing sodium, caustic soda of the highest obtainable strength is used, and with it is mixed sufficient so-called “carbide” to furnish the proper amount of carbon to carry out the reaction. The crucibles in which this mixture is treated are made of cast steel, and are capable of containing a charge of 15 lb. of caustic soda, together with the proper proportion of the “carbide.”

After charging a crucible with the above mixture, it is placed in a small furnace, where it is kept at a low heat for about 30 minutes, during which time the mass fuses, boils violently, and a large part of the hydrogen is expelled by the combined action of the iron and carbon, the “carbide,” owing to its gravity, remaining in suspension throughout the fused soda. At the end of the time stated, the contents of the crucible have subsided to a quiet fusion. The crucible is then lifted, by a pair of tongs on wheels, placed upon the platform of the elevating gear, and raised to its position in the heating chamber of the main distilling furnace. The cover, which remains stationary in the furnace, has a convex edge, while the crucible has a groove round the edge, into which the edge of the cover fits. A little powdered lime is placed in the crucible groove just before it is raised, so that when the edges of the cover and crucible come together, they form a tight joint, and, at the same time, will allow the crucible to be lowered easily from the chamber when the operation is finished, to give place to another containing a fresh charge. From the cover projects a slanting tube connected with the condenser. The condenser is provided with a small opening at the farther end, to allow the escape of hydrogen, and has also a rod by means of which any obstruction which may form in the tube during distillation may be removed. After raising a crucible in its place in the furnace, the hydrogen escaping from the condenser is lighted, and serves to show by the size of the flame how the operation is progressing in the crucible, the sodium actually distilling soon after the crucible is in its place. The temperature of the reduction and distillation has been found to be about 1510° F.

It has been found advisable to use a little more “carbide” than the reaction absolutely requires, and this accounts for the presence of a small quantity of carbonic oxide in the expelled gas, the free carbon acting upon the carbonate formed by the reaction, thus giving off carbonic oxide, and leaving a very small percentage of the residue in the form of sodium peroxide. This small amount of carbonic oxide

rarely combines with any of the sodium in the tube, and so the metal obtained in the condensers is pure, and the tubes never become choked with the black compound. In the preparation of potassium, a little less "carbide" is used than the reaction requires. Thus no carbonic oxide is given off, and all danger attached to the making of potassium is removed. After the reduction and distillation, the crucible is lowered from the furnace, and the contents are poured out, leaving the crucible ready to be recharged. The average weight of the residues from operating upon charges of 15 lb. caustic soda and $5\frac{1}{4}$ lb. carbide is 16 lb. These residues are treated either to produce pure crystallised soda carbonate or caustic soda, and the iron is recovered and used again with pitch in the formation of the "carbide." From this residue, weighing 16 lb., is obtained 13 lb. anhydrous soda carbonate, equivalent to 9.4 lb. caustic soda of 76 per cent. The practical yield of sodium is 2.5 lb., when, theoretically it should be 2.85. The average duration of distillation is $1\frac{1}{2}$ hours, and a furnace arranged for 3 crucibles treats 45 lb. caustic soda every 90 minutes, producing $7\frac{1}{2}$ lb. sodium and 39 lb. soda carbonate. The furnace is heated by gas from a Wilson producer consuming 1 cwt. fuel per hour; and the small auxiliary furnace for heating the crucibles requires a further $\frac{1}{2}$ cwt. The estimated cost is:—

	£	s.	d.
720 lb. caustic soda at 11 <i>l.</i> a ton	3	10	10
150 lb. carbide at $\frac{1}{2}$ <i>d.</i> per lb.	0	6	4
Labour	1	0	0
Fuel	0	17	0
Re-conversion of carbonate into caustic	1	0	0
Total	6	14	2
Less value 475 lb. caustic recovered	2	6	8
Nett cost 120 lb. sodium	4	7	6

or $8\frac{3}{4}$ *d.* a lb. The life of crucibles is found to be about 200 operations, or less than 1*d.* a lb. on the sodium made; and cast-iron is as suitable as steel.

These metals find their chief application in laboratory reagents. Sodium was at one time largely used in making aluminium (see p. 389), and considerable quantities are still consumed in preparing sodium-amalgam for gold mills.

TIN.

THOUGH widely distributed geographically, commercial supplies of tin are obtained from restricted areas. Geologically tin is almost confined to granitic rocks, and mineralogically it is remarkable for occurring practically exclusively in the one form of cassiterite, SnO_2 , binoxide, carrying $78\frac{1}{2}$ per cent. metal, though a sulphide called stannite is encountered as a rarity.

Cornish tin-mining goes back 2000, if not 4000, years, and is entitled to first consideration if only on that account. Formerly large quantities of alluvial tin ("stream tin") were collected in the watercourses, having been derived from the erosion of stanniferous veins; and such tin stone was always purer than vein tin, because associated pyrites had been oxidised and washed away from it. All Cornish tin is now derived from veins, which occur principally in granite; they are also found in the slate (or "killas"), which usually rests on the granite at a high angle. In some cases the junction of these two rocks is nearly vertical; again they are considerably broken and mixed at the point where they come together; and sometimes at these points they are also altered in texture, the granite becoming very fine-grained, and the slate hard and massive. In addition to these rocks are numerous dykes of quartz-porphry, known as "elvan courses," sometimes only a few feet in width, but generally much wider; they traverse the granite as well as the slate without interruption. The mineral veins penetrate the granite, slate, and elvan courses, showing that they were formed since the elvans. It is a common occurrence for the mineral veins to carry copper ores in the slate, tin appearing as the granite which underlies the slate is approached, and eventually, where the main body of granite is penetrated by the vein, the copper ore gives out entirely, and tin takes its place. Every mineral vein or lode throws off branches and stringers into the adjoining country rock, sometimes to such an extent that the main lode becomes divided into a complex network of veins. A lode will also dwindle to a mere line, while some of the stringers become enlarged, exceeding in size the parent vein. Near Redruth are alternations of granite and slate. At the Tincroft mine, granite goes down to 156 ft. below surface, when slate appears, and continues to a depth of 500 ft., at which point the main body of granite reappears. At the Dolcoath mine a large mass of slate rock was met with 2280 ft. below surface; this slate is included in the granite 1440 ft. below the point where that rock was first cut into by the workings, and 1860 ft. below sea-level. The average yield of tin from the rock mined is about 3-4 per cent., or 65-90 lb. per ton. In the Dolcoath mine at 2400 ft. the produce is 300 lb. a ton. Enormous profits have been made in the past from such mineral. Much of the mining is now

carried on actually beneath the sea, presenting many difficulties, and in no place can underground work be better studied.

In Spain are considerable deposits of stream and vein tin, in the province of Orense, the rocks closely resembling the granites, mica-schists, and killas of Cornwall. The alluvials are extensive, 4-12 ft. deep, and carry 3 lb. tin per ton. The veins strike 30° N. of E., averaging 5-8 ft. wide, and dip S., but have not yet been developed.

Burma is the great source of Indian tin supplies. In the Tenasserim division, tin stone is very plentiful, every stream bed near Maliwun in Mergui yielding the metal when washed. Dr. Oldham states that the main source of all the Tenasserim tin is the granite range separating that province from Siam, where it exists as an essential ingredient of the mass of rock, occurring disseminated through the granite in small crystals, and being similarly arranged to the quartz and felspar. The degradation of this granite by weathering through an enormous period of time has supplied the sand which is now so abundantly impregnated with stream tin. At Mergui it used to be worked in the very gardens of the town, and in the Thawbawleck river there have been extensive stream washings for years; the fine sand being sorted out with a cane shovel that acts like a large sieve, and finally washed in wooden dishes, in which the tin sinks by its own weight on the water being revolved. The only European attempt to work Burmese tin on a considerable scale was made between 1873 and 1877, when they not only washed the stream tin, but opened out veins of ore in the hills. During the cold weather of 1874-75 some 7 tons of metal and 14 tons of cleaned picked ore were exported. The works were, however, closed in 1877. It is worthy of note, however, that since the European workers failed, the Chinese have found the mines remunerative, and are still at work there, though they pay a ground-rent and a royalty of 5 per cent. Warth places the average yield at .04 per cent. impure wash tin. Hughes has reported officially on a so-called reef, which he says is "rather a zone of metamorphic rocks through which runs of varying ore-bearing quartzites can be traced. Many of the smaller seams, of a reddish-brown colour, are heavily weighted with tin ore, giving as high a proportion as 60 per cent. The point on which there can be no dispute is that there is a large mineralised zone of rock exposed in the form of a prominent, well-defined hill, which is free from any speculative doubts as to its existence. At the spot known as Khow Muang there are at least 60,000 tons of reef within sight."

Straits tin* forms about a third of the world's production, and the bulk of this is derived from an area 20 miles square in Perak, the Kinta district, from a belt of 1½ sq. miles, having yielded over a million sterling worth of tin in 4 years. The N.-S. mountain ridge traversing Perak consists chiefly of palæozoic rocks, granite, limestone, and syenite constituting the greater part. The granite is porphyritic, containing felspar in large proportions. The limestone

* J. H. Hampton, "Tin Deposits of the State of Perak" Trans. Min. Inst. Cornwall, 1886; E. R. Pike, "Mining in Perak," Trans. Min. Assoc. and Inst. Cornwall, iii. 194; Becher, "Tin Mining in the Malay Peninsula," Trans. Inst. Min. and Met., i.

is a white crystalline mass, the relative age of which is difficult to determine (variously called Devonian, Silurian, and Laurentian), as all evidence of organism has become obliterated. The alluvial tin deposits which rest on these palæozoic rocks exist in the plains, valleys, and gullies, and are of Tertiary age, being an accumulation of disintegrated rock. The beds of alluvium vary in extent and thickness, and are composed of beds of sand and clay resting on the tin "wash," and in which are found numerous trees and stumps in a good state of preservation. The tin wash is found at depths varying from 2 to 35 ft., and with a variable thickness of a few inches to 15 ft., producing at different points very different percentages of tin ore, from $\frac{1}{2}$ to 30 per cent. The wash is composed of pebble-shaped fragments of quartz and granite, and it is this water-worn appearance of the constituents that characterises the tin-producing layers. Tourmaline in large proportions is one of the constituents, and is present in greater quantities than is usual in Cornwall or Tasmania. With a few exceptions the cassiterite is free from pyrites, and each grain of the mineral having a distinct existence, is easily separated from the minerals of inferior specific gravity, and prepared for smelting. The largest grains are found on the tops of some of the hills, while the next largest are in the valleys near the hills, and so a diminution in size is noticeable as distance from the hills is attained. Besides the black tin ore, white cassiterite is of frequent occurrence, and occasionally red or ruby ore. The water in the deposits is in some cases considerable, and the quantity experienced depends on the points at which the shafts are sunk, for in sinking the shaft keeps dry while piercing the clay, and until the sand is reached, when the confined water, finding an outlet, rises to its hydrostatic surface, and necessitates the application of considerable pumping power until the strata are drained. Next to, or underneath the "wash," is a bed of kaolin, or the bedrock, either granite, limestone, or syenite. Pockets and crevices in the limestone are often found filled with tin-producing gravel, but in no case has limestone been discovered to be the matrix.

In Becher's opinion, 1 per cent. of ore is a high average richness for the gravel, as this represents 22 lb. to the ton, or about 40 lb. black tin to the cubic yard; and he considers the average proportion of gravel to overburden to be 10 per cent. of the total alluvium, which would thus contain .1 per cent. of its weight of tin ore. At the lowest computation a Chinese coolie will dig and raise 1 cub. yd. (say 3000 lb.) of ground per day. A yield of .1 per cent. or 3 lb. tin ore from this would be worth 1s. 5d., which is double the ordinary Chinese coolie's wage or the contract price for the job, and at this rate his year's work of 250 days would produce 18l. worth of ore, whilst he actually gets only about 9l. As a matter of fact, a coolie raises 2 cub. yd. a day, and his average production is 800 lb. of ore per annum; and taking it that he is actually employed 200 days in the year on this work only, this yield represents only 2 lb. per cub. yd., or .05 per cent. of tin ore in the total material, which may be taken as a near approach to the actual yield of the deposits together with their overburden.

By the Chinese, these deposits are always worked in opencast,

and never by blocking out with shafts and levels, the whole work of mining and the treatment of the ore being a matter of the most primitive application of manual labour. The valleys, where the Chinese mostly work, are generally very swampy, so a big trench is first dug, some 6 ft. deep, to drain off the surface water. The timber is then felled, and the paddock is marked off. The overburden is taken off by contractors, who get paid about 1*l.* per "chang" (30 ft. square by 1½ ft. deep). The size of a mine is measured by these changs, so that if a mine is 30 changs in size and 30 ft. deep it will cost 600*l.* to remove the overburden. When this has been done, men on daily wages are engaged at about 13*d.* a day to bring up the wash. The overburden and rubbish from each successive paddock is methodically filled back into those last exhausted. Thus the overburden is first entirely removed from each section, and the pay-gravel is then separately excavated and raised to the most convenient and lowest available place for free drainage in the workings, where it is washed in rough sluice boxes, the largest stones in the gravel being separated and left in the bottom. Both overburden and pay-dirt are simply dug by a numerous gang of men at the face, using long-handled hoes, who fill the stuff into small flat baskets, which are slung by rattans in pairs, and carried on shoulder sticks by a still more numerous gang of coolies along a gentle incline or up notched pole ladders to the dump. According to the distance of the latter from the face, it takes 2 or 3 to a dozen carriers to each digger. When working for himself, a Chinaman will bring up 180 lb. in one journey; on the other hand, if working on day wages, it takes a lot of persuasion to make the same man carry 30 lb. even in the Chinese mines.

The workings mostly carry much water, and are usually drained by water-wheels and Chinese pumps. The water-wheels used are about 5 ft. diam. and are always over-shot wheels. There is not only a waste of power, but also of level, as each wheel drops the water at least 6 ft. The Chinese pump ("kinchew") consists of an endless wooden chain, with wooden blades, working through a wooden frame, and over a pulley at each end; the whole framework is placed at an angle, subject to alteration as the mine gets deeper.

This ingenious though cumbrous machine will, when in good order and worked full speed, throw as much water as a 6-in. centrifugal, but only to a height of about 30 ft., for which maximum effect the pump has to be about 100 ft. long, and inclined at an angle of about 25°. Small pumps of this form are worked by man-power, the smallest with hand cranks, and others by treadmills. A wheel and pump about 60 ft. long costs about 60*l.*, and the monthly keep would run to quite 10*l.* In places where water is plentiful, they are cheaper than engines. There is an instance of one of these chain pumps having been run by a steam-engine in Perak with great success. Where water-power is not available, or the water is all required for sluicing, steam-engines are used for pumping, and consequently enable the mines to be worked during seasons of drought, when the water-wheels cannot be used. There are now some 300 such plants in use, consisting of engines of 4-10 nom. h.p. and pumps up to 10 in. discharge. The Malay miners confine themselves to the side-

hill or "lampan" workings, which need no draining or machinery. They begin by diverting a stream, and, when it is possible, running it at a height and allowing it to drop on to the face they want to work. The water falling on the soil disintegrates it, the stuff then running into long sluices with riffles, and being continually stirred up with spades to prevent caking. When the gravel is nearly run off, the residue is taken out and washed, sometimes in pans and sometimes in short boxes. This system has led to the suggestion that modern hydraulic methods might be applied to the less rich gravels lying at lower levels, such as the valley deposits now worked by stripping; but it seems very doubtful whether the flat, forested, or agricultural country would admit of any such operation on a large scale.

Lodes have been recently discovered in the State. In Kinta, they mostly occur in the limestone, and yield copper, sulphur, iron, arsenic, and tin. Up to the present no great depth has been reached, but from the surface down to 30 ft. most of the lodes give great promise of being rich in tin. At the Mahlembu Co.'s claim, large quantities of ore are being shipped to Germany, for which the Company are receiving in some cases 13 per cent. for white tin.

The great preponderance of small mine owners and petty workings is one of the features of backwardness and limitation of profit in the development of this field. Not only is the output less per head of the mining population, owing to the lesser efficiency of small parties without adequate appliances, but much ground is spoilt, and a large proportion of the mineral it might afford is wasted by desultory and unsystematic operations.

Land can be obtained from Government on a 21 years' lease, and *bonâ fide* work must be commenced within 6 months, an average of 2 men per acre to be employed, unless the land is too poor to warrant such expense. All water and water-courses are the property of Government, and on new land sufficient water to wash with is given out by the Inspector of mines. The duty on tin, collected by the Government, is 10 per cent.

The tin deposits of Banca, Billiton, Singkep, and other points in the Dutch East Indies, are mainly alluvial, although some lodes supposed to be of recent origin have been worked. The bed-rock of the country comprises granite, metamorphic slates, quartzites, and sandstones. The cross-section of the Banca deposits would show, following from the bed-rock upward, an average of 3 ft. of tin ore overlaid with coarse sand, followed by red, white, and black clay; then coarse sand with pockets of clay, and layers of fine sand carrying a little tin ore; then humus. The average overburden is 25-30 ft. thick, and the yield from the pay streak about .1 per cent. The tin of Banca and Billiton has been traced to its original sources—the veins in the granite and gneiss. Veins are also found cutting through the overlying quartz-schists, clay-slates, and clay-sandstones, but very little lode mining has been profitably done. Only about one-quarter of the Banca and Billiton tin requires refining; the "black tin" averages 71 per cent. in white metal, and the loss in smelting is given at about 3 per cent.

Stream tin has recently been found in some quantity in the Siak

district of Sumatra, in creek beds overlying granite, with 25-30 ft. of overburden, the pay streak yielding about 1 per cent. metallic tin.

The tin deposits of Tasmania* may be grouped as: (a) alluvial deposits; (b) lodes and veins; (c) impregnations or stockworks. They are generally confined to districts composed of granite or penetrated by quartz-porphry dykes, but at Mount Lyons tin ore is found in Silurian strata, 18 miles from the nearest known granite, though probably the granite lies below at no great depth. The principal alluvial workings are in the north-eastern district, along the valleys of the Ringarooma and George's rivers and their branches; the deposits are of different ages, from Miocene to recent. Some of the older drifts are capped with basalt, and are worked by underground mining, but the most tin has been got from shallow workings by ground sluicing. The easily-obtained ore (.75 per cent.) is now pretty well worked out, and hydraulic sluicing of the larger and poorer deposits is being more and more resorted to. There are still large areas of deep ground to be worked, and tin should be produced from these for the next century at least. In this part of the country the ore appears to be derived from small veins in the granite, and from stockworks rather than from true lodes, for only a very few of the latter have been found, and none has yet been profitably worked. On the Blue Tier the stockworks have been attacked with some success; in these the tin ore impregnates a much altered quartz-porphry, which appears to be intrusive through the main country granite (felspar-porphry). The average value of the rock is quite low ($\frac{1}{2}$ - $1\frac{1}{2}$ per cent. black tin), but as the stuff is in very large quantities, and can be worked in open quarries, it is possible to make it pay. The Anchor mine has opened its deposit over an area of 8-9 acres, and has made profits with only a small and inefficient plant from rock yielding on an average .94 per cent. black tin. With large plant and good appliances, there would be a very large production of tin from these deposits. True lode mining has been but little attempted as yet, and with poor success, though lately the outlook has become more promising, owing to the discovery of richer and larger veins. The celebrated Mt. Bischoff deposit, which yields nearly one-half of the product of the Colony, is partly an alluvial drift and partly a lode, while tin ore also occurs in it impregnating a topaz-porphry; it therefore combines features of all three classes of tin ore deposits. A dyke of eurite and topaz-porphry has been intruded through metamorphic slates and sandstones of Silurian or Archæan age, and along the contacts and in fissures produced by the intrusion, tin ore, associated with much arsenical and iron pyrites and pyrrhotite, has been deposited. In the lower levels the unaltered sulphides are met with, and require to be roasted to set free the tin ore; on the surface, however, the ore is quite oxidised. The Brown Face is an immense mass of gossan containing tin; it is worked as an open quarry 1000 ft. wide and 100 ft. high at very low cost. The lode, which in the underground workings appears as quite a small vein, seems to have widened out to a great size at the present surface

* J. Rowe, "Tin Mining in Tasmania," Trans. Min. Inst. Cornwall, 1886; A. Montgomery, "The Mineral Industry of Tasmania," En. and Min. Jl.

workings. Important discoveries of tin ore have lately been made at North Dundas, the Meredith Range, and at Bell Mount, and it seems likely that the tin-mining industry will increase in importance rather than fall off. At Bell Mount it may be noted that the tin ore is closely associated with bismuth carbonate, specimens being obtainable containing both minerals intermixed, an unusual combination. Miners' wages run high—8*l.*–10*l.* a month, and driving ordinarily costs 4*l.*–5*l.* a fathom.

Australian * tin is generally found in connection with euritic granites, though sometimes the stanniferous granite passes into a micaceous variety. While the tin granite of Australia appears closely allied to that of other countries, and has even been described as exactly corresponding to that of Cornwall, it contains more white orthoclase in its composition and less schorl; in fact, in many places there is a total absence of this last mineral. It is also a much softer rock, more easily eroded; and its easy disintegration is a very important item, as on this greatly depends the extent of the stream deposits. There appear to have been two outbursts of granite, both highly felspathic; the older, which has been the chief source of tin, is euritic, and the second porphyritic, the crystals being white orthoclase. The period between the emissions has not been great, and all of them are tin-bearing. There is a very marked difference, however, in the character of the tin stone from the euritic and the micaceous granite, that from the former being more highly and more generally crystallised and transparent, and that from the latter, when crystalline, being less transparent, but more usually amorphous. The difference is seen, not only in the mode of occurrence in the veins, but also in the stream tin, where it is not derived partly from each kind of granite. In the case of the euritic, the sides of the veins are generally covered with crystals of tin, very transparent; and even when these veins run together, as they often do, and form masses, the ore is always of a more glistening hue when broken. In the micaceous granite, although sometimes crystalline, the crystals are not so perfectly developed, and are dull; while the masses consist of dull irony-looking lumps, and the stream tin is of a dull dirty brown colour. It does not appear, however, to have any effect on the quality of the metal, the tin made from both refining equally well and being as pure.

The sources of Australian tin are threefold:—(a) existing river and creek beds; (b) buried drifts of the Miocene period; and (c) veins in the granites themselves. The first are sometimes enriched by erosions of the second system; they extend for a length of 400 miles along a granite country. The "deep leads" occur wherever basalt joins the granite, and are of enormous extent. Vegetable Creek (Emmaville), New South Wales, has been worked for a distance of about 5 miles along its course with usually great success. Some portions of the ground contained the tin at surface, and in other parts it has been obtained at various depths. The covering in some places is composed of granite detritus cemented together by infiltration of iron. In one mine, the lead has been proved payable for a width of

* S. S. Vale, "Australian Tin Deposits," *Trans. Min. Inst. Cornwall*, 1884.

300 ft., having an average thickness of wash-dirt of 3 ft., containing about 80 lb. of ore to the load of 60 buckets. At Victoria Creek, N.S.W., a tunnel has been driven for a distance of 2000 ft. along the course of the lead, the width being 18–400 ft., with an average thickness of 3 ft. of excellent paying wash-dirt, and at a depth of 60 ft. from surface. On one part of the workings a very hard layer of cement was met with, 14 in. thick, and under it a splendid run of wash was found 2–4 ft. thick; 16 ft. below this again the main lead is worked. In one portion of the lead, tremendous volcanic heat has passed through; everything is charred, even the tin ore. In another place, the phenomena led to a supposition that the tin was *in situ* in a hard elvan rock, but later development showed it to be only a local metamorphosis caused by a flow of basaltic lava, which had hardened the bed. Small patches of tin in the chlorites are only of local occurrence. The permanent sources of tin will be the veins and segregations in the granites. They occur along the whole course of the granite formations, wherever the alluvial ground is found, having a uniform bearing of E.N.E.; varying in thickness from a mere thread to 1 ft.; and are rarely followed to a greater depth than 20–30 ft., when they die out. Occasionally these strings of ore run together and form huge masses of ore; at one place, lumps of solid ore were obtained weighing 50 lb., but it proved to be only an irregular mass. Frequently the ore is disseminated through the rock in fine grains, usually highly crystallised, black, and compact in the euritic, and less crystallised, brown, and less compact in the micaceous, while the tinstone from the former assays higher than that from the latter. The matrix of the tin is principally quartz, and in all cases it is highly silicious; sometimes almost entirely white topaz. In some cases the tin crystals are inside the quartz, and in others outside the quartz, thus showing that they were deposited simultaneously.

The most important tin mines in Queensland are near Coolgarra, in the Herberton district; others are at Cooktown, on the Annan and Bloomfield rivers; and at Stanthorpe, on the border of New South Wales. Herberton is the chief tin-mining centre of Queensland, and the tin is here obtained chiefly from lodes. A very noticeable feature in the district is the occurrence of dykes of some altered basic rock. These dykes are the main sources of the tin ore. They appear to be more prevalent among the sedimentary strata than amongst the granitic rocks. As noticed by R. L. Jack, there exists an intimate connection of the tin deposits with these metamorphosed igneous dykes. These tin-bearing dykes have no prevailing direction. Sometimes they intrude themselves along the planes of bedding of the sedimentary rocks, and at other times they follow joint planes. Cases were noticed in which it appeared as though they have even penetrated quartz reefs. The percentage of tin in these dykes varies very much in different portions. Throughout the "stone," the cassiterite occurs in an exceedingly irregular manner. There are no lodes in the proper sense of the word. The tin ore occurs sometimes in fine "strings" or "leaders," often swelling out into large bunches; at other times a certain amount of the ore is disseminated through the body of the dykes. Some stream tin has been obtained by washing the gullies.

The yield of tin in Victoria is small, and until lately no field of importance had been discovered, but toward the end of 1890 extensive deposits were reported to exist in the Gippsland district, at Omeo and Tarwin. Small deposits have been found in the Beechworth district, at Indigo and Mitta Mitta. The formation in which the lodes occur at Wombat Creek consists mainly of altered slates and sandstones, converted in many places into nodular schists and phyllites. These sedimentary rocks are probably Upper Silurian. They are all highly inclined, and are apparently lithologically similar to the supposed Upper Silurian sediments in the lower part of the valley, which are there associated with limestone and conglomerate beds. The sediments have been penetrated by extensive pegmatite and aplite masses, which, together with other more silicious segregations, form outcrops along the ridges. It is in the former, or associated with them, forming a sort of stockwork, that many of the tin lodes occur. When the stanniferous materials are most abundant, the matrix is a very distinct greisen. The mica (muscovite) is frequently plumosely arranged, and the quartz glassy. In some localities where the lodes traverse the slates the matrix is granulitic. Many of the pegmatite masses are full of tourmaline crystals, and where the latter are most abundant the micaceous materials are either wanting or in smaller quantities. The granitic rock masses with which the tin ore is associated are certainly* younger than the Silurian sediments they invade, and are probably Devonian. The deposits are well situated for economic mining and dressing; yields of the stone vary from 2.9 to 5.85 and average 4.8 per cent. metallic tin.

In Western Australia, tin is worked near Bridgetown. The formation of the district is crystalline schists, gneissic and granitic rock, with numerous dykes of diorite, granite, and veins of tourmaline. The tin-wash of the field varies greatly in thickness (6 in. to 20 ft.), and in richness. No lodes have been found, but from the crystalline, un-waterworn character of the tin they must exist. The field is in its infancy, and, up to the end of 1891, 576 tons of tin ore had been exported. Tin has also been discovered in the alluvial workings at Pilbarra, but the deposits could not be worked, as the mining regulations for working gold and tin clash.

In the United States, cassiterite occurs in small stringers and veins on the borders of granite knobs or bosses, either in the granite itself or in the adjacent rocks, in such relations that it is doubtless the result of fumarole action consequent on the intrusion of the granite. It appears that the tin oxide has probably been formed from the fluoride. A favourite rock for the ore is the so-called "greisen," a mixture of quartz and muscovite or lithia mica, and probably an original granite altered by fumarole action. Topaz, tourmaline, and fluorite are found with the cassiterite, indicating fluoric and boracic fumaroles. Cassiterite seems also to crystallise out of a granite magma with the other component minerals. Narrow veins have been discovered in mica schists with lepidolite and fluorite.†

Of the many American mining ventures which have brought

* J. Stirling, "The Tin Lodes at Wombat Creek," Rep. Victoria Govt.

† Kemp, op. cit.

fortunes to their vendors and disaster to the British capitalist, the tin mines stand out prominently. The Cajalco mine, belonging to the San Jacinto Estate (Limited), in California, has cost approximately 200,000*l.* (including 90,000*l.* purchase money), and from it has been milled about 6000 tons ore, yielding about 120 tons pig-tin (2 per cent. say), value 11,000*l.* Of the Harney Peak mines, South Dakota, it was officially reported in 1891 that there were about 500,000 tons of ore in sight, averaging 14 per cent., while selected specimens gave 30–40 per cent., and that inexhaustible quantities could be got yielding 4 per cent. An expenditure of about 4 millions sterling (mostly English) has not produced more than 10 tons of tin, the fact being that the ore will nowhere average more than 40 lb. to the ton (1.3 per cent.), and cannot be worked at a profit. So much for the developed mines. Undeveloped deposits are reported in Alabama, N. Carolina, and Virginia. At Broad Arrow, near Ashland, Alabama, tin-ore is disseminated in gneiss, the ore averaging about $1\frac{1}{2}$ per cent. black tin, but being very much mixed with titaniferous iron. At King's Mountain, N. Carolina, cassiterite occurs very irregularly in a "greisen" or altered granite, and in limited alluvials derived from the disintegration of the same. On Irish Creek, Virginia, experimental parcels of veinstone taken from deposits in granite have shown $3\frac{1}{4}$ – $3\frac{1}{2}$ per cent. metallic tin, largely associated with arsenical pyrites and ilmenite, which increase the difficulties of concentration and lower the value of the product. The United States virtually produce no commercial supplies of tin.

In Mexico, tinstone has been found at numerous widely separated localities, among which may be mentioned Durango, Cacaria, Potrillos, and Sain, in the State of Durango; Chalchiuites, in Zacatecas; Bolaños, in Jalisco; Cerro de Zamorano, in Queretaro; Cerro del Chiquihuite, in Aguas Calientes; and some places in the State of Guanajuato. None of these deposits has been systematically or extensively exploited, with the exception of those of Durango, where the ore is found to occur in small but frequently very rich pockets in ill-defined veins in trachyte-porphry, which is the common country rock.

Bolivian tin occurs in association with silver. The veins are encountered in porphyritic diorite traversing sandstones and conglomerates, in trachyte penetrating slates, and in slates and quartzites. The silver veins of Potosi carry quantities of tin, the two metals sometimes occurring in distinct bands in the same vein. At Chorolque, bismuth accompanies the tin; and iron pyrites is a common associate. High cost of transportation (on llamas) to market is the chief hindrance to development of the industry.

According to Strauss, very large quantities of alluvial tin exist in Swaziland, South Africa, but are not immediately available on account of lack of labour and difficulties of transportation.

Treatment.—The treatment of stanniferous material is twofold, firstly a mechanical dressing to separate the tinstone or ore proper from the refuse, and secondly, a metallurgical process by which metallic tin is smelted out of the ore. In the case of stream tin the material is already in a form fit for concentration, but vein tin requires pulverising to reduce it to that condition. Nearly all the

Cornish tin is won from veins, and nearly all the foreign tin is alluvial.

The Cornish veinstone is mined and transported to the mill as any other mineral. At the mill it first undergoes a preliminary hand sorting to separate any lumps of copper ore which may be among it, derived, in fact, from the same vein or lode. The first stage in reduction is often accomplished by hammers wielded by women, also by breakers. Next the tin ore passes to the stamps, which are for the most part of simple if not rudimentary construction, as compared

with the modern forms used in milling auriferous rock. Fig. 173 illustrates a pattern possessing some novel features which are claimed * as improvements. The ore is supplied to the feed launder *a* and falls thence into the feed-box *b*, whence it passes at *c* into the mortar proper near the bottom. The shoe and die are made hemispherical in section and the stamp *d* revolves, so that a grinding as well as a crushing action is obtained, and the shape adopted gives twice as much surface as the usual flat form. The battery consists of 8 such stamps, in 2 rows of 4 each. The grating is at *e*. It is recorded that while the "battery sand" or crushed ore of 20 years ago was considered fine enough if it passed through a 30-mesh screen in the grating *e*, now 40-mesh is commonly employed, the reason given being that the tin in the deeper workings is more completely disseminated through the rock

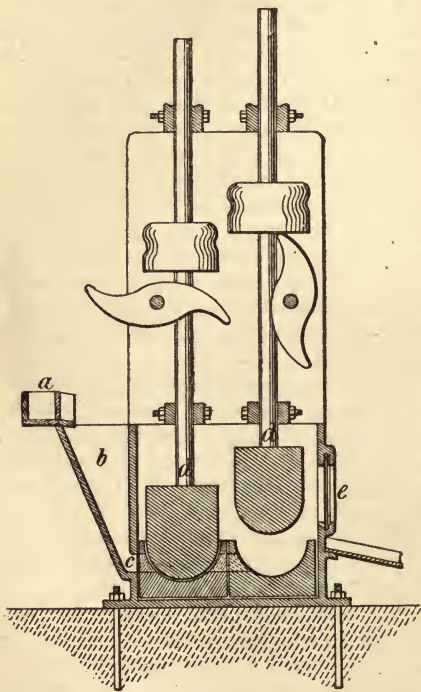

FIG. 173.—TIN STAMP.

in exceedingly fine particles, that in the ore known as "blue peach," for instance, being almost invisible to the naked eye. Stamping is done wet, and the pulp flows from the stamps to a buddle, in which it is settled, so that the heavier metallic particles are deposited in the centre, while the refuse (called "green stuff") is deposited towards the circumference. So much of this central deposit as is not merchantable is calcined ("burned") and then mixed with water, by which means a large portion of the copper is carried off in solution and precipitated; the solid matter is carried into a second

* J. Hicks, "Treatment of Slime Tin," Trans. Min. Inst. and Assoc. Cornwall.

"buddle," from which "black tin" is obtained. The "black tin" concentrates contain an average of about 66 per cent. metallic tin; they are mixed with about 20 per cent. pulverised coal, and smelted in reverberatory furnaces. The tin in the ore is reduced to a metallic state by this treatment, and is tapped out of the furnace into a cast-iron kettle, from which it is afterwards ladled into moulds; the blocks of metal thus obtained are known in commerce as "pig tin." The "burning" or calcining above alluded to expels the arsenic and sulphur carried by the pyrites which accompany the tinstone. The arsenic is collected in separate receivers (see p. 158) and sold. The calcining also affects the chemical condition of the copper, and enables it by subsequent buddling to be further separated from the tin. The product is again buddled and stamped, sometimes several times. The first water, containing copper in solution, is run into pits, and the sediment, containing a large proportion of copper, is sold. By reason of the chemical changes occurring in the "burning," certain parts contain tin, chiefly in the form of oxide, while the outside portions contain little tin, but a certain proportion of copper. So much of the deposit in the buddles at this stage as the workmen think worthless they send down the stream as waste. A certain portion, substantially tin oxide with some copper, is shovelled out and smelted. The residues or discarded portions are known as "leavings" or "burnt leavings," as the case may be. They all carry considerable metallic value, and afford a livelihood to numbers of "streamers," who catch more or less of the escaping metal on various contrivances placed in the streams by which these tailings flow to the sea, the usual harvest of the streamers amounting to about 17 per cent. on the weight of tin saved in the mills. Besides this, an enormous quantity yearly goes to waste, which could certainly be profitably saved by more efficient concentrating apparatus, such as the Linkenbach buddle.

The wash brought up in the Chinese diggings in Perak is generally put in a big heap and left to dry in the sun. By this means a lot of the clay becomes friable, and puddling, which is a very expensive process, is avoided. When all the wash has been brought to surface, a wooden box is made, about 30 ft. long, with a fall of about 1 in 10, according to the class of stuff to be washed. The washing is performed by shovelling the stuff into the box, allowing a stream of water to run over it, and agitating it by means of long hoes. The clean mineral carries 66-67 per cent. tin, and goes to the furnace. The smelting is carried on in a cupola furnace, about 5 ft. diam., made of well beaten clay (supported with stakes arranged around it, and bound with iron rings), hollowed in the centre, into which the tin ore and charcoal are put; the metal runs out of an aperture in the bottom, and is caught in a small cell made on the ground, from whence it is ladled into moulds well prepared in the sand, and after cooling, is ready for the market. At the back of the furnace is a hole made for the admission of air and for raking the charge. The blast is furnished by hand bellows and a bamboo. Charcoal is universally used as fuel, and great damage is done to fine

timber by the promiscuous burning of valuable wood. A company recently are buying a great deal of ore from the Chinese in Kinta, and smelting it in Singapore.

The vein tin raised in Tasmania is treated first by sluicing in boxes on the mine to get rid of clay and soft iron oxide and to get out some free tin ore, and after this partial concentration, is sent to a reduction mill, where it is crushed by stamps and concentrated on a very complete system of V classifiers, jigs, concave buddles, and convex slime tables. The proportion of slimes is about 33 per cent. The clean ore is smelted in the Mount Bischoff Company's smelting works in Launceston, in small reverberatory furnaces. Slack coal from Newcastle, New South Wales, is used as fuel, and a little lime as flux. The dressed ore received for smelting averages 72 per cent. metallic tin, and the average yield is 67.73 per cent., the smelting loss being therefore 4.27 per cent. The tin ingots are of good quality, averaging 99.85 per cent. pure tin.

At Kangaroo Flat, Australia, the cemented wash-dirt is puddled as well as sluiced, at a cost of 9*d.*–10*d.* a ton.

Commerce.—The annual production of black tin in Cornwall is about 14,000–15,000 tons. The Malay Peninsula in 1866 exported 5692 tons; in 1874, 13,566 tons; in 1883, 17,195 tons; in 1889, 28,492 tons, showing a constant and steady increase. What is known to the trade as "Singapore" tin comes partly from Perak, partly from Sungi, Ujong, Selangor, Kwalla Lumper, Jelubu, and Malacca; "Penang" tin is all from Perak; what is known as "Straits" tin in London is Penang and Singapore tin; and what is known as "Malacca" tin in the United States is also Penang and Singapore tin, specially branded for the American buyer, who is every year taking an increasingly large proportion of the total shipments (about 30 per cent. in 1891). Banca and Billiton produce about 10,000 tons annually, of which some 7500 tons go to Holland. Tasmania exports 3000–3500 tons yearly; Queensland, 2500–3000; New South Wales, apparently 4000–5000 tons, but these are chiefly re-shipments of Tasmanian and Queensland produce. California sometimes affords 50–60 tons. Bolivia is a steady shipper of 1500–2000 tons a year, all to England.

The greatest consumption of tin is for making tinplate—exceedingly thin sheet iron covered with a tin coating—and the great development of this industry of late years has been in the canned provision trade. The market values of tin, and therefore of its ore, fluctuate seriously, if not suddenly, say from 30*l.* to 90*l.* a ton for pig-tin. The basis of valuation of tin ores is by chemical assay, the percentage of metallic tin being worked out as tin oxide (black tin). Certain impurities or foreign substances detract from the market value of the sample. Titanium is not of serious moment. Tungsten lowers the standard, though, when a market can be found for the product, the ore may be freed from tungsten by treating with soda sulphate, and washing out the soda tungstate. Tantalum and niobium are found as the minerals columbite and tantalite in many samples of tin ore, and are injurious by alloying with and lowering the quality of the tin during the smelting. All impurities, such as sulphur, pyrites (iron or copper), arsenic, &c., lead to deductions by the

smelter, as they increase the cost of treatment. At Singapore, the smelting charges are 5*l.* 5*s.* a ton on ore assaying 70 per cent. and upwards, 6*l.* for 65-70 per cent., and 7*l.* for 60-65 per cent.; in addition to which, deductions are made of .2-.5 unit per cent. of impurities, and further deductions for smelting losses, viz. 2 units on ore assaying 70 per cent. and over, 3 units on 65-70 per cent., 4 units on 62-65 per cent., and 5 units on 60-62 per cent., so that an impure and low-grade ore may suffer as much as 12½ per cent. discount.

TUNGSTEN.

THE element tungsten has the general characteristics of a mineral; but it is also capable of acting as a non-metallic element, and can form an acid—tungstic acid. It is in this rôle that it is always found in nature, as the tungstic acid salt of iron, manganese, calcium, or lead. The most abundant is wolfram, a mixture of tungstates of iron and manganese in varying proportions. The tungstate of iron may replace the manganese almost entirely, when the mineral receives the name ferberite, or the manganese may replace all the iron, giving the mineral hübnerite. Besides these, scheelite, the tungstate of calcium, scheelitine, tungstate of lead, and wolfram ochre, the anhydrous acid itself, are found in small quantities. In Europe and America, wolfram is almost the only ore raised; in New Zealand, the more important deposits are scheelite. The output is always exceedingly uncertain. Thus the production of wolfram in the United Kingdom rose from 1 ton in 1880 to 380 tons in 1885, fell to $\frac{1}{2}$ ton in 1889, and reached 140 tons in 1891. The two chief applications of tungsten are in the metallic state for alloying with iron, and in the state of soluble tungstates as a mordant and fire-proofing medium for textile fabrics. In order to produce tungsten steel it is necessary in the first place to rid the wolfram of the impurities which it contains. Accordingly it must, in the first place, be roasted, then treated by dilute acid, and finally washed with water. In this manner the sulphur and arsenic are eliminated. After being dried, the residue is raised to a strong heat in crucibles lined with damp charcoal, the tungstic acid is reduced to the metallic state, and a compound is formed containing iron and manganese; 5–25 per cent. is added to the steel, according to the proportion of tungsten desired.

The preparation of soluble tungstates and simultaneous purification of the tin ore with which the wolfram is associated, is effected as follows:—The tin ore is dressed as perfectly as possible in the ordinary manner; then, having ascertained the proportion of wolfram in it, such a proportion of soda ash or crude soda is added as will provide an equivalent of soda for the tungstic acid of the wolfram present. The mixture is then put into a reverberatory furnace (Fig. 174), and there roasted at a low red-heat, until a combination is effected between the tungstic acid and the soda. The iron with which the acid had been previously in combination is at the same time converted into a peroxide, and rendered sufficiently light to be washed off with facility. When the roasting is completed—which may be known by the change of colour, and by the mass assuming a slightly pasty condition—the charge is drawn through a hole in the bed of the furnace into the “wrinkle” *a* beneath. A fresh charge is introduced through the hole *b* in the crown of the furnace from the “dry” *e*; and as soon as

the charge is spread over the bed *c* the furnace is shut, the fire *d* is made up, and it is left without further stirring, until the surface of the charge assumes the appearance of becoming moist, with a slight hissing or frizzling sound. In the meantime the charge, while still red-hot in the interior, is removed from the "wrinkle" and thrown into a cistern of water. The water thus heated dissolves the soda tungstate; the solution is run off from a hole in the bottom, provided with a suitable filter, to prevent the running out of the tin ore.

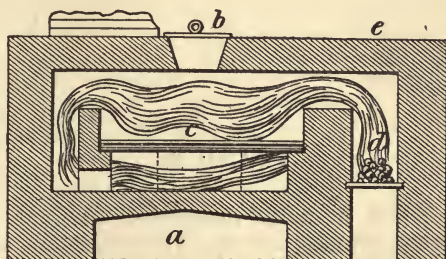

FIG. 174.—WOLFRAM FURNACE.

Fresh water is again run on, to wash off the remainder of the soluble matters; and the tin stuff is then removed from the tank to the burning-house dressing-floor for final treatment. The strong solution is evaporated in iron pans to the crystallising point, when it is drawn off into coolers. After a few days a crop of crystallised soda tungstate is obtained; and the mother liquor is again treated in a similar manner for the obtaining of a further quantity of crystals. The washings of the tin stuff run off from the tank are used instead of plain water for the lixiviation of fresh charges from the furnace.

URANIUM.

THOUGH never found in large quantities, uranium is widely distributed, and forms several minerals. The commonest is pitch-blende, a compound oxide, containing $81\frac{1}{2}$ per cent. uranium, 4 lead, and $\frac{1}{2}$ iron, with oxygen and water, and sometimes magnesia, manganese, and silica. Usually it occurs only in small pockets, as in Annaberg, in Saxony, but a distinct vein of it has been found and worked at the Union mines, Grampond Road, Cornwall. Uranmica, containing 61 per cent. uranium oxide, with phosphorus and copper; uranium-ochre, uranocalcite, and trogerite, and even less common minerals. The ore as mined in Cornwall affords 18–29 per cent of the metal, and is by far the most important commercial source; it is calcined, powdered, dissolved, and precipitated; the precipitate, filtered and dried, goes into the market as a yellow powder of uranium sesquioxide. Very small quantities have been at intervals produced in the Black Hills, South Dakota. The chief application of the oxide is for porcelain staining, though proposals have been made to substitute the metal for gold in electro-plating, and to utilise its high electrical resistance in electric lighting. The market price of the metal is about 18s. a lb.

ZINC.

THIS useful and well-known metal occurs in a variety of forms, the most common being:—

	Per cent. Zinc.
Zincite, red oxide, ZnO	80
Blende, black jack, or sphalerite, sulphide, ZnS.. .. .	67
Willemite, silicate, 2ZnO, SiO ₂	58½
Calamine, hydrated silicate, 2ZnO, SiO ₂ , H ₂ O	54
Smithsonite, carbonate, ZnO, CO ₂	52
Christophite and marmatite, ferro-zinc sulphides	30-40
Franklinite, a mixture of zinc, iron, and manganese oxides	5½

Zinc ores are very generally an accompaniment of lead ores, and their geological occurrence has been already in part described; but some remarkable instances of lead-free zinc deposits are encountered in the United States, and will be further discussed.

The chief British mine, Minera, near Wrexham, dates from Roman times, but has only of late years been a zinc producer of any importance, the galena giving place to blende as depth is reached, so that the mineral raised now affords about 7½ per cent. blende and only 1½ per cent. galena. The deposit occupies a faulted area varying from a knife edge to 18 ft. in thickness, averaging perhaps 6 ft., in Carboniferous limestone and Millstone grit, the gangue being calcite.

The most important deposits of Germany are those of Upper Silesia, which occur in the beds of the lower "Muschelkalk," and extend from Tarnowitz in a south-easterly direction through Beuten to Poland. The ores consist partly of carbonate and silicate of zinc, with compact blende, but principally of zinciferous brown ironstones, "red calamine," and "white calamine," the white generally forming the lower bed and the red the upper. The product is about 60 per cent. calamine and 40 per cent. blende. In the Eifel limestones (Iserlohn, Arnsberg) occur irregular fissures filled with calamine and concretions of blende; and similar deposits are found in the Devonian limestone of Altenbühen, and in the magnesian limestones of the same age at Gladbach, near Cologne. At Diepenlinchen, near Stolberg, this stockwork formation occupies an area 125 yd. by 50, which is removed bodily for treatment. The Lüderich mine is on a shattered zone in the Lenneschiefer beds (Middle Devonian). At Wiesloch, in Baden, is an important deposit of calamine in the "Muschelkalk." Blende occurs with the lead ores of the Upper Harz, particularly in the district of Lautenthal, and in connection with the lead and silver ores of Freiberg and with the lead ores of the Holzappel group.

At the New Pierrefitte mines, France, the chief product is argentiferous galena, contained in a granulite gangue, irregularly impregnated with magnetite intermixed with blende; the very

ferruginous varieties called christophite and marmatite are often present. The ore as mined carries about 20 per cent. blende, 20 per cent. magnetite, and 1-2 per cent. argentiferous galena.

The Spanish mines of Reocin and Udias in Santander and of Linares in Teruel, produce large quantities of very rich calamine (49-54 per cent. metal).

The important beds at Ammaberg, Sweden, exhibit a mixture of blende, pyrite and pyrrhotite, with other non-metalliferous minerals, impregnating a kind of gneiss, the mica of which is often replaced by the ore. Galena is not mentioned as an accompaniment, and is probably absent, as the Vieille Montagne Co. which works these deposits extensively produces a remarkably pure zinc.

In India, zinc is only found to any extent in Oodeypore, where the Jawar mines were formerly worked on a large scale, and yielded a yearly revenue of nearly $2\frac{1}{4}$ lakhs of rupees. At present no extensive zinc workings exist in India, though possibly the indications of the metal at both Sirmur and Tavoy might yield profitable results to scientific development.

The United States* possess several important zinc mining centres, sometimes in common with lead ores, sometimes remarkably free from lead. At Saucon Valley, Pennsylvania, occur zinc-blende and its oxidation products, calamine and smithsonite, filling innumerable cracks and fissures in a disturbed magnesian limestone, thought to belong to the Chazy stage. There are three principal mines, the Ueberroth, the Hartman, and the Saucon, the first-named being in the portion which is tilted nearly to a vertical dip and is much disturbed, while the next is where the dip has gradually decreased to 35° . The mines are on a belt some $\frac{3}{4}$ mile long. At the Ueberroth an enormous quantity of calamine was found on the surface, but it passed in depth into blende, and was clearly an oxidation product. In the others, the blende came nearer the surface. The ore follows the bedding planes and the joints normal to these throughout a zone 10-40 ft. across, and fills the cracks. At the intersections the largest masses are found. Six larger parallel fissures were especially marked at the Ueberroth. A little pyrite occurs with the blende, and thin, powdery coatings of greenockite sometimes appear on its surface, but it is entirely free from lead, and a very high grade spelter is made from it.

At Franklin Furnace and Sterling, New Jersey, is an enormous continuous bed 2500 ft. long, 8-30 ft. wide above, and swelling to over 125 ft. at 200 ft. in depth, consisting of franklinite, willemite and zincite, in crystalline limestone of Cambrian, Lower Silurian, or Archæan age, according to different geologists. The ore bodies are interbedded in the limestone, and are associated with much magnetite. The ore consists of franklinite in black crystals, set in a matrix of zincite, willemite, and calcite. The richest ore lacks the calcite, and consists of the other three in varying proportions. This best ore is in largest amount in the Buckwheat mine, beyond the trap dyke

* F. L. Clerc, in 'Mineral Resources,' 1882, p. 358; Kemp, 'Ore Deposits,' p. 174; W. H. Case, *En. and Min. Jl.*, Sept. 16, 1892; E. C. Moxham, *do.*, Nov. 25, 1893; W. P. Blake, "Zinc-ore Deposits of New Mexico," *Trans. Amer. Inst. Min. Engs.*, 1894.

which cuts it. The limestone containing the ore has a notable percentage of manganese replacing the calcium— $16\frac{1}{2}$ per cent. $MnCO_3$. An explanation of the deposit is that the franklinite bed is an "original manganese-zinc-iron deposit in limestone, much as many Siluro-Cambrian limonite beds are seen to-day, and that in the general metamorphism of the region it became changed to its present condition" (Kemp). The ore is easily mined and requires little selection. The cost of mining and putting it on rails should not exceed the cost of quarrying an equal amount of limestone. An average sample would contain about 36 per cent. zinc oxide, 22 per cent. metallic iron, and 11 per cent. metallic manganese. Owing to its low percentage of zinc and high percentage of iron and manganese, this ore is unsuitable for the manufacture of spelter. The mechanical separation of the zinc ore has been found impracticable on account of the intimate chemical and mechanical mixture of the different ingredients. The ore is, however, particularly adapted for the manufacture of zinc oxide, or "zinc white," for which purpose it is exclusively used. The calamine got at Sterling, being lead-free, makes an excellent spelter.

In the Upper Mississippi lead region are extensive shallow deposits of "dry-bone" (smithsonite, or zinc carbonate), some portions of which are very rich, but these rich layers are ordinarily only a few inches thick. Above and below them are more important layers largely contaminated with limestone, too lean to work as spelter ores, and not amenable to concentration. They have been used to make zinc oxide, and have given a yield of 30–33 per cent.

The Gagnon vein, near Butte, Montana, exhibits the remarkable feature of very large quantities of rich silver- and copper-bearing zinc-blende, some thousands of tons of which were mined and smelted, principally at Argo, Colorado. Smelter-returns show varying contents of shipments as follows:—silver, 50–200 oz. per ton; copper, 1–42 per cent.; and zinc, $7-48\frac{1}{2}$ per cent. The occurrence of blende containing so large a percentage of copper is remarkable. Probably, however, the varieties which are so high in copper have undergone some change, the copper being enriched by the oxidation and partial disappearance of the zinc. Very fine specimens of goslarite (zinc sulphate) are now to be found on the walls of the levels in the Gagnon, which would indicate beyond a doubt that the zinc-blende has been oxidised to a large extent. The same influences which effected the oxidation and removal of the zinc may have caused the disappearance of a portion of the silver; for as a rule, in the lots of ore smelted, an increase in the percentage of copper accompanies a corresponding decrease in silver-contents; and the presence of native silver in very thin plates throughout the masses of the blende would indicate some sort of secondary deposition of the silver. The gangue is quartz and feldspar, with occasional barite.

The largest Virginian mines are in Wythe County, and of these the Bertha is best known. According to Boyd, there are in one section 486 ft. of strata impregnated with lead and zinc in varying amounts. Farther east, other openings of considerable promise have lately been made at Bonsacks. The zinc ore bodies are at times of

great size (40 ft. wide), and are associated with more or less of lead minerals and iron pyrites. The Bertha ore, which is free from lead and iron (hence its high value), has a gangue of soft, unctuous clay ("buckfat"), somewhat difficult to dissolve, and of a specific gravity approaching that of the ore, calling, consequently, for careful treatment in separation. The ore as mined contains about 26 per cent. zinc. The mine yields 12,000–15,000 tons of unwashed ore to the acre, and the ground is now being worked over at the rate of $3\frac{1}{2}$ –4 acres per annum. The output is 200 tons a day, hoisted from 17 shafts, with a working force of about 300 men.

The zinc deposits of south-western New Mexico occur in a region of palæozoic (probably Lower Carboniferous and older) limestones, resting on granite (containing much epidote), and both traversed by intrusive porphyry dykes. The zinc ores comprise the carbonate (smithsonite), with some calamine, and were at first quarried at the surface, and then followed downward in irregular pits and cave-like excavations, in some instances to a depth of 60 ft. or more. The ore occurs in irregularly concentric crusts or layers, or in cavernous masses made up of small layers or concretionary sheets of pure carbonate ore, sometimes in close association with aggregations of small quartz crystals, the presence of which reduces the percentage of zinc—and, consequently, the commercial value—so much as to prevent profitable shipment. The best carbonate ores, assayed by the car load, contain 35–38 per cent. metallic zinc. The excavations upon these carbonate ores show that they occupy cavernous spaces in the limestone strata, and irregular openings between the beds, gradually thinning out to mere seams. Doubtless they originally existed as sulphide, which occurs abundantly in the same region; it is the dark reddish-brown variety, rich in zinc and free from arsenic and antimony. It does not appear to be highly argentiferous, and is an excellent ore for making spelter. It is granular massive, and exists in beds sometimes 20 ft. or more thick. It is usually intermingled with iron pyrites in grains and bodies of irregular shape dispersed through the mass. The deposits are generally lenticular, and are classed by Blake as "contact deposits, or segregations following the dykes or the planes of metamorphism." The blende is closely associated with a garnet rock (grossularite) and with actinolite, and Blake remarks that this "remarkable association of large beds of zinc-blende with pyrite, hematite, actinolite and grossularite in lenticular layers, and in disseminated particles in the substance of the actinolite and the garnet rock, forming great contact aggregations or segregated beds in limestone, appears to be unique." The associations are also highly detrimental, for the garnet is so heavy that it cannot be mechanically separated from one portion of the blende, and the pyrite mixed with the other portion impairs its value for either spelter or oxide, until transportation facilities permit of dressing by steam power. Smithsonite carrying 35 per cent. zinc and upwards is profitably disposed of at 4*l.* a ton.

Treatment.—The first operation with all zinc ores is a process of dressing, to separate the zinciferous portions from the plumbiferous or the ferriferous, as the case may be.

An example which well illustrates the mode of procedure in the former case is afforded by the Lüderich dressing floors of the Vieille Montagne Co. Here the veinstuff, as it comes from the mine, is divided into fine and rough. The former is at once washed, crushed, sized and jigged. The latter goes first to the breaker. An ordinary arrangement of trommels divides the stuff into classes according to size (3·7, 5·2, 7·2, and 10 mm.), and each size goes to a separate jig which divides into: (a) galena, (b) mixed galena and blende, (c) blende, (d) mixed blende and waste, (e) waste. The sand is lifted by a centrifugal pump to a system of pointed boxes, and is here divided into 6 different sizes of grain, clean water being supplied. Each size is conducted to a Harz jig in which a similar separation to that already mentioned takes place. The overflow from the pointed boxes carries the slimes to a set of 2 pyramidal boxes, and the two sizes of deposited slimes are treated separately on revolving convex tables. These tables are 14 ft. diam. have an inclination of 1 in 12, and revolve twice in 5 minutes. The waste sand is piled near the works, and the fine slimes are filtered, the waste water escaping in a remarkably clear condition. The dressing operation requires a supply of 9 cub. m. of water per minute. This is pumped a short distance by steam power. The engine driving the whole of the machinery is 60 h.p.; the steam pressure is 6 atmos., and 90–95 tons veinstuff are treated daily, this quantity producing on an average 28 metric tons of blende a day. The galena produced is about 20 tons a month. The ore may be classed into $\frac{1}{3}$ lump, $\frac{1}{2}$ grain and $\frac{1}{6}$ fine. Selection is carefully carried on underground, the deads being systematically employed for filling. The veinstuff is brought from the mine by an inclined railway, the daily quantity being 50 tons, exclusive of "smalls."

Quite a different method is required at the New Pierrefitte* works, where iron is the principal ingredient to be eliminated. The ores contain blende intermixed with magnetite, which occurs minutely disseminated through the blende and accessory galena, and gangue. The intermixture is very irregular, magnetite aggregates varying from minute quantities to such a proportion as to form a practically massive mineral. The formation also contains small quantities of magnetic pyrites. Very ferruginous varieties of blende, as christophite and marmatite, are also present. On the average, the ore may be taken to contain 20 per cent. blende, 20 per cent. magnetite, and 1–2 per cent. argentiferous galena, the remainder being gangue. When the blende is massive, dressing is a simple and easy process, the magnetite being in very small proportion, and chiefly with the gangue, so that jigs and buddles readily afford a product carrying 45 per cent. metallic zinc. But when the blende is less massive, there is invariably more magnetite present, both in gangue and ore. The blende itself is also more ferruginous in composition, and consequently contains less metallic zinc, and the above operations become no longer possible. To treat this latter class of ore, and the middlings and bye-products from the former operations, the *modus operandi* is to crush the ore to the

* H. L. Lawrence, "Dressing of Zinc-blende Ores and Magnetite at the New Pierrefitte Mines," Trans. Inst. Min. and Met., iii. 92.

required size, classify, treat the coarser classes on jigs, and the slimes on buddles or tables. The jigs can be made to yield:—(1) mixed galena and magnetite, which present no difficulty in final cleansing; (2) mixed magnetite and blende, which can be magnetically separated, giving—(a) pure blende for market, (b) magnetite, (c) middlings, consisting of particles of mixed blende and magnetite; also all magnetic pyrites which is not magnetic enough to pass with the magnetite. The buddles yield in the first washing:—(d) headings consisting of galena, blende, and magnetite; (e) tailings consisting of waste. The headings (d) can now be magnetically separated, and the final freeing of galena from blende can be effected on Rittinger tables or other appliances.

Comparing the two methods of dressing before magnetic treatment and magnetic treatment before dressing, the former has the advantage, as the valuable galena is freed from the blende at the outset, and no re-crushing of these two minerals together is necessary, thus avoiding the tedious and often wasteful operation of treating their slimes. Further, the middle product is minimised in quantity and confined to the very poor, almost unprofitable, ore, consisting of highly ferruginous blende and magnetic pyrites. The magnetic separator, having less bulk to treat, can be regulated and adjusted to requirements of each class of ore, which can be passed in rotation as demanded. On this principle, the works were erected.

The ore is dumped on to a platform, and fed to a pair of Cornish rolls fitted with Raff wheel. The main sizing screen is wire-wove, and has 4 holes to the inch. A bucket elevator carries the pulp to 3 classifying trommels, the first of Cornish gauge, No. 17; the second, No. 28; the third, No. 36. A Spitz-gerinne divides out a fourth class, and 4 4-hutched Green's jiggers are arranged to receive and treat the classified pulp. The overflowing slimes pass on to 2 Spitzkasten, and are separately treated on 2 Rittinger revolving continuous buddles. The waste is here extracted, and the headings are magnetically treated, the final separation of galena and blende taking place on 2 Rittinger percussion tables.

The first hutches of all 4 jigs catch all pure galena, and all galena mixed with magnetite. The second hutches deliver a mixed product of galena, blende, and magnetite. This is re-jigged on the auxiliary machines, which are of exactly similar pattern to the others. Here the last remnants of galena are freed from the remaining pulp, which consists of blende and magnetite. Nos. 3 and 4 hutches give blende and magnetite, with most of the magnetic pyrites, a proportion of which passes over with the tails. The first or galena products, both from main and auxiliary jigs, are passed on to the ordinary fine roller house, where they are cleansed in conjunction with the jig-middlings from the main lead-dressing floors. The blende products (Nos. 3 and 4 hutches) from main and auxiliary jigs, consist, for the most part, of homogeneous grains of magnetite and blende. There is, however, a certain proportion of stuff chiefly coming from the coarsest jigger composed of grains which are a mixture of blende and magnetite.

To separate the pure blende from the magnetite, and prevent the grains of mixed blende from passing into the latter, the Sauter-Harlé

(Paris) magnetic separator (Fig. 171) is used, as it allows of making a middle product, so necessary to the success of the operation, by partitioning off at *a b*. The magnets are sufficiently strong to develop a magnetic force corresponding to 1680 watts. The catch-board and division were added at the mines, after careful experiment as to their position and size. This machine has a capacity of 20–30 tons mineral in 12 hours, and costs 170*l*. The feed has to be regulated according to size of ore, nicety of work required, and proportion of magnetite to other ingredients. This separator works on dry ores only. The wet products from the jigs are taken to sloping platforms outside the building, to allow excess of moisture to drain off, and thence they pass to drying floors. These consist of a double series of brick flues, each with an ordinary brick furnace, and covered by cast-iron plates $\frac{1}{2}$ in. thick. The dry ore passes to two separators, one of 900 watts

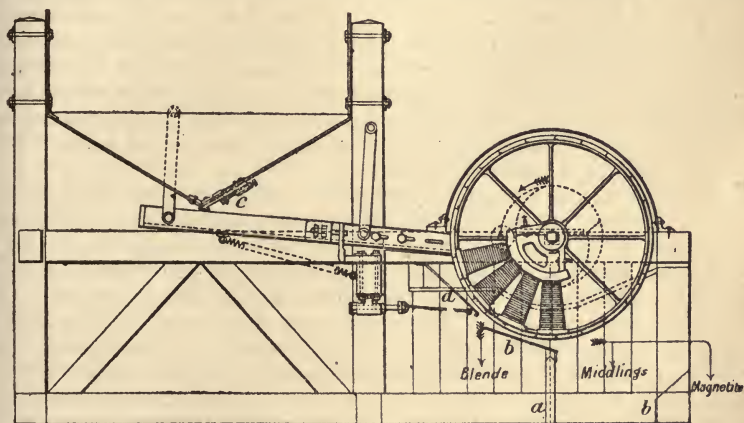

FIG. 175.—MAGNETIC SEPARATOR.

being sufficiently powerful for treating the fines. The number of revolutions of the drum best adapted for good work has been found to be 56 per minute. The feed can be regulated by opening or shutting the hopper door *c*. Coarser stuff requires slower feed. The apron *d* is advanced when magnetite is abundant, and pulled back when there is less. The proportion of blende to magnetite and middlings varies with the ore, but usually 50 per cent. of marketable (97 per cent.) blende is obtained, assaying 48.6 per cent. metallic zinc, and containing 2 per cent. magnetic matter, and 1 per cent. pyrites and gangue, at a cost, including coal and repairs, of about 5*s*. per ton of crude ore. If no "middlings" are made, it is impossible to get the blende above 40 per cent. metallic zinc, without great losses, and smelters do not care to buy below 45 per cent. The middlings are a non-marketable article at present prices, though they carry 25–27 per cent. zinc.

Certain Spanish ores,* consisting mainly of ferruginous calamine, and earthy or calcareous brown hematite, which it is impossible to

* A. L. Collins.

separate by hand picking or dressing; are crushed and roasted in reverberatory furnaces with an admixture of coal, by which means the hematite is reduced to magnetic oxide of iron. On subsequent treatment by magnetic separators, it is found that this artificial magnetite is easily separated, and saleable zinc ore is left behind. The expense of roasting must be considerable, but as the calamine ore is always roasted in any case before export, to lower the freight charges, it is not so great as it seems.

In Wisconsin, Blake dresses a mixture of blende and pyrites carrying 20 per cent. blende, and gets a 60 per cent. product, by very careful oxidation of the pyrites without altering the character of the blende and galena, which he achieves by calcination in presence of abundant unburned hot air, using Siemens regenerators.

At the Bertha works, Virginia,* the dumping or storage bins for receiving the calamine as it comes from the mines are provided with a water-carriage system. The bins consist of timbered trestles built out from a hillside and provided with V-shaped floors, down the centre of which passes the water-trough. The ore, having been dumped, is fed regularly into the water-trough, and is carried by a current of water down to the dressing-house 1300 ft. below. The troughs or "flumes" are 12 in. wide and 6 in. deep, made of cast iron. The water required is pumped up from the river by heavy Worthington pumps, through a 6-in. column pipe, to a large tank on the hilltop, whence it runs into the flumes. The zinc ore brought down the flume falls upon a "grizzly" (through which the large lumps are broken), and passes into a single, revolving log-washer, which gives it a gentle primary sluicing, and where the adhering clay and "buckfat" are separated and dissolved. The lumps are then crushed by a Blake breaker and a pair of Cornish rolls, after which the ore is sized by a conical, perforated revolving screen; the large pieces drop upon a steel-plate conveyor, where they are hand-picked, while the smaller pass down to 4 sets of Parsons jigs, on which they are thoroughly concentrated. The tailings from the above treatment pass through a spitzkasten or classifier, and thence to 2 Harz jigs. The slimes are discharged into a slime pond, whence the muddy water is drained off into the river. The capacity of the dressing-house is 80 tons concentrated zinc ore per day of 10 hours. The yield is approximately one-third of the crude ore treated, and the product gives the following average analysis when dried at 212° F.:—Metallic zinc, 38.08 per cent.; zinc oxide (ZnO), 47.61 per cent.; silica (SiO_2), 29.37 per cent.; oxides of iron and alumina (Fe_2O_3) and (Al_2O_3), 9.23 per cent.; combined water, 8.23 per cent.; calcium carbonate ($CaCO_3$), 4.54 per cent.; magnesium carbonate ($MgCO_3$), 2.07 per cent.; lead, trace. For drying the concentrated ore a roasting plant is attached to the dressing-house, containing an 8-ft. Taylor gas-producer and cylindrical revolving roaster 30 ft. long. The dried product is then shipped to the smelting works.

Calcination of calamine in Sardinia is performed variously in kilns, flat-bedded reverberatories, &c. At Buggerru, Oxland calciners (see p. 157) have replaced the reverberatories, making about 15 rev. an

* E. C. Moxham, op. cit.

hour. The ore passes through in about 4 hours, and loses some 28 per cent. by weight, each furnace yielding about 12 tons calcined ore per 24 hours. The 3 Oxlands, costing 975*l.*, turn out 36 tons daily, as against 5 reverberatories, costing 1000*l.*, 32–33 tons, and the difference in working cost per ton of output is: (a) Reverberatory—wages, 1*s.* 9¼*d.*; fuel, 3*s.* 11*d.*; tools and sundries, 4*d.*; repairs and general charges, 8½*d.*; total, 6*s.* 9¼*d.*; (b) Oxland—wages, 8*d.*; fuel, 3*s.* 2¾*d.*; tools and sundries, 2¾*d.*; repairs and general charges, 8*d.*; total, 4*s.* 9½*d.* The fuel used is a mixture of coal and lignite. The Oxland consumes 15·11 per cent. less fuel than the reverberatory, but this is reduced to 12·41 per cent. by that required for generating motive power.

At Monteponi, Sardinia, the Ferraris furnace is used. This is a gravitating calciner, similar in principle to that of Moser, used for calcining small spathic ore at Eisenerz, in Styria. It has a bed about 38¼ ft. long and 6½ ft. broad, inclined upwards from the fireplace to the flue at a slope of about 1 in 3½. The furnace is heated by a gas-producer burning lignite on a step-grate, and having an air-heating flue round the fireplace. Two similar beds are united in one block, and have a gas-producer and stack in common, the heat being regulated by dampers in the flues, which direct the flame from one bed to the other as required. The ore, fed into the furnace through a hopper into a short vertical shaft at the upper end of the bed, forms a conical talus, which is gradually driven down the slope as fresh material is added above, and falls over the slope at the bottom into a receiving-chamber, whence it is drawn at intervals of about 4 hours. The ore remains in the furnace 25–30 hours; the yield is 20–21 tons in 24 hours, with a loss in calcination of about 25 per cent. Using lignite carrying 12½ per cent. ash, costing 15*s.* 10*d.* a ton, the working expenses are—wages, 1*s.* 9½*d.*; fuel, 2*s.* 9½*d.*; repairs, 2¼*d.*; total, 4*s.* 9¼*d.*

The fume from blende roasting contains sulphates of zinc and iron. At the works on the Rhine it is usually leached in water and the solution treated with lime, precipitating the zinc as hydroxide; but the precipitation is only partial, and the lime is very destructive to the furnaces. Another method, invented by Dr. G. Krause-Cöthen,* consists in precipitating by sodium carbonate, producing an artificial calamine carrying 45–50 per cent. zinc. Leaching is done hot, and sodium carbonate is added in excess; the mixture is filtered, and the filtrate contains, besides the zinc and iron carbonates, some glauber-salt, which is recovered by treatment with sulphuric acid and evaporation. Operations on 1000 kilo. fume, containing 11 per cent. zinc and 2 per cent. iron (both as sulphates) gave 200–250 kilo. calamine, carrying 45–50 per cent. zinc, and 260 kilo. anhydrous glauber-salt, which covers the cost of the 190–200 kilo. sodium carbonate used.

The dissociation of the zinc from its ores is effected by distillation in fireclay vessels in presence of carbon, followed by condensation out of the reach of oxidising agents. The dimensions of the distilling vessels are restricted within very narrow limits by the nature of refractory materials and the thickness of the charge through which

* Berg. u. Hütt. Zeit., 1891, p. 246.

the necessary heat to effect reduction can be economically transmitted; the operations to which the ore and products must be submitted are numerous, and the repeated handling of them cannot be avoided. The recent improvements in practice have not been the results of changes in the form of the furnaces so much as the application of regenerative gas heating instead of direct firing, leading to a saving of fuel, an economy of labour, a prolonged life for the retorts, and an augmented yield of metal.

The zinc ores smelted at Freiberg are black blendes, containing an average of 35 per cent. zinc, 30 per cent. sulphur, and 4-5 per cent. lead. They are arsenical, and very ferruginous. They are first calcined in kilns, to utilise the sulphur, and again roasted in reverberatory furnaces with double stages until they contain no more than 1 per cent. sulphur. They are then distilled by the Silesian process in furnaces, each of which contains 32 muffles, heated by gas on the Siemens regenerative principle. The charge of each muffle is 100 lb. calcined blende; the distillation of this quantity lasts 24 hours, and produces 32 lb. zinc; 50 lb. coal and 5-6 cub. ft. wood are consumed as fuel to each muffle. The muffles last about 6 weeks. The product is ultimately refined by fusion in a reverberatory furnace.

The Boëtius zinc furnace* has 2 gas generators, the gases traversing half the length of the furnace, then passing down a channel, and thence into the flues between the muffles. The air necessary to combustion is obtained partly directly into the gas shaft, and in part through passages in the walls of the furnace. Thus the gases are partly burned in the upper portion of the generator, but mainly in the furnace itself, by means of air channels which are fitted at their inlet with regulating screws, so that the furnace temperature may be under perfect control. The heat is thus evenly distributed, and the muffles are therefore not destroyed so frequently. To carry off the fumes, which are so annoying to the workmen, a flue passes along the top of the furnace connected with the hood of each pair of muffles. At the Lipine works, Silesia, a movable iron hood connected with an iron flue passing just through the roof serves the same purpose, but is useless when the wind is high and causes a down draught. Glazed muffles have been used at some works, but the ordinary form is generally adopted. These cost 4s.-5s. apiece, with an average life of 32 days. Dagner's condenser† has been tried at several works in Silesia, but the yield of metal does not appear to have been finally increased, though more oxide is obtained. The originally increased yield gradually became less as the condensers became older and cracked, until at last it was but little greater than by the previous method. One advantage of this system lies in the fact that the nozzles need not be removed in order to ladle the zinc. Cylindrical upright nozzles, as at the Hohenlohe works, collect a larger portion of the dust and oxide than those generally used, and when employed in conjunction with Dagner's condenser, no zinc flame appears at the orifice, and the gases pass out through a conical nozzle on the side nearest to the furnace, and thus are far removed from the workman.

* K. F. Föhr, *Berg. u. Hütt. Zeit.*, 1883-4.

† *Ding. Polyt. Jl.*, 236, 486.

A flap-valve at the bottom of the nozzle allows the zinc-dust to be removed.

The Bertha smelting works, Virginia, consist of 10 large Welsh-Belgian furnaces, having 140 retorts or pots each. Each furnace consists of a large skeleton combustion chamber with iron pigeon-hole front, into which are set the retorts. The latter are 4 ft. long, and have an inside measurement of 8 by 10 in., being elliptical in section. They are luted into the furnace with ordinary clay. The retorts are made of selected fireclay, capable of making a tenacious paste, which can be formed into the desired shapes without pulling apart and cracking. It must also be absolutely fireproof, so that the retorts will not weaken or break when resting upon their extreme ends in the furnace at a white heat. The following is an analysis of two clays, No. 1 being found slightly the better because more elastic, and because it will bend slightly before breaking, at a very high degree of heat:—

	No. 1. p. c.	No. 2. p. c.
Silica (combined)	38·10	40·50
Alumina	31·53	35·90
Combined moisture	11·30	12·80
Titanic acid (TiO ₂)	1·50	1·30
Free silica (quartz)	12·70	6·40
Potash (K ₂ O)	·40	·28
Soda (Na ₂ O)	none	·16
Iron sesquioxide (Fe ₂ O ₃)	1·92	1·10
Hygroscopic moisture	2·50	1·50

The cost of one retort, dried and ready for use, is in the neighbourhood of 4s.

The calcined ore, mixed with the proper proportion of anthracite coal, is charged into these retorts, and a short clay condenser is set in the mouth of each and luted with clay. Then the furnace is fired from below, the flames circulating around and between the pots, causing the reduction of the zinc ore by the combination of the carbon of the coal with the oxygen of the ore. At first, a bright blue flame burns at the mouth of each condenser; but when the furnace charge reaches a bright red heat, say 1900° F., metallic zinc is volatilised, and burns at the mouth of the condenser with a brilliant greenish-white flame. Conical iron pipes are then placed over the condensers, in order to assist the condensation of the metal, which deposits inside the pipe in the form of metallic zinc. At stated intervals the pipes are removed, and the molten metal is scraped out of the condensers into ladles, from which it is poured into moulds, forming slabs of commercial spelter. This is continued until the furnace has been worked off and all the metal is extracted from the ore, which takes 24 hours, when the pipes and condensers are removed, the residue is scraped out of the retorts, and the furnace is recharged with ore. Of the metallic contents of the ore 80 per cent. is usually obtained, the remaining 20 per cent. being lost by volatilisation, absorption by the retorts, or left in the residue. The ordinary charge per furnace is 8500 lb. ore and 6000 lb. coal per day of 24 hours, and the average yield of metal is 1950–2000 lb.; thus the output of the plant is 300–315 tons per month. The fuel used to fire the furnaces

is Pocahontas coal, which gives a very long flame, necessary to reach the higher rows of retorts in the furnace, and has the following analysis: Fixed carbon, 74·27 per cent.; volatile matter, 10·52 per cent.; ash, 6·94 per cent. For mixture with the ore in the furnace, another coal is used, semi-anthracite in character, and having the following composition: Fixed carbon, 62·72 per cent.; volatile matter, 10·52 per cent.; sulphur, 1·43 per cent.; ash, 25·33 per cent. Although so high in ash, the coal serves its purpose admirably. Both white and coloured labour is used in the smelting works, the latter being found quite advantageous; 5 men are required to each furnace, and they work 24-hour shifts. The cost of smelting a ton of ore is, approximately: Furnace labour, 14s.; yard labour, 7d.; retorts, 3s. 6d.; Pocahontas coal, 9s. 3d.; mixing coal, 3s. 8d.; all other expenses, 7s. 4d.; total, 38s. 4d. per ton. As metallic zinc has a strong affinity for iron, no iron tool or vessel is allowed to come in contact with the zinc in its molten condition.

Recent experiments* on direct production of zinc in the blast-furnace by separating the metallic zinc from the furnace gases by means of a centrifugal machine, would indicate that the ordinary process of zinc-smelting might be modified as follows:—(a) Careful roasting of the ore, whether calamine or blende, to convert it as nearly as possible into oxide; (b) mixing the zinc oxide with 3 times its weight of bituminous coal and 5 per cent. of lime, and coking, giving a material with 22·7 per cent. zinc, partly in metallic form; (c) burning the zinc coke by hot blast in a closed top furnace, having a flue at the top connected with a centrifugal machine; the volatilised zinc carried off by the gases is collected in the flues and in the drum of the centrifugal; the cleaned gases are utilised as fuel; (d) subjecting the zinc dust to a pressure of about 1500 lb. per sq. in., which reduces it to about 10 per cent. of its original bulk, making it perfectly compact; (e) distilling the compressed zinc dust in retorts without addition of carbon, when about 66 per cent. metallic zinc of great purity is obtained. Lead and silver, if present, remain in the fixed residue. This operation requires much less fuel for heating than the ordinary method of reducing, as the material in the retort, being practically metallic zinc, is a good conductor of heat as compared with the mixture of zinc oxide and carbon. Probably more complete reduction might be obtained electrolytically, as lower tension current would be required, the material being largely in the metallic state.

Commerce.—The world's annual production of zinc is about 300,000–350,000 tons. Of this quantity, Belgium affords 130,000–140,000 tons; Silesia, 80,000–90,000; United States, 50,000–60,000; Great Britain, 20,000–30,000; France and Spain, 15,000–20,000; Austria, 4000–7000; Poland, 3000–4000. The output of zinc ores mined in the United Kingdom is about 25,000 tons yearly. Germany's total production of zinc ores in 1891 was 793,442 tons, all but about 1000 tons of which was raised in Prussia; Upper Silesia in 1890 had 35 mines working, which yielded 635,538 tons, in the proportions of about 59 per cent. calamine and 41 per cent. blende. The total zinc ore afforded by

* W. Hempel, Berg. u. Hütt. Zeit.; 1894.

Spanish mines was 55,817 tons in 1891 and 50,100 tons in 1892; one enterprise, the Real Compañía Asturiana, turned out over 27,000 tons calcined calamine in 1891, and over 24,000 tons in 1892, from the rich mines of Reocin and Udias. About $\frac{2}{3}$ of all the spelter produced in Belgium is made by the Vieille Montagne Co.

The market value of spelter (pig zinc) is liable to fluctuation, and may be said to range between 17*l.* and 25*l.* a ton. Brands such as the Bertha, containing 99·98 per cent. pure zinc, are worth something more than current prices. Almost all zinc ores carry some lead, perhaps ·01 per cent., which is a drawback, and in any appreciable quantity will render a zinc ore unsaleable. Further, antimony, arsenic, cadmium, copper, and iron hinder the roasting of the blende, cause loss in the subsequent distillation of the oxide, and, together with sulphur, lower the value of the metal produced, rendering it unfit for some of its most extended applications, e.g. fine brass and lithographic plates. Comparison of the two ores blende and calamine gives the latter a preference for the smelter because it is less costly to work and more readily gives up its metal, besides assisting to liberate the metal from blende when mixed with it in the charge; but as it carries less metal per ton, it reduces the output of the furnace, and its low specific gravity makes it more difficult to dress clean, besides which it cannot bear so much cost for transportation. The smelter in buying blende or calamine, bases his estimate of the value to him in the following manner. From the market price of spelter, say 22*l.* a ton, he deducts 6*l.* a ton as the cost of smelting, reducing the value to 16*l.* Then, from the zinc contents of the ore by assay, say 45 per cent., he deducts 15 per cent. for blende or 10 per cent. for calamine, as being the probable loss in slag, fume, &c., so that he has 30 per cent. or 35 per cent. metal which he can reckon on recovering. Finally, the market value of the zinc product of the ore is arrived at by a rule-of-three sum, e. g.—

If spelter	is worth 16 <i>l.</i> a ton, then	blende	is worth 4 <i>l.</i> 16 <i>s.</i> , or
100 p. c.		30 p. c.	
calamine		is worth 5 <i>l.</i> 12 <i>s.</i>	
35 p. c.			

The smelter therefore offers as much less than the 96*s.* or 112*s.* a ton as will give him the profit he desires. A very impure ore will suffer a greater loss than 15 per cent. in slags, &c., and is therefore not in demand; anything less than 45 per cent. is undesirable, and under 40 per cent. may be unmarketable at any price.



INDEX.



- Acids decomposing rocks, 2
Adits, 81
Adobe silver furnace, 611
Aerial ropeways, 118, 575
— tramways, 491
Agalite, 384
Air currents, resistance to, 60
— in mines, 59
— motors, 29
— supply under pressure, 62
Airways, conditions, 61
Akron cement for buddles, 610
Albertite, 167
Alkali mud cement, 184
Alkaline waters, 352
Allen furnace, 440
Alluvial diamonds, 238
Almaden, 563
Alum, 153
— rock, 153
— shale, 153
— stone, 153
Aluminite, 387
Aluminium, 387
— alloys, 397
— by electrolysis, 389
— cost, 395
— from alumina, 394
— from bauxite, 389
— from cryolite, 392
— furnaces, 389, 392
— in lead purifying, 548
— manufacture, 389
— ores, 387
— properties, 396
— smelting, 389, 392
Alunogen, 387
Amalgamation, lime in, 608
— manganese in, 608
— silver, 601
Amber, 155
Ammonite, 45
Anglesite, 515
Anhydrite, 319
Antimonite, 399
Antimony, 399
— American, 401
Antimony, auriferous, 399
— extraction, 401
— flux, 404
— fume, 405
— furnaces, 402-406
— geology, 399, 400
— in igneous rocks, 2
— industry, 407
— ingots, packing, 406
— lodes, 400
— ores, 399
— — dressing, 401
— Portuguese, 399
— refining, 404
— smelting, 402-406
— starring, 402
— yield, 405
Apatite, 305
Argentite, 590
Argillaceous iron ore, 487
Arkansas stones, 371
Arrastras, 482, 604
Arsenic, 156
— calcining, 157
— commerce, 161
— condensing, 158
— in igneous rocks, 2
— in pyrites, 323
— kettle, 160
— refining, 160
Arsenical copper refining, 460
Asbestos, 163
— African, 165
— American, 165
— Canadian, 163
— commerce, 166
— composition, 166
— dressing, 164
— grading, 164
— Italian, 164
— mining, 163
— Russian, 165
Asbolane, 411
Asphalt, 167
— American, 171
— Cuban, 173
— Mexican, 173

- Asphalt, purifying, 173
 Astrakanite, 319
 Atmospheric pressure, 61
 Annabergite, 572
 Augustine process, 613
 Auriferous samples, testing, 7
 Austin pyritic smelting, 444
 Azurite, 415
- BAILEY'S pumps, 76
 Balbach furnace, 547
 Baling tanks, 72
 Ball mills, 131
 Bandoom, 239
 Banket, 476
 Barite, 309
 Barytes, 309
 Barrel amalgamation, silver, 603
 — quartz, 474
 Base ores, sampling, 8
 Batts, 371
 Bauxite, 326, 388
 — American, 387
 — French, 387
 — geology, 388
 — Irish, 388
 — purification, 388
 — value, 388
 Bertha dressing works, 646
 — zinc, 641
 Bessemer iron, 509
 Bessemerising copper, 449
 — nickel matte, 578
 Bettel's smelting process, 444
 Bilharz concentration, 149
 Biotite, 265
 Bischofite, 319
 Bismuth, 408
 — geology, 408
 — sources, 408
 — treatment, 408
 Bismutite, 408
 Bits, drill, 34
 Bitumen, 167
 — with mercury, 564
 Black band, 487
 — brush ore, 487
 Blackjack, 639
 Blacklead, 249
 Blake breaker, 121, 122
 — multiple crushers, 500
 Blanc fixe, 309
 Blast furnace, Castilian, 536
 — — zinc, 650
 — furnaces, 508
 Blasting, 43, 361
 — disasters, 46, 47
 — explosives, 43
 — firing, 47
 — inefficient, 47
 — leverage, 46
 — tamping, 46
 — wedges replacing, 50
- Bleichert ropeways, 118, 491
 Blende, 639
 — separating from iron, 505
 Blister, smelting to, 447
 Block ore, 497
 Blomers, 59, 63
 Blue billy, 462
 — peach, 632
 Boëtius zinc furnace, 648
 Bog ore, 487
 Boiler reefs, 469
 Boiling soda nitrate, 347
 Bole, 310
 Boliche, 533
 Boracic acid, 174, 177
 Boracite, 319
 Borax, 174
 — American, 175
 — refining, 174, 175
 — Thibet, 174
 Bordeaux phosphate, 295
 Boring petroleum wells, 278
 Bornite, 415
 Boronatrocalcite, 174, 177
 Bort, 233
 Boss process, 608
 Bottoms, 459
 Braunitz, 556
 Brea, 167
 Breakers, 121
 Breeze, 214, 215
 Brick clay, 185
 Bricking fines, 447
 Brimstone, 22, 323
 Brine, 333
 Briquettes, 207, 212
 Broken Hill, 590, 519
 — — timbering, 87
 Bromine, 179
 Brown furnace, 440
 Brown's sinking system, 51
 Broza, 592
 — -guia, 592
 Brückner roaster, 439
 Brunton calciner, 157
 Brush mountain stone, 371
 Brushite, 296
 Bryan mill, 130
 Buchanan magnetic separator, 501
 Buckets, 72, 642
 Buddles, 145, 523, 524, 526
 — Akrom cement for, 610
 — for pan tailings, 609
 Buhrs, 370
 Buhrstone ore, 497
 Building stone, 357
 Bull dog, 509
 Bumsted's fan, 64
- CACHUCHA, 347
 Cadmium, 518
 Cages, 109
 Calamine, 639

- Calcarelle, 376
 Calcarone, 376
 Calcining, air for, 612
 — arsenic, 157
 — bauxite, 388
 — black band, 506, 507
 — cement, 181, 183
 — cobalt, 314, 316, 412
 — copper ore fines, 447
 — — ores, 431
 — cost, 647
 — gypsum, 253
 — in clamps, 506
 — iron ore, 505, 506, 507
 — lead ores, 531
 — lime, 261
 — manganese ore, 560
 — mercury ores, 565
 — nickel ore, 576
 — paint ore, 313
 — refractory substances, 332
 — silver ores, 602
 — sulphur, 376
 — tin stone, 632
 — zinc ores, 645, 646 [381]
- Calcium chloride extraction of sulphur, Caleras, 531
 Caliche, 347
 Campanil iron ore, 489
 Canada phosphate, 305
 Cappagh brown, 317 [382]
- Carbon bisulphide extraction of sulphur, Carbonaceous matter in gold veins, 470
 Carbonado, 243
 Carbonic acid in gold quartz, 478
 Carinthian reverberatory, 530
 Carnallite, 319
 Carolina phosphate, 297
 Cartridges, 43
 — water, 49
 Cascajo, 595
 Cassiterite, 622
 — white, 624
 Castilian blast furnace, 536
 Castner sodium process, 619
 Catalan process, 509
 Cawk, 309
 Cazo process, 604
 Cement, 180
 — artificial, 182
 — auriferous, milling, 482
 — clays, 180
 — kilns, 181, 182
 — lime mud, 184
 — rocks, 181
 Cerargyrite, 590
 Cerisine, 289
 Cerussite, 515
 Chalcocite, 415
 Chalcopyrite, 415
 — nickeliferous, 572, 573
 Chalk, 261
 Chapopote, 173
- Charging furnaces, 569, 570
 Charley Forester stones, 371
 Chateaugay iron ore dressing, 499
 Cherokite, 518
 Chili mill, 129
 — saltpetre, 346
 China clay, 187
 Chloridising roast, 603
 Chocolat, 575
 Christophite, 639
 Chrome iron, 326, 583
 — ore, 409
 — — cost, 410
 — — treatment, 410
 — — value, 409
 Chromium, 409
 — by electrolysis, 410
 — geology, 409
 — uses, 410
 Chromite, 409
 Chrysocola, 415
 Chrysotile, 163
 Cinnabar, 563
 Clamp bricks, 186
 — calcining, 506
 Clarkson-Stanfield concentrator, 151
 Classifying, 133
 Clausthalite, 588
 Clay, 185
 — fireproof, for zinc retorts, 649
 — ironstone, 487
 — tamping, 47
 Clays, cement, 180
 Clinker, cement, 183
 Coal, 191
 — analyses, 191
 — beds, working, 99
 — brasses, 322
 — breaking, 203, 207
 — cleaning, 200
 — conveyors, 112
 — cutting, 196
 — dumps, 111
 — gum, 207
 — heating value, 192, 225
 — jigs, 204
 — measure iron, 487
 — output per miner, 196
 — production, 195
 — river transfers, 112
 — sizing, 201, 209
 — spontaneous ignition, 194
 Coalfield, pumping plant for, 73
 Cobalt, 411
 — extraction, 412
 — geology, 411
 — industry, 414
 — ores, 411
 — pigment, 314
 — pyrites, 527
 — sources, 411, 412
 — with silver, 610
 Cobbing, 499

- Coaclico stone, 371
 Cockermeg, 101
 Coke, 191, 214
 — bye-products, 217
 — commerce, 217
 — ovens, 215
 Cole's crusher, 122
 Collins's smelting process, 446
 Cooling mines, 61
 Columbite, 634
 Compressed air, 29
 Compressors, 30
 Comstock, 2, 601
 Concave buddle, 147
 Concentrating, 133
 — brine, 339
 Concentration, cost, 125
 — dry, 150
 — iron ores, 498
 — lead ores, 521
 — Lührig vanners, 524
 — magnetic, 149, 500
 — platinum, 586
 — rotary tables, 523
 — Salzburg tables, 524
 — silver ores, 607
 Condensing arsenic, 158
 — fumes, 550, 647, 648
 — mercury fumes, 567, 570
 Conkling magnetic separator, 502
 Converters, copper, 450
 — relining, 451
 Convex buddle, 145
 Conveyors, coal, 112
 Copper, 415
 — American, 420
 — and nickel, separating, 578
 — arsenical, refining, 460
 — assays, 463
 — Arizona, 423
 — barilla, 417
 — bessemerising, 449
 — Bolivian, 416
 — bottoms, 459
 — bye-products, 462
 — Californian, 428
 — cementation, 434
 — — cost, 435, 436
 — Chilian, 417
 — commerce, 462
 — concentrating precious metals in, 609
 — converters, 450
 — — construction, 455
 — converting, cost, 455
 — cost of production, 421, 422
 — dissolving, 433
 — fines, roasting, 447
 — from mine waters, 431
 — geology, 416
 — German, 417
 — in conglomerates, 415
 — in eruptive rocks, 422
 — in felsite, 423
 — Copper in igneous rocks, 2
 — in sandstone, 417
 — in wash, 427
 — Indian, 418
 — kernel roasting, 438
 — kiln roasting, 439
 — lake, 420
 — Mansfeld, 418
 — matte roasting, 437
 — — smelting, cost, 444
 — mining, 425
 — Montana, 422
 — Nova Scotian, 418
 — ore, dousting, 429
 — — dressing, 428
 — — lake mills, 429
 — — stamps, 430
 — — treatment, 421
 — ores, 415
 — — burning, 431, 436
 — — chemical oxidation, 432
 — — oxidation, 431
 — Persian, 419
 — precipitating, 434
 — refining, 460
 — remelting furnace, 449
 — returning charges, 434
 — sampling, 463
 — Scandinavian, 419
 — schists, 415, 418
 — slag pots, 462
 — smelting, 222, 436
 — — cost, 446, 447
 — — in Transvaal, 444
 — — low grade ores, 446
 — — to blister, 447
 — — to matte, 442
 — — with naphtha residues, 447
 — sources, 415
 — Spanish, 419
 — spent solutions, 434
 — stall roasting, 438
 — Swansea method of smelting, 447
 — valuing, 463
 — washing out soluble salts, 433
 — wet extraction, 431
 — with zinc, 641
 Coprolites, 292
 Corduri's desilverising process, 547
 Cornish jig, 138
 — rolls, 125
 — tin, 622
 Côrundum, 218, 387
 — drills, 5
 Cowle's process for aluminium, 389
 Crawford mill, 131
 Croëlius drill, 4
 Crookesite, 588
 Crosswork on thick veins, 85
 Crucibles, cobalt, 315
 Crushers, 121
 Crushing, cost, 125
 — iron ore, 500

- Cryolite, mining, 389
 — preparing, 389
 Cumberland iron ore, 490
 Cupelling lead, 542
 Cuprite, 415
 Curly ore, 599
 Cutting mica, 267
 — peat, 271
 — slate, 369
 — talc, 385
 Cyclops mill, 131
- DAGNER'S zinc condenser, 648
 Davey's sinking system, 51
 Davis-Colby furnace, 504, 507
 Davis's safety commutator, 29
 Deads, 83
 Decize electric plant, 26
 Denaby pump, 76
 Dephosphorising iron mechanically, 499
 Desulphurising iron ores, 507
 Developing an ore body, 10
 Dhouah, 350
 Diallogite, 556
 Diamond, 232
 — drilling, cost, 5
 — drills, 3
 Diaspore, 387
 Diatomite, 255
 Distilling zinc, 647
 Dodge crusher, 121
 Doetsch process, 432
 Dolomite, 261, 326, 358
 Douglasite, 319
 Doppione, 380
 Dousting, 429
 Draining mines, 71, 625
 Dredging phosphate, 303
 Dressing, 133
 — antimony ores, 401
 — asbestos, 164
 — coal, 200
 — cobalt ores, 412
 — copper ore, 428
 — diamond earth, 235
 — fullers' earth, 230
 — garnierite, 579
 — iron ores, 498
 — lead ores, 521
 — manganese ore, 561
 — mica, 266
 — nickeliferous pyrrhotite, 576
 — phosphate, 300
 — tin, 631
 — zinc ores, 643
 Driers for ore, 613
 Drilling, 33, 361
 — by oil engine, 24
 — diamond, cost, 5
 — petroleum wells, 278
 — pneumatic, 29
 Drills, 34
 — diamond, 3
- Drills, running, 35
 Drives, 81
 Droppers, 473
 Drums, winding, 108
 Dry-bone, 641
 Dry concentration, 150
 Drying fuller's earth, 230
 — furnaces, 213
 — peat, 272
 — phosphate, 302
 Dunite, 583
 Dumps, coal, 111
 Dust in mines, 64
 Dynamite, 43
- EARTH WAX, 289
 Edison magnetic separator, 503
 Ejectors, 71
 Elaterite, 167
 Electric cables, 80
 — firing, 47
 — installation, 26
 — lamps, 65
 — motors for fiery mines, 28
 — plant, cost, 28
 — power, 25
 — pumping, 79
 — wires, joints, 49
 Electrolysis, aluminium, 389, 392
 — chromium, 410
 — lead, 548
 — zinc, 555, 650
 Elephant stamps, 128
 Elvan courses, 622
 Emerald, 243
 Emery, 218
 — drills, 5
 Emmens nickel process, 581
 Enargite, 415
 Endless chain haulage, 104
 Endlich silver process, 610
 Esopus stone, 371
 Estremadura phosphate, 296
 Eucairite, 588
 Evaporation, solar, 340, 345, 350
 Exploring ore bodies, 10
 Explosives, 43
- FANS, 59, 63
 Faults, 2
 Fauvel's furnace, 439
 Felspar, 223
 Ferberite, 636
 Ferro-nickel process, 580
 Fetting, 509
 Fiery beds, ventilating, 63
 — mines, electric motors for, 28
 Finding mineral deposits, 1
 Fines, roasting, 447
 Fireclay, 188
 Fireproof clay for retorts, 649
 Fire-setting, 219, 244
 Firing blasts, 47
 Fissures, 2

- Fissure veins, 3
 Flach's desilverising process, 547
 Flagstone ore, 497
 Flats, 518
 Flintshire furnace, 528
 Florida phosphate, 298
 Flue dust, 550
 Fluorspar, 221
 Flux, lead smelting, 539
 Fluxes, 221
 — manganese, 610
 Fond's process, 604
 Forest of Dean iron ore, 490
 Fossil meal, 255
 Foster's calcarone, 378
 Francke's tina process, 607
 Franklinite, 639
 Freiberg lead furnaces, 530
 — process, silver, 603
 French chalk, 384
 Friction exploders, 48
 Frongoch classifier, 142
 — jig, 139
 — skip, 110
 First drift, 479
 Fuel, 225
 — gaseous, 612
 — in cement burning, 184
 — lead smelting, 539
 — valuing, 192, 225
 Fullers' earth, 230
 Fumes, condensing, 647, 648
 Furnace, house floor, 578
 — pipes, tar in, 613
 — well, 578
 — wrinkle, 636
 Furnaces, aluminium, 389, 392
 — American reverberatory, 535
 — antimony, 402, 406
 — arsenic, 157
 — at great elevations, 611
 — Balbach, 547
 — blast, 508
 — briquette, 213
 — Carinthian reverberatory, 530
 — Castilian blast, 536
 — cement, 181, 182
 — charging, 569, 570
 — cobalt, 315, 316
 — coke, 215
 — copper remelting, 449
 — distillation, 648
 — Freiberg, 530
 — French reverberatory, 531
 — gaseous fuel for, 612
 — gypsum, 254
 — iron calcining, 506, 507
 — iron ore, 504
 — Jumbo, 552
 — lead cupelling, 542
 — — American, 543
 — — ore hearth, 407, 533
 — — reverberatory, 528
 — Furnaces, lime, 261
 — — for platinum, 587
 — linings, 326, 407
 — manganese ore, 560
 — mechanical rabbling, 440
 — mercury ore, 565
 — Mexican horno castellano, 535
 — — serpenton, 529
 — Moffet, 552
 — paint ore, 313
 — Pilsz, 537
 — platinum, 586
 — Raschette, 537
 — refractories, 332
 — relining, 451
 — Rio Tinto, 444
 — revolving, 439
 — shelf, 439
 — silver, 601, 612
 — — adobe, 611
 — Spanish boliche, 533
 — Swansea reverberatory smelting, 447
 — tapping, 452, 578
 — tin, 633
 — using naphtha residues, 447
 — water-jacket, 445, 537
 — wolfram, 636
 — zinc, 646
 Fuses, electric, 48

 GALENA, 515
 Garnierite, 572
 — cost of nickel oxide from, 582
 — dressing, 579
 — smelting, 579
 Gas in mines, 61
 — natural, 273
 Gaseous fuel, 225, 612
 Gates crusher, 122
 Gems, 232
 Gersdorffite, 572
 Gibbsite, 387
 Gilsonite, 167
 Glacial drift, auriferous, 480
 — — platinum in, 585
 — — sinking through, 55
 Glauberite, 319
 Globe mill, 131
 Gold, African, 476
 — American, 478
 — in antimony, 399
 — Australian, 465
 — Austrian, 473
 — Californian, 478
 — Canadian, 479
 — carbonaceous matter with, 470
 — cement, milling, 482
 — geology, 465
 — German, 475
 — Indian, 475
 — in glacial drift, 480
 — in granite, 466
 — in hematite, 465

- Gold in igneous rocks, 2
 — in sandstone, 466, 479
 — in squibs, 468
 — in whin, 473
 — Mount Morgan, 465
 — Nova Scotian, 473
 — quartz, carbonic acid in, 478
 — placer mining, 480
 — production, 465
 — samples, testing, 7
 — veins, characters, 465
 — — in depth, 467
 — — droppers, 473
 — — indicators, 473
 — with palladium, 586
 — with platinum, 585
 — with rhodium, 586
 Goslarite, 641
 Grahamite, 167
 Granza, 569
 Granzita, 569
 — furnace, 570
 Graphite, 249
 Gratings, 132
 Gravel, milling in arrastras, 482
 — sinking through, 55
 Gravity hoist, 105
 Greenockite, 640
 Green stuff, 632
 Greisen, 630
 Grinding, 121
 — faces, durability, 132
 — mica, 268
 — salt, 343
 — smalts, 316
 Grindstones, 371
 Grits, 370
 Grossularite, 642
 Guadalcazarite, 563, 565
 Guanos, 307
 Gwynne's stratum tester, 480
 Gypsum, 253

 HALL aluminium process, 392
 Hand drilling, 33
 — power diamond drill, 4
 Hard ore-body, working on, 93
 Haulage, electric, 26
 Hauling, 103
 — underground, 104
 Heap roasting, 431, 436, 531
 — — nickel ore, 576
 — — silver ore, 611
 Heat in mines, 59
 — of slag, utilising, 549
 — waste in smoke, 227
 Heating value of coals, 192, 225
 Hematite, 487
 — gold in, 466
 Henderson process, 432
 Heroult aluminium furnace, 392
 Herreschmidt's cobalt process, 413
 Herreshoff furnace, 577

 Hindostan stones, 371
 Hodgson's wire ropeway, 491
 Hoffman magnetic separator, 504
 Hofmann lixiviation, 617
 Hoisting, 103, 105, 569
 Hollway copper process, 449
 Hones, 371
 Horn silver, 590
 Horno castellano, 535
 Howell white roaster, 439
 Hübnerite, 636
 Hughes furnace, 569
 Hunt conveyer, 118
 Hunt-Douglas process, 432
 Hunter's long drill, 40
 Huntingdon mill, 130
 Husband stamps, 127
 Hutches, 103
 Hutching, 134
 Hydraulic cements, 180
 — ejectors, 71
 Hydraulic platinum, 585
 — tin, 626
 Hypo, 613
 Hyposulphites, 613

 IGNEOUS sources of metals, 2
 Illuminating, 65
 Incline, self-acting, 104
 Infusorial earth, 255
 Ingersoll compressors, 30
 — drills, 37
 Ingersoll-Sergeant drills, 364
 Iodine, 257
 Iridium, 485, 583
 — fusing, 486
 — pen points, 485
 — properties, 485
 — removing from platinum, 586
 — sources, 485
 — with gold dust, 485
 Iridosmine, 485
 Iron, 487
 — affinity for zinc, 650
 — American, 492
 — blast furnaces, 509
 — British, 488
 — bye-products, 513
 — Catalan process, 509
 — Cleveland, 488
 — costs, 511, 512
 — Cuban, 497
 — Cumberland, 488
 — dephosphorising, 499
 — desulphurising, 507
 — Elba, 492
 — geology, 492
 — gold with, 465
 — in antimony smelting, 402
 — in igneous rocks, 487
 — labour in producing, 510
 — Lake Superior, 493
 — Lancashire, 488

- Iron, Lincolnshire, 488
 — magnetic concentration, 500
 — malleable, 509
 — Mesabi, 494
 — Missouri, 496
 — New Jersey, 496
 — New York, 496
 — Northamptonshire, 488
 — ore, 487
 — — aluminous, dressing, 498
 — — concentration, 498
 — — desulphurising, 504
 — — dressing at Chateaugay, 499
 — — dry screening, 498
 — — impurities, 487
 — — lias, 488
 — — mining, 491
 — — produced per miner, 488
 — — pulverising, 504
 — — roasting, 498, 505, 506, 507
 — — separating from blende, 505
 — — sorting, 499
 — — transporting, 491
 — — values, 511
 — — waste, concentrating, 302
 — outputs, 510
 — pig, 508
 — production, 512, 513
 — puddling, 509
 — separating from zinc, 643
 — slags, 513
 — smelting, 221, 508
 — Spanish, 489
 — Staffordshire, 488
 — Swedish, 492
 — wrought, 508
 JACUTINGA, 586
 Jade, 244
 Jeffrey coal-cutter, 198
 — drills, 37
 Jet, 259
 Jigging, 134
 — coal, 204
 — diamonds, 236
 — iron ore, 500
 — lead ores, 522, 523
 Jigs, 138, 430
 Joints, 2
 — in electric wires, 49
 Joly process, 432
 Jordan's mill, 131
 Jumbo furnace, 552
 Jumpers, 33
 KAINITE, 319
 Kaolin, 187
 Kermesite, 399
 Kernel roasting, 438
 Kieselguhr, 255
 Kieserite, 319
 Killas, 622
 Kilns, *see* Furnaces
 Kiss process, 613
 Knee joint, 101
 Knotten-sandstein, 516
 Knox furnace, 568
 Knox-Osborne furnace, 569
 Kolpe winding, 106
 Krause-Cöthen fume process, 647
 Krom rolls, 125
 Krugite, 319
 Kupferschiefer, 418
 LAKE copper, 420
 — ore, 487
 Lamps, 65
 Lancaster crusher, 122
 Land plaster, 253
 Lapis-lazuli, 245
 Laurite, 586
 Lavadero, 605
 Laying out mines, 12
 Leaching tanks, 616
 — zinc fume, 647
 Lead, 515
 — American, 517
 — Australian, 519
 — Balbach furnace, 547
 — Bonne Terre, 517
 — British, 515
 — Broken Hill, 519
 — carrying silver, 521
 — Castilian blast furnace, 536
 — Colorado, 518
 — Cordurie's desilverising process, 547
 — Cornish furnace, 529
 — crystallising, 544
 — cupelling, 542
 — desilvering, 542
 — — cost, 546
 — electrolysis, 548
 — Flach's desilverising process, 547
 — Flintshire furnace, 528
 — flue dust, 550
 — fluxes, calculating, 540
 — French, 515
 — fume, 550
 — furnace bye-products, 549
 — geology, 515
 — German, 516
 — Idaho, 519
 — in igneous rocks, 2
 — Indian, 517
 — jumbo furnace, 552
 — Laveissière process, 544
 — Lewis-Bartlett process, 552
 — liquating, 542
 — Marseilles process, 544
 — matte, 550
 — Missouri, 517, 518
 — ore, 515
 — — dressing at Arranyes, 525
 — — — at Bonne Terre, 526
 — — — at Clausthal, 521
 — — — at Laurenberg, 523
 — — — at Sentein, 526

- Lead ore dressing at Werlau, 524
 — — — mill, two story, 527
 — — hearth, 533, 407
 — — impurities, 521
 — — simple washing, 521
 — — valueing, 541
 — oxidising, 542
 — Parkes desilverising process, 546
 — Parnell process, 554
 — Pattinson process, 544
 — pouring, 550
 — preparing smelting mixture, 539
 — purifying, 542
 — reverberatory smelting, 528
 — Rössler-Edelmann process, 548
 — Schnabel's desilverising process, 547
 — slag, 550
 — — forming, 540
 — — remelting, 550
 — smelting, 528
 — — charges, 542
 — — constitution of slag, 540
 — — cost, 539
 — — flux, 539
 — — fuel, 539
 — softening, 542
 — sources, 515
 — Spanish, 516
 — speiss, 549
 — Utah, 519
 — water-jacket furnaces, 537
 — West process, 554
 — Wisconsin, 518
 — with nickeliferous pyrite, 517
 — zinc desilverisation, 545
 Lead-zinc ores, treating, 551
 Leakage, surface, 80
 Lehrbachite, 588
 Levels, 82
 Leverage in blasting, 46
 Levigating, 187, 230, 309, 318
 Lewis-Bartlett lead process, 552
 Lewising, 361
 Lighting, 65
 — cost, 69
 — installation, cost, 69
 Lignite briquettes, 212
 Lime, 261, 326
 — furnace for platinum, 587
 — in amalgamation, 608
 — in lead smelting, 532
 — mud cement, 184
 Limestone, ferriferous, 497
 Limestones, 358
 Linings, furnace, 326, 451, 459, 509, 539
 Linkenbach buddle, 147, 526
 Liquid fuel, 225
 Livingstonite, 565
 Lixiviating saltpetre, 347, 350
 Lixiviation operations, 615
 — plant, 615
 — silver, 612
 — tanks, 616
 Lixiviation troughs, 617
 Lodes, *see* Veins
 Longwall working, 99
 Longmaid process, 432
 Loose ground, sinking in, 55
 Lot phosphate, 295
 Lüderich dressing floors, 643
 Lührig vanner, 143, 524
 Lunedale turbines, 19
 MACFARLANE nickel process, 580
 Macfarlanite, 411
 Maggie, 230
 Magistral, 605
 Magnesia, 326
 Magnesite, 310, 326
 Magnetic concentration, 149
 — — cost, 502
 — firing, 47
 — separation, 500
 — — iron from zinc, 643
 — — nickel, 580
 Magnetite, 487
 Malachite, 415
 Maldonite, 408
 Maletra cobalt process, 412
 Malm, 186
 Maltha, 167
 Manganese, 556
 — American, 435, 558
 — Australian, 435, 560
 — Bosnian, 562
 — British, 435, 556
 — Caucasian, 435, 557
 — Chilian, 435, 559
 — commerce, 561
 — Cuban, 435, 559
 — Dutch, 562
 — flux for silver, 610
 — fouling mercury, 608
 — French, 435, 556
 — Greek, 562
 — impurities, 561
 — Indian, 435, 557
 — Italian, 562
 — Japanese, 435, 557
 — New Brunswick, 435, 559
 — New Zealand, 435, 560
 — Nova Scotia, 435, 559
 — ore, 556
 — — dressing, 561
 — — roasting, 560
 — — treatment, 560
 — — washing, 431, 559
 — Portuguese, 562
 — Spanish, 435, 557
 — statistics, 562
 — Swedish, 435, 557
 — Turkish, 562
 — value, 561
 — with silver, 608
 Manganite, 556
 Manté's copper process, 449

- Marble, 359
 Marmatite, 639
 Marseilles desilverising process, 544
 Matte, lead, 550
 — pots, 462
 — roasting, 437
 — smelting copper, 442
 Melaconite, 415
 Mercury, 563
 — alluvial, 565
 — American, 563, 564
 — applications, 571
 — Austrian, 563
 — Borneo, 563
 — Caucasian, 563
 — condensing, 567, 570
 — consumption, 563
 — cost, 565
 — — of calcining, 567, 569
 — fines, 569
 — fouled by manganese, 608
 — geology, 563
 — Italian, 563
 — Mexican, 563, 565
 — New South Wales, 565
 — ore, 563
 — — calcining, 565
 — — treatment, 563, 565
 — Peruvian, 563
 — production, 563
 — Queensland, 565
 — Russian, 563
 — Servian, 563
 — soot, 569
 — Spanish, 563
 — value, 571
 — with bitumen, 564
 — yield, 564
 Meres, 333
 Metacinnabarite, 563
 Metallic paints, 311
 Metals, igneous sources, 2
 Metasomatic interchange, 2
 Mexican shaft furnace, 442
 — silver process, 611
 Mica, 265
 Millerite, 412, 572
 Milling faces, durability, 132
 Mills, 83
 Millstones, 370
 Mine, laying out, 12
 — surveying, 12
 — timbers, decay, 564
 — — preserving, 102
 — waters, copper from, 140
 Mineral decomposition, 2
 — indications, 1
 — veins, origin, 1
 — wax, 289
 Mining, 81
 — asbestos, 163
 — cost, 89
 — iron ore, 491
 — Mining salt, 342
 — — slate, 367
 — — stone, 360
 — sulphur, 374, 375
 — talc, 386
 Mispickel, 156
 Moffet furnace, 552
 Mond nickel process, 581
 Moser furnace, 647
 Mother lode of California, 478
 Motive power, 15
 Mount Morgan gold, 465
 Mulattos, 591
 Multiplied crushers, 122
 Mundic, 322, 487
 Muschelkalk, 516, 639
 Muscovite, 265
 Mussels, pearl, 269

 NAPHTHA residues in copper smelting, 447
 Nassau phosphate, 295
 Natural gas, 273
 Naumannite, 558
 Neate's grinder, 130
 Negrillos, 591
 Nevada timbering, 86
 Niccolite, 572
 Nickel, 572
 — American, 581
 — and copper, separating, 578
 — Canadian, 573, 581
 — chocolat, 575
 — commerce, 581
 — Cornish, 572
 — cost, 573
 — geology, 572
 — German, 572
 — magnetic separation, 580
 — matte, bessemerising, 578
 — — refining, 578
 — metallic, cost, 582
 — mining, 574, 575
 — New Caledonian, 574, 581
 — Norwegian, 572, 581
 — ore, 572
 — — calcining, 576
 — — cost, 576
 — — treatment, 576
 — oxide, cost, 582
 — production, 581
 — Scotch, 572
 — smelting, 223, 577
 — Swedish, 572, 581
 — uses, 582
 — value, 582
 — with lead, 517
 — with silver, 610
 — yield, 572
 Niobium in tin, 634
 Nitro-compounds, 43
 Noumeaitc, 572

- OCHRES, 310
 O'Hara furnace, 440
 Oil engines, 22
 — pipe lines, 287
 Oilstones, 371
 Okonite, 291
 Opal, 245
 Optimus drill, 39
 Orange stones, 371
 Ore, auriferous, sampling, 7
 — base, sampling, 8
 — bodies, developing, 10
 — — following faulted, 2
 — — origin, 1
 — — persistence, 2, 3
 — — sampling, 5
 — breakers, 121
 — driers, 613
 — hoisting, 569
 — separating impurities from, 133
 Oxford nickel smelting, 580
 Orpiment, 156
 Osmiridium, 485
 Osmium, 583
 Overhead stoping, 83
 Overwinding, 109
 Oxland calciner, 157, 432, 439, 646
 Oysters, pearl, 269
 Ozokerit, 289
- PACOS, 591
 Paint from copper-ore residues, 462
 — — iron slag, 513
 — mineral, 310
 Palladium, 583
 — gold, 586
 — removing from platinum, 586
 Pandermite, 174, 177
 Pan amalgamation, 607
 — scale, 340
 — tailings, smelting, 609
 Pape-Henneberg concentration, 150
 Parkes process, 546
 Parnell lead-zinc process, 554
 Patio process, 604, 613
 Pattinson desilverising process, 544
 Peach, 632
 Pearce furnace, 440
 Pearls, 269
 Peat, 271
 Pedrisco iron ore, 489
 Pelton wheel, 21
 Pentlandite, 572
 Percussive drilling, 33
 Peridote, 583
 Petroleum, 273
 — geology, 273
 — production, 289
 — storing, 288
 — transporting, 287
 — well sinking, 278
 Phosphates, 292
 Phosphatic manures, 513
 Phosphoric acid from slag, 513
 Phosphorite, 296
 Piauzite, 167
 Picotite, 409
 Pigments, 309
 Pillar and stall working, 99
 Pile burning coke, 215
 — roasting, 431, 436, 531
 — roasting nickel ore, 576
 Pilz furnace, 537
 Pipe lines, 287
 Pipes, corrosion, 80
 Pitchblende, 638
 Placer mining, 480
 Platiniridium, 485
 Platinum, 583
 — alloys, 583
 — American, 585
 — Australian, 586
 — Borneo, 586
 — Brazilian, 586
 — British Columbian, 585
 — Californian, 581
 — Canadian, 583
 — Columbian, 585
 — commerce, 587
 — concentrating, 586
 — cost of mining, 585
 — in glacial drift, 585
 — hydraulic, 585
 — New South Wales, 583
 — New Zealand, 586
 — pure, cost, 587
 — purifying, 586
 — qualities, 587
 — Russian, 583, 584
 — sources, 583
 — treatment, 586
 — uses, 587
 — value, 587
 — with gold, 585
 — yield, 585
 Plug, tamping, 46
 Plumbago, 249
 Pneumatic power, 29
 — pulverisers, 131
 Pointed boxes, 139
 Polyhallite, 319
 Porpezite, 586
 Potash nitrate, 319
 — salts, 319
 Potassium, 619
 — cost, 619, 621
 Powders, 43
 Power, motive, 15
 Priceite, 174
 Producer gas, 225
 Props, 101
 Prospecting, 1, 239
 Proustite, 590
 Psilomelane, 556
 Pulverising iron ore, 504
 — slag, 513

- Pulverising tale, 385
 — *see* Grinding
 Pumice, 321
 Pumping, 71
 — brine, 334
 — by oil engine, 24
 — cost, 75
 — electric, 26, 79
 — plants, 73
 Pumps, 72
 — brine, 335
 — Chinese, 625
 — sinking, 51
 Pyramidal troughs, 139, 420
 Pyrites, cupreous, 419
 Pyritic smelting, 444
 Pyrargyrite, 590
 Pyrrhotite, nickeliferous, 572, 573, 574
 — — cost, 581
 — — dressing, 576
 Pyritic smelting, 611
 Pyrite, 487
 Pyrites, 322
 — cinders, 497
 — in coal, 195
 Pyrolusite, 556
 Pyromorphite, 515
- QUARRYING, 97**
 — slate, 367
 Quicksilver, *see* Mercury
- RAGSTONES, 371**
 Rain splitting slate, 369
 Raise, 83
 Raschette furnace, 537
 Realgar, 156
 Red shag calcining, 507
 Reducing, *see* Grinding
 Refractory materials, 326
 Reefs, *see* Veins
 Reichardite, 319
 Reels, 108
 Retorts, clay for, 649
 Reverberatories, 314, 316, 432, 437, 439,
 447, 542, 528, 646
 — American, 535
 Reverberatory, antimony, 406
 Revolving furnaces, 439
 Rhodium, 583
 — gold, 586
 — removing from platinum, 586
 Rhodonite, 557
 Ribbon quartz, 478
 Rig, well boring, 280, 345
 Riolite, 588
 Rio Tinto pyrites, 419
 Rittinger jig, 138
 Robey winding engine, 107
 Robey's stamps, 483
 Rock breakers, 121
 — filling, 90
 — oil, 273
- Rock salt, 333
 Rolls, 125
 Ropes, 107
 Ropeways, rudimentary, 575 [548
 Rössler-Edelmann lead purifying process,
 Rubio iron ore, 489
 Ruby, 246
 — silver, 590
 Russell process, 613
 — — cost, 617
 Ruthenium, 583
- SADDLE reefs, 471, 520**
 Safety commutator, 29
 — lamps, 65
 Salinas, 346
 Salines, 175
 Salnatron, 258
 Saltpetres, 346
 Salt, 333
 — boiling, 339
 — consumption in chloridising roast, 603
 — pans, 340
 — purifying, 339
 Salzburg tables, 524
 Samples, auriferous, testing, 7
 Sampling base ores, 8
 — copper, 463
 — ore bodies, 5
 Sandstones, 358
 Sapphire, 247
 Sassolite, 174, 177
 Sauter-Harlé magnetic separator, 645
 Schnabel's desilverising process, 547
 Schönite, 319
 Schram drills, 4, 39
 Schranz crusher, 122
 — fine crusher, 130
 — tables, 523
 Scheelite, 636
 Scheelitine, 636
 Scotch ore hearth, 407, 533
 Screening coal, 201, 209
 — iron ores, 498
 — lead ores, 523
 Screens, 132
 Scribing mica, 266
 Seams, 2
 Searching for minerals, 1
 Selenium, 588
 — minerals, 588
 — preparation, 581
 Selen-sulphur, 588
 Senarmonite, 399
 Separating, 133
 Separators, 420
 Sergeant coal-cutter, 198
 — drills, 37
 Serpentine, 529
 Settle's water cartridge, 49
 Settlers, 605
 Seyssel asphalt, 167
 Shaft sinking, 51

- Shaking tables, 143
 Shelf furnaces, 439
 Shoots, 2
 Shutes, 83
 Siderite, 487
 Siegenite, 412, 572
 Siemens drills, 36
 — exploders, 48
 — iron, 509
 Siemens-Martin iron, 509
 Siemas, 310
 Silver, 590
 — amalgamation, 601
 — — cost, 606
 — American, 595, 618
 — Argentine, 618
 — Arizona, 595
 — Augustine process, 613
 — Australian, 590, 618
 — Austrian, 618
 — barrel amalgamation, 603
 — Bolivian, 590, 618
 — Boss process, 608
 — British, 618
 — California, 595
 — Canadian, 618
 — Cazo process, 604
 — Central American, 618
 — Chilian, 618
 — chloridising, 603
 — Columbian, 618
 — Colorado, 597
 — commerce, 618
 — concentrating in copper, 609
 — cost of producing, 618
 — Endlich process, 610
 — fondo process, 604
 — Francke's tina process, 607
 — Freiberg process, 603
 — French, 618
 — furnaces, 612
 — geology, 590
 — German, 618
 — Honduras, 593
 — hypo, 613
 — Idaho, 598
 — in igneous rocks, 2
 — in lead, 521
 — Italian, 618
 — Japanese, 618
 — Kiss process, 613
 — Lake Superior, 598
 — liquating, 611
 — lixiviation, 612
 — — cost, 617
 — manganese flux, 610
 — Mexican, 618
 — — process, 611
 — Montana, 599
 — Nevada, 600
 — Norwegian, 618
 — ores, 590
 — — concentration, 607
 Silver ores, heap roasting, 611
 — pan amalgamation, 607
 — patio process, 604
 — Peruvian, 594, 618
 — production, 618
 — Russell process, 613
 — Russian, 618
 — salt consumption in chloridising, 549
 — smelting, 609
 — — at great elevations, 611
 — — pan tailings, 609
 — Spanish, 618
 — Swedish, 618
 — tellurides with, 608
 — treatment, 601
 — Utah, 601
 — volatilisation, 603, 608, 612
 — Von Patera process, 613
 — wet extraction, 612
 — with cobalt, 610
 — with manganese, 608
 — with nickel, 610
 — with tin, 592, 607, 631
 — with zinc, 641
 — Ziervogel process, 613
 Silesian zinc process, 648
 Simonite, 487
 Sinking, 51
 — pumps, 76
 — salt wells, 334
 Sinks, 352
 Sinopel, 473
 Siphons, 71
 Sizing in jigging, 137
 Skips, 72, 109
 Slack briquettes, 212
 Slag, iron, 513
 — lead, producing, 540, 550
 — pots, 462
 — utilising heat of, 549
 Slate, 364
 — cutting, 369
 — names of sizes, 370
 — output, 370
 — picking, 203, 204
 — splitting, 369
 — weight, 370
 Slating, lap, 370
 — measuring, 370
 Slime frame, 147
 — treating, 522
 Smaltine, 411
 Smalts, 314
 Smelting antimony, 402, 406
 — at great elevations, 611
 — copper, 436
 — garnierite, 579
 — iron, 508
 — lead, 528
 — nickel ore, 577
 — pyritic, 611
 — silver, 609
 Smithsonite 639

- Smoke, 227
 Snakestone, 371
 Soapstone, 384
 Soda, 352
 — nitrate, 346
 Sodiocuprous hypo, 613
 Sodium, 619
 — cost, 619, 621
 — uses, 621
 Soft ore body, working on, 94
 Softening lead, 542
 Sorting iron ores, 499
 Sparry iron, 487
 Spathic ore, 487
 Specific gravities, 133
 Specular ore, 487
 Sperrylite, 583
 Sphalerite, 639
 Spitzkästen, 139
 Spitzlутten, 142
 Splitting slate, 369
 — mica, 266
 Square sets, 86
 Squib veins, 468
 Stulls, 84
 Stamps, 126
 — for gold quartz, 484
 — replaced by arrastras, 482
 — steam, 430
 — tin, 632
 Stangen-spath, 309
 Stannite, 622
 Stahl's cobalt process, 412
 Stall roasting, 438
 Stassfurtite, 174
 Steam extraction of sulphur, 381
 — pumps, 72
 — stamps, 127, 430
 Steatite, 384
 Stein vanner, 145
 Stephanite, 590
 Stetefeldt furnace, 602, 612
 Stewart's smelter, 445
 Stibnite, 399
 Stickney's copper process, 456
 Stone, 357
 — grindstones, 371
 — millstone, 370
 — mining, 360
 — whetstones, 371
 Stoping, 83
 Storing petroleum, 288
 Stream tin, 622
 Stripping, 97
 Stucco, 253
 Sudbury nickel, 573
 Sulphur, 323, 373
 — American, 375
 — cost, 375
 — calcarelle, 376
 — calcarone, 376
 — dissolving, 381
 — doppione, 380
 Sulphur extraction, 375, 376
 — Galician, 375
 — geological origin, 373
 — Icelandic, 375
 — Italian, 23
 — Japanese, 375
 — mining, 374, 375
 — production, 374
 — removal from iron, 507
 — roasting, 376
 — Sicilian, 373
 — steam extraction, 381
 Sulphuric acid, 322
 Sump, 83
 Sun evaporation, 340, 345, 350
 Surface leakage, 80
 Surveys, underground, 12
 — transferring surface alignments to underground workings, 12
 Swansea reverberatory smelting furnaces, 447
 Sylvin, 319
- TACHYDRITE, 319
 Taking samples, 5
 Talc, 384
 — American, 384
 — Chinese, 386
 — cost, 385, 386
 — cutting, 386
 — fibrous, 384, 385
 — Indian, 385
 — mining, 386
 — production, 385
 — pulverising, 385
 Tamping, 46
 Tanks, lixiviation, 616
 Tantalite, 634
 Tantalum in tin, 634
 Tapping furnaces, 452, 578
 — wastes, 40
 Tar in furnace pipes, 613
 Taylor gas producers, 612, 646
 Teleras, 431
 Tellurides with silver, 608
 Temperature in mines, 59
 Tephroite, 557
 Terraris furnace, 647
 Testing auriferous samples, 7
 Tetrahedrite, 415, 592
 Thallium, 595
 Thermal units, 225
 Thiosulphates, 613
 Thomas Gilchrist iron, 509
 Tierras, 569
 Tiff, 309
 Timbering, 84
 — square set, 86
 Timbers, decay, 564
 — preserving, 102
 Tin, 622
 — African, 631
 — American, 630, 634

- Tin, Australlan, 628, 634
 — Banca, 626, 634
 — Billiton, 626, 634
 — Bolivian, 631, 634
 — British, 622, 634
 — Burmese, 623
 — calcining, 632
 — Chinese treatment, 633
 — commerce, 634
 — dressing, 631
 — geology, 622
 — hydraulicing, 626
 — impurities, 634
 — in igneous rocks, 2
 — Indian, 623
 — leavings, 633
 — Malacca, 634
 — Mexican, 631
 — mining, 624
 — Mt. Bischoff, 627
 — ores, 622
 — — removing tungsten, 636
 — Penang, 634
 — production, 634
 — Singapore, 634
 — smelting charges, 635
 — Spanish, 623
 — stamps, 632
 — Straits, 623, 634
 — stream, 622
 — Sumatra, 627
 — Tasmanian, 627, 634
 — treatment, 631
 — uses, 634
 — valuation, 634
 — with silver, 592, 607, 631
 — yields, 624
 Tina, 605
 Tinkal, 174
 Tipplers, 103, 109, 110, 111
 Titanium in tin, 634
 Topaz, 248
 Torpedoes, 286
 Tortas, 604
 Transportation, cost, 492
 — nickel ore, 575
 Transporting iron ore, 491
 Trinidad asphalt, 169
 Trogerite, 638
 Troughs, lixiviation, 617
 Tunnels, 81
 Tungstates, soluble, producing, 636
 — British, 636
 — in tin, 634
 — ores, 636
 — removing from tin ore, 636
 — treating, 636
 — uses, 636
 Turbines, 16
 Turkey oilstone, 371
 Turquoise, 248
 Turret furnace, 440
 Tzu-chien, 355
- UINTAHITE, 167
 Uintite, 167
 Ulexite, 174
 Umbers, 317
 Underground hauling, 104
 — transferring surface alignments, 12
 Underhand stoping, 84
 Unwatering mines, 71
 Ural platinum, 583
 Uranium, 638
 — ores, 638
 Uranmica, 638
 Uranocalcite, 638
- VAL DE TRAVERS asphalt, 167
 Valuing lead ores, 541
 Vanadium with copper, 417
 Vanners, 143
 Veins, origin, 1
 Vena dulce iron ore, 489
 Ventilation, 59
 Volatilisation, silver, 612
 — zinc, 649
 Von Patera process, 613
 Vortex turbines, 18
- WAD, 559
 — cobaltiferous, 411
 Wagons, 103
 Wall rocks, 3
 Washing coal, 200
 — phosphates, 300, 302
 Washita stones, 371
 Wastes, tapping, 40
 Water of Ayr stone, 371
 — channels, 16
 — ejectors, 71
 — gas, 226
 — motors, 16
 — pipes, 16
 — power, 15
 — — calculating h.p., 22
 — tapping by long drill, 40
 Water-jacketed cartridges, 49
 Water-jacket furnaces, 445, 537
 Wax, mineral, 289
 Wedges, 50
 Wells, petroleum, 278
 — salt, 334
 — sinking, 51, 278, 334
 Welsh-Belgian zinc furnace, 649
 Wenström magnetic separator, 501
 West lead-zinc process, 554
 Westphalite, 46
 Wet ground, sinking through, 51
 Whetstones, 371
 Whin, auriferous, 473
 Willemite, 639
 Winding, 105
 — drums, 108
 Winning, 81
 Winze, 83

- Wire ropes, 107
 — ropeways, 118, 491
 — — rudimentary, 575
 Wires, electric, fixing, 80
 — joints, 49
 Wood lined pipes, 80
 Wolfram, 636
 — furnace, 636
 Wologonzite, 167
 Working faces, ventilating, 62
 Workings, transferring surface align-
 ments to, 12
 Worthington pumps, 75
 Wrinkle, 157, 636
 Wurtzilite, 167
- ZAFFRE**, 314
 Ziervogel process, 613
 Zinc, 639
 — affinity for iron, 650
 — American, 640, 650
 — applications, 651
 — Austrian, 650
 — Belgian, 650
 — British, 639, 650, 686
 — commerce, 650
 — direct production in blast furnace, 650
 — distillation, 647
 — electrolysis, 555
 — electrolytic, 650
- Zinc for desilverising lead, 545
 — French, 639, 650
 — fume, precipitating, 647, 648
 — geology, 639
 — German, 639, 650
 — Indian, 640
 — lead ores, treating, 551
 — — Parnell process, 554
 — — West process, 554
 — ore dressing, 643
 — — treatment, 642
 — ores, 639
 — — impurities, 651
 — — roasting, 645, 646
 — — valuation, 651
 — oxide pigment, 552
 — Polish, 650
 — production, 650
 — retorts, 649
 — separating iron, 643
 — Silesian, 650
 — smelting, cost, 650
 — Spanish, 640, 950
 — Swedish, 640
 — value, 651
 — volatilising, 551, 649
 — with copper, 641
 — with silver, 641
 Zincite, 639
 Zorgite, 588

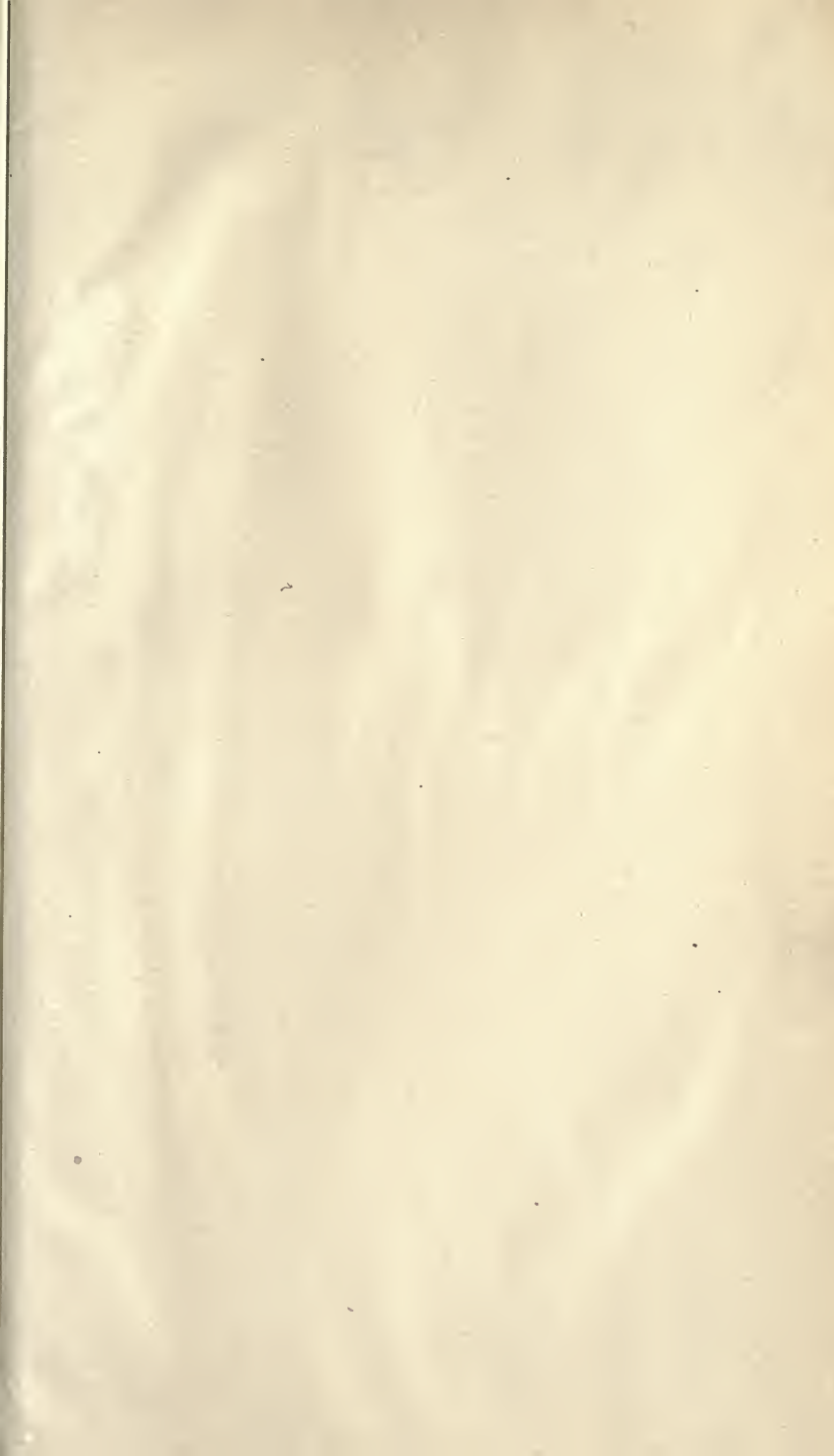

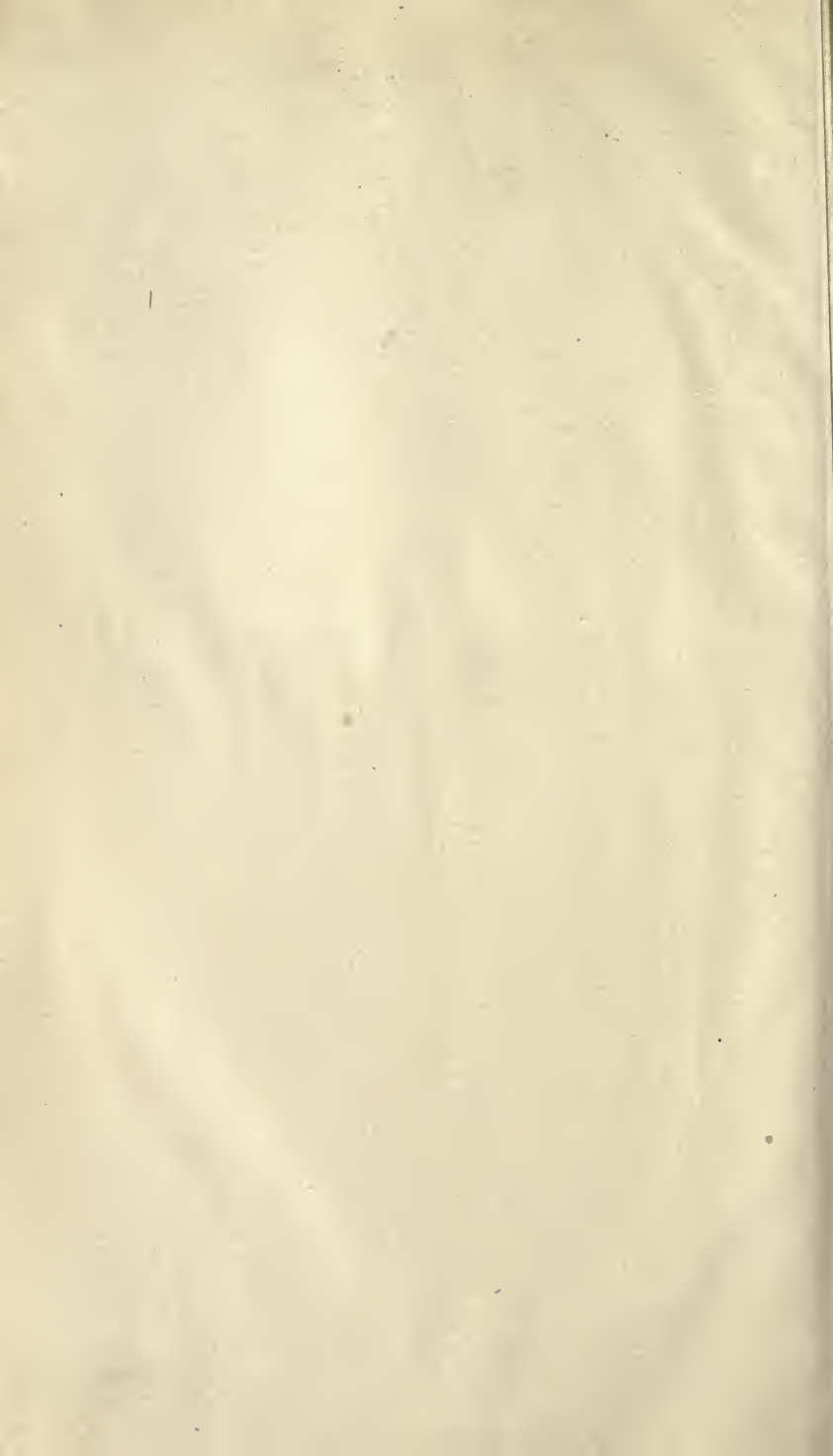

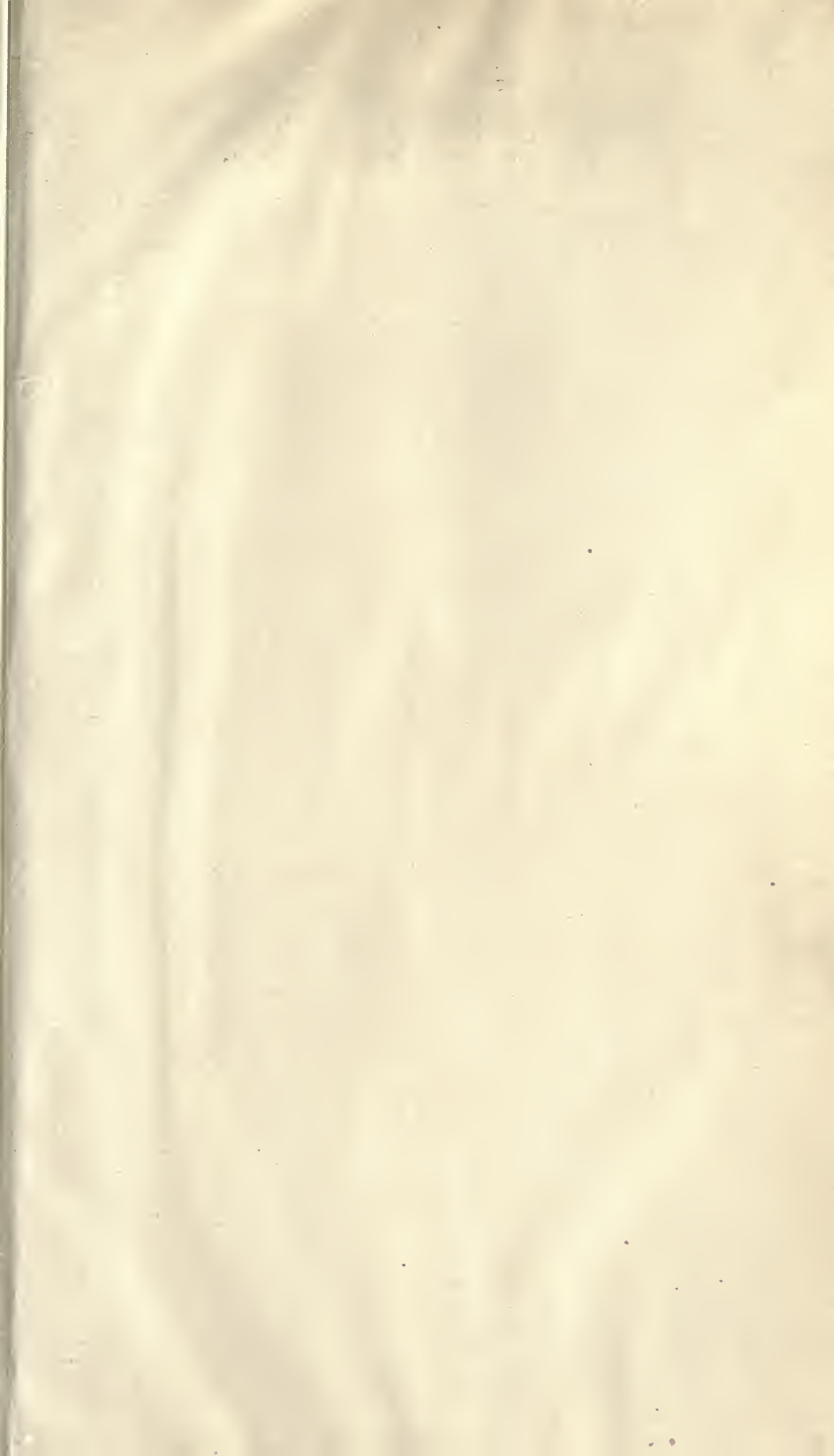

UNIVERSITY OF CALIFORNIA LIBRARY

THIS BOOK IS DUE ON THE LAST DATE
STAMPED BELOW

APR 13 1927

FEB 19 1928
FEB 24 1931

30m-6,'14

TN145
46

62049
Lock

UNIVERSITY OF CALIFORNIA LIBRARY

