



Б 33 307

LIBRARY  
OF THE  
UNIVERSITY OF CALIFORNIA.

*Class*







# ELECTRICAL ENERGY

ITS GENERATION, TRANSMISSION, AND  
UTILIZATION

*Lectures Given at Union University*

BY

ERNST JULIUS BERG, M. A. I. E. E.



Published by the  
**McGraw-Hill Book Company**  
New York

Successors to the Book Departments of the  
McGraw Publishing Company      Hill Publishing Company

Publishers of Books for  
Electrical World      The Engineering and Mining Journal  
The Engineering Record      Power and The Engineer  
Electric Railway Journal      American Machinist



## PREFACE.

---

THIS book is compiled from a series of lectures intended to bridge the theoretical instructions given in the ordinary university education, and the practical problems confronted in commercial engineering. The sequence of the various phenomena discussed is not, therefore, so logical as would be the case if a book on electrical phenomena had been attempted. It is hoped, however, that the arrangement will prove of practical help.

Since many of the questions pertaining to practical engineering cannot be answered by a strictly theoretical calculation, without going into too complex mathematics, some approximate equations have been given, sufficiently accurate for most practical purposes.

Obviously, there can be little originality in the fundamental equations. Almost all problems, however intricate, have been solved; and the difficulty, if not impossibility, of giving due credit has determined the author to omit all references.

I wish to express my warm appreciation and thanks to Dr. Charles P. Steinmetz and Dr. Edwin Wilbur Rice, Jr., whose advice during several years of practical work in Electrical Engineering have materially assisted me; to Mr. Otto Holz, who not only has taken an active part in preparing the book, but has also helped in the proof-reading; to Mr. O. A. Kenyon, who has followed the book through publication, and arranged the notations in conformity with the International Standard; and, finally, to the McGraw Publishing Company, for its generous coöperation in bringing out the work.

E. J. B.





# TABLE OF CONTENTS.

## SECTION I.

TRANSMISSION LINE —	PAGE
Relative merits of direct-current and various alternating-current systems . . . . .	4
Effects of voltage on spacing of transmission wires . . . . .	3
Determination of most economical voltage in power transmissions . . . . .	5
LINE CONSTANTS —	
Equations for determining the resistance, inductance and capacity with commercial arrangements of wires . . . . .	7-15
Numerical instances . . . . .	15
Average inductance and capacity in high-potential lines. Frequency. Standard frequencies. Determination of the natural frequency. Bearing of the natural frequency of the line on the choice of frequency . . . . .	16-20
Discussion of most likely higher harmonic in a transmission line . . . . .	18
Capacity reactance and inductive reactance . . . . .	19
Graphic representation of line phenomena . . . . .	22
Algebraic method of determination of line characteristics . . . . .	24
Principles of algebra of complex quantities . . . . .	26
Complex quantities applied to line calculations . . . . .	27
Maximum output of a transmission line . . . . .	32
Expression of power and apparent power in complex quantities . . . . .	33
Effects of open circuits and short circuits in transmission lines . . . . .	34
Transformer connections in high-potential lines . . . . .	37
Advisability of grounding of neutral in transmission lines . . . . .	38
Investigation of corona effects in air, and in insulated wires . . . . .	38
Minimum distances to avoid corona . . . . .	40
Effects of accidental grounds . . . . .	42
General equation of phenomena due to accidental grounds . . . . .	43
Static stresses in transformers due to accidental grounds . . . . .	46
How to ground the neutral . . . . .	47
Apparent erratic voltage to ground . . . . .	48
Tabulation of numerical constants in transmission lines . . . . .	49
Rating of cables, maximum voltage . . . . .	50
Skin effects in solid and stranded copper and aluminium conductors . . . . .	52
Inductance and capacity in concentric cables . . . . .	53
Effect of lead covering in cables . . . . .	54

	PAGE
Effect of iron armour on constants of cables . . . . .	59
Numerical instances of cable calculations . . . . .	60
Iron conductors and cables used as electrical conductors . . . . .	62
Telephone line. Inductive and static effects with various commercial arrangements of wires . . . . .	63
Striking distances . . . . .	73
Wire table . . . . .	73
Cost of various types of transmission constructions . . . . .	74
SECTION II.	
POWER STATION —	
Prime Movers. Steam turbines, general characteristics of different types, steam velocities used . . . . .	75
The meaning of efficiency . . . . .	76
Determination of available energy in superheated and saturated steam . . . . .	77
Thermal efficiency . . . . .	78
Saving coal and water by superheat . . . . .	78, 82
Reciprocating engines, when best suited . . . . .	83
Combination of reciprocating engines and steam turbines . . . . .	83
Gas engines . . . . .	83
Relation between generator voltage and voltage transmission lines . . . . .	84
Switchboard arrangements . . . . .	86
GENERATORS —	
Necessary tests to determine characteristics . . . . .	87
No-load saturation test . . . . .	87
Armature reaction in machines of definite poles and distributed field winding . . . . .	88
Armature self-induction or reactance depending upon the type of generator . . . . .	90
Synchronous impedance test . . . . .	90
Numerical instances . . . . .	91
Graphical method of determining the induced E.M.F. and the field excitation . . . . .	93-95
Algebraic methods of determining the field excitation for various loads . . . . .	95
Determination of mechanical displacement of armature with load . . . . .	98
Stability as depending upon constants and type of generator . . . . .	103
Synchronizing force . . . . .	103
Hunting of alternators. Theory and numerical instances for different types . . . . .	105
Parallel operation of alternators . . . . .	112
Cross currents caused by pulsation in speed and excitation . . . . .	113
Energy transfer by the fundamental and triple frequency current . . . . .	116
Mechanical arrangements necessary in rigidly connected alternators . . . . .	116
E. W. Rice compensated alternator, theory and numerical instance . . . . .	117

TABLE OF CONTENTS

vii

	PAGE
Alexanderson self-exciting alternator . . . . .	120
Induction alternator, its limitations and rating in connection with synchronous generators . . . . .	123
Half-frequency generator . . . . .	125
Inductor alternator . . . . .	128
Double-current generator . . . . .	129
Synchronizing of alternators . . . . .	129
Instantaneous very large currents in synchronizing . . . . .	131
Wave shape of alternators . . . . .	132
Instances from tests . . . . .	132-136
Interesting data on modern generators of different types . . . . .	135
Transformers. Core type and shell type, single phase and three-phase transformers. Connections of single-phase transformers for multi-phase work. Two-phase, three-phase transformation, single-phase and multiphase compensators . . . . .	137
Transformers in series and multiple connection . . . . .	147-149
Losses, efficiency and regulation of transformers . . . . .	150
Abnormal currents taken by transformers . . . . .	160
Instruments. Direct-current voltmeters and ammeters . . . . .	161
Alternating-current volt and ammeters, electrostatic voltmeter . . . . .	163
Sparkgap as voltmeter. Compensation for line drop. . . . .	164-165
Wattmeters and watthour meters of commutator and inductance type. Curve drawing and recording instruments . . . . .	166
Multiphase meters, limitations of various types . . . . .	166
Power-factor indicator. Synchronism indicators, frequency indicators . . . . .	172, 176
Oscillograph . . . . .	176
Protection of apparatus in generating station . . . . .	178





## LIST OF ILLUSTRATIONS.

---

FIG.	PAGE
1. Inductance between parallel conductors . . . . .	9
2. Capacity between parallel conductors . . . . .	11
3. Wave shape of Delta-connected alternator . . . . .	18
4. Wave shape of Y-connected alternator . . . . .	18
5. Graphic solution of $e_o$ non-inductive current . . . . .	22
6. Graphic solution of $e_o$ 30° lagging current . . . . .	23
7. Graphic solution of $e_o$ 30° leading current . . . . .	23
8. Algebraic method . . . . .	24
9. Complex expression of current . . . . .	26
10. Complex expression of current . . . . .	26
11. Complex expression of current impedance . . . . .	26
12. Constants at receiving end of line . . . . .	32
13. Corona effects in parallel conductors . . . . .	39
14. Effect of leaks in switches . . . . .	42
15. Effect of grounds in systems . . . . .	42
16. Balanced three-phase system . . . . .	43
17. Effect of ground . . . . .	43
18. Effect of ground balanced system . . . . .	45
19. Effect of ground unbalanced system . . . . .	45
20. Electrostatic stresses in generator . . . . .	46
21. Capacity effects in generators and transformers . . . . .	46
22. Balanced capacity in systems . . . . .	46
23. Static stresses with one high-potential line grounded . . . . .	47
24. Erratic ground . . . . .	48
25. Skin effect, resistance coefficient . . . . .	52
26. Inductance of concentric conductors . . . . .	53
27. Grounded lead-covered cable . . . . .	54
28. Grounded lead-covered cable . . . . .	54
29. Grounded lead-covered cable . . . . .	54
30. Grounded lead-covered cable . . . . .	55
31. Single conductor lead-covered cable . . . . .	56
32. Lead-covered, not grounded cable . . . . .	58
33. Telephone line disturbances . . . . .	65
34. Telephone line disturbances . . . . .	66
35. Telephone line disturbances . . . . .	67
36. Telephone line disturbances . . . . .	69

FIG.	PAGE
37. Theoretical water rates . . . . .	79
38. Theoretical water rates . . . . .	79
39. Theoretical water rates . . . . .	80
40. Theoretical water rates . . . . .	80
41. Theoretical water rates . . . . .	81
42. Theoretical water rates . . . . .	81
43. Theoretical water rates . . . . .	83
44. Effect of superheat . . . . .	84
45. Switchboard . . . . .	86
46. Saturation curve of alternator . . . . .	87
47. Armature reaction of alternator . . . . .	88
48. Armature reaction of alternator . . . . .	88
49. Synchronous impedance curve . . . . .	89
50. Synchronous impedance curve . . . . .	90
51. Vector diagram of alternator . . . . .	93
52. Vector diagram of alternator . . . . .	93
53. Vector diagram of alternator . . . . .	94
54. Vector diagram of alternators . . . . .	94
55. Vector diagram of alternators . . . . .	95
56. Saturation curve of alternator . . . . .	96
57. Phase characteristic . . . . .	98
58. Compounding curve of alternator . . . . .	101
59. Phase characteristic . . . . .	101
60. Hunting of alternators . . . . .	106
61. Natural frequency . . . . .	110
62. Natural period . . . . .	112
63. Pulsation in engine speed . . . . .	113
64. E.M.F. corresponding to engine pulsation . . . . .	113
65. Compensated alternator . . . . .	117
66. Alexander alternator . . . . .	121
67. Self-excited alternator . . . . .	122
68. Inductor alternator . . . . .	128
69. Synchronizing of alternators . . . . .	130
70. Synchronizing of alternators . . . . .	130
71. Synchronizing of alternators . . . . .	130
72. Synchronizing of alternators . . . . .	131
73. No-load E.M.F. of alternator . . . . .	132
74. Terminal E.M.F. of alternator . . . . .	133
75. Full-load E.M.F. of alternator . . . . .	134
76. Terminal voltage of alternator . . . . .	134
77. Current in neutral of alternator . . . . .	135
78. Potential in ground connection of alternator . . . . .	136
79. Single-phase core type transformer . . . . .	137
80. Single-phase shell type transformer . . . . .	137
81. Three-phase core type transformer . . . . .	137
82. Three-phase shell type transformer . . . . .	137

FIG.	PAGE
83. Resultant E.M.F. core-type transformer . . . . .	138
84. Resultant E.M.F. shell-type transformer . . . . .	138
85. Resultant E.M.F. shell-type transformer . . . . .	139
86. Transformer connection . . . . .	140
87. Transformer connection . . . . .	140
88. Transformer connection . . . . .	140
89. Transformer connection . . . . .	140
90. Transformer connection . . . . .	141
91. Transformer connection . . . . .	141
92. Two-phase, three-phase transformer . . . . .	141
93. Single-phase compensator . . . . .	143
94. Two-phase, three-phase compensator . . . . .	144
95. Three-phase, two-phase compensator . . . . .	146
96. Series-connected transformers . . . . .	148
97. Parallel connected transformers . . . . .	149
98. Exciting current, single-phase transformer . . . . .	150
99. E.M.F. of generator . . . . .	151
100. Exciting current of transformer . . . . .	152
101. Line current . . . . .	152
102. Neutral current and exciting current . . . . .	152
103. Transformer voltage and current . . . . .	153
104. Triple harmonic exciting current . . . . .	154
105. Transformer voltage . . . . .	154
106. Transformer voltage . . . . .	155
107. Regulation of transformers . . . . .	158
108. Hysteresis cycle of sheet iron . . . . .	160
109. Connections for volt and ammeters . . . . .	163
110. Connections for volt and ammeters . . . . .	164
111. Instruments for line-drop compensation . . . . .	165
112. Wattmeter connections . . . . .	166
113. Wattmeter connections . . . . .	166
114. Single-phase wattmeter in three-phase circuit . . . . .	166
115. Single-phase wattmeter in three-phase circuit . . . . .	166
116. Single-phase wattmeter in three-phase circuit . . . . .	166
117. Two single-phase meters in multiphase system . . . . .	170
118. Single-phase meter in balance multiphase system . . . . .	171
119. Diagram of phase relation . . . . .	172
120. Power-factor indicator . . . . .	173







# THE GENERATION, TRANSMISSION, AND UTILIZATION OF ELECTRICAL ENERGY.

---

## INTRODUCTION.

In the following treatise it has been assumed that the student is in a general way familiar with the fundamental principles of electrical engineering and to some extent with the theories of the various phenomena and apparatus involved. For this reason, when the equations used are found in elementary textbooks, no endeavor is made to deduce them, but their application to practical problems is given. The deductions are, however, made when not otherwise readily available.

The subject will be treated from the consulting and designing engineers' point of view, therefore such practical and theoretical questions will be discussed, as are met by engineers of electrical manufacturing companies. Whenever possible, a general discussion will be given covering the widest range of current practice, at the same time one specific example of a transmission system will be numerically deduced to aid the student in the use of the general equations.

This practical example will be a large power transmission scheme for which the proper system, voltage, frequency, sending and receiving apparatus, etc., must be determined; also the best method of installation, protection, etc., and, finally, some interesting features in the design of the apparatus involved.

That particular problem is to transmit 20,000 kw. 150 miles, for railway and other power purposes; and, independently thereof, 30,000 kw., 100 miles, for lighting.

The first section of the book deals with the transmission line proper, the choice of system, voltage, distance between transmission wires, number of lines in multiple, line constants, frequency, transformer connections and telephone circuit and cost of the line. The second with the power station proper,

some problems in thermo-dynamics, electrical generators, methods of control, and switchboard arrangements. The problems in thermo-dynamics are included although they do not properly belong in a treatise on electrical engineering, since the subject is daily becoming more important and the literature on the effect of superheat, vacuum, etc., is scant and not readily available at the present time. The third with the arrangement of the receiving stations, their apparatus, control, method of secondary distribution, etc.

Sections I and II are incorporated in the first volume; section III, in the second.

## SECTION I.

### TRANSMISSION LINE.

UNDER this heading is included the discussion of the following:

First. *System.* This is determined by commercial conditions — largely the cost of the conductor in the transmission lines.

Second. *The Voltage.* The upper limit is given by experience. At present a line potential of 60,000 volts is successfully used, and 100,000 volts is seriously considered. Such high voltages are not resorted to unless necessary on account of commercial conditions.

Third. *Distance between Transmission Wires.* This is governed by practical experience.

For voltages from 2300 to 6600 the distance is 2 ft. 4 in.

For voltages from 10,000 to 20,000 the distance is 3 ft. 4 in.

For voltages from 20,000 to 30,000 the distance is 4 ft.

For voltages from 30,000 to 50,000 the distance is 5 ft.

For voltages from 50,000 to 60,000 the distance is 6 ft.

Fourth. *Line Constants.* Resistance, induction coefficient and capacity are obtained by calculations.

Fifth. *Frequency.* Partly governed by commercial considerations but also by “the natural period,” which is depending upon the “line constants.”

Sixth. *Transformer Connections.* Under this heading also comes the decision of using a grounded or an ungrounded system. This is largely governed by theoretical considerations, and to some extent by the proximity of trunk lines, of telephone or telegraph wires.

Seventh. *Telephone Line.* The arrangement and protection are governed by theoretical considerations.

## SYSTEM.

Since the cost of the transmission line is usually the largest part of the investment, it is evident that of the alternating current systems, only the three phase, which requires least copper, can be considered. Until recently this system had no rival, but with the introduction of some rather important direct current installations in Europe, this latter, as well as the three phase, needs discussion.

Comparing the various systems on the basis of same maximum value of potential between conductors, we find the following relation between the amount of copper required:

Single phase system . . . . .	100
Two phase four wire . . . . .	100
Two phase three wire . . . . .	146
Three phase three wire . . . . .	75
Direct current . . . . .	50

It is evident from this that, if there is any choice at all, it lies between the direct current and the three phase systems; indeed, were there no other considerations, the direct current system would be chosen, since it requires but two thirds of the copper of the three phase system, and even this amount could be cut in half by using ground as return and only one conductor.

These, indeed, are the arguments which have made the direct current high potential systems possible.

However, the drawbacks are:

First. The enormous complication of the generating and receiving stations, which must involve a large number of units connected in series; since, at the best, each unit can be made for only about 6000 volts.

Second. The difficulties, not to say the impossibility, of future increase of such stations, which are obviously a consequence of the series connection of the generators and motors and the limit imposed by the line potential.

Third. The ground return is not practical on account of telephone and telegraph disturbances, and, to a large degree, on account of the variation in potential around the grounded terminal, which might be sufficient to cause serious accidents.



Fourth. It is not certain that the limit of potential is depending upon the maximum value. Electrolytic action seems to be detrimental to the insulators; so that, though the available practical data is scant, it looks as if the "effective" value of the alternating current voltage gives about as much stress on insulators as the same direct current voltage, though the direct current voltage corresponds to the maximum value of the alternating current wave.

Assuming that the effective alternating current potential is comparable with the direct current voltage, the three phase system would require but 75 per cent of the copper of the direct current system.

Perhaps the relation between the equivalent voltage lies between the two limits discussed above. If so, it would seem as if the amount of copper necessary would be the same.

Considering, therefore, the problematic saving in copper and the serious disadvantages of the direct current system and the flexibility of the alternating current systems, there seems to be, with the present knowledge of the high tension direct current systems, no choice between the two.

The three phase system will, therefore, be more particularly considered and used in the numerical examples referred to above.

#### VOLTAGE.

Since the amount of line conductor is inversely proportional to the square of the voltage, it is well to consider as high a potential as is consistent with good engineering; provided, of course, that the additional cost of insulators, transformers, etc., does not overbalance the saving in cost of the line conductor.

Numerous diagrams and more or less complicated equations have been published which show, for a given cost of installation, conductor, price of delivered energy, load factor, etc., just what is the most economical line voltage.

These equations, however, are so complicated that very little time would be gained (after deducing that necessary to get confidence in the equation) over that required when several different line voltages are investigated.

There seems to be an increasing tendency to go to higher line voltage, partly because of experience gained, and partly

because the price of copper and aluminium has steadily advanced.

Sometimes the line voltage is determined by the generator voltage. At present large slow-speed engine-driven generators have been wound for about 20,000 volts, and it is possible that this voltage is practicable also with turbo generators.

To do away with the step-up transformer, it will frequently pay to adopt such line voltage as will permit connecting the generators directly to the lines, although, considering the line conductor alone, a higher voltage would be advisable.

At least one transmission system is to-day in operation, which delivers power at 60,000 volts. Almost a dozen are being built, so that ample experience with this voltage will soon be available.

In the numerical example, this voltage will, therefore, be considered.

Consider first the longest distance — 150 miles. The power, in that case, shall be used for railway load, involving the use of rotary converters and direct current railway motors or transformers and alternating current motors.

In the former case an excessive line loss is not practicable, on account of the probability of "hunting," which phenomenon will be discussed later in connection with this type of apparatus; in the latter case it is not permissible, on account of the effects on the speed and the lighting of the cars.

More than 15 per cent energy loss with full non-inductive load ought therefore not to be permitted.

Depending upon the price commanded by the delivered energy it may well be possible that a lesser line loss than 15 per cent is permissible.

It is desirable to calculate the transmission system on the basis of at least two different losses, and then from the estimated total cost of installation judge which is preferable.

These cost estimates will be discussed in the latter part of the section.

Although the load is almost always inductive, the line loss is estimated on non-inductive operation, so that in reality the drop in voltage is often considerably more than the assumed loss. This feature will be discussed in connection with the line calculations.

## LINE CONSTANTS.

*Resistance.*

Let  $P$  be the full non-inductive input in kilowatts to the receiving end of the line.

$p$  be the percentage loss of delivered power due to full load non-inductive current over the line resistance ( $p$  expressed as an integer number, not a fraction; thus, for instance, 15 for 15 per cent loss).

$I$  the full load non-inductive current in each phase.

$r$  the resistance of each line, counting the distance as that from generating station to end of line.

$m$  the number of lines in the system.

We have then,

$$\frac{p}{100} \times P \times 1000 = m \times I^2 r,$$

or

$$r = \frac{p \times P \times 1000}{100 \times I^2 \times m}.$$

In a single phase system  $m = 2$ .

In a two phase system  $m = 4$ .

In a three phase system  $m = 3$ .

For the same maximum voltage between lines  $E$ , we have

$$\text{For a single phase system } I = \frac{P \times 1000}{E}.$$

$$\text{For a two phase system } I = \frac{P \times 1000}{2 E}.$$

$$\text{For a three phase system } I = \frac{P \times 1000}{\sqrt{3} E}.$$

Therefore, the resistance of each conductor can also be written as

$$r = \frac{.000005 p E^2}{P}, \text{ for single phase,}$$

$$r = \frac{.00001 p E^2}{P}, \text{ for two phase,}$$

and 
$$r = \frac{.00001 p E^2}{P}, \text{ for three phase.}$$

From the above it is evident that the amount of copper in the single phase and two phase systems is the same. Furthermore, since the resistance of each of the two phase lines is the same as that of the three phase lines, and the three phase system uses three lines only, it follows that the three phase system uses only 75 per cent as much conductor as the two phase system.

Returning now to the numerical example and substituting in the above equation for the three phase system, we get

$$r = \frac{.00001 \times 15 \times 60,000^2}{20,000} = 27 \text{ ohms.}$$

The resistance of each phase is therefore

$$\frac{27}{150} = 0.18 \text{ ohm per mile.}$$

Referring to the wire table given in the last paragraph of this section, we find that two No. 000 B. & S. copper wires in parallel will have practically this resistance.

Although formulæ are very convenient, it is very desirable to know how to do without them; we will, therefore, arrive at the proper line conductor in another way.

With 20,000 kw. delivered at 15 per cent loss, the total loss is  $0.15 \times 20,000,000 = 3,000,000$  watts, therefore the loss in each phase should be 1,000,000 watts.

The line current corresponding to an output of 20,000 kw. at 60,000 volts is

$$I = \frac{20,000,000}{\sqrt{3} \times 60,000} = 192 \text{ amp.}$$

Therefore,  $I^2r = 192^2r = 1,000,000$ , or  $r = 27$  ohms, as found above.

Our calculations happened to demand two conductors in multiple, so that there is no question about installing *duplicate lines*, but even had the figures demanded one conductor only, it would have been wise to have used two, each of one half cross section.

The two lines in multiple, in case a wooden pole line is used, should preferably be strung on independent lines, whereas, when tower construction is used, they can be on the same towers.



Under ordinary conditions both lines are in service, but in case of breakdown of one line all the power can be carried over one at a sacrifice of good voltage regulation.

In the case of the second substation where 30,000 kw. were to be delivered for lighting, it is no doubt necessary to use motor generator or frequency changing sets to raise the frequency to 60 cycles, since 25-cycle lighting is not entirely satisfactory. This will be shown in the third section. In either case, due to the possibilities of hunting, a higher line loss than 15 per cent should not be advocated. We get therefore

$$r = \frac{.000001 \times 15 \times 60,000^2}{30,000} = 18 \text{ ohms.}$$

Thus

$$\text{ohms per mile} = \frac{18}{100} = 0.18.$$

So that, in this case as well as in the case of the first substation, a duplicate line of No. 000 B. & S. copper wire should be used.

In subsequent calculations only one of these two parallel lines leading to the first substation will be considered.

What happened in the one line will occur in the other, as long as it is assumed that the two are in parallel and carry equal load.

#### *Coefficient of Self-Induction.*

In looking up the available literature on this subject, one is surprised at the great number of different formulæ given, which generally consists of two terms, one of which is constant and is variously given as 0.5, 0.75, and 1.

Frequently the constant term is left out altogether, especially in formulæ pertaining directly to standard line constructions.

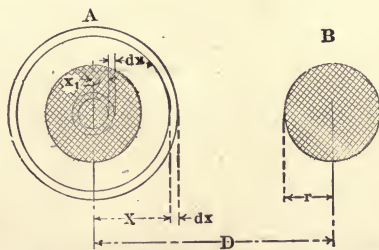

FIG. 1. Inductance between parallel cylindrical conductors.

To clear up the situation the following deductions are made

and a discussion added to show when the approximate formulæ can properly be used.

$A$  and  $B$  in Fig. 1 represent two parallel cylinders of radius  $r$  and distance between centers  $D$ . For convenience in reasoning, it is assumed that they are made up of a large number of strands or elements.

A current  $I$  through conductor  $A$  will set up magnetic fields inside of the conductor and in the surrounding space. Consider at first the flux inside of the conductor.

The flux per unit length of line in zone  $dx_1$  is due to the current inside of zone  $dx_1$ , which current is

$$\frac{x_1^2}{r^2} I.$$

Thus the m.m.f. per unit is

$$\frac{\frac{x_1^2}{r^2} I}{2 \pi x_1}.$$

The field intensity is

$$4 \pi \times \text{m.m.f.} = \frac{2 x_1 I}{r^2}.$$

Therefore the flux

$$\frac{2 x_1 I dx}{r^2}.$$

The e.m.f. corresponding to this flux =  $k \times$  flux

$$= \int_0^r k \times \frac{2 x_1 I dx_1}{r^2} \times \frac{x_1^2}{r^2} = k \frac{I}{2}.$$

The equivalent flux corresponding to this e.m.f. is

$$\frac{kI}{2k} = \frac{I}{2},$$

and therefore the equivalent inductance, which is

$$\frac{\text{flux}}{\text{current}} = \frac{1}{2}.$$

The flux outside of the conductor is found in a similar way.

In that case the m.m.f. per unit length is

$$\frac{I}{2 \pi x},$$



the field intensity

$$4\pi \frac{I}{2\pi x} = \frac{2I}{x},$$

and the flux

$$\begin{aligned}\phi_0 &= \int_r^{D-r} \frac{2I}{x} dx = 2I (\log_e (D-r) - \log_e r) \\ &= 2I \log_e \frac{D-r}{r}.\end{aligned}$$

The total flux expressed in c.g.s. units is, therefore,

$$\phi = I \left( 2 \log_e \frac{D-r}{r} + \frac{1}{2} \right),$$

and the inductance

$$L = \frac{\phi}{I} = 2 \log_e \frac{D-r}{r} + \frac{1}{2}.$$

Transforming this equation to practical units, and expressing  $L$  in milhenrys per mile of conductor, we get

$$L = \frac{161}{10^3} \left( 2 \log_e \frac{D-r}{r} + \frac{1}{2} \right).$$

In transmission lines  $D$  is usually large compared with  $r$ , so that the equation can be written

$$L = \frac{161}{10^3} \left( 2 \log_e \frac{2D}{d} + \frac{1}{2} \right),$$

where  $D$  is the distance between centers of wires and  $d$  their diameter.

#### Capacity.

The capacity between two parallel cylindrical conductors is determined as follows: Let  $A$  and  $B$  in Fig. 2 represent two conductors charged with a certain amount of electricity  $Q$ ,  $A$  being positively charged  $+Q$  and  $B$  negatively charged  $-Q$ .

Around each of these conductors is a field of stress, gradually decreasing towards zero potential.

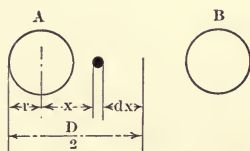

FIG. 2 Capacity between parallel cylindrical conductors.

The total field emanating from  $A$  is  $4 \pi Q$ , thus the field intensity of an element at any distance  $x$  from  $A$  is

$$\frac{4 \pi Q}{2 \pi x} \text{ or } \frac{2 Q}{x}.$$

The corresponding field intensity due to the charge in  $B$  is

$$-\frac{4 \pi Q}{2 \pi (D - x)} = -\frac{2 Q}{D - x}.$$

so that the resultant static field intensity or static potential is

$$\frac{2 Q}{x} - \frac{-2 Q}{D - x} = 2 Q \left( \frac{1}{x} + \frac{1}{D - x} \right).$$

Consequently, in moving the element from the plane of zero potential to the surface of the conductor, its potential rises to

$$\int_r^D 2 Q dx \left( \frac{1}{x} + \frac{1}{D - x} \right),$$

which integrated is

$$2 Q \log_e \frac{D - r}{r}.$$

The capacity, which is the ratio of charge to potential causing the charge, is therefore

$$C = \frac{Q}{2 Q \log_e \frac{D - r}{r}} = \frac{1}{2 \log_e \frac{D - r}{r}},$$

which in electro magnetic units is

$$C = \frac{890 k}{10^4 \log_e \frac{2 D - d}{d}}$$

where  $C$  is microfarads per mile of conductor,  
 $k$  specific inductive capacity,  
 $D$  distance between centers of wires,  
 $d$  their diameter.

In transmission lines where  $k = 1$ , and  $2 D$  is large compared with  $d$ , the formula can sufficiently accurately be written as

$$C = \frac{89}{10^3 \log_e \frac{2 D}{d}}$$

This latter formula ceases to be approximate and becomes accurate if  $D$  denotes the distance from center of wire to the surface of the adjacent conductor.

The coefficient of self-inductance and capacity between two parallel cylindrical non-magnetic conductors placed in air can therefore without approximation be expressed as

$$L = \frac{161}{10^3} \left( 2 \log_e \frac{2 D}{d} + \frac{1}{2} \right)$$

and

$$C = \frac{89}{10^3 \log_e \frac{2 D}{d}}$$

or, when expressed in ordinary logarithms,

$$L = \frac{740}{10^3} \log_{10} \frac{2 D}{d} + \frac{80.5}{10^3}$$

and

$$C = \frac{38.6}{10^3 \log_{10} \frac{2 D}{d}}$$

where  $L$  is the coefficient of self-inductance in milhenrys ( $\frac{1}{1000}$  henry) per mile of wire whether single phase or multiple.

$C$  is the capacity in microfarads ( $\frac{1}{1000}$  farads) between each mile of conductor and neutral plane whether single phase or multiphase.

$D$  is the distance from the center of the conductor to the nearest surface of the return conductor.

$d$  is the diameter of the conductor expressed in same unit as  $D$ .

From the tabulation of proper distances between wires for various voltages, page 3, we find that in the particular numerical examples a distance of 6 ft. should be used.

The diameter of No. 000 B. & S. copper wire is .41 in., thus the coefficient of self-induction in milhenrys per mile of conductor becomes

$$L = \frac{161}{10^3} \left( 2 \log_e \frac{2D}{d} + \frac{1}{2} \right) = \frac{161}{10^3} \left( 2 \log_e \frac{143.6}{.41} + \frac{1}{2} \right)$$

$$= 1.96 \text{ milhenrys.}$$

Thus the total coefficient in each transmission of 150 miles is  $1.96 \times 150 = 292$  milhenrys.

The capacity is expressed as

$$C = \frac{89}{10^3 \log_e \frac{143.6}{.41}} = .0152 \text{ mf. per mile,}$$

or for 150 miles 2.28 mf.

The coefficient of self-induction and capacity against ground can be found directly from the deductions made for parallel conductors, when remembering that  $D$  is the distance between the centers of the conductors, which is twice the distance to the plane of zero potential.

The ground being at zero potential, we can, therefore, use the same formula if we make the proper substitutions, so that if

$D$  is the distance of the conductor above ground,

$d$  its diameter,

$L$  the coefficient of self-induction against ground in milhenrys per mile of conductor, and

$C$  the capacity against ground in microfarads per mile of conductor,

we get

$$L_1 = \frac{161}{10^3} \left( 2 \log_e \frac{4D - d}{d} + \frac{1}{2} \right)$$

and

$$C_1 = \frac{89}{10^3 \times \log_e \frac{4D - d}{d}}$$

Assuming in the numerical instance that the conductor was 40 ft. above ground, we would get

and 
$$L_1 = 440 \text{ milhenrys for 150 miles,}$$

$$C_1 = 1.46 \text{ in farads for 150 miles.}$$

Before concluding the discussion of the induction coefficient and capacity of the transmission lines, it is well to add that with the commercial distances and sizes of line conductors, the numerical values of the inductance and capacity do not vary much. This is shown in the following table, which covers line conductors from No. 1 B. & S., with a diameter of 0.289 in. to a conductor of 1 in. in diameter, also distance of from 4 ft. to 7 ft. between the conductors.

For  $D = 48$  in. and  $d = 1$  in.  $L$  is 1.46 milhenry and  $C$  is .0195 mf.

For  $D = 48$  in. and  $d = 0.289$  in.  $L$  is 1.86 milhenry and  $C$  is .0153 mf.

For  $D = 84$  in. and  $d = 1$  in.  $L$  is 1.65 milhenry and  $C$  is .0173 mf.

For  $D = 84$  in. and  $d = 0.289$  in.  $L$  is 2.04 milhenrys and  $C$  is .0142 mf.

The average induction coefficient per mile of conductor is 1.75 milhenry, and the average capacity per mile of conductor is .0165 mf.

In using these average values for any transmission line of from 20,000 to 80,000 volts, an error greater than 15 per cent is not well possible. In the particular numerical example we are dealing with, the error would have been less than 10 per cent, which ought to be sufficiently accurate for all practical calculations.

From this follows that when using two separate transmission lines the inductive drop is reduced to one half and the charging current doubled.

(The induction coefficient and capacity in each line is substantially the same; in case of two lines, the current in each is 0.5; thus the drop which is proportional to the current is one half. By a similar reasoning we find the charging current doubled.)

Where, therefore, the inductive drop is important, — as in



low potential transmissions and distributions, — it is well to have as many circuits in parallel as possible; where, on the contrary, the charging current is large, it is well to use as few lines as possible.

#### FREQUENCY.

By far the largest amount of electrical power used in the United States is generated at 25 or 60 cycles. Not a few plants operate at 40 cycles, some at 50 and 30, others are contemplated for 12.5 or 15 cycles.

It may be said, however, that 60 cycles is the standard lighting frequency, and 25 the standard "power" frequency.

Other frequencies might be warranted at times, but should not be used unless for good and special reasons.

Long distance transmissions usually are planned for power purposes more particularly, the lighting load being more or less incidental. In such cases 25 cycles should be chosen, since synchronous apparatus operate more satisfactorily at the lower frequency. Where, however, a considerable percentage of the load is lighting, there is great temptation to choose the higher frequency — 60 cycles. It may be justified, but before final decision, it is well to consider not only the increased charging current which may require several generators in operation, although there may be no load proper, but also the possibilities of resonance, due to the coincidence of the "natural period of the line," and some of the higher harmonics of the line current.

#### *The Natural Frequency.*

That is, the frequency at which the system oscillates, due to its own constants, depends only upon the coefficient of self-induction and the capacity as long as the resistance is sufficiently low to permit of any oscillations at all.

With concentrated inductive reactance and concentrated condensive reactance the natural frequency is found by the well known expression:

$$f = \frac{1}{2\pi\sqrt{LC}}$$

With distributed inductive reactance and condensive react-



ance, as is the case in transmission lines, Steinmetz has proven that the frequency is expressed by the following equation:

$$f = \frac{1}{4\sqrt{LC}}$$

where  $L$  is expressed in henrys,  
 $C$  in farads.

Thus if  $L_m$  is expressed in milhenrys  
 and  $C_m$  in microfarads, the  
 equations become

$$f = \frac{5050}{\sqrt{L_m C_m}}$$

for concentrated inductive and condensive reactances,

and

$$f = \frac{7900}{\sqrt{L_m C_m}}$$

for distributed inductive and condensive reactances.

In the 150-mile transmission the natural frequency would therefore be

$$f = \frac{7900}{\sqrt{292 \times 2.28}} = 305 \text{ cycles per second.}$$

It is of interest to note, that since the propagation of electricity and light is substantially the same, this frequency is such that the line constitutes one quarter of the wave length.

Light travels with a velocity of about 185,000 miles per second, therefore, on the assumption given above, we would have arrived at a natural frequency of

$$\frac{185,000}{4 \times 150} = 308 \text{ cycles,}$$

practically the same as obtained above.

The question then is: Which are the likely higher harmonics?

In modern alternators an endeavor is made to shape the magnetic circuit so that the e.m.f. is a sine wave, nevertheless, a triple harmonic of some magnitude usually exists in the e.m.f. wave of single phase alternators, and in each of the individual phases of a multiphase generator.

The e.m.f. between two terminals of a three phase generator

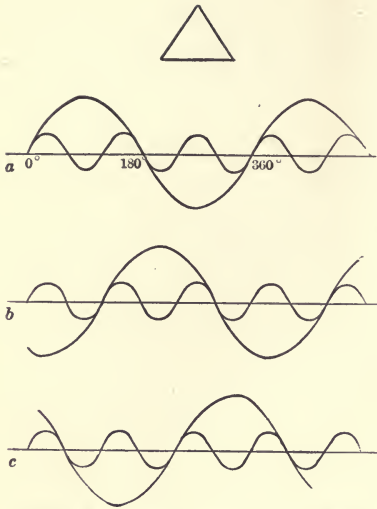

FIG. 3. Wave shape of alternator.

which will consume the e.m.f., which, therefore, will not appear in the terminal e.m.f.

The triple harmonic current will, however, set up an armature reaction which will distort the field magnetism and thereby cause a fifth and seventh harmonic. With Y-connection the terminal e.m.f. is the resultant of two e.m.f.'s  $OA$  and  $OB$  in Fig. 4. Referring to Fig. 4, we see that again  $OA$ ,  $OB$ , and  $OC$ , the individual e.m.f.'s, are displaced 120 degrees. The e.m.f. between  $A$  and  $B$  is the resultant of  $OA$  and  $OB$ , thus  $OA - OB$  (the minus sign on account of the direction). In  $a$  are given the e.m.f.'s in  $OA$ , in  $b$  are given the e.m.f.'s of  $OB$ ; and their resultant (with  $OB$  reversed) is  $c$ . The triple harmonic again has disappeared, but the fundamental is larger

does, however, not contain any triple harmonic for the following reasons: Consider first in Fig. 3 a delta-connected three phase generator in each phase of which is a prominent triple harmonic;  $a$ ,  $b$ , and  $c$  represent the three e.m.f.'s as displaced 120 degrees. It is seen that the three triple harmonics are in phase, thus the machine is really running under short circuit as far as the triple harmonic is concerned. A triple frequency current will be established, which, therefore, will not

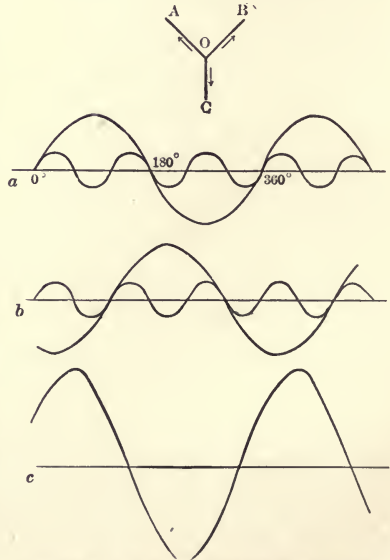

FIG. 4. Wave shape of alternator.

than in the individual phases. In the e.m.f. against the neutral or ground the triple harmonic exists; therefore, the charging current against ground will be of triple frequency and any multiple thereof if permitted to exist, that is, if the generator neutral is grounded.

As will be discussed more fully in connection with transformers, the transformers are a source of triple harmonics e.m.f. or current, but this can also be eliminated if one side of the transformers is delta-connected, as should always be the case.

In general, therefore, it can be said, that the triple harmonic should give no difficulties in a three phase transmission; it need not exist.

The fifth and seventh harmonic, however, do exist, and especially the fifth should be guarded against.

The fifth harmonic, corresponding to a 25-cycle system, is  $5 \times 25 = 125$  cycles; that corresponding to a 60-cycle system is  $5 \times 60 = 300$  cycles.

Thus the critical length of transmission in a 25-cycle system is 360 miles, whereas the critical length in a 60-cycle system is practically 150 miles.

Obviously, by inserting a reactance in the line, the period can be changed, but this means extra apparatus and attention.

The particular line used in the numerical instance would, therefore, be decidedly less suited for 60 cycles than for 25 cycles.

In view of this and the fact that almost all power is used for motors, there can be no hesitation in adopting 25 cycles.

#### REACTANCE.

The inductive reactance which consumes an e.m.f. in quadrature to the current is given by the well known equation

$$x = 2 \pi f L$$

where

$x$  is expressed in ohms,

$f$  is the frequency,

$L$  the coefficient of self-induction in henrys.

If the coefficient is given in milhenrys,

$$x \text{ is expressed as } \frac{2 \pi f L_m}{10^3}.$$

The e.m.f. due to this inductive reactance is obviously

$$Ix = \frac{2 \pi f L_m}{10^3} . I$$

The condensive reactance or the ratio of e.m.f. to charging current is given by the following formula:

$$x_c = \frac{1}{2 \pi f C}$$

where

$x_c$  is expressed in ohms,

$f$  is the frequency,

and

$C$  is expressed in farads;

or, if

$C_m$  is expressed in microfarads,

$$x_c \text{ is expressed as } \frac{10^6}{2 \pi f C_m};$$

or, since

$$x_c = \frac{E}{i_0},$$

we have the following relation between e.m.f., capacity, frequency and charging current:

$$i_0 = \frac{2 \pi f C_m E}{10^6},$$

where  $E$  is the voltage to neutral and  $i_0$  the charging current at the generator. Since the line can be considered as a number of condensers in parallel, it is evident that the charging current decreases as we leave the generator and is nothing at the end of the line.

Complete resonance occurs if the e.m.f. caused by the charging current over the line reactance is the same as the voltage across the condenser. Thus in the case of concentrated reactance and capacity when

$$i_0 x = E$$

or

$$2 \pi f_1 C E \times 2 \pi f_1 L = E,$$

solving this equation on  $f_1$ , the natural frequency, we get

$$f_1 = \frac{1}{2 \pi \sqrt{LC}},$$

which is the same formula as is given above.

Since Steinmetz has proven that with distributed inductive and condensive reactances the natural frequency is

$$f_1 = \frac{1}{4\sqrt{LC}}$$

it follows that the effective inductive reactance and charging current can be written as:  $4 f_1 L$  and  $4 f_1 CE$ , respectively, instead of  $2 \pi f_1 L$  and  $2 \pi f_1 CE$  as given above.

In the numerical example the inductive reactance per 150 miles of conductor would thus be

$$\begin{aligned} x &= \frac{2\pi 25}{10^3} 1.96 \times 150 = 46 \text{ ohms,} \\ \text{and} \\ i_o &= \frac{2\pi 25 .0152 \times 60\,000}{10^6 \sqrt{3}} \times 150 = 12.5 \text{ amp.} \end{aligned}$$

So that the joint inductive reactance, when considering the two parallel lines as one, is 23 ohms, and the joint charging current at the generator is 25 amp. or 13 per cent of full load current.

If the e.m.f. of the fifth harmonic is 15 per cent of that of the fundamental, its charging current would be

$$\frac{2 \times \pi \times 5 \times 25 \times 2.28}{10^6} \times .15 \times \frac{60,000}{\sqrt{3}} = 9.27 \text{ amp.}$$

per phase of each line, or 18.6 amp. per phase of transmission.

The total charging current at the generator would be in this case,

$$\sqrt{25^2 + 18.6^2} = 31.1 \text{ amp.}$$

or 16.2 per cent of full load current, since the resultant current of currents of different frequencies is the square root of the sum of the squares of the individual.

The fact, that the charging current changes along the line, complicates the line calculations considerably.

As a general rule it can be said, that when desiring to determine voltage regulation, the line capacity can be considered as a concentrated capacity, a condenser, of one half line capacity and placed at the end of the line.



When determining current relations, a fair approximation can be made by considering the whole line capacity as a condenser placed in the middle of the line.

For accurate work it is necessary to make independent calculations of the effect of the charging current and the main current.

#### GRAPHIC REPRESENTATION OF LINE PHENOMENA.

This method is instructive and accurate, though seldom used on account of the practical difficulties.

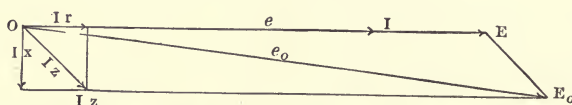

FIG. 5. Graphical solution for  $e_0$  with unity power factor.

In Fig. 5 let  $OE = e$  represent the magnitude and phase of the voltage at the receiving end of the line. A non-inductive current taken by the load is obviously in time-phase with this e.m.f. and may be represented in magnitude by  $OI$ .

This current through the line resistance consumes an e.m.f. in time-phase with itself; represented in the diagram by  $Ir$ .

The inductive reactance voltage, popularly called the e.m.f. of self-induction, lags 90 degrees in time-phase behind the current, and therefore consumes an e.m.f. 90 degrees ahead. Assuming, that time rotates counter-clockwise, the e.m.f. consumed by the line inductive reactance is represented by  $Ix$  in the diagram.

The e.m.f. consumed by the line impedance is, therefore, the resultant of these two and is represented in the diagram by  $Iz$ . The resultant e.m.f.  $e_0$  or  $OE_0$  of  $OE$  and  $Iz$  is therefore the e.m.f. which has to be generated in order to have  $OE$  at the receiving end of the line.

Assume next that the power factor of the load is less than unity and that the current lags behind the e.m.f. The condition of 30 degrees lag which corresponds to a power factor of the load of 86.6 per cent ( $\cos 30^\circ = 0.866$ ) is illustrated in Fig. 6.

$Ir$  and  $Ix$  are as above respectively in phase and 90 degrees ahead of the current  $OI$ . Their resultant  $Iz$  combined with the



terminal voltage  $OE$  is  $OE_0$ , which therefore represents in phase and magnitude the e.m.f. at the generating end of the line. This e.m.f. is larger than in the previous case.

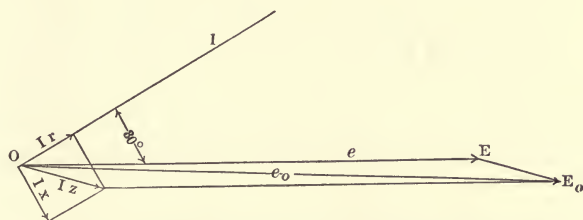

FIG. 6. Graphical solution for  $e_0$ , current lagging  $30^\circ$ .

If, on the other hand, the current taken by the receiving circuit is leading with reference to the e.m.f., as might be the case, if part of the load consisted of condensers or over-excited synchronous apparatus, the conditions would be as represented in Fig. 7.

Again the e.m.f.'s consumed by the resistance and the reactance of the line are respectively in phase and 90 degrees ahead

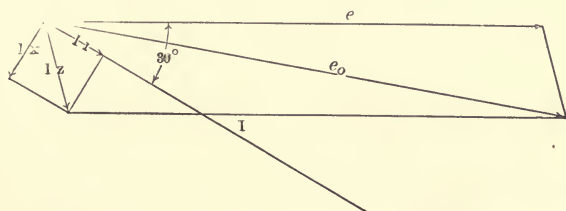

FIG. 7. Graphical solution for  $e_0$ , current leading  $30^\circ$ .

of the current, and combine by the law of parallelograms with the terminal voltage to give the generator voltage  $OE_0$ .

The three diagrams, 5, 6, and 7, are drawn to scale and represent the conditions of the numerical example.

We see, that for the same total current 96 amp. (which is the current in one of the two parallel lines), the generator voltages are respectively 37,123, 39,725, and 41,040 volts with leading, non-inductive and lagging current; the actual energy output with 86.6 per cent power factor being but 86.6 per cent of that at non-inductive load.

The constants used are

$$E = \frac{60,000}{\sqrt{3}} = 34,700 \quad x = 46 \text{ ohms.}$$

$$I = 96 \text{ amp.} \quad Ir = 4750$$

$$r = 49.5 \text{ ohms.} \quad Ix = 4416$$

$$Iz = 6490$$

The relation between power factor and angle  $\theta$  between current and terminal voltage is of course for:

1.00	power factor, $\cos \theta = 1.00$	$\theta = 0^\circ$
0.95	power factor, $\cos \theta = .95$	$\theta = 18^\circ$ approx.
0.90	power factor, $\cos \theta = .90$	$\theta = 26^\circ$ “
0.80	power factor, $\cos \theta = .80$	$\theta = 37^\circ$ “
0.707	power factor, $\cos \theta = .707$	$\theta = 45^\circ$
0.50	power factor, $\cos \theta = .50$	$\theta = 60^\circ$

#### ALGEBRAIC METHOD.

Fig. 8 gives the general diagram in which the algebraic values of the various vectors are indicated.

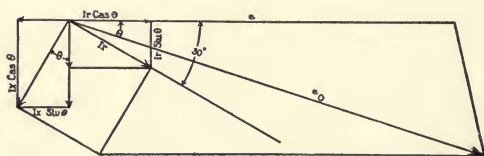

FIG. 8. Algebraic method of determining the generator voltage.

The diagram explains itself and shows that the generator voltage for a given voltage at the receiving end of the line can be expressed as:

$$E_0 = \sqrt{(e + Ir \cos \theta + Ix \sin \theta)^2 + (Ix \cos \theta - Ir \sin \theta)^2}.$$

For non-inductive load  $\theta = 0$ , and we have

$$E_0 = \sqrt{(e + Ir)^2 + I^2 x^2}.$$

For loads of leading current  $\theta$  is negative.

For loads of lagging current  $\theta$  is positive.

EXAMPLE. 86.6 per cent power factor lagging current.

$$I = 96 \qquad \cos \theta = .866, \quad \sin \theta = .5$$

$$r = 49.5 \qquad e = 34,700$$

$$x = 46$$

$$Ir \cos \theta = 4110$$

$$Ix \sin \theta = 2208$$

$$Ix \cos \theta = 3825$$

$$Ir \sin \theta = 2375$$

thus

$$E_0 = 41,040 \text{ volts.}$$

With leading current we get the same numerical values, but  $Ix \sin \phi$  and  $Ir \sin \phi$  become negative.

We therefore get

$$E_0 = \sqrt{(34,700 + 4110 - 2208)^2 + (3825 + 2375)^2} = 37,123.$$

By far the most convenient method is, however, that involving the use of algebra of complex quantities.

For persons slightly familiar with the ordinary algebra the use of complex quantities offers no difficulties, and the theory and justification of their use has been fully dealt with in Steinmetz' book on Alternating Current Phenomena. It will therefore be unnecessary to go into this in detail. It is hoped that the following explanation will suffice.

A current  $I$  consisting of a power or watt component  $i$  and a wattless lagging component  $i_1$  can be written as:

$$I = \sqrt{i^2 + i_1^2}$$

or as

$$\sqrt{(I \cos \theta)^2 + (I \sin \theta)^2}$$

The watt component  $i$  is  $I \cos \theta$ , the wattless component  $i_1$  is  $I \sin \theta$ , and the total or resultant current is the hypotenuse in a triangle having  $i$  and  $i_1$  as sides.

By remembering this relation between the three quantities, we could write

$$I = i + j i_1$$

using a dot under  $I$  to show that it represents the hypotenuse, so that  $i$  and  $i_1$  must be added vectorially.

The index  $j$  is used to denote that  $i_1$  is at right angles to  $i$ . The plus sign is used to show that  $i_1$  is positive, that is, should be added in positive direction, as shown in Fig. 9 and not

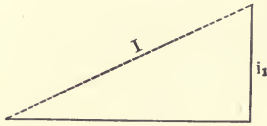

Fig. 9. Complex expression of current.

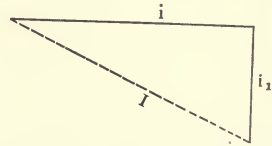

Fig. 10. Complex expression of current.

as in Fig. 10.  $i_1$  represents in that case the lagging component. It is readily proven that  $j$  not only is a convenient index but is the imaginary unit and  $j = \sqrt{-1}$ .

The impedance of a line is expressed by two quantities  $r$  and  $x$ ; these two are also at right angles to each other. Thus the impedance might be written as  $Z = r + jx$ , and we realize that the numerical value of  $Z$  or  $z = \sqrt{r^2 + x^2}$ .

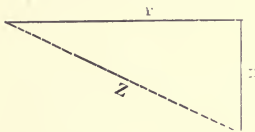

Fig. 11. Complex expression of impedance.

Since, however, the reactance consumes an e.m.f. 90 degrees ahead of the current, the diagram should be constructed as in Fig. 11. In other words,  $x$  is negative, which fact should be shown in the imaginary equation by

using the minus sign.

Thus, the impedance should be written as

$$Z = r - jx.$$

The voltage consumed by the line impedance  $r - jx$  when a lagging current,  $i + ji_1$ , is flowing, is  $IZ = (i + ji_1)(r - jx)$ , which multiplied gives

$$ir + i_1x + j(i_1r - ix).$$

For lagging current and condensive reactance we get

$$(i + ji_1)(r + jx) = ir - i_1x + j(i_1r + ix).$$

For leading wattless current and inductive reactance we get

$$(i - ji_1)(r - jx) = ir + i_1x - j(i_1r + ix).$$

The actual numerical value of a complex expression  $a \pm jb$  is always

$$\sqrt{a^2 + b^2}.$$

Since  $a \pm jb$  really represents the hypotenuse of a triangle having  $a$  and  $b$  as sides, it matters not whether  $a$  or  $b$  are positive or negative.

The numerical values of the drops are, therefore, respectively:

$$\sqrt{(ir + i_1x)^2 + (i_1r - ix)^2}$$

$$\sqrt{(ir - i_1x)^2 + (i_1r + ix)^2}$$

$$\sqrt{(ir - i_1x)^2 + (i_1r + ix)^2}$$

$$\sqrt{(ir + i_1x)^2 + (i_1r - ix)^2}$$

It would, however, not be possible to use these values directly in finding the drop in the line, since this drop may not, and usually is not, in phase with the voltage at the receiving end of the line.

To determine the drop it is necessary to settle on a "base line," which, depending upon the character of the problem, might be the voltage at the receiving end of the line, the power component of the current, etc.

As a rule the main part of any given problem is to choose the best "base line."

If in the determination of the line phenomena, it is desirable to keep the voltage at the receiving end constant, it is well to make this voltage the base line. If, on the other hand, the generator voltage is to be kept constant, this voltage is made the base line.

In the first case let

$e$  be the voltage at the receiving end of the line,

$Z = r - jx$  be the line impedance,

$I = i + ji_1$  be the current,

$i_1$  being positive for the lagging current and negative for leading current,

$E' = e' + je'_1$  the voltage at the generator.





Since the generator voltage is the sum of the voltage consumed by the line impedance and the voltage at the receiving circuit, we get

$$\begin{aligned} E' &= e + IZ = e + (i + j_1)(r - jx) \\ &= e + ir + i_1x + j(i_1r - ix). \end{aligned}$$

This equation shows that the numerical value of the generator voltage is

$$\begin{aligned} E' &= \sqrt{(e + ir + i_1x)^2 + (i_1r - ix)^2} \\ &= \sqrt{e^2 + I^2Z^2 + 2e(ir + i_1x) \dots \dots \dots} A \end{aligned}$$

It shows also, that the total voltage is lagging behind the voltage at the receiving end by an angle  $\theta$  whose tangent is

$$\frac{i_1r - ix}{e + ir + i_1x}.$$

If, on the other hand, the generator voltage should be kept constant, the problem would best be solved as follows:

Let

$$\begin{aligned} Z_0 &= r_0 - jx_0 \text{ be the load impedance,} \\ Z &= r - jx \text{ the line impedance,} \\ e_1 &= \text{generator voltage,} \\ E &= \text{voltage at the receiving end of the line.} \end{aligned}$$

We have then:

$$\text{The total impedance} = Z_0 + Z = r_0 + r - j(x_0 + x).$$

The current  $I$  is therefore

$$\frac{e_1}{Z_0 + Z} = \frac{e_1}{r_0 + r - j(x_0 + x)},$$

or in real value

$$I = \frac{e_1}{\sqrt{(r_0 + r)^2 + (x_0 + x)^2}}.$$

The line drop is  $I(r - jx)$  and the voltage across the load

$$= I(r_0 - jx_0) = \frac{e_1(r_0 - jx_0)}{(r_0 + r) - j(x_0 + x)}.$$



By multiplying with  $(r_0 + r) + j(x_0 + x)$   $j$  disappears in the denominator and the equation becomes:

$$\begin{aligned} E &= \frac{e_1 (r_0 - jx_0) (r_0 + r + j(x_0 + x))}{(r_0 + r)^2 + (x_0 + x)^2} \\ &= \frac{e_1}{(r_0 + r)^2 + (x_0 + x)^2} [r_0(r_0 + r) + x_0(x_0 + x) \\ &\quad + j((x_0 + x)r_0 - (r_0 + r)x_0)]. \end{aligned}$$

The numerical value of the voltage at the receiving end of the line is therefore

$$\begin{aligned} e &= \frac{e_1}{(r_0 + r)^2 + (x_0 + x)^2} \\ &\times \sqrt{(r_0(r_0 + r) + x_0(x_0 + x))^2 + ((x_0 + x)r_0 - (r_0 + r)x_0)^2} \\ &= e_1 \sqrt{\frac{r_0^2 + x_0^2}{(r_0 + r)^2 + (x_0 + x)^2}} \dots \dots \dots B \end{aligned}$$

This equation shows that the relation between the voltage at the receiving end of the line and the generator is the same as between the load impedance and total impedance.

The power factor of the load enters obviously by the constants of the resistance and reactance of the load.

Numerical application of equation A.

$$\text{Voltage at receiving end of line } e = \frac{60,000}{\sqrt{3}} = 34,700 \text{ volts.}$$

Power factor of load 86.6 per cent.

Current lagging.

$$\text{Total current } I = 96 \text{ amp., } I^2 = 9220.$$

$$\text{In phase component of current } i = I \cos \theta = .866 I = 83 \text{ amp.}$$

$$\text{Lagging component of current } i_1 = I \sin \theta = .5 I = 48 \text{ amp.}$$

$$r - jx = 49.5 - 46j = \text{line impedance.}$$

$$Z = \sqrt{r^2 + x^2} = .67.5 \text{ ohms.}$$

$$Z^2 = 4565 \text{ ohms.}$$

Substituting these values in equation A we get:

$$\begin{aligned} e_1 &= \sqrt{34,700^2 + 9220 \times 4565 + 2 \times 34,700 (83 \times 49.5 + 48 \times 46)} \\ &= 41,040. \end{aligned}$$

Therefore, the voltage between the lines at the generator is  $41,040 \sqrt{3} = 71,000$ , and the per cent drop in voltage is 18.34 per cent.

As another example we shall use equation *B* and assume a generator voltage of 41,040 volts per phase, and from the line constant determine the voltage at the receiving end of the line.

Since the power factor of the load is assumed as 86.6 per cent, we have the following relation between the load resistance and reactance:

$$\frac{r_0}{x_0} = \frac{0.866}{0.5}, \text{ or } x_0 = 0.577r_0.$$

$$\begin{aligned} \text{Thus,} \quad r_0 + r &= 49.5 + r_0 \\ x_0 + x &= 46 + 0.577r_0. \end{aligned}$$

The volt-ampere output at the receiving station is from the above.

$$\begin{aligned} IE &= \sqrt{\frac{e_1^2}{(r_0 + r)^2 + (x_0 + x)^2}} \times \sqrt{\frac{r_0^2 + x_0^2}{(r_0 + r)^2 + (x_0 + x)^2}} \\ &= \frac{e_1^2 \sqrt{r_0^2 + x_0^2}}{(r_0 + r)^2 + (x_0 + x)^2} \end{aligned}$$

and the load impedance corresponding to the maximum volt ampere at the receiving circuit is obtained by substituting:

$$\frac{\delta IE}{\delta(z_0)} = 0$$

and solving for  $r_0$  and  $x_0$ .

For a given power factor of the load a definite ratio exists between  $r_0$  and  $x_0$ , so that we can write  $x_0 = kr_0$ .

The equation then becomes:

$$EI = \frac{e_1^2 r_0 \sqrt{1 + k^2}}{(r_0 + r)^2 + (kr_0 + x)^2}$$

thus,

$$\begin{aligned} (r_0 + r)^2 + (kr_0 + x)^2 e_1^2 \sqrt{1 + k^2} - e_1^2 r_0 \sqrt{1 + k^2} \times (2(r_0 + r) \\ + 2k(r_0 + x)) = 0. \end{aligned}$$

which solved gives:

$$r_0 = \sqrt{\frac{x^2 + r^2}{1 - k^2 + 2k}}$$

This equation then gives the numerical value of the load resistance which gives maximum output in volt-amperes at the receiving circuit. The energy output is obviously obtained by multiplying by  $\cos \theta$ , which is the power factor.

In this instance  $k$  is 0.577.

Thus, for —

$r_0 = 0$	$I = 608$	and	$E = 0$	volt-amp. = 0
$r_0 = 50$	$I = 329$		$E = 19,000$	volt-amp. = 6,250,000
$r_0 = 100$	$I = 226$		$E = 26,000$	volt-amp. = 5,875,000
$r_0 = 200$	$I = 138$		$E = 31,900$	volt-amp. = 4,400,000
$r_0 = 300$	$I = 99.5$		$E = 34,450$	volt-amp. = 3,430,000
$r_0 = 500$	$I = 63.8$		$E = 36,800$	volt-amp. = 2,345,000

The resistance which corresponds to maximum output is

$$r_0 = \sqrt{\frac{49.5^2 + 46^2}{1 - 0.33 + 1.14}} = 50.2 \text{ ohms}$$

when the volt-ampere output is 6,200,000 and the power output per phase  $0.866 \times 6,200,000 = 5,350,000$ , and, therefore, the total output is  $3 \times 5,350,000$  watts = 16,100 kw. The normal output at 86.6 per cent power factor is 8660 kw., so that the line is able to give practically double output.

The numerical values are plotted on Fig. 12.

In investigating the line conditions it is very convenient to express the resistance, reactance, currents and e.m.f.'s in percentages.

This has the advantages, that the same calculation can be used for many different conditions. In that case, the voltage at the generator or receiving end of the line and the power component of the full load current are taken as unity, and the resistance and reactance determined from the percentage drop of rated voltage with the current. The wattless component of the current is also expressed in percentage of the power component of the full load current, as the case may be.

As a numerical example, consider in this case, that the voltage at the receiving end and full load current is unity.

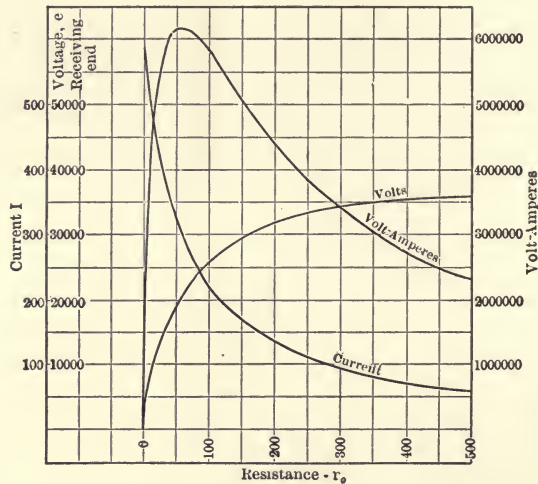

FIG. 12. Curves showing relation between current, voltage, and volt-ampere output at the receiving end of a line.

We have then, when considering in this instance the two parallel lines as one — which carries the current corresponding to 20,000 kw.:

$$e = 1$$

$$i = 1$$

$$r = \frac{192 \times 23}{34,700} = 0.137$$

$$x = \frac{192 \times 23}{34,700} = 0.127$$

and  $i_s$  the average charging current  $\frac{12.5}{192} = -0.065$ .

Substituting these values in equation A we get for non-inductive load:

$$e' = \sqrt{1 + 1.004 \times 0.037 + 2(0.137 - 0.065 \times 0.127)} = 1.135.$$

The voltage at the generator is, therefore, 13.5 per cent greater than at the receiving end of the line.

With a receiving circuit of 50 per cent power factor we have:

$$\cos \theta = .5; \text{ thus, } \theta = 60^\circ \text{ and } \tan \theta = 1.73.$$

$$\frac{i_1}{i} = \tan \theta = 1.73; \text{ thus, } i_1 = 1.73.$$

We must, however, subtract from this lagging component of the current the average charging current, which is leading; thus  $i_1$  in the equation becomes  $1.73 - .065 = 1.665$ .

$$I^2 = i^2 + i_1^2 = 1 + 1.665^2 = 3.77.$$

We get then:

$$e_0 = \sqrt{1 + 3.77 \times 0.037 + 2(0.137 + 1.665 \times 0.127)} = 1.35.$$

In this case then the voltage at the generator must be 35 per cent greater than at the receiving end of the line, although the actual output is the same.

At no load on the external circuit there is no current except the charging current. We have then:

$$e_0 = \sqrt{1 + 0.0042 \times 0.037 - 2 \times 0.065 \times 0.127} = 0.99.$$

There is, therefore, a rise in voltage at the receiving end of 1 per cent.

Assuming that the e.m.f. of the fifth harmonic is 15 per cent of the fundamental, it is interesting to see how the voltage is affected thereby. The charging current is then  $5 \times 0.15 \times .065 = .0487$  amp., the reactance is  $5 \times 0.135 = 0.675$ , resistance 0.135.

Thus,

$$e_0 = \sqrt{1 + 0.0237 \times .457 + 2(0 - .0487 \times .675)} = 0.967.$$

Thus the voltage at the receiving end, due to the fifth harmonic, is therefore 15 per cent of 3.3 per cent thus negligible.

The apparent power or volt-ampere at the generator is

$$E_0 I_0 = (e_0 + j e_{01}) (i + j i_1)$$

where

$$e_0 \text{ is } e + ir + i_1 x$$

$$e_{01} \text{ is } i_1 r - ix.$$

Thermal power is, as shown by Steinmetz, expressed by

$$e_0 i + e_{01} i_1$$



or

$$P = (e + ir + i_1x) i + (i_1r - ix) i_1.$$

The "wattless power" is

$$e_{01}i - e_0i_1$$

or

$$P_1 = (i_1r - ix) i - (e + ir + i_1x) i_1$$

$$\text{tg } \phi = \frac{P_1}{P}.$$

\*  $\text{Cos } \theta$  = power factor at the generator.

In this instance:

$$P = 1 + 0.137 + 1.66 \times 0.127 + (1.665 \times 0.137 - 0.127) 1.66 \\ = 1.49$$

$$P_1 = 1.66 \times 0.137 - 0.127 - (1 + 0.137 + 1.66 \times .127) 1.66 \\ = -2.13$$

$$\frac{2.18}{16} = 1.36 \theta_2 \quad 53^\circ 91 \quad \text{cos } \theta = .59$$

$$\text{tg } \theta = -\frac{2.13}{1.51} = 1.41 \quad \theta = 54^\circ 30'$$

$\text{Cos } \theta = 0.56$ . The power factor of the generator is, therefore, 56 per cent. Although the current has to pass the line reactance, the power factor is slightly better than at the receiving end, because the line loss is considerable.

In connection with the rise of voltage in a transmission line, it is of importance to determine also the

#### *Effects of Short Circuits and Open Circuits.*

This leads to the consideration of the energy stored. The energy in joules (watt-seconds) stored electromagnetically is  $0.5 LI^2$ . The energy in joules stored electrostatically is  $\frac{1}{2} CE^2$ .

Therefore, if the line is disconnected at the moment the current has a given instantaneous value  $i$ , energy is stored which must be spent some way. The only path for the current is formed by the line capacity, therefore the line becomes charged to a certain voltage depending upon its constants, next it discharges in the inductive circuit formed by the line,

so charges again, etc. A current oscillates in the system, until the energy is spent in the resistance of the line.

Therefore, with low resistance, there will be many surges, and with high resistance few surges. The two energy equations become:

$$\frac{1}{2} LI^2 = \frac{1}{2} CE^2; \text{ thus, } E = I \sqrt{\frac{L}{C}}$$

and

$$I = E \sqrt{\frac{C}{L}}$$

where  $L$  is expressed in henrys and  $C$  in farads.

Substituting the average values of the coefficient of self-induction and capacity, we get

$$E = 325 I, \text{ and } I = \frac{E}{325}.$$

Opening a switch at an instantaneous value of current, of 96 amp. the rise in voltage would be

$$E = 96 \times 325 = 31,200.$$

Thus, if this e.m.f. is in phase with the main e.m.f. we would have practically double voltage between the lines. Obviously, at a short circuit when there is a very large current the voltage might well be several times the normal.

In interrupting the charging current a very slight rise can take place since the current then is small.

In connecting a line to a transformer or generator a very large instantaneous current is, however, likely to be established, as can be seen from the above equation.

In our example, if the instantaneous voltage was 34,700 we would have  $I = \frac{34,700}{325}$  or over a hundred amperes — about ten times normal charging current. If, instead of an overhead line, we had a cable system, the current might well be very large indeed, and is of course determined by equation

$$I = E \sqrt{\frac{C}{L}}.$$

Several interesting conclusions can be drawn from the above.

First. Since in the equation governing the rise in voltage, the coefficient of self-induction and the capacity enter as a ratio, it is evident that the rise is independent of the length of the line.

Second. The energy stored is proportional to the length of the transmission line; therefore, since the frequency as will be shown later is inversely proportional to the length, the higher the frequency the less energy is involved.

Third. Since with any commercial grouping of wires  $\frac{L}{C}$  is approximately the same, we can say that in any transmission, no matter how long or what size conductors is used, the maximum rise in voltage is approximately  $325 I$ .

Fourth. The rise in voltage is practically the same for the same current; therefore, the lower the voltage the more likelihood of trouble, due to this cause, since the insulator usually is chosen chiefly with reference to the line potential.

Fifth. While in high voltage transmissions four to five times normal voltage can be expected as a maximum when opening a short circuit, in transmissions of moderate voltage we might readily have ten times normal potential in opening a short circuit.

Sixth. There is little rise in voltage in disconnecting a line carrying charging current only since this current usually is small.

Seventh. It is evident that since the rise in voltage is proportional to the current existing at the time, such current interrupting devices should be used as disconnect, when the current value passes through zero. Such a device is a properly designed oil switch.

An air switch, unless used on circuits of extremely high voltage, may cause an interruption at a certain value of current which will cause surging.

Eighth. The instantaneous charging current of the line might well be several times full load current, therefore a rise in voltage may occur in connecting the line to the generator.

TRANSFORMER CONNECTIONS AND CONSIDERATIONS IN DECIDING  
FOR OR AGAINST A GROUNDED SYSTEM.

There is no item in connection with the layout of an electric transmission system which is more subject to differences of opinion than the best transformer connection, and whether the system should run with grounded neutral or not.

The advocates of the delta-delta system maintain quite rightly, that this system offers a great advantage over any other involving Y connection, since with any open circuit or short circuit on the line, transformer connections or windings, resonance cannot take place. It has, however, disadvantages as will be shown later, which seriously limits, and often excludes, its use. At the same time, the static stresses imposed upon the transformer windings and the generator winding, in case one line is grounded, are highly objectionable, and may be of such magnitude as to be a source of frequent breakdowns of the insulation.

The fact that the voltage on the high potential winding to ground is 73 per cent greater than under normal condition, when one line is grounded, may appear most important, but the more important fact, which is frequently overlooked, is that with such ground the low potential winding of the transformer and the generator winding may be subjected to many times normal voltage.

When, as is usually the case, the generator winding is not grounded the static potential will be distributed between the low potential winding of the step-up transformer and generator winding inversely as their capacities against ground. Thus, if, for instance, these capacities were equal, one half of the high potential voltage would be found from the low potential winding of the transformer to ground, the other from the generator winding to ground.

Of other transformer connections the delta-Y connection on the step-up side and Y-delta on the step-down side is the best, although with this connection, as well as with any other connection except the delta-delta, there is a possibility of resonance, which could occur in case the receiving system supplied leading current either from synchronous apparatus, or from a second high potential circuit in parallel; provided in



each case one delta connection of the secondaries of the step-down transformers were accidentally open circuited. In a single transmission line, supplying power to lamps or induction motors, no resonance can occur under any condition whatever.

Such system should be used with a grounded neutral, in which case, at step-up as well as step-down side, in case of an accidental ground, a short circuit results.

By installing in each of the lines single pole automatic switches such short circuit need do no harm, and the service need not be interrupted, since considerable power can be transmitted over two of the wires and ground as the third. In this case serious telephone and telegraph disturbances might, however, take place, unless the telephone or telegraph lines are insulated for high potential, say 10,000 to 12,000 volts. In fact, if the transmission line parallels established trunk lines of telephone or telegraph wires for some considerable distance, due to the probability of serious interferences and legal complications, it might be well to decide at once upon the use of delta-delta connections.

The arrangement of the delta-*Y* and *Y*-delta connection has the following advantages: Since the voltage across each of the high potential windings of the transformer is only 58 per cent of the line voltage, it is easier to insulate, and when line voltages of from 60,000 to 100,000 volts are used, this is indeed a very important point. It enables one to operate with one line grounded with 58 per cent of the static voltage of that which would exist in the delta system.

It is obviously desirable to have as few prominent higher harmonics as possible in a transmission line, and it is interesting to note that the two systems are practically on a par in this respect.

#### CORONA EFFECTS.

In order to appreciate the difficulties met with in insulating wires for very high potentials, which often are caused by accidental grounds, it is important to study the limiting conditions; the least amount of insulation for given diameter of wires, distance to ground, etc.

This leads to the investigation of corona effects.



Referring to Fig. 13, in which a conductor of radius  $r$  is represented as charged to a potential difference of  $E$  volts from surrounding concentric tube of radius  $R$  at zero potential. The field emanating from this conductor is  $4\pi Q$ . Therefore, the field intensity of an element at the distance  $x$  from the conductor is  $\frac{4\pi Q}{2\pi x} = \frac{2Q}{x}$ . Therefore, in moving the element from the position of zero potential to the surface of the condenser its potential

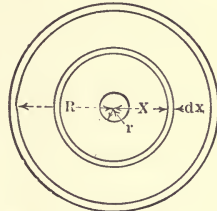

FIG. 13. Investigation of corona effects in parallel conductors.

$$E = \int_r^R \frac{2Q}{x} dx = 2Q \log_e \frac{R}{r}.$$

The potential at position  $x$  from the conductor is evidently

$$E_x = \int_x^R \frac{2Q}{x} dx = 2Q \log_e \frac{R}{x}.$$

Therefore, we get the following relation between the e.m.f. at any distance from the conductor and at the surface of the

conductor as

$$\frac{E_x}{E} = \frac{\log_e \frac{R}{x}}{\log_e \frac{R}{r}}.$$

The potential gradient is

$$\frac{dE_x}{dx} = \frac{1}{x} \frac{E}{\log_e \frac{R}{r}}.$$

Therefore the potential gradient at the surface of the conductor is

$$e = \frac{E}{r \log_e \frac{R}{r}}.$$

and at the inside of the outside sphere representing ground potential:

$$e_1 = \frac{E}{R \log_e \frac{R}{r}}.$$

The stress is therefore as much greater at the conductor than at the shell as  $R$  is larger than  $r$ .

Obviously, when applying this to parallel conductors, we should use as  $R$ , one half the distance between conductors, and as  $E$ , the voltage to neutral.

From a number of experiments, it looks as if at atmospheric pressure 14.7 lb. abs. of the maximum permissible stress that can be permitted in air is 100,000 volts per inch. (In all probability this maximum stress varies with the absolute pressure.) Based upon this value we obtain the following voltages of corona:

R		No. 10 B. & S.	No. 4 B. & S.	No. 000		
		$r=0.05$ in.	$r=0.10$ in.	$r=0.20$ in.	$r=0.5$ in.	$r=l$ in.
		E	E	E	E	E
5	in.	23,000	39,000	64,000	115,000	161,000
10	in.	26,500	46,000	78,000	150,000	230,000
20	in.	30,000	53,000	92,000	184,000	300,000
50	in.	34,500	62,000	110,000	230,000	390,000
100	in.	39,000	69,000	124,000	264,000	460,000
500	in.	46,000	85,000	156,000	345,000	620,000

We see, for instance, that in a 60,000-volt ungrounded system, where the potential to ground can readily be 64,000 volts, the wire that could be used in carrying the line through a wall having a hole 10 in. diameter shall be larger than No. 000 B. & S. Any smaller wire would give corona effects. No. 4 B. & S. would, at the same voltage, require a hole of about 100 in. diameter.

It is also evident, that if, as often is the case, the high potential bus bars are carried in compartments within but a few inches from the walls, we must expect corona effects, especially so where there is a sharp bend in the wires, whenever for some reason the voltage is increased above normal. Incidentally we see the desirability of using large round bus bars instead of small rectangular bars.

The dielectric strength of insulating materials is greater than that of air, so for instance, from a number of experiments, it seems that insulation made of strips of rubber has a strength of about 350,000 volts per inch; oil of about 200,000 volts per inch; and varnished linen or paper, between 250,000 and 300,000 volts per inch. It is evident from this that we cannot subject this insulation to higher stress than this without causing deterioration. In the following table is calculated how much insulation is necessary with various sizes of wires and materials of various dielectric strengths.

**THICKNESS OF INSULATION IN INCHES WITH VARIOUS  
STRESSES AT SURFACE OF CONDUCTOR.**

500,000 VOLTS TO GROUND.

$r$	$e = 70,000$	$e = 140,000$	$e = 200,000$	$e = 350,000$
0.05	$5 \times 10^{50}$	$5 \times 10^{28}$	$2506 \times 10^{16}$	$1256 \times 10^0$
0.10	$1 \times 10^{29}$	$3163 \times 10^{10}$	$708 \times 10^8$	158,500
0.20	$6325 \times 10^{10}$	$1125 \times 10^3$	53,220	251.6
0.50	792,400	628.9	73.46	8.189
1.00	1258	34.49	11.16	3.169

300,000 VOLTS TO GROUND.

0.05	$7925 \times 10^{31}$	$1991 \times 10^{13}$	$5236 \times 10^7$	1,377,000
0.10	$3981 \times 10^{12}$	$1995 \times 10^4$	322,500	324.8
0.20	$3991 \times 10^4$	8934	3598	14.29
0.50	2623.5	35.72	9.7	2.273
1.00	71.45	7.512	3.478	1.355

150,000 VOLTS TO GROUND.

0.05	$1991 \times 10^{13}$	99,760,000	161,800	262.4
0.10	$1995 \times 10^4$	4666	179.8	7.1444
0.20	8934	42.07	8.283	1.502
0.50	35.72	3.755	1.739	0.677
1.00	7.512	1.918	1.112	0.535

60,000 VOLTS TO GROUND.

0.05	1,380,000	263	20.04	1.488
0.10	325	7.15	1.904	0.4546
0.20	14.3	1.5	0.6954	0.271
0.50	2.28	0.68	0.4108	0.2043
1.00	1.35	0.54	0.35	0.187

30,000 VOLTS TO GROUND.

0.05	263	3.6	0.9525	0.2273
0.10	7.15	0.752	0.34477	0.1355
0.20	1.5	0.384	0.2232	0.1041
0.50	0.68	0.27	0.1748	0.0934
1.00	0.54	0.24	0.162	0.09

15,000 VOLTS TO GROUND.

0.05	3.6	0.37	
0.10	0.752	0.192	
0.20	0.384	0.14	
0.50	0.27	0.12	
1.00	0.24	0.11	

It is interesting to see that, even with rubber insulation, we should insulate a wire of 1 in. diameter with about 8 in. of insulation if subjected to 500,000 volts potential to ground.

At 300,000 volts we should need 2.27 in. of insulation.  
 At 150,000 volts we should need 0.68 in. of insulation.  
 At 60,000 volts we should need 0.20 in. of insulation.

This would give no safety factor whatever. At 500,000 volts the smallest wire that can be insulated is about 1 in. in diameter. At 300,000 volts 0.5 in. in diameter; at 150,000 volts, 0.20 in. diameter; and 60,000 volts, a very small wire.

But limiting the stress to 140,000 volts per inch we find that:

For 500,000 volts the wire should be more than 2 in. in diam.  
 300,000 volts the wire should be about 2 in.  
 150,000 volts the wire should be just a little less than 1 in.  
 60,000 volts the wire should be 0.20 in. or about No. 000 B. & S.  
 30,000 volts the wire should be 0.10 in. or about No. 10 B. & S.

It is evident from this that it is very essential to keep the maximum voltage down when considering voltages around from 60,000 to 100,000 volts. By grounding the neutral we limit this to 58 per cent of the voltage between lines. Assuming that the terminal of one phase through a slight leak is connected to ground; the voltage between the other phases and ground will then be almost doubled, being  $e\sqrt{3}$  (Fig. 14).

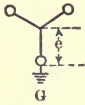

FIG. 14.  
 Effect of slight leaks in switches, etc.

If there are two sets of generators running independently, and there is a slight leak from one terminal of one to that of the other, and also a slight leak to ground, there will be at times 3.5 times as great potential to ground as when the neutral is grounded (see Fig. 15). This condition might well occur when synchronizing machines or transformers. In circuits of moderate voltage, these voltages might not cause undue stresses, but with a normal voltage of 100,000 such voltage is likely to be destructive.



FIG. 15.  
 Effect of ground in two systems not in parallel.

But grounding a terminal does not always give the same results. A positive "good" ground does not cause the "statics" of an arcing ground. The reason is as follows:



No matter how or where the circuit is made, as long as there is an arc, there is a circuit. Usually this contains resistance, inductive reactance, and condensive reactance.

With a positive ground the impressed frequency is that of the generator. The probability of resonance with the generator frequency is of course very slight, since it would involve a definite relation between the condensive and inductive reactance, but if the ground was made by an arc, independent oscillating circuits can form; in this case there is all probability of excessive rise in voltage, since the circuit will oscillate at such frequency as will give resonance.

If, however, as in lightning arresters, the oscillations are damped out by judicious use of resistance, no dangerous voltages occur, but with accidental slight leaks or grounds it is quite different. The voltages from ground might then be very high. Some protection is gained, of course, by limiting the rise with a grounded neutral.

VOLTAGE RISE DUE TO GROUNDS.

We will consider a general case. A lightning stroke disables some apparatus so that inductive reactance is introduced in the accidental ground. Before the accident we had a perfectly balanced system, where the neutral, or ground potential, is symmetrical in reference to the line conductors and governed entirely by the ground capacities represented in Fig. 16 as three condensers. If, now, one line is grounded through an impedance, the neutral will be displaced along line *AB*.

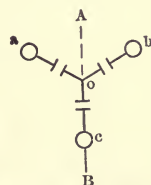

FIG. 16. Balanced three phase system.

For convenience in demonstrating, we can change the diagram to a single phase system, making due

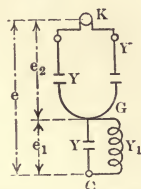

FIG. 17. Effect of a ground.

allowance, however, in the final conclusions — we will reconstruct the system to another shown in Fig. 17. Let  $Y_2$  represent the admittance of each condenser,  $Y_1$  the admittance of the impedance connected to ground, which is electrostatically the same as connecting impedance between the line and the point of normal neutral potential.

We have then the joint admittance between *C* and  $G = Y + Y_1$ ,



therefore the joint impedance  $\frac{1}{Y + Y_1}$ . The joint admittance between  $G$  and  $K$  is  $2Y$ , therefore the corresponding impedance is  $\frac{1}{2Y}$ . The total impedance is, therefore,

$$\frac{1}{Y + Y_1} + \frac{1}{2Y} = \frac{3Y + Y_1}{2Y(Y + Y_1)}.$$

The current is, therefore,  $\frac{2eY(Y + Y_1)}{3Y + Y_1}$ .

$$e_1 = \frac{2eY(Y + Y_1)}{3Y + Y_1} \times \frac{1}{Y + Y_1} = \frac{2eY}{3Y + Y_1}.$$

$$e_2 = \frac{2eY(Y + Y_1)}{3Y + Y_1} \cdot \frac{1}{2Y} = \frac{e(Y + Y_1)}{3Y + Y_1}.$$

$Y = g - jb$  where  $g$  is power component of current.  
 $b$  is wattless component of the admittance in the condenser.

$$Y_1 = \frac{r_1}{Z_1^2} + \frac{jx_1}{Z_1^2}$$

where  $r$  is power component of e.m.f. and  $x$  is wattless component of e.m.f.

We will assume that there is no leakage in the line, therefore,

$$g = 0, \quad \text{and} \quad Y = -jb.$$

We will also assume that there is no resistance, but only reactance in the accidental ground of the line.

$$\text{Thus} \quad r_1 = 0 \quad \text{and} \quad Y_1 = j \frac{1}{x_1}.$$

$$\text{We get then } e_1 = \frac{2be}{3b - \frac{1}{x}} \quad \text{and} \quad e_2 = \frac{\frac{1}{x_1} - b}{\frac{1}{x_1} - 3b} e.$$

If  $x$  is the condensive reactance =  $\frac{\text{e.m.f.}}{\text{charging current}}$

$$\text{and } Y = -j \frac{1}{x} \quad \text{we get } e_1 = \frac{2ex_1}{3x_1 - x} \quad \text{and} \quad e_2 = \frac{x - x_1}{x - 3x_1} e.$$

First. Ground made by infinite reactance. (No ground.)

We have then  $x = \infty$ ,  $e_1 = \frac{2}{3}e$  and  $e_2 = \frac{1}{3}e$ .

Therefore in our diagram the neutral lies at  $O$  (see Fig. 18), and the ground is symmetrical in reference to the three lines.

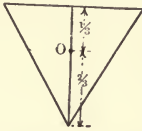

FIG. 18. Balanced condition.

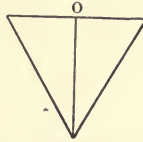

FIG. 19. Unbalanced condition.

Second.  $\frac{1}{x} = b$ , thus  $e_2 = 0$ , and  $e_1 = e$  (shown in Fig. 19).

In this case the neutral lies midway between the two other conductors, and its potential difference to ground is  $.87e$ .

Third. For  $\frac{1}{x_1} = 3b$ ,  $e_1$  and  $e_2$  both become infinite, showing that, under such condition, the system would be subjected to infinite potential.

$b$  is the susceptance of the condenser, therefore  $\frac{1}{b}$  is the condensance or condensive reactance. We see, therefore, if one line is grounded by a reactance of  $\frac{1}{3}$  the condensive reactance, the system is subjected to very great stresses, even at normal frequency.

We might, for instance, in such accident have the line conductors 3 ft. apart and separated by 6 ft. from any wall, and still, upon inspection, find that each line was connected through flames to the wall, but that there was no flame between conductors.

Obviously, if the impedance had been grounded through an arc, high voltages would have resulted, independent of the relation between the capacity and the coefficient of self-induction. The destructive effect of these voltages depends obviously upon the energy stored. The remedy, in that case, would have been to ground the neutral.

**ELECTROSTATIC STRESSES BETWEEN WINDINGS NOT  
ELECTRICALLY CONNECTED INTRODUCED BY  
ACCIDENTAL GROUND.**

As stated above, a ground might well cause serious break-downs by the static effect only. Consider for simplicity's sake

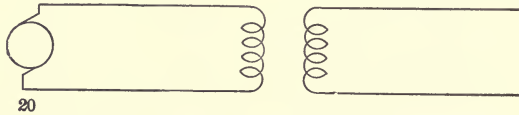

FIG. 20. Generator feeding step-up transformer.

a single phase system, consisting of a generator, a transformer and a line, as shown in Figs. 20 and 21.

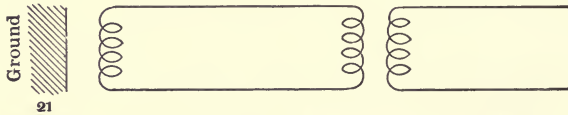

FIG. 21. Capacity effect in generator and transformer.

There is, of course, a certain capacity between primary and secondary of the transformer winding. There is also a certain capacity between generator winding and the frame, which is the ground.

With the two lines symmetrical and well insulated, there is a balanced capacity against ground; and the resultant potential difference between the coils and the ground is zero, thus the high potential coils of the transformer are at ground potential, consequently the low potential coils and the armature windings considering these coils as one plate of a condenser system and the secondary coils and armature as the other plates, these latter obviously are also at ground potential (see Fig. 22).

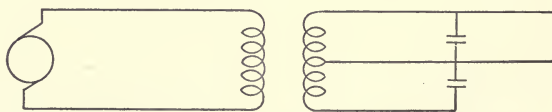

FIG. 22. Balanced capacity.

If now one line becomes grounded, the average potential difference of the coil against the ground is obviously 0.5 of

the line voltage (see Fig. 23). Consequently, the low potential winding acting as the other plate of the condenser, is also charged to a certain potential, the magnitude of which depends upon the relative capacity of the generator winding to ground and the

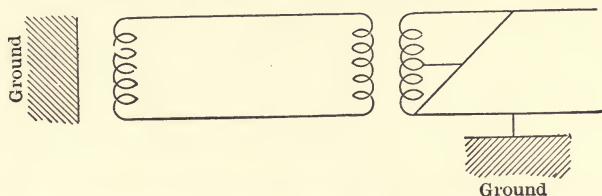

FIG. 23. Static conditions with one high potential line grounded.

capacity between the transformer windings. If they are the same, then 0.5 of the line voltage is divided equally between the primary and secondary of the transformer and the generator winding to ground. The distribution of voltage is inversely proportional to the capacities.

If the capacity between transformer coils is twice that of the generator winding against ground, then the generator winding

will be subjected to  $\frac{2}{3} \times \frac{1}{2}$  or  $\frac{1}{3}$  of the line voltage.

The remedy is a system with grounded neutral.

#### *How to Ground the Neutral.*

Must we ground the neutral perfectly, or can we use resistance or reactance?

Without going further into the question, it is evident from the preceding example, that an inductive reactance in the ground connection is not advisable.

A resistance connected between the neutral point of the Y connection of the transformer and ground is often permissible and advantageous. Under normal conditions there will be very little if any current through this resistance, especially with delta connection on the low potential side of the transformer, which connection forms a path for the triple harmonic exciting current of the transformer. When, however, one line becomes grounded it is evident that the voltage across this resistance will be substantially the Y potential. Therefore, while running

with one line grounded, the high potential lines and apparatus connected thereto are subjected to the same high voltage as it would have in case of the grounded delta system.

Therefore, it would seem feasible to use resistance if there is such a margin on the insulation of the system, including line insulators, that the potential difference against ground at times may be increased 73 per cent. When this is not permissible the neutral must be grounded without resistance, in which case it would be well to have single pole expulsion fuses in the high potential lines, which will disconnect the grounded line before the short circuit has been felt in the system.

It must, of course, be remembered that if it is desired to run with the ground as conductor, should one of the live wires become open circuited, it is obviously necessary to have no resistance in the ground connection.

In connection with these abnormal voltages, although not directly bearing on this subject, it might be of interest to discuss apparent erratic voltages to ground, as are frequently found, when after an accident it is necessary to determine just what took place. When measuring the voltage between any of the terminals and ground, it is observed that it is not definite, but depends essentially upon the resistance in the circuit. This, however, is natural, as can be seen from the following reasoning. (See Fig. 24.)

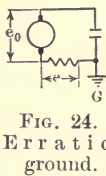

FIG. 24.  
Erratic  
ground.

Let  $e$  be the voltage from terminal to ground, that is the voltage across the resistance.

$e_0$  be the generator voltage per phase.

$x_c$  = condensive reactance of the system.

$r$  = the resistance between the capacity and the terminal.

We have then,

$$\text{current } i = \frac{e_0}{r + jx_c};$$

and voltage across the resistance,

$$e = \frac{e_0 r}{r - jx_c} = \frac{e_0 r}{\sqrt{r^2 + x_c^2}}.$$

With a generator disconnected from any line, the charging current against ground is, of course, very slight, so that  $x$  is very



large; therefore, for moderate values of  $r$  compared with the values of  $x$ , we see that changing the resistance does not materially change the denominator, but the voltage  $e$  is proportional to the resistance; thus there is a constant current effect,—the more resistance is put in circuit, the higher is the voltage. With infinite resistance the voltage is  $\frac{e_0}{\sqrt{3}} = 0.58 e_0$ .

Tabulating the interesting constants of the two transmission lines we get:

	Substation.	
	No. 1.	No. 2.
Kilowatts delivered . . . . .	20,000	30,000
Volts receiving end . . . . .	60,000	60,000
Volts per phase . . . . .	34,700	34,700
Full load current . . . . . amperes	192	288
Number of wires each transmission . . . . .	6	6
Size of each transmission, B. & S. . . . .	000	000
Distance between conductors . . . . . in.	72	72
Distance lowest conductor to ground . . . . . ft.	40	40
Number circuits per transmission . . . . .	2	2
<i>Constants per Circuit.</i>		
Resistance per phase . . . . . ohms	49.4	33
Inductive reactance per phase . . . . . ohms	46	30.6
Inductive reactance per phase to ground . . . . . ohms	69	46
Condensive reactance per phase . . . . . ohms	2,770	4,160
Condensive reactance per phase to ground . . . . . ohms	4,300	6,500
Induction coefficient per phase . . . . . milhenrys	292	194
Induction coefficient per phase to ground, milhenrys	440	293
Capacity per phase . . . . . mf.	2.28	1.52
Capacity per phase against ground . . . . . mf.	1.46	.96
Charging current per phase . . . . . amp.	12.5	8.35
<i>Constants per transmission.</i>		
Resistance per phase . . . . . ohms	24.7	16.5
Inductive reactance per phase . . . . . ohms	23	15.3
Inductive reactance per phase to ground . . . . . ohms	34.5	23
Condensive reactance per phase . . . . . ohms	1,385	2,080
Condensive reactance per phase to ground . . . . . ohms	2,150	3,250
Induction coefficient per phase . . . . . milhenrys	146	97.2
Induction coefficient per phase to ground, milhenrys	220	146
Capacity per phase . . . . . mf.	4.56	3.04
Capacity per phase against ground . . . . . mf.	2.92	1.92
Charging current per phase . . . . . amperes	25	16.7
Per cent resistance per phase . . . . .	13.7	13.7
Per cent inductive reactance per phase . . . . .	12.7	12.7
Per cent inductive reactance per phase to ground . . . . .	19	19
Per cent charging current per phase . . . . .	13	5.8
Per cent condensive reactance per phase . . . . .	770	1,720
Per cent condensive reactance per phase to ground . . . . .	1,190	2,700

## CABLES.

In order to introduce some cable problems it shall be assumed that the entire power has to be brought to a city which does not permit of overhead high potential lines, and that the length of the cable or cables is two miles.

With the present state of the art it would not be conservative to use a cable at more than, say, 25,000 volts between lines, although it is to be expected, that at least with rubber-covered cables, or cables with insulation of varying specific inductive capacity, a much higher voltage can finally be used.

At the present time essentially, or almost entirely, two kinds of cables are used, one having paper insulation and the other rubber insulation, both being covered by lead.

Although the dielectric strength of paper is considerably less than that of rubber, and, therefore, more insulation is needed, due to the lesser cost, it is almost entirely used, and no doubt will remain so until cables for higher voltages are required.

The stresses on the insulation of cables were fully dealt with when discussing corona effects in lines, so that the equations and tables are omitted here.

*Rating.*

It is almost impossible to give a general rule for the safe current capacity of a cable, since it depends largely upon what kind of conduit is used, the relative amount of insulation, etc. Perhaps 0.025 watt per sq. in. radiating surface (outside) is as fair an approximation as can be made.

When, however, the cable is laid directly in soil, 50 per cent more current can be carried; and when placed in water, 100 per cent seems safe.

This last case corresponds to 0.1 watt per sq. in. radiating surface. The actual rise in temperature of the conductor is in each case about 30° C.

*Skin Effect.*

On account of the skin effect, there is, however, a limit in size of the conductor.

The theoretical equations for this phenomenon are extremely complicated, however, and therefore no endeavor is made to give them here.

Allowing the same skin effect a slightly larger cable than solid conductor can be used. The gain by the use of cable is, however, not great, since the individual strands are not interlaced, but remain at all times at the same distance from the center.

Steinmetz has proven that the relative current density at the center of any conductor can be expressed by the following equation:

$$B = \frac{1}{\sqrt{1 + \left(\frac{k}{\delta}\right)^2}},$$

where  $\frac{k}{\delta} = 0.0135 D^2 N$  for copper,

and  $\left(\frac{k}{\delta}\right) = 0.008 D^2 N$  for aluminium

where  $D$  is the diam. and  $N$  the frequency for aluminium.

The inverse value or  $\sqrt{1 + \left(\frac{k}{\delta}\right)^2}$  represents approximately the relative resistance of the center core of the wire and the periphery.

The current distribution in the wire is very difficult to determine, but it is evident that the change is not gradual from center to periphery; the greatest change occurs in reasonable size of conductors near to the center, therefore a fair approximation of the coefficient of skin effect would be

$$c = \frac{1 + \sqrt{1 + \left(\frac{k}{\delta}\right)^2}}{2}.$$

Comparing aluminium conductors with copper conductors, we get for the same percentage of skin effect,

$$\frac{1 + \sqrt{1 + (.008 ND_1^2)^2}}{2} = \frac{1 + \sqrt{1 + (.0135 ND^2)^2}}{2},$$

or  $0.000064 D_1^4 = 0.000183 D^4,$

or  $D_1^4 = 2.85 D^4,$

or  $D_1 = 1.3 D,$

where  $D$  is the diam. of the copper conductor,

where  $D$  is the diam. of the aluminium conductor.

The aluminium conductor can be 30 per cent greater than the copper conductor.

The relation between the resistance of a solid conductor and a cable depends upon the ratio of the metallic section and the whole section, including the air space. It also depends to a small extent upon the increased length due to the twist. This ratio is therefore variable but can be approximated as  $\frac{.785}{1}$ . Thus the formula becomes :

$$\text{For copper cable, } \left(\frac{k}{\delta}\right) = 0.0105 D^2 N,$$

$$\text{and for aluminium cable, } \left(\frac{k}{\delta}\right) = 0.0063 D^2 N.$$

Thus for the same per cent increase, due to skin effect, the cable can have 13 per cent larger diameter than the solid wire; in other words, the skin effect is the same as long as the ohmic resistance is the same, whether we use solid conductor or ordinary cable.

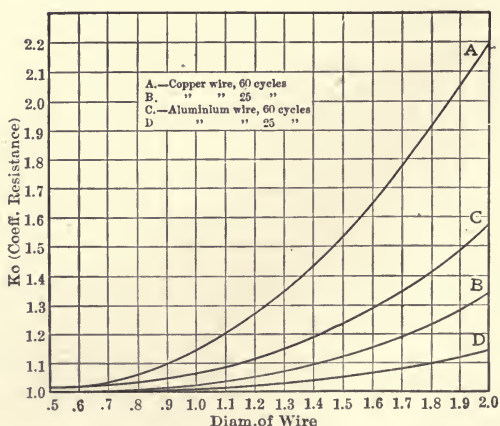

FIG. 25. Resistance coefficients.

Fig. 25 gives the results of these calculations. It should, however, be remembered that these values may be slightly large.



In the line constant determinations are shown the equations for the coefficient of self-induction and capacity for parallel conductors. Since concentric cables sometimes are used, the corresponding equations for such cables are added.



FIG. 26.  
Inductance and capacity in concentric conductors.

$$L_m = \frac{370}{10^3} \log_{10} \frac{D}{d} \text{ (in tubular conductors),}$$

$$L_m = \frac{370}{10^3} \left( \log_{10} \frac{D}{d} + \frac{1}{2} \right) \text{ if the inside conductor is solid,}$$

$$C_m = \frac{770 k}{10^4 \log_{10} \frac{D}{d}}.$$

In these equations  $L_m$  and  $C_m$  are respectively the induction coefficient in milhenrys and the capacity in microfarads per mile of conductor, thus in a cable as shown in 0.5 mile of length or in a three phase cable 1 mile of length.

The equations for the coefficient of self-induction and capacity apply directly as long as all conductors belonging to the same circuit are in the same conduit or cable. If, however, that is not the case, but as in a single conductor cable independent cables are used for the outgoing and incoming conductors, "effective" values have to be calculated.

#### *Effect of Grounded Lead Covering of Single Conductor Cables.*

The lead covering obviously acts as a short-circuited secondary to the e.m.f. generated by the inductive reactance of the line. It consumes therefore some of the e.m.f. and reduces the inductive drop, but increases the ohmic loss due to the currents in the lead.

In calculating the phenomenon there will be substituted for the line, the primary of a transformer of same resistance as the line having a magnetizing current the same as the line current at the voltage corresponding to the reactance e.m.f.

The inductive reactance of the primary in this equivalent transformer is caused by the flux between lead covering and the conductor, and is therefore, as a rule, quite small.



The secondary resistance corresponds to the resistance of the lead (which for given cross section is fourteen times that of copper); the reactance is zero since the conductor is tubular. We can therefore diagrammatically show these circuits as in Fig. 27.



FIG. 27. Single conductor grounded lead covered cable.

The lead covering being grounded becomes a closed secondary.

Or, as in Fig. 28, where the line resistance and inductive reactance are considered as being those of a transformer.

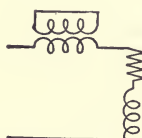

FIG. 28. Single conductor lead covered cable represented as transformer.

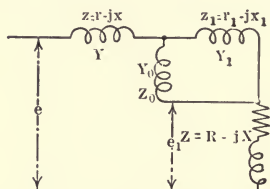

FIG. 29. Lead cable represented as inductive circuit.

Or finally, as in Fig. 29, as a combination of inductive circuits with the proper transformer constants.

Let  $e$  = line voltage,

$Z = R - jX$  = load impedance,

$z = r - jx$  = primary impedance,

where  $r$  = line resistance,

$x$  = inductive reactance between conductor and lead,

$z_1 = r_1 - jx_1$  = secondary impedance,

where  $r_1$  = resistance of lead covering. (For the same cross section fourteen times that of copper.)

$Y_0$  = primary admittance =  $j\bar{b}$ , where

$$b = \frac{1}{x_0}, \text{ or } Y_0 = \frac{j}{x_0}.$$

$x_0$  = line inductive reactance if no lead covering existed and a conductor of the same outside diameter as that of the lead covering was used in the calculations.

$$z_0 = \frac{1}{Y_0} = -\frac{j}{b} = -jx_0.$$

Joint admittance of the two parallel circuits of impedance  $z_0$  and  $z_1$  is  $Y_0 + Y_1 = Y_2$ . The corresponding impedance  $z_2 =$

$$\frac{1}{Y_0 + Y_1} = \frac{1}{\frac{j}{x_0} + \frac{1}{r_1}} \text{ since } x_1 \text{ is small.}$$

We have 
$$z_2 = \frac{r_1 x_0}{jr_1 + x_0} = \frac{r_1 x_0 (x_0 - jr_1)}{r_1^2 + x_0^2}.$$

Total impedance  $= z_2 + z + Z.$

Current therefore  $= \frac{e}{z_2 + z + Z}.$

Voltage across load  $e_1 = \frac{eZ}{z_2 + z + Z}.$

$E_1' =$  drop in line  $e - \frac{eZ}{z_2 + z + Z} = \frac{e(z + z_2)}{Z + z + z_2}.$

Let  $z + z_2 = z_3.$

We have then 
$$E_1' = \frac{ez_3}{Z + z_3} \dots \dots \dots C$$

In an ordinary line we have

current  $= \frac{e}{Z + z_4}.$  Drop in line  $E_1' = \frac{ez_4}{Z + z_4} \dots \dots \dots D$

Comparing these two equations A and B, we see, that if the values of line impedance obtained by writing  $z_4 = z_3$  are inserted we can use the ordinary line equations

$$Z_4 = r_4 - jx_4.$$

From above we have

$$Z_4 = z_3 = z + z_2 = r + \frac{r_1 x_0^2}{r_1^2 + x_0^2} - j \left( x + \frac{r_1^2 x_0}{r_1^2 + x_0^2} \right).$$

Therefore the effective resistance is:

$$r + \frac{r_1 x_0^2}{r_1^2 + x_0^2},$$

and neglecting  $x$  which is small

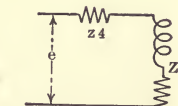

FIG. 30. Ordinary transmission.

$$\text{the effective reactance} = \frac{r_1^2 x_0}{r_1^2 + x_0^2}.$$

As a rule,  $x_0$  is small compared with  $r_1$ , and we can write,

$$\text{effective resistance} = r + \frac{x_0^2}{r_1}$$

$$\text{effective reactance} = x_0.$$

When estimating the reactance and effective resistance of a grounded single conductor lead covered cable, calculate the ohmic resistance  $r$  of the conductor, the ohmic resistance  $r_1$  of the lead covering (specific resistance fourteen times that of copper), determine the reactance  $x_0$  as between two parallel conductors of same diameter as the outside diameter of the lead, and substitute the values so obtained in the equations given above.

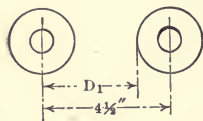

FIG. 31. Single conductor lead covered cable.

*Example* (Fig. 31). Two cables of 1000 ft. total length placed with their centers 4.5 in. apart; each cable contains a No. 0000 B. & S. conductor. Outside diameter of lead 1 in., inside diameter 0.75 in. What is the effective resistance and inductive reactance of 25 and 60 cycles?

$$r = 0.049,$$

area of lead

$$\frac{1}{8} \pi \frac{7}{8} = 0.343 \text{ sq. in.}$$

corresponding to copper section

$$= \frac{0.343}{14} = 0.0245 \text{ sq. in.}$$

for the same conductivity.

Therefore

$$r_1 = 0.332.$$

At 25 cycles inductive reactance outside of lead is

$$\frac{2 \pi 25}{10^3} \times \frac{161}{10^3} \left( 2 \log_e \frac{8}{1} + \frac{1}{2} \right) \frac{1}{5.28} = 0.0223 \text{ ohms.}$$

Therefore effective resistance

$$= 0.049 + \frac{0.0223^2}{0.332} = 0.0505 \text{ ohms.}$$

At 60 cycles the inductive reactance is 0.0535 ohms.

Therefore effective resistance = 0.0572 ohms.

The resistance is increased 3 per cent in the first case, 16 per cent in the latter.

To illustrate the increased loss in a single conductor lead covered cable, the table given below has been prepared. It applies to a single conductor cable No. 0000 B. & S. having a lead covering  $\frac{1}{8}$  in. thick; the outside diameter of the lead covering is 1 in. Losses are given for various distances to return conductor and at various frequencies.

It shows, that in general the losses introduced are small and need only be considered in 60-cycle systems, when the cables are considerable distance apart. This table refers to one mile of conductor.

#### 12.5 CYCLES PER SECOND.

Distance inches	2.13	4	12	24
$r$	.264	.264	.264	.264
$x_0 = x_e$	.0249	.0458	.0772	.0952
$x_0^2$	.0006	.0021	.0059	.009
$r_e = \text{effective resistance}$	.2642	.2649	.2665	.2678
Increase in resistance	.1%	.34%	.98%	1.4%

#### 25 CYCLES PER SECOND.

Distance inches	2.13	4	12	24
$r$	.264	.264	.264	.264
$x_0 = x_e$	.0497	.0916	.1544	.1904
$x_0^2$	.0025	.0084	.0238	.0362
$r$	.2651	.2676	.2743	.2796
Increase	.42%	1.37%	3.9%	5.9%

#### 60 CYCLES PER SECOND.

Distance inches	2.13	4	12	24
$r$	.264	.264	.264	.264
$x_0 = x_e$	.1193	.220	.3706	.4570
$x_0^2$	.0142	.048	.137	.208
$r_e$	.2701	.2848	.3233	.3536
Increase	2.3%	7.9%	22.5%	33.9%

#### *Effect of an Ungrounded Lead Covering in Single Conductor Lead Cable.*

Since there is a difference in flux between the inside and the outside half of the lead covering, counting from the

center line of the loop, currents alongside the covering must be in one direction in the inside half, in the other direction in the outside half.

The average distance between center of one conductor and the nearer half of the lead covering of the other conductor is

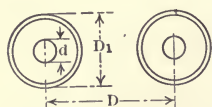

FIG. 32. Lead covered not grounded single conductor cable.

$$D - \frac{D_1}{4}$$

The average distance to the outer half is

$$D + \frac{D_1}{4}$$

The difference in inductance is therefore

$$\begin{aligned} l_d &= \frac{742}{10^3} \left( \log_{10} \frac{D + \frac{D_1}{4}}{d} - \log_{10} \frac{D - \frac{D_1}{4}}{d} \right) \\ &= \frac{742}{10^3} \log_{10} \frac{D + \frac{D_1}{4}}{D - \frac{D_1}{4}} \end{aligned}$$

where  $l_d$  is expressed in milhenrys per mile of conductor.

With  $I$  current in the conductor and the resistance of the lead covering calculated as above, we get:

$$\text{Reactance e.m.f} = \frac{2 \pi f l_d I}{10^3}$$

$$\text{and eddy currents in lead} = \frac{2 \pi f l_d I}{4 r_1 10^3}$$

$$\text{Thus the loss in the lead} = \frac{4 \pi^2 f^2 l_d^2 I^2}{4 r_1 10^6}$$

$$\text{Therefore the effective resistance} = r + \frac{f^2 l_d^2}{r_1 10^5}$$

where

$f$  = frequency,

$l_d$  = induction coefficient in milhenrys,

$r_1$  = lead resistance — as defined above,

$r$  = resistance of conductor proper.



With 4 in. distance between centers and one-inch diameter over lead covering we get:

$$D + \frac{D_1}{4} = 4.25,$$

$$D - \frac{D_1}{4} = 3.75,$$

$$l_d = \frac{742}{10^3} \log_{10} 1.13 = \frac{40}{10^3} \text{ milhenry.}$$

Therefore effective resistance

$$= 0.049 + \frac{25^2 \times 40^2}{0.33 \times 10^6 \times 10^5} = .04903 \text{ ohms.}$$

We see from this, that the eddies in a single conductor lead covered cable are negligible, if the lead is not grounded.

#### *Effect of Iron Armored Single Conductor Cable.*

If the cable instead of being covered by lead was covered by a magnetic material such as iron, the problem is more complicated on account of the increased flux due to the iron. Such conduit is indeed quite out of the question on account of the increased reactance and eddy current losses.

From the saturation curve of the iron it is possible to determine the magnetic density, and therefrom the flux in the iron for a given current in the conductor.

Assume this flux to be  $\phi$ .

$E$ , the e.m.f. corresponding to this flux, is

$$\frac{4.44 \times \phi \times f}{10^8}$$

The corresponding inductive reactance is  $\frac{E}{I}$ , which reactance should be added to the normal reactance as obtained in a non-ferric system.

The hysteresis loss corresponding to this density is found from the hysteresis curves of the iron, and this loss divided by  $I^2$  gives an equivalent resistance which should be added to the resistance as obtained in case of a non-ferric conduit.

As an example: Assume the cable described above covered by iron instead of lead, and that there are 150 amp. in the main conductor.

Assume further that the iron is  $\frac{1}{8}$  in. thick and that the total loss due to eddies and hysteresis is five times as great as the hysteresis loss alone.

The m.m.f. available is  $150\sqrt{2} = 212$  amp. turns.

The magnetic length is  $\frac{7}{8}\pi = 2.75$  in.

m.m.f. per inch  $= \frac{212}{2.75} = 77$ .

This corresponds to a density (from saturation curve) of 100,000 lines per sq. in.

The magnetic cross section =  $1000 \times 12 \times \frac{1}{8} = 1500$  sq. in.

Therefore the total flux  $\phi = 150,000,000$  and  $E = 166$  volts;

the reactance due to iron is thus  $\frac{166}{150} = 1.1$  ohm.

From a standard hysteresis curve we find the loss per cubic inch per cycle (at a density of 100,000) as 0.028 watt.

Therefore the loss is

$$.028 \times 5 \times 1500 \times \frac{7}{8} \times \pi \times 25 = 14,500 \text{ watts.}$$

Whereas the  $I^2R$  proper is but  $150^2 \times 0.049 = 1100$  watts.

It can readily be proven, that even the thinnest iron covering is prohibitive in single conductor cables for alternating currents.

In concluding the discussion of the effect of armor we may add, that where two or more conductors constituting a complete circuit are carried in the same conduit, it matters little whether the covering is of iron or lead, grounded or not grounded. The effect of the covering on the resistance or the reactance is negligible.

We will now return to the problem of carrying the entire power of 20,000 kw. two miles through cables at 25,000 volts, and assume that the neutral is grounded, therefore the maximum voltage between any conductor and the lead covering is

is  $\frac{25,000}{\sqrt{3}} = 14,400$  volts. We will also assume the use of

cables containing three No. 000 B. & S. conductors and such insulation as stands as a maximum 250,000 volts per inch. Furthermore, that the safety factor shall be 2. Referring to

the discussion on corona effects, we find the potential gradient at the surface of the conductor as

$$e = \frac{E}{r \log_e \frac{R}{r}}$$

which can be solved for  $R$  as follows:

$$\log_{10} R = \frac{0.434 \times 14,400}{125,000 \times 0.205} + \log_{10} 0.205,$$

or

$$R = 0.36 \text{ in.}$$

Therefore the insulation to the lead would be

$$0.36 - 0.205 = 0.155 \text{ in.}$$

When considering parallel conductors  $R$  represents one half the distance between conductors. Thus in this case the distance is 0.72 in., and the thickness of insulation between conductors is  $0.72 - 0.41 = 0.31$  in., or twice as great as to the lead.

We get, therefore, an approximate outside diameter of the lead covering of about 2 in. diameter. Two miles of cable has, therefore, a radiating surface of

$$2 \times 5280 \times 12 \times \pi \times 2 = 790,000 \text{ sq. in.}$$

Therefore permissible watts loss per conductor

$$= \frac{.025 \times 790,000}{3} = 6650 \text{ watts.}$$

Full load current is 460 amp.

Resistance of No. 000 for 2 miles = 0.66 ohm.

$$I^2 \times 0.66 = 6650 \text{ watts,} \quad I = 100 \text{ amp.,}$$

which is the amount that can be carried in each of the conductors — provided No. 000 conductor is used. Therefore we would need four or five such cables in multiple.

#### *Iron Wire and Cables Used as Electrical Conductors.*

Since the ohmic resistance and permeability of iron changes very considerably with different grades, and since the permeability varies with the flux density, it is evident that it is very

difficult to lay down any definite rules regarding the effective resistance and reactance. So that, in order to get accurate determinations, it is necessary to test samples of the conductor intended to be used.

With a high price of copper wire, it is evident, however, that wherever small power is carried relatively short distances at high voltages, iron wire, or at least iron cables, could be used, and calculations must be made before the wire has been secured.

With direct current the matter is fairly simple, since the permeability does not enter, and wires of definite resistance could be ordered. This resistance in iron wire varies from, say, four times to seven or eight times that of copper.

With alternating current the skin effect causes additional resistance, which, in large conductors, is considerable, often several times that of the true ohmic resistance. This effect is, however, small in small wires, say wires of No. 8 to 12 B. & S. gauge. Such small wires can, however, not well be used for transmission lines for mechanical reasons. Therefore, it seems evident that stranded cables only need to be considered.

From a number of tests and calculations it would seem as if the effective resistance of such stranded cable (7-strand cable) could be expressed by the following formula:

$$R = r + \frac{Kf^2D^2}{r 10^5},$$

in which  $K$  depends upon the permeability and average 2.

$R$  = effective resistance per mile of cable.

$r$  = ohmic resistance.

$f$  = frequency.

$i$  = current density in amperes per square inch of circumscribed circle.

$D$  = external diameter of the cable.

The inductive reactance can be approximated as:

$$X = x + 0.01f + \frac{Kf^2D^2}{rx 10^5}.$$

where  $X$  = effective reactance per mile of wire.

$x$  = reactance as obtained if the cable were made of copper.



These formulas apply fairly well at least to cables of from 0.25 in. to 0.5 in. external diameter. It is unlikely that larger cables will be used, since the skin effect is very considerable with 0.5 in. cables, and it is also unlikely that smaller cables will be used, on account of mechanical reasons.

It is to be noted, in connection with these formulas that it is not the reactance that prohibits the use of iron cables as is usually held — the effective resistance is of more importance.

When using very large iron or steel conductors, such as rails in the case of single phase railroading, the effective resistance can be estimated from the degree of penetration or current, and this has been approximated by Steinmetz and others to be

$$\delta = \frac{2000}{\sqrt{\lambda \mu f}}$$

where  $\delta$ , the penetration, is expressed in inches;

$\lambda$  = electrical conductivity, which with soft iron is about 110,000;

$\mu$  is the permeability, which may approach 500; and

$f$  is the frequency.

Consequently, the resistance of such large iron and steel conductors does not depend upon the actual cross section, but upon the perimeter. It is furthermore proportional to the square root of the frequency.

#### TELEPHONE LINES.

To obtain satisfactory service it is of first importance that telephone communication shall be possible under all conditions, and that the installation shall be such as to exclude all personal danger to the operators.

The most reliable and safest way to accomplish this is to use an independent pole line run a considerable distance away from the main line.

The electrostatic and inductive effects are then a minimum, and there need be no possibility of mechanical contact between the high potential lines and the telephone lines. This is, however, seldom possible on account of the cost.

The important problem is then how to arrange a telephone line on the pole line proper,



## A. Inductive Effects.

Let in Fig. 33  $A, B, C$ , represent the main line conductors;  $D$  and  $E$  the telephone conductors. Let  $d$  be the diameter of the main conductors. The difference in flux inclosed between any of the main conductors and the telephone conductors is practically independent of the diameter of the latter. We can, therefore, assume that the telephone conductors have the same diameter as the main conductors =  $d$ .

Let  $a_1$  be the distance between  $A$  and  $D$ .  
 $a_2$  be the distance between  $A$  and  $E$ .  
 $b_1$  be the distance between  $B$  and  $D$ .  
 $b_2$  be the distance between  $B$  and  $E$ .  
 $c_1$  be the distance between  $C$  and  $D$ .  
 $c_2$  be the distance between  $C$  and  $E$ .

We have then the coefficient of self-induction per mile (in milhenrys) between  $D$  and  $E$  caused by the current in  $A$ .

$$\begin{aligned} L_a &= \frac{161}{10^3} \left( 2 \log_{\epsilon} \frac{2 a_2}{d} - 2 \log_{\epsilon} \frac{2 a_1}{d} \right) \\ &= \frac{322}{10^3} \log_{\epsilon} \frac{\frac{2 a_2}{d}}{\frac{2 a_1}{d}} = \frac{322}{10^3} \log_{\epsilon} \frac{a_2}{a_1}. \end{aligned}$$

In a similar way we get the induction coefficient caused by  $B$ ,

$$L_b = \frac{322}{10^3} \log_{\epsilon} \frac{b_2}{b_1},$$

and that caused by  $C$ ,

$$L_c = \frac{322}{10^3} \log_{\epsilon} \frac{c_2}{c_1}.$$

These three induction coefficients are displaced  $120^\circ$  in phase; their resultant is, therefore,

$$L_r = \sqrt{\left[ L_b - \frac{1}{2}(L_a + L_c) \right]^2 + 0.75 (L_a - L_c)^2}.$$

The reactance is, therefore,  $\frac{2 \pi L_r}{10^3}$ .

and the induced e.m.f. in the telephone line is  $\frac{2\pi f}{10^3} L_r \times I$ ,

where  $I$  is the current in each main line conductor.

*Example a* (no transposition and no ground).

$$a_1 = 10.5 \text{ ft.} = 126 \text{ in.}$$

$$a_2 = 12.5 \text{ ft.} = 150 \text{ in.}$$

$$b_1 = 16.0 \text{ ft.} = 192 \text{ in.}$$

$$b_2 = 18.0 \text{ ft.} = 216 \text{ in.}$$

$$c_1 = 10.5 \text{ ft.} = 126 \text{ in.}$$

$$c_2 = 12.5 \text{ ft.} = 150 \text{ in.}$$

$$L_a = \frac{322}{10^3} \frac{\log_{10} \frac{150}{126}}{0.434} = 0.056.$$

$$L_c = \frac{322}{10^3} \frac{\log_{10} \frac{150}{126}}{0.434} = 0.056.$$

$$L_b = \frac{322}{10^3} \frac{\log_{10} \frac{216}{192}}{0.434} = 0.0378.$$

$$L_r = \sqrt{(0.0378 - 0.056)^2} = 0.0182.$$

If the transmission line is 150 miles long, operates at 25 cycles, and carries 96 amperes, we get:

The induced e.m.f.

$$= 2\pi \frac{25 \times .0182}{10^3} \times 96 = 0.274 \text{ volt per mile,}$$

or

$$150 \times 0.274 = 41.2 \text{ volts.}$$

It is evident from the above, that the induced e.m.f. depends largely upon the actual position of the two telephone lines in reference to the power lines.

It is an advantage to have the plane of the two telephone lines parallel to ground, since then the difference of the two distances between any main line conductor and the telephone conductors is a minimum. It is usually undesirable to have the plane of the telephone line at right angle to the ground. Furthermore, the longer the distance between the telephone lines the larger is the inductance.

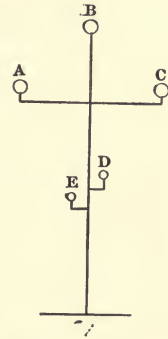

FIG. 33. A, B and C main line conductors, D and E telephone conductors. No ground.

Thus, the worse condition is to have one telephone conductor only and to use the ground as return, since this condition introduces both undesirable features.

The induced e.m.f. is, as seen, proportional to the current; thus if the inductive effect is prominent the difficulties in communicating should increase with the current and be specially objectionable with rapidly changing values. Transposing the three wires will overcome this trouble.

When ground is used as the return conductor there is, of course, no possibility of transposing the wires.

*Example b.* Three insulated power wires, telephone line strung on the same pole line but having one metallic conductor only, the other conductor being ground. The mutual induction in milhenrys per mile of transmission between  $D$  and ground due to unit current in  $A$ .

$$\begin{aligned} L_a &= \frac{322}{10^3} \times \log_e \frac{4 a_2}{d} - \frac{322}{10^3} \log_e \frac{2 a_1}{d} \\ &= \frac{322}{10^3} \left( \log_e \frac{4 a_2}{d} - \log_e \frac{2 a_1}{d} \right) \\ &= \frac{322}{10^3} \log_e \frac{2 a_2}{a_1}. \end{aligned}$$

In a similar way,

$$L_b = \frac{322}{10^3} \log_e \frac{2 b_2}{b_1}$$

and

$$L_c = \frac{322}{10^3} \log_e \frac{2 c_2}{c_1}.$$

The resultant is

$$L_r = \sqrt{[L_b - \frac{1}{2}(L_a + L_c)]^2 + 0.75(L_a - L_c)^2}.$$

$$a_1 = 10.5 \text{ ft.} = 126 \text{ in.}$$

$$a_2 = 30.0 \text{ ft.} = 360 \text{ in.}$$

$$b_1 = 16.0 \text{ ft.} = 192 \text{ in.}$$

$$b_2 = 36.0 \text{ ft.} = 432 \text{ in.}$$

$$c_1 = 10.5 \text{ ft.} = 126 \text{ in.}$$

$$c_2 = 30.0 \text{ ft.} = 360 \text{ in.}$$

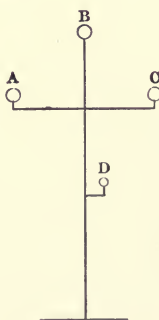

FIG. 34 Ground used as one telephone conductor.

Substituting in the above equation we get

$$L_a = \frac{322}{10^3} \frac{\log_{10} \frac{720}{126}}{0.434} = 0.561,$$

$$L_c = \frac{322}{10^3} \frac{\log_{10} \frac{720}{126}}{0.434} = 0.561,$$

$$L_b = \frac{322}{10^3} \frac{\log_{10} \frac{864}{192}}{0.434} = 0.484,$$

and

$$L_r = 0.07.$$

In the transmission discussed in the last example, the induced voltage would therefore be 174 volts. Obviously if the transmission lines had been properly transposed this voltage would not have existed.

With one transmission line accidentally grounded but the other two perfectly insulated, there should be no change in the inductive effect since the currents and their phase relation are not disturbed (neglecting the charging current).

If, however, the ground is used as one of the main conductors (as will be the case when operating with a grounded Y-system and one of the main lines is accidentally cut out) difficulties arise. The circuits are then illustrated in Fig. 35 where conductor *B* is assumed as ground.

The telephone lines are between the main lines, and the flux caused by *B* is combined with the other fluxes in opposite direction, thus the resultant

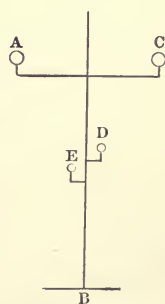

FIG. 35. Ground used as one main conductor.

$$L_r \text{ is } \sqrt{[L_b + \frac{1}{2}(L_a + L_c)]^2 + 0.75(L_a - L_c)^2}.$$

In this case transposition does not help matters, since one wire — the ground — is not transposed.

Under this condition the expressions for  $L_a$ ,  $L_b$  and  $L_c$  are respectively

$$L_a = \frac{322}{10^3} \log_e \frac{a_2}{a_1},$$

$$L_c = \frac{322}{10^3} \log_e \frac{c_2}{c_1}$$

and

$$\begin{aligned} L_b &= \frac{322}{10^3} \left( \log_e \frac{4 b_1}{d} - \log_e \frac{4 b_2}{d} \right) \\ &= \frac{322}{10^3} \log_e \frac{b_1}{b_2}. \end{aligned}$$

*Example c.* Ground used as main line conductor *B*. The telephone lines are not grounded. We have then,

$$\begin{aligned} a_1 &= 126 \text{ in.} \\ a_2 &= 150 \text{ in.} \\ c_1 &= 126 \text{ in.} \\ c_2 &= 150 \text{ in.} \\ b_1 &= 240 \text{ in.} \\ b_2 &= 216 \text{ in.} \end{aligned}$$

We have then,

$$L_a = \frac{322}{10^3} \frac{\log_{10} \frac{150}{126}}{0.434} = 0.056,$$

$$L_c = \frac{322}{10^3} \frac{\log_{10} \frac{150}{126}}{0.434} = 0.056,$$

$$L_b = \frac{322}{10^3} \frac{\log_{10} \frac{240}{216}}{0.434} = 0.0339,$$

and

$$L_r = 0.0899.$$

And for the transmission given in previous example the voltage induced in the telephone line would be about 200 volts.

If the telephone circuit had only one single conductor and the earth was used for return for one of the main conductors we would have the following. A three phase transmission line using two metallic conductors only and the ground as the third and a single metallic conductor telephone line with ground return — what would be the induced voltage?



We have:

$$L_a = \frac{322}{10^3} \log_{\epsilon} \frac{2 a_2}{a_1},$$

$$L_c = \frac{322}{10^3} \log_{\epsilon} \frac{2 c_2}{c_1},$$

$$L_b = \frac{322}{10^3} \log_{\epsilon} \frac{4 b_1}{d} = 0,$$

where

$$4 b_1 = d,$$

which is the case, since  $d$  is the diameter of the "ground," which is very large compared with any of the other distances. Applying these equations to the same practical example we get:

$$a_1 = 126 \text{ in.}$$

$$a_2 = 360 \text{ in.}$$

$$c_1 = 126 \text{ in.}$$

$$c_2 = 360 \text{ in.}$$

and

$$L_a = \frac{322}{10^3} \frac{\log_{10} \frac{720}{126}}{0.434} = 0.5615,$$

$$L_c = \frac{322}{10^3} \frac{\log_{10} \frac{720}{126}}{0.434} = 0.5615,$$

and

$$L_r = 0.56,$$

which gives an induced voltage of 1268 volts.

This condition is, therefore, the worst, and no transposing will help matters. Usually the resistance drop of main circuit of the ground return is so high as to be the predominant factor, and is sufficient to make the single conductor telephone line impractical.

### B. Electrostatic Effects.

In connection with the discussion of corona effect it was shown that the potential  $E_x$  from ground as zero at a given

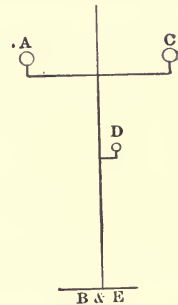

FIG. 36. Ground used as one main and one telephone conductor

distance from a conductor at potential  $E$  could be expressed as

$$E_x = E \frac{\log_{10} \frac{L}{x}}{\log_{10} \frac{R}{r}}$$

where  $L$  is the distance from the conductor to ground potential,  
 $r$  is the radius of the conductor,  
 $E$  is the potential difference to ground,  
 $E_x$  is the potential to ground at a distance  $x$  from the conductor.

Referring now to Fig. 33, using the same denotations as previously, and denoting the distance of the three wires to ground as  $L_a, L_b, L_c$ , respectively, we get then for telephone conductor  $D$ ,

$$\text{Voltage due to } A = E \frac{\log_n \frac{L_a'}{a_1}}{\log_n \frac{L_a}{r}} = E_a,$$

$$\text{Voltage due to } B = E \frac{\log_n \frac{L_b}{b_1}}{\log_n \frac{L_b}{r}} = E_b,$$

$$\text{Voltage due to } C = E \frac{\log_n \frac{L_c}{c_1}}{\log_n \frac{L_c}{r}} = E_c.$$

Again, these voltages are 120 degrees apart, thus the resultant voltage above ground for  $D$ ,

$$E_D = \sqrt{(E_b - 0.5(E_a + E_c))^2 + 0.75(E_a - E_c)^2}.$$

In a similar manner the resultant voltage from ground of line  $E$  is found by substituting  $a_2, b_2, c_2$  instead of  $a_1, b_1, c_1$ .

It is evident from this, that static voltage is much dependent upon the size of the main conductors; the larger the wire, the higher the charge on the telephone wires.

*Example e.* Transmission lines not grounded; metallic telephone circuit, and voltage between the lines 60,000. Size of line conductor No. 000 B. & S.

$$d = 0.41.$$

We have then,

$$E_a = \frac{60,000}{\sqrt{3}} \frac{\log \frac{360}{125}}{\log \frac{360}{0.205}} = 4910,$$

$$E_c = \frac{60,000}{\sqrt{3}} \frac{\log \frac{360}{125}}{\log \frac{360}{0.205}} = 4910,$$

$$E_b = \frac{60,000}{\sqrt{3}} \frac{\log \frac{432}{192}}{\log \frac{432}{0.205}} = 3670.$$

Therefore,

$$E_D = \sqrt{(3670 - 4910)^2} = 1240 \text{ volts.}$$

The voltage induced statically on  $E$  is found in a similar way.

$$E_a = \frac{60,000}{\sqrt{3}} \frac{\log \frac{360}{150}}{\log \frac{360}{0.205}} = 4058,$$

$$E_c = \frac{60,000}{\sqrt{3}} \frac{\log \frac{360}{150}}{\log \frac{360}{0.205}} = 4058,$$

and

$$E_b = \frac{60,000}{\sqrt{3}} \frac{\log \frac{432}{216}}{\log \frac{432}{0.205}} = 3138,$$

and

$$E_D = 920 \text{ volts.}$$

Now assume that the telephone circuit has one metallic conductor and that the ground is used as the return conductor as in example *b* in the previous discussion.

It is evident then that the potential on the metallic conductor is not changed, but the other (the ground) becomes zero or ground potential.

Assume next, as in previous example, *c*, that the telephone circuit consists of two metallic conductors, but that one of the main power lines, *B*, is grounded.

$E_a$  and  $E_c$  are  $\sqrt{3}$  times the values given in example *e*, since the voltage between ground *A* and *B* is now the full line voltage. The voltage due to *B* is, of course, zero, since *B* is at zero potential. We get, therefore, as resultant potential on *D*,

$$E_D = \sqrt{(-\sqrt{3} \times 4910)^2} = 8500 \text{ volts,}$$

and in a similar way the potential on telephone wire *E* is

$$E_E = 7010 \text{ volts,}$$

an enormous potential when considering telephone lines.

On account of static and inductive effects the greatest trouble with the telephone installation should be expected when ground is used as one of the three lines in a three phase system.

Transposition does not help matters as far as static stresses are concerned. The voltage all along the line may not then be the same, but at any point it will be the resultant of the static stresses due to the three main conductors and the telephone will be affected by the static condition at that point.

The telephone line is therefore always likely to have some static voltage which in case of very high voltage transmissions and relatively short distance between the telephone lines and main lines might be considerable.

The danger from such static stresses might be great in a long line, so that it is desirable that the operator should stand on a very well insulated platform, but even then an unpleasant shock may be had, caused by the charging current of the person.

By using a telephone transformer and grounding the neutral of the secondary winding considerable protection is offered. The static effects are then done away with, but obviously not the inductive.

The difficulty is, however, to make a transformer wound for, say, full line voltage and still have small enough exciting current for satisfactory use with telephone.

To conclude the discussion on the phenomena of transmission lines are appended some tables of sparking distances as, given in the standardization Rules of the American Institute of Electrical Engineers; weights and resistance of line wires, and cost of pole line construction.

Kilovolts Sq. Root of Mean Sq.	Distance Between Needle Points.		Kilovolts Sq. Root of Mean Sq.	Distance Between Needle Points.	
	Inches.	Cm.		Inches.	Cm.
5	0.225	0.57	140	13.95	35.4
10	0.47	1.19	150	15.0	38.1
15	0.725	1.84	160	16.05	40.7
20	1.0	2.54	170	17.10	43.4
25	1.3	3.3	180	18.15	46.1
30	1.625	4.1	190	19.20	48.8
35	2.0	5.1	200	20.25	51.4
40	2.45	6.2	210	21.30	54.1
45	2.95	7.5	220	22.35	56.8
50	3.55	9.0	230	23.40	59.4
60	4.65	11.8	240	24.45	62.1
70	5.85	14.9	250	25.50	64.7
80	7.1	18.0	260	26.50	67.3
90	8.35	21.2	270	27.50	69.8
100	9.6	24.4	280	28.50	72.4
110	10.75	27.3	290	29.50	74.9
120	11.85	30.1	300	30.50	77.4
130	12.90	32.8	...	...	...

WIRE TABLE.—B. &amp; S. GAUGE.

Size of Wire.	Weight per Mile.	Diam. in Inches.	Area in Circular Mils.	Resistance at 75° F. per Mile of Wire.
0000	3376	.460	211,600	.26
000	2677	.410	167,805	.33
00	2123	.365	133,079	.41
0	2123	.325	105,592	.52
1	1335	.289	83,694	.65
2	1059	.258	66,373	.83
3	840	.229	52,633	1.04
4	666	.204	41,742	1.31
5	528	.182	33,102	1.66
6	419	.162	26,250	2.09
7	332	.144	20,816	2.63
8	263	.128	16,509	3.32
9	209	.114	13,094	4.18
10	166	.102	10,382	5.28



Approximate costs of the various kinds of transmission lines — four columns — are given:

*A* represents single line tower construction.

*B* represents single line pole construction.

*C* represents double line tower construction.

*D* represents double line pole construction.

	A	B	C	D
Number of poles or towers . . . .	14	52	14	104
Cost of poles or towers . . . . .	\$1100	\$240	\$1100	\$480
Cost of insulators (about 40,000 volts) . . . . .	90	320	180	640
Cost of foundation . . . . .	135		135	
Cost of pole or tower erection . . .	65	75	65	150
Cost of putting up wires . . . . .	115	115	230	230
Cost of painting . . . . .	65		65	
Cost of ground wire . . . . .	110	110	110	220
Cost of ground plates . . . . .	80	80	80	160
Total cost . . . . .	\$1760	\$940	\$1965	\$1880

We see from this that when — as is the rule — duplicate lines are necessary, the cost of tower or wooden pole transmission is practically the same. Since the life of tower construction ought to be considerably greater than that of pole construction, our preference would be for tower construction.

## SECTION II.

## GENERATING STATION.

THE main features to be decided in connection with the generating station are:

- First. Type of prime mover;
- Second. Size of units;
- Third. Type of generator;
- Fourth. Voltage of generator;
- Fifth. Method of potential control;
- Sixth. General switchboard arrangement.

## TYPE OF PRIME MOVER.

In many cases the presence of water power makes the electrical transmission possible; in such case water turbines are of course the obvious prime movers. Since, however, there are very few plants in which the available water power does not fluctuate considerably during the different seasons, it is often necessary to install auxiliaries of different types.

These types are steam turbines, steam engines of reciprocating type, combination of the two, or finally gas engines. Each type has points of advantage.

*The steam turbine* is a very simple piece of machinery, can be made of very large size, requires the least attention and floor space, and has a good efficiency, especially when operating with high vacuum. Its cost should be less than that of the other types.

Essentially two types are built to-day. One, usually designated as the Parsons type, permits the steam to expand gradually, as it passes through the turbine, so that there is a gradual drop in pressure from wheel to wheel. The steam velocities are with this type less than 1000 ft. per second.

The others, the De Laval, Curtis, Rateau-Zoelly type, permit the steam to expand in one or more sets of nozzles, thereby

acquiring a high velocity which is converted into energy given the wheel or wheels.

De Laval employs one nozzle to convert the steam from the boiler pressure to the pressure of the condenser, or atmosphere, thereby giving the steam a theoretical velocity of 4020 ft. per second in the first case, and 2970 ft. per second in the second. (In each case an initial absolute pressure of 175 lb. per square inch and saturated steam is assumed. The vacuum in the first case is assumed as 28 in., and in the second case the exhaust is assumed in the atmosphere.)

Curtis and the others do not convert the entire pressure difference in energy in one step, but divide it up. So, for instance, the 10,000 kw. Curtis turbine employs five stages of substantially equal work, each stage having two sets of buckets, and an intermediate stationary guide vanes. The theoretical steam velocity in that case (steam leaving the nozzle) is 1800 ft. per second.

In the Rateau-Zoelly, and other types of turbines, as a rule, many more stages are used than with the Curtis type, and each stage has one wheel. (The number of rows of buckets is, however, decidedly less than with the Parsons type.) The steam velocity in such type, assuming 20 stages, would be 900 ft.

Without going into the design of such turbines, it is not possible to discuss them more in detail.

In a general way, there is an advantage in low steam speed, and with everything else the same, the turbine using the lowest steam speed would be the most efficient; but everything else cannot be the same. With low steam speed comes a great number of rotating parts, loss by balancing the end pressure, high rotation loss, due to the wheels revolving in a stage of high pressure, etc.

After all, as long as these turbines are built by responsible parties, the choice would depend upon the guaranteed efficiency, the cost and floor space. It is appropriate to discuss here the measuring of efficiency of a turbine. As with any other piece of apparatus it is the ratio of the  $\frac{\text{output}}{\text{input}}$ .

The output can be directly determined by brake or electrical readings. Indeed, when turbines are used with electrical gen-

erators the "electrical efficiency" is given, and means the ratio of  $\frac{\text{electrical output}}{\text{theoretical input from the steam}}$ .

The energy input from the steam is not the total heat, since, by the limitations of the condenser, we cannot give the turbine the full benefit of all the energy. We mean the energy in the steam between the pressure limits, the high pressure on one side and the condenser pressure on the other.

The available energy is, however, not directly obtainable from the steam tables. It might be thought that since 1 lb. of steam at 175 lb. absolute pressure contains 1194.9 heat units, and one pound at one pound pressure contains 1130 heat units, that 64.9 heat units or  $64.9 \times 778 = 50,500$  ft. lb. are available, if the steam is used between 175 lb. and 1 lb.

A slight consideration will tell, however, that we ought to have much more energy available, since when steam expands adiabatically from 175 lb. to 1 lb. a large percentage of the steam is converted to water — in this case 23.4 per cent.

The available energy per pound of steam can be calculated from the following equation, involving constants which can be readily found in standard text-books.

$$\text{Ft. lb. per pound of steam} = 778 (H_1 + C_p t_1 - (q_2 + x r_2))$$

where

$H_1$  = total heat at pressure  $p_1$

$C_p$  = specific heat of superheated steam at pressure  $p_1$

$t_1$  = superheat in degrees F. at pressure  $p_1$

$q_2$  = heat of liquid at pressure  $p_2$

$x$  = quality of steam at pressure  $p_2$

$r_1$  = latent heat at pressure  $p_1$

$r_2$  = latent heat at pressure  $p_2$

The quality of steam  $x$  has to be calculated from the fact that the entropy is the same before and after expansion.

$$\text{Entropy of superheated steam} = C_p \log_e \frac{T_1 + t_1}{T_1} + \frac{r_1}{T_1} + \phi_1$$

$$\text{Entropy of moist steam} = \frac{x r_2}{T_2} + \phi_2$$

In these equations  $T_1$  and  $T_2$  are the absolute temperatures



of saturated steam at pressures  $p_1$  and  $p_2 = 461 +$  temperature expressed in degrees Fahrenheit.

$\phi_1$  = entropy of water at pressure  $p_1$

$\phi_2$  = entropy of water at pressure  $p_2$

*Example.* Find available energy per pound of saturated steam when expanding adiabatically from 175 lb. absolute pressure to one pound (about 28 in. vacuum).

We have then,

$$\frac{r_1}{T_1} + \phi_1 = \frac{xr_2}{T_2} + \phi_2$$

or

$$x = \frac{T_2}{r_2} \left( \phi_1 - \phi_2 + \frac{r_1}{T_1} \right)$$

$$= \frac{461 + 102}{1043} \left( .53 - .134 + \frac{851.6}{461 + 370.5} \right) = 0.769$$

Thus moisture = 23.4 per cent.

Available energy in ft. lbs.

$$= 778 (1194.9 - (70.1 + .766 \times 1043)) = 253,000.$$

If the expansion could have been carried to absolute vacuum, by substituting proper values in above equation, we would have found that each pound of steam contained 950,000 ft.-lb.; thus the available heat in percentage of total heat in that case is 27.2 per cent. Using 215 lb. pressure, 200 degrees superheat, and 29 in. vacuum, this ratio is 31 per cent; with 215 lb. pressure, 0 degrees superheat, and 29 in. vacuum, this ratio is 30 per cent. Thus there is a gain by superheat (the specific heat of superheated steam was assumed as 0.5).

Crediting the coal consumption with the benefit of heated feedwater of, say, 127° F., the theoretical heat efficiency of saturated steam between 175 lb. absolute pressure and 28 in. vacuum

would be  $\frac{253,000}{856,000} = 29.6$  per cent. With a turbo unit of 70 per cent efficiency the thermal efficiency to the bus bar is 20.7 per cent.

One kw.-hour is equivalent to 2,654,000 ft.-lb.

Consequently, the theoretical water rate corresponding to one kw.-hour is  $\frac{2,654,000}{\text{available energy per pound of steam}}$ .



For convenience, some of these theoretical water rates are given in curve sheets 37-43 inclusive.

By the use of these tables with guaranteed electrical efficiency

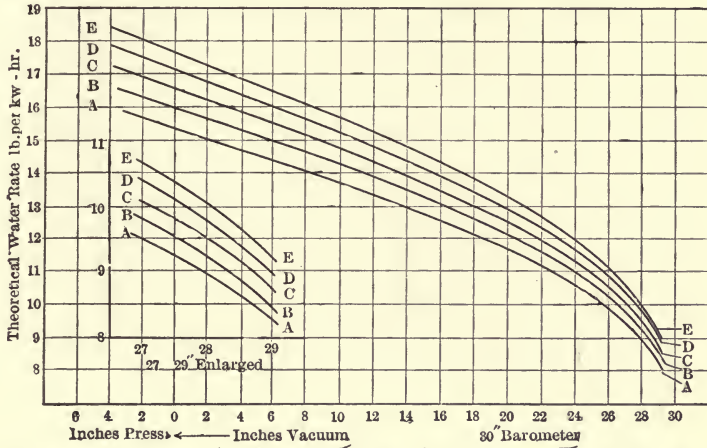

FIG. 37. Theoretical water-rate curves, initial pressure = 215 lbs. abs.

of the turbine set the water rate can directly be ascertained. So, for instance, with saturated steam at 175 lb. absolute pressure

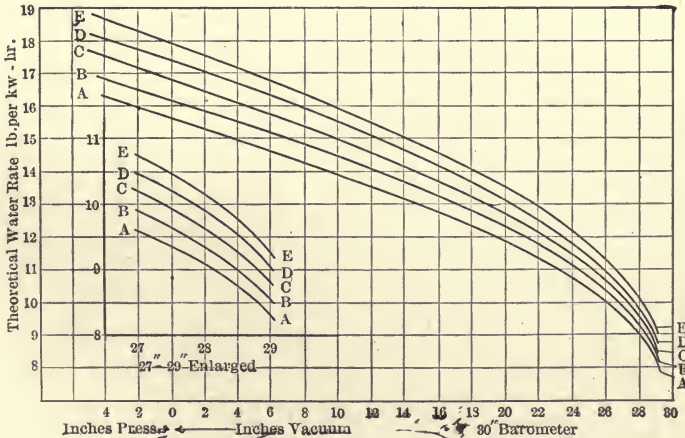

FIG. 38. Theoretical water-rate curves, initial pressure = 200 lbs. abs.

and 28 in. vacuum, and an efficiency of 60 per cent, the water rate is 17.5 lb. per kw.-hour.

As a rule, turbines give a slightly better efficiency with superheated steam than with saturated steam, due to lesser rotation losses.

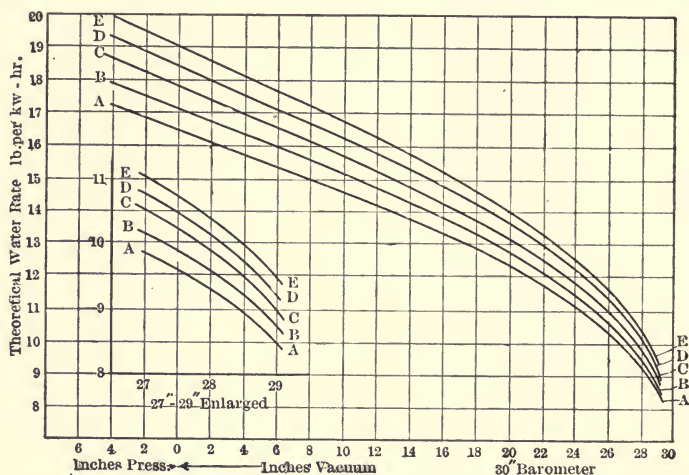

FIG. 39. Theoretical water-rate curves, initial pressure = 175 lbs. abs.

Superheat very materially reduces the water consumption, and to some extent effects a saving in coal. This latter amount is,

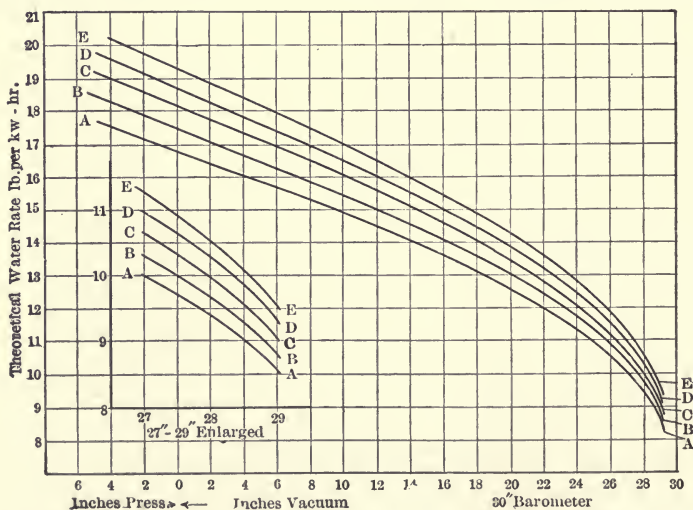

FIG. 40. Theoretical water-rate curves, initial pressure = 165 lbs. abs.

however, at present time somewhat uncertain, since the specific heat of superheated steam is not satisfactorily determined.

Assuming, however, that the steam boiler efficiency is the same in the case of saturated steam, and when superheated steam

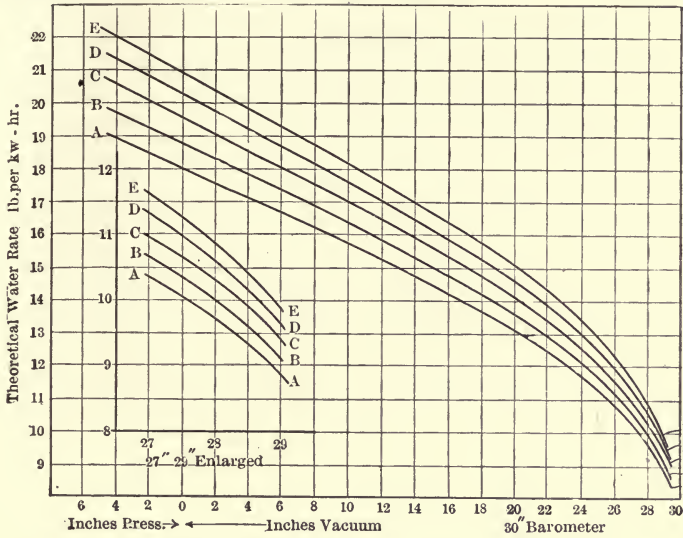

FIG. 41. Theoretical water-rate curves, initial pressure = 140 lbs. abs.

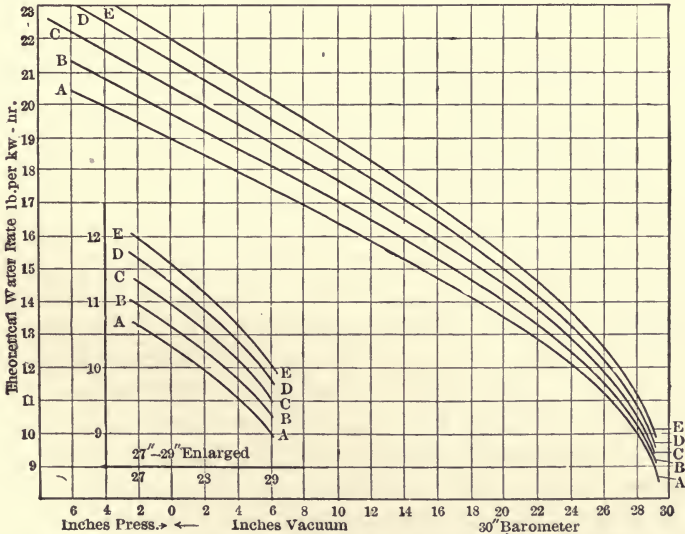

FIG. 42. Theoretical water-rate curve, initial pressure = 126 lbs. abs.

is used, and that the fuel gases leave at the same temperatures, it is possible to determine the gain in coal by superheat under various assumptions of specific heat of superheated steam.

Let  $H$  be the total heat per pound of saturated steam.

Let  $H_1$  be the total heat per pound of superheated steam.

Then the increase by superheat in coal =  $\frac{H_1 - H}{H}$ .

Let  $A$  be the available energy in a pound of saturated steam.

Let  $A_1$  be the available energy in a pound of superheated steam.

The increase in available energy per pound of steam by superheat is then  $\frac{A_1 - A}{A}$ . Assuming the water rate with saturated steam as unity, the superheated water rate is then  $\frac{A}{A_1}$ . Thus the total heat with the saturated steam is  $H$ , and with superheated steam  $\frac{A}{A_1} H_1$ , and the saving in heat by superheat  $H - \frac{A}{A_1} H_1$ .

Thus the saving in coal is  $\frac{H - \frac{A}{A_1} H_1}{H} = 1 - \frac{A}{A_1} \frac{H_1}{H}$ . This

value is plotted in curve sheet 44, for some of the ordinary operating conditions and various values of  $C_p$ . The percentages saving in coal given do not take into consideration the additional gain by superheat by the reduction of rotation losses, so that the values should be conservative.

It is interesting to note, that, the higher the value of  $C_p$  the more is the gain, also the percent gain is greatest, if the heat cycle used is smallest; so, for instance, the gain by 200 degrees superheat in a plant operating between 215 lb. absolute pressure and 28 in. vacuum is 3 per cent. Whereas, if operated between 100 lb. and 28 in. vacuum and 200 degrees superheat, the gain would have been  $3\frac{1}{2}$  per cent, or finally, if between atmospheric pressure and 28 in. vacuum, 6 per cent.

A good vacuum means, however, not only a saving in water but also in coal. Best economy in coal and water is obtained with a maximum initial pressure, maximum superheat, and minimum back pressure. Comparing now the steam turbine with the reciprocating engine, we find, that for non-condensing operation, or operation against a back pressure higher than the



atmosphere, the most efficient engine is more economical than a turbine, whereas, when operating at low pressure or good vacuum, the turbine is better than the engine.

The best steam combination, therefore, is reciprocating engines for the higher range of pressures, and turbines for the lower.

The theoretical possibilities of the gas engine are of course great, but so far very little inroad has been made by this type of prime mover. There are several reasons for this; for instance, high initial cost, large floor space, complicated system, and rather small maximum size of each unit. It does not seem

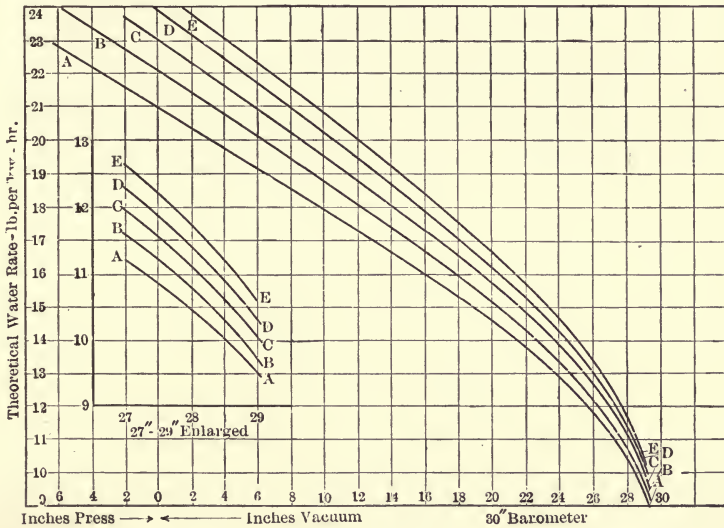

FIG. 43. Theoretical water-rate curves, initial pressure = 100 lbs. abs.

likely that for some time to come gas engines of larger than 2000 to 3000 kw. capacity will be built. Whereas, modern large stations demand sizes from 5000 to 10,000 kw.

When we consider the generator in each case there is little choice as to electrical features. Mechanically it might be expected that the slow speed engine driven or gas engine driven units ought to require less attention or repairs, but as a matter of fact, considering the smaller size of the turbine driven unit, for a given output its lesser number of coils, etc., these advantages do not exist. Obviously, the turbine driven generator should be the cheaper.



Looking at the condition fairly, it would seem as if by far the greatest number of large stations will be equipped with steam turbines.

In the particular numerical example that has been considered involving, — as a maximum 50,000 kw. at the receiving end of

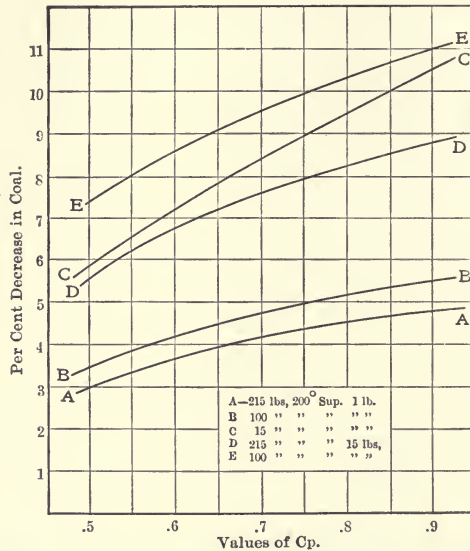

FIG. 44. Effect of superheat on coal consumption.

the line with a line loss of 15 per cent, — we would recommend the installation of six 10,000-kw. units capable of 50 per cent overload for a couple of hours.

With such an equipment the maximum load could readily be taken care of with one machine shut down; indeed, four out of the six should suffice.

### THE GENERATOR.

Regarding the type of generator, since the transmission is three phase, generators of the same system will be installed, there seems no valid reason why it should not be three phase. The maximum voltage for which generators have been built up to date is 22,000 volts. These high potentials are obviously of advantage when the transmission voltage can be the same as that of the generator. When, however, the transmission

voltage is so high as to make the use of step-up transformers, between generator and line, necessary, the lower voltage of the generator is advantageous. There is, however, a limit below which the generator voltage should not be made, since under certain conditions a fraction of the line voltage is electrostatically impressed upon the generator winding. Under such conditions, the stresses on the insulation might be too great." Such condition is, for instance, when in a delta high potential system one line is grounded, or in a *Y*-system with the neutral grounded, when operating temporarily with two of the lines and the ground as the third conductor. Against this might be argued that with the generator winding *Y* and the neutral grounded such conditions cannot arise. Nevertheless it is not always practical to ground the neutral of the generator windings, especially when different types of alternators are operated in parallel, and therefore the neutral cross-current cannot be left out of consideration.

In transmissions involving voltages up to 13,000 it is preferable to wind the generator for the line potential. For transmissions of higher voltages it seems conservative to use step-up transformers and to choose a generator voltage of from 6,000 to 10,000 volts.

#### VOLTAGE CONTROL.

We shall next consider the best method of voltage control in the generating station. This feature is very simple in a station of some size where all power is transmitted a long distance, since the load on individual machines does not fluctuate much. The station engineer soon finds at what voltage the station should be run to give the best average potential at the receiving end of the transmission and the field regulation is done by hand.

In a small station the control ought to be automatic, and the methods used will be discussed when dealing with the substation features. The best *switchboard arrangement* is much debated. As a general rule, the consulting engineer at first demands very complete layout which permits of any generator units running with any feeder, duplicate oil switches, one protecting in case of failure of the other, control of any part of the system from one central board, or in some cases from two different places, etc.; time limit and reverse current relays,

etc. In very large and important installations such layout is no doubt justified — nevertheless the writer believes that there will be less and less thereof — if for no other reason, on account of the cost and the space required.

Each case needs, however, special and most thorough investigation. In the particular station that is considered in the numerical example, a switchboard arrangement as shown in Fig. 45 would be recommended on account of its great simplicity and flexibility.

The six generators *A* are substantially directly connected to the step-up transformers, and the paralleling is done on the high potential side.

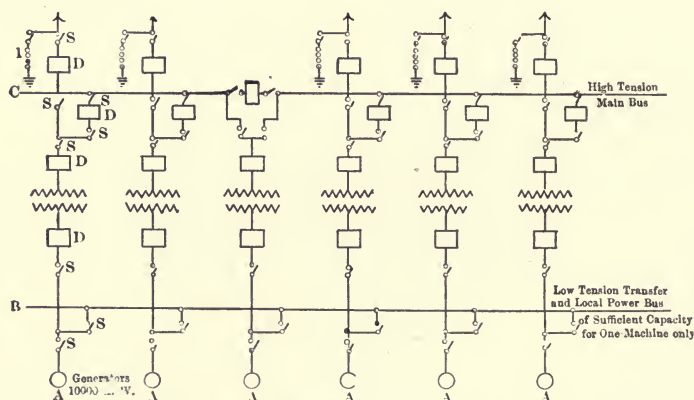

FIG. 45. Switchboard arrangement.

*B* represents a low tension transfer or local power bus of sufficient capacity for one generator only.

The main bus *C* is connected to the high potential transformers by means of an oil switch *D* and a series of knife switches *S*.

The four transmission lines can be fed either directly from the generators or through the bus bars *C*.

Each transmission line has its oil switches *D* and lightning arrester equipment *i*. The diagram is very plain, and it seems unnecessary to explain it more in detail.

#### GENERATORS.

It is not intended to discuss the actual designing of apparatus, but it is desirable to go into this question sufficiently to enable

the engineer to judge the behavior of the various apparatus under many conditions which are not directly brought out by the commercial tests.

So, for instance, in the case of alternating current generators guarantees are usually made as to regulation and efficiency, and the machines have to be accepted without the actual load tests.

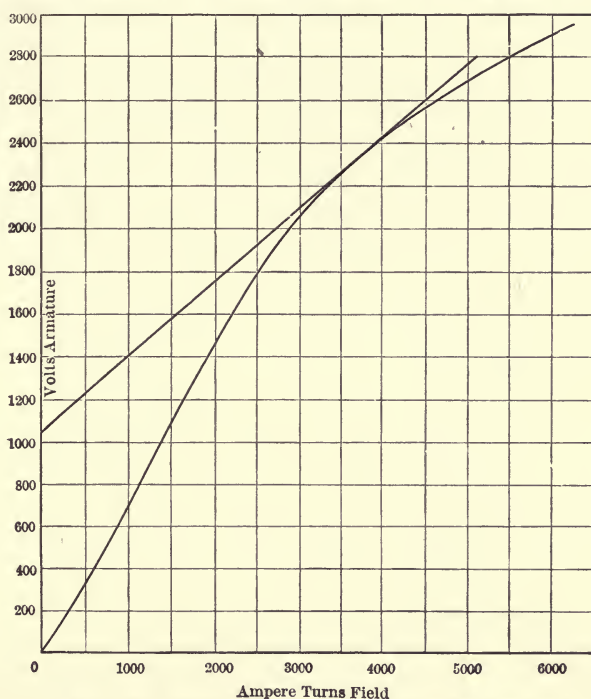

FIG. 46. Saturation curve of 100-kw. alternator.

As a matter of fact, the characteristics can very closely be calculated from two tests — which fortunately are easily made and require but a small percentage of the full load power.

These tests are: No-load saturation and synchronous impedance.

The no-load saturation test is made at normal speed, and the terminal voltages corresponding to various field excitations are taken. The results are usually plotted with field ampere-turns per pole as abscissæ and volts as ordinates, as shown in Fig. 46.

The curve gives, therefore, directly the no-load excitation corresponding to any voltage. At load and same terminal



voltage the flux and field excitation is changed on account of the armature reaction and self-induction.

Armature reaction represents the resultant m.m.f. of the armature currents, and pulsates between zero and  $\sqrt{2} It$  in single phase machines. It is  $\sqrt{2} It$  in quarter phase machines, and  $1.5 \sqrt{2} It$  in three phase machines, where  $I$  is the current in one phase and  $t$  is the number of effective turns in series per pole and phase.

This m.m.f. may have a magnetizing, or a demagnetizing effect, or it may shift the field flux from one side of the pole to the other, or combine both effects. The energy current is a maximum when the slot is under the pole, therefore it has only a shifting tendency. (See Fig. 47.) If the magnetic reluctance is the same all around the field, the shift can be obtained directly

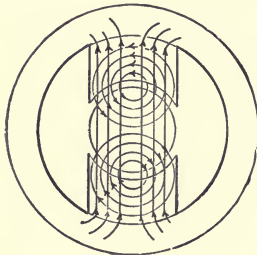

FIG. 47. Armature reaction. Energy current.

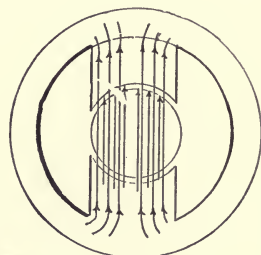

FIG. 48. Armature reaction. Wattless current.

by a vector diagram. If, however,—as is the case with machines of definite poles,—the magnetic reluctance is not constant, then the shift will be less. Experience has shown that in such machines the shift is about 0.5 of what the vector diagram would indicate.

The wattless component of current, however, has either a magnetizing or a demagnetizing effect, and its action, therefore, in both types of machines can be considered the same. (See Fig. 48.)

In the following calculations the armature reaction is represented by  $mI$  or  $m_0 I$ , where  $m$  is  $\sqrt{2} t$  for two phase machines, and  $1.5 \sqrt{2} t$  for three phase machines.  $m_0$ , the corresponding figure for the energy current in definite pole machines, is  $0.5 m$ .  $t$ , the number of armature-turns per pole and phase and  $I$  the effective current.



The self-induction of the machine is caused by the flux which is set up by the armature current, and which does not interlink with the main flux.

In a definite pole machine this changes with different positions of the armature slot in regard to the poles. When the power component of the current is a maximum, the self-induction is also a maximum, since the slot is then under the pole; whereas, when the wattless component is a maximum, the self-induction is a minimum for obvious reasons. The self-induction in definite pole machines is about 50 % greater with

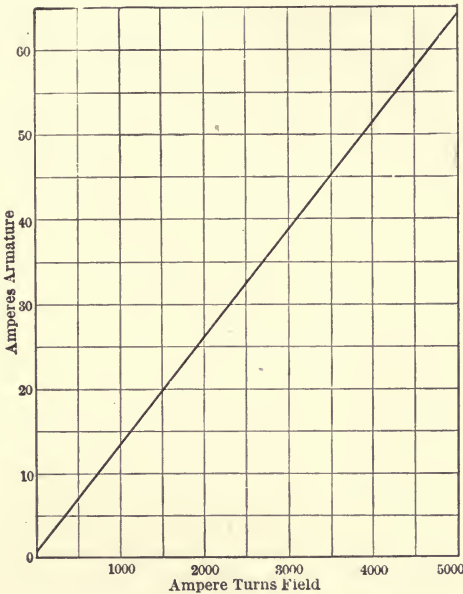

FIG. 49. Synchronous impedance curve of 100-kw. alternator.

the conductor under the pole than when between the poles. With machines of uniform magnetic reluctance the self-induction, as well as the armature reaction, is, of course, the same for both currents.

The synchronous impedance test is taken by short-circuiting the armature windings upon themselves at normal speed. The armature and field current is read.

A curve is usually plotted, as shown in Fig. 49, between the field ampere turns and the armature current, or frequently, as

shown in Fig. 50, where the armature current is plotted against the no-load voltage as obtained from the saturation curve for the same number of ampere-turns.

These curves are not straight lines, but bend due to saturation. This test is used to determine the self-induction of the armature. Since in this test the armature is short-circuited upon itself, no appreciable power component of current exists, and the current is lagging approximately  $90^\circ$ . Consequently, if the machine is of definite pole type, the current reaches its maximum in the position of least self-induction. (See Fig. 48.)

Let  $R$  be the armature reaction with full load current.

Let  $R_1$  = the synchronous impedance ampere-turns corresponding to full load armature current.

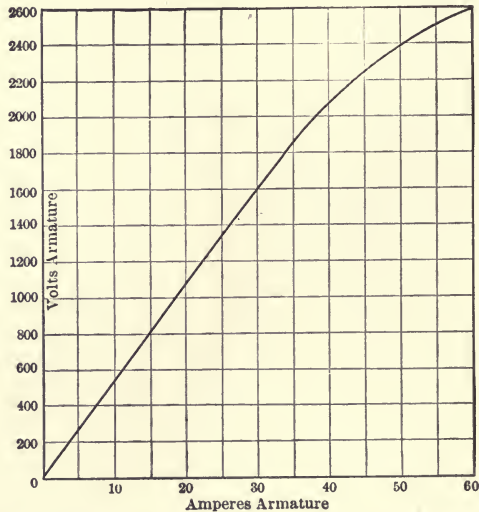

FIG. 50. Synchronous impedance curve, 100 kw. alternator.

The self-inductive ampere-turns =  $R_s$  are then =  $R_1 - R$ .

From the no-load saturation curve we find then  $E_x$  the voltage corresponding thereto. This voltage divided by the current gives then the true inductive reactance in a round rotor machine. In a definite pole machine this represents the inductive reactance for wattless currents, whereas for the power component we should use an inductive reactance of 50 per cent greater value.

Lacking complete tests on a large machine I have illustrated the application of the above reasoning with a 100 kw three-phase generator, 8-100-900-2300 volts, 25 amp. Y-connected, revolving field definite pole machine, having 8 poles and running at 900 revolutions per minute.

The armature has 48 slots.

Each slot has 28 conductors, each consisting of 4 No. 14 B. & S. wires in parallel.

Resistance per phase = 0.68 ohm.

Diameter of armature, 24 in.

Length of core lamination, 12 in.

Effective length, 9 in.

Length of air gap, 25 in.

Turns in series per phase =  $28 \times 8 = 224$ .

Volts per phase =  $2300 \div \sqrt{3} = 1330$ .

Thus, flux per pole =  $\frac{1330 \times 10^8}{4.44 \times 60 \times 224} = 2.3$  megalines.

Armature reaction  $R = \sqrt{2} \times 1.5 \times 25 \times 28 = 1490$  ampere-turns.

Thus,  $m = \frac{1490}{25} = 59.5$  and  $m_0 = 29.7$ .

The synchronous impedance test of this machine shows that the excitation corresponding to full load armature current is 1890 ampere-turns =  $R_1$ .

Therefore, the self-inductive ampere-turns

$$R_s = 1890 - 1490 = 400,$$

and corresponding voltage from the saturation curve

$$E_x = 250 \text{ volts.}$$

The apparent inductive reactance is, therefore,

$$\frac{250}{25} = 10 \text{ ohms.}$$

It must, however, be remembered that this is not the true inductive reactance, but the reactance which refers to the terminal voltage, since the saturation curve usually does not give the voltage per phase. In a three phase Y-connected

generator the voltage per phase is  $\frac{\text{terminal voltage}}{\sqrt{3}}$ , therefore in this case the reactance as obtained by test is

$$\frac{10}{\sqrt{3}} = 5.8 \text{ ohms}$$

per phase. Therefore, since this is a machine of definite poles we get

$$\begin{aligned} x_0 &= \text{reactance for the power component of the current} \\ &= 1.5 \times 5.8 = 8.7 \text{ ohms,} \end{aligned}$$

and

$$\begin{aligned} x &= \text{reactance for the wattless component of the current} \\ &= 5.8 \text{ ohms.} \end{aligned}$$

(If this machine had been a delta-connected generator of the same voltage the inductive reactance per phase would have been

$$\frac{250}{\frac{25}{\sqrt{3}}} = 17 \text{ ohms,}$$

since the current in each winding would have been the line current divided by  $\sqrt{3}$ . In a quarter phase machine it would have been the same as obtained directly from the saturation test.)

With round rotor machines, that is, machines having uniform magnetic reluctance in all positions, it is possible to construct diagrammatically the internal reactions. With definite pole machines the problem is almost impossible. Since, however, the graphical method throws more light on the subject than any analytical, this method will be described.

Let in Fig. 51  $OE$  represent the voltage per phase at the terminal of the generator, when carrying the current  $I$   $\theta$  be the angle between the terminal e.m.f. and the current which is governed by the power factor of the load, and is found from the fact that  $\cos \theta$  is the power factor. If the load is inductive  $\theta$  is positive, as shown in diagram; if consisting of over-excited synchronous apparatus or condensers it is negative, as shown in dotted lines.

The e.m.f. consumed by the armature resistance is in phase with the current and is  $Ir$ , as shown in the diagram.

The e.m.f. consumed by the self-induction or armature reactance is 90 degrees ahead of the current and represented in diagram as  $Ix$ .

The resultant of these two e.m.f.'s  $Iz$  represents the drop in the armature. Consequently, in order to get a terminal e.m.f.  $OE$  an induced e.m.f., represented by  $OE_0$ , has to be generated.

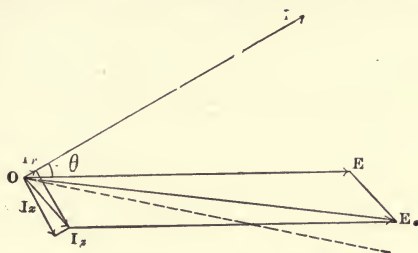

FIG. 51. Determination of induced e.m.f.

In its general nature this diagram is identical with that given previously in case of a transmission line; and were the generator perfectly "compensated," so that there was no distorting or demagnetizing effect of the armature current, the

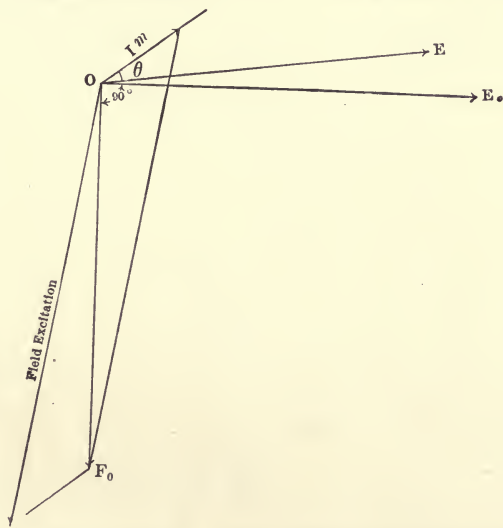

FIG. 52. Determination of field excitation from induced e.m.f.

proper field excitation could be found directly from the saturation curve; it should correspond to the value  $OE_0$ .

Unfortunately the generators are not compensated, so that the diagram and deductions are fairly complicated.

In Fig. 52 the construction is continued for the sake of making it plainer.



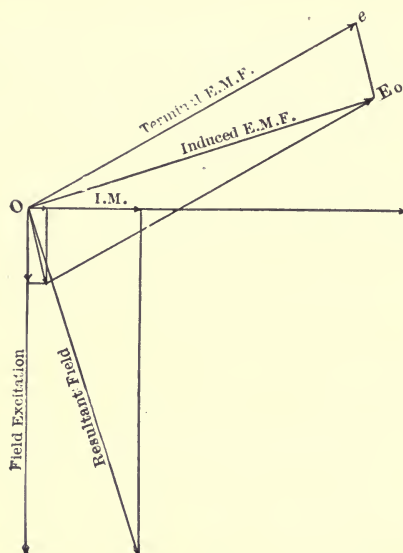

FIG. 53. Vector diagram for finding field excitation.  $30^\circ$  leading current.

ture current is in phase with the figure. Since  $OF_0$  is the resultant of the armature and field excitation, we can find by construction the phase relation and absolute magnitude of the field m.m.f.

To illustrate this further, three diagrams, Figs. 53, 54, 55, are given, in which the following constants have been assumed:

$$\begin{aligned}
 I &= 1, & e &= 1, \\
 r &= 0.05 \text{ corresponding to} \\
 &\quad 5 \text{ per cent resistance,} \\
 x &= 0.20 \text{ corresponding to} \\
 &\quad 20 \text{ per cent inductive} \\
 &\quad \text{reactance,} \\
 &\quad \text{no-load excitation} \\
 &\quad \text{corresponds to } e=1, \\
 &\quad \text{and } m = 0.30.
 \end{aligned}$$

We have then  $OE_0$  representing the induced e.m.f.; that is the voltage which results from the combined flux due to the field excitation and the armature reaction.

The number of ampere-turns corresponding to  $OE_0$  is determined from the saturation curve and is represented in the diagram as  $OF_0$ .

This line is drawn  $90^\circ$  degrees ahead of  $OE_0$  since the flux and, therefore, the m.m.f. causing the e.m.f. are  $90^\circ$  degrees ahead of the e.m.f.

The magnetizing or demagnetizing effect of the armature current, and is  $IM$  in the

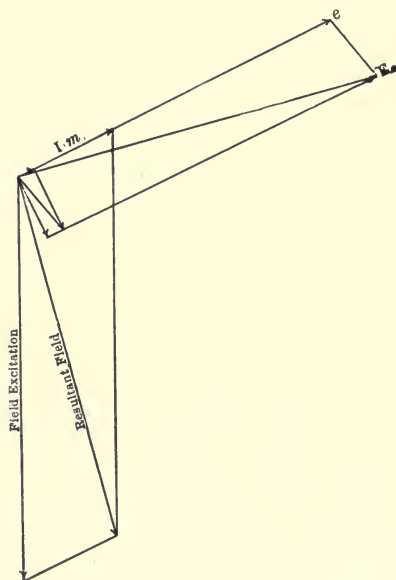

FIG. 54. Vector diagram for finding field excitation. Non-inductive load.

Two of the three diagrams refer to power factors of 86.6 per cent ( $\theta = 30$  degrees). The third, in Fig. 54, represents non-inductive load; in Fig. 55 with 86.6 per cent power factor the current is lagging, in Fig. 53 leading.

These relations can conveniently be expressed by equations by the use of complex quantities.

Let  $e_0$  be the induced e.m.f. per phase.

$e$  be the terminal voltage per phase.

$F_0$  be the m.m.f. from saturation curve corresponding to  $e_0$ .

$I = i + ji_1$  be the current per phase.

$i$  = power component.

$i_1$  = the wattless component;  $i_1$  is positive for lagging current, negative for leading.

$Z = r - jx$  internal impedance per phase; remembering, however, that with definite pole machines  $x$  is different for energy and wattless currents.

$F_1$  = no-load field excitation corresponding to rated voltage.

$E$  = field excitation at load.

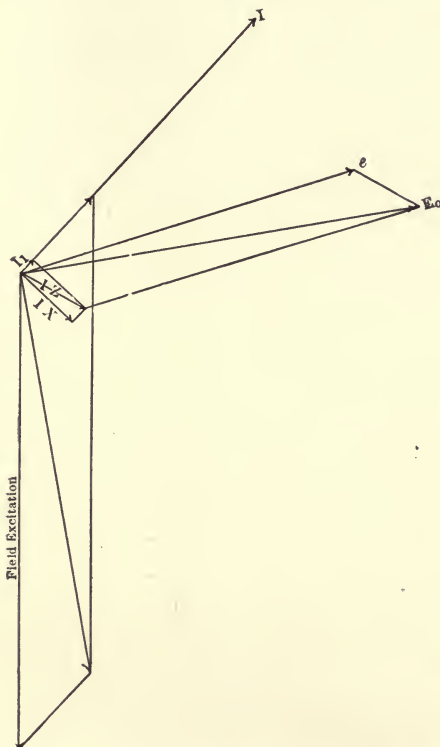

FIG. 55. Vector diagram for finding field excitation. 30° lagging current.

We have then

$$\begin{aligned} E_0 &= e + IZ = e + (i + ji_1)(r - jx) \\ &= e + ir + i_1x - j(ix - i_1r). \end{aligned}$$

This gives then in complex quantities the induced e.m.f. in machines of uniform magnetic reluctance.

In definite pole machines we get from the discussion given above,

$$E_0 = e + ir + i_1x - j(1.5ix - i_1r).$$

The m.m.f.  $n$  corresponding to the real part of the expression  $e + ir + i_1x$  is obtained directly from the saturation curve.

The quadrature component of the e.m.f. represented by the imaginary term increases the total e.m.f. but slightly, therefore we are not justified in taking the corresponding ampere-turns  $n_1$  from the saturation curve counting from  $e$ , the terminal voltage, because that would give too high a value.

Neither would we be justified in taking it from the origin of the curve because this e.m.f. has to be given with the saturation

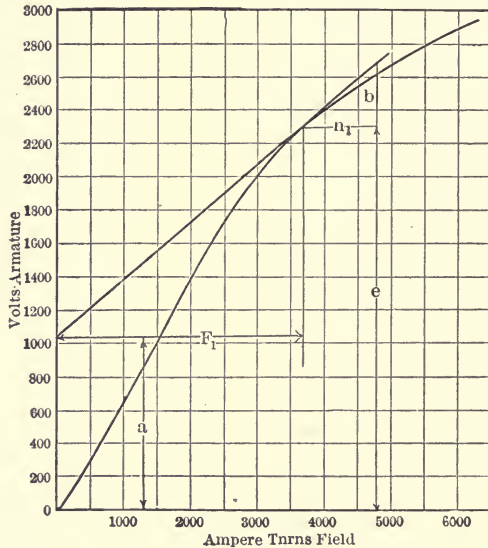

FIG. 56. Saturation curve of the alternator.

at about rated voltage. It seems reasonable to take it from a saturation curve represented by the tangent at  $e$ . Thus, referring to Fig. 56, if  $b$  is the e.m.f. corresponding to the imaginary term (referring to the terminal voltage), that is in a  $Y$ -connected machine  $\sqrt{3}$  times the voltage per phase, we have

$$\frac{b}{n_1} = \frac{e - a}{F_1}, \text{ or } n_1 = \frac{F_1 b}{e - a}.$$

Or, obviously, if  $b$  is expressed in voltage per phase in the above equation, we should use a value  $\frac{a}{\sqrt{3}}$ , where  $F_1$  is the

no-load ampere-turns corresponding to the normal voltage, and  $a$  is the ordinate at the point of intersection with the tangent.

Since the flux is 90 degrees ahead of the induced e.m.f. we can represent these fluxes in complex quantities by multiplication by  $-j$ . Since, furthermore, the m.m.f. and flux are in phase which can now be assumed after the corrections by the constants, we get then the resultant m.m.f. =  $-n_1 - jn$ .

The available m.m.f.'s are those of the field and the armature.

The armature m.m.f., that is, the armature reaction, is in phase with the armature current, and can, therefore, be written as  $m(i + ji_1)$ , or, referring to our previous discussion regarding the constants, as  $m_0i + mji_1$  where  $m_0 = 0.5 m$  in machines of definite poles.

We can therefore write for definite pole machines,

$$-n_1 - jn = m_0i + mji_1 - F,$$

or  $F = m_0i + n_1 + j(mi_1 + n),$

or  $F = \sqrt{(m_0i + n_1)^2 + (mi_1 + n)^2}$   
 $= \sqrt{m_0^2i^2 + n_1^2 + m^2i_1^2 + N^2 + 2(m_0n_1i + mni_1)}$

In this equation,

$m_0 = 0.5 m$  in definite pole machines.

$m_0 = m$  in machines of uniform magnetic reluctance.

$m = \sqrt{2} \times 1.5 t$  in three phase machines.

$= \sqrt{2} t$  in quarter phase machines.

$t =$  effective turns per pole and phase of armature.

$N^2 = n^2 + n_1^2.$

$n =$  m.m.f. from saturation curve corresponding to  $e + ir + i_1x$ .

$n_1 =$  m.m.f. from tangent of saturation curve corresponding to  $ix - i_1r$  in machines of uniform magnetic reluctance,

or  $1.5 ix - i_1r$  in machines with definite poles.

$x$  is the armature reactance as obtained from the synchronous impedance test as explained above. With machines of definite poles it should be 50 per cent greater when referring to the energy component of current.

At no load the excitation is 90 degrees ahead of the terminal e.m.f., that is, it is represented by  $-jF_1$  and therefore does not represent energy. With load a real component of the field appears, and the shift represents the displacement of the armature with load.

This angle as shown above can be found by equation

$$\tan \theta = \frac{m_0 i + n_1}{m i_1 + n} \text{ in definite pole machines,}$$

or 
$$\tan \theta = \frac{m i + n_1}{m i_1 + n} \text{ for round rotor machines.}$$

As a numerical instance the field excitation corresponding to full load output at various power factors (leading, non-

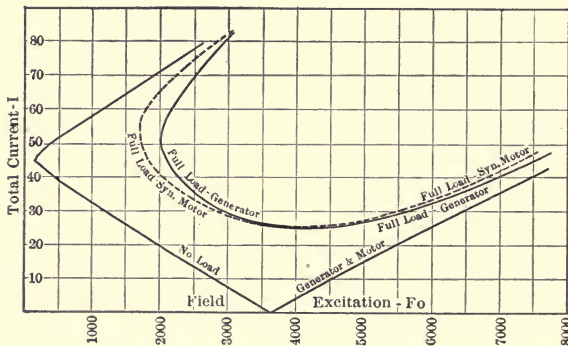

FIG. 57. Phase characteristics definite pole machine.

inductive and lagging current) is given below for the three-phase generator referred to previously.

We have the following constants:

$$\begin{aligned}
 e &= 1330 \text{ volts} & a &\text{ from saturation curve is } 1050, \text{ thus} \\
 & & &\text{ using a saturation curve plotted for} \\
 i &= 25 \text{ amp. at full} & &\text{ the voltage per phase } a \text{ would be} \\
 &\text{ load} & &= \frac{1050}{\sqrt{3}} = 606
 \end{aligned}$$



$i_1 =$  variable  $F_1$  from sat. curve corresponds to  
2300 volts and is 3650

$m = 59.5 AT$   $r = .69$  ohms  
 $m_0 = 29.7 AT$   $x = 5.8$  ohms  
 $x_0 = 8.7$  ohms

The various terms entering in the calculations are tabulated below, and the relation between field excitation and total current (that is  $\sqrt{i^2 + i_1^2}$ ) is shown in Fig. 57.

(On this curve sheet are also given, in dotted lines, the corresponding curves for the same generator used as synchronous motor, but these latter curves will be discussed later.)

The no-load phase characteristic is also added on the same sheet. This is obtained from the same general equation by substituting for  $i$  zero.

The detailed calculations for these curves are given below.

FULL-LOAD CHARACTERISTIC OF A GENERATOR WITH DEFINITE POLES.

Lagging.			Leading.		
$i_1$ . . . . .	37.5	25	0	-25	-37.5
$e$ . . . . .	1330	1330	1330	1330	1330
$ir$ . . . . .	17.3	17.3	17.3	17.3	17.3
$i_1x$ . . . . .	217	145	0	-145	-217
$e + ir + i_1x$ . . . . .	1564	1492	1347	1202	1130
$n$ . . . . .	5100	4600	3720	3100	2850
$ix_0$ . . . . .	217	217	217	217	217
$-i_1r$ . . . . .	-26	-17.3	0	17.3	26
$ix_0 - i_1r$ . . . . .	191	200	217	234	243
$n_1$ . . . . .	963	1006	1094	1182	1225
$n_1^2 \div 10^6$ . . . . .	.927	1.012	1.197	1.397	1.50
$n^2 \div 10^6$ . . . . .	26.01	21.16	13.84	9.61	8.12
$m_0n_1i \div 10^6$ . . . . .	.716	.748	.815	.88	.91
$mn_1i \div 10^6$ . . . . .	11.38	6.84	0	-4.61	-6.35
$2(m_0n_1i + mn_1i) \div 10^6$ . . . . .	24.192	15.176	1.63	-7.46	-10.88
$N^2 \div 10^6$ . . . . .	26.937	22.172	15.037	11.007	9.62
$m_0^2i^2 \div 10^6$ . . . . .	.55	.55	.55	.55	.55
$m^2i_1^2 \div 10^6$ . . . . .	4.98	2.21	0	2.21	4.98
$F^2 \div 10^6$ . . . . .	56.659	40.108	17.217	6.307	4.27
$F$ . . . . .	7520	6340	4150	2510	2070
$\sqrt{i^2 + i_1^2}$ . . . . .	45.1	35.36	25	35.36	45.1

NO-LOAD PHASE CHARACTERISTIC OF A GENERATOR WITH DEFINITE POLES.

Lagging.			Leading.		
$i_1$	37.5	25	0	-25	-37.5
$e$	1330	1330	1330	1330	1330
$i_r$	217	145	0	-145	-217
$e + i_r$	1547	1475	1330	1185	1113
$n$	5000	4450	3650	3050	2800
$-i_r$	-26	-17.3	0	17.3	26
$n_1$	-131	-87.2	0	87.2	131
$n_1^2 \div 10^6$	.017	.0076	0	.0076	.017
$n^2 \div 10^6$	25	19.8	13.32	9.30	7.84
$m_0 n_1 i \div 10^6$	0	0	0	0	0
$mn i_1 \div 10^6$	11.13	6.62	0	-4.53	-6.25
$\frac{2(m_1 n_1 i + mn i_1)}{10^6}$	22.26	13.24	0	-9.06	-12.50
$N^2 \div 10^6$	25.017	19.8076	13.32	9.3076	7.857
$m_0^2 i^2 \div 10^6$	0	0	0	0	0
$m^2 i_1^2 \div 10^6$	4.98	2.21	0	2.21	4.98
$F^2$	52.257	35.2576	13.32	2.4576	.337
$F$	7230	5940	3650	1568	581
$\sqrt{i^2 + i_1^2}$	37.5	25	0	25	37.5

The compounding curve, that is, the relation between field excitation and non-inductive load is also directly found from the same general equation.

We have then:

$i$	37.5	25	12.5	0
$e$	1330	1330	1330	1330
$i_r$	26	17	8.6	0
$i_1 x$	0	0	0	0
$e + i_r$	1356	1347	1339	1330
$n$	3750	3725	3700	3650
$i x_0$	324	217	109	0
$i_r$	0	0	0	0
$\Sigma$	324	217	109	0
$n_1$	1630	1095	548	0
$n_1^2 \div 10^6$	14.05	13.9	13.7	13.35
$n^2 \div 10^6$	2.66	1.2	.3	0
$N^2 \div 10^6$	16.71	15.1	14	13.35
$2 m_0 n_1 i \div 10^6$	3.63	1.63	.41	0
$m_0^2 i^2 \div 10^6$	1.24	.53	.14	0
$F^2 \div 10^6$	21.58	17.26	14.55	13.35
$F$	4640	4150	3810	3650

These values of field excitation are plotted on Fig. 58.

It is interesting to note from these calculations, that the generator should require some field excitation in order to stay

in step with other alternators even at no load, and, furthermore, that there is a minimum field excitation corresponding to each load. So, for instance, at no load an actual field excitation of 150 ampere-turns is required, at full load at least 2000 ampere-

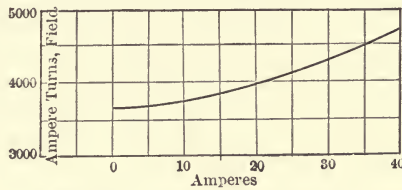

FIG. 58. Compounding curve.

turns. The magnetization caused by the armature current under these conditions corresponds to an armature current of 45 amperes and 52 amperes respectively, or about double full-load current.

Due to hysteresis of the generator the minimum field excitation is less than indicated by the calculation, and, at

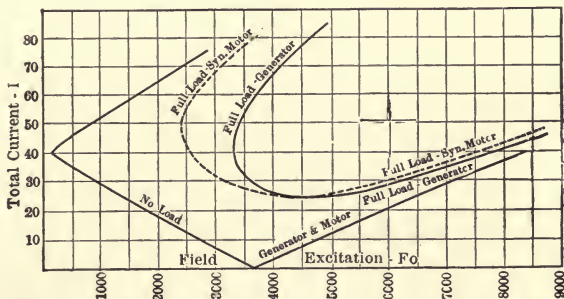

FIG. 59. Phase characteristics round rotor machine.

least with machines of definite poles, it is possible to keep the generator in step with other machines without any field excitation. So that these determinations of field excitation cannot be considered perfectly accurate, when the generator is running with, say, double full-load wattless current, and the actual field excitation is very low, as would be the case if the generator were supplying power to greatly overexcited synchronous machines — motors or rotary converters.

The calculations of the no-load and full-load phase characteristics of a similar machine having round rotor or uniform magnetic reluctance are given below, and the results plotted in Fig. 59.

For convenience' sake, it is assumed that the same armature was used as in the previous case, but that the armature was placed in a field of uniform magnetic reluctance.

The saturation curve is assumed the same in both cases, but the synchronous impedance test would be different, since the self-induction for wattless currents is materially increased.

In accordance with the general discussion we would expect to find  $x_0 = 1.5x$  the value found by the test of the definite pole machine.

Thus the constants would be

$e = 1330$ volts	$m_0 = 59.5$ ampere-turns
$r = .69$ ohms	$r = .69$ ohms
$x = 8.7$ ohms	$a = 606$ ampere-turns
$x_0 = 8.7$ ohms	$F_1 = 3650$ ampere-turns
$m = 59.5$ ampere-turns	$i = 25$ ampere-turns

FULL-LOAD PHASE CHARACTERISTIC AS GENERATOR DISTRIBUTED WINDING OF FIELD AND ARMATURE.

	Lagging.			Leading.			
$i_1$ . . . . .	37.5	25	12	0	-12	-25	-37.5
$e$ . . . . .	1330	1330	1330	1330	1330	1330	1330
$ir$ . . . . .	17.3	17.3	17.3	17.3	17.3	17.3	17.3
$i_1x$ . . . . .	326	218	104	0	-104	-218	-326
$e+ir+i_1x$ . . . . .	1673	1565	1451	1347	1243	1129	1021
$n$ . . . . .	6000	5100	4350	3720	3260	2850	2530
$ix_0$ . . . . .	217	217	217	217	217	217	217
$-i_1r$ . . . . .	-26	-17	-8	0	8	17	26
$ix_0-i_1r$ . . . . .	191	200	209	217	225	234	243
$n_1$ . . . . .	963	1010	1053	1094	1134	1181	1225
$n_1^2 \div 10^6$ . . . . .	.927	1.02	1.10	1.197	1.286	1.395	1.501
$n^2 \div 10^6$ . . . . .	36	26.01	18.92	13.84	10.63	8.12	6.401
$m_0n_1i \div 10^6$ . . . . .	1.432	1.5	1.565	1.628	1.689	1.755	1.82
$mn_1i \div 10^6$ . . . . .	13.38	7.58	3.11	0	-2.325	-4.24	-5.64
$2(m_0n_1i + mn_1i) \div 10^6$ . . . . .	29.624	18.16	9.35	3.256	-.636	-2.485	-3.82
$N^2 \div 10^6$ . . . . .	36.927	27.03	20.029	15.037	11.916	9.515	7.902
$m_0^2i^2 \div 10^6$ . . . . .	2.21	2.21	2.21	2.21	2.21	2.21	2.22
$m^2i_1^2 \div 10^6$ . . . . .	4.98	2.21	.51	0	.51	2.21	4.91
$F_0^2 \div 10^6$ . . . . .	73.741	49.61	32.099	20.503	14.000	11.45	11.178
$F_0$ . . . . .	8590	7040	5670	4530	3742	3384	3342
$I$ . . . . .	45.1	35.36	27.7	25	27.7	35.36	45.0

Comparing now the two types of generators as shown by the calculations, we find that the definite pole machine can carry its full load over a wider range of excitation than the "round

rotor" machine; it is also seen that the definite pole machine will stay in step with a lower value of field excitation than that of the "round rotor" machine. In other words, the definite pole machine is in general more stable.

It is evident therefore that if the same regulation and stability is required in the two types, the armature reaction should be less in the round rotor machine — or with the same armature reaction the winding should be so subdivided as to reduce the armature self-induction to a minimum.

#### *Synchronizing Force.*

This force may be defined as the torque per degree displacement of the armature. In the previous discussion the equation for the displacement was given as:

$$\tan \theta = \frac{m_0 i + n_1}{m i_1 + n}$$

for definite pole machines,  
and

$$\tan \theta = \frac{m i + n_1}{m i_1 + n}$$

in machines of uniform magnetic reluctance.

The torque in foot lbs. corresponding to a given kw. output is readily proven to be

$$\frac{7050 \times \text{actual kw. output}}{\text{Rev. per min.}}$$

Thus if  $P$  is the output in kilowatts and  $S$  the normal speed of the machine in revolutions per minute, we get

$$Q = \text{synchronizing torque} = \frac{7050 P}{S \times \theta}$$

As an instance the synchronizing force corresponding to full non-inductive load and 0.5 non-inductive load will be determined for the definite pole machine.

Referring to the second tabulation which gave the figures for the corresponding curve.



We have at full load ( $i = 25$ ),

$$\begin{aligned} m_0 &= 29.7 & m &= 59.5 \\ n_1 &= 1095 & n &= 3725 \end{aligned}$$

Thus at full load,  $\tan \theta = \frac{743 + 1095}{3725} = 0.494$  and  $\theta = 26.5^\circ$

approximately;

at 0.5 load,  $\tan \theta = \frac{371 + 548}{3700} = 0.248$  and  $\theta = 14^\circ$

approximately.

Thus at full-load output the synchronizing force is

$$\frac{7050 \times 100}{900 \times 26.5} = 29.6, \text{ and at 0.5 load } \frac{7050 \times 50}{900 \times 14} = 28.$$

We see from this that the synchronizing force is practically independent of the load.

Consider next the effect of power factor on the synchronizing force. Using the calculations for the full-load phase characteristic of the definite pole machine, we get:

	Lagging.			Leading.	
$i_1$ . . . . .	37.5	25	0	-25	-37.5
$m_0 i$ . . . . .	743	743	743	743	743
$n_1$ . . . . .	963	1096	1094	1182	1225
	1706	1749	1837	1925	1968
$mi_1$ . . . . .	2230	1485	0	-1485	-2230
$n$ . . . . .	5100	4600	3720	3100	2850
	7330	6085	3720	1615	620
$\tan \theta$ . . . . .	232	.287	.493	1.19	3.18
$\theta$ . . . . .	13°	16°	26°	50°	72.5°
Synchronizing force . . . . .	CO.2	47	20.1	15.7	10.8

We see from this that the synchronizing force is much stronger with strong field on the alternator than when part of the excitation is supplied by a leading alternating current, and therefore the actual field excitation is low.

Before leaving the question of synchronizing force, it is of interest to compare the results in machines of the two types.

Referring to the tabulations given above on the "smooth rotor" generator, we get:

	Lagging.			Leading.	
$i_1$ . . . . .	37.5	25	0	-25	-37.5
$m_0 i$ . . . . .	1490	1490	1490	1490	1490
$n_1$ . . . . .	963	1010	1095	1181	1225
	2453	2500	2585	2671	2715
$m i_1$ . . . . .	2230	1485	0	-1485	-2230
$n$ . . . . .	6000	5100	3720	2850	2530
	8230	6585	3720	1365	300
$\tan \theta$ . . . . .	.298	.379	.695	1.96	9.05
$\theta$ . . . . .	16.5°	20.5°	35°	63°	83.5°
Synchronizing force . . . . .	47.5	38.2	22.4	12.4	9.4

The synchronizing force is less than in the previous case under all conditions, thus these machines are less stable unless designed with different relations of field and armature ampere-turns.

*Hunting of Alternators.*

This phenomenon is affected by the synchronizing force, and the natural period depends directly therefrom. It is a pendulum problem, the problem of the period of a vibrating spring.

It has been previously proven, that the position of the armature relative to the field is not the same with no load as with load. The armature position in space is with load somewhat behind the position at no load.

This displacement is due to the torque on the periphery. If the torque is removed the armature accelerates to get into the no-load position, but due to its inertia will overreach, then swing back again, etc., until finally it stops in its true position.

Consider the problem from the mechanical point of view.

The force  $F$  in pounds at the periphery of an armature giving an output of  $P$  kw at speed  $S$  revolutions per minute and diameter  $D$  feet, is readily found to be

$$F = \frac{14,100 \times P}{S \times D}.$$

The displacement in phase with the load is, as shown previously, expressed by

$$\tan \theta = \frac{m_0 i + n_1}{m i_1 + n}$$

In an alternator with  $n_p$  number of poles the corresponding displacement of the armature  $\alpha$  would be

$$\frac{\theta}{\frac{n_p}{2}} = \frac{2\theta}{n_p}$$

Referring to Fig. 60 which shows the components for the motion of a pendulum.

The radial force corresponding to  $F$  is  $p = \frac{F}{\tan \alpha}$ . This force multiplied by the vertical distance represents the work

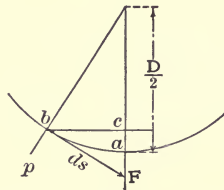

FIG. 60. Hunting of alternators.

done in moving a given point from  $a$  to  $b$ . It is  $pc = p \frac{D}{2} (1 - \cos \alpha)$ .

The work done can also be represented as  $Fds$ ; or, since

$$F = M \times a = \text{mass} \times \text{acceleration},$$

and  $a = \frac{dv}{dt}$  where  $v$  is velocity at time  $t$ ,

and  $v = \frac{ds}{dt}$  where  $s$  is distance at time  $t$ ,

we get  $F = \frac{Mvdv}{ds}$ , and the work done is  $Mvdv = \frac{Mv^2}{2}$ .

With rotary motion  $v = r\omega$  where  $r$  is the radius and  $\omega$  the angular speed. We can, therefore, write:

$$\text{work} = \frac{pD}{2} (1 - \cos \alpha) = \frac{Mr^2\omega^2}{2} = \frac{J\omega^2}{2}$$

when  $J = Mr^2$ .

Solving this equation for  $1 - \cos \alpha$  we get:

$$1 - \cos \alpha = \frac{J\omega^2}{pD}.$$

In an ordinary pendulum of weight  $P$  and length  $L$ , we would get by a similar reasoning:

$$PL (1 - \cos \alpha) = \frac{P L^2 \omega^2}{g};$$

thus 
$$1 - \cos \alpha = \frac{L\omega^2}{2g};$$

thus we can write

$$\frac{J\omega^2}{pD} = \frac{L\omega^2}{2g}, \quad \text{or} \quad L = \frac{2gJ}{pD}.$$

The time of oscillation of a pendulum of length  $L$  is

$$T = 2\pi \sqrt{\frac{L}{g}}.$$

If  $N_1$  represents the number of complete beats per minute,

we get 
$$N_1 = \frac{60}{T} = \frac{30}{\pi} \sqrt{\frac{pD}{2J}};$$

but  $p$  is as shown above,  $\frac{F}{\tan \alpha}$ ,

and 
$$\alpha = \frac{2\theta}{n_p};$$

thus 
$$\tan \alpha = \tan \frac{2\theta}{n_p},$$

or, since this angle is small,

$$\tan \alpha = \frac{2}{n_p} \tan \theta;$$

thus 
$$p = \frac{Fn_p}{2 \tan \theta},$$

and 
$$N_1 = \frac{30}{\pi} \sqrt{\frac{D}{2J} \frac{F n_p}{2 \tan \theta}}.$$

Since 
$$F = \frac{14,100 P}{S \times D},$$

and the following relation exists between frequency  $f$ , number of poles  $n_p$  and speed  $S$ , we have

$$f = \frac{n_p}{2} \times \frac{S}{60}, \quad \text{or} \quad \frac{n_p}{2} = \frac{60 f}{S};$$

we get 
$$N_1 = \frac{30}{\pi} \sqrt{\frac{D}{2J} \frac{60 f}{S} \times \frac{14,100 P}{SD \tan \theta}}$$

$$= \frac{6200}{S} \sqrt{\frac{P \times f}{J \tan \theta}}.$$

Substituting for  $J$  
$$\frac{WR^2}{32},$$

we get 
$$N_1 = \frac{35,000}{S} \sqrt{\frac{P \times f}{WR^2 \tan \theta}},$$

or, since  $\tan \theta$  as previously shown is  $\frac{m_0 i + n_1}{m_1 i + n}$ ,

we can finally write

$$N_1 = \frac{35,000}{S} \sqrt{\frac{P \times f \times (m_1 i + n)}{WR^2 \times (m_0 i + n_1)}}.$$

In this equation,

$N_1$  = natural period of alternator in complete beats per minute.

$S$  = revolutions per minute of alternator.

$P$  = output in kilowatts.

$f$  = frequency.

$W$  = weight in lb. of all revolving parts.

$R$  = radius of gyration in feet.

$i$  = power component of the current per phase.

$i_1$  = wattless lagging current per phase.



$m = \sqrt{2} t$  in two phase machines.

$= 1.5 \sqrt{2} t$  in three phase machines, where

$t =$  number of turns per pole and phase of the armature.

$m_0 = \frac{m}{2}$  in definite pole machines.

$= m$  in machines of uniform magnetic reluctance.

$n =$  ampere-turns field excitation from saturation curve corresponding to voltage  $e + i_r r + i_1 x$ .

$n_1 =$  ampere-turns from tangent of saturation curve of  $e$  corresponding to voltage  $i x_0 - i_1 r$ , where

$x =$  inductive reactance per phase in the armature as obtained from synchronous impedance test and armature reaction (explained previously).

$x_0 = 1.5 x$  in machines of definite poles.

$x_0 = x$  in machines of uniform magnetic reluctance.

*Example.* This particular machine (the 8-100-900) has a value of  $WR^2 = 550$ . Thus the natural frequency at full non-inductive load is

$$N_1 = \frac{35,000}{900} \sqrt{\frac{100 \times 60}{550 \times 0.493}} = 183.$$

To illustrate the range of variation in natural periods of the two types of machines, curves *a* and *b*, curve sheet 61, are plotted from the calculations made previously.

*a* refers to the definite pole machine.

*b* refers to the "round rotor" type.

In each case the  $WR^2$  has been assumed the same, which would hardly have been the case in an actual machine. It should have been expected that the round rotor would have been heavier, thus the natural period even lower than shown.

Both curves show that the frequency increases with lagging current, — that is, with "stiff field," — also that the range of natural frequencies in a given machine is very considerable.

In order to more fully understand this phenomenon, it is well to calculate the natural frequency for several loads and amounts of leading or lagging currents.

Some of the calculations are tabulated below.

Table *A* gives the values when full-load power component of current is delivered.

Table *B* when 0.5 load power component of the current is given.

Tables *C* and *D* the corresponding values when the generator is driven as synchronous motor (the theory of which will be given later). Suffice it here to say that the correct constants can be obtained by substituting for  $i$  the negative value  $-i$ . Thus in table *C*, 0.5 load power is supplied to the generator; in Table *D*, full-load power.

The results are plotted on curve sheet 62, which is quite instructive.

We see that the period depends very little upon the actual load or the fact that power is given or taken. We can quite

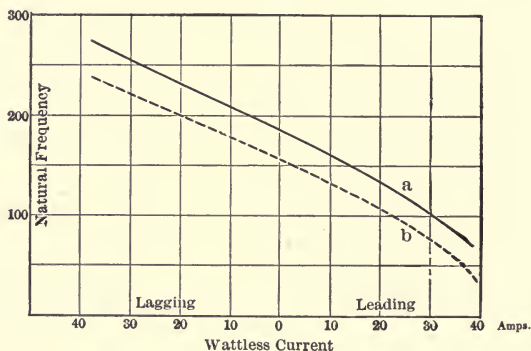

FIG. 61. Natural frequency with full-load energy output.

accurately draw the conclusions that the governing factor is the field excitation for any given terminal voltage.

Thus, for instance, if two similar machines are operated in parallel the probability of hunting is greatest, if the field excitation is such as to cause no cross currents under stable operation. When permitting cross currents by over-exciting one and under exciting the other the likelihood is less, since the machine (whether motor or generator at the time) which has the stronger field excitation has a higher natural period than the other, therefore, no resonance can take place.

TABLE A. FULL-LOAD OUTPUT ( $i = 2\bar{c}$ ).

$i_1$	25	12.5	0	-12.5	-25
$e + ir$	1347	1347	1347	1347	1347
$i_1x$	145	73	0	-73	-145
$n$	1492	1420	1347	1274	1202
$ni_1$	4600	4150	3720	3400	3100
$mi_1$	1485	743	0	-743	-1485
$mi_1 + n$	6085	4893	3720	2657	1615
$ix_0$	217	217	217	217	217
$i_1r$	17	8.5	0	-8.5	-17
$ix_0 - i_1r$	200	208.5	217	225.5	234
$n_1$	1010	1050	1095	1125	1180
$m_0i$	743	743	743	743	743
$m_0i + n_1$	1753	1793	1838	1868	1923
$F$	6380	5700	4150	3245	2510
$\tan \theta$	.289	.367	.495	.702	1.19
$N_1$	238	211	183	153	118

TABLE B. ONE-HALF LOAD OUTPUT ( $i = 12.5$ ).

$i_1$	25	12.5	0	-12.5	-25
$e + ir$	1338	1338	1338	1338	1338
$i_1x$	145	73	0	-73	-145
$n$	1483	1411	1338	1265	1193
$ni_1$	4550	4100	3670	3550	3050
$mi_1$	1483	743	0	-743	-1483
$mi_1 + n$	6040	4920	3670	2807	1583
$ix_0$	108	108	108	108	108
$i_1r$	17	8.5	0	-8.5	-17
$ix_0 - i_1r$	91	100	108	116	125
$n_1$	458	505	545	586	631
$m_0i$	371	371	371	371	371
$m_0i + n_1$	829	876	916	957	1002
$F$	6040	4920	3780	2970	1860
$\tan \theta$	.137	.181	.25	.342	.64
$N_1$	246	215	182	155	114

TABLE C. ONE-HALF LOAD INPUT ( $i = -12.5$ ).

$i_1$	25	12.5	0	-12.5	-25
$e + ir$	1322	1322	1322	1322	1322
$i_1x$	145	73	0	-73	-145
$n$	1467	1395	1322	1249	1177
$ni_1$	4400	3950	3600	3300	3000
$mi_1$	1483	743	0	-743	-1483
$mi_1 + n$	5883	4693	3600	2557	1517
$ix_0$	-108	-108	-108	-108	-108
$i_1r$	17	8.5	0	-8.5	-17
$ix_0 - i_1r$	-125	-117	-108	-100	-91
$n_1$	-630	-590	-545	-505	-458
$m_0i$	-371	-371	-371	-371	-371
$m_0i + n_1$	-1001	-961	-916	-876	-829
$F$	5960	4780	3720	2700	1730
$\tan \theta$	-.17	-.205	-.255	-.342	-.547
$N_1$	221	202	181	157	123

TABLE D. FULL INPUT ( $i = -25$ ).

$i_1$	25	12.5	0	-12.5	-25
$e + ir$	1313	1313	1313	1313	1313
$i_1 x$	145	73	0	-73	-145
$n$	1458	1386	1313	1240	1168
$m i_1$	4385	3940	3555	3250	2990
$m i_1 + n$	1485	743	0	-743	-1485
$i x_0$	5835	4683	3555	2507	1505
$i x_0 - i_1 r$	-217	-217	-217	-217	-217
$i_1 r$	17	8.5	0	-8.5	-17
$i x_0 - i_1 r$	-234	-225	-217	-209	-200
$n_1$	-1180	-1135	-1090	-1045	-1010
$m_0 i$	-743	-743	-743	-743	-743
$m_0 i + n_1$	-1923	-1878	-1833	-1788	-1753
$F$	6140	5050	3990	3080	2310
$\tan \theta$	.33	.4	.516	.713	1.175
$N_1$	223	202	178	152	118

*Some Features of Parallel Operation of Alternating Current Generators.*

With alternators running at uniform speed and with proper field excitation there is practically no cross current, and therefore the current from each machine is the current delivered to

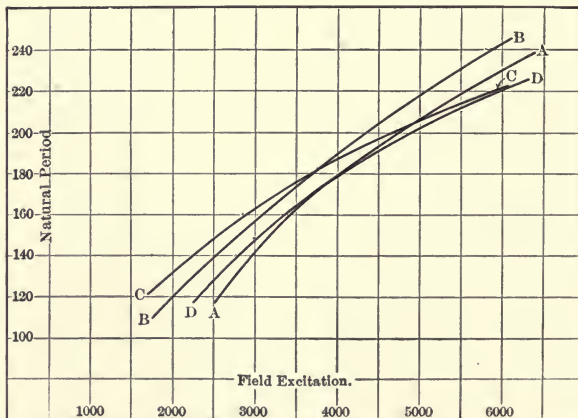

FIG. 62. Field excitation. Natural period of generator or motor.

the lines. This ideal condition is, however, seldom obtained in practice. With almost every direct connected unit there is a slight pulsation in speed, and with the ordinary adjustment of

field rheostats, there is usually a slight cross current, although this cross current is not necessarily detected by the station ammeters.

The effect of pulsating speed is to establish a cross current between the machines, which substantially represents power,

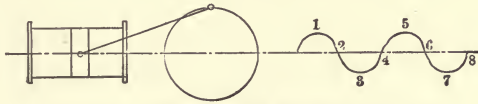

FIG. 63. Pulsations in speed of engine.

while the effect of wrong excitation is a wattless current and a slight mechanical shift of the two machines in reference to each other. This shift will cause considerable cross current in the neutral of the machine, if these are connected together, and this cross current in the neutral represents power. So that it is possible to have power transfer not only by pulsation in speed, but also by wrong excitation, in the latter case chiefly through the third harmonic. In addition to this cross current there is a cross current caused by hunting of the machines, which current also represents power.

*Cross Current Due to Pulsation of Speed.*

Let  $p$  = total per cent variation of speed per revolution, this variation taking place twice per revolution, as seen in Fig. 63.

The speed variation from the average speed is then either



FIG. 64. E.M.F. corresponding to pulsation.

$0.5 p$  high or  $0.5 p$  low in a quarter of a revolution, so that the mean variation in a quarter of a revolution is  $0.25 p$ .

If the generator has  $n_p$  number of poles, we have then the displacement of phase of e.m.f. due to the speed variation

$$= \frac{n_p \times 180}{4} \times \frac{p}{400} = 0.112 n_p \times p \text{ degrees.}$$

If  $E$  is the e.m.f. per phase, then the e.m.f. corresponding to this displacement is  $E \sin (0.112 n_p p)$  (Fig. 64). Therefore, the



total e.m.f. acting in the circuit which is the sum of the e.m.f.'s of each machine is  $2 E \sin (0.112 n_p p)$ . And if  $z$  is the internal impedance in each armature, we get the value of the cross current as:

$$\frac{2 E \sin (0.112 n_p p)}{2 z} = \frac{E \sin (.112 n_p p)}{z} .$$

Usually the ratio of the short circuit current to the full-load current is known and expressed as  $k$ , in which case the pulsating cross current can be written as:

$$k \sin (0.112 P \times p) I .$$

*Instance,* A 40-pole generator with  $k = 3$ , maximum speed variation per revolution = 0.75 per cent =  $p$ , what is the cross current?

Substituting above we get the cross current

$$I_c = 3 \times 0.061 I = 0.183 I .$$

This current practically represents power, since it is in quadrature with the e.m.f. —  $E \sin (112 P_x p)$  — which causes it, which again is in quadrature approximately to the main e.m.f.

#### *Cross Currents Due to Wrong Excitation.*

Such currents are found in the neutral as well as in the mains if similar machines are operated with grounded neutral.

#### *First. Determination of Cross Currents in the Mains.*

Let  $e$  be the no-load e.m.f. of one machine.

Let  $e_1$  be the no-load e.m.f. of the other.

$r - jx$  be the impedance of the first armature.

$r_1 - jx_1$  be the impedance of the second armature.

The current, after parallel connection, is, therefore,

$$i_1 = \frac{e - e_1}{r - jx + r_1 - jx_1} ,$$

or, neglecting the armature resistance and assuming  $x = x_1$ , that is, similar armatures, we get

$$i_1 = \frac{e - e_1}{2 x_0} .$$

Substituting this in the equation previously given of the angular displacement of armatures for various currents, and remembering that  $i=0$

$$\tan \theta = \frac{m_0 i + n_1}{m i_1 + n}$$

we get

$$\tan \theta = \frac{n_1}{\frac{m_0(e - e_1) + n}{2 x_0}}$$

*Example.* Armature reaction =  $R = m_0 i$ , or  $m_0 = \frac{R}{i}$ ,

where  $i$  is full-load power component of the current.

Assume	$n = 3 R$	$e = 1$
	$n_1 = .3 R$	$e_1 = .9$
	$i = 1$	$x_0 = .35$

We then get,

$$i_1 = \frac{0.1}{0.7} = 0.143,$$

therefore the cross current in the main is 14.3 per cent, and the displacement,

$$\tan \theta = \frac{0.3 R}{0.143 R + 3 R} = 0.095, \text{ or } \theta = 5^\circ 30' \text{ approximately.}$$

#### *Second. Cross Current in the Neutral.*

The cross current due to the slight difference in voltage is so small that it can be neglected, but the cross current due to the displacement is quite large and must be essentially a power current as discussed when dealing with cross currents due to variation of angular position.

We found then, that this current is very closely expressed as

$$I_c = \frac{E \sin \theta}{Z}$$

As previously discussed, the cross current between the neutrals of parallel connected alternators is of triple frequency or any odd multiple thereof. Considering at present the triple

frequency current only, the displacement of the armature in reference to this current is obviously three times as large as for the fundamental. Thus,  $\theta_3 = 3 \theta$ .

The impedance  $Z$  is three times as large as the main impedance on account of the higher frequency, but only one third of that value, since the three phases are in parallel, thus  $Z = x_0$  - neglecting the resistance. If the ratio of the triple harmonic to fundamental voltage is  $p_0$  we have then

$$I_c = \frac{p_0 e \sin 3 \theta}{x_0}.$$

Assuming  $p_0 = 0.3$ , which means a triple harmonic of 30 per cent of the value of the fundamental, we get

$$I_c = \frac{0.3 \sin 16^\circ 30'}{0.35} = \frac{0.3 \times .285}{.35} = .245,$$

or the triple harmonic is 24.5 per cent of full-load current.

We see thus, that whereas an ammeter in the mains would only read 14.3 per cent of full-load current, an ammeter in the neutral would read 24.5 per cent.

In other words, an ammeter in the neutral is very sensitive for detecting error in field excitation. Furthermore, it is interesting to note that this current represents substantially  $0.245 \times 0.3 = 0.073$  watts, corresponding with a full-load output of  $1 \times 1 \times \sqrt{3} = 1.73$ , or 4.2 per cent of the output. Therefore 10 per cent difference in excitation meant a transfer through the triple harmonic of 4.2 per cent of the full-load power.

The angular displacement of the armature with load is of greatest importance. Assume, for instance, that two machines of different armature reactions and field excitations are to be rigidly connected to the same prime mover, in order that they shall distribute the load correctly at full load, it is necessary to ascertain this angle in each case and to adjust the armatures in reference to the poles an amount corresponding to the difference in angles.

It is obvious, that although the machines then will distribute the load correctly at full load, at other loads they may not do so. This same question comes up in arranging frequency changing sets where, for instance, 25-cycle motors drive 60-cycle generators.

Should, therefore, two such rigidly connected generators or frequency changers not divide the load properly, the remedy is to shift either of the fields or the armatures relative to each other, though a slight improvement can be made by changing the excitation of the two, over-exciting one and under-exciting the other, in which case, however, there will be large cross currents.

In connection with distributing the load between generators operating in parallel from independent prime movers, it is to be remembered that with direct current units the field excita-

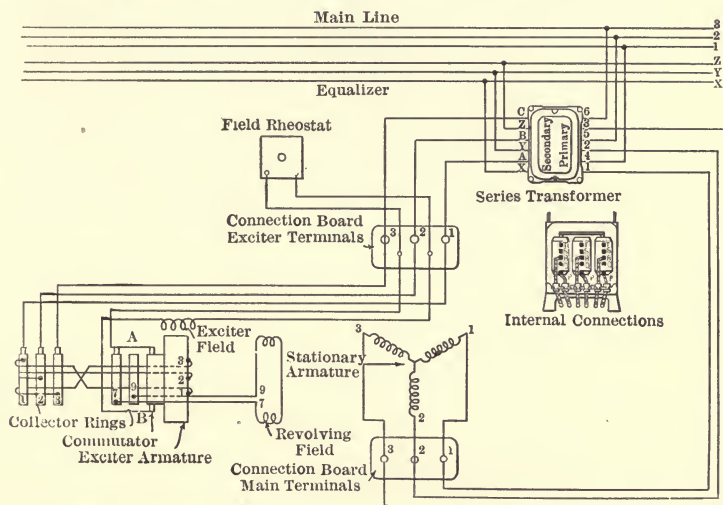

FIG. 65. Diagram of connections of compensated alternator. (Equalizes lines for parallel operation.)

tion will decide the load, whereas, with alternating current generators, the field excitation has no effect, except in the matter of cross current.

The load can only be changed by changing the power admission of the prime mover. Shortly the speed regulation of the prime mover determines the distribution of the load.

#### *Compensated and Self-Excited Alternator.*

As an illustration of the first type, will be given the compensated alternator built by the General Electric Company and invented by E. W. Rice, Jr.

The mechanical arrangement of such machine is given in Fig. 65. It consists of an ordinary alternator to which is geared,

or directly connected, an exciter which runs synchronously with the generator.

The exciter in its general details resembles a synchronous converter, since it has a commutator and at the same time is connected to the alternating current mains with or without the use of series transformers.

The field winding of the alternator is connected to the direct current brushes, and is, therefore, excited by a current proportional to the exciter voltage.

The exciter voltage is determined by both the excitation of the shunt winding and the armature reaction of the alternating current fed from the main alternator to its armature.

The shunt winding is so adjusted that the direct current voltage across the exciter is right for supplying the no-load excitation of the alternator; the alternating current in the winding is so proportioned that its reaction on the exciter field will as nearly as possible give the correct exciter voltage with load on the alternator.

Referring to the previous determination of the proper excitation of an alternator with load:

$F_1$  was the no-load excitation,

and

$F$  the load excitation.

Therefore, the change in excitation with load is

$$= F - F_1.$$

In order to operate satisfactorily, the magnetic circuit of this exciter is so proportioned that throughout a small range the excitation and voltage are proportional.

We can therefore write:

$$\begin{aligned} E_x &= \text{change in exciter voltage with load} \\ &= a (F - F_1) \text{ where } a \text{ is a constant.} \end{aligned}$$

We have then:

$$\begin{aligned} E_x &= a \sqrt{(m_0 i + n_1)^2 + (m i_1 + n)^2} - a F_1 \\ &= a \sqrt{(m_0 i + n_1)^2 + (m i_1 + n)^2} - a \sqrt{(n_1^2 + (m i_1 + n)^2)}. \end{aligned}$$



Assume next that an alternating current

$$I = \sqrt{i^2 + i_1^2}$$

which is proportional to the main current, and either obtained directly or through series transformer, is supplied to the exciter armature.

Its m.m.f. is  $cI \sin(\omega + \phi)$ , and the e.m.f. induced by this m.m.f. is  $bcI \cos(\omega + \phi)$ , where  $b$  and  $c$  are constants,  $c$  depending upon the number of turns per pole of the exciter armature, and  $b$  the ratio between the e.m.f. and corresponding m.m.f.;  $\omega$  depends upon the power factor of the load;  $\tan \omega = \frac{i_1}{i}$  and  $\theta$  is the angle between the field poles of the alternator and exciter.

If at full non-inductive load on the alternator the excitation were the same as at no load,  $\theta$  would be zero and perfect regulation of voltage could be obtained. As it is not the case, the exciter armature is displaced in space in relation to the alternator so as to give the best average results.

*Example.* Assume that it is desired to have perfect regulation at full non-inductive load and a load of 70.7 per cent power factor on the definite pole alternator previously discussed. From previous calculations it has been determined that  $F$  for non-inductive load is 4150, and for 70.7 per cent power factor

$$(i = 25, i_1 = 25) F = 6340 \text{ and that } F_1 \text{ is } 3650.$$

Thus, for non-inductive load,

$$a(4150 - 3650) = bcI \cos \theta,$$

and for 70.7 per cent power factor,

$$a(6340 - 3650) = 2690 a = bcI_1 \cos(45 + \theta).$$

Assume further that the no-load voltage is 100 volts, and that its excitation corresponding thereto is 2000 AT

we get 
$$a = \frac{100}{3650} = 0.0274;$$

that the alternating current is carried directly through the exciter armature without transformer, and that  $b$ , the ratio of e.m.f. and m.m.f. of the exciter, is

$$\frac{100}{2000} = 0.05.$$

We then get  $13.7 = 1.25 c \cos \theta$   
and  $73.7 = 1.768 c \cos (45 + \theta)$ .

Solving these equations on  $c$  and  $\theta$  we get:

$$c = 49.2, \text{ and } \theta = -77^\circ 7'.$$

The armature reaction of the exciter should thus be

$$25 \times 49.2 = 1230 \text{ ampere turns,}$$

and the shift of the armature in reference to the alternator  $77^\circ 7'$ .

By inserting various values of current and power factor in the above equations, it will be found that the voltage control is very close, not only with changes of load, but also with changes of power factor.

#### • *Self-Exciting Alternator.*

One instance of this type of alternator is that invented by Mr. Alexanderson and brought into commercial use within the last couple of years.

This generator in its general characteristics is much like the old self-exciting alternators in which the alternating current is rectified through a two-segment commutator. Whereas in the old type the commutation conditions were far from satisfactory, and the machines would compound only for a load of definite power factor, with Alexanderson's alternator, not only is the commutation very satisfactory, but the machine compounds for loads of any power factor.

The general arrangement of his alternator is shown in Fig. 66.  $A$  is the three phase winding of the machine.  $B$  represents the three phases of an auxiliary armature winding, which consists of a few turns of small wire, which are placed in the slots of the main winding.  $R$  represents three non-inductive resistances connecting the windings to the neutral point. Three series

transformers  $S$  are connected in the main lines of the alternator, the secondaries of which are connected to the resistance in the  $Y$ -connection of the auxiliary winding.  $F$  is the field winding of the alternator, which may be in this type of the ordinary construction; that is, it need not be distributed, but each pole can have one coil.

The commutator has as many segments as there are number of poles, and every alternate segment is connected to one side of the field winding. The terminals of the auxiliary winding

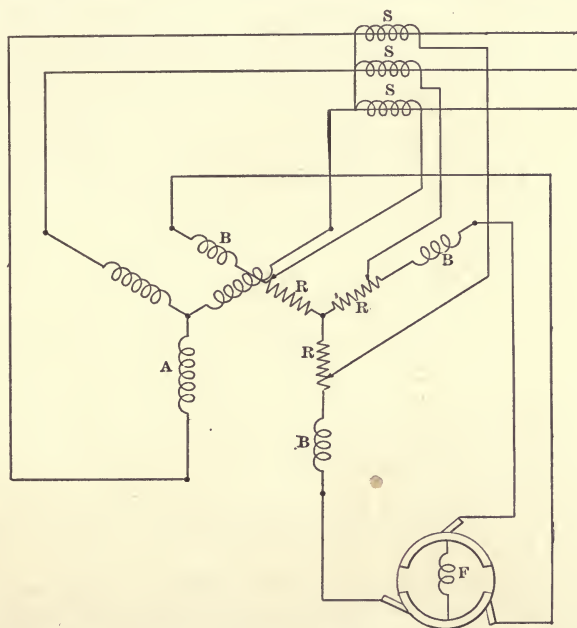

Fig. 66. Diagram of Alexanderson self-excited alternator.

are connected to three brushes, which are placed 120 degrees apart in phase on the rectifying commutator.

The operation of the machine is as follows:—The voltage generated in the auxiliary winding is sufficient to give the full inductive excitation of the machine, and the resistance in series with the winding is so adjusted that the current from the winding to the brushes is right at no load.

With full-load wattless current of the alternator the current in the secondary of the series transformer and its potential

is such that the drop in the resistance, which occurs at no load, is completely compensated for. In other words, although the resistance is in series with the commutator, there is no rotational difference. With full non-inductive load, since the arrangement of the circuits is such that the opposing e.m.f. by the series transformer is displaced  $90^\circ$  from that generated in the auxiliary winding, the resultant drop in the resistance is of some magnitude and, therefore, the exciter voltage is less than at full-load wattless current, but more than at no load. The true relation between excitation at no load, full non-inductive load and full-inductive load is illustrated in Fig. 67, in which

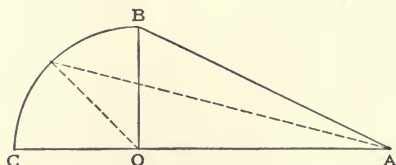

FIG. 67. Self-excited alternator. Excitation diagram.

$AB$  is the excitation at full non-inductive load,  $AC$  the excitation at full-inductive load, and  $AO$  equal to  $AC - OC$  is the no-load excitation.

The circle is the locus for the field excitation for different power factors.

It is evident that the voltage so obtained at the rectifying commutator is correct for proper compounding, since the relation between the no-load ampere-turns and the full non-inductive load ampere-turns are quite closely found by combining the no-load ampere-turns and synchronous impedance ampere-turns at right angles. This corresponds in the diagram, combining  $AO$  and  $OB$ . The full inductive excitation is very closely obtained, if the no-load ampere-turns and the synchronous impedance ampere-turns are directly added. This corresponds in the diagram to the conditions when  $AO$  is added to  $OC$ . The commutation is also good for all loads, since the phase relations at the commutator correspond to that at the alternator.

*Induction Alternator.*

In connection with the extended use of turbo generators which involve generators of very high speed, it is frequently proposed to use the induction type, which lends itself to high speed, since the revolving member can be made of squirrel-cage type, and therefore will be symmetrical and rigid mechanically. There are, however, considerable objections to this type, and therefore it has so far found little application.

The main objection is, that it must be excited from a synchronous alternator, which means, that it cannot be a self-contained unit; it must operate in parallel with other synchronous apparatus.

The second, and often overlooked, objection is that it cannot supply wattless current. Consequently, synchronous apparatus operated in parallel with this type of machine must be of sufficient size not only to supply the excitation to the induction machine, which in volt-amperes might be, say, 30 per cent of the rated output, but also must supply the wattless current of the load of the induction machine. Consequently, where the power factor of the load is relatively low, somewhere around 80 or 85 per cent, it is often not practical to use the induction type of alternator, whereas, if the power factor is in the neighborhood of unity, it ought to have considerable field.

To illustrate this feature the following equations are deduced for the operation of synchronous and induction generators in parallel.

It is assumed that the induction generator is giving its full rated power output. The synchronous generator is then supplying the wattless kilovolt-amperes required for the excitation of the induction generator, and the wattless kilovolt-amperes for the entire load in addition to its power, which then is limited to such value as to keep the current at full-load value.

Let  $i_1$  be the wattless component of the current taken by the induction generator.

$i_2$  the wattless component of the current corresponding to the load on the induction generator.

$i_3$  the wattless component of the current taken by the load on the synchronous generator.



- $i$  the power component of the current supplied by the synchronous generator.  
 $n$  the rated current of synchronous generator.  
 $n_1$  the rated current of induction generator.  
 $p_f$  = power factor of the induction generator.  
 $\cos \theta$  = power factor of the load.

The rating of the induction generator corresponding to its output is  $\frac{n_1}{P_f}$ .

We have then

$$\begin{aligned}
 i_1 &= n_1 \sqrt{\frac{1}{p_f^2} - 1}, \\
 i_2 &= n_1 \sin \theta, \\
 i_3 &= i \tan \theta.
 \end{aligned}$$

Therefore,

$$n = i + j(i_1 + i_2 + i_3),$$

or

$$\begin{aligned}
 i &= \sqrt{n^2 - (i_1 + i_2 + i_3)^2} \\
 &= \sqrt{n^2 - (i_1 + i_2 + i \tan \theta)^2} \\
 &= \sqrt{n^2 - (i_1^2 + i_2^2 + i^2 \tan^2 \theta + 2i_1i_2 + 2i(i_1 + i_2) \tan \theta)},
 \end{aligned}$$

which solved for  $i$  gives

$$i = \frac{\sqrt{n^2(1 + \tan^2 \theta) - (i_1 + i_2)^2 - (i_1 + i_2) \tan \theta}}{1 + \tan^2 \theta}.$$

The per cent maximum output of the rating of the synchronous generator

$$= \frac{100}{n(1 + \tan^2 \theta)} \sqrt{n^2(1 + \tan^2 \theta) - (i_1 + i_2)^2 - (i_1 + i_2) \tan \theta}.$$

The largest possible percentage power output as compared with the rating of the synchronous generator operating in parallel with an induction generator is

For	$\cos \theta = 1.00$	per cent output = 87.5
	= .95	per cent output = 35
	= .90	per cent output = 6
	= .88	per cent output = 0

Thus even with a load of 88 per cent power factor the synchronous generator ceases to be useful in delivering power if its current is limited to its full-load value.

If the synchronous generator is twice as large as the induction generator — with the same power factor of the induction generator — we would have the following relation:

$$\begin{aligned} \text{Cos } \theta &= 1.00 \text{ per cent} = 97 \\ &= .95 \text{ per cent} = 75.2 \\ &= .90 \text{ per cent} = 62 \\ &= .80 \text{ per cent} = 39.9 \end{aligned}$$

Substituting numerical values in the above equation we find, for instance, that when an induction generator having a full-load power factor of 90 per cent is operated in parallel with a synchronous generator of the same rating as the induction generator, the synchronous generator can deliver only a certain fraction of its rating in actual power output, since it must deliver not only the wattless lagging current of the induction generator but also that of the load on the induction generator. So that, if  $\cos \theta = 1.0$ , that is with a load of 100 per cent power factor, its power output can, as a maximum, be only 87.5 per cent of the rating. For a load of 95 per cent power factor the power output can as a maximum be only 35 per cent; with a load having 90 per cent power factor only 6 per cent; and with a load of 88 per cent power factor the whole output of the synchronous generator is taken up by wattless current, so that no power can be delivered.

In its general characteristics the induction generator is very similar to the induction motor, and there are no elements of uncertainty or difficulty in its design. From the well-known theory of the induction motor it ought to be possible to very accurately determine the proper rating, power factor, secondary voltage, for any given speed or load, so that these features will be omitted.

#### *Half Frequency Generator.*

With the introduction of single phase railroading it has been proposed to adopt a new standard frequency of 15 or 12.5 cycles, on account of the advantages derived in the motor characteristics.

If such frequency is adopted, it will be desirable to use a generator which at high speed can give the lowest possible frequency.

With the standard generators the speed, corresponding to 12.5 cycles with a two-polar structure, is 750 revolutions per minute. This speed is satisfactory for very large units, but too low for high steam economy in smaller units.

By the use of a type of machine proposed by Ziehl, Stanley, and others, it is possible to obtain a given frequency with a given number of poles at double synchronous speed.

In its construction the generator is similar to an induction motor the secondary of which has slip rings, so that its circuits can be connected in parallel with those of the primary.

In order to understand its action, it is well to consider the characteristics of an induction motor.

With the rotor running at synchronous speed no e.m.f. is generated, there is no current in the secondary, and the frequency is zero.

With the rotor standing still an e.m.f. is generated in the secondary at impressed frequency, and a current can be supplied as in case of an ordinary transformer.

If now instead of standing still, or revolving in the direction of the magnetic field, the rotor were driven at rated speed but against the direction of rotation of the magnetic field, an e.m.f. of double the value obtained at standstill would be generated in the secondary at double the impressed frequency.

If the secondary was closed through a resistance giving the same current in the previous case, twice as much output would be given at double frequency.

Since the current taken is the same as in the case of the rotor at standstill, it is evident that the power supplied electrically to the primary is the same, therefore the rest of the power must be supplied mechanically in driving the secondary against the revolving field.

If the rotor or secondary is driven at 0.5 synchronous speed against the rotation of the magnetic field, its voltage would be 50 per cent greater than at standstill, and one third of the total power would be given mechanically to the rotor.

In general, if  $f$  = frequency of the supply circuit,  
 $f_1$  = frequency of the secondary,  
 $n_p$  = number of pairs of poles,  
 $S$  = number of revolutions per second of the  
rotor,

we have  $f_1 = f \pm n_p S$ .

+ is used if the mechanical rotation is against the rotation of the revolving field.

-- is used if with the field.

Thus for  $n_p S = + f$  the secondary frequency is  $2f$ ;

for  $n_p S = 0$ ,  $f_1 = f$  the two frequencies are the same;

for  $n_p S = -f$ ,  $f_1 = 0$ ;

that is, when the rotor is running at synchronous speed with the rotation of the magnetic field no frequency exists in the secondary.

For  $n_p S = -2f$ ,  $f_1 = -f$ ,

the frequencies of the primary and secondary are the same numerically, but the revolving field rotates in opposite direction.

By reversing a couple of terminals the primary and secondary phases can be connected in parallel, and the machine becomes a generator in which the power, derived from a mechanical source is converted to electrical power, one half of the power by the stator, the other by the rotor.

Thus in this type of machine, unlike the ordinary type, both elements supply power.

Like the induction generator proper, this is limited to the supply of in-phase current; its magnetizing current and any wattless currents of the load must be supplied by a synchronous generator.

The power factor of a 12.5 or 15-cycle railway system will probably be about 90 per cent; the power factor of the half frequency generator 95 per cent.

The wattless kilovolt-amperes taken with full load on the half frequency generator is, therefore,  $\sqrt{1 - .90^2} + \sqrt{1 - .95^2} = .75$ , or 75 per cent of that delivered to the load.

In other words, the synchronous machines have to be about as large as the induction generators, though the power re-

quired to drive them needs to be very small—just enough to supply the excitation losses.

There is, however, but little objection to connecting the synchronous generators to large turbines since the power delivered by these turbines is directly useful for the load. At the same time, it must be remembered, that the synchronous generators run at one half of the speed of the induction generators, therefore their steam economy is not so good.

#### *Inductor Alternator.*

Before the introduction of the revolving field alternator it was very difficult, and in fact almost impossible, to wind an armature for very high voltages, because of mechanical reasons, since it was recognized that a high voltage winding should be stationary. This probably was one of the chief reasons for the introduction of the inductor type of alternator which has the

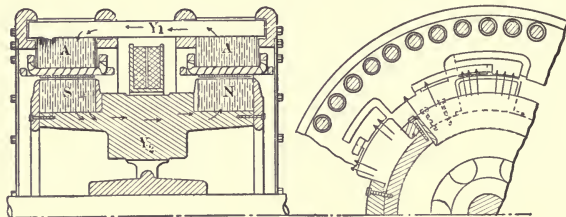

FIG. 68. Inductor alternator.

superiority over the revolving armature type in that the armature winding is stationary.

It has another seeming advantage, which is, that the field winding is stationary; in other words, with this type no revolving wires need exist.

With the introduction of the revolving field alternators, which have the advantage of stationary armature winding, this type met with a serious competitor, and at present time by far the larger number of machines are built of the latter type. The essential difference in the characteristics of the two is that in the inductor type twice as much flux for the same armature reaction is required for a given voltage, which makes a very heavy machine and often considerably more expensive.

The general diagram of such an inductor alternator is given in Fig. 68, which shows the location of the armature coils on



the two halves of the stationary structure and the field coils placed between them. The poles on one side of the machine are all of the same polarity, and the armature coils, therefore, pass from, say, north pole to the place of no flux, then to another north pole, etc., whereas, in the revolving field armature machine, the coils pass from north pole to south pole.

#### *Double Current Generator.*

This type of machine is in its general construction identical with the rotary converter, which will be dealt with more in detail in the second volume.

The armature winding is usually designed so that full output can be obtained either from the direct or the alternating current side, or combined full load of the two. Therefore, there is no compensation of direct current and alternating current in the armature, but the conductors have to be designed for full-load current, therefore their cross section has to be considerably larger than would be the case with the multiphase converter.

To get a good regulation, the armature reaction is made less than with the rotary converter, so that it is always a larger and more expensive machine.

The ratio between the alternating current voltage and the direct current voltage at no load in a three phase double current machine is 0.61, and with a two phase machine 0.71. This ratio changes somewhat with load, due to the internal reactions of the armature.

The potential control and general characteristics can be calculated in identically the same way as in the case of the ordinary alternating current generator.

#### *Synchronizing of Alternators.*

In multiphase alternators it is not sufficient to synchronize one phase only before throwing the machine in parallel by the main switches.

This can be best seen by drawing the waves of e.m.f. of the two alternators and superimposing one set on the other.

An instructive and practical method of studying this is to draw the waves of e.m.f. of the generators on transparent paper and then move one set of waves over the other.

Assume two identical generators one of which revolves clockwise, the other counter-clockwise. The rotation of the phases in the first case may be 1, 2, 3, and the corresponding waves as shown in Fig. 69.

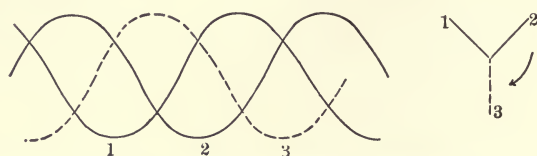

FIG. 69. Synchronizing of alternators.

In the second case the rotation is 1, 3, 2, and the corresponding waves as shown in Fig. 70.

In comparing these two diagrams, we see that phase 1 is not disturbed, but 2 and 3 have exchanged places.

At the same speed, phase 1 of one machine can be synchronized with phase 1 of the other; but if collector rings 2 and 3

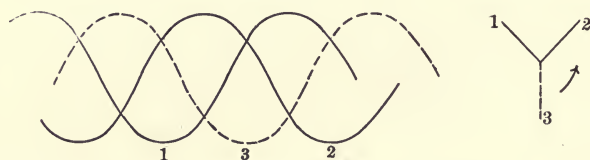

FIG. 70. Synchronizing of alternators.

are connected to 2 and 3 respectively of the other generator a short circuit takes place, since with 1 synchronized the other two phases 2 and 3 of one machine are always at a difference of potential with 2 and 3 of the other.

If, however, we connect collector ring 2 of one machine with

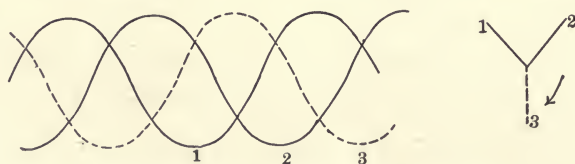

FIG. 71. Synchronizing of alternators.

3 of the other, we see in Fig. 71 that the rotation of phases is the same in the two machines, and they can be synchronized.

By putting diagram 70 over diagram 69 and adjusting them so that phase 1 overlaps phase 1 in the other diagram, we see this very plainly, whereas, after reversing the leads, by putting diagram 71 over 69, we find that if phases 1 coincide, 2 and 3 respectively will also do so.

Several kinds of apparatus are made to show when two generators are in phase, and therefore the switches can be closed. The most common is, perhaps, incandescent lamps wired either to show brightness or darkness at the time of synchronism.

The behavior of such lamps if wired for darkness at synchronous speed is as follows:

First. Phase rotation right.

As the speed and voltage of one machine approach those of the other, the periods of brightness and darkness grow longer

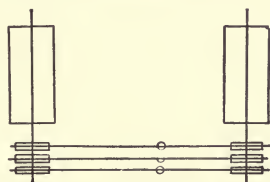

FIG. 72. Synchronizing alternators.

until finally the lamps stay dark, say a couple of seconds, when the switch can be closed.

Second. Phase rotation wrong (to correct reverse two leads).

As the speed and voltage of the two machines approach each other, alternately one after the other of the lamps of one phase will remain dark or very bright, whereas those of the other two phases are rather dim.

This is shown very nicely by moving Fig. 71 or Fig. 70 over Fig. 69. The lamp connection in this case is as shown in Fig. 72.

Obviously one set of terminals could be connected by a wire, when two lamps or sets of lamps would suffice.

#### *Instantaneous Short-circuiting Current Alternator.*

In connection with the synchronizing of alternators a few words may be added about the abnormal momentary rush of current in case of throwing the machines together when out of phase, or short-circuiting them.

At such times the instantaneous rush of current is only limited by the resistance and true reactance of the winding, and reaches readily ten or fifteen times, possibly twenty times, the normal current value. Depending upon the character of the magnetic circuit the time required for dying down to normal short circuit current varies from a fraction of a second to one second.

It is obvious that the  $i^2R$  in the armature, with such currents, is very large, several times the normal output, therefore the torque is very great, and the shaft and windings often subjected to great stresses.

*Wave Shape.* It is safe to say that no commercial alternator ever produces a perfect sine wave of e.m.f., though in some

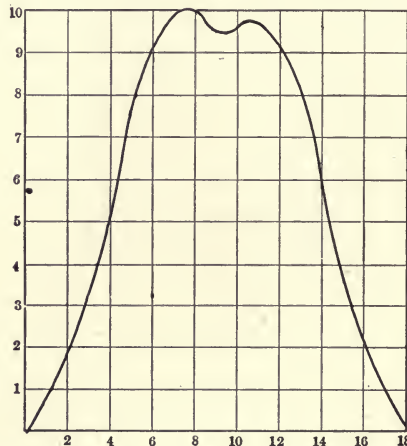

FIG. 73. No-load E.M.F. between neutral and terminal of 12,000 volts revolving field alternator.

cases, notably smooth core machines with carefully shaped poles, a very close approximation is made.

To get a true sine wave, the winding should revolve in a perfectly uniform field.

In commercial machines, almost without exception, the winding is laid in slots, and the distribution of flux is not uniform.

The number of slots and the shape of the poles are largely instrumental in causing the higher harmonics.

With  $n$  slots per pole, harmonics of  $2n \pm 1$  frequency are generated. Thus in a three phase machine with two slots per



pole and phase, the third and the fifth harmonics might be expected in the e.m.f. wave induced per phase, that is, in the  $Y$ -voltage by which is denoted the voltage between neutral and terminal. Of these the third is usually by far the most important.

In connection with the discussion on phenomena in transmission lines was shown how in a three phase generator, whether  $Y$ - or delta-connected, no third harmonic can exist in the line potential.

*Examples of Waves.* Although it is very laborious to analyze a given wave shape and decide the magnitude of each harmonic, in general it is possible to tell at a glance which predominates, since in general sharp peak and flat zero denote third harmonic, also double-peaked wave with sharp zero denotes third harmonic,

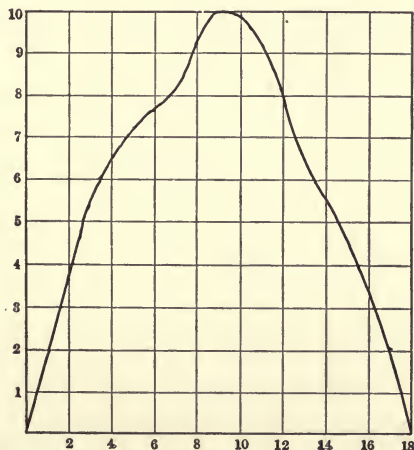

FIG. 74. Partial-load E.M.F. at terminals of same machine.

double peak with flat zero denotes fifth harmonic, also three peaks denote fifth harmonic.

To illustrate clearly the wave shapes under various conditions, a rather more than usual distorted wave of a three phase high voltage 40-cycle generator with two slots per pole and phase is shown.

Fig. 73 shows the no-load e.m.f. per phase, that is, in a  $Y$ -connected machine (as was the case here), the voltage between a terminal and the neutral.



We note that the zero point is flat, and that the top is somewhat flat and has two small peaks, therefore we can conclude that it has some third harmonic — which is to be expected. Fig. 74 gives the terminal no-load e.m.f. We note indications of three peaks, thus the fifth harmonic is prominent; indeed, from the previous reasoning we expected the third to have disappeared.

Fig. 75 shows the e.m.f. per phase at somewhat more than full non-inductive load. We note here also plainly the presence

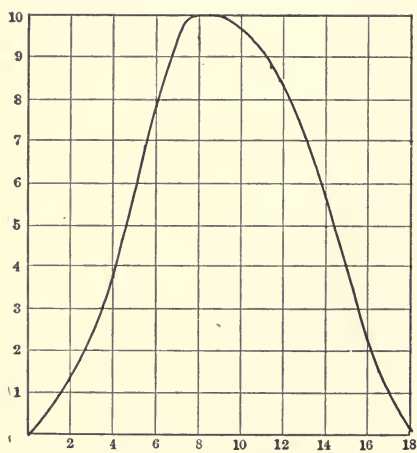

FIG. 75. Full-load E.M.F. between neutral and terminal.

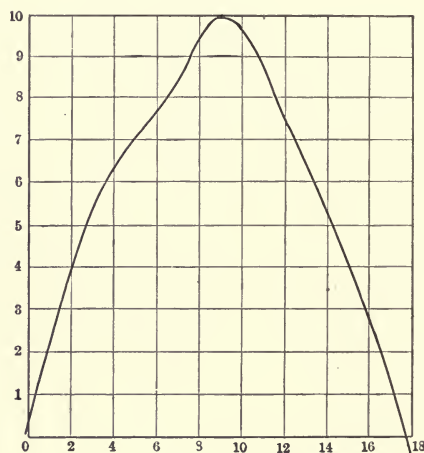

FIG. 76. Full-load E.M.F. at terminals.

of the third harmonic, therefore can conclude, that in general non-inductive load does not materially affect the wave shape.

Fig. 76 shows the corresponding terminal voltage. Here the fifth harmonic is very evident by the steep zero.

An inductive load tends to smooth the wave shape, since the drop in voltage of the higher harmonics is relatively more than of the fundamental. A condenser load taking leading current accentuates the higher harmonics, since these are relatively more increased than the fundamental.

If there were no capacity to ground of the three phases of a Y-connected generator, there could be no current when the neutral point of the winding was grounded.

If, however (as is always the case — especially when the generator is connected to the line), there is some capacity to ground, there will be a current.

This current cannot be of the fundamental frequency, since the capacity effect of the three lines — acting as one to ground — must be zero. It is of triple, ninth, etc. (multiple of three) frequency.

In Fig. 77 is shown the shape of this current wave in the above generator. That it is essentially of triple frequency is apparent, although the distortion due to some still higher harmonic is evident.

To determine this a test was made, in which some inductive reactance was added to the ground connection. Such reactance

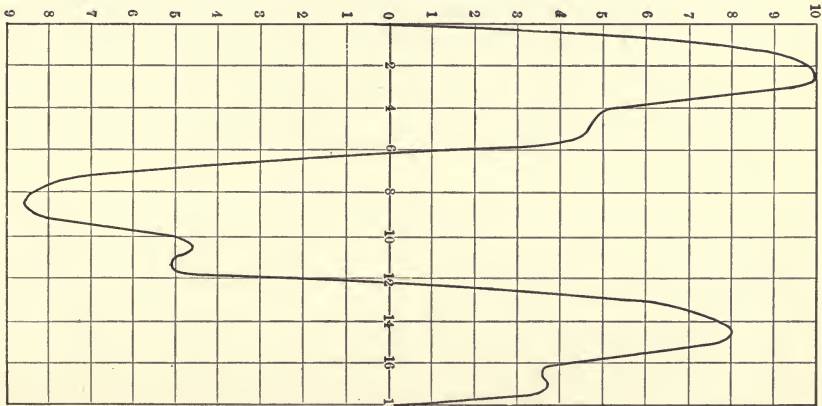

FIG. 77. Current in the neutral.

with the leading ground current should amplify the distortion due to partial resonance.

The potential wave in that case is shown in Fig. 78, from which we see plainly the ninth superimposed on the third.

To conclude the discussion of generators some of the interesting data on modern machines are given below.

Type of Prime Movers.	Engine Reciprocating.		Water Turbine.		Steam Turbine.	
Cycles . . . . .	25	60	25	60	25	60
Arm. diam. per pole about . . . . .	5	3	13	5	20	7.5
Arm. reaction about . . . . .	3200	1800	8300	3200	13,000	4800
No load ÷ arm. reaction . . . . .	2.5	3	2.5	3	2.5	3
Regulation . . . . .	8	6	8	6	8	6
Per cent short circuit current . . . . .	2.50	2.80	2.50	2.80	2.50	2.80

Three general types are in use:

No. 1 with individual poles.

No. 2 with individual poles, having short circuited windings.

No. 3 with round field and distributed field winding.

These give different characteristics:

No. 1 synchronous impedance

ampere turns =  $1.25 \times$  armature reaction,

No. 2 synchronous impedance

ampere turns =  $1.15 \times$  armature reaction,

No. 3 synchronous impedance

ampere turns =  $1.4 \times$  armature reaction,

where synchronous impedance ampere turns represent the ampere turns (from saturation curve) corresponding to the impedance volts with full-load current, as defined previously.

The reason for the lesser impedance ampere turns in the second case probably is that the three phases of the armature meet different magnetic reluctance, therefore one or two are

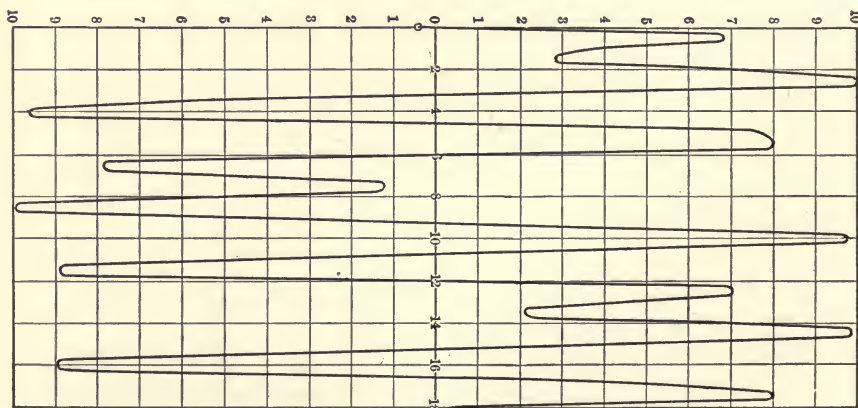

FIG. 78. Potential across reactance in ground connection.

more prominent, and a pulsating reaction takes place which produces currents in the short circuited windings and thereby lowers the self-induction.

The reason for the larger impedance ampere turns in the last case is obviously the lesser magnetic reluctance due to the continuous iron circuit for the cross field.

It is also evident from the above that the self-inductive ampere turns are:

- for No. 1,  $0.25 \times$  armature reaction,  
 No. 2,  $0.15 \times$  armature reaction,  
 No. 3,  $0.40 \times$  armature reaction.

### *Transformers.*

At a glance it would seem that the ordinary transformer is such a simple piece of electrical machinery that there would

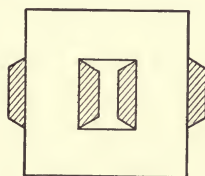

FIG. 79. Single phase core type transformer.

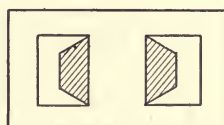

FIG. 80. Single phase shell type transformer.

be few if any difficulties in its design. This is indeed the case, as long as the problem is one of moderate current and voltage.

With large current values, and therefore a number of circuits in parallel, the problem is, however, quite intricate, since for proper distribution of load between the various windings

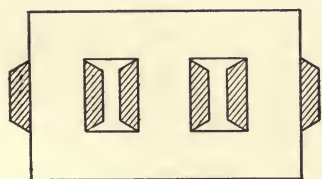

FIG. 81. Three phase core type transformer.

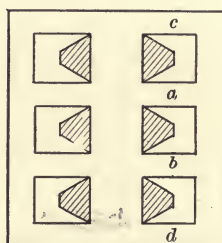

FIG. 82. Three phase shell type transformer.

greatest consideration has to be paid to the question of inductive reactance.

With high voltages the question of insulation and proportions of terminals and connecting wires needs considerable study.

This latter was dealt with in the discussion of insulation under heading "Transmission Line."

The method of determining the inductive reactance is, however, outside the scope of this book.

Single phase and multiphase transformers are built of two types, the core and the shell type.

Fig. 79 gives diagrammatically the construction of the single phase core type.

Fig. 80 gives diagrammatically the construction of the single phase shell type.

Fig. 81 gives diagrammatically the construction of the three phase core type.

Fig. 82 gives diagrammatically the construction of a three phase shell type.

In the core type the magnetic cross section at every place is the same, since the same flux traverses the magnetic structure.

In the shell type the "sides" have one half the cross section of the main core, since the two sides are in multiple in regard to the flux.

This applies in single phase as well as in three phase transformers, though in the latter case the middle phase has to be reversed.

In the case of single phase transformers, it is quite evident how the iron cross sections are determined from the voltage, frequency and number of turns of the windings.

In the three phase core type, the cross section of each main core corresponds, of course, to the flux necessary to give the

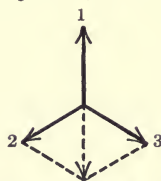

FIG. 83. Resultant E.M.F. core type transformer.

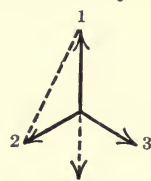

FIG. 84. Resultant E.M.F. shell type transformer.

counter e.m.f. of one phase, but there might be some questions about the proportions of the connecting bars of the three cores.

Since, however, as shown in Fig. 83, in a three phase system the resultant e.m.f. of two phases is always the same as each individual, the connecting bars have to carry the same flux as



the main cores, and therefore should be of the same cross section.

Consider next the shell type transformer. Such transformer of three phase type could obviously be built by three single transformers placed above each other. In that case the connecting bars  $a$  and  $b$  would be of the same cross section as the main cores, whereas the necessary section would be only  $\frac{\sqrt{3}}{2}$  thereof, as shown in Fig. 84.

If, however, the winding of the middle section is reversed, as shown in Fig. 85, then the resultant flux in  $a$  or  $b$  must be due to e.m.f.'s 1-2 and 1-3, or one half of what it would have been in the case with the three single phase transformers placed above each other. Therefore,  $a$ ,  $b$ ,  $c$ , and  $d$  can be made of the same cross section, and each one half of that of the main cores.

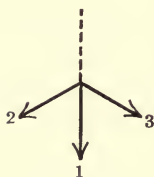

FIG. 85. Resultant E.M.F. shell type transformer (with center winding reversed).

In diagrams 86, 87, 88, and 89 are given the usual connections of single phase transformers for three phase work.

Fig. 86 represents transformers with primaries and secondaries  $\Delta$ -connected.

Each transformer is wound for line potential and  $\frac{1}{\sqrt{3}}$  of line current.

Fig. 87 represents transformers with primaries  $\Delta$ - and secondaries  $Y$ -connected.

The primaries are wound for line potential and  $\frac{1}{\sqrt{3}}$  line current. The secondaries for  $\frac{1}{\sqrt{3}}$  line voltage and full line current.

Fig. 88 represents transformers with primaries and secondaries  $Y$ -connected.

The primaries and secondaries are wound for  $\frac{1}{\sqrt{3}}$  line voltage and full line current.

Fig. 89 represents transformers with primaries  $Y$ -, secondaries  $\Delta$ -connected.

In that case the primaries should be wound for  $\frac{1}{\sqrt{3}}$  of the line voltage and line current, the secondaries for full line voltage, but  $\frac{1}{\sqrt{3}}$  of the line current.

In all these cases the rating of the combinations of the transformers is the same as the sum of the individual ratings.

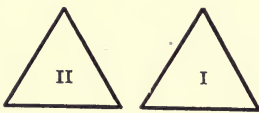

FIG. 86. Transformer connections.

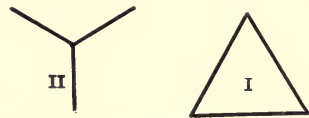

FIG. 87. Transformer connections.

Fig. 90 shows the  $T$ -connection in three phase system.

The voltage of one transformer  $cd$  is the full line voltage, and the current capacity obviously the line current.

For the other transformer the voltage  $ab$  is  $\frac{\sqrt{3}}{2} = 0.866$  of line voltage and the current rating corresponding to the line

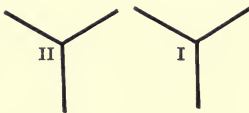

FIG. 88. Transformer connections.



FIG. 89. Transformer connections.

current. The sum of the kw. ratings of the two transformers is therefore:

$$ei + 0.866 ei = 1.866 ei,$$

whereas the three phase power corresponding to the current and voltage is

$$\sqrt{3} ei = 1.73 ei.$$

Therefore, the combined rating is only 92 per cent of the sum of the individual ratings. In other words, for the same output,

this connection requires 8 per cent more transformer capacity than any of the previous combinations. (As a rule the transformers are made interchangeable, so that the actual rating is 16 per cent greater than the output.)

In the open delta (Fig. 91) connection, each transformer has full line potential and carries line current. Therefore, the total rating is  $2ei$ , whereas the three phase output is  $\sqrt{3}ei$ . This connection requires, therefore, 15 per cent more transformer

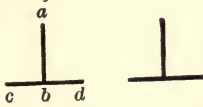

FIG. 90. Transformer connections. FIG. 91. Transformer connections.

capacity than corresponds to the output. But if this connection is forced by the burning out of one of the three delta-connected transformers the rating of the set can obviously only be  $.85 \times \frac{2}{3}$  or 57 per cent of what the combination previously gave.

With the two phase system two transformers are used, and the rating of each is one half of the total output whether the phases are independent or connected for a three wire network.

*Two Phase, Three Phase Transformation by T-Transformers.*

For the sake of simplicity the ratio of transformation will be assumed to be 1: 1.

The main transformer  $ab, a_1b_1$ , Fig. 92, is wound for line potential in the primary as well as the secondary. The "teazer"

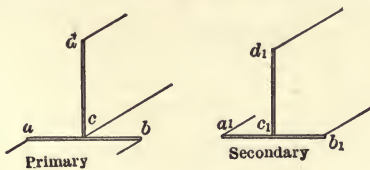

FIG. 92. Two phase, three phase transformation.

transformer  $cd, c_1d_1$ , has its primary wound for line potential, but its secondary for 86.6 per cent of the line voltage.

Assuming an efficiency of 100 per cent in this and the follow-

ing cases we have, if the two phase current is denoted as  $i_2$ , a three phase current of

$$\frac{2 e i_2}{\sqrt{3}e} = 1.16 i_2.$$

Therefore, the rating of the primaries is  $2 e i_2$ , and the rating of the secondaries

$$0.866 e \times 1.16 i_2 + e \times 1.16 i_2 = 2.16 e i_2.$$

Therefore, the cost rating is

$$\frac{4.16 e i_2}{2} = 2.08 e i_2.$$

In other words, the transformer capacity is  $\frac{2.08}{2} = 1.04$  times the output — 4 per cent greater than the output.

For the sake of interchangeability of the two transformers, they are, however, made 16 per cent greater than the output.

#### *Compensators.*

In transforming over a small range of voltages a compensator will be found decidedly cheaper than a transformer, the reason being, that the same winding is used for both primary and secondary current.

The rating of a transformer depends upon its full-load current and its voltage. At full load the primary and secondary currents are so nearly in opposition that in this discussion they can be considered so.

Let

$e$	= primary e.m.f.,
$i$	= primary current,
$e_1$	= secondary e.m.f.,
$i_1$	= secondary current.

We have then

$$ei = e_1 i_1, \quad \text{or} \quad i_1 = \frac{e}{e_1} i.$$

By referring to Fig. 93 it is seen, that in winding  $bc$  we have

the primary current  $i$ . In winding  $ab$  we have the difference between the primary and secondary current. Thus

$$i - i_1 = i \left( 1 - \frac{e}{e_1} \right) = \frac{e_1 - e}{e_1} i.$$

We have, therefore:

Winding  $bc$  should have sufficient number of turns for  $e - e_1$

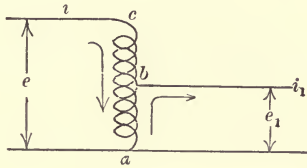

FIG. 93. Single phase compensator.

volts, and sufficient current carrying capacity for  $i$  amp. Thus the rating of section  $bc$  is

$$(e - e_1) i.$$

Similarly the rating of section  $ab$  is found

$$e_1 \frac{e_1 - e}{e_1} i = (e_1 - e) i = - (e - e_1) i.$$

In other words, section  $bc$  acts as the primary to section  $ab$ . The rating as transformer is, therefore,

$$i (e - e_1),$$

and percentage cost rating of a compensator and a transformer is

$$\frac{i (e - e_1)}{ie} = \frac{(e - e_1) 100}{e}.$$

For	$e_1 =$	10 per cent,	the rating is =	90 per cent.
	$=$	25	$=$	75 " "
	$=$	50	$=$	50 " "
	$=$	75	$=$	25 " "
	$=$	90	$=$	10 " "
	$=$	100	$=$	0 " "



We see from this, that where there is a slight change in voltage there is a very great advantage in the use of a compensator.

If, however, the secondary voltage is only, say, 10 per cent of the primary, there is very little to be gained. There is indeed a disadvantage in such cases, since the entire winding has to be insulated for the highest voltage.

*Two Phase, Three Phase Transformation by Means of Compensators and T-Connection.*

Fig. 94. Transformation from a lower two phase voltage to

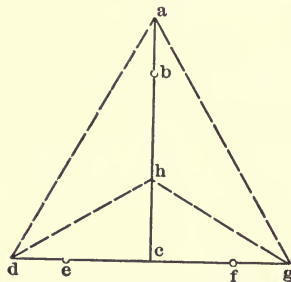

FIG. 94. Compensator transformation from lower two phase to higher three phase voltage.

a higher three phase voltage, or transformation from a higher three phase voltage to a lower two phase voltage.

- Let
- $i_3$  = three phase line current,
  - $e_3$  = three phase line voltage,
  - $i_2$  = two phase current,
  - $e_2$  = two phase voltage.

Assuming no losses in the transformation, we have then

$$\sqrt{3} i_3 e_3 = 2 i_2 e_2 \dots \dots \dots A$$

In section *ab* of compensator *ac* the current is  $i_3$  and the voltage is  $0.866 e_3 - e_2$ . Therefore the rating is

$$i_3 (0.866 e_3 - e_2) \dots \dots \dots B$$

In section *bh* (*h* being located at  $\frac{2}{3} ac$  from *C*), the two phase and three phase currents are in complete opposition. Thus

the current is  $i_2 - i_3$ . Voltage  $bh = e_2 - \frac{1}{3} 0.866 e_3 = e_2 - 0.288 e_3$ . Therefore, the rating of  $bh$  is

$$(i_2 - i_3) (e_2 - .288 e_3) \dots \dots \dots C$$

Since the two three-phase currents from  $d$  and  $g$  are 120 degrees apart, their resultant is equal to each and in phase with  $ac$ .

The resultant current in  $hc$  is, therefore,  $i_2 - i_3$ , and the voltage across  $hc = \frac{1}{3} \times 0.866 e_3 = 0.288 e_3$ . The rating of  $hc$  is, therefore,

$$0.288 e_3 (i_2 - i_3) \dots \dots \dots D$$

The current in  $de$  is  $i_3$ , and the voltage  $\frac{e_3 - e_2}{2}$ . The rating

of  $de$  is therefore  $\frac{i_3 (e_3 - e_2)}{2}$ . In a similar way the current in

$fg$  is  $i_3$ , the voltage of  $fg = \frac{e_3 - e_2}{2}$ , and the rating  $fg = \frac{i_3 (e_3 - e_2)}{2}$ .

Thus rating of

$$de + fg = i_3 (e_3 - e_2) \dots \dots \dots E$$

The current in  $ef$  is the resultant of the two phase and three phase currents which are displaced 150 degrees. The resultant current in  $ef$  is, therefore,

$$\sqrt{(i_2 - i_3 \cos 30^\circ)^2 + i_3^2 \sin^2 30^\circ}$$

The voltage is  $e_2 -$ . Thus the rating of  $ef$  is

$$\sqrt{e_2 (i_2 - i_3 \cos 30^\circ)^2 + i_3^2 \sin^2 30^\circ} \dots \dots \dots F$$

*Example I.* Transformation by compensators of 100 kw. two phase power at 2000 volts, to three phase power at 3000 volts. We have then:

$$\begin{array}{ll} e_2 = 2000 \text{ volts.} & e_3 = 3000 \text{ volts.} \\ i_2 = 25 \text{ amps.} & i_3 = 19.25 \text{ amp.} \end{array}$$

Current in  $ab = i_3 = 19.25$  amp.

Voltage  $ab = .866 e_3 - e_2 = 600$  volts.

Kilovolt-ampere section  $ab =$  (see  $B$ )  $= 19.25 \times 600 = 11,500 \dots \dots \dots G$

Current in  $bc = i_2 - i_3 = 25 - 19.25 = 5.75$  amp.

Voltage  $bc = e_2 - .288 e_3 + .288 e_3 = e_2 = 2000$ .

Kilovolt-ampere  $bc = 11,500 \dots \dots \dots H$

Current in  $de$  and  $fg = i_3 = 19.25$  amp.  
 Voltage  $e_3 - e_2 = 1000$   
 Kilovolt-ampere in  $gf$  and  $de = 19,250 \dots \dots \dots J$   
 Current in  $ef = \sqrt{(25 - 19.25 \times 0.866)^2 + 19.25^2 \times \frac{1}{4}} = 12.67$  amp.  
 Voltage in  $ef = e_2 = 2000$ .  
 Kilovolt-ampere in  $ef = 25,340 \dots \dots \dots J$

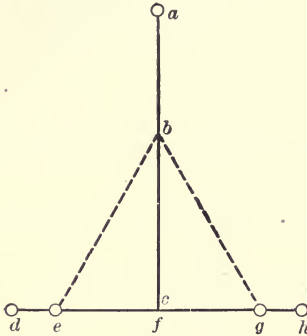

FIG. 95. Compensator transformation from lower three phase to higher two phase voltage.

Therefore, total cost rating of both compensators is  $11,500 + 11,500 + 19,250 + 25,340 = 67,600$ , or the transformer rating is  $33,800$  watts, being always one half of the compensator rating since with compensators there are no secondaries.

In Fig. 95 is shown diagrammatically a transformation from a higher voltage two phase system to a lower voltage three phase system, or from a lower three phase system to a higher voltage in the two phase system.

Current in  $ab = i_2$ .  
 Voltage in  $ab = e_2 - 0.866 e_3$ .  
 Rating  $ab = i_2 (e_2 - 0.866 e_3) \dots \dots \dots K$   
 In a similar way is found the rating  $bc = (i_3 - i_2) 0.866 e_3 \dots \dots \dots L$   
 Current in  $de = i_2$ .

Voltage in  $de = \frac{e_2 - e_3}{2}$ .  
 Rating of  $de + gh = i_2 (e_2 - e_3) \dots \dots \dots M$   
 Voltage  $eg = e_3$ .  
 Current in  $eg = \sqrt{(i_3 \cos 30 - i_2)^2 + i_3^2 \sin^2 30}$ .  
 Rating  $eg = e_3 \sqrt{(i_3 \cos 30 - i_2)^2 + i_3^2 \sin^2 30} \dots \dots \dots N$

Example II. Two phase 3000 volts to three phase 2000 volts, 100 kw.

We have then:

$e_2 = 3000$ volts.	$e_3 = 2000$ volts.
$i_2 = 16.7$ amp.	$i_3 = 28.9$ amp.

Current in  $ab = i_2 = 16.7$ .  
 Voltage in  $ab = e_2 - 0.866 e_3 = 3000 - 1730 = 1270$ .  
 Rating  $ab = 16.7 \times 1270 = 21,200$  kv.-amp. . . . . *O*  
 Current in  $bc = i_3 - i_2 = 28.9 - 16.7 = 12.2$ .  
 Voltage  $bc = 0.87 e_3 = 1730$ .  
 Rating  $bc = 21,200$  kv.-amp. . . . . *P*  
 Current in  $de$  and  $gh = i_2 = 16.7$ .  
 Voltage in  $de$  and  $gh = e_2 - e_3 = 1000$ .  
 Rating  $de$  and  $gh = 16,700$  kv.-amp. . . . . *Q*  
 Current in  $eg = \sqrt{(i_3 \cos 30 - i_2)^2 + i_3^2 \sin^2 30} = 16.7$ .  
 Voltage  $eg = e_3 = 2000$ .  
 Rating  $eg = 33,400$  kv.-amp. . . . . *R*  
 Total kv.-amp. = 92,500.  
 Or transformer rating 46,250 watts.

For the same two phase as three phase line voltage we can apply equations *K, L, M, N, or B, C, D, E*.

Substituting, therefore, we get:

For  $e_2 = e_3 = 3000$  volts.  
 $i_2 = 16.7$  amp.  
 $i_3 = 19.3$  amp.

Current in  $ab = i_2 = 16.7$ .  
 Voltage  $ab = 0.134 e_2 = 402$ .  
 Rating  $ab = 6700$  kv.-amp.  
 Current in  $bc = 19.3 - 16.7 = 2.6$ .  
 Voltage  $bc = 0.866 \times 3000 = 2600$ .  
 Rating  $bc = 6700$  kv.-amp.

$de$  is then = 0.

Current in  $eg = i_3 \sin 30 = 9.65$  amp.  
 Voltage  $eg = e_3 = 3000$ .  
 Rating = 29,000 kv.-amp.  
 Total rating = 6700 + 6700 + 29,000 = 42,400.  
 Or transformer rating 15,100, or 21.2 per cent of the output.

*Series Connection of Transformers.*

Fig. 96. Since the voltage of a transformer depends directly upon the magnetizing current, and with series connection the same magnetizing current passes through both trans-

formers, it is evident that the voltages across each transformer are inversely as their magnetizing currents. This

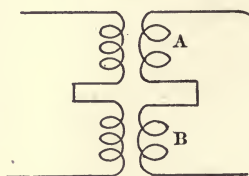

FIG. 96. Series connected transformer.

assumption is permissible over a fair range of voltage.

Thus,

Let  $i$  be the magnetizing current of  $A$  (Fig. 96) for voltage  $e$ ,  
 $i_1$  be the magnetizing current of  $B$  for voltage  $e$ ,  
 and  $I$  be the magnetizing current when the two are connected  
 in series at a total voltage  $E$ .

The open circuited impedance of  $A$  is  $\frac{e}{i}$ .

The open circuited impedance of  $B = \frac{e}{i_1}$ .

Therefore, the voltage across  $A = \frac{e}{i} \times I$ .

Therefore, the voltage across  $B = \frac{e}{i_1} \times I$ .

Thus,

$$Ie \left( \frac{1}{i} + \frac{1}{i_1} \right) = E.$$

The per cent voltage across  $A$  is

$$\frac{\frac{e}{i} I \times 100}{Ie \left( \frac{1}{i} + \frac{1}{i_1} \right)} = \frac{100}{i \frac{(i + i_1)}{i_1}} = \frac{100 i_1}{i + i_1},$$

and the per cent voltage across

$$B = \frac{100 i}{i + i_1} \text{ of full-load value.}$$



*Example.* Magnetizing current of  $A = 5$  per cent = 0.05.  
 Magnetizing current of  $B = 6$  per cent = 0.06.

We have then per cent voltage of  $A = \frac{5}{0.11} = 0.455$ .

per cent voltage of  $B = .545$ .

Thus, if the transformer were designed for 0.5 volt, one would run 10 per cent above, the other 10 per cent below, normal density.

This relation of voltages remains practically the same with load.

*Parallel-connected Transformers.*

Fig. 97. In this case the voltage across each is of course the same, being the line potential, but with different reactance the load will differ.

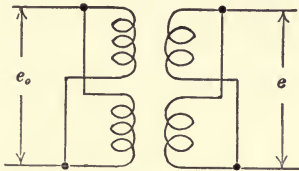

FIG. 97. Parallel connected transformer.

- Let  $e_0$  (Fig. 97) be the primary voltage.
- $e$  be the secondary voltage.
- $i + ji_1$  current in one transformer.
- $i_0 + ji_{01}$  current in the other.
- $r - jx$  impedance of one transformer.
- $r_1 - jx_1$  impedance of the other.

We have then

$$e_0 = e + (i + ji_1)(r - jx)$$

$$= e + (i_0 + ji_{01})(r_1 - jx_1),$$

$$\text{or } (i + ji_1)(r - jx) = (i_0 + ji_{01})(r_1 - jx_1) \text{ or } ir - ijx + i_1jr + i_1x$$

$$= i_0r_1 - i_0jx_1 + i_{01}jr_1 + i_{01}x_1$$

Thus  $ir + i_1x = i_0r_1 + i_{01}x_1,$   
 and  $ix - i_1r = i_0x_1 - i_{01}r_1.$

Neglecting the resistance of the transformer, we get:

$$ix = i_0x_1$$

and  $i_1x = i_{01}x_1,$

or the current is divided inversely at the reactances.

The theory of reactive coils, constant current and constant power transformers belongs properly to the third section dealing with receiving apparatus and is, therefore, given in the second volume.

#### *Losses in Transformers.*

Some years ago, when high frequency alternators of unitooth construction were largely used, the iron losses were determined by wattmeter measurements with current supplied from such generators.

Within the last few years, wave shapes closely resembling sine waves are being almost entirely used, and indeed are stipulated by the recommendation of the American Institute of Electrical Engineers in such tests.

It was found that with true sine wave the core loss was greater than with the old waves obtained in unitooth machines. This can be explained as follows: Assume first a sine wave of impressed e.m.f. The flux and the transformer voltage must then also be a sine wave. The current causing this flux is larger during the time of increasing density than during the time of decreasing density, due to well known properties of iron.

The current wave is, therefore, not symmetrical, but indeed



FIG. 98. Exciting current of single phase transformer with impressed sine wave of e.m.f.

very distorted, the most prominent harmonic being the third. Such current is shown in Fig. 98. If an e.m.f. containing a pronounced triple harmonic of predetermined value and phase were supplied to a transformer, the exciting current could be a sine wave.

The hysteresis loss depends upon the wave shape of the impressed e.m.f. Comparing the losses due to two different wave

shapes of e.m.f.,  $A$  and  $B$  of the same effective value, we have:  $\frac{\text{loss due to } A}{\text{loss due to } B} = \left( \frac{\text{area enclosed by e.m.f. wave of } A}{\text{area enclosed by e.m.f. wave of } B} \right)^{1.6}$  as is seen from the following reasoning:

$$E = k \frac{dM}{dt}$$

Thus

$$Edt = kdM$$

and

$$Et = kM.$$

$Et$  represents the area of the e.m.f. wave and the hysteresis loss is proportional to the 1.6 power of the flux. The eddy current losses are not affected by the wave shape. This same relation between wave shape of e.m.f. and hysteresis loss can also be stated as follows:

The hysteresis loss is inversely proportional to the 1.6 power of the form factor, the form factor being the ratio of effective to average e.m.f.

A very instructive set of oscillograms of the wave shapes of exciting current and e.m.f. in a number of transformer combina-

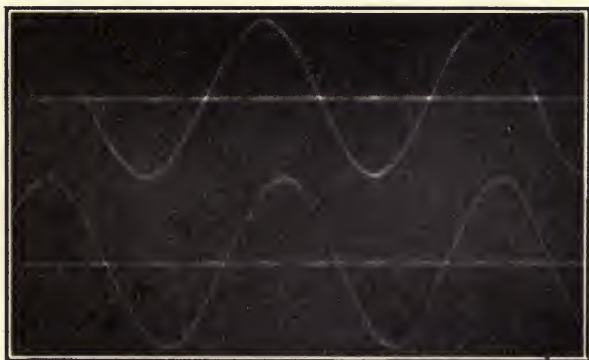

FIG. 99.  $Y$ -connected generator e.m.f. Upper wave terminal e.m.f. Lower wave e.m.f. per phase.

tions were taken some time ago, which gives as nearly as practical a sine wave of e.m.f. between the lines, as seen in Fig. 99.

Three single phase 60-cycle transformers, each of 75 kw. capacity, were experimented with, these large transformers

being used so that the exciting current would constitute a reasonable load on the generator. All tests were taken at substantially the same voltage per transformer.

First test. Transformers delta-connected.

Fig. 100 gives the oscillogram of the transformer current

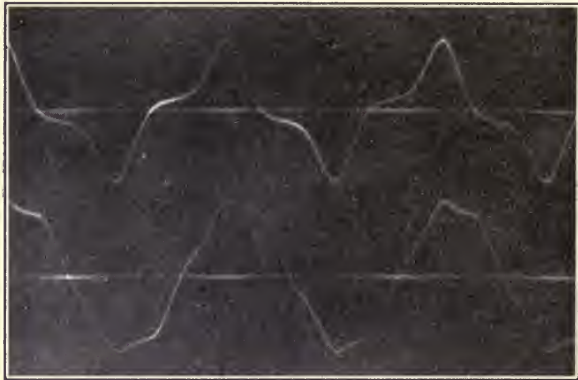

FIGS. 100 and 101. Exciting current of delta-connected transformers. Upper curve, transformer current. Lower curve, line current.

which in this case was 8.8 amp. and contained, as can be seen from the shape, a triple harmonic.

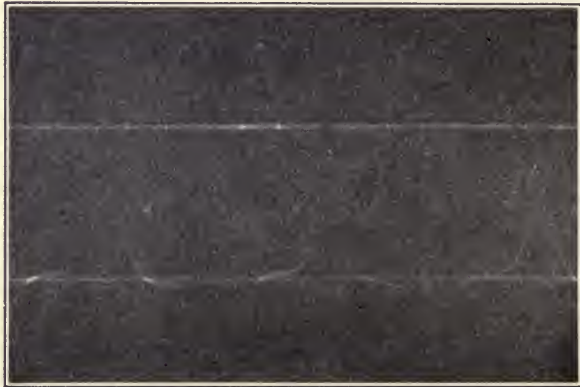

FIG. 102. Y-connected transformers with neutral brought to generator. Upper curve, neutral current. Lower curve, exciting current.

Fig. 101 shows the corresponding line current of 14.2 amp. Comparing Fig. 100 and Fig. 101, we see in the first case a



sharp peak and a flat zero which denotes a triple harmonic, whereas in Fig. 101 we have a wave of the line current which we know does not contain any triple harmonic.

It is interesting to note that the ratio of line current to transformer current is 1.61, whereas with sine wave we would have found 1.73. The reason is that in the transformer current is included the short-circuited triple harmonic, which does not appear in the line.

With *Y*-connected transformers and the neutral brought back to the generator, the wave of the line current is found in Fig. 102, which again shows the triple harmonic. In fact, this



FIG. 103. *Y*-connected transformer, neutral not connected to generator. Upper wave is the transformer voltage. Lower wave, the transformer and line current.

gives the exciting current of a single phase transformer, for obvious reasons. The line current here is 10.2 amp. and the neutral current 12.2 amp.

With *Y*-connection and the neutral insulated the transformer voltage, current and line current are shown in Fig. 103. In this case there is no evidence of a triple harmonic, but the fifth is prominent. The current is 5.3 amp. as compared with 8.8 amp. for the same voltage with delta-connection and 10.2 amp. with four wire system.

Neglecting the distortion of wave shape these currents should have been the same. We see from this, that the exciting current depends to no small degree upon the connections used, and varies almost 100 per cent.



The smallest value is 5.3 amp. Under that condition a sine wave e.m.f. is impressed. There can be no triple harmonic current, therefore the flux must contain a triple harmonic. The effective value of the corresponding e.m.f. is higher for the same maximum flux than with a sine wave, therefore the core



FIG. 104. The triple harmonic exciting current in the neutral of Y-connected transformers.

loss and magnetizing current are less, and a small exciting current should be expected.

With four wire, Y- or with delta-connection the exciting current contains the triple harmonic. The magnetic density for the same voltage is higher, therefore the exciting current and core loss are greater than in the former case. In the former

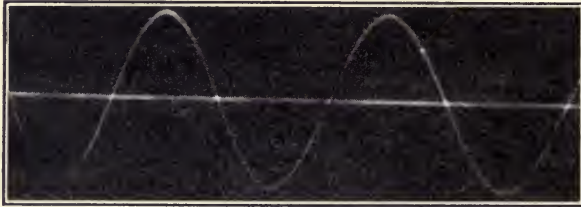

FIG. 105. Transformer voltage with delta-connected transformers or Y-connected transformers with neutral brought to generator.

case the triple harmonic returns to the generator, in the latter it circulates in the transformer windings.

The neutral current in the case of a four wire Y-connection is given in Fig. 104. Its magnitude is 12.2 amp., therefore the triple harmonic of each transformer is one third thereof or 4.1 amp.

Comparing now the voltages, with the delta-connection or four wire Y-connection, where there can be a triple harmonic current, the transformer voltage is practically a sine wave, as shown in Fig. 105. With three wire Y-connection, however,

transformer voltage contains a very decided triple harmonic, as seen in Fig. 106.

Tabulating the core loss and the exciting currents for the same transformer voltage, we have:

Connection.	Delta.	Y.	Grounded Y.
Transformer current, amperes . . .	8.8	5.3	10.2
No-load watts . . . . .	480	350	500

### *Efficiency.*

Since a transformer is a translating device which changes a certain voltage and current to another voltage and current, its losses and efficiency should be based upon kilovolt-amperes and not upon the actual power output.

With full load is always meant full-load current at rated voltage. Therefore, at, for instance, half load and a load power



FIG. 106. Transformer voltage with Y-connection and insulated neutral.

factor of 50 per cent, we have the same losses and efficiency as at full load, though in other machinery, when referring to the power output the efficiency would have been less.

Assume at full load a total loss of 5 per cent. The efficiency is then

$$\frac{1}{1 + .05} = 0.952,$$

whereas at half load and a power factor of 50 per cent it would be

$$\frac{0.5}{0.5 + 0.05} = 0.908.$$

Obviously this latter efficiency means nothing in judging the efficiency of the transformer to do its duty, that is, to translate a given kv.-amp. to another. Full load must mean full-load current, half load, half load current, etc. Therefore the power factor of the load has nothing to do with the transformer efficiency.

Let  $a$  be the  $I^2R$  loss (primary, secondary, and eddies in the copper).

$b$  be the iron loss (eddies and hysteresis).

$\eta$  be the efficiency.

$W$  be the rated kilovolt-amp. of the transformer.

$p$  be the load.

We have then

$$\eta = \frac{\text{output}}{\text{input}} = \frac{p a}{W + a + b} \text{ at full load,}$$

or in general

$$\eta = \frac{pW}{pW + p^2a + b} \dots \dots \dots (1)$$

Instance:  $W = 1$   
 $a = 0.02$   
 $b = 0.02.$

$p.$	$pW.$	$p^2a.$	$b.$	$\eta.$
2.0	2.0	0.08	0.02	0.952
1.0	1.0	0.02	0.02	0.962
0.5	0.5	0.005	0.02	0.953
0.25	0.25	0.00125	0.02	0.925
0.1	0.1	0.0002	0.02	0.833

As a fair approximation the efficiency can also be written as

$$\eta_1 = \frac{pW - \text{losses}}{pW} = 1 - \frac{\text{losses}}{pW} = 1 - \frac{p^2a + b}{pW} \dots \dots (2)$$

Using this equation the efficiency would be as follows:

$p.$	$pW.$	$p^2a$	$b$	$\eta.$
2.0	2.0	0.08	0.02	0.95
1.0	1.0	0.02	0.02	0.96
0.5	0.5	0.005	0.02	0.95
0.25	0.25	0.00125	0.02	0.915
0.1	0.1	0.0002	0.02	0.80

This method gives somewhat large values.

Equation (2) can also be written as:

$$\eta_1 = 1 - p \frac{a}{W} - \frac{1}{p} \frac{b}{W}.$$

Therefore, if at full load the percentage  $I^2r$  is  $m$  and the percentage core loss is  $n$ , we get for any load the efficiency

$$\eta = 1 - pm - \frac{n}{p} \dots \dots \dots (3)$$

Thus for

$p.$	$pm.$	$\frac{n}{p}.$	$\eta.$
2.0	0.04	0.01	0.95
1.0	0.02	0.02	0.96
0.5	0.01	0.04	0.95
0.25	0.005	0.08	0.915
0.1	0.002	0.2	0.80

The  $I^2r$  losses are determined directly from the currents and resistances of the windings. The eddies in the copper are so small that for commercial transformer investigations they can be neglected.

The core loss is taken by exciting the transformer from a generator giving as nearly as is practical a sine wave of e.m.f., reading the watts input with open circuited secondary for various impressed voltages.

The variations of core loss can be assumed as the square of the voltage, though, depending upon the relative amount of hysteresis and eddies, it may vary from the 1.6 power to the square.

Thus the core loss is increased practically 20 per cent by increasing the voltage 10 per cent.

*Regulation of Transformers.*

Let  $e$  be the secondary e.m.f.

$i + j i_1$  the load current (the magnetizing current is neglected here).

$r$  = combined primary and secondary resistance, reduced to the primary (the secondary resistance is multiplied by the square of the ratio of the voltages).

$x$  = the combined reactance as obtained from test.

$e_1$  = the primary voltage.

We have then

$$\begin{aligned}
 e_1 &= e + (i + j i_1) (r - j x) \\
 &= e + ir + i_1 x - j (ix - i_1 r)
 \end{aligned}$$

or

$$e_1 = \sqrt{(e + ir + i_1 x)^2 + (ix - i_1 r)^2} \dots \dots \dots (4)$$

Therefore, the voltage regulation at load is

$$\frac{e_1 - e}{e_1} = 1 - \frac{e}{e_1} = 1 - \frac{e}{\sqrt{(e + ir + i_1 x)^2 + (ix - i_1 r)^2}}$$

Thus the regulation at full non-inductive load is

$$1 - \frac{e}{\sqrt{(e + ir)^2 + i^2 x^2}},$$

and at full inductive load

$$1 - \frac{e}{\sqrt{(e + i_1 x)^2 + i_1^2 r^2}}.$$

Such regulation curve is plotted in full drawn lines on curve sheet 107, based upon the following constants.

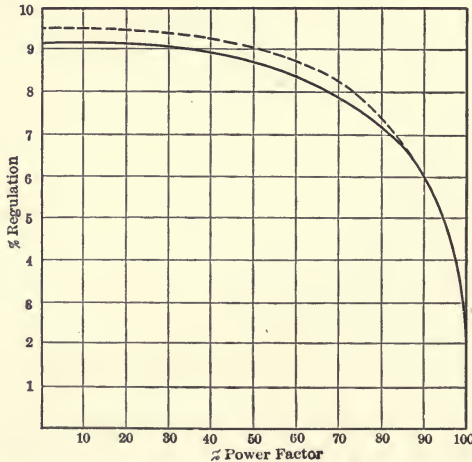

FIG. 107. Regulation of transformer.

Resistance of primary and secondary =  $r = 2$  per cent =  $0.02$ .

Reactance of primary and secondary =  $x = 10$  per cent =  $0.10$ .

Full-load current  $I = \sqrt{i^2 + i_1^2}$ .

Secondary voltage  $e$  reduced to primary =  $1$ .



It is seen that the change of regulation with change of power factor is slight with low, but considerable at high power factors. Obviously, the lower the power factor the poorer the regulation.

A very fair approximation to the regulation for various power factors with full-load current can be obtained by the following equation:

$$\text{regulation} = \sqrt{1 + 2c \cos \theta + 2d \sin \theta} - 1$$

where  $c$  is the percentage ohmic drop at full load,

$d$  is the percentage reactive drop at full load, and

$\cos \theta$  the power factor of the load.

The regulation obtained from the approximation formula is given on the same curve sheet in dotted lines, and for all practical purposes, except perhaps at non-inductive load it is sufficiently close to the theoretical shown in full drawn lines.

The reactance of the transformer is determined from the impedance test, in which the secondary winding is short-circuited, and such primary voltage supplied as will cause full-load secondary current to flow. This voltage gives then the impedance drop =  $IZ$ .

The reactance is calculated from this by the following equation:

$$IZ = \sqrt{I^2 r^2 + I^2 x^2},$$

or

$$I_x = \sqrt{(IZ)^2 - (Ir)^2},$$

the resistance obviously being known from direct measurements. In the particular instance considered,

$$z = \sqrt{0.02^2 + 0.10^2} = 0.102,$$

and the voltage required to force full-load current through this transformer is, therefore, 0.102 or 10.2 per cent of the no-load voltage.

Before leaving the subject of transformers, it is of interest to note how, under certain conditions, — which frequently occur, — in connecting a transformer to a generator or live line a *very large instantaneous value of current might exist*, which is many times as large as the normal exciting current, and may be several times the full-load value.

To explain this we refer to Fig. 108, which gives the hysteresis cycles of sheet iron as used in transformers. The abscissæ represent the m.m.f., the ordinates the corresponding flux. As the m.m.f. is increased, the corresponding values of the flux are found from curve *b*; as it is decreased, the flux values are found from curve *a*.

It is seen, that when the current is zero, there is still a very considerable flux either positive or negative in the iron. This flux is about 70 per cent of the maximum.

When a transformer is disconnected from its source of supply the time of opening the circuit is in almost every case when the current wave is at its zero. Thus, we can say that an idle

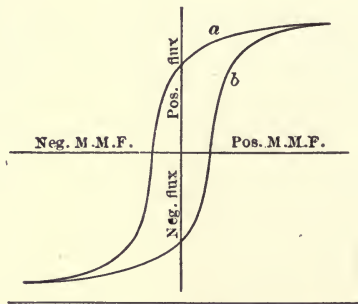

FIG. 108. Hysteresis cycle of sheet iron.

transformer, which once has been in use, is magnetized either positively or negatively, at about 70 per cent of its maximum density.

This has an important bearing on the instantaneous current taken by the transformer at the time it is connected to the line.

Assuming, for instance, that the maximum density of the iron under normal conditions is 100,000, the remanent density is then about 70,000.

In connecting the transformer to the generator under least favorable conditions, we should then get the exciting current corresponding to  $100,000 + 70,000 = 170,000$  density.

Iron is saturated at about 130,000, thus the m.m.f. will be such as to give 130,000 in the iron and 40,000 in space. This latter means a very large current — may well be several times full-load current.

The actual conditions occurring in a transformer at the time of connection or disconnection from its source of supply are very complex.

The first impulse of current penetrates the winding at a very high rate, which is governed by the induction and capacity of the transformer. Individual turns carry different amounts of current, since a large proportion is shunted by the capacity against adjacent metal and ground. Since the voltage across individual turns depends upon the current flowing, it follows that at the time of connecting the transformer not only do the end turns carry more current than subsequent turns, but the voltage across these turns is greater than across the same number of turns in the middle of the winding.

### *Instruments.*

In this chapter will be described a few of the more important instruments and their application to commercial tests; a discussion of all electrical instruments or a complete analysis of any electrical instrument would obviously be far beyond the scope of this book.

### *Direct Current Voltmeters and Ammeters.*

The most common type of voltmeter or ammeter consists of a moving coil which receives current through springs and a permanent magnet in the field of which the coil moves. To get a large torque a cylindrical soft iron core is fixed between the poles of the magnet, so that the coil moves in a narrow air gap having a high flux density. As the pole pieces are concentric with the core, the lines of force are radial and the flux is uniform, so that the deflection is proportional to the current traversing the coil. As the current in most commercial measurements is too large to be sent through the moving element, the latter is connected to a shunt, which for moderate values of current is contained in the instrument itself; for larger values of current is external.

This shunt is made of a material having a negligible temperature coefficient of resistivity, so that heating does not affect the drop, and, consequently, the ammeter reading. The temperature coefficient of the meter itself must also be negligible. In



portable ammeters of small capacity this shunt is usually made of copper and no resistance is put in series with the moving coil. When using such instrument it is always preferable to short-circuit it by means of a switch and to open this switch only at the instant of taking readings. To use this type as a voltmeter, resistance is placed in series with the moving coil. For voltages up to 750 volts the resistance is under the cover of the instrument; for higher voltages, it is usually external. This type of instrument can only be used on direct current circuits, as on alternating current circuits the torque would be reversed every half period.

It would, however, measure the average e.m.f., if by means of a synchronously driven commutator the alternating e.m.f. were reversed at its zero; but it is not the average e.m.f. which is usually required, but the square root of the mean square or the so-called effective e.m.f.

When required to shield these instruments against stray magnetic fields, such as those due to conductors carrying heavy currents, they are protected by iron cases.

Instead of using a spring to act as both conductor and controlling force, a small piece of iron fastened to the shaft on which the moving coil is fixed, is employed in the so-called astatic direct current instruments. When the field strength of the permanent or electromagnet changes, or the field is affected by stray fluxes, both the controlling torque due to the iron piece and the deflecting torque of the moving coil are changed in the same way and the deflection is unaltered. This type is used to quite an extent for switchboard instruments.

The leads carrying the current to the moving coil have in this type little controlling torque.

#### *Alternating Current Voltmeters and Ammeters.*

To measure the effective alternating e.m.f. the field in which the coil moves must be reversed simultaneously with the current of the moving coil; this is attained by placing the moving coil in the field of a fixed coil, which is in series to the moving coil, so that the field changes at the same rate and in the same direction as the current of the moving coil. The deflection, therefore, will be proportional to the square of the voltage times

a constant, which varies from point to point, as the coil moves into different parts of the field, the scale readings being effective voltages.

When an alternating current instrument is used on direct current circuits, two readings should be made, reversing the leads for the second reading, and taking the average of the two, since even weak external fields like that of earth magnetism produce errors.

The temperature coefficient of the combined resistance of portable alternating current voltmeters is not always negligible, as the resistance of the fixed and moving coils is an appreciable part of the whole, and the temperature coefficient of the coils, being made of copper, is high. The series resistance is made of a material having a low temperature coefficient.

Alternating current voltmeters are therefore usually provided with a push button switch by which the circuit is closed at the time of taking readings, and kept open when no observations are being made.

Alternating current ammeters are constructed with iron as moving element. As in all electromagnetic apparatus, so also in this ammeter, the motion takes place in such a manner as to increase the magnetic flux, that is, the iron vane moves to decrease the magnetic reluctance and tends to set itself parallel to the lines of force generated by the current in the fixed coil, and thus the vane controlled by a spring is deflected with its attached pointer.

The iron is not saturated, otherwise the deflections would be proportional to the average and not to the effective e.m.f.

Some types of A.C. voltmeters also have iron vanes instead of moving coils.

As a voltmeter should always be connected across that part only of the circuit, of which it is desired to know the voltage, care must be taken not to include potential differences which do not belong to that portion which is being tested, as, for instance, the impedance drop in a cable carrying large currents. The imped-

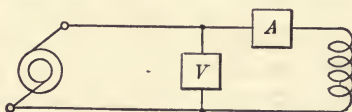

FIG. 109. Connection of volt and ammeters.

ance drop of a small current ammeter may be sufficient to give incorrect results, if connected as shown in Fig. 109; while with



connection as shown in Fig. 110 the voltmeter reading will be correct, but the ammeter reading will be too high, as it includes the current taken by the alternating current voltmeter. That method should in each case be preferred, which gives the smallest error and corrections made, taking into account the phase differences.

For measuring high potentials, potential transformers or large series resistances are used. For measuring large currents or currents of high potential circuits, current or series transformers are used, which should be calibrated before the test with the secondary load, as the combined impedance of the instruments affects the ratio of transformation.

The introduction of transformers is advantageous in that it diminishes the danger, which is still further decreased by keeping the secondary and the case grounded.

For high potential circuits *electrostatic voltmeters* also are used, especially when testing insulation. They contain movable and fixed sectors or disks; the moving elements approach the fixed elements, increasing the electrostatic capacity so as to increase the electrostatic flux.

The torque depends on the square of the voltage, and the instrument indicates effective voltage.

Electrostatic voltmeters are also used as ground detectors, one element being connected to the line and the other to the ground. Thus they measure the voltage between the line and the ground, and they therefore indicate in systems where the individual lines have the same capacity to ground, the severity of the ground. In

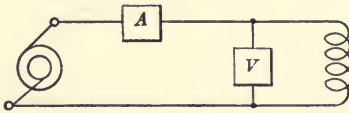

FIG. 110. Connection of volt and ammeters.

other words, their indications for ground are correct only in systems which normally have balanced capacity.

A *spark gap* between needle points is often used to measure high voltages, or to serve as a check measurement when testing the strength of insulating material. It does not measure the effective voltage but rather the maximum, and thus depends on the wave shape. A peaked wave, that is, one having a higher amplitude factor, causes a spark at a lower effective voltage than a wave which is either sinusoidal or flat topped.

To measure currents or voltages of a high frequency circuit, electromagnetic instruments, that is, instruments having coils, are not permissible, due to their self-induction, and hot wire instruments must be used. They consist of a wire kept under tension by a spring and of an indicating mechanism. The wire, when heated by the current to be measured, expands, the minute expansion of the wire being enormously magnified by the indicating system. The heating is proportional to the square of the voltage or current, therefore these instruments also indicate effective values.

### *Compensating for Line Drop.*

To read in the generating station the voltage at the end of a line, a miniature line consisting of resistance and reactance, both having a number of taps, is connected in the secondary of

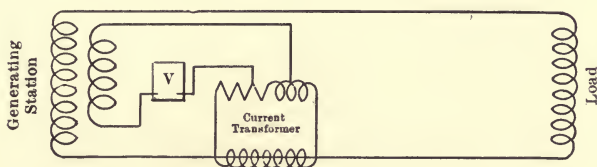

FIG. 111. Compensating for line drop.

a current transformer, the primary being in the transmission line. The relation between the resistance and the reactance of the miniature line is made the same as in the main line, in which case the voltmeter will show the condition at the end of the line. (See Fig. 111.)

For instance, if the secondary voltage of the potential transformer is 120 volts, and we have found that the inductive drop of the transmission line at full load is 10 per cent and the non-inductive drop 7 per cent, the voltmeter and the secondary of the potential transformer would be connected to those terminals of the compensating device which have a potential difference of 12 volts across the reactance and 8.4 volts across the resistance. This arrangement will correct the reading of the station voltmeter for all loads and all power factors.

*Wattmeters and Watthour Meters.*

A wattmeter is an instrument which measures the average power of the circuit to which it is connected. It consists of a fixed coil of large wire and a moving coil of fine wire, a controlling spring which carries the current into the moving coil, and a non-inductive resistance in series with the moving element. The circuit consisting of movable coil and series resistance is the potential circuit, and is connected across the load at the same points where the voltmeter is connected.

The torque between the movable and the fixed coil is determined by the relative position of fixed and moving coils and the product of volts, amperes, and power factor, and therefore can serve as a measure of the true watts of the circuit to which it is connected.

In the ordinary dynamometer type the potential circuit should be non-inductive. If it were inductive, the angle

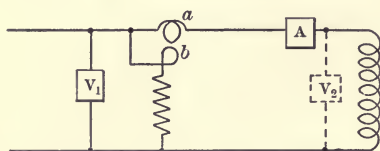

FIG. 112. Wattmeter connections, *a*, fixed coil.

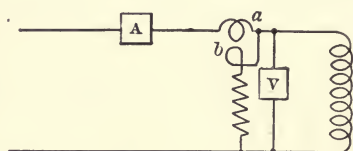

FIG. 113. Wattmeter connections, *b*, movable coil.

between the current in the fixed and movable coils would not be equal to the angle between current and e.m.f. of the circuit under test; at an inductive load this phase difference would be decreased and the reading would be too large.

When used directly on high tension circuits, the moving coil and the fixed coil should be connected to the same terminal, the terminal of the series resistance being connected to the other side to avoid electrostatic action and destruction of the instrument. (See Fig. 112.)

As connected in Fig. 112 the wattmeter measures also the power lost in the current coil and in the ammeter, while connecting it as seen in Fig. 113, causes the reading to include the loss in the potential circuit and in the voltmeter. The method giving the smaller error should be preferred in each case. In most cases connections of Fig. 113 are advisable, as the test

is then made with the correct voltage on the load. The method shown in Fig. 112 can be somewhat improved by adjusting the voltage of the load by a second voltmeter, as indicated by dotted lines and  $v_2$ , and by noting voltmeter reading  $v_1$ , which differs from  $v_2$  by the impedance drop of the instruments, and then disconnecting  $v_2$  and keeping  $v_1$  at the observed value.

For large currents or high potentials, current and potential transformers are used. With these there is an additional source of error, due to the phase difference, as well as any incorrections of ratio between the primary and secondary. This occurs especially with current transformers, when the load to be tested has a low power factor.

For instance, when the secondary current is leading the primary current by 1 degree, and the actual power factor of the lagging circuit under test is 10 per cent, corresponding to an angle of approximately 84 degrees 15 minutes, the wattmeter reading would indicate a power factor corresponding to 83 degrees 15 minutes, that is, 11.75 per cent, and therefore would give a result of 17.5 per cent too large. In modern transformers and better power factors the error is negligible.

In general, potential and current transformers partly counteract each other's errors. In all cases where the power factor is very small, it is necessary to know the phase difference between primary and secondary of potential and current transformers and to apply correction.

To multiply power with time or to measure energy (watt-hours), one element is arranged so that it can revolve continuously. In the dynamometer type the moving element is the potential coil, taking the form of an armature with a commutator.

The meter becomes a motor doing work by turning an aluminium disk through the magnetic field of permanent magnets. When, due to an increase of load to twice its previous value, the current in the fixed coil is doubled, the motor exerts twice the torque which accelerates the armature, until it is balanced by the torque between the currents induced in the aluminium disk and the permanent magnets. This occurs at twice the speed, as at double speed the e.m.f. generated in the aluminium disk is doubled. Therefore, when the load of the circuit, which



the wattmeter is intended to measure, is increased, the speed of the motor meter increases proportionally. The resistance in series with the armature is so large that the e.m.f. generated by the rotation of the armature is negligible, so that raising the voltage of the load circuit also increases the current of the potential circuit and the speed of the meter proportionally to the true watts.

Another type which is extensively used is built on the induction principle. It consists of two fixed coils, an aluminium disk and brake magnets. The potential circuit consists of a fine wire coil of many turns wound over an iron core in series with a larger coil of many turns wound also over an iron core with open magnetic circuit, so that the current lags approximately 90 degrees behind the impressed voltage. The smaller coil is directly over the aluminium disk. The current coil is displaced in space in regard to the core carrying the potential coil so as to produce a shifting field which produces current in the aluminium disk, dragging it in the same direction in which it moves.

To make the angle between the flux and e.m.f. exactly 90 degrees, the ends of the core, which is wound with the potential coil, are usually provided with short circuited coils. These latter retard the flux, and the whole arrangement of potential and current coils represents at unity power factor a quarter phase induction motor; but as the flux of the potential circuit is usually larger than the flux due to the current circuit, the rotating magnetic field is not circular but elliptical.

This type of instrument is used also as an indicating wattmeter, in which case it is provided with a controlling spring as the ordinary dynamometer wattmeter described above.

The same type is also used for indicating voltmeters and ammeters by using the so-called split phase arrangement, that is, by producing a phase difference between the two inducing coils by means of resistance and reactance.

To overcome bearing friction of the commutating type of energy meter, a small fixed coil is put in series with the armature in a position to act on the armature and produce torque in the same direction as the current coil. In the induction type there are small loops of copper displaced laterally under the core which is magnetized by the potential circuit, to produce a shifting field in the normal direction of rotation of the aluminium disk.



*Curve Drawing or Graphic Recording Instruments.*

Curve drawing instruments mark on a disk or roll of paper, which is moved by clockwork, by means of a pen, changes in volts, amperes, watts, etc. The pen is moved at right angles to the motion of the paper, either directly by an instrument having more torque and being usually of larger dimensions than the corresponding indicating instrument, to overcome the friction of the pen on the paper, or by a mechanism moved by an electromagnet or motor, which is fed by an auxiliary circuit. This auxiliary circuit is closed by a relay whenever the current or power of the circuit to which the relay is connected changes.

*Measuring Power of Polyphase System.*

A most important matter is the manner of connecting wattmeters to polyphase circuits. It is evident, that a balanced polyphase circuit can be measured by one wattmeter on one phase and by multiplying the reading by the number of phases.

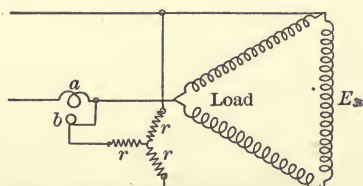

FIG. 114. Single phase wattmeter in balanced three phase circuit.

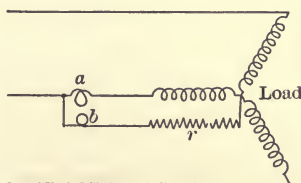

FIG. 115. Single phase wattmeter in balanced three phase circuit.

For instance, in a balanced three phase system, the current coil of the wattmeter may be placed in one leg, and the potential circuit connected between this leg and the neutral point of the load. Or an artificial neutral may be established by having three circuits of equal resistance connected to one point with the three other ends to the three main lines, the moving coil of the wattmeter being part of that leg which is connected to the line in which the current coil is. (See Figs. 114 and 115.)

Or, with the load connected in delta, it may be connected as shown in Fig. 116.

If the load of the three legs is not balanced, this method may give erroneous results, and when used, for instance, to measure

the power taken by an induction motor, which is connected to a three phase system of unequal voltage, it may cause enormous errors.

The method, which is correct on a three phase three wire system, or indeed in any three wire system with balanced or unbalanced load of any power factor, is shown in Fig. 117.

It requires two wattmeters or an instrument consisting of two wattmeter elements acting on one shaft (a polyphase watt-

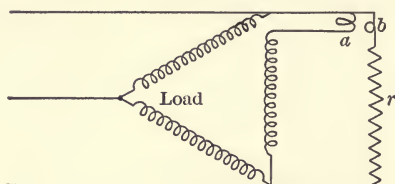

FIG 116. Single phase wattmeter in balanced three phase circuit.

meter). The current coil of wattmeter  $W_1$  is put in phase 1, and the potential circuit between 1 and 3. Current coil of wattmeter 2 is in phase 2, and its potential coil between 2 and 3.

The torque of wattmeter  $W_1$  is proportional at each instant to  $e_1 i_1 + e_3 i_1$  where  $e_1$  and  $e_3$  may be of opposite sign.

The torque of wattmeter  $W_2$  is proportional at each instant to  $e_2 i_2 + e_3 i_2$ ; all  $e$ 's and  $i$ 's being here instantaneous values.

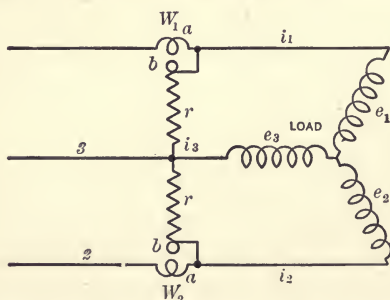

FIG. 117. Two single phase wattmeters in any three wire system, balanced or unbalanced.

Therefore, the sum of the instantaneous torques at each instant is  $e_1 i_1 + e_2 i_2 + e_3 (i_1 + i_2)$ . Now  $i_1 + i_2$  (where  $i_1$  and  $i_2$  may be of opposite sign) is  $= i_3$  - and the above sum becomes

$$e_1 i_1 + e_2 i_2 + e_3 i_3,$$

which is the instantaneous power of the whole three phase load, and as the wattmeter does not respond to each impulse but takes up the position corresponding to the average torque, the sum of the two wattmeter readings give the true average watts. In arriving at this conclusion no assumption has been made in regard to power factor or wave shapes, therefore this method is correct under all conditions of a three wire system.

The correctness of this method of measuring the power of any three wire system can also be shown as follows: Here  $e_1 e_2 e_3$  are the effective values of the E.M.F.'s between the neutral and the lines, and  $i_1 i_2 i_3$  are the energy components of the effective currents respectively.

The energy component of  $i_3$  in regard to  $e_3$  must be carried by the lines carrying also  $i_1$  and  $i_2$  before combining in  $i_3$ . Let  $k_1 i_3$  be that part of  $i_3$  which is carried in the line with  $i_1$  and

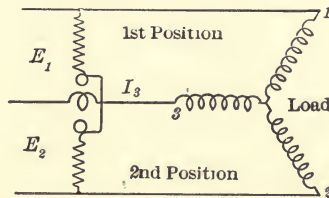

FIG. 118. Balanced three phase system, use of one single phase wattmeter.

$k_2 i_3$  be that part carried in the line with  $i_2$  where evidently  $k_1 + k_2 = 1$ , since  $k_1$  and  $k_2$  each represents a fraction of the whole.

Then, as a wattmeter measures the sum of the individual powers consumed in a circuit consisting of parts, wattmeter reading

$$W_1 = e_1 i_1 + e_3 k_1 i_3$$

and wattmeter reading  $W_2 = e_2 i_2 + e_3 k_2 i_3$

or  $W_1 + W_2 = e_1 i_1 + e_2 i_2 + e_3 i_3.$

In a four wire three phase system, when the neutral wires carry current  $i_1 + i_2$  is not equal to  $i_3$ ; and to get perfectly accurate results, three wattmeters must be employed, each measuring the power of one leg.

When the load is balanced, one wattmeter may be used and two readings taken as indicated in Fig. 118.

The current coil is in leg 3. First a reading is taken with potential circuit between 1 and 3; then the potential circuit

is connected to 2 and 3, again a reading is taken, and both are added. These readings are equal only at unity power factor.

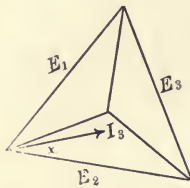

FIG. 119. Diagram of phase relations.

At 50 per cent power factor one of them is 0, and at still lower power factor it becomes negative, requiring a reversal of connection to make a reading possible. The negative reading must be subtracted from the positive reading. One of the wattmeter readings  $W_1 = E_1 I_3 \cos (30 + \theta)$ , while  $W_2 = E_2 I_3 \cos (30 - \theta)$  where  $\theta$  is the phase difference between the current and e.m.f.  $e$   $W_1$  and  $W_2$  being average and  $E_1$ ,  $E_2$ ,  $I_3$  and  $e$  being effective values. (See Fig. 119.)

When  $\theta$  becomes 60 degrees, that is, when the power factor at the instrument is equal to  $\cos 90$  degrees or zero, wattmeter reading  $W_1$  becomes zero. At a still lower power factor  $W_1$  becomes negative and increases while  $W_2$  decreases. Therefore a small error in reading at very low power factors produces large errors in the final result, as the computed watts are the difference of two wattmeter readings which approach each other in magnitude.

#### *Measuring Power Factor of a Polyphase System.*

The two wattmeter readings  $W_1$  and  $W_2$  can serve for calculating the power factor of a balanced load. The ratio of the two wattmeter readings

$$\frac{W_2}{W_1} = \frac{E_1 I_3 \cos (30 - \theta)}{E_2 I_3 \cos (30 + \theta)} = \frac{\cos (30 - \theta)}{\cos (30 + \theta)},$$

the system being assumed to be balanced, and therefore  $E_1 = E_2$ . Now expanding the cos of the difference and of the sum of two angles, and solving the equation in reference to  $\theta$ , we get

$$\tan \theta = \sqrt{3} \frac{P_2 - P_1}{P_2 + P_1}.$$

The power factor is the cosine of  $\theta$ .

This fact is made use of in the power factor indicator, which consists of a fixed coil carrying current  $I_3$  and two movable



coils fixed under an angle to each other on the shaft which carries the pointer. Non-inductive resistances are in series to the moving coils, and the current is brought into these coils by spiraled leads, which have negligible control, so that the position of the moving element with the pointer depends entirely on the relative torque between the two moving coils and the

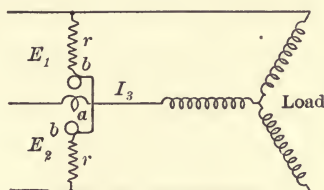

FIG. 120. Power factor indicator.

fixed coil. For instance, at unity power factor the coil connected across  $E_1$ , Fig. 120, will tend to move to the right with the same force as the coil connected to  $E_2$ , so that the system will be balanced with the pointer in the center of the scale.

When the load becomes lagging, the angle between  $I_3$  and  $E_1$  becomes larger, and the angle between  $I_3$  and  $E_2$  smaller, and the torque between the moving coil connected to  $E_1$  and the fixed coil becomes correspondingly smaller than that between the moving coil connected to  $E_2$  and the fixed coil, and the moving element takes up the position in which the two torques are again balanced, that is, the needle moves over the scale to the correct indication of power factor.

Instead of reading the power factor directly, the idle component of the volt-amperes, the so-called wattless watts, can be measured and then be divided by the power component of the volt-amperes, the so-called true watts, which gives the tangent of the angle, whose cosine is the power factor.

The true power of the balanced system is measured by a wattmeter connected with the current coil in one leg and the potential coil in series with a resistance joined to an artificial neutral. The wattless component of the volt-amperes is then measured with the same wattmeter by connecting the potential coil to  $E_3$ , which is at right angles to  $e$ . (See Figs. 114 and 119.) To make the readings comparative the resistance in



series to the moving coil when connected to  $E_s$  is made  $\sqrt{3}$  times the resistance which is in series when connected to  $e$  as  $E_s = \sqrt{3} e$ .

The power factor of one phase of a three phase system is  $\frac{w}{eI}$ , where  $w$  and  $e$  are the watts and e.m.f. of that phase. Now in a three phase system the total power  $W = 3w$ , and multiplying numerator and denominator by 3 and putting  $e = \frac{E}{\sqrt{3}}$ ,  $E$  being the line voltage, we get

$$\text{Power factor} = \frac{W}{\sqrt{3} EI}$$

which is the formula most frequently used for computing the power factor.

#### *Synchronism Indicator.*

The synchronism indicator is an instrument intended to indicate the relative speed and phase of two machines, so as to enable the operator to bring them into synchronism and phase and to put them in multiple at the proper moment. It consists essentially of a rotor having two coils at approximately right angles, wound over cylindrical iron core, and a stationary bipolar single phase field. In series to one of the two movable coils is a reactive coil, and in series to the other a non-inductive resistance, usually an incandescent lamp. The currents are led by brushes and slip rings to the rotor coils, which make with each other an angle somewhat greater than 90 degrees, in fact an angle equal to the supplement of the electrical angle.

The stationary field winding is usually connected to the bus bar and the rotor to the machine to be synchronized. The split phase currents produce a magnetically rotating flux of approximately constant value, and the single phase current in the stationary winding furnishes a single phase field having one maximum value during half a period.

Now the  $N - S$  pole line of the rotating flux tends to line itself along the flux between the stationary poles at the instant that this single phase flux is a maximum, as in this position,

the greatest combined flux will be produced, the two magneto-motive forces just then acting together in the same direction. After the rotor has turned to reach this position it will remain there as long as the phase between the e.m.f.'s impressed on stator and rotor do not change. But when the e.m.f. impressed on the rotor lags behind the e.m.f. impressed on the stator, the  $N - S$  pole line of the rotor will not have reached the flux line between the poles of the stator at the instant that the single phase alternating current field has reached its maximum, and the rotor will turn around its axis so as to bring the maximum flux of the rotor into the direction of the flux of the stator, and the pointer fastened to the rotor will indicate a phase difference.

When the machines to be synchronized run at different speeds the e.m.f. of one will continually change its phase difference in regard to the other, and the rotor of the synchronism indicator will continually rotate, indicating by the direction of rotation which of the machines is running faster. The working of this instrument is similar to that of the phase indicator. In both instruments are two movable coils on the same shaft carrying currents displaced in phase and moving in the field of a fixed coil. The position of the movable element will depend, other things being constant, on the relative phase angles which the individual currents in the moving coils make with the flux of the fixed coil, that is, the moving element will take up such a position that the torque between one moving coil and the field will just balance that between the other moving coil and the same field.

In synchronizing machines, it is well not to lose sight of the fact, that there is a phase difference between the no-load e.m.f. and the terminal e.m.f. under load, that is, when the machine carrying no load is brought into synchronism with the e.m.f. of the bus bar, and then switched into the circuit, the load put on the incoming machine will produce a phase difference between its terminal e.m.f. and that of the bus bar, and a synchronizing current will be established, bringing it into correct phase. At what amount of phase difference the machine should be synchronized will depend on the design of the machine and the load it is going to carry when thrown into the circuit.

*Frequency Indicators.*

Frequency indicators are constructed on various principles. One type makes use of the fact, that the current in an inductive circuit depends on the frequency of the impressed voltage. It consists, like the power factor indicator, of a fixed coil and two movable coils at an angle on one shaft.

In series with one moving coil is a non-inductive resistance, and in series to the other is a reactive coil. These two circuits are in multiple. In series with these multiple split-phase circuits is a reactive coil, and also the fixed coil carrying the current of both moving coils. At a certain frequency both moving coils take, say, the same current, and their resultant magnetomotive force determines their resultant flux and the position which the instrument needle takes. At a different frequency the relative value of the currents in the two moving coils, due to the reactance in series with one, varies, and the direction of their resultant flux changes, so that the needle takes up a different position indicating a different frequency on the scale. When the line voltage varies, the relation between the currents in the divided circuit is not changed, and the reading is not affected.

As the wave shape of the impressed e.m.f. affects the ratio of currents in the divided circuit, the frequency indicator must be adjusted by an auxiliary resistance provided, to establish the proper relation in the divided circuit.

Another type consists of a number of reeds arranged side by side, fixed on one end, having the free vibrating end towards the observer. These reeds have natural periods of vibration differing progressively, and all are under the influence of the action, individually or collectively, of an electromagnet excited by the alternating current, the frequency of which is to be observed. The reed which has a free period of vibration corresponding to the frequency of the circuit vibrates most, while only those which are of very nearly the same frequency vibrate at all. The scale markings correspond to the frequency of the reeds, so that readings can be taken directly.

*Oscillograph.*

The oscillograph is a short period galvanometer, the form most widely used having a moving element or vibrator consist-



ing of a single loop immersed in a damping liquid. It is used in taking wave shapes and in investigating phenomena of short duration.

The vibrator proper is a single loop of metal strips of small dimensions, to the middle of which a small mirror is cemented. The vibrator is held under tension by means of a helical spring. When there is a current through this loop, which is placed in a strong magnetic field, one side of the loop moves forward and the other backwards, and thus turns the mirror through an angular deflection approximately proportional to the current. A ray from an arc or a ray of daylight is thrown on the vibrator-mirror and reflected back either on a revolving film or thrown by means of a synchronously vibrating mirror at right angles to the small vibrator-mirror on a reviewing screen. There are, therefore, two motions at right angles, as in a curve drawing instrument, namely: First, that of the ray reflected from the vibrator-mirror in a horizontal plane furnishing the instantaneous values, positive and negative, that is, the ordinates of the curve; second, that of the film in a vertical direction, giving the time or abscissa of the curve.

By having two or three vibrators and magnetic fields, all in a dark box, and drawing curves on one film, the relative position of the individual waves can be observed. To take pressure curves, resistance is put in series; to take current curves, the vibrator is connected across a non-inductive shunt.

If the time of a free swing of the vibrator were longer than the time with which the vibrator should move to produce a certain harmonic, the instantaneous deflection would lag behind the current which produces it, as the vibrator cannot follow instantly, and before it has reached its correct maximum the current would decrease, and thus not show its proper maximum. Therefore, the harmonic would be decreased and be made lagging, and the reproduced wave would not be true. With a free period of the vibrator equal to that of some harmonic contained in the wave, this harmonic will cause too large a deflection due to mechanical resonance, and also distort the wave. The natural frequency of vibration, therefore, must be much larger than that of the harmonics to give correct results.

The free period of a vibrator is about .6000 per second, so that it is able to follow instantly the instantaneous values of

waves of commercial circuits. The vibrator is immersed in a damping liquid to prevent the deflection going above its final value. The liquid is tested in the following manner: A direct current is sent through the vibrator and abruptly interrupted and again made, thus causing rectangular waves. Now when the damping liquid is too thin, the exposed and developed film will show "overshooting;" and when the liquid is too thick, the deflection is seen to be "creeping" to its final value.

The critical, correct value of the damping fluid is attained when the curve shown by the developed oscillogram has sharp rectangular corners.

All the apparatus described above, with the exception of the needle gap, give effective or average values, while the oscillograph gives instantaneous values, and is especially valuable in investigating phenomena of short duration, or such as do not periodically recur, as, for instance, momentary short circuits or sudden rises of potential.

#### *Protection of Generators and Transformers.*

In discussing phenomena in transmission lines, there were pointed out some causes for abnormal rise in potential, the principals of which were a ground on one line in an insulated delta system, short circuits, leaks, and certain combinations of switching. In addition to these sources of high potentials are voltages induced by atmospheric conditions, lightning strokes, etc. Whatever the cause, it is desirable to minimize the effect.

Disturbances due to the atmospheric conditions can be minimized by the use of one or more frequently grounded overhead wires, preferably placed above the transmission lines. These conductors should and must be grounded frequently, however, — every two or three poles, — otherwise, they are of little benefit.

The ground should be "good," which means either of low resistance by submerging in wet soil, or by covering large surface, or by both. But no matter how well the lines are protected by this method, high frequency oscillations can take place, and considerable benefit is derived from the use of reactive coils in each outgoing feeder. Such reactive coils should have a large induction coefficient, but very low capacity, which latter condition cannot well be fulfilled except in air insulated coils.



For mechanical reasons such coils can have but relatively few turns, therefore their induction coefficient is low. Considering, however, that their function is to protect against oscillations of very high frequency, a low induction coefficient giving a high reactance affords considerable protection.

High voltage oscillations, and especially oscillations of moderately high frequency, a few thousand cycles or so, do, however, reach the station, and therefore the apparatus. For this reason various types of lightning arresters are developed, the object of which is to absorb or discharge such surges.

The most common type consists of a large number of metal balls in connection with a combination of series and shunt resistances.

Another form is the horn arrester, frequently used in Europe. This arrester is usually connected in series with some resistance, preferably of the water jet type.

The weakness of both of these types is, that they involve considerable resistance, or otherwise have relatively high "equivalent gap." Therefore they cannot discharge a surge of considerable volume, or else they subject the insulation to high voltage before they are over and relieve the strain.

A new promising type recently brought out is the "electrolytic," which in its protective characteristics and mechanical construction is very similar to the ordinary storage battery.

The action of the electrolytic arrester, which really is a condenser, is not completely understood. It appears that a very thin film is formed on the surface of the aluminium plates, which film is practically non-conducting up to a certain voltage, 250 to 400 volts, depending upon the solution used. Above the critical voltage the film breaks down, and a very large current value, limited only by the resistance of the electrolyte, is permitted. When the voltage again becomes normal, the film is reestablished, and the current reduced to a minute value.

The critical voltage of the cell is with a given solution so definite that it can be adjusted to take care of rise in voltage of a few per cent, and its action is so rapid that surges of the very shortest duration will be taken care of.



# INDEX.

	PAGE		PAGE
Abnormal current of transformer, voltage on transformer . . . .	160	Characteristics of generators . . .	87
Accidental ground . . . . .	38	Charging current, instantaneous value of . . . . .	15, 20, 35, 36
Adiabatic expansion . . . . .	77	Coefficient of self-induction against ground . . . . .	9, 13, 14
Admittance joint . . . . .	44	capacity against ground . . . . .	14
Air, dielectric strength . . . . .	40	of resistivity . . . . .	161
Air switch . . . . .	36	Commutation, self-excited alternators . . . . .	122
Alexanderson Alternator . . . . .	120	Compensated alternators . . . . .	117
Algebra of complex quantities . . . . .	25	Compensation for line drop . . . . .	165
Algebraic method of line calculation . . . . .	24	Compensators, single-phase . . . . .	142
Alternator . . . . .		Compensators, three-phase . . . . .	144, 146
armature reaction . . . . .	88	Complex quantity . . . . .	25, 26
compensated . . . . .	117	expression of current . . . . .	26
no-load E.M.F. . . . .	132	of impedance . . . . .	26
saturation curve . . . . .	87	of voltage . . . . .	49
synchronous impedance . . . . .	87	Compounding curve of alternator, . . . . .	100
synchronizing force . . . . .	103	Concentrated inductive reactance, . . . . .	16
synchronizing of . . . . .	129	condensive reactance . . . . .	16
Aluminium conductors . . . . .	52	Condensive reactance . . . . .	20
Ammeter . . . . .	161, 162	Constants of transmission in lines, . . . . .	49
Amplitude factor . . . . .	164	Copper economy . . . . .	8
Armature reaction . . . . .	88, 97, 116, 135	Core type transformers . . . . .	137
diameter per pole . . . . .	135	Corona effects . . . . .	38
self-induction . . . . .	85	Cost estimates . . . . .	6
drop . . . . .	93	of pole lines . . . . .	74
Astatic instrument . . . . .	162	of steel towers . . . . .	74
Atmospheric pressure . . . . .	76	Critical length of transmission line . . . . .	19
Automatic switches . . . . .	58	Cross currents due to speed . . . . .	113
Available energy in steam . . . . .	77	due to wrong excitation . . . . .	113
Balanced capacity . . . . .	46	in the main lines . . . . .	114
"Base Line" . . . . .	27	in the neutral . . . . .	115
Boiler pressure . . . . .	76	Cross field . . . . .	136
Cables . . . . .		Current density in conductor . . . . .	51
lead covered . . . . .	53	penetration . . . . .	63
losses in lead covering . . . . .	57	rating of cable . . . . .	50
iron armoured . . . . .	59	Curtis turbine . . . . .	75
in conduit . . . . .	50	Curve-drawing instruments . . . . .	169
in soil . . . . .	50	Definite pole machines . . . . .	88, 90, 92
in water . . . . .	50	Delta-Delta system . . . . .	37
maximum voltage . . . . .	50	Delta-open . . . . .	141
paper . . . . .	50	Delta-Y system . . . . .	37
rubber . . . . .	50	De Laval turbines . . . . .	75
rating . . . . .	50	Demagnetizing effect . . . . .	88
Capacity . . . . .	11	Dielectric stress of air . . . . .	40
average for transmission lines . . . . .	11	stress of rubber . . . . .	40
between parallel cylindrical conductors . . . . .	53	stress of oil . . . . .	40
concentric conductors . . . . .	12	stress of paper . . . . .	40
specific inductive . . . . .	35	Distance between transmission lines . . . . .	3
to ground . . . . .	14, 135		

	PAGE		PAGE
Displacement of armature . . . . .	78, 106	Grounding of neutral . . . . .	47
Distortion of wave-shape . . . . .	152, 154	Grounds, effect of . . . . .	42
Distributed condensive reactance, 17, 21		"good", . . . . .	42
Division of load . . . . .	117	"arcing", . . . . .	42
Double current generator . . . . .	129	effect of impedance of . . . . .	45
Duplicate lines . . . . .	8		
		Half-frequency generator . . . . .	125
Eddy currents in lead cables . . . . .	58	Harmonics in generators . . . . .	17, 18
Eddy losses in transformer iron . . . . .	151	third . . . . .	133
Effective resistance in cables . . . . .	56	fifth . . . . .	133
reactance in cables . . . . .	56	function of number of slots . . . . .	132
Efficiency of transformer . . . . .	155	Heat unit . . . . .	77
Electrolytic action . . . . .	5	High-tension direct current . . . . .	5
Electrostatic stresses . . . . .	46	Horn arrester . . . . .	179
voltmeters . . . . .	164	Hot wire instruments . . . . .	165
E.M.F. average . . . . .	162	Hunting of alternators . . . . .	6, 105
E.M.F. effective . . . . .	162	Hysteresis cycles of sheet iron . . . . .	160
Energy loss in transmissions . . . . .	6	loss . . . . .	59, 150, 160
Energy stored . . . . .	34, 36		
Equivalent resistance . . . . .	59	Impedance for triple harmonic . . . . .	116
Erratic voltage to ground . . . . .	48	Impulse of currents . . . . .	161
Excitation of induction alternator, 123		Instantaneous current . . . . .	35
Exciter, direct connected . . . . .	118	Instruments, curve-drawing . . . . .	169
Exciter, geared . . . . .	118	commutator type . . . . .	167
Exciting current of transformer, 152, 160		A. C. voltmeter . . . . .	162
		A. C. ammeter . . . . .	162
		D. C. voltmeter . . . . .	166
		D. C. ammeter . . . . .	161
Field excitation, minimum for		Electrostatic voltmeter . . . . .	164
stability . . . . .	101	for line compensation . . . . .	165
Field excitation . . . . .	93	for polyphase system . . . . .	169, 172
Field intensity . . . . .	9, 11	for power-factor measurements, 172	
of stress . . . . .	11	for large currents and voltage . . . . .	167
static . . . . .	12	ground detector . . . . .	164
Fifth harmonic . . . . .	133	induction type . . . . .	168
Flux in conductor . . . . .	9	shielding of . . . . .	162
outside of conductor . . . . .	9, 11	oscillograph . . . . .	176
equivalent . . . . .	9	synchronous indicator . . . . .	174
of generator . . . . .	94	Wattmeter . . . . .	166
Form factor . . . . .	151	Watt-hour meter . . . . .	166
Four-wire system, power of . . . . .	171	Inductance between parallel con-	
Frequency, addition of currents . . . . .	21	ductors . . . . .	9, 11
changing sets . . . . .	116	to ground . . . . .	12
indicator . . . . .	176	average for transmission lines . . . . .	15
Frequency . . . . .	3, 16	between concentric conductors, 53	
natural . . . . .	16, 17	Inductive effects in telephone	
for lighting . . . . .	16	lines . . . . .	64
for power . . . . .	16	Induction alternator . . . . .	123
resultant current . . . . .	21	Inductor alternator . . . . .	128
natural, of machine . . . . .	109	Insulation, minimum thickness of, 41	
Fuse expulsion . . . . .	48	Interrupting charging current . . . . .	35
		Iron armoured cable . . . . .	59
Gap, equivalent . . . . .	179	Iron cable . . . . .	61
Gas engines . . . . .	75	Iron wire as electrical conductor . . . . .	61
Generating station . . . . .	75		
Generator . . . . .	75, 84, 86	Lead-covered cables . . . . .	53
maximum voltage . . . . .	84	losses in . . . . .	57, 58
Graphic recording instruments . . . . .	169	Lead, specific resistance . . . . .	56
Graphic representation . . . . .	22, 23	Leaks in switches . . . . .	42
Ground arcing . . . . .	43	Lighting, 25 cycles . . . . .	9
as third conductor . . . . .	85	60 cycles . . . . .	9
as main conductor . . . . .	67	Lightning . . . . .	178
detector . . . . .	164	arrester . . . . .	43, 179
return of D. C. system . . . . .	4	stroke . . . . .	143
Grounded overhead lines . . . . .	178	Limit of potential . . . . .	5
telephone conductor . . . . .	68, 69	generator voltage . . . . .	85
high-potential line . . . . .	47		

	PAGE		PAGE
Line constants . . . . .	3, 7	Revolving field alternators . . . . .	128
loss . . . . .	6	Rice, E. W., Jr. . . . .	117
duplicate . . . . .	8	Rise in voltage . . . . .	36
Load distribution between alter- nators . . . . .	117	Round rotor . . . . .	90, 92
Losses in lead-covered cables . . . . .	57	Rubber . . . . .	40
Losses in transformers . . . . .	150	Saturation curve of alternator . . . . .	87, 96
Magnetic reluctance . . . . .	88	Self-excited alternator . . . . .	120
Magnetizing effect of armature . . . . .	31	Shell-type transformers . . . . .	137
Maximum output of line . . . . .	31	Shift of field . . . . .	88
Natural frequency . . . . .	16, 17, 20, 21	Short-circuiting current of alter- nator . . . . .	131, 135
Natural period of alternator . . . . .	108	Short circuits . . . . .	34
Neutral connection . . . . .	37	Single-phase railroading . . . . .	63
cross current . . . . .	85	Skin effect . . . . .	50, 63
reactance in . . . . .	47	Smooth core alternator . . . . .	132
resistance in . . . . .	47	Spark gap . . . . .	164
No-load E.M.F. of alternator . . . . .	132	Stanley alternator . . . . .	126
Oil, dielectric strength of . . . . .	40	"Statics" . . . . .	42
Oil switch . . . . .	36	Static stresses in transformers . . . . .	37
Open circuits . . . . .	34	stresses in generators . . . . .	37
Open delta-connection of trans- former . . . . .	141	Steam turbines . . . . .	75
Oscillations . . . . .	178	engines . . . . .	75
Oscillograms . . . . .	150, 155	velocity . . . . .	75
Oscillograph . . . . .	176	superheated . . . . .	80
Overhead grounded wire . . . . .	178	saturated . . . . .	78
Paper . . . . .	40	Steel conductor . . . . .	63
Parallel connected transformers . . . . .	149	Steel towers . . . . .	74
operation of alternators . . . . .	112	Striking distances . . . . .	73
operation of synchronous and induction generators . . . . .	124	Substation first . . . . .	6, 8
Pendulum . . . . .	106	second . . . . .	9
Penetration of current . . . . .	63	Surges . . . . .	35
Permanent magnet . . . . .	161	Switchboard . . . . .	86
Phase characteristics . . . . .	98, 102	Switches, leaks in . . . . .	42
Pole-line construction . . . . .	74	Switching . . . . .	35
Potential gradient . . . . .	39, 61	Synchronizing force . . . . .	103
Power-factor . . . . .	24	Synchronizing of alternator . . . . .	129, 131
Power, thermal . . . . .	33	Synchronism indicator . . . . .	174
wattless . . . . .	34	Synchronous impedance . . . . .	87, 136
Problem, numerical . . . . .	1	System . . . . .	3
Propagation of electricity . . . . .	17	single-phase . . . . .	4, 7
Protection of generators . . . . .	178	two-phase, four-wire . . . . .	4, 7
Pulsation in engine speed . . . . .	113	two-phase, three-wire . . . . .	4
Radiating surface . . . . .	50	three-phase . . . . .	4, 7
Radius of gyration . . . . .	108	direct-current . . . . .	4
Rateau turbines . . . . .	75	T-connection of transformers . . . . .	140
Rating of cables . . . . .	50	Telephone line . . . . .	3, 63
Reactance, inductive . . . . .	19	disturbances . . . . .	37
condensive . . . . .	20	electrostatic effects . . . . .	69
distributed . . . . .	21	ground return . . . . .	65
Reactive coils as protection . . . . .	178	metallic circuit . . . . .	65
Regulation of alternator . . . . .	135	transposition . . . . .	65
of transformer . . . . .	157	transformer . . . . .	72
Remanent density in transformers . . . . .	160	Temperature coefficient . . . . .	163
Resistance . . . . .	7	Theoretical water rate . . . . .	78
Resistance of lead . . . . .	56	Thermal efficiency . . . . .	78
Resonance . . . . .	16, 19, 20, 43	Third harmonic . . . . .	133
possibilities with transformer . . . . .	37	Three-phase, two-phase trans- formation . . . . .	141
Resultant current of different fre- quencies . . . . .	21	Tower construction . . . . .	8
		Transformer, abnormal current of . . . . .	160
		abnormal voltage of . . . . .	161
		connections . . . . .	3, 139, 141, 337
		core-loss . . . . .	150



	PAGE		PAGE
<b>Transformer — <i>continued</i></b>		Two-phase, three-phase trans-	
core-type . . . . .	137	formation . . . . .	141
efficiency . . . . .	155	Velocity of light . . . . .	17
magnetic circuit . . . . .	137	Voltage . . . . .	3, 5
regulation . . . . .	157	rise due to charging current . . . . .	33
shell-type . . . . .	137	rise by short-circuit . . . . .	34
single-phase . . . . .	137	rise due to "ground" . . . . .	43
three-phase . . . . .	137	control . . . . .	85
in series . . . . .	148	Water rate . . . . .	78, 79
parallel . . . . .	149	Watt-hour meter . . . . .	166
Transmission line . . . . .	3	Wattmeter . . . . .	166
Transposition in telephone lines . . . . .	65	Wave shape of alternator . . . . .	132
Triple harmonic cross-current . . . . .	113	Wire table . . . . .	73
Tubular conductors . . . . .	53	Wooden pole line . . . . .	8
<b>Turbines</b>		Ziethl alternator . . . . .	126
efficiency . . . . .	76	Zoelly turbine . . . . .	75
steam . . . . .	75		
water . . . . .	75		
Two-phase, three-phase com-			
pensators . . . . .	144		









THIS BOOK IS DUE ON THE LAST DATE  
STAMPED BELOW

AN INITIAL FINE OF 25 CENTS  
WILL BE ASSESSED FOR FAILURE TO RETURN  
THIS BOOK ON THE DATE DUE. THE PENALTY  
WILL INCREASE TO 50 CENTS ON THE FOURTH  
DAY AND TO \$1.00 ON THE SEVENTH DAY  
OVERDUE.

APR 17 1933

SEP 4 1934

OCT 4 1937

OCT 11 1937

LD 21-50m-1,'33



jsd  
VES ml

YC 19683

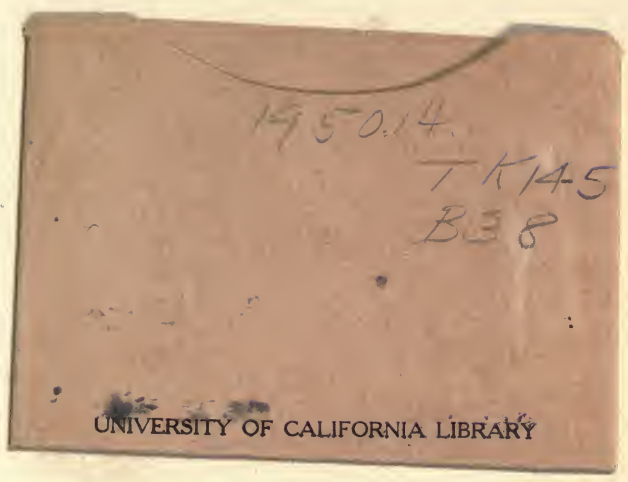

1950.14.

TK145

B38

UNIVERSITY OF CALIFORNIA LIBRARY

