

TJ  
910  
G4

UC-NRLF



⌘B 661 670



This book is due on the last date  
stamped below.

ELECTRICALLY  
OPERATED  
IRRIGATION PLANTS  
FOR THE STATE OF CALIFORNIA



Digitized by the Internet Archive  
in 2007 with funding from  
Microsoft Corporation

This book is due on the last date stamped  
below.

# Electrically Operated Irrigation Plants

FOR THE STATE OF CALIFORNIA

A HANDBOOK OF USEFUL  
INSTALLATION DATA



GENERAL ELECTRIC COMPANY  
SCHENECTADY, N. Y.

NOVEMBER, 1919

*For pumping plant reliability demand General Electric equipment*



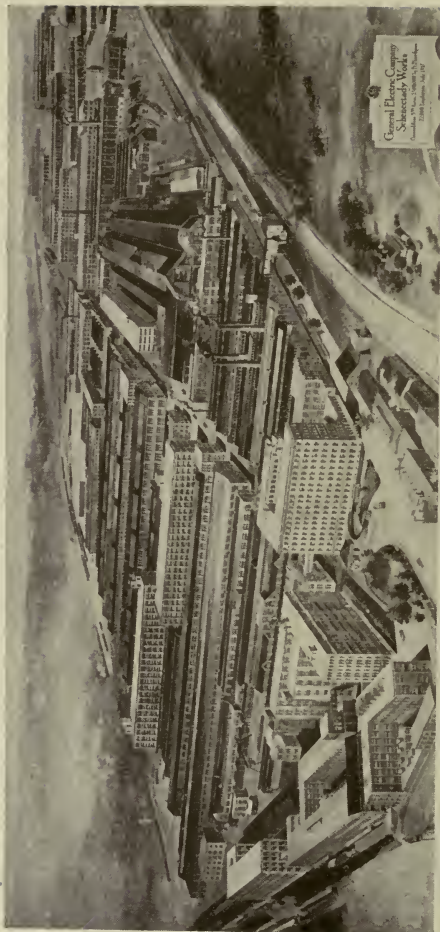

Works at Schenectady, N. Y., General Electric Company

## TABLE OF CONTENTS

	PAGE
General Description of 220- or 440-volt, Three-phase Installation	7
General Description of 2200-volt, Three-phase Installation . . . . .	12
Lighting . . . . .	25
Motor Starting Devices . . . . .	26
Starting Compensators . . . . .	26
Type FP-10 Oil Circuit Breakers . . . . .	28
Type FK-20 Oil Circuit Breakers . . . . .	33
Wiring Data . . . . .	35
Table I—Type RI Induction Motors, Single-phase, 220 Volts	35
Table II—Type KT Induction Motors, Three-phase, 220 Volts	35
Table III—Type KT Induction Motors, Three-phase, 440 Volts	36
Table IV—Type KT Induction Motors, Three-phase, 2200 Volts	36
Table V—Ground Wire Sizes . . . . .	36
Table VI—Table of Allowable Carrying Capacities of Wires	37
Table VII—Size of Conduits for the Installation of Wires and Cables . . . . .	38
Table VIII—Conduit Table Giving Sizes of Conduit which will be Required for Various Combinations of Wires . . . . .	39
General Information on Centrifugal Pumps . . . . .	40
Hydraulic Data . . . . .	42
Table IX—Approximate Capacities and Efficiencies of Centrifugal Pumps for Various Heads . . . . .	44
Table X—Conversion Table . . . . .	44
Table XI—Recommended Sizes of Pipe for Various Lengths of Discharge Line . . . . .	45
Table XII—How to Determine Total Head of a Pumping Plant in Operation . . . . .	45
Friction of Water in Pipes . . . . .	46
Formula for Calculation of Approximate Quantity of Water Flowing in Open Ditch or Flume . . . . .	46
Table XIII—Friction Head of Water for Various Pipe Sizes	47
Table XIV—Data on Leather Belt Transmission . . . . .	48
Belt Centers, Widths, Speeds . . . . .	49
Width of Belt in Relation to Width of Pulley Face . . . . .	49
Pump and Motor Specification Sheets . . . . .	50
Pump and Piping, Pit, Motor . . . . .	50
Wiring—220- or 440-volt, Single- or Three-phase Plant . . . . .	51
Wiring—2200-volt, Three-phase Plant . . . . .	51
Priming Equipment . . . . .	52
Motor . . . . .	52
Priming Motor Transformers . . . . .	52
Type H . . . . .	52
Lighting . . . . .	52



Works at Lynn, Mass., General Electric Company



Works at Pittsfield, Mass., General Electric Company



## PREFACE

The essential considerations in a pumping plant installation are reliability, safety and economy.

The object of this booklet is to supply information as a guide to the selection and installation of equipment for electrically operated irrigation plants, in the State of California, which meet these requirements.

In presenting this information, it is our aim to outline definite standards which, if followed, will result in a successful installation. The General Electric Company offers a complete line of electrical equipment which will accomplish these results. Should you require information beyond the scope of this booklet our engineers will gladly assist you.



An Irrigated Orchard

# GENERAL DESCRIPTION OF 220- OR 440-VOLT, THREE-PHASE INSTALLATION

Irrigation pumping plants, as generally installed, consist of an electric motor connected to a centrifugal pump set in a pit near the water level.

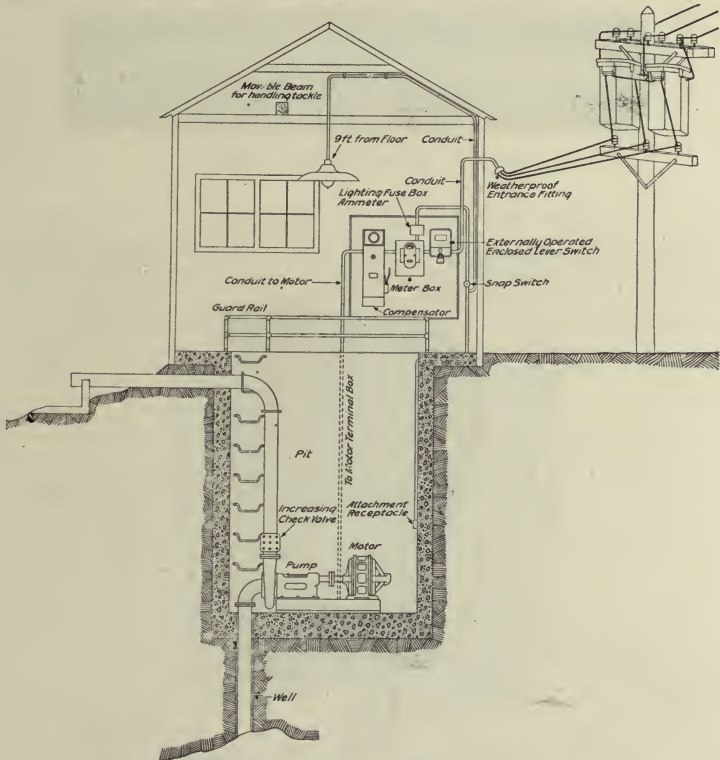

Fig. 1. Pumping Plant Installation Arranged for  
220- or 440-volt, Three-phase Motor

Centrifugal pumps are built in two styles, horizontal and vertical, and are usually arranged for either direct or belt connection depending upon the conditions to be met.

Fig. 1 shows the complete electrical installation for a plant employing three-phase alternating current at either 220 volts or 440 volts.

*For pumping plant reliability demand General Electric equipment*

Transformers provided with cutouts are mounted on a pole near the pump house for reducing the voltage to that required by the motor. Wires extend from the pole and terminate on insulators outside of the building.

For the protection of the wires a conduit (Fig. 2)  Green-



Fig. 2. Greenfielduct Conduit

fielduct provided with a weatherproof entrance fitting, should be installed from the point of connection to the power company's lines to the main entrance switch; all three wires being run in the same con-

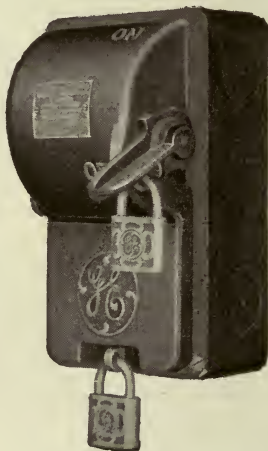





Fig. 3.  Safety First Switch

duit. About three feet of wire should be allowed for the connection to the power company's wires. All wire should be  Red Core rubber covered.

The main entrance switch (Fig. 3) should be of the  externally operated fused type enclosed in an iron box to prevent accidental contact with any of the live parts. It should be located not more than

*For pumping plant reliability demand General Electric equipment*



seven feet above the floor and arranged to cut off all the current used in the pump house.  cartridge fuses (Fig. 4) of the size shown in the tables, should be provided with the switch. From this point the wires, provided with proper fittings and enclosed in conduit,  Greenfielduct, should extend to the location of the power company's meter.





Fig. 4.  Cartridge Fuse

Depending upon the requirements of the power company supplying service, there should be provided either a meter board built of one-inch surfaced lumber properly painted, or a metal cabinet complete with door. These should be of ample dimensions to accommodate the



Fig. 5. FP-10 Oil Circuit Breaker

metering apparatus provided by the power company. Not less than 36 inches of wire should be allowed to make the connections. From the meter location the conduit,  Greenfielduct, should extend to the location of the motor starting device.

For motors 5 h.p. and smaller this will consist of a  Type FP-10 oil circuit breaker (Fig. 5) equipped with under-voltage and overload

*For pumping plant reliability demand General Electric equipment*





Fig. 6. Type CR 1034-Form A1  
Compensator

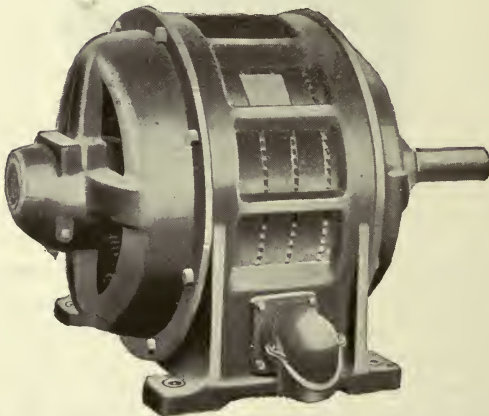

Fig. 7. Standard Skeleton-frame Induction Motor  
*For pumping plant reliability demand General Electric equipment*

protective features. For the installation of this device there should be provided a piece of 1-in. by 12-in. surfaced lumber fastened to the pump house wall and to which the circuit breaker is bolted.

For motors  $7\frac{1}{2}$  h.p. and larger the motor starting device will consist of a  Type CR 1034-Form A1 (Fig. 6) compensator





Fig. 8. Polyphase Vertical Induction Motor

equipped with under-voltage release and overload relays. This should be bolted to 2-in. by 4-in. surfaced timbers which are fastened to the pump house wall.





Fig. 9. Greenfield Flexible Steel Conduit

From the motor starting device the conduit,  Greenfielduct, should extend in a continuous length to the location of the motor (Fig. 7 and 8) and be fastened to the conduit terminal (Fig. 7).

If the motor is direct connected to the pump, the rigid conduit can be connected directly to the fitting. If the motor is belted, it will be necessary to provide not less than 18 inches of  Greenfield

*For pumping plant reliability demand General Electric equipment*

flexible steel conduit (Fig. 9) to make the connection to the conduit terminal.

All joints in conductors should be soldered and insulated with  Splicing Gum and  Acme Tape and then painted with insulating paint.

A wire fastened to the conduit by means of a ground clamp should be connected to the suction pipe of the pump. If the conduit is not run continuously, the separate sections should be bonded together in a similar manner.



**Fig. 10. R-1 Single-phase Motor with Sliding Base**

Where single-phase motors (Fig. 10) are installed, the above information applies, except that two instead of three wires are run to the motor and a special outlet box must be provided to cover the motor terminals where connection is made to the conduit. The proper sizes of switches, wire, fuses and conduit for the various horse power motors are shown on page 35.

**NOTE.**—Where motors larger than 100 h.p. are operated from 440 volts, it is recommended that a  K-5, 600-volt, triple-pole, single-throw oil circuit breaker (Fig. 11) equipped with under-voltage release and overload relays mounted in a manner similar to that shown in Fig. 12 for 2200-volt plants, be employed instead of the usual externally operated enclosed knife switch.

## **GENERAL DESCRIPTION OF 2200-VOLT, THREE-PHASE INSTALLATION**

In the larger installations where the lower voltages would involve excessive wire sizes, it becomes desirable to operate the motor at a higher voltage. This voltage is usually 2200 for the motor driving the

*For pumping plant reliability demand General Electric equipment*

main pumping unit. The priming pump motor and the lighting are supplied through transformers mounted in the pump house and arranged to change the voltage from 2200 volts to 110 or 220 volts.

When 2200 volts are employed it is necessary, in order to safeguard employees and equipment, to install wiring of a higher standard than



**Fig. 11. FK-5 Oil Circuit Breaker**

that used in plants of the 220- or 440-volt class. Fig. 12, 13 and 14 show the complete electrical installation for a plant employing three-phase current at 2200 volts for the main pump motor, 220 volts for the priming pump and 110 volts for lighting.

The power company's wires terminate on insulators at the outside of the building.

Three holes 8 in. by 8 in., arranged as shown in Fig. 13, should be provided in the side of the house for the incoming wires. Surfaced

***For pumping plant reliability demand General Electric equipment***

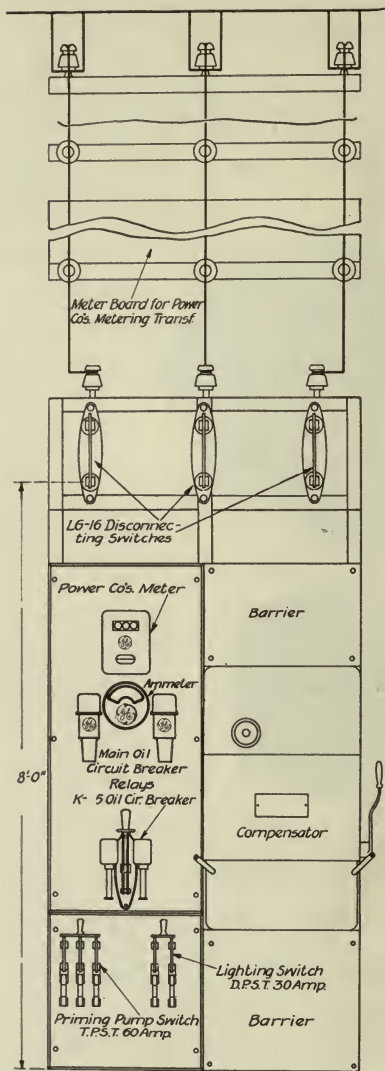

Fig. 12. Elevation, Typical 2200-volt Installation

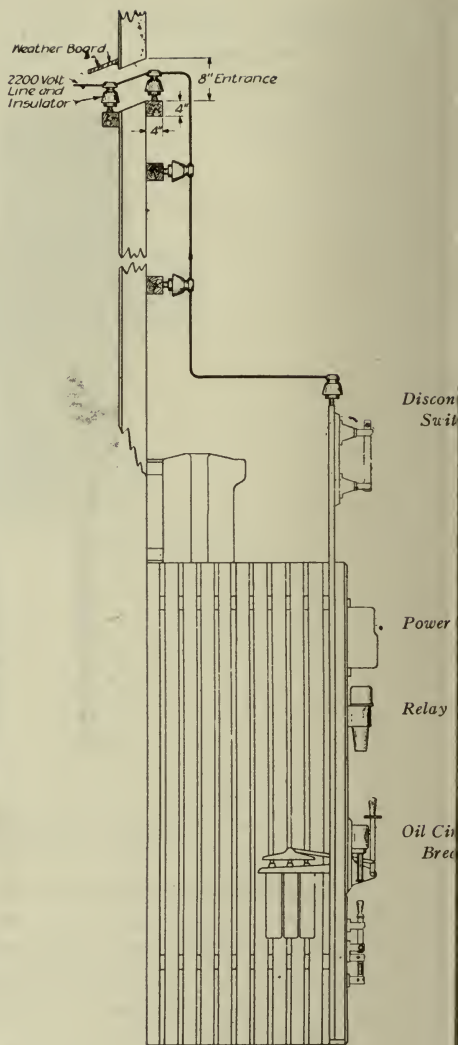
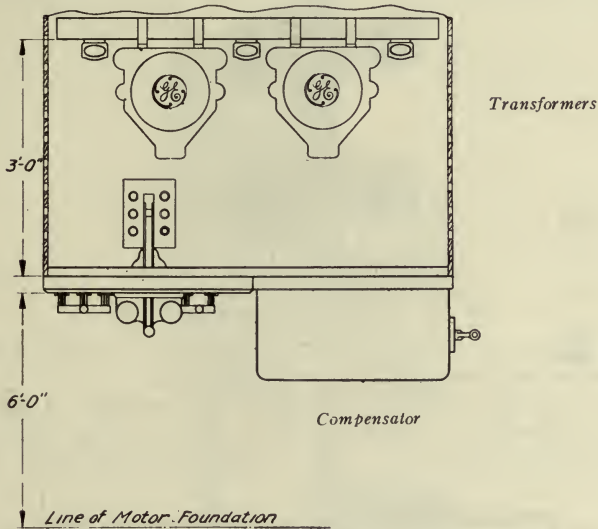

Fig. 13. Section Through Typical 2200-volt Installation

[For pumping plant reliability demand General Electric equipment



timbers 4 in. by 4 in. are fastened to the inside of the house by means of bolts. On these are mounted metal pins and 2200-volt porcelain insulators (Fig. 15) for the support of the wires. The wires extend to the top of the switchboard panel where they terminate as shown.



**Fig. 14. Plan of Typical 2200-volt Installation**

A 1-in. surfaced board of ample dimensions for the reception of the power company's current and potential transformers is fastened to the wall and the timbers and the pins, and the insulators as shown, are provided to terminate the wires. Not less than 36 inches of wire



**Fig. 15. Insulator**

at each point should be allowed for the connections to the power company's incoming lines and the installation of the metering apparatus.

Connections are run from the incoming lines to  Type LG-16, 2500-volt, back connected disconnecting switches (Fig. 16) which

***For pumping plant reliability demand General Electric equipment***

are mounted on iron cross supports fastened to the switchboard frame. These switches completely disconnect all live wires in case any work has to be done in the pump house or on the high voltage wires.

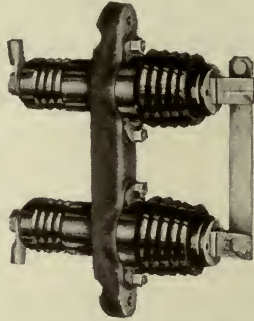



Fig. 16. LG-16 Disconnecting Switch

A  switch hook (Fig. 17) should be kept in the pump house for the purpose of opening the switches.

From the disconnecting switches the wires extend to a  Type FK-5, 2500-volt, triple-pole oil circuit breaker (Fig. 18). This circuit breaker, which is provided with overload and under-voltage

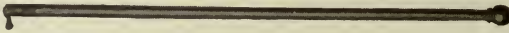



Fig. 17. Cat. No. 65849 Switch Hook



(not shown) protective features, is mounted on a  $1\frac{1}{2}$ -in. dull black marine slate panel complete with subbase fastened to a  $1\frac{1}{2}$ -in. frame. The 110-volt current for the operation of the under-voltage release is obtained from the lighting circuit.

The wires from the oil circuit breaker are connected through  Type PC-146 series overload relays (Fig. 19) to the motor starting device which consists of a  Type CR 1034-Form A1 starting compensator (Fig. 20) mounted on a  $1\frac{1}{2}$ -in. angle iron frame located alongside the switchboard panel.

These angle iron frames are fastened to a 3-in. channel iron base which in turn is bolted to the floor, and braces are provided back to the wall.

From the motor starting device the wires extend to the location of the motor terminals.

*For pumping plant reliability demand General Electric equipment*

All wiring connections from the incoming lines to the motor starting device should be  3000-volt braided varnished cambric cable (Fig. 21). The wiring from the motor starting device to the motor should be  3000-volt triple conductor lead covered varnished cambric cable (Fig. 19). The lead covering is to prevent short circuit-

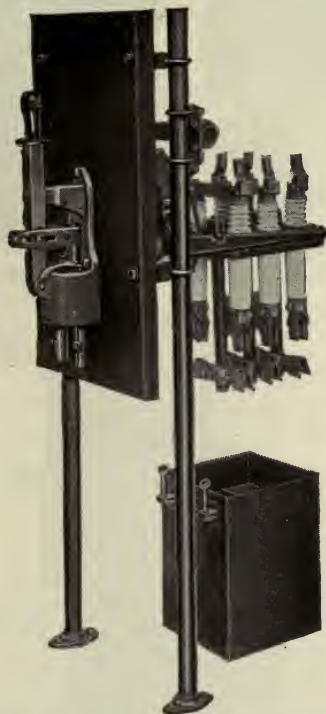



Fig. 18. FK-5 Oil Circuit Breaker

ing of the wires in case moisture should get into the conduit (Fig. 22) in which they are enclosed. The conduit,  Greenfielduct, which should be equipped with bushings at each end, extends continuously from the motor starting device to the motor (Fig. 23) and is to protect the cable against mechanical injury.

The cable should be provided with  mechanically fastened end bells\* (Fig. 24) which are filled with G-E No. 227 insulating com-

\* Cable terminal.

*For pumping plant reliability demand General Electric equipment*

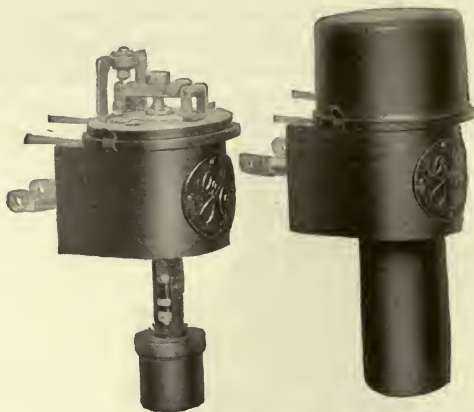

Fig. 19. Type PC-146 Relays



Fig. 20. CR 1034-Form A1  
Compensator

*For pumping plant reliability demand General Electric equipment*

pound in order to protect the wires and prevent the entrance of moisture into the cable.

A No. 16 gauge galvanized iron box with screwed cover should be provided around the end bell at the motor end of the cable and a similar box should be fastened to the motor to enclose the motor terminals.



Fig. 21. Varnished Cambric Cable

These boxes are to be connected by means of  Greenfield flexible steel conduit (Fig. 25). The length of this conduit will be dependent on whether the motor is belted or direct connected to the pump.



As 2200 volts is not suitable for the operation of the priming pump motor it is necessary to provide transformers to reduce this to 220 volts. Either two or three  Type H transformers (Fig. 26) of



Fig. 22. Greenfielduct Conduit

proper capacity rated 2200 volts primary, 220/110 volts secondary, should be mounted on the rear wall of the house as shown in Fig. 14.

For the mounting of the transformers 4-in. by 4-in. surfaced timbers are bolted to the frame of the house. These transformers, which are mounted on iron hangers are connected to the incoming lines through  Cat. No. 104227 fused cutouts (Fig. 27). For the purpose of

*For pumping plant reliability demand General Electric equipment*



disconnecting the transformers from the incoming lines, there should be kept in the pump house a  Cat. No. 158354 plug puller (Fig. 28).

All wires used in conjunction with the priming pump motor and lighting installation should be  Red Core rubber covered.

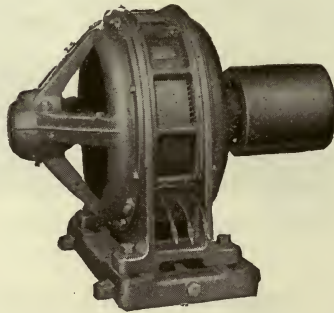

Fig. 23. Polyphase Induction Motor

Connections should be run from the 220/110-volt leads on the transformers to fused knife switches located on the subbase of the main switchboard. The wires should be enclosed in  Greenfielduct



Fig. 24. Mechanically Fastened End Bell

*For pumping plant reliability demand General Electric equipment*

conduit, which is fitted with proper terminal fittings complete with porcelain covers.





**Fig. 25. Greenfield Flexible Steel Conduit**

A  Type LD-22 triple-pole, single-throw fused switch (Fig. 29) of proper capacity should be provided to control the circuit to the priming pump motor.



**Fig. 26. Type H Transformer**

The wires to this motor, enclosed in  Greenfielduct conduit equipped with proper terminal fittings, should extend to the location of a  Type FP-10 oil circuit breaker (Fig. 5 and 30) provided with

***For pumping plant reliability demand General Electric equipment***

under-voltage and overload protective features. This should be mounted on a 1-in. surfaced board bolted to the frame of the pump house. From this circuit breaker the wires should extend in conduit to the motor conduit terminal (Fig. 31).



Fig. 27. Cat.  No. 104227 Cutouts

A  Type LD-22 double-pole, single-throw fused knife switch (Fig. 29) of 30-amp. capacity should be provided to control the lighting and under-voltage release circuits.





Fig. 28. Cat.  No. 158534 Plug Puller



Fig. 29. LD-22 Switch

The main switchboard panel should be drilled for the mounting of the power company's watt-hour meters.

Wires in  Greenfielduct conduit, provided with proper terminal fittings, should extend from the meter board to the power company's meter, allowing 18 inches of wire at each end for connections. All

*For pumping plant reliability demand General Electric equipment*

joints should be soldered and if made in 3000-volt wiring, should be insulated with  bias varnished cambric tape. Similar insulation should be used on all 2200-volt exposed current carrying parts. If



Fig. 30. FP-10 Oil Circuit Breaker



made in 220-volt wiring, they should be insulated with  splicing gum and  Acme tape. In either case the finished joint should be given a coat of insulating varnish.



Fig. 31. Motor Conduit Terminal Box

A ground wire connected to the suction pipe of the pump should be provided and wires connected to it and to the following pieces of apparatus:

1. The secondary wiring of the power company's meter transformers.
2. The compensator cases.
3. The oil circuit breaker case.
4. The switchboard frame.
5. The lighting transformer cases and the neutral of the same.
6. The lead sheath of the cable and all conduits.

*For pumping plant reliability demand General Electric equipment*

These connections should be made either to approved type ground clamps or lugs bolted to the apparatus.

To provide against accidental contact with any of the live parts at the rear of the main switchboard barriers should be provided.

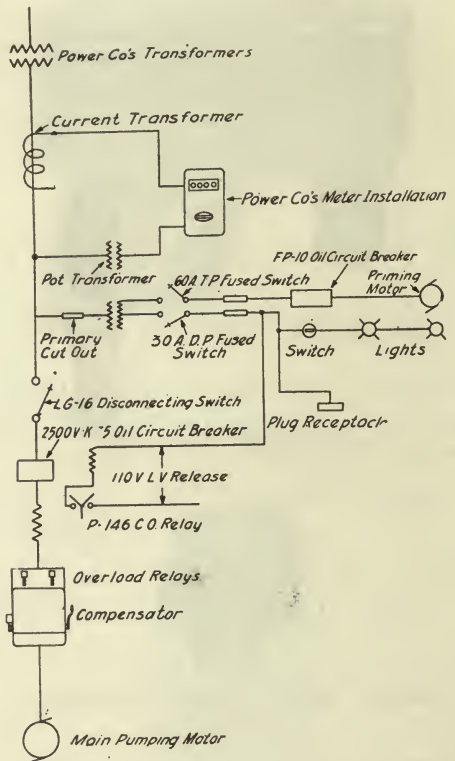

Fig. 32. One Line Diagram of Connections, 2200-volt Plant

The space above and below the motor starting device should be covered with No. 16 gauge dull black finish steel plate screwed in place. At each side of the board provide a wooden barrier made of  $\frac{3}{4}$ -in. by 2-in. battens not less than 8 ft. high and spaced 3 in. apart. They should be securely fastened in place and set not nearer than six inches to any live part.

*For pumping plant reliability demand General Electric equipment*



The diagram of connections is shown in Fig. 32.

The proper sizes of switches, cables and conduit for the various 2200-volt motors are shown on page 38.

The proper sizes of switches, wire and conduits for the various horse power, 220-volt priming pump motors are shown on page 37.

## LIGHTING

It is desirable in all cases to provide artificial light in pump houses for purposes of inspection.

For the smaller installations the equipment falls in two classes.







In surface type plants this may consist of a 50-watt Edison MAZDA lamp complete with a  Ivanhoe 822 holder and  Ivanhoe D.P.D. 40 shade mounted nine feet above the floor as shown in Fig. 33.



Fig. 33. MAZDA Lamp  
with Reflector

In plants having pits similar equipment should be provided on the surface and an 18-in. gooseneck similarly equipped to the surface outlet should be provided on the side wall of the pit about nine feet above the floor. In each case these outlets should be controlled by means of a  Cat. No. 60449 snap switch located at the entrance to the pump house.

In the larger plants the above equipment should be increased in size. The lamps should be  75-watt Edison MAZDA "C" with  Ivanhoe R.E.D.D. 75 reflectors. In addition it is desirable to provide a  543 attachment receptacle to permit of the use of an inspection lamp.

All wiring should be run in  Greenfielduct conduit using proper style  Sprague boxes at the various outlets.

*For pumping plant reliability demand General Electric equipment*



In the 220-volt plants current can be taken from the incoming lines through a  Cat. No. 102928 fuse switch complete with 6-amp.  cartridge fuses and mounted in a metal cabinet located adjacent to the meter cabinet. In these cases 220-volt lamps can be used.



Fig. 34. Type CR 1034-Form A1 Compensators

In the 440-volt plants it will be necessary to provide a  Type H transformer mounted and connected in a similar manner to that noted under 2200-volt plant installations.

In the 2200-volt plants the current can be taken from the transformers used for the priming pump motor.

In these two latter classes of plants 110-volt lamps will be used.

## MOTOR STARTING DEVICES

### STARTING COMPENSATORS

Starting compensators are furnished with all motors  $7\frac{1}{2}$  h.p. and larger. They reduce the heavy inrush of current which would otherwise occur if no compensator was employed. They consist of an auto-

*For pumping plant reliability demand General Electric equipment*

transformer enclosed in an iron case and an oil circuit breaker to make the connections to the circuit and are provided with overload relays and under-voltage release to prevent damage to the motors in case of loads or failure of line voltage.



**Fig. 35. Overload Relay Panel**

They are made in two styles as shown in Fig. 34 and are arranged for all mounting.

They are arranged for conduit wiring.

On both types overload relays are provided. Their function is to protect the motor against continued overloads or single-phase operation. Used in place of fuses, they soon pay for themselves. Adjustment of the relays can be made without uncovering any live parts.

Existing plants using motor starting devices equipped with fuses and having under-voltage releases can secure better protection at less cost by installing these overload relays (Fig. 35) mounted on a panel instead of using fuses.

Type CR 1034-Form A1 compensator can be provided with an ammeter in addition to the overload relays. The ammeter (Fig. 36) as

***For pumping plant reliability demand General Electric equipment***

a part of the compensator equipment is a valuable safeguard in insuring that the motor is not working at an overload due to abnormal friction or other causes, an increase in the ammeter reading being a direct indication of the overload.

The transformers in the case are provided with taps to enable the voltage impressed on the motor to be changed to suit the starting conditions. When the compensator is shipped from the factory the starting connection is made to the second tap nearest the core.



Fig. 36. Type R-6 Ammeter

All compensators are arranged so that all connections and live parts are totally enclosed. A tripping button operated from the outside is provided to open circuit the compensator.

Fig. 37 and 38 show diagrams of connections for starting compensators, 220 or 440 volts, and 2200 volts.

#### **TYPE FP-10 OIL CIRCUIT BREAKERS**

In the case of motors 5 h.p. and smaller where the inrush of current at starting is not objectionable,  Type FP-10 oil circuit breakers (Fig. 39a) are used to protect the motor against continued overloads, single-phase operation or failure of line voltage.

This is accomplished by means of time limit overload protective plugs and under-voltage release. The time limit overload plugs (Fig. 40) are connected in series with the motor circuit and are designed so that excessive current, due to the overload, heats the post A. This in turn is transmitted to the fusible joint which melts, thereby opening the circuit and causing the motor to shut down.

*For pumping plant reliability demand General Electric equipment*

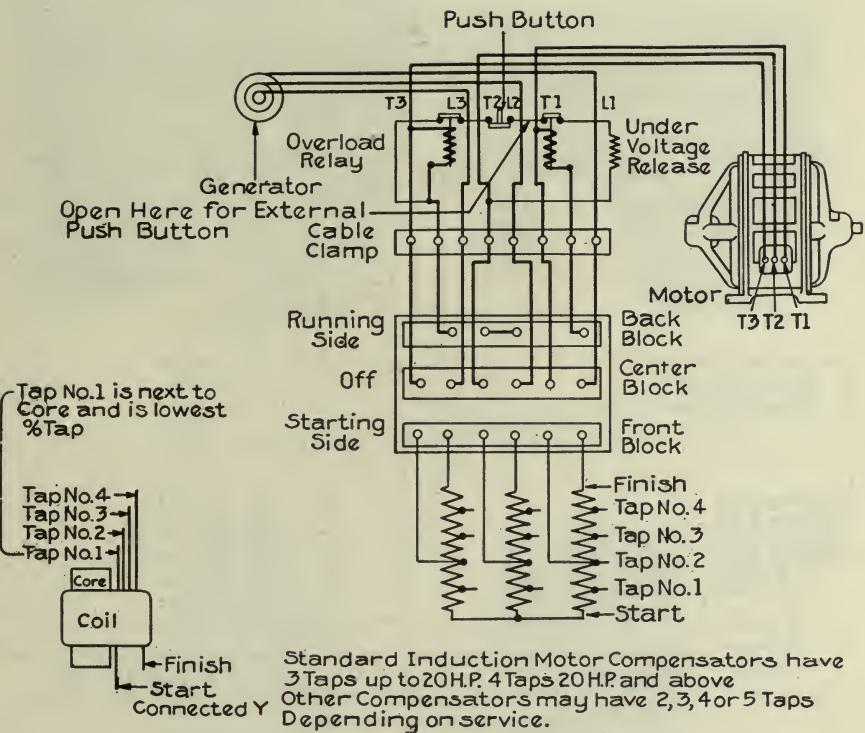

Fig. 37. Connections of Three-phase CR 1034 Form A1 Starting Compensator with Under-voltage Release and Overload Relays for 220- or 440-volt Circuits

*For pumping plant reliability demand General Electric equipment*



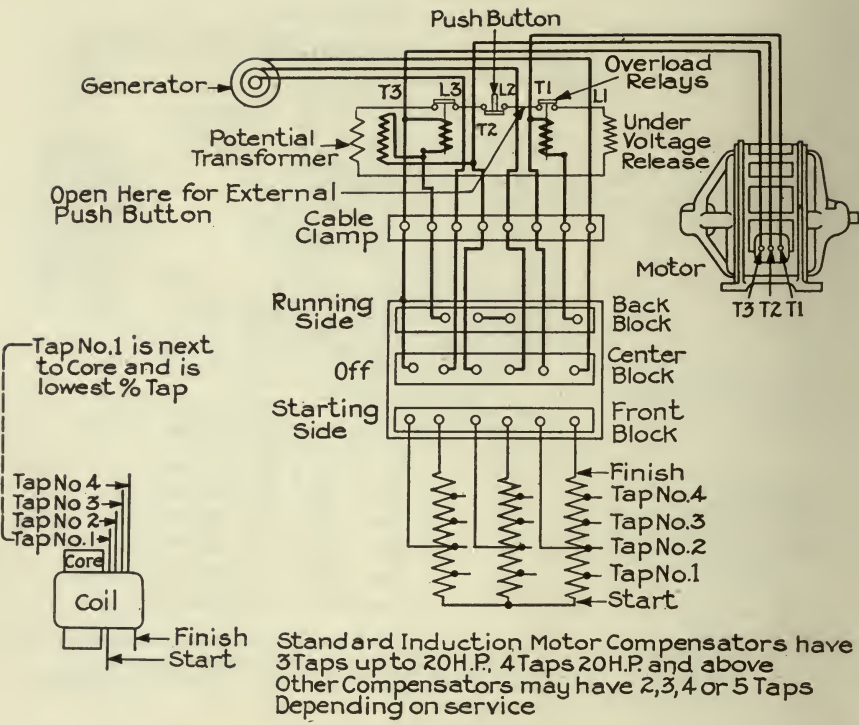
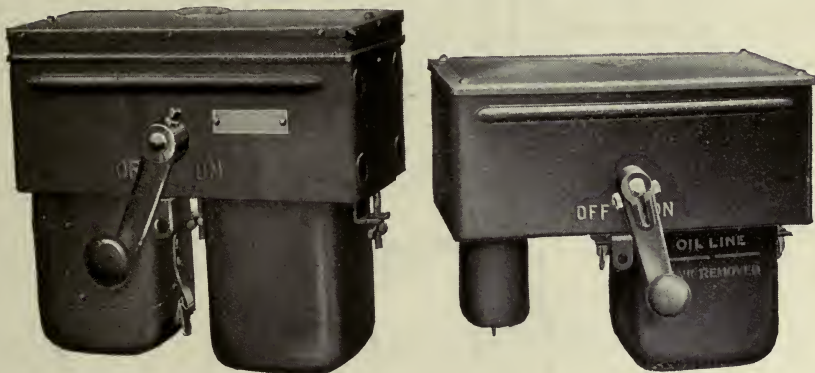

Fig. 38. Connections of a Three-phase CR 1034 Form A1 Compensator with Under-voltage and Overload Release for 2200-volt Circuits

*For pumping plant reliability demand General Electric equipment*

These circuit breakers can also be furnished with overload relays and under-voltage release (Fig. 39b).



(a) Fig. 39. FP-10 Oil Circuit Breakers (b)

Fig. 41 shows the diagram of connections for a Type FP-10 oil circuit breaker using time limit overload protection plugs and under-voltage release for either 220 or 440 volts.

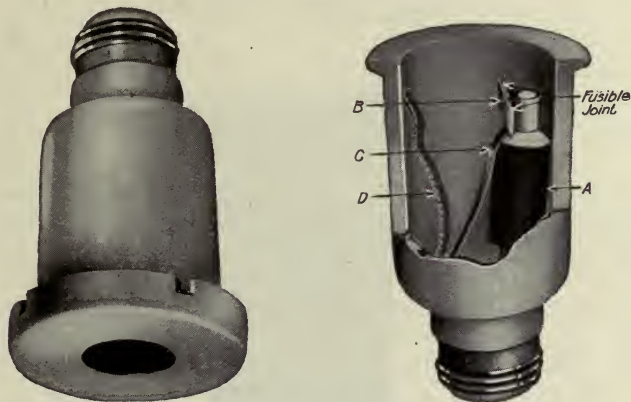

Fig. 40. Time Limit Protective Plugs, 220-440 Volts

*For pumping plant reliability demand General Electric equipment*

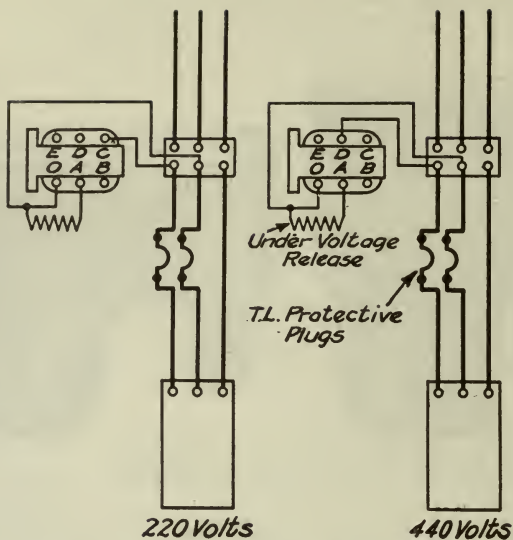

Fig. 41. Wiring for Triple-pole FP-10 Oil Circuit Breaker Using Under-voltage Release and Time Limit Protective Plugs—60 Cycles



Fig. 42. Type FK-20 Oil Circuit Breaker with Series Trip Coils and Under-voltage Release

*For pumping plant reliability demand General Electric equipment*

## TYPE FK-20 OIL CIRCUIT BREAKERS

Many existing plants have the older type of motor starting devices equipped with fuses and without under-voltage release.

In order to provide complete protection against continued overloads or single-phase operation, a  Type FK-20 oil circuit breaker (Fig. 42) can be installed ahead of these motor starting devices. It is

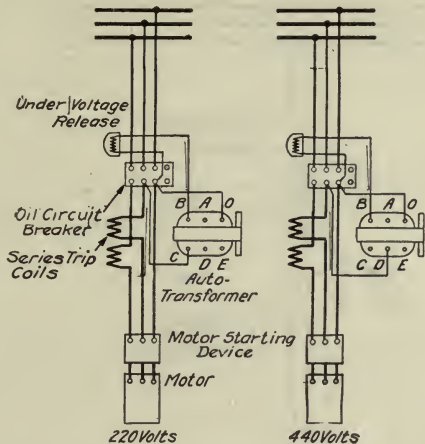

Fig. 43. Wiring for Triple-pole Type FK-20, 220- and 440-volt Oil Circuit Breaker Using Double Series Trip and Under-voltage Release

equipped with protective features in the form of under-voltage release and overload relays and its use will make an old installation up-to-date.

Fig. 43 shows a diagram of the connections for a  Type FK-20 oil circuit breaker for either 220 or 440 volts connected to provide protection to a plant having the old style motor starting devices.

Fig. 44 shows a similar installation for 2200 volts.

*For pumping plant reliability demand General Electric equipment*

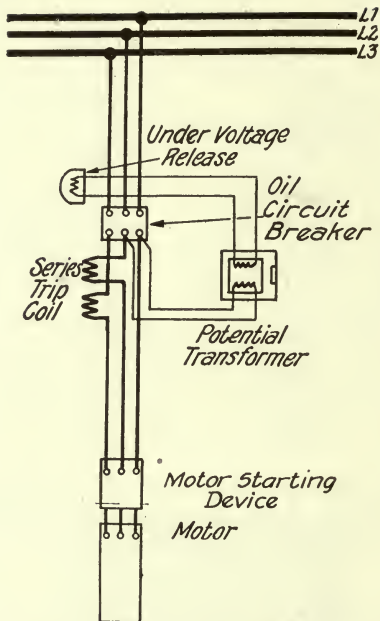

Fig. 44. Wiring for Type FK-20 Oil Circuit Breaker, 2200 Volts, with Double Series Trip and Under-voltage Release

*For pumping plant reliability demand General Electric equipment*



## WIRING DATA

The following tables show the suggested sizes of wires, conduits, fuses, entrance switches, etc., to be used with motors of the voltages and horse powers noted:

### TABLE I

#### TYPE RI INDUCTION MOTORS—SINGLE-PHASE 220 VOLTS

H.P.	Full Load Current	Size of Switches in Amp.	Size Start Fuses	Size of Wire B.&S. Gauge	Size of Conduit in In.
1	5.9	30	20	14	1/2
2	10.7	60	30	10	3/4
3	14.5	60	40	8	1
5	23	60	60	6	1
7 1/2	32.5	100	75	4	1 1/4
10	42	100	100	2	1 1/4

### TABLE II

#### TYPE KT INDUCTION MOTORS—THREE-PHASE 220 VOLTS

H.P.	Full Load Current	Size of Switches in Amp.	Size Start Fuses	Size of Wire B.&S. Gauge	Size of Conduit in In.
1	3.4	30	15	14	1/2
2	6.2	30	25	12	3/4
* 3	8.8	30	30	10	3/4
* 5	14.2	60	50	8	1
7 1/2	18.9	60	50	6	1 1/4
10	25	100	70	6	1 1/4
15	38	100	90	4	1 1/4
20	49	200	125	2	1 1/2
25	61	200	150	1	1 1/2
30	73	200	175	0	2
40	97	200	225	00	2
50	122	400	275	000	2 1/2
75	178	400	350	300 MCM	2 1/2
100	244	600	500	400 MCM	3

\* These size motors are those usually employed for priming pumps in the larger installations.

*For pumping plant reliability demand General Electric equipment*

**TABLE III**

**TYPE KT INDUCTION MOTORS—THREE-PHASE 440 VOLTS**

H.P.	Full Load Current	Size of Switches in Amp.	Size Start Fuses	Size of Wire B.&S. Gauge	Size of Conduit in In.
1	1.7	30	10	14	1/2
2	3.1	30	15	14	1/2
* 3	4.4	30	20	14	1/2
* 5	7.1	30	20	12	3/4
7 1/2	9.5	30	25	10	3/4
10	12.5	60	30	8	1
15	19	100	40	6	1 1/4
20	24.5	100	80	6	1 1/4
25	30.5	100	90	4	1 1/4
30	36.5	100	90	4	1 1/4
40	48.5	200	150	1	1 1/2
50	61	200	150	1	1 1/2
75	89	200	200	0	2
100	122	400	325	0000	2 1/2
150	180	400	475	400 MCM	3
200	247	600	500	500 MCM	3

\* These size motors are those usually employed for priming pumps in the larger installations.

**TABLE IV**

**TYPE KT INDUCTION MOTORS—THREE-PHASE 2200 VOLTS**

H.P.	Approximate Full Load Current in Amp.	Size of Oil Circuit Breaker in Amp. K-5, K-20	Capacity Relays K-5 Oil Circuit Breaker	Capacity of Series Coils K-20 Oil Circuit Breaker	Size of Wire B.&S. Gauge	Size of Conduit in In.
20	6.0	60	10	6	14	1
25	7.2	60	10	8	12	1 1/4
30	8.5	60	10	10	12	1 1/4
40	11.2	60	15	12	10	1 1/4
50	12.5	60	15	12	8	1 1/4
75	20	60	20	20	8	1 1/4
100	26	60	25	25	6	1 1/2
150	38	60	40	40	4	1 1/2
200	50	60	50	60	1	2

**TABLE V**

**GROUND WIRE SIZES**

Copper wire should be used of a size not smaller than that indicated below.

Size of Cutout in Amperes	Size of Wire
0-60	No. 10
60-100	No. 8
100-200	No. 6
201-600	No. 4

Fuses are automatic cutouts

*For pumping plant reliability demand General Electric equipment*

**TABLE VI**

**TABLE OF ALLOWABLE CARRYING CAPACITIES OF WIRES**

The following table, showing the allowable carrying capacity of copper wires and cables of 98 per cent conductivity, according to the standard adopted by the American Institute of Electrical Engineers, must be followed in placing interior conductors.

For insulated aluminum wire the safe carrying capacity is 84 per cent of that given in the following tables for copper wire with the same kind of insulation.

B.&S. Gauge Number	Diameter of Solid Wire in Mils	Area in Circular Mils	Table A Rubber Insulation Amperes	Table B Other Insulation Amperes
18	40.3	1,624	3	5
16	50.8	2,583	6	10
14	64.1	4,107	15	20
12	80.8	6,530	20	25
10	101.9	10,380	25	30
8	128.5	16,510	35	50
6	162.0	26,250	50	70
5	181.9	33,100	55	80
4	204.3	41,740	70	90
3	229.4	52,630	80	100
2	257.6	66,370	90	125
1	289.3	83,690	100	150
0	325.0	105,500	125	200
00	364.8	133,100	150	225
000	409.6	167,800	175	275
		200,000	200	300
0000	460.0	211,600	225	325
		300,000	275	400
		400,000	325	500
		500,000	400	600
		600,000	450	680
		700,000	500	760
		800,000	550	840
		900,000	600	920
		1,000,000	650	1000
		1,100,000	690	1080
		1,200,000	730	1150
		1,300,000	770	1220
		1,400,000	810	1290
		1,500,000	850	1360
		1,600,000	890	1430
		1,700,000	930	1490
		1,800,000	970	1550
		1,900,000	1010	1610
		2,000,000	1050	1670

1 mil = 0.001 inch.

*For pumping plant reliability demand General Electric equipment*

TABLE VII

SIZE OF CONDUITS FOR THE INSTALLATION OF WIRES AND CABLES

Number of Conductors

	One Conductor in a Conduit. Size Conduit in In.	Two Conductors in a Conduit. Size Conduit in In.	Three Conductors in a Conduit. Size Conduit in In.	Four Conductors in a Conduit. Size Conduit in In.
Size B.&S.	Electrical Trade Size	Electrical Trade Size	Electrical Trade Size	Electrical Trade Size
14	1/2	1/2	1/2	3/4
12	1/2	3/4	3/4	3/4
10	1/2	3/4	3/4	1
8	1/2	1	1 1/4	1
6	1/2	1	1 1/2	1 1/4
5	3/4	1 1/4	1 1/4	1 1/4
4	3/4	1 1/4	1 1/4	1 1/2
3	3/4	1 1/4	1 1/4	1 1/2
2	3/4	1 1/4	1 1/2	1 1/2
1	3/4	1 1/2	1 1/2	2
0	1	1 1/2	2	2
00	1	2	2	2 1/2
000	1	2	2	2 1/2
0000	1 1/4	2	2 1/2	2 1/2
CM.				
200,000	1 1/4	2	2 1/2	2 1/2
250,000	1 1/4	2 1/2	2 1/2	3
300,000	1 1/4	2 1/2	2 1/2	3
400,000	1 1/4	3	3	3 1/2
500,000	1 1/2	3	3	3 1/2
600,000	1 1/2	3	3 1/2	
700,000	2	3 1/2	3 1/2	
800,000	2	3 1/2	4	
900,000	2	3 1/2	4	
1,000,000	2	4	4	
1,250,000	2 1/2	4 1/2	4 1/2	
1,500,000	2 1/2	4 1/2	5	
1,750,000	3	5	5	
2,000,000	3	5	6	

For sizes not greater than No. 10 B.&S. gauge, one more conductor than permitted by the above table may be installed in the specified conduit, provided the conduit is not longer than 30 feet, and has not more than the equivalent of two quarter bends from outlet to outlet, the bends at the outlets not being counted.

*For pumping plant reliability demand General Electric equipment*

TABLE VIII

CONDUIT TABLE GIVING SIZES OF CONDUIT WHICH WILL BE REQUIRED FOR VARIOUS COMBINATIONS OF WIRES

Size in In.	Area	½ in.	¾ in.	1 in.	1¼ in.	1½ in.	2 in.	2½ in.	3 in.	3½ in.	4 in.	5 in.
½	.196	.392 ¾	.638 1	.981 1	1.423 1¼	1.963 1½	3.337 2	5.105 2½	7.265 3	9.817 3½	12.762 4	19.831 5
¾	.442	.638 ¾	.884 1	1.227 1¼	1.669 1½	2.209 1½	3.583 2	5.351 2½	7.511 3	10.063 3½	13.008 4	20.077 5
1	.785	.981 1	1.227 1¼	1.570 1½	2.012 1½	2.552 1½	3.926 2	5.694 2½	7.854 3	10.406 3½	13.351 4	20.420 5
1¼	1.227	1.423 1¼	1.669 1½	2.012 1½	2.454 2	2.994 2	4.368 2½	6.136 3	8.296 3	10.848 3½	13.793 4	20.862 5
1½	1.767	1.693 1½	2.209 1½	2.552 2	2.994 2	3.534 2	4.908 2½	6.676 3	8.836 3½	11.388 4	14.333 4	21.402 5
2	3.141	3.337 2	3.583 2	3.926 2	4.368 2½	4.908 2½	6.282 3	8.050 3	10.210 3½	12.762 4	15.707 4½	22.776 5
2½	4.909	5.105 2½	5.351 2½	5.694 2½	6.136 3	6.676 3	8.050 3	9.818 3½	11.978 4	14.530 4	17.475 4½	24.544 6
3	7.069	5.265 3	5.511 3	5.854 3	8.296 3	6.836 3½	10.210 3½	11.978 4	14.138 4	16.690 4½	19.635 5	26.704 6
3½	9.621	9.817 3½	10.063 3½	10.406 3½	10.848 3½	11.388 4	12.762 4	14.530 4½	16.690 4½	19.242 5	22.187 5	29.256 6
4	12.566	12.762 4	13.008 4	13.351 4	13.793 4	14.333 4½	15.707 4½	17.475 4½	19.635 5	22.187 5	25.132 6	
5	19.635	09.831 5	20.077 5	20.420 5	20.862 5	21.402 5	22.776 5	24.544 6	26.704 6	29.256 6		

You will note that the first vertical column gives the standard sizes of conduit together with the cross-sectional area. The top horizontal column gives the sizes of conduit only. The small figures in the body of the table give the combined area of the two conduits and the size of conduit required for the reception of the required number and sizes of wires. For example: It is desired to know what size conduit will be required for three 0000 and three No. 1. Starting in the vertical line with 1½-in. conduit, proceed horizontally to the vertical column for 2½-in. conduit and you will note that the combined area of the two conduits is 6.676, and the size conduit required is 3 in. If it is desired to find the size of conduit for three circuits, take the pipe size thus obtained and repeat the operation for the next size of conduit required.

*For pumping plant reliability demand General Electric equipment*



## GENERAL INFORMATION ON CENTRIFUGAL PUMPS

The purpose of this section is to present in brief form some tables and data which may be of assistance to those interested in the planning and installation of irrigation pumping plants.

The centrifugal pump is in most general use due to its adaptability for various classes of service. Its design is generally well understood and the various pump manufacturing companies issue catalogs which cover the field in a thorough manner—and which they will gladly supply on request.

The usual pumping plant is either belt driven or direct connected. The latter drive can usually be employed and is more satisfactory and economical due to the elimination of belt loss, belt renewal and the saving in space.

It is important that the pump be located as near the water line as possible to eliminate excessive suction head. The suction lift should not exceed 20 feet. If this distance can be lessened, so much the better. For that reason the pumping unit is usually mounted in a pit sunk to a point near the pumping water level. Although not absolutely essential, it is advisable that the pit be concreted throughout and that the floor be of sufficient thickness to provide a proper foundation. The pit should be large enough to permit of easy accessibility of pump and motor.

The casing of the well extends through the concrete floor and can be water sealed around pump suction pipe if necessary.

General Electric motors (Fig. 45) are particularly suitable for pumping plant service. A wide range of standard speeds permits of direct connection of motor to pump to fit almost any condition. They are made in single-phase, two-phase, three-phase 110 volts, 220 volts, 440 volts and 2200 volts.

Impregnated moisture-resisting windings in General Electric motors make them particularly reliable in pumping plants where during a season of the year the plant is idle and it is impossible to prevent the accumulation of a certain amount of moisture on the windings.

In selecting or ordering a centrifugal pump it is important that the following information be known:

1. Desired capacity of pump in gallons per minute.
2. Total suction lift in feet, that is, distance from center line of pump to operating water level.

*For pumping plant reliability demand General Electric equipment*

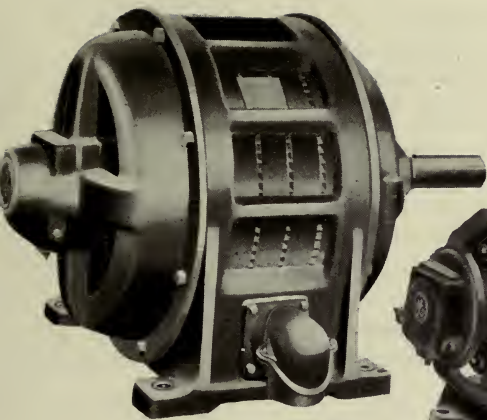

Type KT, Form B  
Skeleton Frame Polyphase

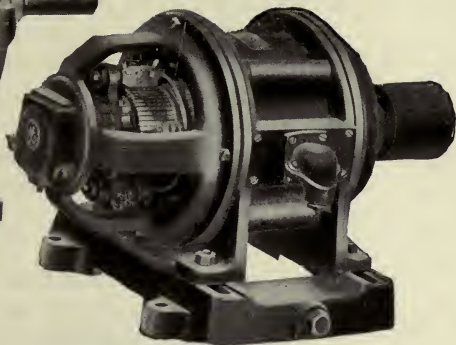

Type RI, Form C, Single Phase



Type I, Form K  
Skeleton Frame Polyphase

Fig. 45. Types of Induction Motors

*For pumping plant reliability demand General Electric equipment*

3. Total discharge lift in feet.
4. Length of suction and discharge pipe required, together with number of elbows required in line.
5. Voltage, phase and cycles of alternating current motor to be used.
6. If water is to be supplied from bored well, give diameter of well casing. If pit is already constructed, state its breadth, length and depth.
7. A rough sketch showing these dimensions and the proposed layout will greatly assist pump manufacturers in readily supplying the proper pump to fit the conditions.

It is advisable that wells be tested before equipment is ordered.

## HYDRAULIC DATA

### FORMULA FOR FIGURING HORSE POWER REQUIRED BY CENTRIFUGAL PUMPS

$$\text{H.P.} = \frac{\text{G.P.M.} \times \text{H} \times 8.33.}{33,000 \times \text{E}}$$

H.P. = horse power of motor required by pump.

G.P.M. = capacity of pump in gallons per minute.

H = total pumping head in feet.

8.33 is weight of one gallon of water in pounds.

E = pump efficiency.

*For pumping plant reliability demand General Electric equipment*

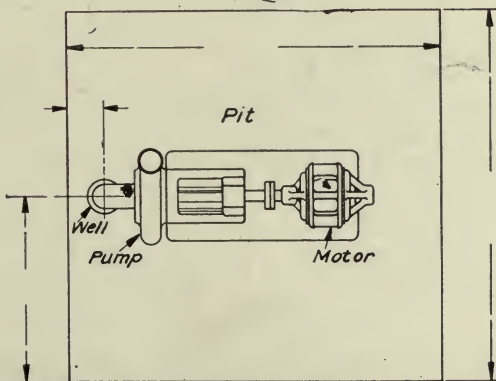
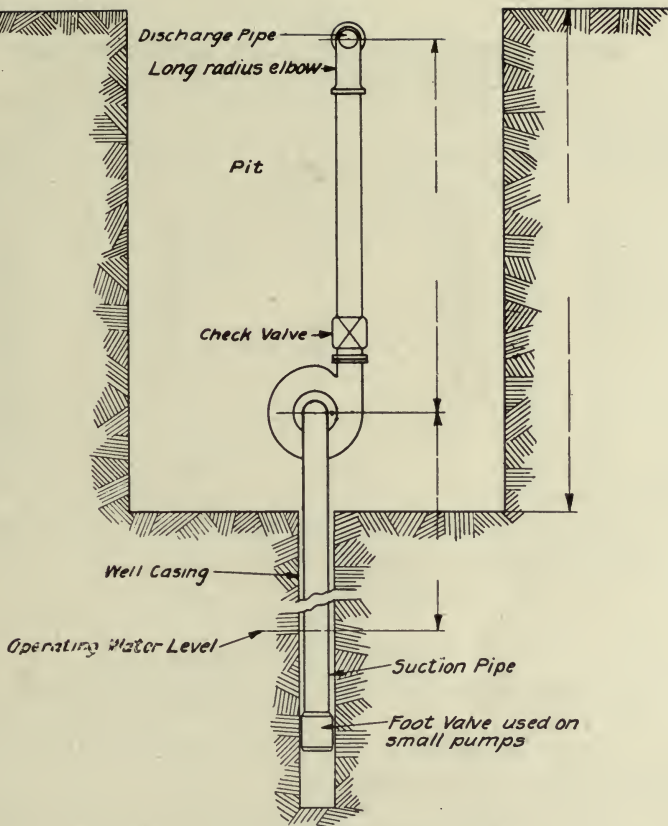

Fig. 46. Necessary Pumping Plant Dimensions

**TABLE IX**  
**APPROXIMATE CAPACITIES AND EFFICIENCIES OF**  
**CENTRIFUGAL PUMPS FOR VARIOUS HEADS**

Size in In.	Gal. per Min.	PER CENT EFFICIENCY—HEAD RANGE		
		15 to 25 Ft.	30 to 60 Ft.	70 to 80 Ft.
1	20	35	28	..
1½	50	33	40	..
2	100	40	48	40
2½	150	40	50	40
3	225	48	56	52
4	400	50	60	55
5	700	55	64	60
6	900	56	67	62
7	1200	60	68	65
8	1600	60	68	65
10	3000	65	70	68
12	4500	65	70	68

These figures will vary somewhat depending on the type and manufacture of the pump, but may be used as a guide.

Data can be supplied by pump manufacturers on any specific proposition or on sizes larger than shown in table.

**TABLE X**  
**CONVERSION TABLE**

To convert inches vacuum to feet head multiply vacuum gauge reading by 1.13.

To convert pressure in pounds per square inch to feet head multiply pressure gauge reading by 2.31.

To convert feet head to pounds pressure per square inch multiply by 0.433.

231 cubic inches of water = 1 gallon.

1 gallon of water weighs 8.33 lb.

1 cubic foot of water contains 7½ gallons.

1 second-foot = 450 gallons per minute.

1 California miner's inch = 11.22 gallons per minute.

*For pumping plant reliability demand General Electric equipment*



**TABLE XI**  
**RECOMMENDED SIZES OF PIPE FOR VARIOUS**  
**LENGTHS OF DISCHARGE LINE**

Gals. per Min.	LENGTH OF PIPE LINE IN FEET									
	50	100	250	500	750	1000	2000	3000	4000	5000
	Recommended Pipe Sizes in Inches									
25	1¼	1½	2	2	2½	2½	2½	3	3	3
50	2	2	2½	2½	3	3	3	4	4	4
75	2	2½	2½	3	3	4	4	4	5	5
100	2½	2½	2½	3	4	4	5	5	5	5
150	3	3	3	4	4	5	5	5	6	6
200	3	4	4	5	5	5	5	6	6	6
250	4	4	4	5	5	5	6	6	6	7
300	4	4	5	5	5	6	6	7	7	8
400	4	5	5	6	6	6	7	7	8	8
500	5	5	6	6	7	7	8	8	10	10
700	6	6	6	7	7	8	8	10	10	10
800	6	6	7	7	8	8	10	12	12	12
1000	7	7	8	8	10	10	12	12	14	14
1200	8	8	8	10	10	10	12	12	14	14
1500	8	8	10	10	12	12	14	14	15	16
2000	10	10	10	12	12	14	14	15	16	18
3000	10	12	12	14	15	15	18	18	20	20

**TABLE XII**  
**HOW TO DETERMINE TOTAL HEAD OF A PUMPING**  
**PLANT IN OPERATION**

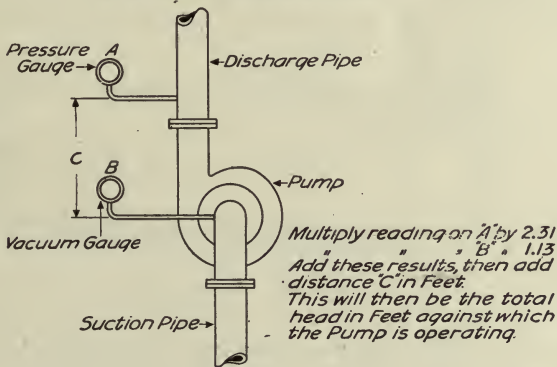

Fig. 47

This will then be the total head in feet against which the pump is operating. There will be a slight error in this procedure due to neglecting entrance and velocity head losses, but as these losses are slight on the average size of plant, they may be neglected.

*For pumping plant reliability demand General Electric equipment*

## FRICTION OF WATER IN PIPES

When water flows through a pipe certain contact friction is set up with a resulting additional head, which is measured in feet or fractions thereof. The friction indicated in this table is in feet head

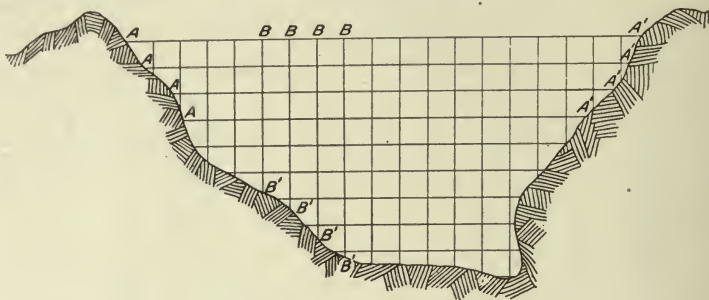

Fig. 48. Open Ditch

per 100 feet of pipe, and is based on clean, smooth pipe interior. For slightly rough pipes add 25 per cent and for very rough pipes add 50 per cent to indicated friction heads. It is only when water is to be pumped through pipe line instead of being discharged into ditch at pumping plant that consideration of this table is necessary.

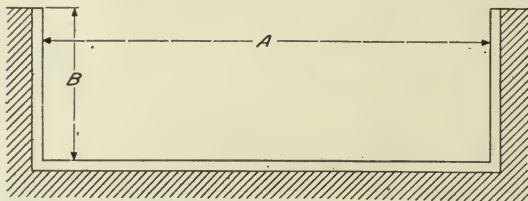

Fig. 49. Open Flume

### FORMULA FOR CALCULATION OF APPROXIMATE QUANTITY OF WATER FLOWING IN OPEN DITCH OR FLUME

The correct method of measuring water flow is by means of a standard weir. However, it is not always convenient to construct a weir on the job and for that reason the following method is offered for calculation of approximate quantity of water flowing in open ditch or flume.

*For pumping plant reliability demand General Electric equipment*

TABLE XIII—FRICTION HEAD OF WATER FOR VARIOUS PIPE SIZES

Gal. per Min.	¾ in.	1 in.	1¼ in.	1½ in.	2 in.	2½ in.	3 in.	3½ in.	4 in.	5 in.	6 in.	7 in.	8 in.	9 in.	10 in.	12 in.
5			.71	.27	.09	.05	.01	.....	.....	.....	.....	.....	.....	.....	.....	.....
10			1.4	1.0	.28	.09	.05	.01	.02	.....	.....	.....	.....	.....	.....	.....
15			5.5	2.2	.57	.18	.09	.05	.07	.01	.....	.....	.....	.....	.....	.....
20			4.8	4.8	.96	.32	.13	.07	.03	.....	.....	.....	.....	.....	.....	.....
25		43.7	14.7	6.0	1.7	.48	.23	.09	.05	.02	.01	.....	.....	.....	.....	.....
30	179.0	63.2	21.0	8.6	2.1	.69	.30	.14	.07	.03	.01	.....	.....	.....	.....	.....
35	264.0	83.2	28.9	11.6	2.7	.92	.39	.20	.11	.04	.02	.....	.....	.....	.....	.....
40	372.0	88.1	37.0	14.9	3.7	1.2	.53	.25	.14	.05	.02	.....	.....	.....	.....	.....
45	461.0	110.	46.5	18.7	4.6	1.5	.64	.32	.16	.07	.02	.....	.....	.....	.....	.....
50	594.0	145.	57.3	23.0	5.6	1.9	.80	.39	.20	.09	.03	.01	.01	.01	.01	.01
60	.....	185.	82.8	32.2	8.0	2.7	1.2	.55	.30	.11	.05	.01	.01	.01	.01	.01
70	.....	253.	116.	46.0	11.0	3.5	1.7	.87	.44	.16	.06	.02	.02	.02	.02	.02
75	.....	340.	129.	51.4	12.2	4.1	1.7	.90	.48	.17	.07	.02	.02	.02	.02	.02
80	.....	393.	147.	57.5	14.5	4.6	2.0	.93	.53	.18	.07	.03	.02	.02	.02	.02
85	.....	442.	179.	73.6	17.9	5.9	2.5	1.1	.60	.21	.09	.04	.02	.02	.02	.02
90	.....	580.	184.	73.6	17.9	5.9	2.5	1.1	.60	.21	.09	.04	.02	.02	.02	.02
100	.....	.....	228.	89.7	21.7	7.3	2.9	1.5	.74	.27	.11	.05	.03	.03	.03	.03
125	.....	.....	367.	150.	34.3	10.0	4.6	2.1	1.2	.39	.16	.07	.04	.02	.01	.01
150	.....	.....	207.	207.	48.8	16.1	6.5	3.1	1.6	.57	.23	.09	.06	.03	.02	.01
175	.....	.....	294.	294.	64.6	21.7	8.6	4.2	2.1	.78	.30	.11	.07	.04	.03	.01
200	.....	.....	359.	359.	86.2	28.6	11.5	5.4	2.8	.96	.39	.16	.10	.05	.04	.02
225	.....	.....	455.	455.	110.	36.2	14.4	6.7	3.4	1.2	.45	.21	.11	.06	.04	.02
250	.....	.....	600.	600.	137.	47.7	17.7	8.5	4.3	1.5	.60	.28	.15	.09	.05	.02
300	.....	.....	.....	.....	195.	64.4	25.7	11.5	6.2	2.1	.85	.39	.21	.11	.07	.03
350	.....	.....	.....	.....	258.	86.8	34.9	16.3	8.4	2.9	1.1	.53	.28	.16	.10	.04
400	.....	.....	.....	.....	345.	114.	44.9	21.3	10.9	3.7	1.5	.69	.37	.21	.13	.05
450	.....	.....	.....	.....	439.	145.	57.5	26.9	13.8	4.6	1.8	.85	.43	.25	.15	.06
500	.....	.....	.....	.....	549.	167.	70.8	33.4	17.1	5.5	2.3	1.0	.56	.32	.20	.08
600	.....	.....	.....	.....	780.	251.	103.	46.0	24.5	8.4	3.3	1.6	.80	.44	.27	.11
750	.....	.....	.....	.....	.....	375.	159.	76.5	38.7	13.5	5.1	2.3	1.4	.69	.41	.18
1000	.....	.....	.....	.....	670.	288.	288.	184.	68.4	22.0	9.0	4.1	2.2	1.2	.73	.30
1200	.....	.....	.....	.....	.....	412.	412.	184.	98.0	33.6	12.9	6.4	3.1	1.76	1.03	.42
1500	.....	.....	.....	.....	.....	442.	442.	212.	107.	37.5	13.8	6.6	3.7	1.9	1.1	.46
1800	.....	.....	.....	.....	.....	637.	637.	301.	154.	49.5	19.8	10.4	5.0	2.7	1.6	.66
2000	.....	.....	.....	.....	.....	.....	.....	330.	174.	59.7	22.9	11.4	5.8	3.1	1.8	.74
2500	.....	.....	.....	.....	.....	.....	.....	430.	220.	73.6	28.8	13.6	6.9	4.0	2.3	.94
3000	.....	.....	.....	.....	.....	.....	.....	534.	273.	88.	35.6	16.4	8.5	4.8	2.8	1.2
.....	.....	.....	.....	.....	.....	.....	.....	427.	256.	138.	35.7	16.4	8.5	4.8	2.8	1.2
.....	.....	.....	.....	.....	.....	.....	.....	.....	.....	198.	81.	36.9	13.3	7.5	4.4	1.8
.....	.....	.....	.....	.....	.....	.....	.....	.....	.....	.....	.....	.....	.....	.....	.....	2.6

For pumping plant reliability demand General Electric equipment

### Open Ditch

Measure widths A-A', etc.  
 Measure depths B-B', etc.  
 Let A = average width in feet.  
 Let B = average depth in feet.

Measure velocity of water by timing a float in the ditch. This velocity should be reduced to feet per second. Deduct 15 per cent of this for friction.

Then gallons per minute =  $A \times B \times V \times 450$ . (See Fig. 48.)

### Flume

Same procedure as above, except deduct 10 per cent from indicated velocity for friction. (See Fig. 49.)

**TABLE XIV**  
**DATA ON LEATHER BELT TRANSMISSION**

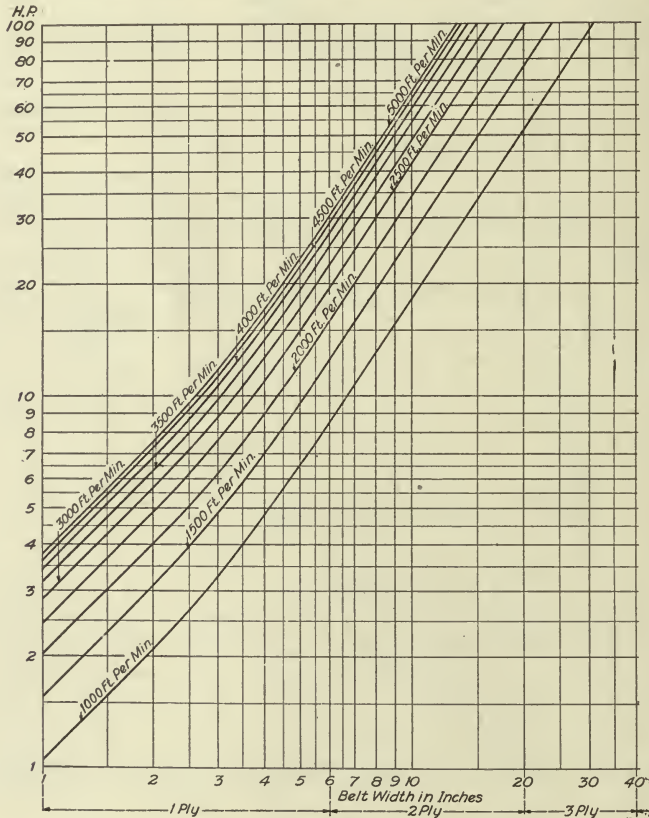

**Fig. 50**

For pumping plant reliability demand General Electric equipment

## DATA ON LEATHER BELT TRANSMISSION—(Cont'd)

### Belt Centers

In order to avoid trouble which may arise on account of belted motors being located so close to driven pulleys that belts do not make sufficient contact with the motor pulley, the following rule should be observed:

### Rule

The distance between centers with straight open belting should preferably be more but *never less* than  $2\frac{1}{2}$  times the diameter of the larger pulley. This will insure an arc of contact of at least 160 degrees.

### Belts are Manufactured to the Following Widths:

Up to 2 in., varying by  $\frac{1}{4}$  in.; 2 to 5 in., varying by  $\frac{1}{2}$  in.; 5 to 10 in., varying by 1 in.; 10 to 36 in., varying by 2 in.; above 36 in., vary in by 4 in.

### Widths

The accompanying curves showing the widths of leather belting which should be used for various belt speeds and horse power, have been plotted from the following data:

Working tension per sq. in. = 275 lb. for laced belting.

Average thickness per ply =  $\frac{3}{16}$  in.

Centrifugal force =  $0.012V^2$  (with velocity in ft. per sec.).

$T_1 = 1$ ;  $T_2 = 0.316$ .

Ratio tight over slack side =  $\frac{T_1}{T_2} = 3.1643$ .

Torque or pull =  $T_1 - T_2 = 0.684$ .

Greatest tension =  $T_1 + 0.012V^2$ .

### Speeds

The following belt speeds are considered safe recommendations:

H.P.	Kw.	Recommended Belt Speed in Feet per Min.
1 to under 5	1 to under 4	2000
5 to under 20	4 to under 15	2500
20 to under 75	15 to under 56	3000
75 to under 100	56 to under 75	3500
100 to under 150	75 to under 112	4000
150 to under 200	112 to under 159	4500
200 to under 1450	159 to under 1082	5000

Five thousand feet per minute is the maximum speed considered safe to operate belts.

### WIDTH OF BELT IN RELATION TO WIDTH OF PULLEY FACE

Width of Belt in Inches	WIDTH OF FACE MUST NOT BE LESS THAN WIDTH OF BELT BUT MAY EXCEED SAME BY	
	Cast Iron Pulleys	Paper Pulleys
	Max. in Inches	Max. in Inches
Up to 2	$\frac{1}{2}$	$\frac{1}{4}$
2 to 5	$\frac{1}{2}$	$\frac{1}{2}$
5 to 12	$\frac{1}{2}$	$\frac{3}{4}$
12 to 20 incl.	$\frac{1}{2}$	1
Above 20 to 24	$\frac{3}{4}$	1
4 to 36	$\frac{3}{4}$	$1\frac{1}{2}$
Above 36	$\frac{3}{4}$	2

*For pumping plant reliability demand General Electric equipment*

# PUMP AND MOTOR SPECIFICATION SHEETS



## PUMP AND PIPING



Size of pump.....Capacity in gallons per minute.....  
Total head.....Suction lift..... Discharge lift.....  
Size and length of discharge pipe.....  
Size and length of suction pipe.....  
Does pump discharge at surface?..... If not, state size and  
length of pipe line.....  
Elbows: number, size and length.....  
Priming equipment; hand or motor-driven.....  
.....  
Check valve.....Foot valve.....  
Miscellaneous fittings.....  
.....

## PIT

Depth.....Length.....Width.....  
Concreted.....Timbered.....Earthen.....  
Location of well in pit.....  
Diameter and gauge of well casing.....  
Type and dimensions of house over pit.....  
.....  
.....



## MOTOR





Horse power.....Speed.....Volts.....  
Phase.....Cycles.....Type.....  
How connected to pump.....  
Accessories: Pulley.....Base.....  
Starting device.....Ammeter.....

*For pumping plant reliability demand General Electric equipment*









## WIRING

### 220- OR 440-VOLT, SINGLE- OR THREE-PHASE PLANT

Size of wires..... Red Core  
Size of Conduit..... Greenfielduct  
Capacity of entrance switch.....  
Capacity of entrance fuses.....  
NOTE.—Consult power company regarding metering requirements.  
Meter board.....  
Miscellaneous fittings.....  
.....  
.....

## WIRING





### 2200-VOLT, THREE-PHASE PLANT

Size of entrance wires..... braided  
varnished cambric 3000-volt cable.  
Meter board.....  
Switchboard panel: Capacity of  FK-5, 2500-volt oil circuit  
breaker.....amperes, equipped with under-voltage  
release and 2 ..... ampere  PC-146 overload relays. Drill for  
power company's wathour meter..... Watthour meter con-  
nections..... Disconnecting switches.....  
amperes,  Type LG-16, 2500-volt, back connected.  
Size of motor conduit..... Greenfielduct  
Size of lead covered cable..... varnished  
cambric, 3-conductor, 3000-volt lead covered.  
Mechanically fastened end bells.....  
Motor connections.....  
Miscellaneous material and fittings.....  
.....  
.....

*For pumping plant reliability demand General Electric equipment*

## PRIMING EQUIPMENT

### MOTOR





Horse power.....Speed.....Volts.....  
Phase.....cycles.....Type.....  
How connected to priming pump.....  
Accessories.....  
Starting device.....ampere  FP-10 oil  
circuit breaker. Capacity of switch mounted on subbase of switch-  
board.....amperes  Type LD-22.  
Capacity of fuses.....  
Size of wires..... Red Core  
Size of Conduit..... Greenfielduct

## PRIMING MOTOR TRANSFORMERS

### TYPE H

Number.....Capacity.....Voltage primary  
.....Voltage secondary.....

## LIGHTING

No. of outlets.....Location.....  
Size of  Edison MAZDA lamps.....watts  
Reflectors..... Ivanhoe  
Main lighting switch: Capacity.....amp.  
Location.....  
Control switch:  snap.....Location.....  
Transformer capacity.....Kv-a. High tension voltage.....  
Low tension voltage.....  
( Type H transformers where required.)

*For pumping plant reliability demand General Electric equipment*

# GENERAL ELECTRIC COMPANY

PRINCIPAL OFFICES: SCHENECTADY, N. Y.

## SALES OFFICES (Address nearest Office)

Atlanta, Ga.	Third National Bank Building
Baltimore, Md.	Lexington Street Building
Birmingham, Ala.	Brown-Marx Building
Boston, Mass.	84 State Street
Buffalo, N. Y.	Electric Building
Butte, Mont.	Electric Building
Charleston, W. Va.	Charleston National Bank Building
Charlotte, N. C.	Commercial National Bank Building
Chattanooga, Tenn.	James Building
Chicago, Ill.	Monadnock Building
Cincinnati, Ohio	Provident Bank Building
Cleveland, Ohio	Illuminating Building
Columbus, Ohio	The Hartman Building
Dayton, Ohio	Dayton Savings & Trust Building
Denver, Colo.	First National Bank Building
Des Moines, Iowa	Hippee Building
Detroit, Mich.	Dime Savings Bank Building
Elizhuth, Minn.	Priority Building
Elmira, N. Y.	Hotel Building
Erie, Pa.	Commerce Building
Fort Wayne, Ind.	1600 Broadway
Grand Rapids, Mich.	Commercial Savings Bank Building
Hartford, Conn.	Hartford National Bank Building
Indianapolis, Ind.	Trust National Building
Jacksonville, Fla.	Heard National Bank Building
Joplin, Mo.	Miners Bank Building
Kansas City, Mo.	Dreger Building
Knoxville, Tenn.	Barnall Building
Little Rock, Ark.	419 Main Street
Los Angeles, Calif.	Corporation Building, 724 S. Spring Street
Louisville, Ky.	Stacks Building
Memphis, Tenn.	Walker Building
Milwaukee, Wis.	Deloitte Service Building
Minneapolis, Minn.	710 Third Ave., North
Nashville, Tenn.	Stations Building
New Haven, Conn.	Second National Bank Building
New Orleans, La.	Marion Beaudre Building
New York, N. Y.	Equitable Building, 120 Broadway
Niagara Falls, N. Y.	Guise Building
Omaha, Neb.	Electric Building
Philadelphia, Pa.	Widener Building
Pittsburgh, Pa.	Oliver Building
Portland, Ore.	Electric Building
Providence, R. I.	Turtle Beach Building
Richmond, Va.	Virginia Railway & Power Building
Rochester, N. Y.	Granite Building
St. Louis, Mo.	Pierce Building
Salt Lake City, Utah	Newcomb Building
San Francisco, Calif.	Elite Building
Seattle, Wash.	Colman Building
Spokane, Wash.	Paulsen Building
Springfield, Mass.	Third National Bank Building
Syracuse, N. Y.	Grondage County Saving Bank Building
Toledo, Ohio	Switzer Building
Washington, D. C.	Commercial National Bank Building
Worcester, Mass.	State Mutual Building
Youngstown, Ohio	Stamberg Building

For TEXAS, OKLAHOMA and ARIZONA Business refer to Southwest General Electric Co.  
 Dallas, Tex. . . . . Interurban Building  
 El Paso, Tex. . . . . 520 San Francisco Street  
 Houston, Tex. . . . . Third and Washington Streets  
 Oklahoma City, Okla. . . . . West Grand Ave.

For HAWAIIAN Business refer to Cattan, Neill & Co., Ltd., Honolulu

Motor and Lamp Agencies in all large cities and towns

INTERNATIONAL GENERAL ELECTRIC CO., INC.

120 Broadway, New York City, and Schenectady, N. Y.

REPRESENTATIVES AND AGENTS IN ALL COUNTRIES



RETURN TO the circulation desk of any  
University of California Library

or to the

NORTHERN REGIONAL LIBRARY FACILITY  
Bldg. 400, Richmond Field Station  
University of California  
Richmond, CA 94804-4698

ALL BOOKS MAY BE RECALLED AFTER 7 DAYS  
2-month loans may be renewed by calling  
(510) 642-6753

1-year loans may be recharged by bringing books  
to NRLF

Renewals and recharges may be made 4 days  
prior to due date

DUE AS STAMPED BELOW

SEP 01 1995



