

*The
Electric
Home*

E. S. LINCOLN

From the collection of the

o Preinger
v a Library
z n m k
b t a w p

San Francisco, California
2006

11/23/34
61
94-
APN Ud
-lee

THE ELECTRIC HOME





THE ELECTRIC HOME

A Standard Ready Reference Book

By
E. S. LINCOLN

PAUL C. SMITH
Collaborator

THE ELECTRIC HOME PUBLISHING COMPANY
NEW YORK, 1934

COPYRIGHT, 1933

COPYRIGHT, 1934

BY

E. S. LINCOLN

ALL RIGHTS RESERVED

TO every one who is doing his or her part in making the home a place of happiness and inspiration in keeping with American traditions of civic progress and social betterment, whether that home be a humble dwelling or a palatial estate, this book is most respectfully dedicated.



● Kitchen work becomes kitchen play in the new guest room of your home . . . your General Electric Health Kitchen.

CONTENTS

	PAGE
INTRODUCTION	11
PROLOGUE	15

CHAPTER ONE

<i>The Electric Highway of the Home</i>	35
---	----

The first journey into the realm of modern electric service. How electricity is distributed over the wiring system and how "traffic" is regulated on this "highway." How the "vehicles" of electric current finally reach their destinations in the various rooms and other locations of the home, outbuildings and grounds.

CHAPTER TWO

<i>Modernizing the Home Electrically</i>	53
--	----

The second journey over the "Electric Highway." How to make it suitable for greater comfort and convenience, as well as for more efficient and economical service in modern "travel." A trip over the modernized "highway" in the author's home, with suggestions for improving the electric service in any existing home.

CHAPTER THREE

<i>Lighting the Home</i>	75
------------------------------------	----

The third journey, in which the "Electric Highway" is judged of its fitness for "night travel" as evidenced by the facilities which the home lighting system provides for artificial illumination. Residential lighting in all its forms, both inside and out, and for all utility and decorative purposes.

CHAPTER FOUR

<i>Extending the Electric Highway of the Home</i>	141
---	-----

The fourth journey over the "Main Highway" and "Branch Roads," pointing out the most approved methods of extending the "routes" so as to serve the new appliances to be installed in the home. How to plan for such extensions and why they should be constructed of the best materials for insuring satisfactory service.

<i>Little Journeys into Modern Wonderland</i>	161
---	-----

The fifth journey, arranged in seven stages (one for each day of the week), showing how the electric appliances employed in the home and about the grounds perform their duties. The "Day Family" and what they do with the "Electric Servants" on their household staff.

CHAPTER SIX

<i>The Efficient Use of Electricity</i>	403
---	-----

The sixth journey, or "bargaining tour" of inspection of the home wiring system. Guides to economy and how to make "Electric Servants" shop to better advantage with respect to the current they draw from the "Main Supply." What *one cent's worth* of electric current—the "wages" of electric service—will buy in modern comfort and convenience.

CHAPTER SEVEN

<i>Home Supervision of the Electrical System</i>	413
--	-----

The seventh journey over the "Home Highway System" under the guidance of the "Superintendent of Maintenance." How a little care and personal supervision of electrical equipment and the "Home Service Staff" of appliances, as well as other connected services of modern utility, will insure their maintenance at the highest peak of efficiency.

CHAPTER EIGHT

<i>The Electric Highway for the New Home</i>	423
--	-----

The eighth journey. Recommendations for adequate service. How to lay out a proper highway with sufficient capacity and suitable outlets in various rooms and locations for all present and future needs. Wiring requirements for a complete plan of modern electric service to accommodate approved methods of lighting and the use of additional appliances.

CHAPTER NINE

<i>The Electric Home of the Future</i>	439
--	-----

The ninth and last journey. An adventure in the realm of imagination, following the "signs" which point to future developments for the "Home Highways" of tomorrow.

	PAGE
CONCLUSION	445
A brief message to the home owner and members of the Electrical Fraternity.	
—————	
GIFT CALENDAR	447
A personal record of important dates and events to be observed with appropriate gifts.	
INDEX	451
An alphabetical reference to all appliances, lamps, and other specific products and electrical devices and material, and where descriptions and illustrations appear in the book.	
MEMORANDUM OF PARTIES TO CALL UPON WHEN ASSISTANCE IS NEEDED	454
A form for the reader to fill out with local addresses, telephone numbers, and information relating to electrical service.	

Introduction

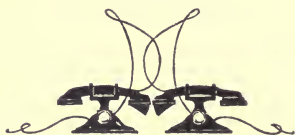

INTRODUCTION

When a man comes to the point where he feels called upon to write a book, there is a strong temptation to make himself out to be a marvelously clever fellow. The more the subject seems fraught with difficulties, the harder he bears down upon our mental machinery. He goes about his writing much as a bicycle rider treads the pedals—*putting forth a prodigious amount of effort*—when pulling up a steep grade. I could never understand why so many authors of educational books make their readers climb hills, anyway. Is it not far easier, quicker and pleasanter coasting down them? And it covers the same ground!

In this book, which is the outgrowth of a meeting with an old friend who sought my aid in modernizing his home, I am attempting to provide you with an effortless means of learning the simple facts everyone should know about the modern applications of electricity in the home. Its prime object is to show the home owner how to derive the greatest benefits from electric service through proper selection, installation and maintenance of equipment, and how to employ this service in the most practical and economical way.

Ever since the inception of the first domestic electrical appliance many years ago, it has been my chief hobby to go adventuring in leisure hours ever further afield into the practical benefits of home electrification. The result is that my friends regard my modest country place as something of a marvel in modern comfort and convenience. Impelled by motives of economy, as well as by a desire to know the "whys and wherefors" of this supposedly difficult subject, I have directed the little work involved myself, with suggestions from my boys. It has required a small amount of time, some inexpensive materials and equipment and a little imagination, but no unusual ability. What I have learned to do, every man, woman and child of high school education can accomplish just as easily.

The subject is so simple that I often feel foolish in explaining it. A few nights ago I was showing a friend the workings of a common, everyday electrical appliance. He laughed at me when I told him

how simple it was, as if anything electrical could be made easy for a layman like himself to understand. I wasn't called upon to defend my statement, for at this point his twelve-year-old boy broke into the conversation and fairly took the wind out of our sails by explaining clearly and simply not only how this particular appliance worked but also a number of others of less common application. Some little incident like that can so often straighten out a difficulty and change our whole course of thinking!

"For instance," I asked, "do you remember how discouraged we used to get with calculus when we were in school?"

My friend smiled reminiscently.

Neither one of us thought it possible ever to understand it. And then we came across a little book called, "Calculus Made Easy." If it hadn't been for that book we would have flunked the course. As it was, we both got honors in the subject. I prize my old dog-eared copy of that book as a shining example of how a really complicated subject can be simplified. Perhaps a number of my readers are familiar with this little volume and will recall the following quotation from its prologue:

"Considering how many fools can calculate, it is surprising that it should be thought either a difficult or a tedious task for any other fool to learn how to master the same tricks.

"Some calculus tricks are quite easy. Some are enormously difficult. The fools who write the textbooks of advanced mathematics—and they are mostly clever fools—seldom take the trouble to show you how easy the easy calculations are. On the contrary, they seem to desire to impress you with their tremendous cleverness by going about it in the most difficult way.

"Being myself a remarkably stupid fellow, I have had to unteach myself the difficulties, and now beg to present to my fellow fools the parts that are not hard. Master these thoroughly and the rest will follow. What one fool can do, another can."

Now, just like the calculus tricks, there are some "electricity tricks," as we might call them, that are enormously difficult. But, fortunately, we do not have to work out any of these problems. They are the ones that have to do with designing and building the big generators and other electrical apparatus used in the power house, on

the transmission lines and in the sub-stations that supply our homes with electricity. When it comes to the simple little mechanisms in the home, with all the just-as-simple appliances which we plug into our convenience outlets, electricity is no more difficult than any other of our common, everyday conveniences, such as gas or water.

It is really just as desirable to know something about how electricity is controlled throughout the electrical system in the home in delivering light, heat and power safely and efficiently to our lamps, heating appliances and motor-driven equipment, as it is to understand the mechanism of the car we drive. No good driver would be satisfied merely to know how to start the engine and shift gears. Some little information about the clutch, carburetor and spark plugs is always a help. Then why shouldn't we all become more familiar with the simple fundamentals of our electric service, at least from the point where it enters the house, instead of pursuing the subject no further than pushing a button or turning a switch?

In the following collection of experiences and practical suggestions, I have but blazed the trail and removed the technical obstructions for a better understanding. It is all just as simple as coasting down hill. The introductory chapter will give you an easy start. Before you realize it you will be at the bottom of the subject. And may you have an enjoyable and profitable journey!

Prologue

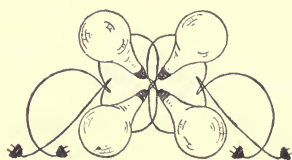

PROLOGUE

"Enchanted Hill"

It was mid-afternoon on an insufferably hot day late in July. I was just closing shop when my desk 'phone rang.

"Now what's up?" I groaned. I was anxious to catch an early train out of the sizzling city and enjoy a couple of hours' cool relaxation in my home before dinner.

"Hello!" I answered, a little irritably.

Our own switchboard operator answered.

"While you were at lunch a Mr. James Wagner rang you," she said. "Left this number and asked to have you call him at about three o'clock."

It was a welcome interruption to my plans, having old Jim turn up so unexpectedly from his long trip abroad. We had been in school together. There would be a lot to talk over—new experiences he had met with on the other side as a foreign correspondent, personal side-lights on conditions which he could not mention in his dispatches. With a newly awakened interest, I reached for the 'phone and when Jim's voice answered I invited him to spend the week-end with us on our hilltop in the country.

"I'm truly sorry, Ed. It's very tempting. You see, Betty came over with me. We've taken a small house up the river—just moving in this week."

"All the more reason, Jim," I urged. "It's no time to move furniture around in this heat. Let everything stay the way it is and declare a holiday. Drive the family over tonight. You know the house, and what's more, you know there is plenty of room in which to spread out and be comfortable."

"Ed, you've got me wavering. It does sound reasonable. Besides, there is a matter you can help me with. It's important enough to have brought me into town on a day like this, and I've spent all the morning and half the afternoon looking around in all the shops and getting nowhere. It's this electrical mystery that you have always been so bugs about. I used to scoff at all the contraptions you were

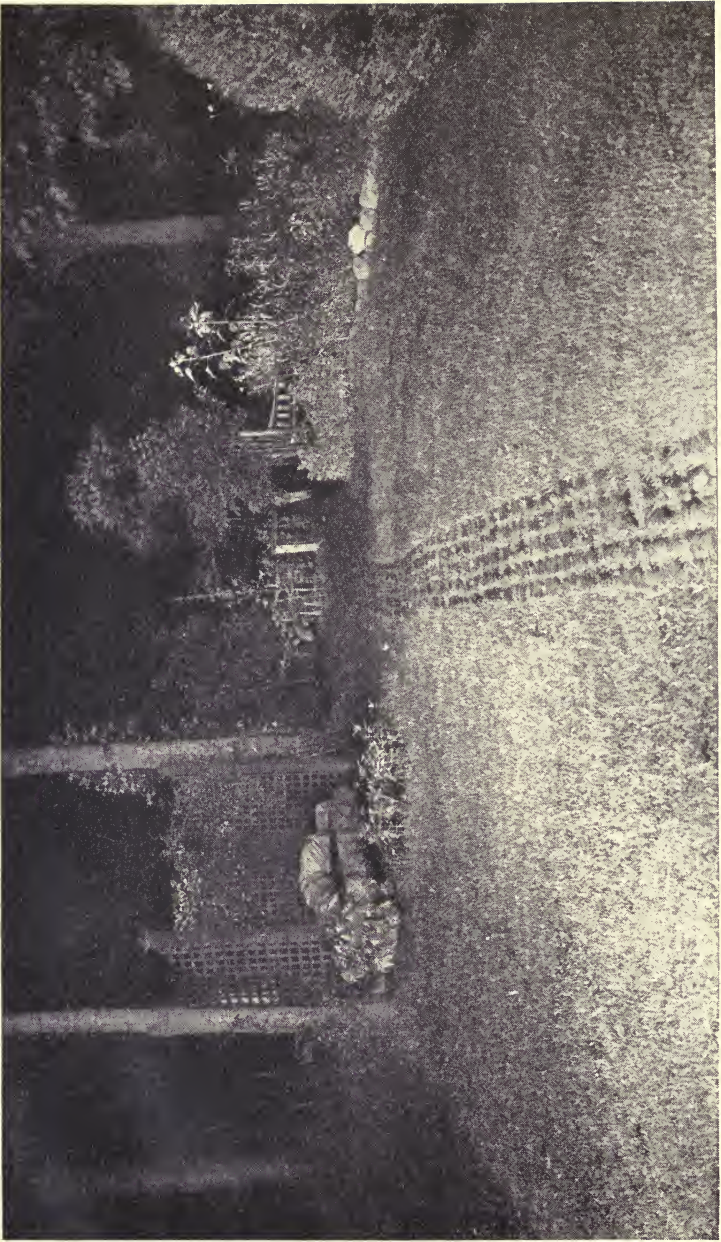

“Suddenly the wide expanse of lawn became a brilliant carpet of light”

having rigged up in that house of yours, but now I'd most humbly scrape up the crumbs from your table of knowledge."

"Business hasn't been too good but I can do better than that," I said. "I will see to it that you won't starve over Sunday."

"Oh, I'm not worrying about that! But seriously, Ed, I am in a quandary. We are going into an old house. It's a delightful old place but it needs fixing up. More than anything else, it requires modernizing—wiring, lights and those 'electrical home conveniences' you were forever harping about. Perhaps you will tell me what to do."

"All right, Jim, I'll take you on. I won't aggravate your sensitive feelings now by telling you how simple it all is. I'll let you see for yourself. Then it's a bargain? You'll bring Betty over tonight?"

"Thanks, Ed. It's a one-sided bargain with everything in our favor, but if you're sure Alice won't put herself to the least trouble I think I can accept for both of us and that we'll be over. Mind now, no special preparations!"

"Don't worry about our being put to any trouble, Jim," I said. "You forget my 'mysterious contraptions,' as you call them. We are all going to be just as lazy as we like."

It was nine o'clock before Jim and Betty arrived, and the late twilight had deepened to pitch darkness. We were beginning to fear that they had lost their way, or that something else had happened, when from our open porch we could hear a car pulling up the grade below the house and soon saw its headlights turning in towards us.

"Here they come, Alice," I said to my wife, "and here is where Jim gets his first lesson in practical illumination."

Far out in front, the lawn was bordered by a low stone fence, culminating at each side of the drive in an embrasured pillar. In the center of one of these, about five feet from the ground, a light fixture had been installed with the bulb so arranged that a narrow beam would play directly across the drive and focus on the watchful "eyes" of a photo-electric cell in the opposite pillar. This photo-electric cell sounds technical, but it is a simple device and turns our lights on or off automatically, using rays of light instead of fingers. Any object passing through



Photo-Electric Cells, or "Electric Eyes," as they are popularly called

this beam of light would touch off some "fireworks," as Jim and Betty were presently to discover.

"Ah, there it is!" Alice exclaimed.

Suddenly the wide expanse of lawn became a brilliant carpet of light, with a myriad of dew pearls glowing over its emerald surface.

And then they saw us.

"Say, but you are the most amazing people! Did you rig up this display for our special benefit?"

"Yes, partly, Jim," I replied. "For the entertainment of very special friends who come to see us, not to overlook the matter of actual protection if we so desire. It's a pretty efficacious method of keeping prowlers away from this lonely abode. If you'll promise not to send a reporter up to scoop a mystery story I'll tell you what name my next door neighbors have coined for my modest little property."

"Promise!" said Jim soberly, holding up his right hand.

"Enchanted Hill," I replied with impressive emphasis. "Sounds magic, doesn't it? But it really isn't, nor is it the least mysterious when you see how it's done. It's like all ghost humbugs," I added for our little Clara's benefit. "When you investigate them they are just foolish myths—very simple and just plain everyday things."

"It's very intriguing, certainly," Betty responded. "Won't you please dispel the myth of the lighted lawn?"

"If you don't mind, Betty," I said, "I must keep that a secret until tomorrow and then I'll show you how it's done. School is out and tonight we are just going to visit and chat over old times."

Before Jim could get to the door leading to the living-room, the interior of the house, which purposely had been kept in total darkness, now suddenly became alight with a soft, mellow glow. In the same instant the brilliant light which flooded the lawn snuffed out like a candle. Jim turned towards us, hesitating.

"Whew! But this is spooky," he laughed.

"But practical, too," I suggested. "Like well-trained servants, when one has discharged his duty he retires and the next one appears to do your further bidding. The lodge-keeper departs with a 'Good night—all's well!' and here is the hallman waiting to greet you."

"Oh, but wait a minute, Ed," said Jim. "Summon back your lodge-keeper, as you call him, for a moment. Your delightful distractions have made me forget all about my car. Show me where to put it and

I'll run it under cover. See that lightning? We are going to get a storm."

"Pardon me, Jim," I apologized. "I'd run it in for you, but I want you to have the experience if you don't mind."

And with that I pressed a button which turned on a light over the garage door.

"Take the right hand door under that marker-light, Jim. I'll walk out with you to the car. There you are. Now your headlights will do the rest. Never mind the door being shut—drive right through it!"

Jim started, first insisting that I sit beside him by way of assurance. What he'd get I'd get too, and after all it was my door!

"Go ahead, man!" I said. "Step on it! Nothing's going to stop you until you get inside."

Jim looked dubious but did as I directed, and as we neared the door it swung wide open as if pushed by an unseen hand.

"Oh, sure! Very simple," agreed my friend in advance of any explanation, as he stalked towards the house.

And with that we had reached the door. Behind us, as Jim took a look into the night, the garage beacon choked out, mysteriously. Jim gulped, too, as if a hand had closed on his Adam's apple, but he never said a word.

It was a half hour or so before Jim and Betty came downstairs. Alice had been showing them around.

"How do you keep your floors looking so nice, especially with the children playing on them so much?" asked Betty.

"Oh, our eldest looks out for that with our electric floor polisher. He has a lot of fun with it, too," replied Alice.

"That's not even classed with work," I added.

"Why!" gasped Betty in surprise as she entered the living-room, "it's marvelously cool in here. How do you manage it?"

"It's a new electrically driven air-conditioning and cooling device I have just had installed in this room," I explained modestly. "We can keep this room at the proper temperature and humidity the year 'round, regardless of the weather."

I knew by the expression on Jim's face that he was much interested and had many questions to ask.

"Betty, I think you will like this chair. It's the best seat in the room, and this mosquito electrocutor will protect you. And Jim,

there's an automatic cigarette lighter at your elbow. Just push the button and a lighted cigarette comes out."

"Why, Edwin, you clever old genius!" Betty burst out, "I never dreamt so much could be done with those queer-looking cords and wires you call conductors and things. I am simply dying to ask you," she continued, "about all the interesting and helpful aids around your home which Alice has been showing me. Like those little automatic lights in the closets and that most ingenious home telephone system your boys have installed. The playroom, too: what a perfectly marvelous electric railroad system! It's just like the real thing. And having the tracks elevated so that the room can be cleaned without disturbing any of the equipment is more than a clever feat of engineering—it's a divine inspiration!"

"Did Alice tell you about the master switch in our bedroom?" I inquired. "It is an emergency measure for lighting up every part of the house if something should happen in the night—just as the lawn lighted up upon your arrival. Imagine its effect on anyone who might be prowling around!"

At this point little Bobby sauntered sleepily into the room in his gaily-colored bath robe.

"It's way past your bedtime, dear," his mother remonstrated.

"But, Mother, I want to ask Daddy something."

Coming up to me, he held up a light bulb he was carrying.

"What's wrong with it, Daddy?" he asked. "It's getting all black."

"Aha!" I said. "Now I've caught you. Reading in bed again. Fact is, Bobby, this lamp is tired out. It has finally just gone to sleep with fatigue. Let me have it and we will put it away for a long rest. We want only wide-awake and efficient little helpers to call upon for service, don't we? And now run along up to bed or you, too, will have dark circles under those bright eyes, just like this lamp.

"Just a little thing, Jim, which so few people pay any attention to. Good lighting has its beautiful as well as its practical aspects to consider. Think of the money that is spent today for furniture and home decorations. And yet the lighting is so often abominable. It's not necessary when there is every size and color of lamp to choose from—for each room and each purpose. And when you know how to light the home properly it means much more comfort and pleasure, more useful lighting and less expense."

"Is that really true, Ed?" Jim interposed. "I mean the expense part of it. Hasn't it cost a tidy little sum to install this equipment? Admitting that it may be simple to learn about all these things, hasn't it represented, after all, a considerable investment?"

"The nice thing about it, Jim, is that it has cost so little in actual outlay. It has meant some planning and work, of course, if you call it work. We don't. It has been a marvelous educational stimulus for the boys for one thing—a means of acquiring practical knowledge about the art of living and serving and, if need be, a trade. The real secret is to know what you want and what you can accomplish, and then get a first-class electrician to carry out your plans. No, Jim, if all this hadn't been simple and inexpensive I wouldn't have been able to do it. And, of course, it has not been done all at one time. We put aside a little from our income each month and add the items that serve us best, using a small portion of the savings we put aside to take care of extensions to our wiring system, or 'Electric Highway,' as I call it.

"Best of all is the pleasure it gives the whole family. What counts most in our lives is the pleasure we get out of it, not only for ourselves but for others as well. The home always comes first, but a home must have certain necessities before there is happiness. Electricity is our greatest servant and serves us in many ways, as I shall show you presently. The first things of importance in any home are health and safety. What other agency is there that does so much for us—lighting the home, cleaning the floors and rugs, washing our clothing and ironing it, and dozens of other things about the house and grounds? And it is this same agency that starts your automobile and keeps it going, and makes the movies and the radio possible for your entertainment.

"But here, we mustn't talk shop tonight. If it won't bore you I would like to show a home movie we have just finished making."

By the time the picture was shown the storm had passed and, after chatting for awhile, we decided to turn in.

I had closed up everything downstairs for the night and was on my way up the hall to my room when Jim hailed me from his open bedroom doorway.

"How about this fan, Ed? I guess I'll have to ask you to show me how it works. There's some sort of mechanism I can't figure out."

“Oh, that’s the time switch, Jim. First, tell me where you want the fan—here by the window? All right. Do you see this wall dial? Watch me! I am going to set it to stop the fan in half an hour from now. That will be eleven-forty-five. Go to bed and forget it. You won’t have to get up and turn it off. At just a quarter of twelve it will shut off automatically, or I will set it for all night if you wish. And now, ‘Good night and sleep tight.’ We serve a buffet breakfast. Come down whenever you feel like it. No maids to bother about and breakfast is very simple to prepare electrically, you know.”

“Oh, you and your simplicity! Now I know what your initials ‘E. S.’ stand for.”

Jim looked at me drolly. It was a way he had when he was pleased with himself.

“Go ahead!” I said. “I guess it’s coming to me. ‘Fire when ready, Gridley!’”

“Electrical Simplicity!” he said exultantly.

I made a pass at him but he had ducked back into his room and the incident, as well as the door, was closed.

By nine o’clock next morning our guests were up and abroad. A breeze had come up in the night and freshened the air considerably. Breakfast was a simple meal with the toaster, egg cooker, coffee maker and the automatic waffle iron right on the table, not only preparing the breakfast with no effort on our part and no steps to take, but serving it hot the moment we were ready for it. You simply *have to eat* a good breakfast when it is cooked so easily and quickly! I know the children eat more just to see these helpful devices work. Everyone was in good spirits and after breakfast Alice and Betty made themselves comfortable out in the arbor. This left Jim and me to ourselves—“to get down to the business in hand,” as Jim reminded me.

I took him over the entire system. First, we went down into the cellar where I showed him the laundry and workshop, pointing out all the simple little conveniences we had installed. He was interested in seeing how the floodlights, used the night before for lighting the grounds, were turned on and controlled, how we heated certain rooms in the Spring and Fall by electricity and washed, dried and ironed clothing by simple, labor-saving methods.

We went all through the house and then out on the lawn and down past the garden to the garage. I was afraid it might be too

much for one session, but Jim said not. He wanted to see everything, to be told what it was for, how it worked and what it cost to operate.

When we had made the rounds I said, "Jim, I've been thinking over this problem of yours and I'd like to pass on to you some of the simple things we've learned. I'm only wondering how to go about it in the most practical, helpful and interesting way."

"Strange as it may seem, Ed," Jim answered, "once in a blue moon I get a real idea. I've got one now. Listen! I've been looking over all this material you have gathered—notes, rough sketches, photographs, and a thousand and one short cuts and easy methods you have discovered. It's all a marvelously human and entertaining story. Why don't you put it into a book?"

By the time Jim and Betty left for home in the middle of the afternoon we had the matter settled. During the Autumn and Winter months which followed, Jim and I had a number of meetings and discussions. Sometimes we met at Jim's old place up the river, where we worked out the details of remodeling the house electrically from cellar to attic, after which we tackled the outbuildings and grounds. But more often in the beginning, we met at my house—down in the shop and "Museum of Electrical Appliances," as Jim called it. And during this time, of course, we were planning the book. All of which explains how the following discourse on "The Electric Home" finally got into print.

The Journey Begins—Consulting the "Route Map"

Now that we are ready to set out upon our adventure along the "Electric Highway" of home comforts and conveniences, suppose we go at it just as if we were planning a motor trip to some actual destination. That is the suggestion I made to my friend Jim at the beginning of our discussions and, since this idea was helpful to him, perhaps the analogy of the motor highway will simplify the subject for my readers, as well.

When you start on a long automobile trip over roads which you have never travelled, don't you consult some friend who has been over them, or else study the route maps, so that by knowing the way and what to expect, you can get the greatest comfort and satisfaction out of the trip?

When we start out on the unfamiliar territory of electricity, we follow exactly the same method. The electric wiring system of the home is like the motor highway. You must master the few simple "signs" and "traffic regulations" before you can arrive at your "destination," which on this trip is a clear understanding of the object of your journey, or what constitutes a completely electrified home.

When you reach this "destination" you can then comfortably enjoy the convenience and satisfaction that a knowledge of electricity gives you, since the more you understand its nature and how it is distributed through the wiring system into all parts of the house, the better you will be able to employ it intelligently and economically for the greater improvement of your house and grounds. You will know how to take proper care of your equipment and appliances and how to add a number of useful services. If you have had the proper training and are mechanically inclined, you may even do some of the work yourself if you wish, and thus acquire the habit of keeping up with modern developments so that you may take advantage of improved devices and little conveniences as they come along.

The purpose of this first trip, then, will be to take up the general considerations of the wiring system, or "Electric Highway." But before we start our journey to see what this highway actually is, we need a little information for the greater interest and ease of further "travel." What we are particularly interested in is what electricity will do for us and how it is controlled. It is the effects that electricity will produce which chiefly concern us.

Electricity Simplified

There are many interesting things about electricity which in themselves would fill a book, but perhaps I can pick out a few that will give you an idea of its simplicity as used in the home.

Electricity is an invisible power called an "electric current." It cannot be seen or heard, it has no weight, and the only space it occupies is in the wires used for its transmission. The nearest we can come to seeing electricity is when a "live" circuit is broken and we see a spark. But we can readily visualize its presence because it is so easily measured and controlled.

Years ago, when gas was extensively used for lighting, this electric spark was used instead of matches for lighting the gas. It was one of the first applications of electricity in the home. Today, however, sparks are out of place in the home, even though they mean much to the automobile engine. Sometimes we hear a noise or a hum in some electrical device, such as a motor, but this is not electricity itself. It is the friction or vibration of moving parts, or the magnetic hum of some loose metal.

Electricity cannot be stored except in small quantities, so that when you turn on a light or put some appliance into use, electricity must be generated in a power house at the other end of the electric highway and transmitted to your home, which may be many miles away. Distance means little to electricity. It travels at a rate equivalent to seven and a half times around the world in a second.

If electricity is passed through wires of certain metals of proper size and length, it will heat these wires. This heat, which is easily regulated and can be confined to small places, is what makes electricity so useful in this connection. We can, of course, supply heat with an ordinary match, but this kind of heat consumes wood and air and cannot be regulated. On the other hand, an electric wire can be heated regardless of its surroundings; that is, it can be heated in the open air, or when imbedded in solid material or placed in water. Electricity consumes no air, and if the wire is of a proper material it is not itself consumed. Furthermore, if electricity heats a small wire white hot, as in a light bulb, it produces light. If it operates a flatiron, toaster, coffee pot, or range, it heats a larger wire which gets only red hot. If it is used in a heating-pad or blanket, it slightly heats a wire but not hot enough to burn. It is simply a matter of choosing a wire of proper material, length and diameter.

The other thing which electricity can do is to operate a motor. This is done by means of magnetism. Magnetism, as you know, is the attraction and repulsion of iron or steel which has become magnetized. This magnetism can be produced and controlled with ease by means of an electric current. It is the production of this magnetism that gives us power for operating our motors and for producing mechanical action. All any motor does is to turn electricity supplied to its terminals into rotating mechanical power at the motor shaft.

I think it best not to go into this subject too deeply, but there are a few simple terms with which everyone should be familiar. When we hear such terms as "volts" and "amperes" electricity begins to seem perplexing, so I will remove this "obstruction" before we go any further and say a few words about these electrical units. They are hard to describe since no one has yet been able to see them and probably never will, but their meaning is easy to explain and understand. The "ampere" expresses quantity, like gallons of a liquid. One ampere is a unit of quantity, and ten amperes are ten of these units, or ten times as much as one ampere, just as ten gallons of water would be ten times the quantity of one gallon.

Before we can go any further we must understand another unit, namely the "volt." No one knows what a volt looks like either, but it is merely the pressure, or we might say the "push," that sends the amperes through a wire. Given a certain wire or other conductor, the more volts, or "push," applied to that wire, the more amperes will flow through it. When a lamp is marked "120 volts," it means that 120 units of electrical pressure, or "push," are required to send sufficient current in amperes through the fine metal wire in the bulb to make the wire white hot. It is the current, or amperes, in this wire that makes it white hot and causes it to give off light. If less than 120 volts, such as 110 or 112 volts, is applied, insufficient current will pass through the wire to heat it properly. If the voltage is 125 or 130, too much current will pass through the wire and will cause it to burn out. Volts are always ready to serve in any "live" or active circuit, but no amperes can flow through that circuit unless it is closed and there is a continuous conductor, or highway, over which they can travel. In order to have current in a wire, therefore, we turn a switch to "on," thus closing or completing the circuit and allowing the amperes to flow. The traffic officer at a highway intersection signals "stop" or "go," or the red and green lights serve to "close" or "open" the road to traffic in a somewhat similar manner.

When all of these amperes flow in one direction through a wire, the current is called "direct current" (D. C.). When current flows first in one direction and then in the other, as it does in most home circuits, it is called "alternating current" (A. C.). The word "alternating" is given to this current on account of the rapidity with which it changes its direction of flow. This change in direction is called

“frequency,” and is expressed in “cycles,” or the number of complete reversals per second.

Whether your home is supplied with A. C. or D. C. is only a matter of the type of generating equipment used by the electric company supplying your electricity. As far as the use of electricity for heating is concerned, it does not matter which type of current is used, but it does make a difference in the case of motor-driven appliances such as washing machines, refrigerators, fans, etc., and most of the sun-ray health lamps will operate only on alternating current, or A. C. Some of the very small motors are so built that they will operate on either direct current or alternating current. This type is called a “universal” motor. In most cases, however, the motors used in permanently installed equipment will operate only on one kind of current—either direct or alternating.

Most of the alternating current provided in this country is what is known as “60-cycle” current. In a few city districts and in some of the rural sections “25-cycle” current is still supplied, but these districts are rapidly being changed over to the more universal 60-cycle current. Motors which operate on 60-cycles, however, will not operate on 25-cycles. This may account for the fact that some motor-driven appliance which worked all right for you in the city would not operate satisfactorily in another location. In purchasing motor-driven appliances, therefore, it is well to make sure that the ones you purchase are equipped to operate on the type of current you have in your home. For this reason I have provided space in the back of the book for you to put down as a memorandum for future reference details of your own home electrical circuit.

The terms “ampere” and “volt” apply to all types of electric current, regardless of whether it is direct or alternating, and regardless of the number of cycles.

Another term, and one which is even more important to the home, is the “watt,” which is a combination of the other two units. Now a watt is equal to one volt multiplied by one ampere. Thus, 10 amperes times 120 volts is 1200 watts. A watt, then, is a measure of the usefulness of electricity, while the ampere measures the amount of current and the volt measures the amount of “push” which forces the current to flow. It is the watts which we really use, and they represent amperes and volts combined.

These watts, then, do work for you by furnishing light, heat or power, and will continue to do your bidding for a second, an hour, a week or a month. Therefore, the length of time during which we make use of these watts must also be considered. The longer the time during which we use a certain number of watts, the more work they do for us, so the number of watts in use, times the number of hours they are used, is the basis for the charge made for our electrical service. Watts times hours are called "watt-hours." In other words, if the 1200 watts we mentioned above were used continuously for one hour, we would have used 1200 watt-hours.

Now these watts are so small, and so many of them are used, that it has been found convenient to designate 1000 watt-hours as one "kilowatt-hour," the prefix "kilo" standing for 1000. Our 1200 watt-hours, therefore, have become 1.2 kilowatt-hours, and it is the kilowatt-hours that we pay for in the bill we receive each month for our electricity. Watts are designated by a "w," kilowatts by "kw.," and kilowatt-hours by "kw.h." Thus, 5 kw. used for 4 hours equals 20 kw.h. ($5 \times 4 = 20$). These same 5 kw.'s used for half an hour would equal $2\frac{1}{2}$ kw.h. ($5 \times \frac{1}{2} = 2\frac{1}{2}$), and if used for only 15 minutes they would equal $1\frac{1}{4}$ kw.h. ($5 \times \frac{1}{4} = 1\frac{1}{4}$). If you want to know the kilowatt-hours necessary to operate a small stove that has marked on its name-plate "110 volts and 6.6 amperes," for $2\frac{1}{2}$ hours, you can do it in your head, it's so simple. Just multiply all the figures together and divide by 1000, which is for the "kilo" I just mentioned; but always change minutes to hours. Here we are: 110 volts times 6.6 amperes equals 726 watts and multiplied by $2\frac{1}{2}$ hours, equals 1815. This result divided by 1000 gives you 1.815 kw.h.

In buying electricity, you pay so much for each of these kw.h.'s. If they are 3 cents each, the cost of operating the stove just mentioned for $2\frac{1}{2}$ hours would be .03 times 1.815 kw.h., or \$0.05445, or nearly five and one-half cents. One great satisfaction in buying electricity, or we can call it buying kilowatt-hours, is the simplicity of measuring them by means of the "watt-hour meter." Page 409.

That's all the mathematics there is to it as far as home use of electricity is concerned. The "calculus tricks" referred to in the "Introduction" only need to concern the engineer.

Before we go on to another subject, I want to say a few more things about volts and amperes. The volts, or "voltage" as it is termed

by the electrician, is always the same or nearly so, in the home. The amperes, however, vary as we use more or less electric appliances or lights.

It is the current (amperes) that heats the wire, and the amount of heat developed depends primarily upon the size of the wire and the amount of current. It requires a larger wire to carry fifty amperes without overheating it than to carry ten amperes. To prevent overheating, we must have wires (or conductors) large enough to safely carry *all* the current to be used. The size of the wire, then, offers a certain "resistance" to the flow of current—the smaller the wire, the greater the resistance and the more the wire is heated in consequence of being "overtaxed" by the passage of too much current for its size. In a water pipe much the same kind of strain would be exerted if too great a volume of water were passed through it under "push," or pressure, for the size or inside diameter of the pipe. If the walls of the pipe were too thin, the combined pressure and volume of water would burst the pipe. In the case of the wire, it would overheat, and if the wire were insulated by rubber walls or other covering, the excessive heat would in time cause injury. So it will be seen that the wires through which electricity passes must be large enough to safely carry the current.

Of course, you know that electricity passes through any metal. For convenience it is usually directed through a wire or, as the electrician calls it, a "conductor," because it "conducts" the current from one point to another. This wire is made of copper, since copper will conduct electricity better or more efficiently than any other metal except silver, and silver is too expensive to use.

Inasmuch as electricity will pass through any metal, we must employ some means of keeping it in the wire so that it will not come into contact with other metals and get off its path. For this reason the wire is covered with a material through which electricity cannot pass. Electricians call this material an "insulator," or "insulation," but

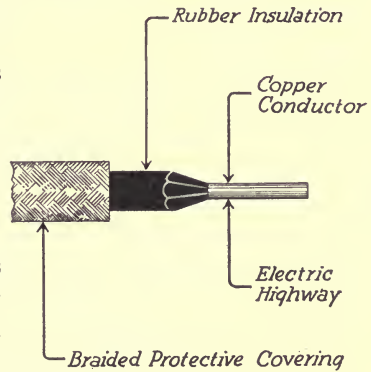

FIG. 1.—Conductor or "Electric Highway"

it is simply a material which keeps the electricity confined to the wire just as a water pipe confines the water which flows through it, as referred to above. This covering, or insulation, is usually of rubber, because rubber is cheap and flexible, as well as waterproof.

Fig. 1 shows you just how the ordinary wire, or conductor, is made. This particular wire is installed permanently in your house and is used where it is not subject to continual bending. From the point where the electricity enters the house until it is finally led into a light-bulb or appliance, various types and sizes of wires, or conductors, are used depending upon the required mechanical strength and the amount of electricity to be carried. It is like main motor highways, branch roads and the individual driveways leading off them—in which the amount of traffic determines the nature or strength of the construction necessary to meet the requirements of service.

When you wish to use some portable appliance where you are continually bending and moving the wire, you use a type made up of many small strands, so that it can be bent many times without breaking. This is called "portable cord" because it connects directly with portable appliances or lamps and is very flexible. This cord of stranded wire is covered with rubber insulation, the same as the larger wire, and two such wires are twisted together and enclosed in a braided cotton-covered or silk sheath. See page 142. The purpose of the two wires will be explained later when I describe the electric circuit.

Now that we have had this preliminary glimpse of the "route map," and know something about the traffic regulations—in other words, have become familiar with the simple electrical terms and their meaning—we are ready to start out upon our first journey over the complete wiring system. In later chapters we will go over the route again and in each succeeding journey we make over this electric highway we will take up in turn, and in logical sequence, each important phase of the subject of "THE ELECTRIC HOME" which you will find in the "Contents."

It may be that you are not interested in the complete electrification of your own home at this time, but of some particular appliance, better lighting, or perhaps in extending your electric highway for greater convenience. For this reason, I am dividing my suggestions into several chapters, making each one as complete as space per-

mits, but this may lead to a little repetition which I trust you will pardon.

To assist you further and to conserve your time, I have placed a brief summary (or sometimes a list of questions) at the beginning of each chapter, and at the beginning of each section of Chapter Five; and this, together with the various sketches and photographic illustrations will, I believe, outline the contents and make it easier for you to find the subjects that interest you most.

And then, to still further assist you, I am calling your attention in the list below to some subjects that may be of especial interest.

The index at the back of the book will enable you to locate quickly any subject desired.

If you wish to:

- Use electricity efficiently, read Chapter Six, page 401.
- Add lights or outlets to your present home, read Chapter Four, page 139.
- Know about air conditioning, turn to page 223.
- Get the most out of your radio, turn to page 267.
- Heat water electrically, turn to page 175.
- Keep cool electrically, turn to page 227.
- Cook electrically, turn to page 318.
- Know about the All-Electric Kitchen, turn to page 363.
- Wash dishes electrically, turn to page 360.
- Laundry clothes electrically, turn to page 179.
- Sew electrically, turn to page 251.
- Clean the house electrically, turn to page 203.
- Kill insects electrically, turn to page 303.
- Get worms for the fishing trip, turn to page 310.
- Use electrical appliances of any kind, read Chapter Five.
- Tell time electrically, turn to page 284.
- Light the yard or garden, turn to page 120.
- Know about electrical toys for the children, turn to page 373.
- Know about the electric shop for the older boys, turn to page 379.
- Wire a new home, read Chapter Eight.
- Look into the future home, read Chapter Nine.



The Electric Home of the Author—1917-1925

Completely electrified for maximum convenience.

85 lights and 32 convenience outlets controlled by 25 switches.

Electric range and electric hot water heater. Auxiliary electric heat for Spring and Fall.

Electrically operated laundry and work shop.

Electrical refrigeration and many labor saving appliances.

Radio wired-in connection with convenience outlets, 1921.

Battery charger and tire pump in garage and electrically operated pump for water system.

Elevated electric railway—2-inch gage—125 feet track with automatic switches, signals, etc., in boys' play room together with motion picture projector in small home theatre.



FOREWORD
To Chapter One

THE purpose of this first chapter, or journey into the great realm of modern electric service, is to make you familiar with the means by which electricity is distributed over the wiring system. I will show you how the "traffic" is regulated on this "highway" and how the "vehicles" of electric current finally reach their destinations in the individual "driveways" leading to light fixtures, permanent electrical equipment and portable appliances in the various rooms and other locations of the home, outbuildings and grounds.

Following is what might be termed a "route card" showing the chief landmarks you will observe in this first journey over the "Electric Highway."

The beginning of the Electric Highway, or Service Entrance.

The Traffic Signal, or Main Switch.

The Automatic Traffic Control, or Main Fuse.

The Main Highway, or Three-Wire Circuit.

The Highway Intersection, or Distributing Panel.

The Forks of the Road, or Branch Circuits.

The Individual Driveways, or Convenience Outlets.

The House Delivery Entrance, or Electrical Connection to Appliance or Lamp.

The Service Doorway (It is either open or closed), or Electric Switch.

The Servant who receives you, or the Light Bulb and Appliance supplied.

Thus, in this manner and sequence, the "vehicles" of electric current deliver their wares to the "Ultimate Consumer."

Chapter One

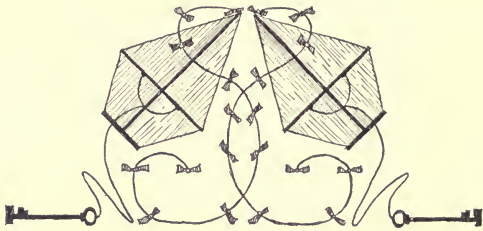

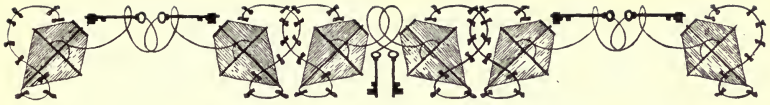

CHAPTER ONE

Electric Highway of the Home

The electric circuit is comparable to a highway system of automobile roads used throughout the country. Just look at Fig. 2, typical of such a system, and then compare it with an electric circuit, shown in Fig. 3. Now on any highway system we have, in addition to passenger automobiles, trucks and other commercial vehicles constantly plying back and forth on missions of service. These trucks load up at their "home garages" and, after discharging their freight, return empty to their starting points.

The electrical system is similar in principle to the highway system since all the electricity that passes through the circuit and does work for you must return to the point from which it started, the same as the trucks which bring your supplies and return empty. This electricity may go to the final loop in the road—that is, to the outlet or lamp farthest away—or it may take a cross road by going through lamps or outlets in the electric circuit nearer to the starting point.

For comparative purposes there are certain "traffic rules" to be considered in this electric highway system. First, it is a "one-way road," all "trucks" proceed in the same direction and at the same speed and can cause trouble only when the highway is too narrow for them all to move at one time. Second, a separate line of trucks passes through each destination or outlet, and when any line is stopped all the trucks in that line stop clear back to the "garage." In terms of the electric circuit, we express this condition by stating that a reduction in current is effective back to the power station. Since this book is concerned only with home electrification, however, in the discussion of the electric circuit which follows we may properly assume that the electric highway begins at the point where electricity enters the house, without following it all the way back to the "garage" or power station.

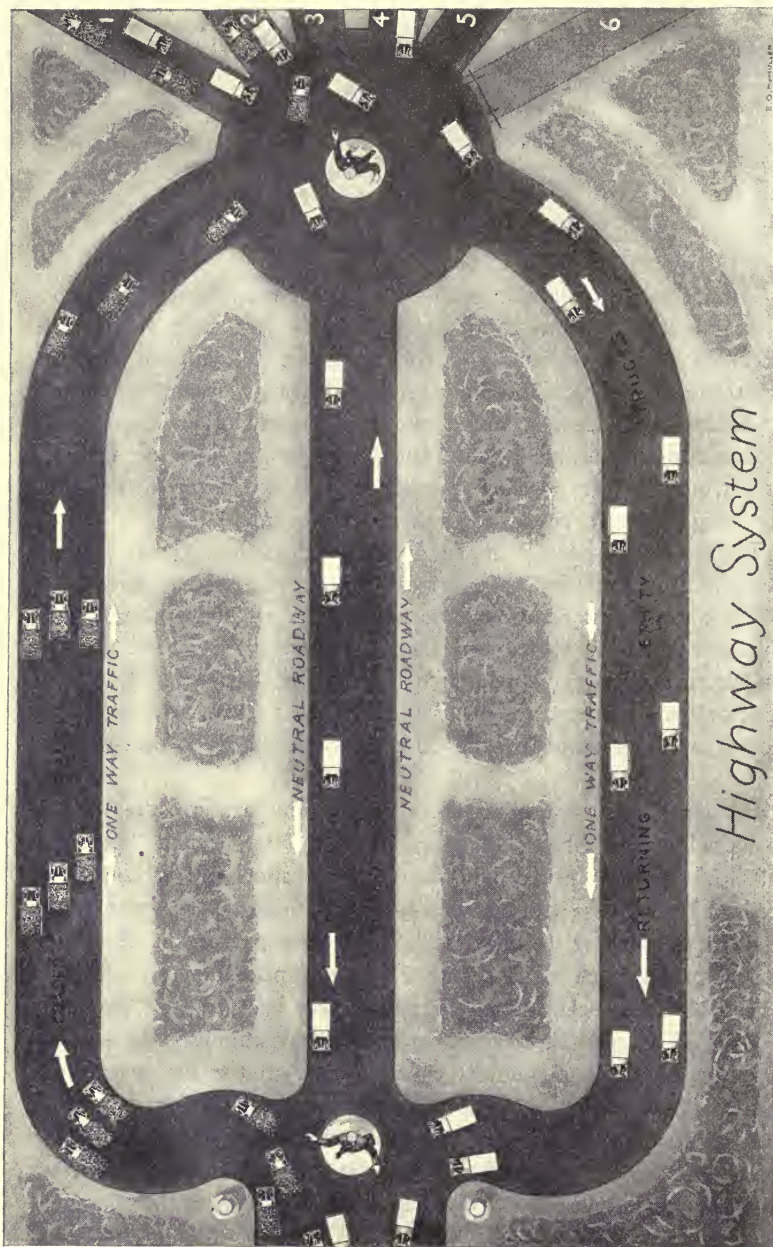
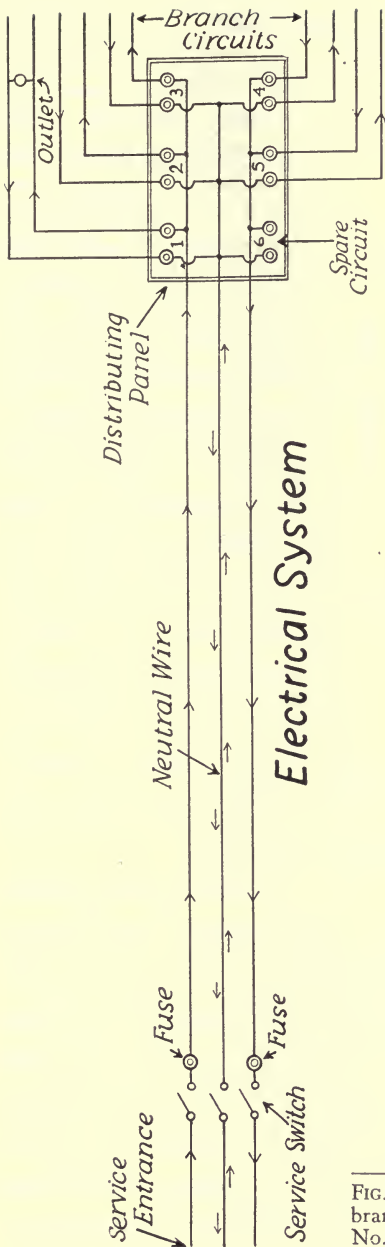

FIG. 2.—Main auto-highway with branch roads, 1 to 5, leading to various communities. Road No. 6 is for future needs. Compare with electrical system, Fig. 3



The Electric Service Entrance

Here we are, then, at the beginning of the road. This beginning of the road is called the "service entrance" because electricity comes into your house through service wires either overhead or underground to a panel located at this point. This service entrance, or service panel, consists of a main switch, meter and fuses.

The panel is not always placed in the cellar or the basement, although that location is usually the most convenient, since meter readers do not need to pass through the house as would be necessary if the panel were in the attic or an upper story. In many southern homes the service entrance is even placed outside the house, usually on the front or rear porch. In apartment houses it is sometimes located in each individual suite, but perhaps more often in the general basement. The modern service panel, as shown diagrammatically in Fig. 4, is enclosed in a steel box.

The meter records the amount of electricity consumed, and from it the amount of your bill is calculated.

FIG. 3.—The electrical system with its branch circuits, 1 to 5, and spare circuit No. 6, comparable to auto-highway system shown in Fig. 2

Just as the highway system is operated under the supervision of traffic policemen, so also the electrical system of the home is placed

under control by means of switches. The main switch controls the electrical supply throughout the entire house, and it is at this point that service may be completely shut off should it ever become necessary. Like every other switch, it is merely a device for opening and closing an electric circuit, or turning on or off an electric current. It works on exactly the same principle as putting an obstacle or a valve inside a pipe to shut off the water or gas. The switch, when open, puts air in between the metal parts of the switch. Since air is an excellent insulator, it acts as an obstruction and breaks the metallic connection in the electric circuit, thus cutting off the flow of electricity.

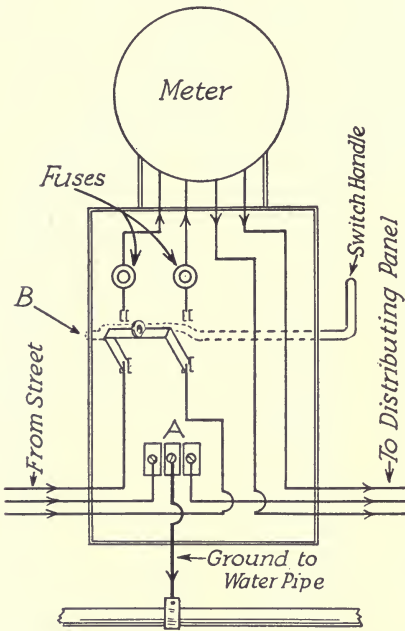

FIG. 4.—A modern service entrance for the electric highway. "A"—special terminal for the neutral wire with its ground connection to the water pipe. "B"—the main switch with its controlling handle outside the box, so that it may be turned on or off without opening the cover

The wider our highway, the greater the number of cars and trucks that can be accommodated at one time. Narrow roads do not give us the service that we should have and, for much the same reason, small-size copper wire on long circuits fails to give us proper electrical service. But an electric circuit, on the other hand, need be no "wider" or larger than its particular service requires, and so on all circuits there must be installed an "automatic traffic signal" to limit the amount of current, or "traffic," to the safe capacity of each electric highway. This regulation is a matter of protecting the circuit and is provided by a fuse which acts as a means of narrowing the highway at this point, thus allowing only a certain

amount of current, or electrical "traffic," to pass. The fuse is the simplest of all electrical devices. It is the electrical safety valve. If too much electricity passes through the circuit, the fuse becomes overheated and "blows." That is to say, a narrow strip of metal within the fuse, made of lead alloy and called the "fuse ribbon," melts and automatically breaks the circuit. Fig. 5.

In terms of the highway system it is like a narrow section which allows only a definite number of cars to pass at any one time. If too many cars try to pass this point all abreast, the highway is automatically blocked, so that no cars whatever can go until the trouble is remedied.

Any break in the highway would also stop the cars and, in the same way, breaking the electric circuit stops the flow of current. If, for example, we broke the main roadway at its beginning and stopped all cars, it would be the same as opening our service entrance switch and putting out all the lights in the house. If we turn off a single lamp or bulb, it is the same as

stopping traffic on a small section of a branch highway. Such a break would not affect any other section of this highway system any more than turning off one lamp affects the operation of other lamps on the household wiring system.

Now that the nature and purpose of the switch and fuse are understood, we will pause for a moment to become acquainted with another "visitor" which first makes its appearance at the service entrance. This is the main circuit, consisting of continuous metallic wires for carrying or conveying electricity. A circuit must have two wires, one of which is a pathway for the entrance of electricity into the house from the street mains, and the other is a pathway for the electricity to travel back again to the source of supply and thus

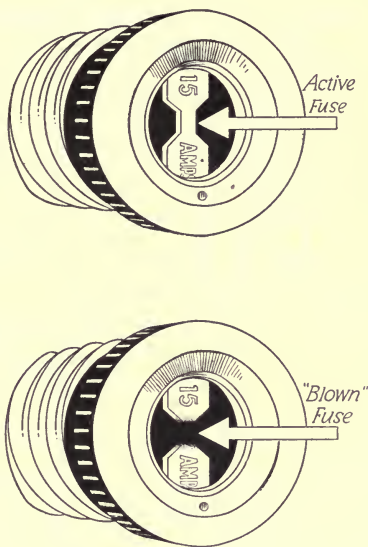

FIG. 5.—A good and "blown" fuse. The "safety valve" of the electric circuit

complete the circuit. The electric circuit may be compared to the continuous belt which travels over the pulleys connecting two machines. The "tight" side of the belt is doing work and the "loose" side may be called the return circuit since it does no work.

You say that you have three wires in your house, and so have we here. This is simply two separate circuits combined, thus pro-

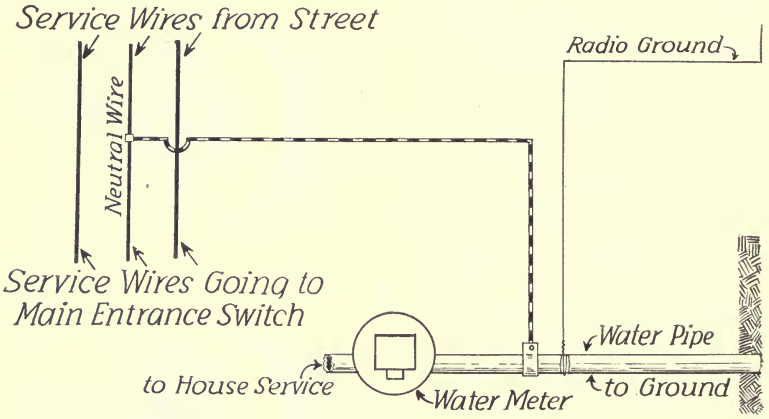

FIG. 6.—The grounded neutral, showing an approved connection

viding a larger highway for electricity to enter the home. Instead of using four wires, two for each circuit, there is a middle wire common to both circuits. This accounts for the three wires, as shown in Fig. 3. This middle wire is called the "neutral wire" since it will form a circuit with either outside wire. The Three-Wire System is an economical method which saves one wire and, by cutting down the amount of copper, lessens the expense of wiring. The neutral wire is connected to a water pipe so as to safeguard the house wiring system. It is therefore also called the "grounded wire," or "grounded neutral." It is simply a connection between one side of the electric circuit, or "highway," and the ground, as shown in Fig. 6. The electrical connection is usually made to a water pipe which makes an actual connection with the ground. The object of this connection is to provide a path for any stray currents, or lightning, to the ground and to keep such disturbances away from the house wiring system. There are many houses supplied with electrical service through two wires, but they are usually either old installations or where a small amount of electricity is required.

Now that we have completed our inspection of the service entrance, let us follow the three wires of the main circuit. After passing through the main switch on the service entrance panel, the electric current goes through these three wires to the distributing panel which contains the fuses for protecting the branch circuits.

The Distributing Panel

In this house the distributing panel is placed in the cellar stairway wall, which you will note is in the central part of the house. The two reasons for this location are: first, to facilitate the replacing of fuses, and second, to minimize the lengths of branch circuits. In a much larger house than this, the distributing panel might be located on the second floor for the same reasons, or there might be two panels, one on each floor. Sometimes it is placed in a closet for convenience and protection.

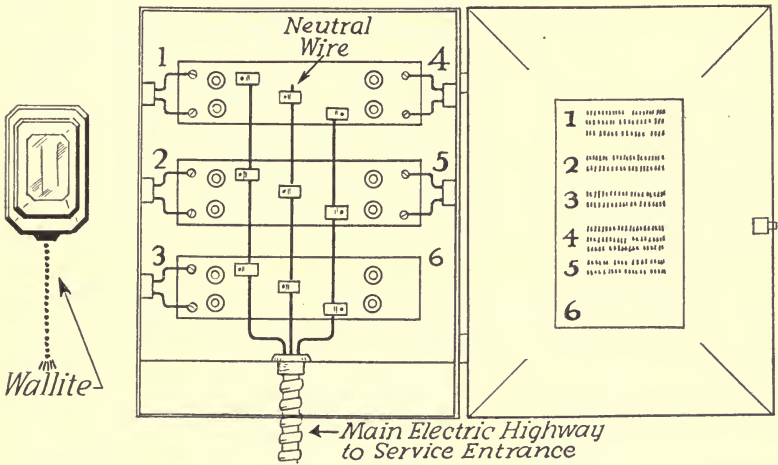

FIG. 7.—The distributing panel where the main electric highway is divided into branch circuits which supply service to various outlets throughout the house. Circuits 1 to 5 in use; No. 6, spare

It is at this distributing panel that our main electric highway splits up into several smaller branch roads leading out in different directions to all parts of the house. Fig. 7.

You say that all your lights were on one circuit in your first summer cottage at the beach. Exactly, but you had only a few

lights, and you needed no distributing panel since the fuse cut-out at your service entrance was sufficient protection for a single circuit.

Whenever larger wires, or conductors, are joined with smaller ones, as at this panel, fuses must be introduced into the circuit in order to prevent too much current from entering the smaller wires and overheating them. Each fuse protects a circuit. In some cases two fuses are used, one for each wire. Now we can see how the fuse for each circuit functions like a traffic officer guarding each small roadway. You will notice that there are six fuses in this particular distributing panel. That means there are six circuits leading from this point into all parts of the house. You may call them "branch roads" if you like. One of these fuses, however, is for a "reserve road" that can be opened up to provide another circuit if we should wish to add more lights or appliances in the house at some future time.

You ask what those numbers are for beside each fuse? Each fuse is marked to show what particular fixtures or convenience outlet it controls. You see that this one is numbered "4," and by referring to the list in the cover of the cabinet you will find that the circuit corresponding to this number goes to the living room side-lights, sun parlor, front hall and coat closet. These numbers, then, are just to save time and make it easy to find which fuse needs replacing in case of trouble by showing you where the outlets on the disabled circuit are located.

You notice this fancy little light at the left of the distributing panel shown in the illustration. This is called a "Wallite" which is operated by small dry cells and is independent of the regular electrical system. It is an auxiliary light in case the regular light on the stairs should go out when its protecting fuse blows or the bulb itself burns out. It provides sufficient light for renewing the fuse or the bulb. We have several of them in other parts of the house, as you will see later on.

Do we use many fuses, you ask? No, we have not burned out a fuse for over two years. You know that if your highways and motor cars are in good repair you will seldom have trouble. In the same manner, if you keep your electrical system up to date and in proper order, you will avoid renewing fuses as well as other troubles.

There is a new device coming into use which takes the place of the fuse. This device replaces the entrance switch as well as fuses in other parts of the system where protection is required. When a fuse blows it must be discarded and replaced with another, but this new device needs no renewal parts and in time may do away entirely with the fuse method of protecting a circuit. It is called a "Nofuze" circuit-breaker and also serves the same purpose as a switch. When the current is excessive the circuit breaker opens the circuit automatically without itself becoming defective, like a blown fuse. All you have to do is to flip the handle which throws the circuit-breaker back into use and closes the circuit. If it is obstinate and "kicks" out again, then you know that something is still wrong, just as fuses may keep "blowing" when you try to replace them. In that case you must locate the trouble.

Branch Circuits

We are now ready to leave the main electric highway and proceed along the various branch circuits. I suggest that we pause here at the fork of the roads, so to speak, while I explain to you the essential construction of these branch circuits.

For properly distributing electricity, several different methods of domestic electric wiring are employed which will be described later on. But for the moment we will consider the branch circuit only in a general sense.

We have seen that the electric circuit—the copper wire highway throughout the house—must run through insulated wires, or conductors. It is extremely important that these insulated wires themselves be encased in some kind of protective covering, or kept away from walls and ceiling. The reasons for this are obvious. The electric circuit must be protected from mechanical injury and rough contacts and abrasions, or there would be constant danger of short circuits and broken wires, causing service interruptions as well as creating fire hazards. We call it a "short circuit" when electricity gets off its track and tries to take a short cut back to the power station, like the automobile that tries to turn around on a crowded highway. There are several methods of protecting the insulated wires, but since I will describe such methods later on we will not stop to go into it now.

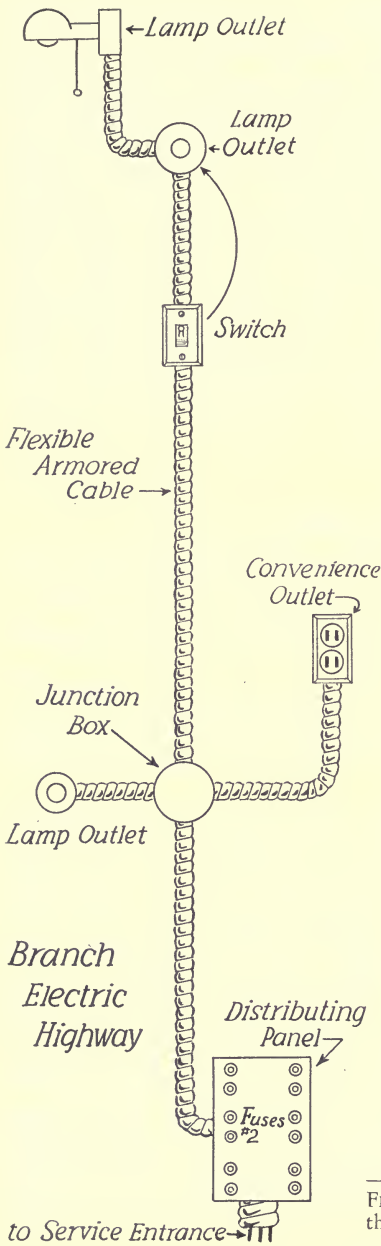

I suggest that we follow one of these circuits and see what it leads to, for every road must have a terminal. Since they are all alike, except that they serve different groups of outlets, we may take any one of these branch circuits. The ceiling of our basement is not plastered, the wiring being exposed, and we can easily follow several circuits until they disappear inside the walls. This is our basement lighting circuit, Fig. 8, marked "No. 2" on the distributing panel. From the distributing panel you notice that the flexible metal conduit enclosing the two wires enters a junction box. Here it is further subdivided and continues on to a convenience outlet, switch box and lamp outlets.

Suppose we now follow along another circuit which leads into the living room—that place in your home where you spend so many evening hours and where you wish to have all those many comforts which the various electric outlets and sockets can provide. Here we are, and I want you to sit down and enjoy the

FIG. 8.—A typical branch circuit with the active electrical conductors properly protected from mechanical injury



Key type—With
bushing for drop
cord



Key type—With
threaded cap for
fixture use



Keyless type

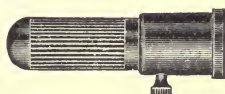

Extension or portable
socket



Waterproof type
for outdoor
use



Chain pull type

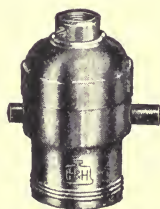

Push-through
type

FIG. 9.—A few of the many varieties of sockets for household use

“scenery,” as it were, while I show you the various points of interest. One terminal of this branch circuit is in the socket of the reading lamp that is now giving us our light. If we were to follow this highway back to its source beyond the service entrance, we would have a long journey since the supply of electricity for our home comes from a power station many miles away.

Perhaps you would be interested in having me show you some of the fittings, especially the later ones, that are employed in modern homes for the use and control of electricity. This can best be done by several sketches and a few words of explanation.

SOCKETS. First of all, a socket is a device for holding an electric light bulb and usually contains a small switch for controlling the light. It is the method of controlling the switch on the socket that gives the socket its name. If a key is used, the socket is called a “key socket,” if by pulling a chain, a “chain-pull socket,” and so on. A socket without a switch is called “keyless.” In Fig. 9 are shown several styles of sockets. For use out of doors, a special waterproof socket is employed. This socket has no switch of its own (keyless), and must be controlled by a separate switch.

SWITCHES. A switch is a device for breaking or completing a circuit—that is, it turns the electricity on or off. Like sockets, switches are made in many varieties. The common forms used in the home are shown in Fig. 10.

The names of most switches are derived from the method used in operating them. Thus a “push switch” is one you push to make it work. A “rotary switch” requires a twist and is sometimes called a “snap switch” because it snaps on and off. A “tumbler switch,” an excellent type for the home, tumbles the switch parts into place when the operating lever is moved.

Again, some switches are named from their location or the manner in which they are installed. Thus a “surface switch” mounts on a wall, while a “flush switch” sets into the wall in the metal outlet box and is flush with its surface. Many switches have the words “on” and “off” stamped on them to indicate whether the circuit is closed or open. Others employ indicator lights, such as you may have on your radio, to indicate the same thing. Another method of indicating whether a switch is on or off is by means of a white dot which is exposed when the switch is on. Still another method is in the use of light and dark-colored “push buttons.”



Tumbler switch, flush type

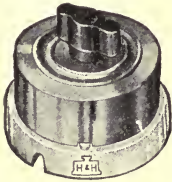

Rotary snap-switch,
surface type

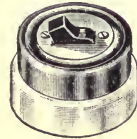

Tumbler switch,
surface type



Push switch,
flush type

FIG. 10.—Typical standard switches

Two more types are the "pendent switch," which resembles a lamp socket containing a switch but having no place for the bulb, and the "knife switch," so called because its movable contacts are like a knife blade. The service entrance switch is usually of the knife-switch type. See Fig. 4, page 38. There are other kinds of switches, such as the "automatic door switch," which works against



Typical pendent switches often used for controlling ceiling lights

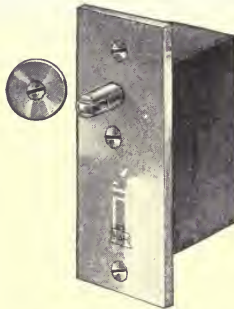

Automatic door switch



Typical portable cord switches used for controlling individual appliances

FIG. 11.—Special switches for special uses

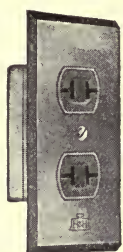

Duplex outlet

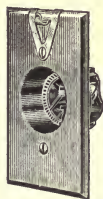

Clock outlet



Fan outlet



Triplex outlet

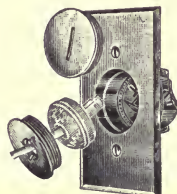

Floor outlet

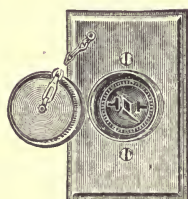

Waterproof outlet

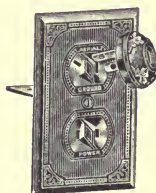

Radio outlet

FIG. 12.—Convenience outlets of many types available for home use

a spring operated by the doors of some motor cars and closet doors in the home. These switches turn on a light when you open the door and put it out when the door is closed. In addition to these, there are various kinds of "cord switches." Such cord switches are usually used for the control of individual appliances. Some of these various switches are shown in Fig. 11.

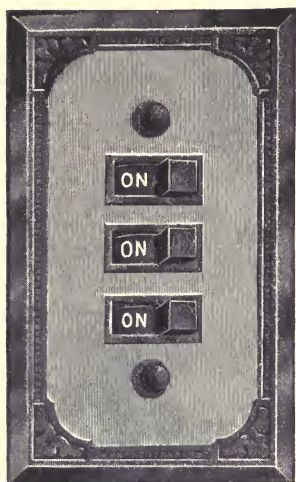

FIG. 13.—To save space and for convenience several switches are often combined in one plate

It is good practice in cases where several switches control the lights in a particular room to group these switches in one location where they will be more convenient. Such switch combinations are called "gang switches," as shown in Fig. 13.

There is still another switch, called the "electrolier switch," which controls various combinations of bulbs on a single fixture. Other types of switches to meet the various requirements of the home are principally variations of the foregoing types.

CONVENIENCE OUTLETS. Convenience outlets are for use with portable appliances and lamps and are usually installed either on the wall or baseboard. Some of them have receptacles for two

plugs and are called "duplex outlets," and some for only one plug, called a "single outlet."

Here are examples of several forms of convenience outlets, so that you may become familiar with them. Fig. 12. They are all that the name implies and should be installed more generously in rooms where portable lamps and appliances are frequently used. Of the nine we have here in the living room, seven are now in use for portable lights and one for the radio. The remaining one is a "spare," available for another lamp, or an appliance as need arises. It is a simple matter to modernize the home wiring system, or highway, since all the fittings I have just shown you are easily installed in place of the older types you may have in use.

Let us now continue and see what I have accomplished in my own home by way of modernizing it electrically.

FOREWORD
To Chapter Two

EVERY man's home is his castle. The kind of home he chooses to live in, and the manner in which he desires to furnish it, constitute those sacred rights of the individual which, however they may be tampered with in the outside social and business world, still are preserved to him in the stronghold of his home.

However uniformly humanity is welded to custom in fashions and other fancies which have to do with external contacts and interests of life, there is not likely ever to be a completely standardized American home. Here, at least, we can depart from the strict observance of custom, exercise our hobbies and personal tastes and put into practice those preferred ideas which create the interesting distinctions in our manner of living.

While I am mindful of the fact that what I have done in my own home by way of modernizing may not be a pattern you can follow in all particulars—for homes, conditions and needs vary, as I have said—yet the trip we are now about to take may suggest a number of advantageous changes you CAN apply, at least in principle.

This chapter covers the following subjects:

The first step in modernizing. How to plan for present and future needs.

What kinds of convenience outlets to install and their location.

Proper switch controls for groups of lamps—a desirable convenience and economy measure.

Sufficient light switches and their convenient locations.

Hints on the practical application of lights and appliances for various rooms.

How to modernize and improve service from door-bell, telephone and chime call-systems.

Some practical time-switch applications.

Where to install "Wallites," "Nitelites," "Indicator Lights," etc., to advantage.

The advantage of connecting certain equipment to separate circuits, use of spare cords, etc.

Special provisions for work-shop, garage, outdoor lighting, children's rooms, etc.

Chapter Two

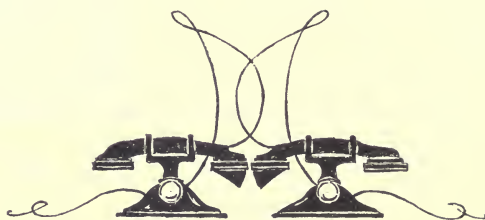



CHAPTER TWO

Modernizing the Home Electrically

If you drove a high-powered, expensive motor car over country lanes and rough backroads, it would cause tremendous wear and tear on the car and result in a fuel consumption per mile out of all proportion to the distance traveled. If you have an inadequate permanent wiring system in your house, you must expect the same inefficiency from your electrical service. To give you proper service from all your electrical appliances, lamps, etc., at a minimum cost, the wiring system must be properly designed and constructed, just like a modern highway system. In other words, you should progress with developments in the electrical field the same as you do in other fields of activity. You would not think of driving a 1907 model car, and yet the wiring of your house may be as antiquated as 1907 methods, even though your house was built at a much later date. For instance, my house is only six years old, and although the architect and builder used good materials and constructed it well, they installed an antiquated electrical system. The house I formerly lived in, which was built in 1917, was far more modern electrically than my present one built in 1927, because the architect and builder of my former house had put in an adequate wiring system, plenty of appliance outlets and many switches for controlling the entire electrical system. By an adequate number of outlets, I mean enough to permit the use of a portable light or an appliance in any part of the house without the need of long connecting cords.

If a new house is being built it is a comparatively easy matter to install adequate wiring facilities at a minimum cost, just the same as building a new highway over a properly constructed right-of-way is more certain to result in a lower-cost construction than if sections have to be torn out from time to time when reducing grades, straightening curves and introducing other improvements. Even if the system is out of date, however, it is in most cases a comparatively simple and inexpensive matter to make changes and extensions that

will give better and more extended service or, in other words, to modernize it. Modernizing is not expensive in the average home.

By modernizing, I mean, first of all, having a properly arranged wiring system, or highway, of sufficient capacity to supply your requirements, and then bringing the equipment, outlets, fittings and conveniences up to date, so that any electrical appliance can be used in any location. That means, of course, installing sufficient convenience outlets and switches for controlling the various essential lights and circuits. (Chapters Four and Eight.)

The important thing in modernizing or building is to know exactly what you want and then to get an up-to-date contractor to carry out your plans. A little thinking and planning will enable you to have practically any convenience you desire. If you are uncertain about what appliances you want, read the advertisements in the magazines, or look in the shop windows and display rooms for ideas and suggestions. My method is to see what we need in the house to benefit first the whole family group, and then to consider the needs and comfort of each individual member, always keeping economy in mind.

In order that you may see what I have done to modernize my



FIG. 14.—The single convenience outlet does not meet the requirements of an active room in the modern home

own home, suppose that I show you through it. Let us start here in the living room, where I have made a few important changes so that the family won't hear me grumble when I sit down to read in the evening. The trouble in the living room was this: Right next to this arm chair I had a portable floor lamp which was connected to the electric highway at the single convenience outlet on the baseboard, as shown in Fig. 14. When the suction cleaner was used during the day it was necessary to remove the reading

lamp connection and put the suction cleaner plug in its place, but when the cleaning was finished, and the cleaner put away, the reading lamp connection was seldom put back where it belonged. As a result, when I sat down to read, I had no light until I got up and put the

lamp connecting plug back again. I had this changed to a duplex outlet, as shown in Fig. 15, and now the reading lamp never has to be disconnected. The spare outlet is available not only for the cleaner but the floor polisher, fan, or any other appliance, as well.

I have had every single outlet changed to a duplex or triplex one because of the possibility of wanting to use several appliances or lamps at the same time. The cost of such a change is small, and the convenience is well worth it. To make this substitution is a very simple job.

At the same time I have made another change which adds to our comfort and will pay for itself, too. In the living room you see we have six portable reading lamps, all connected to the top receptacle of the double convenience outlets like the one I just showed you in Fig. 15. Now, the top receptacles of all these double combinations in the living room are connected to this switch near the entrance from the hall. It was my idea that we should be able to turn off all the portable lights at one time when we retired, so that we would not have to go to each lamp and turn it off separately. The saving that resulted by making this arrangement lies in the fact that no lights are left on by accident all night or during the dinner hour, which often happened before, for now we just turn off the switch and all the lights are out with one snap. The ornamental lights on the bookcase are lighted during the evening and give sufficient light to find one's way about the room when other lights are off.

You are probably wondering how we can use a cleaner when the switch is off. The answer is simple. The bottom receptacles of these duplex outlets are not connected to the switch circuit, but are on a separate highway where the electricity is on all the time, there being no switch. These duplex outlets are made in two types, either for two separate circuits or both receptacles connected together on the same circuit.



FIG. 15.—The duplex outlet for additional service

If we desire to use any of these portable lamps independently of the controlling switch at the entrance of the room, it is only necessary to put the plug for this lamp into the lower receptacle of the duplex convenience outlet. This combination cannot be improved upon for convenience and simplicity.

The double switch here on the wall of the living room controls two lighting circuits, one for the portable lights I just showed you and the other for the side-lights or wall brackets. This side-light switch is arranged to turn on all the side-lights or just two, one at each end of the room. It is called an "electrolier switch" and is designed to control more than one group of lights, or a combination of lights. When the room is not in use we keep only one or two small lights burning. When we want full illumination we merely push the same button again. When these switches are on we can, of course, control all lights from their individual sockets.

Another thing I have done is to add a ceiling light which is controlled by an independent switch at the entrance to the room.

Therefore, you can see that in my living room I can obtain any amount of light that I desire for any occasion. I am afraid this sounds somewhat complicated. It really is not in the least, however, and it serves our needs for the living room to perfection. We require proper lighting for different occasions. For card playing, or quiet reading, local lighting is prescribed. For a gay party brilliant illumination is needed, and for a musical entertainment only soft decorative lighting is called for.

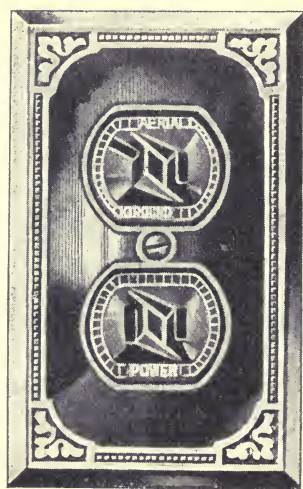

FIG. 16.—A special outlet for the radio, combining power and signal circuits

Over here in the corner I have put in a special outlet for the radio, as I am showing you in Fig. 16. This makes a very satisfactory arrangement inasmuch as it does away with a separate outlet for connecting the radio to the aerial and ground systems. I have had the aerial wire run directly to the roof of the house and the ground wire to the basement where it is fastened to a water pipe

for the ground connection. In addition to this special outlet, another plug connects the radio so that an extension may be made to other parts of the house where I have located loud-speakers for use on special occasions.

The electric chime clock on the mantel was connected to one of the outlets down near the baseboard, but since I never liked the appearance of the long cord, I have put a convenience outlet, such as in Fig. 17, directly on the mantel. This makes it possible to use a cord only six inches long to connect with the clock, a very neat looking arrangement.

Down near the bottom of the fireplace there is a convenience outlet and switch for use with an electric grate. This grate we can remove at any time and have the ordinary wood fire in the fireplace. We use this electric grate on many occasions, especially for decorative purposes, since it gives the room a very cheerful appearance, although it is not effective from a heating standpoint. If we wished a real source of heat from the grate we would have to install an electric heater in it.

Here in this enclosure is a prize package for the hot weather season—an air cooler and dehumidifier. Fig. 18. It is automatic in its operation and certainly adds to our comfort. Air-conditioning is an interesting and important subject for the home owner and I am sure it will interest you, so I suggest that a little later on we go into this subject in detail. (Page 223.)

Let us now look at the entrance hall, where I have made only two small changes. We have a ceiling light, controlled from the upper floor as well as from the lower floor, with switches in each case located at convenient points. I always plan the location of a switch at a point where it will be handy, such as near the front door, the entrance of a room, or at the beginning of a stairway. The lights on the second floor hall are also controlled from downstairs as well as upstairs. We use the ceiling light or lantern for special occasions, but for general illumination we have on the table an orna-

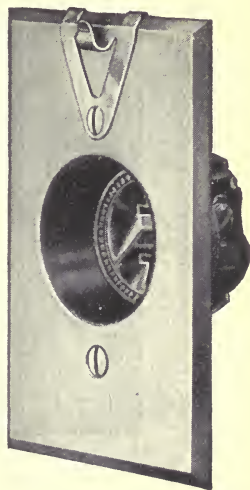

FIG. 17.—A special outlet for a wall clock, provides a hook and requires a short connecting cord. With hook removed it has other uses

mental light which we keep lighted during the evening. We connect this with a duplex convenience outlet of the type in which both outlets are common, or always alive, using the additional outlet for the suction cleaner, floor polisher, etc.

From a point near the front door, where the other switches are located, we also control the entrance lights, house number light, piazza lights, etc. As our house is set quite far back from the main



FIG. 18.—A cooling unit adds to our comfort during warm weather

road I use an illuminated house number which saves us considerable inconvenience, since strangers can see our number without coming into the yard.

I have made an addition here to our coat closet in the lower hall. Since this particular closet does not receive proper light, even in the daytime, I have connected the light in the closet with an automatic door-switch, which turns on the closet light whenever the door is opened. This closet is so located that the door must be kept closed, otherwise it interferes with the passageway. We found that an ordinary hand-controlled light was left on a great deal of the time, because we usually had our hands full of coats or rubbers and did not think of the light; but since the automatic door-switch was installed the light has never been left on when not needed.

In the dining room is the center light controlled from two points, one at the entrance from the front hall and the other at the entrance

from the kitchen. This is an economy, not only of personal effort but also of electricity, since the easier it is to put out a light, the more certain it is to be put out. This center light consists of several lamps which may also be regulated directly at the fixture itself for different degrees of lighting.

Under the table top I have installed a triplex convenience outlet so that we can use three different appliances on the table at one time, such as the toaster, coffee maker, the egg cooker or table grill. In addition to this, we have a convenience outlet on the wall for use with appliances on the tea table.

On the wall, above the window, is a special outlet for the electric fan which I am showing you in Fig. 19. In warm weather we can put the fan on this hook and remove it in the winter, leaving the outlet available for other uses.

We certainly appreciate these conveniences when we look back to the days when we had to connect our appliances to the lamp socket over the dining room table—an arrangement that should always be avoided.

Over the built-in china closet and out of sight, we have an extension for the radio loud-speaker which we can control by a switch located near the china cabinet, since we sometimes wish to listen to special programs while we are dining. This arrangement has worked out very satisfactorily.



FIG. 19.—Special fan outlet, provides hook for mounting the fan

This small push button at the left of the china cabinet connects to our "Telechime," used for announcing meals. The chimes are located in the front hall and when a meal is ready, pushing a button sets them going. A different chime is played for each meal, repeating every third day. These chimes are also connected to a small keyboard which is located at the piano in the living room and various chimes can be played which are very effective in our musical programs.

Before going into the kitchen, we might take just a few minutes to see what has been done in the sun parlor. Here we have several duplex convenience outlets for appliances, cigarette lighters, fans, or our tea table accessories, since we often serve tea out here. In chilly weather we sometimes use a small electric heater, and the children like to use the corn popper and play with their electric toys in here. Over the tops of the windows on this side, we have placed a con-



FIG. 20.—A ventilating fan in the kitchen removes cooking odors

venience outlet for use with decorative flowers. On this wall is a “sun-lamp” which gives us sunshine throughout the year.

It is especially important that the kitchen should have every convenience that electric wiring can provide. First, it should have special attention from a lighting standpoint. Since our kitchen is small, and the walls light in color, we use one large light in the center of the room, but in many kitchens it is desirable also to have a

light directly over the sink and one over the range. Originally this single light was controlled by means of a pull-socket on the ceiling fixture, but we have had it changed since it is better to use either a single switch or two switches located at different entrances, each controlling the same light. The convenience outlets in the kitchen should be arranged so that appliances may be used at any point convenient for cooking. This necessitates several outlets, but when you consider the number of appliances used in the kitchen you will see why several outlets are required. For instance, many of them are in permanent use, because some of the appliances, such as the dishwasher, the refrigerator, the clock and the exhaust fan, are always plugged in, ready for instant service. The clock has a special outlet of its own. The exhaust fan in the window is arranged so as to dispel air from the kitchen or to bring air into the kitchen from outdoors.

Fig. 20. This fan may be removed at any time when not in use. Other daily necessary aids, such as the food mixer and beater, the juice extractor and the toaster, require outlets. For

these small appliances it is especially desirable to have a duplex convenience outlet mounted on the kitchen cabinet. We have a special cabinet containing what we call our accessory appliances, Fig. 21, for mixing and preparing foods.

Inasmuch as the electric range requires more current than portable appliances, it has a special highway, or circuit, of its own and is



FIG. 21.—A complete food preparing outfit and its containing cabinet. A time and labor-saving convenience

wired directly to the service entrance. The new range is a great improvement over the first one I used in 1917, for it heats up much faster and is provided with auto-

matic control. The electric range is so clean and saves so much time in the kitchen, as well as being absolutely safe, that we call it our "master appliance." If you have servants, labor-saving appliances are a great factor in keeping them and making their services more efficient. Labor-saving appliances

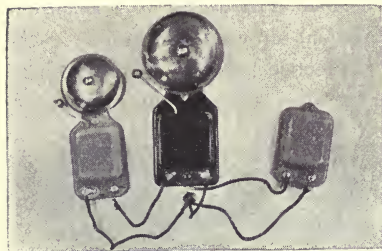

FIG. 22.—Unsightly door bells are unnecessary

are of such outstanding utility in this department of the home that we are gradually coming to an all-electric kitchen.

Over here is a small closet where we keep the suction cleaner and all its attachments, together with the floor polisher—both ready for instant use.

Leaving for a few moments the consideration of lighting and appliances to take up another important subject, I want to show you the improvements I have made in our door-bell system, which have added greatly to the appearance of the kitchen. When we moved into the house it contained several bells, as I am showing you in Fig. 22, which were an eyesore to us all. Now I will show you, in Fig. 23, the up-to-date system I have

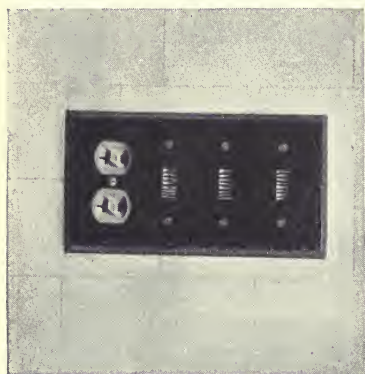

FIG. 23.—A front and back door and dining room signal system, combined with a duplex outlet for electrical appliances, makes a neat and convenient arrangement

installed. This compact arrangement combines our door-bell system with the convenience outlet that we use for the mixer. We have two different bells and a buzzer, one of the bells being for the front door, the buzzer for the back door, and a special mellow-toned single-stroke bell, which cannot be heard in the dining room, for the dining room service.

I have gone a little further than ordinarily is done with these call systems, and at the telephone here in the front hall I have installed a push-button. This button sounds a musical note on three "Telechimes" located in different parts of the house and is used for calling different members of the family to the telephone. A duplicate of this push-button is also mounted near the telephone on the second floor. This little call system is entirely local and the chime can be heard only a short distance. Each member of the family can tell who is wanted at the telephone by the number of notes given over this signal system. It saves many steps, as well as calling from one floor to another, and the system is very simple and inexpensive to install.

In the "refrigerator nook," as we call it, we have a convenience outlet for the refrigerator. This outlet is controlled by a switch which automatically "defrosts" our refrigerator every week, or we may change the interval if we wish. The defrosting switch winds itself electrically, never requires any attention, and has solved our defrosting problem once and for all.

Before we go to the second floor it might be well to look over a few changes I have made in the basement. To begin with, we have a switch at the head of the basement stairs that controls a light for general illumination of the stairs and part of the basement. I have just changed the ordinary switch we found in the house to one with an indicator. Whenever the basement light is on, this little indicator light shows red, Fig. 24, and is a gentle reminder that the light has been left on, since you cannot close the basement door without seeing the indicator light. This general light in the basement is also controlled from another switch in the basement itself. This is not necessary in all homes, but if we remain in the basement for any length of time (as we do in the workshop, laundry, or recreation room) it is economical to turn this light off while we are down there. Another light is located near the oil heater so that we can see any part of the furnace.

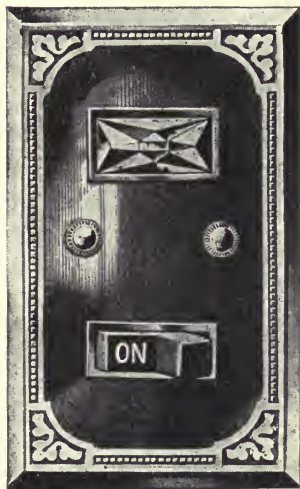

FIG. 24.—Indicator light combined with switch

In the storage room the light is controlled by a door switch, making it unnecessary to use either hand when light is wanted, as one's hands are usually full of supplies.

In the workshop I have a light over the work bench and another one at the side of the room for general illumination. The light over the bench is provided with a neat looking reflector which directs all the light to the bench where it is wanted and allows a smaller light

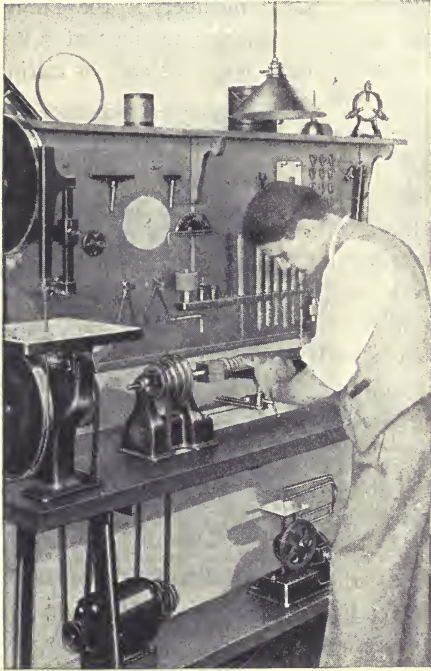

FIG. 25.—A properly lighted shop bench
(See also Fig. 48, page 95)

to be used. Fig. 25. Here I also have several convenience outlets so that we can use any of the handy electrically driven tools or a soldering iron. Yes, the shop is my hobby, but it means much to the boys as well. It is an important factor in their education and keeps their interest at home. It is common ground for solving our household mechanical problems and in making play of what might be work for all. There are several convenience outlets throughout the cellar so that we can use the suction cleaner, bug-killer, or any other appliance.

This small room is a dark room for printing and developing pictures.

It is really just a little corner of the basement boarded off and fitted with a red and a green light for use in developing films, and a white light for general illumination and for printing pictures. Just now we are using special lamps, which I am showing you later, page 133, for photographing some interior movies.

For the oil burner we have installed a special circuit so that, in case of any trouble with other circuits about the house, its operation will not be interfered with in any way. As you know, it is electricity

that makes the oil burner possible. It has a fuse all its own and is independent of everything except our main service switch, which, as I have told you before, controls everything electrical in the house.

The recreation room has a sun-lamp, and here also is a heater for chilly mornings in the spring and early fall. In addition, there are numerous convenience outlets for various portable appliances such as the coffee maker, grill and the like, when we are giving a little party or are dancing. You will note, too, the combination radio and phonograph cabinet we have installed here for just such a purpose. This room is a place for the children and their friends to have a good time in, and a basement room such as this means much to any family. The grown-ups also have their fun, but that is another subject. The installation of the oil burner has made this room possible.

Various improvements made in the basement have given us that extra space which is available in most modern homes and which ours lacked. Notice how clean the basement is. The only way to clean a basement thoroughly is with the suction cleaner and it certainly does a fine job for us.

The wires in our basement were all exposed, as you will see in Fig. 26, but I have re-wired the basement, using the surface metal

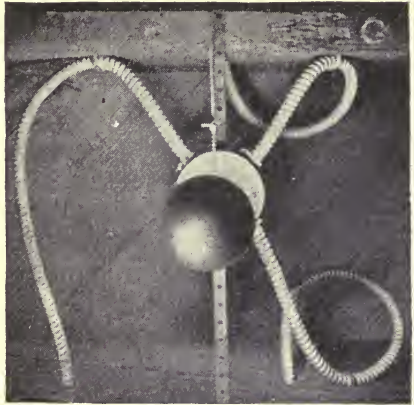

FIG. 26.—In exposed locations wiring should be neatly arranged. Compare with Fig. 27, which shows a better job



FIG. 27.—Surface metal raceway makes a neat job in an exposed location

raceway system, shown in Fig. 27. This system is so very flexible for extensions and neat in appearance that I have also used it throughout our summer camp. It is described more in detail on page 145. Inexpensive metal reflectors have added greatly to the appearance of the basement and have directed the light to where it is needed.

Another of those little "Wallites" I have told you about is placed near the electric service entrance so that, in case of trouble with our main fuse, we have a light that can be used. We also keep several flashlights about the house in handy locations, but in this location I prefer a permanent light to eliminate the possibility of someone misplacing the flashlight.

Over here in the laundry we use a 100-watt daylight bulb with a reflector to make it easier to iron and inspect the clothes. (We also use a daylight bulb in the kitchen, but I forgot to mention it when we were up there.) It helps to bring out proper colors and is better for places where fine work is being done. You will notice that the ceilings and walls are painted cream color, which not only makes the laundry more attractive but reflects the light where it is needed.

The laundry is on a branch circuit or highway of its own. I am proud of the washing machine installation, since I had it connected directly to the water faucets by means of a rubber hose. This makes it very convenient in washing, since either hot or cold water, or both, can be turned directly into the washer. Furthermore, the drain was taken care of directly under the set tubs by means of a second hose, draining the dirty water from the washer into the sewerage system—no bother with heavy pails.

Over here is the electrically heated clothes dryer which we use on stormy days when the clothes have to be dried indoors. As you can see, it is simply a metal cabinet large enough to contain a good portion of the washing, and heat from an electric heating unit in the base dries the clothes as the heat rises in the cabinet.

And here is our ironing equipment—an electric ironer and a 1,000-watt light-weight automatic iron. The convenience outlets that we use for this equipment are fitted with indicators, Fig. 28, to show when the current supplied to the iron is on.

Over here on this hook are several spare cords, ready to connect to an iron in case of trouble with the regular cord. In order to

avoid any delay in ironing it is better to have a new cord on hand to use while the worn one is being renewed or repaired. If these cords are properly handled they will not give much trouble, but in some homes they are abused. We also keep a spare iron on hand. A little later I am going to tell you something about the care of all these appliances (Chapter Seven). They don't need much attention but they must be treated with some respect if they are going to last and give satisfaction.

Before leaving the basement I want you to see our automatic water heater. It is electrically operated and provides us with hot water the year 'round.

Oh, here is something of interest to any home owner—an electric vaporizer for exterminating cold blooded insects, such as water bugs, cockroaches, moths, etc. Even if these are in the walls, under the floors or in clothing, they are driven out by the gas it creates. It has solved a problem for us and perhaps you would like to learn more about it. (Page 305.)

Now let us go to the second floor, where I have done some more modernizing that may interest you. As I told you before, we can control the hall light on the first floor from right here near the stairs in the second story hall. In the same way we can control the light on the third floor. In other words, the light in this second floor hallway can be controlled from downstairs on the first floor, here on the second floor, or from the third floor upstairs. I want you to notice that the light in the lower hall is so arranged that it lights the stairs without shining in your eyes. This is important, since poorly lighted stairs are dangerous, especially for elderly people and children and where a bathroom is located near an open stairway.

In addition to this regular light, we have another little light, a sort of "Nitelite," which we keep on all night and which gives just sufficient illumination in the hall so that we can see our way about comfortably. Too much light wastes electricity and tends to blind a person coming out of a dark room. This small bulb, consuming

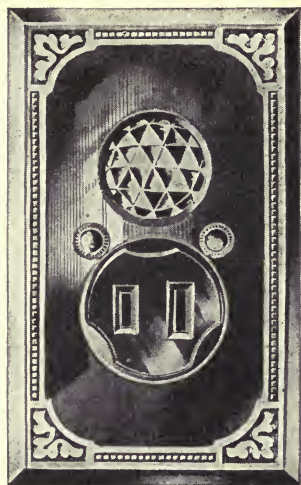

FIG. 28.—Convenience outlet with indicator light

only two watts, lights the entrance to the bathroom and the head of the stairway leading down to the first floor.

Of course, there is a convenience outlet in this hall, which we use especially for the suction cleaner and floor polisher.

Here we are at one of the bedrooms. There is no object in going through all the bedrooms, because this one is typical with the exception of one or two items. At the entrance, of course, we have a switch controlling the lights. In some bedrooms it is well to have two switches to control the lights, especially if there are two entrances some distance apart. We also have a light, more or less ornamental, which gives a dim glow for general illumination and adds charm to the room. It consumes such a small amount of electricity (ten watts), that we let it burn all evening. An outlet is provided in the ceiling so that any time we wish to add a ceiling light everything is ready.

Right between the beds we have a master switch which turns on several special lights on each floor of the house, so that in case of an emergency we can give general illumination to all parts of the home. By means of a second switch next to this one we can also light the yard at any time if we hear anyone prowling around the house at night or want to break up a cat fight. It can also be controlled from the first floor if we wish to have the yard lighted for any special occasion.

This room has an unusual number of convenience outlets so that we can use a health lamp, heating pad, or any other appliance that we may desire. For instance, a special outlet is located near the dresser for use with a curling iron, hair dryer, or other small appliance. And here, between the beds, we have connections for a radio, with the radio itself contained in this convenient "night table." Fig. 29. Here is our electric alarm clock, and over here near the window is another fan outlet, controlled by a time switch in case we should go to sleep and forget to shut off the fan.

Yes, that is a new table, but it is more than a table—it is our electrically operated sewing machine—and what a convenience! When a boy, I can well remember the task I had in working the pedals of an old foot-power machine—the best we had in those days. My mother was making a tent for our camping trip, and my job was to supply the power. I had to get back of the machine and run the foot pedals by hand. This new machine is not only motor-driven, but has no belt of any kind.

This little push-button is connected with the signal system I told you about for avoiding confusion when calling any member of the family to the telephone.

Here is the boys' room where, as I have said, they have an intercommunicating telephone system. This little system of 'phones connects the boys' bedroom, their playroom, the shop and garage. On several occasions it has proved more than a plaything. It helps to round up the children for meals and at bedtime. An automatic time switch is used for shutting off the boys' radio to avoid the possibility of its running all night after they are asleep. On some occasions they like to listen to a program when they are going to bed. It can also be set for turning on the radio to wake them up in the morning.

When we bought the house none of the bedroom closets was fitted

with an electric light so we put in several of the little automatic dry cell "Wallites." By "automatic," I mean that the light turns itself off in case you forget it. We found this was a far less expensive installation for some of the closets than putting in special lights on the regular lighting system, and just as convenient.

Here is another one of the little "Nitelites," placed in the little fellow's room, right next to his bed, so that he can get up alone at night, if necessary. On one or two occasions he has neglected to turn it off and has left it going all night, but its cost of operation is practically nothing.

In here is the girls' room, and they have been putting up some special decorations which are very effective with the colored lights I have given them. They made that pretty shade for the portable table lamp, and it's surprising what can be done if one is at all



FIG. 29.—Combination night table and radio

artistic. The lamp itself was an old one, and the boys converted it from kerosene to electricity.

In the bathrooms we have nothing of especial interest with the exception of sun-lamps which are controlled from a switch at the entrance to the room. A duplex convenience outlet is available for an electric razor blade sharpener or an immersion heater and for a small electric heater on chilly mornings.

The arrangement of our linen closet is such that it doesn't require any special lights, since light is provided from the hall. We did, however, place a convenience outlet near the linen closet so that it could be used for the suction cleaner, floor polisher and moth exterminator.

You will be interested in the children's playroom. It is very carefully lighted, with an evenly distributed light in every part of the room, since children's eyes need considerable protection. Of course there are several convenience outlets. The doll house, which can be moved about and connected to any convenience outlet, is fitted with miniature electric lights controlled by little switches just the same as in the big house. This other smaller doll house is lighted by dry cells and is independent of the house lighting system. We use the little flashlight bulbs in the different rooms of the doll house, in the bottom of which is sufficient room to put the necessary dry cells. This is a perfectly satisfactory and safe arrangement, especially for small children, since some of the larger bulbs get pretty hot and young children might burn their fingers if they should touch them. Then, again, the miniature bulbs contain only a very small amount of glass in case of breakage.

Over here you will note the prize toy—an elevated electric railroad mounted on legs about a foot and a half from the floor, and fastened to the wall so it won't need to be put away. This keeps the children off the floor and simplifies the process of cleaning. The little guards at the curves keep the trains from being damaged in case of a derailment. Also you will notice this provision we have made to get into the closet. It is a little draw-bridge on a hinge which can be opened whenever we wish to enter the closet. The railroad is equipped with all the automatic signals, switches and other things that boys like to play with.

The third floor is well electrified the same as the rest of the house; that is, it is well lighted and has the necessary convenience

outlets. The unfinished attic, however, has a large light for general illumination and also an indicator light mounted on the controlling switch located at the entrance. We find this absolutely necessary, since without such an indicator the large lamp might be left on for days, if not weeks, before it would be noticed. With the indicator, however, this is impossible since it would be seen by some member of the family several times during the day.

This is enough for the house, so suppose we take a look at the garage. Here electricity provides a great convenience. We have two lights in the ceiling of the garage so that each one will be over the engine hood of a car when it is in place, and two others for general lighting, an arrangement which avoids the possibility of bad shadows. Here again reflectors give a better distribution of light and also add to the appearance. These lights are controlled by switches at the main entrance and at the side door. The convenience outlets are arranged for portable lights, for the tire pump, or for a battery charger which we often find it convenient to use. The little work bench in the corner has a light and a convenience outlet all its own.

This small outlet plug near the car is arranged for an auto engine heater that we can put in to keep the carburetor and engine warm during the very cold weather. Of course, the garage is heated, but like many garages it is not fitted with sufficient heating equipment for extremely cold weather.

Before you leave I want to show you a few connections for our outside lighting. Here is a waterproof outlet, shown in Fig. 30, for the Christmas tree placed outside of the house, from which, by means of a rubber-covered cord, we can light up very effectively one of the evergreen trees

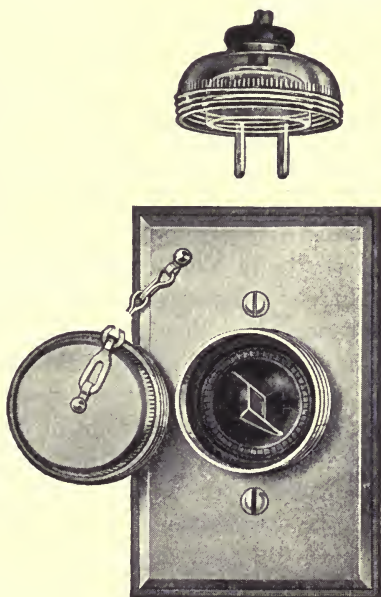

FIG. 30.—Waterproof outlet for outdoor use

in the yard. The attachment plug is also waterproof and when the outlet is not in use it is covered by means of a watertight cap. There are several of these waterproof outlets in different parts of the yard and on the piazza. Into these outlets we can connect not only flood lights but also the electric lawn mower and the hedge clipper that we find so convenient for keeping the grounds in good condition.



FIG. 31.—Portable flood lights extend out-of-door activities

A portable flood light, shown in Fig. 31, is part of our regular equipment and can be stuck into the ground. These flood lights will light a considerable area, and we have used them on many occasions in playing clock golf, working in the garden after dark, for lawn parties and many other purposes. During the winter we use these same lights mounted on a board so that the children can see to coast—and how they do light up the snow-covered ground!

I have shown you how I am using electricity to help us in our home, and it has been an important factor in the happiness of my whole family. Nothing helps more to bring a family together than a convenient, well arranged home, and electricity will provide that convenience.

In our summer camp at the lake we use many of these same appliances, since they give us more time for play. When we replace an appliance with a later model, the older one goes to the camp. The busiest appliance at our camp is the "worm charmer," and it's kept busy getting worms out of the ground for the fishermen. How worms hate electricity! Here is another device that is used in the ground during the spring for heating the hotbed to start the early flowers or vegetables.

Now for some suggestions as to where electricity will help you in your home, whether it is a log cabin, a city apartment, an average home or a palace. So in my next chapter I am giving you a "shining" example of electricity's greatest usefulness, "*Lighting the Home.*"

FOREWORD
To Chapter Three

IN the two trips which we have thus far taken over the Electric Highway of the home—first, to become acquainted with the “route” and second, to check in detail the provisions which have been, or may be, made for greater convenience and comfort—the ground was covered “in broad daylight,” so to speak. In our next journey we will subject this highway to its first real test of service and judge of its adequacy for “night travel” as measured by the facilities for artificial illumination which your home lighting system and fixtures provide.

This chapter deals with the following subjects:

Residential electric lighting in all its forms and for all utility and decorative purposes.

A brief reference to artificial sunlight or “Sun-lamps.”

(For a complete review of this subject from a health standpoint, see page 235.)

Lighting equipment such as fixtures, brackets, lamps, shades, reflectors, etc.

Planned lighting for individual rooms and locations.
Emergency and protective lighting for house and grounds.

All-night lights.

Out-of-door lighting.

Special lighting equipment.

Applications of the electric lamp, or light bulb, to home uses.

Table of lamps, or bulbs, listing sizes in watts, styles and finishes.

Chapter Three

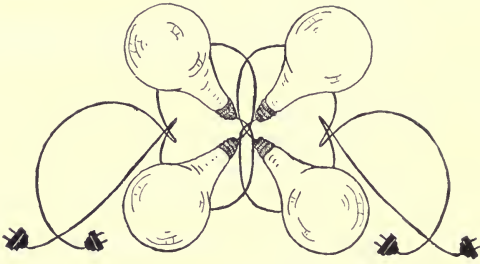



CHAPTER THREE

Lighting the Home

Instant brilliance at the touch of a switch is accepted as the obvious advantage of electric light, but few realize the many other advantages inherent in electric lighting as compared to the more primitive lighting of the open-flame type.

With electricity the lamp, or light "holder," may be turned upside down, concealed in silken folds and within parchment or marble screens, or arranged in any manner and with any materials desired—with adjustable power to do just the kind and size of lighting job required.

Never in the history of man has a means been provided of greater flexibility than the use of electricity. Only in those rare instances when a storm or a catastrophe of some kind interrupts this continuous service and throws our homes into temporary darkness, can we realize how absolutely dependent we are upon artificial light.

Essential as this service has become in our daily life, the mere utility of modern lighting is but a part of its value to us, for the charm which it adds to our homes, the beauty it lends to the furnishings and decorations and the delightful variety of light and shadow which it affords us are continuous sources of pleasure. Proper light is both utilitarian and charming, and this is a rare combination of virtues.

In the earlier days, there were separate rooms for different occasions. There was the usual living room for the family gatherings, the library for the quiet hour, the conservatory for the musical mood and, of course, the parlor where the guests were entertained. Modern homes do not provide these separate rooms for varying moods and purposes. There usually is but one room which serves all such purposes, and this room must be adaptable to all moods—a quiet evening for reading, a dim background for appreciation of good music, facilities for the family gathering and the children's evening study period, as well as for the gay, festive affairs and bridge parties.

Light, more than any one thing, can be fitted to our moods, or made to influence them.

We have plenty of evidence of the power of light—high intensities will stimulate our minds, quicken thought and action; low intensity soothes. It is the same as comparing noon-day with twilight.

If you want guests to be lively and enjoy a long evening, keep a high intensity; if there is a heavy day ahead, adjust for twilight and they will soon consider the comfort of their own beds!

No other feature of a home can play so important a part in adapting it to these varying purposes as can a properly arranged lighting installation. A change of lighting can transform the atmosphere of any room in an instant. And this feature of modern lighting under our present style of existence is equally as important as merely having light by which to see. So, truly, modern home lighting plays a dual rôle: it serves a purely utilitarian purpose and also adds that touch of charm and variety through which a home can express its individuality.

In order to take complete advantage of these two uses of light, considerable care must be given to planning the lighting installation so that all its utility and charm can be used without sacrificing either of these features. There are three considerations to be kept in mind when planning a lighting installation: the method of lighting, the amount of light, and the location of the light source—all depending upon what use you intend to make of the particular room.

Types of Lighting for the Home

The science of light is so simple, so direct, it should prove no puzzle, and with an understanding of its principles more can be done with light to influence the comfort, usefulness and appearance of the home than many realize.

The bare or raw light from a candle caused no eyestrain, neither did the average kerosene lamp or the gas flame, but when applying the incandescent gas-mantle of long ago, some shading device was found necessary.

The early electric 16-candle-power carbon filament lamp was not very bright, and its incandescence extended over a comparatively long filament or light source. This lamp did not produce as much light

as did the better kerosene lamps or the incandescent gas mantle. Therefore, larger ones giving twice as much light, and called 32-candle-power lamps, were made. Incidentally, they consumed more current than our present day 100-watt lamp which develops more than three times as much light.

Today we have electric lamps which produce any desired quantity of light from a small glow-light to that which would light a room at night to a higher intensity than is generally obtained in daytime. Therefore, the quantity of light is unlimited.

The distribution of light generally is considered in three fundamental classes which will be discussed under their separate heads as follows: Direct Lighting, Semi-Indirect Lighting and Indirect Lighting.

DIRECT LIGHTING. Direct Lighting is illumination uninterrupted by any shade to prevent its natural direction. This results in too bright a light source for comfort and creates harsh, disagreeable shadows—uncomplimentary to hostess and guests and even room appearance—which, being caught and reflected by bright surfaces, is most annoying. Therefore, bright, bare bulbs should never be used where comfort or relaxation is desired. Strong, bright light is a tool of the "Third Degree Torture Chamber."

SEMI-INDIRECT LIGHTING. The first improvement made was in the nature of smothering the light with ornamental and obscuring shades. While this overcame excessive brightness, it was done at considerable cost of useful light until some genius conceived the idea of placing this shade below the lamp so that, while shielding the eyes from glare, the upward light was allowed to escape and be reflected usefully from the ceiling. Fig. 32. This method is known as "Semi-Indirect Lighting."

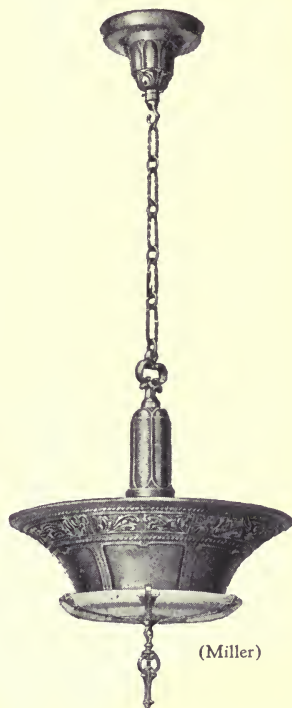

FIG. 32.—Typical semi-indirect lighting fixture

INDIRECT LIGHTING. The next step was total indirect lighting, in which case the shielding bowl was entirely opaque, no direct light was emitted, and the inside of the shade was supplied with a high reflecting surface to secure maximum light effectiveness.

As far as visual comfort and efficiency are concerned, this method is very satisfactory, but the unfortunate result of the use of this type of fixture around the lamp is the dark silhouette of the fixture against a comparatively bright ceiling surface.

The final development for best results is the combination of the advantages of the semi-indirect and the total indirect methods, whereby an indirect fixture is provided with a small glass bottom plate, or by other means the fixture itself is illuminated to relieve the contrast with the light-toned or white ceiling, and thus becomes more pleasing.

Fig. 33. Frosted bulbs are recommended for

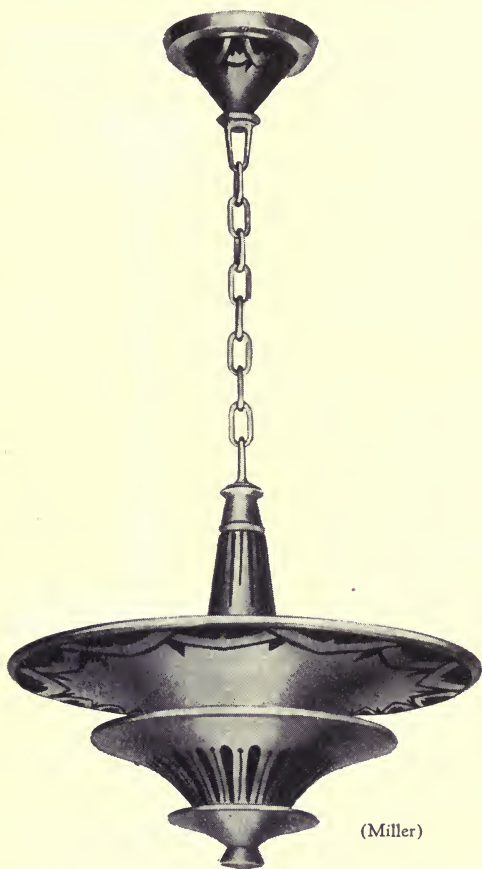

(Miller)

FIG. 33.—Indirect lighting fixture with illuminated shades

indirect lighting since they help to diffuse the light.

COVE LIGHTING. Cove Lighting is a method of securing indirect or semi-indirect lighting for homes. In this type, the bulbs and their reflectors may be completely hidden from view in recesses in the walls, just below the ceiling. Although light from this "cove" is

reflected onto the ceiling as totally indirect light, this method has been given a separate classification since provision must be made in the building plans to make the necessary space available. Fig. 34. Many homes are making use of this type of lighting in hallways and some in dining and living rooms, and even in bathrooms. It offers all the advantages of totally indirect lighting in eliminating shadows



FIG. 34.—An example of cove lighting bordering the ceiling

and avoiding glare, but is somewhat more costly to install than other types and consumes more electricity for the same volume of effective illumination. In homes already built, where it is desired to employ cove lighting, decorative forms of translucent material may be obtained for concealing the bulbs.

DECORATIVE LIGHTING. Another class of lighting, and probably the most interesting, is decorative lighting. The possible variations in lighting ornaments, decorative fixtures, specially concealed lighting in bookcases, china closets, fireplaces and halls are practically unlimited

and afford a marvelous opportunity to express individuality and taste. Have you ever held a piece of fine china up to the light to enjoy the picture presented by transmitted light? A lovely plate, cup, bowl or vase concealing a small bulb will make such a treasured ornament much more attractive. Makers of finest china already recognize this and have made special ornamental pieces, some purely ornamental, while others add a very practical value of useful light. Fig. 35. There is available a small bulb which is shaped and colored to represent the flame of a candle. It may be mounted directly in the top of a real candle, taking the place of the wick, and the wires

concealed in the candle by drawing them through the duct provided by the removal of the wick. It is then a simple matter to connect them to an outlet. Such bulbs are operated in sets of five and burned in series, the same as the miniature Christmas tree bulbs.

Decorative lighting for particularly festive occasions, such as Christmas, Hallowe'en, birthdays and the like, is becoming more and more popular. Just a few of the many lighting ornaments are shown in Fig. 36, while Fig. 37 illustrates some of the



FIG. 35.—An illuminated china vase makes an attractive ornament

ways in which decorative lighting may be used for special occasions inside the home.

ARCHITECTURAL LIGHTING. There is another method of illumination just entering the realm of home lighting which might be termed direct lighting, but because of the construction of the equipment I have put it into a separate classification. This new practice is to install built-in lighting equipment. This built-in type, also referred to as architectural lighting, is usually recessed into the walls or ceiling so that the frosted or diffusing glass is practically flush with the finished surface. Fig. 38. Behind this glass is placed an inexpensive reflecting surface of metal and the bulbs are mounted in sockets between the reflector and the glass.



FIG. 36.—Examples of illuminated ornaments



FIG. 37.—Decorative lighting for festive occasions

These fixtures are becoming quite popular in some of the larger homes because of their modern appearance. This type of lighting should be considered early in the construction of new homes, so that provision can be made for the metal boxes to contain the bulbs. It may be installed in old homes by cutting into the walls or ceilings.

ARTIFICIAL SUNLIGHT. The increasing popularity of "sun-ray" lamps which yield the health-giving ultra-violet rays, warrants a

brief discussion of this new type of lighting, which adds another health appliance to the list already in general use. The invisible rays of the sun which are really of greater value to our health than those which we can see, are developed by this new type of bulb. This bulb also provides light for general illumination. Sun-ray bulbs cannot be used directly on household lighting circuits unless provided with a transforming device for the special voltage required. For this reason they cannot be used in ordinary sockets. However, there are available



FIG. 38.—An example of architectural lighting bordering the ceiling

many designs of ceiling, bracket, floor and table fixtures properly equipped for sun-ray bulbs so that they can be connected into any outlet. Fig. 39. I shall discuss this new type of lighting from a health standpoint in Chapter Five.

IN GENERAL. One thing that always should be kept in mind when planning any type of lighting, particularly of the home, is to avoid any possibility of glare. Even the modern frosted bulbs, while much less glaring than the clear glass bulbs, are nevertheless uncomfortable and trying, and should be shaded. We are all familiar with the blinding glare of the automobile headlights as they approach us on a dark highway. If you are back of these lights in the driver's seat, you can see clearly what is ahead since the lights are properly

shaded. The glare from an ordinary light bulb is not quite so intense as the concentrated light of an automobile headlight, but if one's eyes are subjected to even this less intense glare for any length of time there is a very noticeable eyestrain.

The bulbs in all fixtures, therefore, and of course in all portable lamps, should be shaded so that it is impossible to see the bulbs themselves. The only exception to this rule is in the use of the very small decorative bulbs, such as the flame-shaped bulbs, sometimes used in ornamental candles and bracket fixtures. These small bulbs do not give any great amount of light and the frosted glass, with its tint of color, is sufficient to protect our eyes against the strain of glare.

Another condition which involves this matter of eyestrain, and hence the amount

of light recommended, is the variation in the intensity of the light to which the eye must adjust itself. It is not a good thing to have a single lamp lighting up a page which one may be reading, with no other light in the room. There should be a certain amount of general light so that when the eye strays from the page, as it does continually even without our knowing it, it does not have to adjust itself to too great a difference in the amount of light. Insufficient light when reading or doing close work requires greater effort and wastes human energy.



FIG. 39.—A combination fixture providing both health rays and general lighting

Before we can decide on the amount and location of our light, provision must be made for the light source, so the first step in planning an individual lighting installation is, of course, to determine the route of the electric highway which is to serve us. In the average home there are three locations for lighting outlets. As was pointed out in Chapter One, an "outlet" is the term used to designate the point at which the lighting equipment is connected to the wiring system of the home. First, there is the ceiling outlet for overhead fixtures, then the wall outlet to serve brackets, and finally the convenience outlet for the connection of portable lamps. Each of these types of lighting is going to play its part in providing us with illumination to meet our needs, and each must be considered in laying out a wiring installation for new homes, or in revamping the wiring of present homes. The electric highway from the main service entrance to each outlet must first of all be sufficiently wide to carry the traffic, and also sufficiently complete to provide light at any point where it may be desired.

How to Secure the Best Lighting Effect

CEILING FIXTURES. There has been a tendency until recent years to eliminate this fixture, but that practice was due primarily to the fact that the only fixtures available shed a cold, barren light and were actually uncomfortable because of the glare of the bare bulbs which usually were used. Even with the frosted bulbs the glare was annoying and, gradually, as this annoyance was relieved by turning out the center light, it was felt that the location of the light, rather than the type of light it shed, was the objectionable feature. Modern ceiling fixtures are entirely different. They are shaded to prevent the glare and the shade provides a diffusion of the light, often creating a tent of color which softens the light and sheds a warm, radiant glow instead of the uninviting cold glare of the bare bulb fixture.

Every active room in the house should be provided with at least one ceiling outlet controlled by a wall switch. Light coming from overhead is most natural and it is difficult to provide that degree of general illumination required for the gaiety of an evening's social function without a good center fixture.

Another important consideration of ceiling fixtures which has led to their retention and increasing use is the improvement made in their design in recent years. Early electric fixtures, Fig. 40, followed the

lines of former lighting equipment which depended on the use of oil or gas. This was a natural development, but there was really no reason for continuing to build fixtures originally designed for the old-fashioned candle, oil- or gas flame. Electricity provides light without requiring air and without giving off oily soot so that the fixture does not need to be pointed upward, and no provision need be made to take care of heat or smoke, such as was thrown off from the open flame. Modern fixtures, therefore, can be built comparatively close to the ceiling, and can be constructed so as to fit into the architectural design and balance of a room instead of having to be suspended away from the ceiling, thus interfering with that clear sweep of vision which creates a feeling of spaciousness.

A number of these modern fixtures are shown in Fig. 41. These new fixtures do not mean that the charm and artistic design of the old craftsmen need be entirely forgotten. In homes where there are period motifs in the architecture, electric fittings may be designed in artistic harmony with the characteristics of that period. In practically every case, however, modern practice requires that the bulbs in this type of fix-

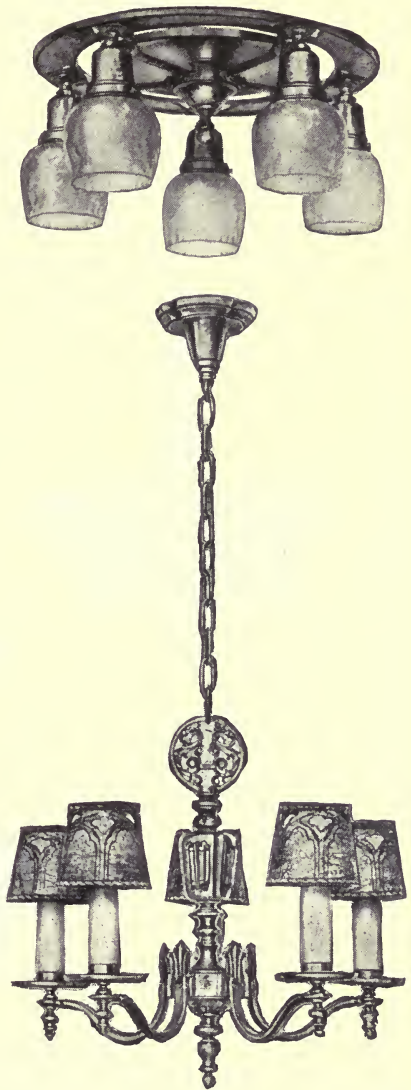

FIG. 40.—Early examples of electric fixtures



(Miller)

FIG. 41.—Examples of modern ceiling fixtures

ture should be properly shaded if the glare of the bare bulb and the consequent cold, barren light are to be avoided.

So much for the ceiling fixture which, as now designed, should constitute a part of every complete lighting installation.

WALL BRACKETS. Brackets, except those designed especially for totally indirect or semi-indirect lighting, should not be relied upon as sources of general illumination. They are principally decorative and afford delightful spots of color, or areas of contrasting light and shadow. Since brackets are usually fixed at about eye-level their light, when sufficiently strong to serve as part of the useful illumination, is annoying and uncomfortable unless shades or reflectors are provided to direct this light and obscure excessive brightness.

Particular attention should be paid to the location of brackets. Usually they should be located in pairs and balanced, with respect to both individual wall spaces and the room as a whole. Balanced pairs are usually most effective; that is, if the room has a pair at one end, it should have a pair at the other end. In some locations a pair of brackets at each end of the room is impractical, but in such cases at least one bracket should be installed to balance a pair on the opposite wall so that the lighting fixtures of the room will not appear unbalanced. Brackets should also be located with particular attention to the natural disposition of furniture and pictures. For this reason they should usually be placed at the ends, rather than in the center of wall spaces. In order to avoid the bother of lighting individual brackets, they should be controlled by wall switches near the entrance. It is good practice to divide the brackets in a room between two switches so that part, or all, of them can be turned on at one time. In this arrangement the balanced pairs should be switched together so that the lighting balance in the room will be maintained.

The selection of bracket fixtures for any room should be based primarily upon its furnishings and the decorative effect desired. A number of modern brackets are shown in Fig. 42. For the bathroom, summer cottage, or other locations where it is desired to combine a convenience outlet with a light, Fig. 43 shows a type of bracket for such applications.

As has been said, all bracket lights should be shaded to prevent glare. If your present home is equipped with the rather old-fashioned candle type of bracket, attractive silk or parchment shades or shields, which one can make or purchase at low cost, will add decidedly to

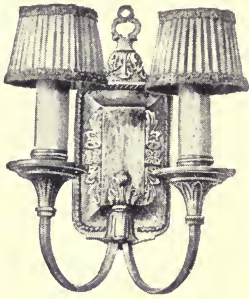

(Miller)

FIG. 42.—Modern bracket fixtures

the effectiveness of the side-wall lighting. There are also available what are called "adaptors," which will convert the ordinary wall bracket into a semi-indirect light, allowing the use of a larger bulb and thus adding to the general illumination. Fig. 44.

PORTABLE LAMPS. There are many types of floor and table lamps and their selection should be based on the color scheme desired, with due regard to the type of light which they afford. Shades, of course, are needed on these lamps the same as on brackets, and these should be open at the top so that some of the light will be directed to the ceiling and walls to furnish general illumination. Portable lamps, in addition to being useful as light sources, are extremely decorative in themselves and also serve to unify furniture groupings. The bridge type of floor light is a necessity for any close work. No desk or table with its accompanying chair would be complete without its floor or table lamp, and even a davenport or chaise-longue is always more attractive with a lamp on an adjoining end table, or with a nearby floor lamp for reading completing the group.

Totally indirect lighting as now obtained by floor and table

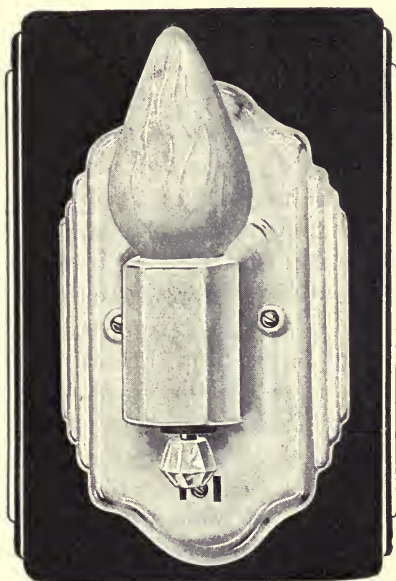
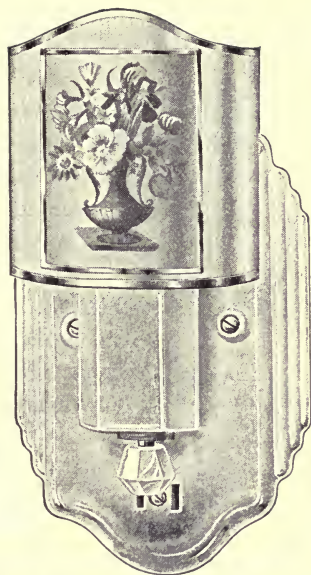

(H.&H.)

FIG. 43.—Combination bracket light and convenience outlet, with and without shade

lamps, is becoming quite popular because of the even distribution of light which it provides. Such lamps are usually equipped with one large (200 or 300 watt), or two or more smaller bulbs, and are particularly useful for general lighting as when piecing jig-saw puzzles, or playing bridge without an adequate ceiling light. Fig. 45. They are also made with additional smaller bulbs which serve to illuminate a silk or parchment shade and give the appearance of the usual portable lamp.

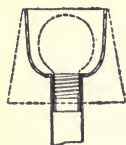

FIG. 44.—Adaptor for converting wall bracket into semi-indirect light

A very flexible arrangement is shown in Fig. 46, which combines the advantages of both the indirect and the direct lighting in a floor lamp. When the shade of this lamp is in its downward position, a small bulb, 60 watts or less, is used. If the shade is tipped upwards towards the ceiling, a larger bulb, 150 watts, is automatically turned on and the lamp becomes one of the indirect type.

Another lamp of equal usefulness is shown in Fig. 47, and contains both large and small bulbs, some of which are used as in a regular floor or table lamp, while larger bulbs are used for the indirect lighting. All bulbs are under the control of a switch conveniently located on the lamp support under the shade. By the use of either or both of these lamps a very flexible arrangement for lighting any room may be obtained.

The height of a reading lamp beside a chair is important, depending largely upon the location in which it is to be used. A height of 44 inches from the floor to the bottom of the shade is usually satisfactory for a chair-side lamp. A tall lamp on a table beside a low chair is unsuitable, for then the light shines in the eyes of anyone sitting in the chair. In such a case a better choice would be a lamp with a low base and a spreading shade. This would do away with any possibility of the light reaching the eyes and throwing illumination beyond the book or paper one is reading.

In the average portable lamp the socket, or sockets, are connected by means of lamp cord to the attachment plug, the cord passing through the lamp support, which is hollow. In such cases supports should not be turned, since this would tend to twist the cord and strain it. Some modern lamps are provided with a special connection between the base and the sockets which conducts the current to the

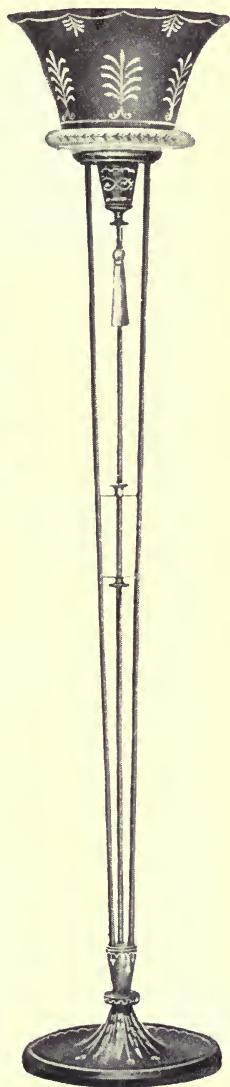
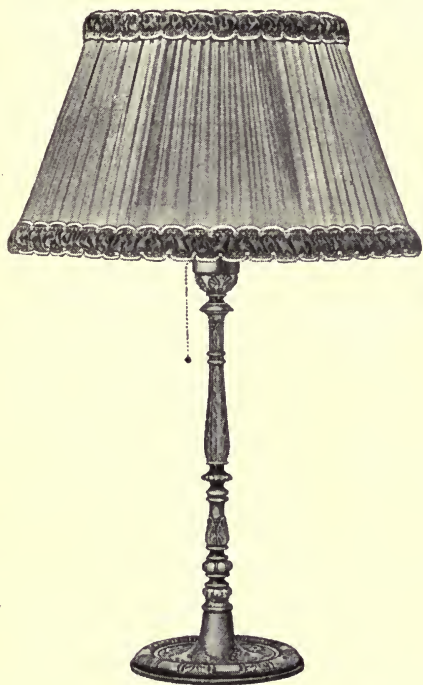

FIG. 45.—Indirect floor and table lamps

(Miller)

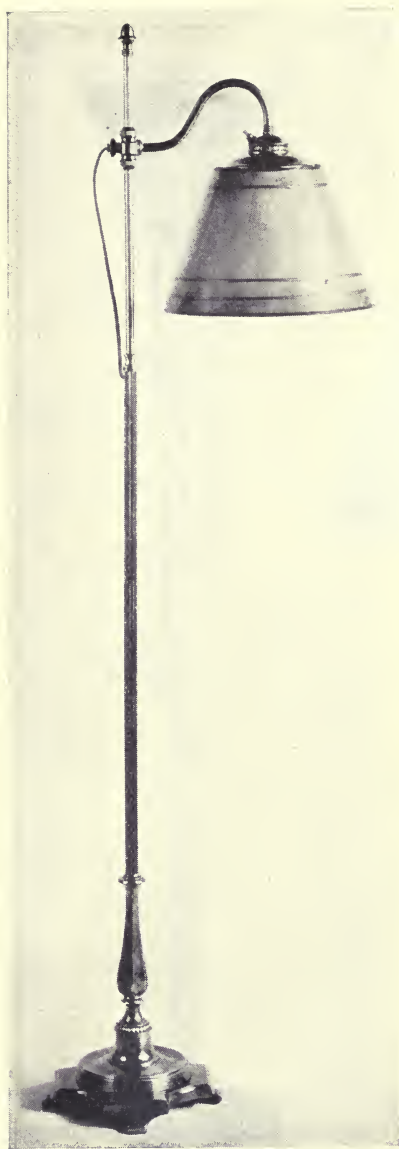
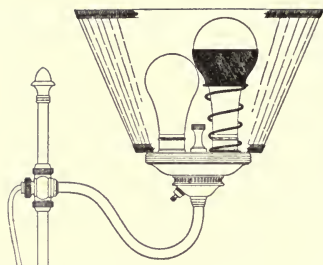

FIG. 46.—“Bi-flector” combination bridge and indirect floor lamp, in position for direct lighting



With shade in its inverted position, lamp becomes “indirect”

bulbs without the usual connecting lamp cord. This permits the stem of the lamp to be turned in any position since there is no cord to become twisted.

The increasing use of portable lamps connected to convenience outlets or wall plugs is correspondingly reducing the number of wall brackets now being installed. Floor and table lamps, movable at will, can be adapted to any arrangement of the furniture while the more or less permanent location of the brackets sometimes interferes with carrying out a particular scheme. Every home-maker tires of a fixed arrangement of furniture and it is common practice to vary the decorative scheme occasionally, even with the same furniture, by moving it about and changing the groupings. With this in mind, and the thought that new furni-

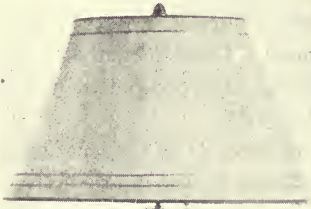
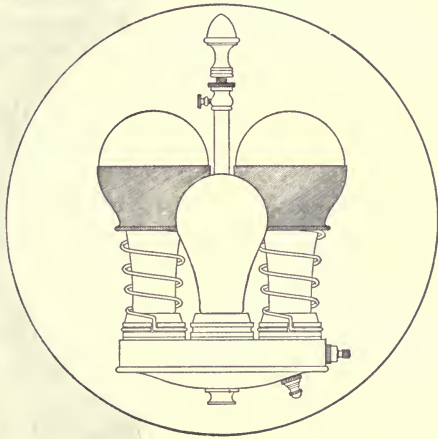

FIG. 47.—“Bi-flector” floor lamp used for both direct and indirect lighting provided with large and small bulbs



The large bulbs with reflectors are used for indirect lighting. The small bulbs are used for direct lighting, independently, if desired, of the large bulbs



ture, as well as new appliances and lamps, may be added from time to time, the arrangement of the convenience outlets should not be governed by any particular furniture grouping, nor by merely providing for the use of present equipment. Convenience outlets should be installed with provision for serving any equipment which may ultimately be used in that particular room.

The following rule will cover most cases as to the location of convenience outlets to serve portable lamps in the more active rooms such as living room, library, bedrooms, playroom and the like:

Convenience outlets (duplex of course) should be so placed that no point along the floor line in any unbroken wall space is more than six feet from an outlet and so that there will be at least one outlet in every wall space of three feet or more in length.

The basis for the six feet in distance is that cords on most lamps are about six feet long. With the suggested arrangement it would mean that the outlets would be not more than twelve feet apart. In short wall spaces there is very likely to be a small table, a radio, or a reading chair which will need an electric connection, and if there is no outlet provided in such spaces it would probably be necessary to run an extension cord across a doorway. Such extensions are not only unsightly but often unsafe, since the insulation of the cord is likely to wear due to being stepped on, the wires then becoming exposed and causing short circuits.

SHADES. There are many varieties and styles of shades made of glass, silk, parchment and other materials for use on lamps or fixtures of any type. Those best adapted should be chosen. Shades should be shaped so as to throw the light where it is needed and should have sufficient depth to prevent the light bulb from being seen. Shades open at the top permit light to strike the ceiling, thus adding to the direct lighting from the shade itself. If shades are lined, the linings should be of light-colored material so that the light from the lamp will be well reflected. Dark green, red and deep blue absorb a great deal of light and should be avoided. The color scheme of a room is often distorted by the strength of these colors, and the beautiful appearance of the shade in daylight is destroyed at night when the lamp is lighted. Sometimes a tinted inner lining, giving the light a touch of color, can be used with good effect.

In general, the decorations of a room are best served by shades of pale colors. Omitting pure white, those glowing colors, tints, shades, and light-colored mixtures of gold, rose and yellow that give the effect of sunshine, are safe choices. They give the greatest amount of light and the quality is very pleasing.

Shades should be sufficiently translucent to allow enough light to pass through without showing the outline of the light bulb.

When selecting shades of any kind be sure that they will fit the bulb or shade-holder used with the lamp socket. For sockets which have no provision for a shade or shade-holder, special adaptors are available upon which a shade can be mounted.

REFLECTORS. Reflectors, as their name implies, are used for controlling the direction of all the light rays. They differ from shades which filter and diffuse light.

For lighting the basement, garage, laundry, shop, etc., steel reflectors as shown in Fig. 48, used with frosted bulbs, give a good distribution of light and tend to improve the appearance of the room. They direct the light to where it is most needed, and their use is strongly recommended. Here again, reflectors should have a type of holder to fit the particular sockets on which they are to be used. In cases where reflectors are required, and no shade-holders are provided on the sockets or receptacles, the special adaptor may be used.

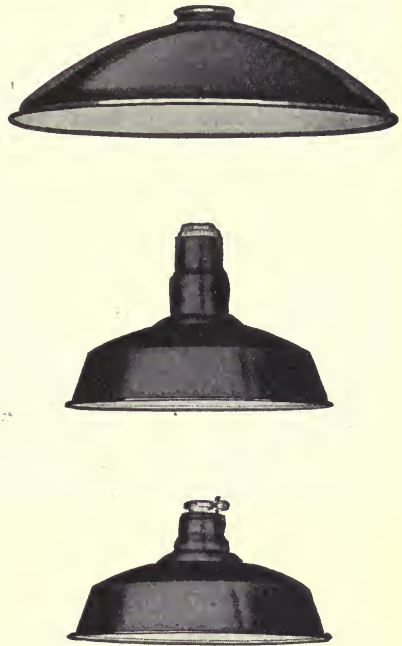

FIG. 48.—Typical metal reflectors for use in the basement, shop, garage and similar locations

Planned Lighting for Individual Rooms and Other Locations

As you have probably decided by this time, there is considerably more to the problem of planning proper home lighting than merely putting a fixture on each outlet. This use of electricity in the daily life of every one of us is so important in respect to our health, and



FIG. 49.—Early lighting installation with its glaring ceiling fixture. Compare with modern lighting methods shown in Fig. 50

particularly in eliminating eye-strain, as well as in the charm and individuality of our homes, that careful consideration of the subject is necessary. With this in mind, having covered home lighting in a more or less general way, there are certain special applications of light to individual rooms which warrant further study. To illustrate how proper lighting helps to make a room more homelike, just compare Fig. 49 and Fig. 50. These show the same room first lighted by a glaring center ceiling fixture, and then modernized by the use of portable lamps, wall brackets and a modern non-glaring ceiling fixture.

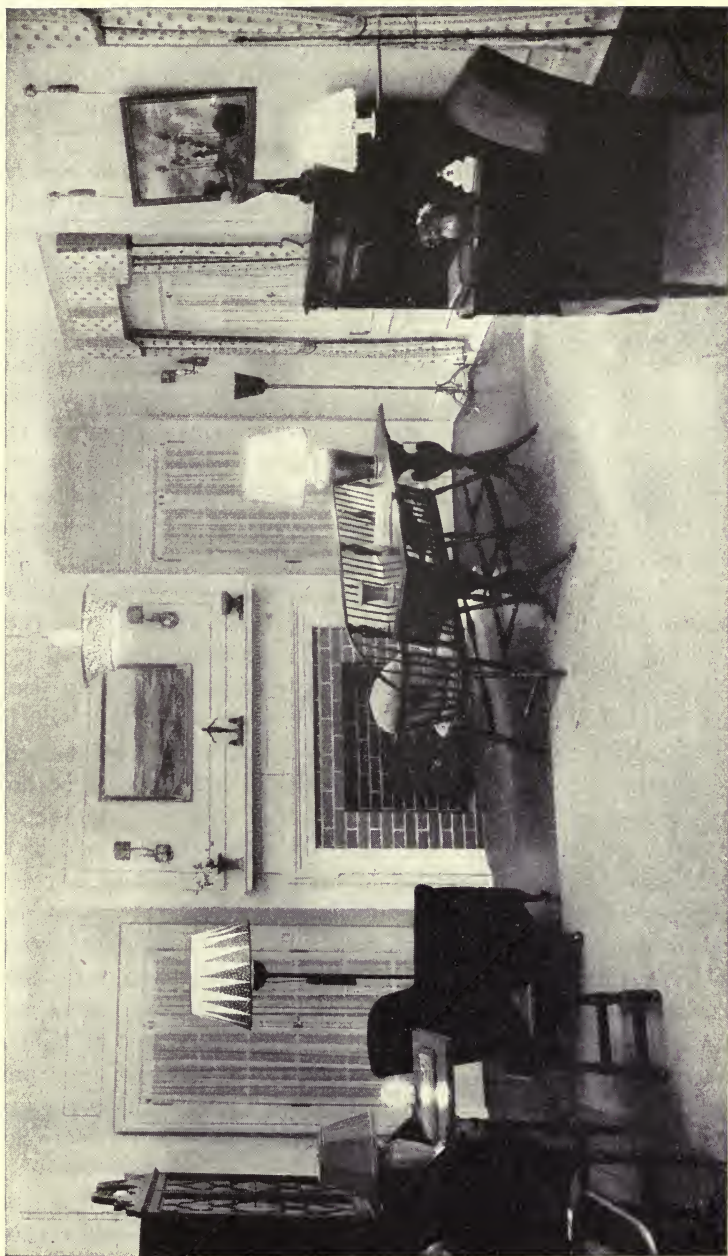

FIG. 50.—Modern lighting installation in living room

The electric light bulb determines the amount of light available, but it is the fixture that controls the direction and distribution of light. Care in the selection of fixtures which perform the kind of lighting service best suited for the particular room, assure satisfactory and comfortable illumination.

For decorative or other sentimental reasons, old candle fixtures and brackets are sometimes employed, but though these can easily be wired and fitted for electric service it does not follow that they should be so treated. It is perhaps in better taste to continue using them with wax candles.

The popularity of early American and other periods in furniture and home furnishings is attended by the use of most attractive designs in wrought iron, brass and copper which find suitable application in wall fixtures. Such designs provide for modern wiring but in their faithful adherence to the periods they represent, they combine utility with the charming effect of antique prototypes. In some of these fixtures the designs ingeniously carry out the suggestion of candle sticks and hand lamps, as shown in Fig. 51, and when located in such places as stairway landings and other convenient nooks where candle sticks and oil lamps of olden days would naturally have been placed, the appearance of original antiques is cleverly simulated.

The opportunities which electric light offers in securing decorative and efficient illumination are so numerous that you will be well repaid for any effort involved in selecting appropriate fixtures.

PORCHES. On enclosed porches overhead lights should be provided, at least one for each 100 square feet of floor area. In lighting any porch attention should be paid to the steps, which should be so lighted that they may be seen while leaving or approaching.

Enclosed porches connecting directly with the living-room, or sun-parlor, may be lighted by side brackets and floor lamps. The method employed will depend upon how the porch is finished and its location.

In southern latitudes generally, as well as in summer seasons elsewhere, for use on open porches where a small amount of light is required, an "Insekiller," shown on page 304, will not only provide light, but will kill flying insects as well. Such lights are best hung from the ceiling, connected to a convenience outlet controlled by a switch.

ENTRANCES. Entrances need particular attention, for it is most important that your home and the welcome it extends should register

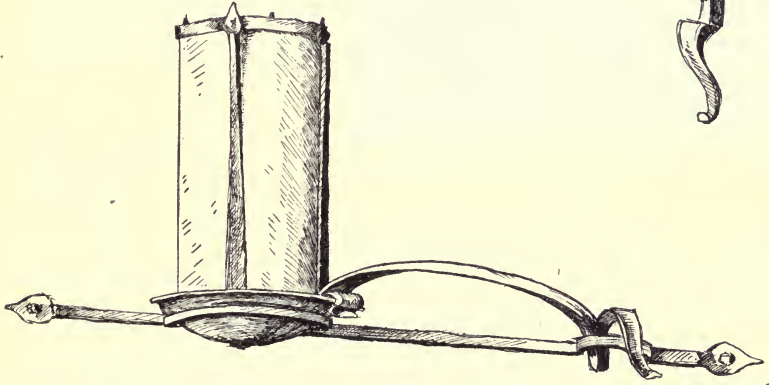
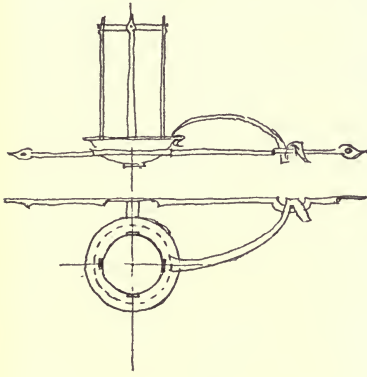
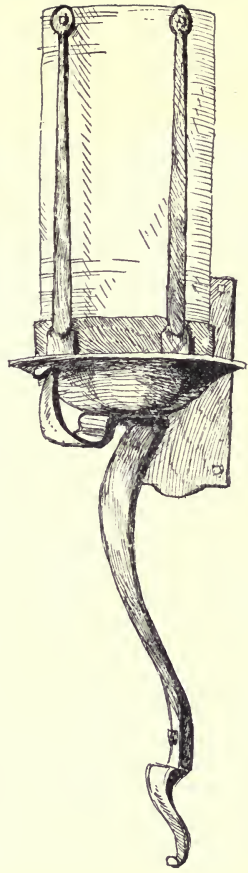
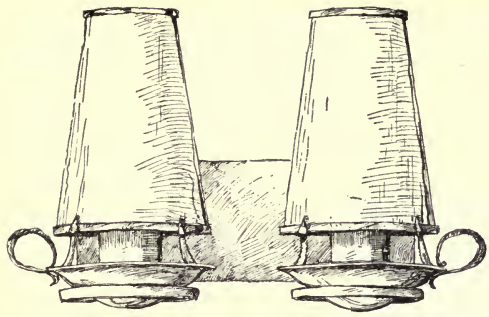

L.D.W..

FIG. 51—Hand-wrought reproductions of antique lighting fixtures
[99]

a good impression the instant friends approach the house. Attractive lanterns, to fit the architectural design of the house, should be hung on each side of the doorway, or immediately over the entrance. If the construction is such that only one side-wall lantern is practicable, it is better to have it placed on the door-opening side of the entrance.



FIG. 52.—Side brackets used for entrance lighting

Whatever method of lighting is selected, the light should be directed to the doorway and steps and not tend to blind anyone approaching the house. Figs. 52 and 53. Rear and side entrances require proper lighting, not only for convenience but for the assurance of safety.

ILLUMINATED HOUSE NUMBER. Lanterns can be secured which provide for an illuminated house number so that your friends will be able to locate you more easily, and so that evening deliveries of telegrams, or other items, will be more certain. There are many varieties of separate illuminated house numbers, one of which is shown in Fig. 54. Some are operated on the regular lighting circuit by small bulbs of the

usual type, while others make use of the small Neon bulb which consumes almost no electricity at all. Another type is connected with the bell-ringing circuit and includes the push-button for the bell.

As an aid in locating the correct key and in finding the keyhole, a momentary contact switch connected to the entrance lights is most convenient. This device is much like the ordinary switch but remains on only as long as one's finger rests on the switch. As soon as the

pressure is removed, the switch automatically turns off the lights. The wiring is so arranged that the current "by-passes" the regular switch controlling the entrance lights. It is obvious that this momentary contact switch need not be used provided the entrance lights are already on.

VESTIBULES. The vestibule is the passageway to the home and should be lighted by an appropriate ceiling light, giving more illumination than the outside entrance light, but not too bright on account of the eye adjustment necessary for the person entering from the



FIG. 53.—Entrance lighting using overhead fixtures

dark. By gradually increasing the amount of light upon entering the home, the eyes will have sufficient time to become properly adjusted.

HALLS. The hall is where your guests obtain the first view of the interior of your home. Here, then, is where a bright, cheerful, welcoming light should be used in contrast to dim, mysterious and disconcerting effects sometimes employed. Yet, because your guests come from the darker outdoors, care should be exercised not to blind them with glaring light sources.

If a lantern type of fixture is desired, have the inner light diffused through tinted cylinders or panels. Shielded brackets are

also suggested. An artistic torchere is appropriate at the staircase, or beside a table in the hall. It adds a touch of acceptable and pleasing formality and accents the hospitality of the entrance hall.



It should not be placed so as to reflect light directly into the eyes of anyone descending the stairs. (Fig. 55.) Portable lights, or lighted ornaments, are suggested for general lighting.

LIVING ROOM. The general principles of illumination already stated apply with equal force to the living room, and in order to emphasize these points I will summarize them briefly:

FIG. 54.—Illuminated house number

Varying lighting methods and effects are required for differing moods, as well as occupations.

One ceiling light to supply general illumination of high intensity and two such lights for a long room are desirable. Here indirect light will be found very effective.

Side-brackets used as "light pictures" may be balanced all alike, or each may be of individual design for decorative effect in an informal room.

Ornamental lighting, such as a bulb in a china vase, may be used for lighting a picture.

Floor lamps beside the chairs and sofa, with adjustable stems, are desirable. Such lamps should have the bottom of their shades about 44 inches from the floor.

One or more large-size, indirect floor lamps are very convenient for close work, study, or bridge.

Different individuals require different amounts of light, and sufficient light should be available to avoid eye-strain. Eye specialists recognize that although they may supply lenses to correct eye troubles, unless people take reasonable care of their eyes further correction will soon be required. Some of the more advanced doctors have a means by which they analyze the amount of light intensity required by each patient and prescribe this

intensity for all close work in the home, as well as in the office or school.

Special portable equipment is available which will provide any amount of illumination up to 50 foot-candles, which is a pretty good average of indoor daylight. Without becoming technical, it might be well to explain the meaning of "foot-candle." It is the unit of measure of the amount of light on a working plane or surface. Generally speaking, it is the light received by an object placed one foot away horizontally from an ordinary wax candle.

FIREPLACE OR MANTEL. Mantels are of such a wide variety of construction that no hard and fast rule can be laid down for their lighting. Brackets at each side of the mantel are very attractive, but some prefer to have electrically lighted ornaments served from convenience outlets on the mantel shelf. It is not good taste to put bright lights in competition with a real old-fashioned log fire. However, a decorative light on the mantel itself is very effective for lighting a picture. Fig. 56.

SUN ROOM. The sun room is put to so many varied personal and seasonal uses that any general lighting scheme is difficult to suggest. In many homes, however, the sun room offers an excellent opportunity for some form of decorative lighting, such as artificial flowers electrically lighted, placed over the windows. Such treatment adds



FIG. 55.—Suggested method of lighting hall and stairway

to the appearance of the room and gives ample light for general illumination.

Another form of decorative lighting for the sun room and glassed-in or semi-enclosed porches, terraces, etc., is obtained by concealing bulbs above a latticed frame-work placed on the ceiling and strung with real or artificial vines in semblance of an arbor, so that shadow leaves are cast on floor and walls as if sunlight were streaming down through foliage.



FIG. 56.—Suggested method of lighting a picture

Still another form of decorative lighting for sun rooms where the space occupied by glass windows leaves little room for the effective placing of wall fixtures, is obtained by concealing bulbs in specially constructed boxes built into the pilasters or wall spaces between windows and placed near the ceiling so that the light will be directed downwards through glass panels. The resulting effect is somewhat like that of cove-lighting.

The sun room also permits of a unique form of "light picture" in the attractive designs of lighted aquaria for tropical fishes now so much in vogue. Fig. 57 shows two reproductions of old sea-chests made from

both native and South American woods, a novel adaptation of typical marine designs, suggestive of "Yankee Clipper" days, converted to modern usage in this logical application. For the aquarium there is also provided a heating fixture, automatically controlled, for use in maintaining the proper water temperature for tropical fishes.

A sun-lamp, either portable or mounted on wall or ceiling, adds to the value of this room from a health standpoint.



(Shannon)



FIG. 57.—Attractive "light picture" is obtained with an illuminated aquarium

DINING ROOM. Fixtures for the dining room need not provide for as bright a light as is often required in the living room. The same means for properly diffusing the light, however, should be employed here as in the living room and, in addition to the general illumination and decorative lighting, there is, of course, the special treatment of the dining table itself to be considered. There is an art in correct lighting which nowhere in the home, perhaps, is better exemplified than in the charming effects it imparts to table illumination, varying to suit the occasion from the friendly intimacy of soft, warm lights appropriate for family or informal dinners, to the decorum of a brilliant setting prescribed for conventional functions. The hostess who is particular about the attractiveness of her table and attentive to the comfort of her guests will avoid the use of harsh, strong light and its consequent glare by so concealing or diffusing the light that it will cause no annoyance, either directly from its source, or indirectly by reflection from the white table cover.

Silver and glass will sparkle under candle-light and, if bright and polished, the same effect will be secured with electric light of average intensity. In other words, if the table is attractively arranged, the food good and the guests well entertained and in good humor, no lighting stimulation is required to assure the success of the party. It is perhaps preferable to divert a little attention from the food and allow the guests and their personalities to provide their share of the attractions and festive brilliance.

Years ago the dome light was commonly used with a screen below to diffuse the soft, yellow light of the old carbon lamp. When candelabra, center-pieces, flowers and other table ornaments came into vogue, the center fixture clashed with these decorations and thus met with disfavor. Often it was desired to use the table for playing games, principally that of ping-pong. This was impossible with the dome hanging over the center of the table. Another objection to the low dome was the necessity of craning one's neck to see a friend's husband at the opposite end of the table! Without the dome the table was free for the use of wax candles or ornaments of any kind. But today, with most of the former artistic effects out-moded, and with the modern bulbs giving white light, the dome light has come into its own again—a modernized and indispensable fixture. Fig. 58.

Proper light can be secured with the right kind of center fixture, but shading the light from this fixture is of utmost importance. In

order to light the table more brightly than the balance of the room, the distance between the bottom of the fixture and the top of the table should be from 24 to 26 inches to give the best results, thus bringing the bulbs near to those seated around the table and yet above the line of vision. If the bulbs are not properly shaded, or the



FIG. 58.—Modern dome light for lighting the dining room

light properly diffused, the lighting will be uncomfortable and fail to give the desired effect.

As a center-piece, an ornamental china bowl for natural or artificial flowers, with the electric light concealed, is very attractive.

Bracket fixtures in the dining room are used chiefly for their decorative effect and not for general illumination. When used in conjunction with the center light, Fig. 59, they should be attractively placed and properly shaded. Those of the indirect type are well adapted to many dining rooms, especially if the walls and ceiling are light in color.

Some dining rooms are well adapted to cove-lighting, which has already been suggested.

There are many beautiful vases which can be fitted for electric illumination, and one might have an old pewter plate so placed as to reflect the light from a bulb concealed by a small, beautiful, transparent china saucer in front of it. Lights can be hidden in the tops of cupboards so that the dishes behind the glass doors may be shown to advantage. If one light is used in a cupboard for this purpose,



FIG. 59.—Use of center light and bracket fixtures for dining room lighting

glass shelves should be employed so that the light will be effective on the lower shelves also. Tubular bulbs can be installed along the front sides of the cabinet in long reflectors, such as are used in lighting show-cases. The use of these longer bulbs, with two or three on each side of the cabinet door, will provide an even lighting on all the shelves. In either case a switch should be provided to control the lights in the cabinet.

BREAKFAST NOOK. Breakfast nooks can usually be lighted by a single shaded ceiling fixture rather than by a light suspended from the ceiling with the annoyance of a dangling cord suspended over the center of the table.

KITCHEN. The kitchen is still the workshop of the home, though today a delightful one because of the All-Electric Kitchen and the

charm and convenience which it provides. And because work, particularly in the kitchen, should be made as simple and easy as possible, full advantage should be taken of the assistance of light. The old-fashioned drop cord in the center of the kitchen ceiling, or the more antiquated combination gas-jet and electric light, has all but passed out of existence, although just a few years ago this was considered quite satisfactory lighting. Many kitchens are now lighted by what is called the "kitchen unit" controlled by a wall switch. This is a globe of diffusing opal glass enclosing the bulb and hung close to the ceiling. Fig. 60. Bulbs of 100 to 200 watts are used in these units, depending on the size of the kitchen and the color of the walls.



FIG. 60.—Kitchen unit with diffusing globe

The usefulness of better lighting in the kitchen has brought in another improvement and, in all but the very small kitchenettes, modern practice now includes a light over the sink and one over the range. By such an arrangement, there is no standing in one's own shadow and there is plenty of light to see just when the frosting threads, or the cake is brown, and to eliminate the annoyance of washing dishes in the shade, so to speak. These

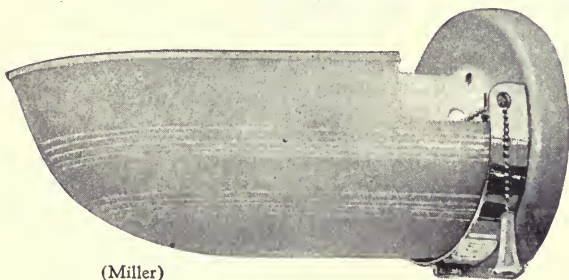

(Miller)

FIG. 61.—Bracket light for kitchen use, with diffusing globe

lights over sink and range should, where possible, be of the bracket type.

Such lights must, of course, be shaded and the type of shade usually recommended is shown in Fig. 61. Additional lighting on other working areas such as kitchen cabinets, over the kitchen table, etc., are very useful and should not be overlooked. In some kitchens

the lighting may be built into the ceiling, Fig. 62, and over the range or other work areas.

When the kitchen is not provided with special fixtures over the sink and range an indirect ceiling fixture will distribute light in a shadowless manner, reaching well into the recesses of shelves and cupboards and illuminating all dark corners.



FIG. 62.—Architectural lighting applied to the kitchen. (Installed in ceiling over range)

home, deserves special lighting. Good light goes far towards winning the washday battle, which today is only a very small skirmish, as we shall see in Chapter Five. In addition to the center light, which should be controlled by a switch at the door, there should be a light over the laundry tubs and one over the location for the ironer. All of these lights should be equipped with reflectors to make the lighting more effective, as was shown in Fig. 48. In all of these fixtures the blue "daylight" bulb is recommended. This is a great help in making sure that the yellow tinge has been removed from the linen and that all the spots have been washed out. These bulbs are a little more expensive than the ordinary frosted ones, but certainly are worth the slight difference. In the laundry, as in the kitchen, the size of the room

The walls, and especially the ceiling, should be light-colored to give best results, since dark colors absorb light.

A most useful light, also, is the one installed inside the refrigerator which turns on as the door opens. Fig. 63.

PANTRY. The pantry with its many shelves and cupboards may be well lighted by a small, indirect ceiling fixture. This method of lighting eliminates shadows and gives a uniform light on the shelves.

LAUNDRY. The laundry, another workshop of the

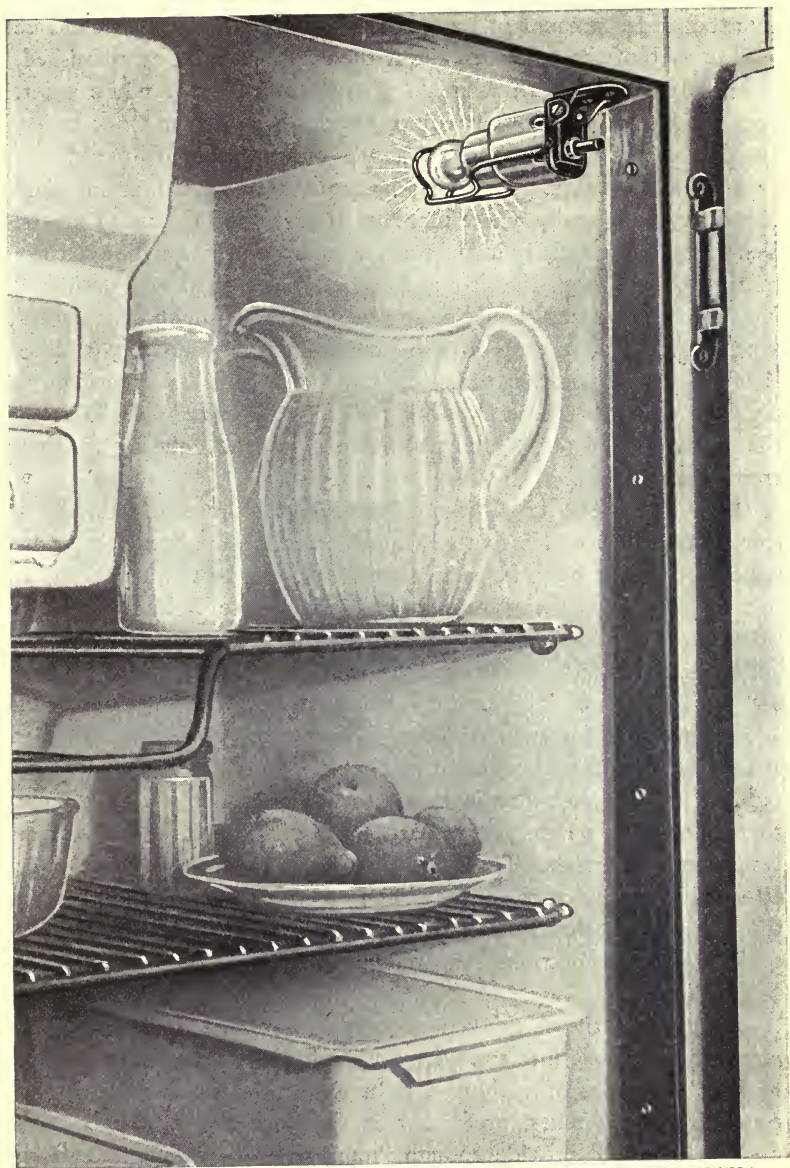

(H.&H.)

FIG. 63.—Refrigerator light controlled by door switch is a great convenience

and the color of the walls determine the size of bulb required to give the proper amount of light. Bulbs of 60 to 100 watts should be used in each of the reflectors, and if the walls are dark, or unfinished, it would be well worth while to give them a coat of white paint. Proper lighting and a bright laundry not only make the work easier, but they create a much more attractive place in which to work.

UPPER HALLWAY. Light may be required in the hall at any time of the night, especially where there are children and in case of illness. General lighting, usually in the form of an appropriate ceiling fixture, controlled from both the first and second floors, is always desirable. The stairway lighting should be so planned that no light shines in the eyes, making a clear view of each step possible. If there is a landing, it offers a good location for some form of ornamental lighting. A night light of low intensity burning all night, is suggested. This has the advantage of not tending to "blind" anyone entering the hall from a dark room.

BEDROOM. The usual idea of desirable bedroom lighting is a soft, tinted light to match the general color scheme, but it must be remembered that here, in particular, the hostess before appearing to her guests, or receiving her friends, adds those finishing touches which are so important to her appearance. The advantage of the full-length mirror is limited indeed if there is not enough light to see just how that new dress or that attractive coat fits. A most acceptable light for such purposes is indirect, and fixtures of most attractive design and material are available which provide semi-indirect and indirect illumination. In addition to this center light, there should be a light on the table next to the bed, and a pair of lamps on the dresser. There are also small brackets which can be attached to the sides of dresser mirrors so that, when the location of the furniture is changed, all that is needed is a handy convenience outlet for the connection. An example of bedroom lighting is shown in Fig. 64.

A light underneath the bed serves a very good purpose also. This may either be built into the wall, with a fitting similar to those used to light the aisles of a theatre, or mounted on the baseboard, and controlled by switches, preferably at the door and at the bedside. Such a light will provide enough illumination to prevent stumbling over stray shoes or toys in the children's room and yet it will not be bright enough to disturb the kiddies while they are asleep. It will

be of great advantage, also, in case of illness, as well as on hot summer evenings when pulling down the shades might shut out a breath of fresh air.

Outlets should also be provided for the use of floor lamps next to the chaise-longue, or the comfortable reading chair, and for the connection of a health lamp. Beside the bed, or between beds, an



FIG. 64.—A well-lighted bedroom

outlet should be provided for a reading lamp, table clock and heating pad.

EMERGENCY LIGHTING. Many homes are installing what is called a "master switch" in the bedroom which controls one or more lights in each of the main rooms of the house, or a large light in each hallway according to the design of the house, so that in case of emergency, or if one hears a strange noise during the night, the entire house—inside and out—can be lighted at the touch of a single switch. This installation requires consideration when the house is being built, since special wiring must be run from each fixture connected to the circuit. The wiring is so arranged that when the master switch in the bedroom is turned on, one light selected in each of the

rooms or halls is lighted in such a manner that it is impossible to turn that light off again at any other point than at the master switch.

Prowlers and other unwanted visitors are going to cut their visits short if they suddenly find themselves in a brightly lighted room, or if the yard is suddenly lighted. This protective lighting is particularly useful in outlying sections and is most certainly a decided comfort.

CLOSETS. Every closet should have a light. There is nothing more annoying than groping around in a dark closet for a lost shoe or fumbling on a dark shelf for something one knows must be there but which cannot be seen because of lack of light. Closet lights are never used for any great length of time, so that the cost of using them is practically nothing. The best location for the usual closet light is immediately over the doorway, with the pull-chain suspended on the door-opening side, so that it is always easy to find and yet is not dangling down in the center of the doorway. With this location, also, the light is coming from behind and not glaring into the eyes. In linen closets and other locations where shelving or shallow depth makes a lighting outlet inside the door ineffective, light should be provided from some other source. In many cases, particularly in narrow closets off hallways, an additional ceiling light should be provided in the hallway in front of the closet door. In larger closets the light can be placed in the center of the space and controlled by a switch at the door.

Not only are lights in closets a decided convenience, but they obviate the danger of fire resulting from the use of a match to find a stray shoe in a dark corner. This danger of fire has been felt to be so important in certain cities that local electrical regulations require the installation of an electric light in every closet.

Door switches, which automatically turn the light on as the door opens and off again as the door closes, are very helpful in closets, particularly in the main hall closet where guests are likely to hang their wraps. Such an arrangement assures light every time it is needed and also prevents the possibility of leaving the light on when it is not needed. Some of these door switches are provided with an arrangement by means of which the switch can be turned off while the door is open, if this is desired. This allows the door to be left open so that the closet may be aired without leaving the light burning. If the regular lighting system cannot be used on account of the expense, a small automatic "Wallite," Fig. 65, may

solve the problem since it will turn off automatically without thought or act on anyone's part.

BATHROOM. Probably nowhere in the house is poor lighting the cause of so much annoyance as in the bathroom. Much of the fine art of make-up is accomplished before the bathroom mirror and in this I refer as much to the husband's razor as to the wife's lip-stick. A light on each side of the mirror is the solution to many lighting difficulties encountered at this point. It will eliminate the shadow under the male chin as well as show up the too-thin or too-thick application of the feminine rouge. Brackets at the side of the mirror, arranged as indirect fixtures reflecting light against the wall instead of into the eyes, will give surprising satisfaction—no shadows being possible. In order to adapt the height of these side-lights to varying requirements of the household, they are available in adjustable models so that each will slide up and down. If winged mirrors are to be installed, attention should be given this feature in advance so that wiring and fixtures can be chosen accordingly. It is preferable to have bathroom brackets controlled by a switch at the door.

If proper brackets at the mirror are not available, good results may be obtained with an indirect or semi-indirect ceiling fixture, diffusing general illumination. A ceiling light of some sort in the bathroom is advisable, especially in the larger ones. A well-lighted bathroom, having both a ceiling fixture and side-brackets, is shown in Fig. 66.

A light inside of a shower compartment may also be necessary if the compartment is recessed into the wall of the room. This outlet should have special moisture-proof equipment and should be controlled by a switch outside of the shower compartment.

Here in the bathroom, where the healthful rays of the sun-lamps can be absorbed by the entire body while bathing, would seem to be the most logical place for making use of this combined advantage of light and health which these new lamps afford. There are several types of sun-ray fixtures which may be used in the children's play-

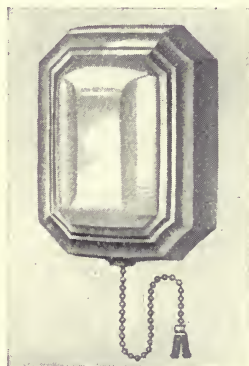

FIG. 65.—Automatic "Wallite" using dry cells. A useful light for closets and other occasional lighting

room, the sun porch, the bedroom and even the living room. Here in the bathroom, also, is an excellent place to make use of the new architectural or built-in type of fixture.

In many bathrooms where the tub is set back in a recess, in which the ceiling is lower than in the rest of the room, a light in the ceiling of this tub recess should be installed. This would be a particularly good location for a sun-ray lamp, which should be controlled by a separate switch, preferably located at the bathroom doorway.



FIG. 66.—Bathroom lighting with both ceiling and side fixtures

RECREATION ROOM. Because of the need for extra lighting, particularly where games such as ping-pong and billiards are to be played, the lighting of the recreation room should have special attention. For ping-pong, it is obvious we need ample light of even distribution, so that the ball remains evenly lighted during its entire play. Fittings should be high enough to avoid interference, and if hit should not be easily damaged. For this purpose, indirect metal bowls located fairly close to the ceiling are suggested.

The game of billiards or pool requires such exacting skill in execution that the lighting must be good, and there is no excuse for bad light since proper equipment is available for all sizes of tables. The theory is based on distribution without glare. Some elaborate fixtures have been developed with four and with six lights over the table, but this is unnecessary except on the standard table, which measures 6 ft. by 12 ft. On the average home-size table, 4½ ft. by 9 ft., two lights over the middle of the table, 4½ feet apart, insure excellent results. Fig. 67.

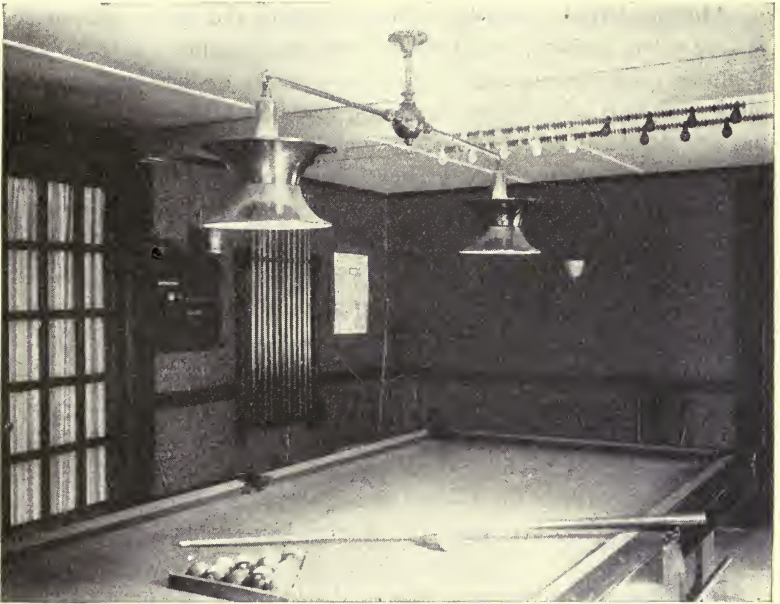

(Miller)

FIG. 67.—Recreation room lighting using a combination direct and indirect fixture

Then, to avoid the necessity of eye accommodation to the change of light intensity in the room and on the table, the room should be well lighted. The fixture in this same illustration lights the entire room as well as the table.

If general lighting in this room is omitted and the table brightly lighted, this condition will lead to many "first shots" being missed due to sudden change of intensity and slowness of the eye to become properly adjusted. Often more than one ceiling light is needed. In case of a rather low ceiling, or where the length of the room is more than one and a half times the width, two ceiling lights should be provided.

Convenience outlets in the recreation room are worth while and allow the use of the children's electrical toys, suction cleaner, floor polisher, waffle iron or toaster for serving friends, and possibly a small secondary refrigerator for keeping a few "snacks" for your guests. A number of portable lamps will add a great deal to the cheeriness of the room.

MISCELLANEOUS ROOMS. Other rooms of the home, such as the sewing room, nursery, or playroom, sometimes require special lighting facilities. The sewing room should have plenty of light and daylight bulbs will help when colors are to be matched. The lighting of the nursery should avoid any glare, since children's eyes are very sensitive and need protection. Indirect lighting is ideal.

BASEMENT. Lighting the basement is not a difficult problem, but there are a few hints which may be of help. First of all, the light at the bottom of the cellar stairway should be controlled by a switch upstairs. An indicator light is a very helpful addition to this circuit for it glows when the light is on and serves as a reminder so that the last one to leave will be sure to turn it off. This indicator light may be adjoining the switch at the head of the stairs, or at any other point in the house where it may be readily seen. Perhaps it should be in the kitchen, or placed in the back of one of the steps leading up to the second floor, so that it is sure to be noticed as the last member of the household retires for the night.

In basements having an outside doorway, or where there is a recreation room or other finished room installed, there should be a second switch on the main basement light so that it will be unnecessary to grope around in the dark if you enter the basement from the outside. This second switch, also, would make it possible for you to turn out the main basement light if you expected to spend any considerable time in the basement or laundry and did not need the light at the foot of the stairs.

Vegetable rooms and storage spaces in the basement each should have a light controlled by a switch at the door. In such spaces as these the switch is particularly useful, for it avoids groping in the dark for a dangling pull-chain and is particularly appreciated when one's arms are loaded with preserves. Perhaps an automatic door-switch would be of even greater assistance.

There should also be a light in front of the furnace and one over the workbench. It might be well, also, to provide a light in the vicinity of the gas and electric meters for the convenience and accuracy of the meter reader, and also for your own convenience in case you desire to check up on the readings.

THE ATTIC. All finished rooms in the attic should, of course, have the same good lighting as that provided in the balance of the

house. Each other enclosed space should have a ceiling light with switch control, if practicable, and there should, of course, be a light at the head of the stairs controlled by a switch at the bottom of the stairway. This switch should also have its indicator light, showing whether or not the light upstairs has been left burning.

ALL-NIGHT LIGHTS. There are places and occasions where a small light is needed all night, and by the use of proper lamps this light may be obtained at an operating cost of only a few cents a month and less than a dollar a year. A small Neon glow lamp, one-half to two watts, may be used where just a soft glow is wanted to light a doorway, or stairway, or to show the location of some object. Where more light is wanted, use a seven-and-one-half or ten-watt bulb of the regular type. For temporary use in a sick room, or in the nursery, a portable lamp such as was shown in Fig. 46, is suggested. In its downward position a small, permanent, well-shaded light will shine on the floor. When the shade is turned upwards, a larger light will automatically turn on and give sufficient light for seeing about the room, but no light will shine in the child's or the patient's eyes.

By the use of a special adjustable socket, shown in Fig. 68, a bulb up to 60 watts in size may be turned up or down as desired and used as a night light. This will be found convenient where a wall bracket is already installed and the use of an independent night light is not possible. Such a socket can also be used with a ceiling light by using an extension cord for operating the dimming device.

An illuminated pendant on a socket chain or switch handle will be useful at night to assist in finding the socket or switch.

THE GARAGE. One can never tell when it is going to be necessary to do a little work around the garage. Even if it is only to put a set of chains on the car, good light is not only a great convenience, but a time-saver. Inasmuch as these occasions are probably rare, the cost of operating good lighting is negligible and the expense of installing the original equipment, when spread over a number of years of convenience, is certainly justified.

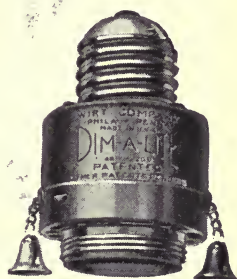

FIG. 68.—“Dim-A-Lite” used for changing intensity of light from an ordinary bulb

The best lighting for the interior of the garage is secured by having one ceiling light over the hood of the car and one over the rear. In double or multiple garages, one light over each hood, plus one light between each car at the rear, is sufficient. In single garages both lights may be controlled by a single switch, but in multiple garages more than one switch may be preferable. There should also be a light mounted outside the garage and the house. This light should be controlled from either the garage or the house, so that the light can be turned on before leaving the house and off after reaching the house, as well as at the garage itself.

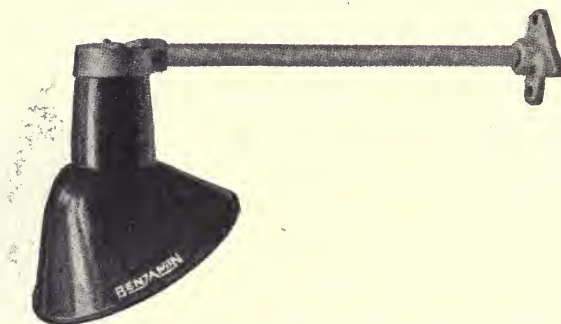

FIG. 69.—Angle reflector suitable for lighting garage entrance

At least one convenience outlet should be provided for each car so that portable trouble lamps, heaters, electrically operated tools, etc., can be connected. Small portable flood lamps are often useful about the garage and can also be connected to the convenience outlet. A workbench in the garage is a convenience and needs proper light, either a wall bracket or a suitable ceiling light with a reflector.

Detached garage entrances may be properly lighted by the use of an angle reflector extended out over the doorway, as shown in Fig. 69. This type of reflector directs the light into the garage and not into the driver's eyes. In the case of a built-in garage, entrance lights should be selected to fit into the architectural plan of the house.

OUT-OF-DOOR LIGHTING. The possibilities of outside lighting are so great and so varied that the best I can do is to make general suggestions, since what you accomplish depends upon the type of house or grounds, or both, to be lighted. Proper lighting equipment is not expensive and with a little planning much may be accomplished.

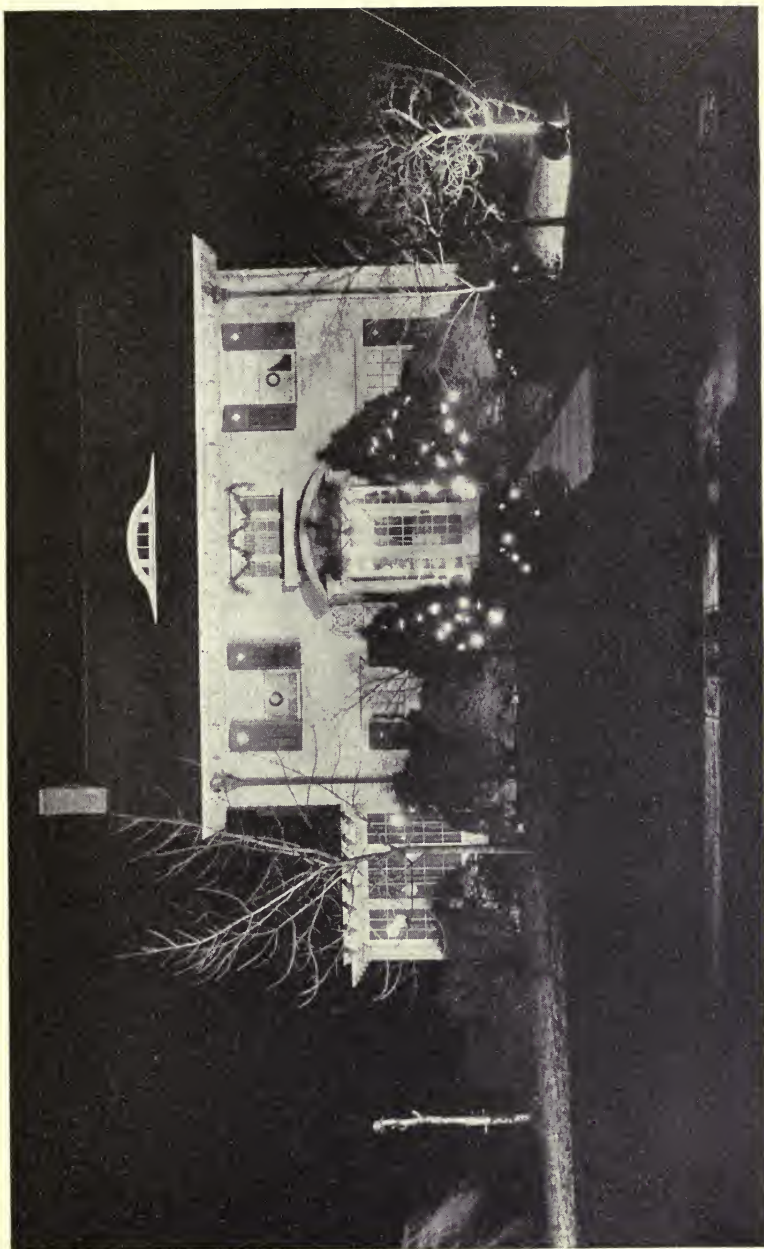

FIG. 70.—An example of outside lighting using portable flood lights

The house exterior may be lighted by lights attached to the house, or by flood lights located on the ground. Fig. 70. A permanent installation can be made by placing 100-watt to 200-watt bulbs in reflectors mounted under the eaves at the corners of the house.

The installation of lights and reflectors outside the house, as well as the use of portable flood lights, is becoming more and more popular, not only as a safeguard against annoying prowlers, but also to provide light in the yard so that cars can be washed, or lawns mowed, and gardens weeded after dark.

Sunlight may be essential to the growth of a beautiful garden, but in this modern age it is not necessary to limit the enjoyment of its colorful charm to daylight hours. Garden lighting is becoming more and more popular, not only on the large estates but also in the smaller gardens and backyards, so that the busy housewife and the business man may enjoy these beauty spots during the evening. Fig. 71 shows the beautiful effect of night-lighting in a rock garden.

A favorite rosebush as it bursts into bloom may be lighted by a small flood light; a shapely fir may be silhouetted against the garden wall or the house; smaller trees and shrubs may be lighted by placing one or two reflectors below them; and if there is an arbor of flowering vines in the yard, flood lighting will produce a beautiful effect. Fig. 72. A pool with its budding lilies, or bubbling fountain, Fig. 73, is a particularly beautiful sight when lighted at night by reflectors hidden nearby, or by electric lights actually built into the fountain. As a further aid in achieving these colorful effects, there is available a special lawn sprinkler provided with lights for reflecting color-rays into the whirling spray.

In locations where it is difficult to provide running water for the fountain a most practical and inexpensive expedient can be effected by the use of a small electric pump operating within a pool lined with sheet-lead so that no water will be wasted. Here again, under-water light bulbs and flood lights provide a variety of colorful and charming effects. This same arrangement of the lead-lined pool, with the illusion of running water created by the operation of an electric pump, may be extended to form a fair-sized stream on a hillside, or one that trickles down from pool to pool in a rock garden. It is simply a matter of constructing a sheet-lead trough, moulded into the rough semblance of the bed of a shallow stream by pressing the soft material down over rocks, and covering with small stones



FIG. 71.—Rock gardens and lawns may have their beauty extended into the night by proper flood lighting

and pebbles. The addition of water plants makes the effect complete. The circulation of water is obtained by connecting a copper pipe between the lowest and the topmost pool, and the electric pump does the rest.

In addition to their use for night lighting, flood lights have a most practical value, as a friend of mine has recently discovered.



FIG. 72.—Illuminating an arbored pathway by the use of colored flood lights adds charm and utility to the night scene

By directing the lights to the treetops in his garden, and even on the lower shrubbery and hedges, the lights not only serve to illuminate the garden and lawn but so effectively attract insects that screens on the porch have been eliminated and outdoor dining after dark has become a new and pleasurable recreation.

If there are any steps in the garden they should be lighted, and this can easily be done during construction, although a small flood light can be placed near the base of the steps which will serve admirably for this purpose. Fig. 74. Waterproof boxes may be



FIG. 73.—The spray of a fountain sparkles and glows with rainbow effects in the rays of colored flood lights



FIG. 74.—Lighting the garden steps is a simple matter with modern facilities

built into the concrete of the adjoining wall of the steps, and in these boxes bulbs placed to light alternate steps, or every third step, as may be found necessary.

In lighting a garden some experimenting may be necessary if one expects to bring out the natural coloring of the flowers and foliage. Whether a white or a colored light would be best for tinting a background, such as the garden wall, or the side of the house, depends upon several factors one of which is your taste for

color. Here again further experimenting may be worth while.

Portable flood lights are useful at night for working in the garden, playing games, or in the winter for coasting or skating. Fig. 75.

DRIVEWAYS. Many of the larger homes set back from the main road have driveways or walks of their own. Ornamental fixtures may be obtained for this purpose.

The wiring and outlets to supply garden and driveway lighting should be of



FIG. 75.—Portable flood lights for various uses about the grounds

the waterproof type! Its installation, which is comparatively simple, is explained in Chapter Four. It will probably be well in planning this wiring to have it all controlled by a switch within the house so that it will be unnecessary to go out into the garden to turn off the lights. It is possible to use a time switch so that the lights may be turned on or off at any hour one may choose.

SPECIAL LIGHTING EQUIPMENT. A "candle" that lights when it is picked up and goes out when set down, or that will stay lighted all the time, is certainly convenient. Everyone is so familiar with the common, everyday flashlight that I am not going to take up much

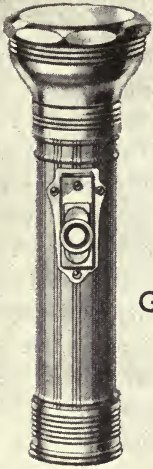

Official
Girl Scout
Model



Official
Boy Scout
Model



400 Foot
Spotlight

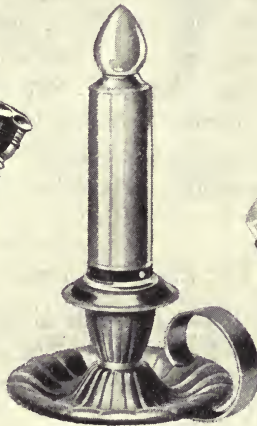

Automatic
Candle Light

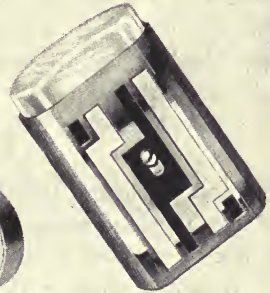

Pocket
Light

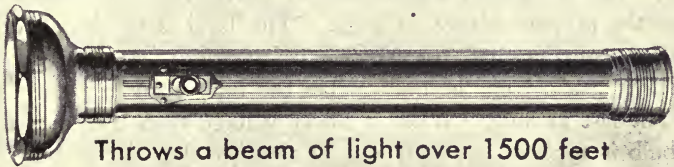

Throws a beam of light over 1500 feet

FIG. 76.—Typical “Eveready” flashlights

time in going over this subject, but there are a few of the later novelties that may be of interest. These lights are available in the familiar tubular form as candles, lanterns—both large and small—vanity cases, fountain pens, and arrangements for attaching to the telephone. The electricity used for lighting these small bulbs is furnished by a small battery called a “dry cell.” Such cells have a reasonably long life and are easily replaced. In Fig. 76 are shown several of the principle types. I find these little lights so handy that I always have several available. They are a great convenience around the automobile, and whenever we go camping they form a part of our main equipment. When tramping with the boys we each not only have our regular flashlight for walking through the woods at night, but in our knapsacks we carry a small box which contains some extra bulbs and fresh dry cells to use in case of emergency. In the past few years we have tramped many a mile at night through trails in the wilderness, depending entirely upon these flashlights for finding our way. Our camping trips would not be complete without their assistance. We have several types on hand, and if a ball or a thimble is lost, it is the flashlight that helps find it. They help a lot, also, in examining those sore throats that keep children in bed until after school has begun!

The Electric Lamp

Modern electric lamp bulbs are made in many sizes and varieties to meet the requirements of any home. The term “bulb” is used so as not to confuse it with portable lamps, desk lamps, etc., which are complete units in themselves.

On the end of all standard bulbs will be found two figures besides the name of the maker. Fig. 77. The figures before the letter “V” mean the voltage of the circuit on which the bulb should be used. Thus, “120 V” means 120 volts. In purchasing bulbs one should know the proper voltage to select. The local lamp dealer, or the lighting company, will furnish this information. A voltage higher than that marked on the bulb makes the bulb burn brighter, but it will not last as long. When a lower voltage than that marked on the bulb is applied, less light will be obtained, but the bulb will last longer. Standard bulbs have an average life of about 1000 hours when used at their rated voltage. The letter “W” after a figure or

figures, such as 25 or 40, means the size of the lamp, the "W" indicating the watts consumed by the bulb. The greater the number of watts consumed the more light the bulb will give (see page 27 for explanation of "watt").

Fig. 78 shows standard bulbs used in the home for general lighting, ranging in size from 15 to 100 watts. The proper size of lamp to use is hard to suggest, since so many factors must be considered. The best method is by trial. However, modern electric fixtures are designed for a particular size of bulb and best results are obtained when that size is used. Some suggested sizes and uses are given on pages 136-7. Larger lamps than are necessary should not be used, and frosted lamps are preferable since they offer better diffusion of light. Since the efficiency of light bulbs increases with their size, it is more economical to use one large bulb rather than several small ones totalling the same wattage.

For portable hand lamps, or other places where bulbs receive rough usage, a 50-watt "rough service" bulb is recommended. These bulbs are more rugged than the regular bulbs and their slight additional cost may prove a saving in the long run. They are not generally carried in stock by the average dealer, but may be obtained on special order without much delay.

For the laundry, kitchen, sewing room, or places where fine work is being done, a special "daylight" bulb is recommended. This bulb is blue and gives a light that approaches daylight, hence its name. It is made in the 60-watt, 100-watt and 150-watt sizes for home use. The light given by these bulbs is somewhat less (about 35 per cent) than that of the ordinary frosted bulb of the same wattage and it is therefore necessary to use a little larger bulb. In cases where a standard 60-watt bulb would be sufficient, one of the daylight variety, rated at 100 watts, would be necessary.

There is another bulb made in the larger sizes—150 watts, etc.,—known as "white-bowl bulb," the bowl being whitened on the inside



FIG. 77.—Typical marking of a lighting bulb, giving its size and voltage

and the upper part of the bulb being made of clear glass. This bulb should be burned with its base up to avoid overheating. It may be used to advantage where ceilings are high.



(Hygrade)
FIG. 78.—Standard light bulbs for household use

Bulbs used principally for decorative purposes are illustrated in Fig. 79. As a rule these bulbs are not used for reading or other fine work, but more for decorative lighting. Ordinary bulbs may also be obtained in many different colors, such as red, blue, green, amber, old

rose, yellow, ivory, etc., in the smaller sizes, for decorative lighting. Miniature Christmas-tree bulbs must all burn at one time and can only be controlled in groups since they are of a special series type.



(Hygrade)

FIG. 79.—Decorative light bulbs for household use

Most bulbs used in the home have what is known as a “medium base,” but other and smaller bases are used on special decorative bulbs. Fig. 80. It is through this base that electric contact is obtained between the socket and the filament in the lamp bulb. It is part of

the electric highway and the terminal of the individual branch leading to the bulb.

There are many places in the home that require a small amount

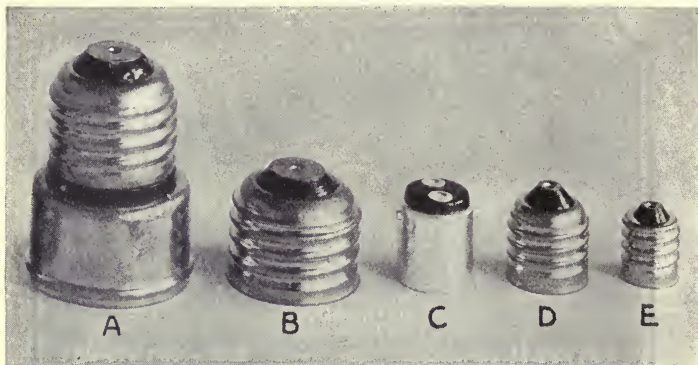

FIG. 80.—Standard light bulb bases. "A"—Medium base for large bulbs. "B"—Medium base for standard size bulbs. "C"—Bayonet base for small bulbs. "D"—Intermediate base for small bulbs. "E"—Candelabra base for small bulbs



FIG. 81.—Neon glow lamps

of light through the dark hours of the night, especially in halls and bathrooms. The small Neon glow lamp, shown in Fig. 81, is well adapted to this purpose. These small bulbs consume only a few watts and have a life of over 3000 hours. The light comes from a

gas that is made luminous by the passage of electricity between two electrodes, and not from a heated wire such as is used in standard bulbs. Not having a wire filament, these bulbs cannot burn out, but they eventually become blackened.

Photographs of children at play in the home are prized by parents and mean much to the children in later years. Here again electricity adds to our pleasure, since interior photographs are easy to make provided we have sufficient light. Special bulbs have been developed for photographic purposes, one of which, for taking ordinary still pictures, is called the "photo-flash lamp." Fig. 82. This bulb takes the place of the old-fashioned flashlight powders with their smoke and noise, but such a bulb can be used only once. This bulb is connected to a source of electricity, either the lighting circuit or a dry cell, and when the button is pushed there is a flash which is of sufficient brilliancy to make a correct exposure. In this case the camera shutter is open for "time exposure." This flash lasts about one-fiftieth of a second—ample time for a good snap-shot picture. If more light is



FIG. 82.—Photo-flash lamp

required, use more than one bulb. Care must be exercised in using such bulbs to see that they are not set off prematurely. This means that the actual contact must not be made, or the button pressed, until the flash from the bulb is desired.

The modern motion picture camera with its super-sensitive film can be used for taking interior photographs, and to assist in furnishing light for these interiors a special "photo-flood lamp" has been

developed. This type is also convenient for furnishing light when ordinary interior photographs are desired—(time exposures)—with a regular camera. The bulb of this lamp is of the ordinary 60-watt type in appearance, but is designed to give a very brilliant light for a comparatively short time. It consumes about 250 watts. Such bulbs have a life of from one to two hours, but even in one hour a lot of pictures may be taken. This bulb is stamped differently on its end, the words “photo-flood” being used.

The proper use of both the photo-flash and the photo-flood bulbs is contained in special instructions furnished with the bulbs. Proper reflecting lamp stands, or hand reflectors, are necessary for directing the light when interior photographs are being made. Space

does not permit giving detailed instructions as to how these lamps may be used, but it is suggested that anyone interested in photography consult a dealer for the necessary details. These bulbs with proper reflectors may be used when temporary flood lighting is wanted. Special natural red and green colored glass bulbs are available for developing films and plates

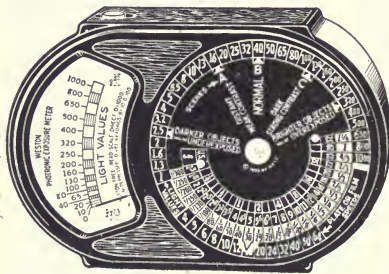

FIG. 83.—Exposure meter for photographic purposes

in the dark room and are the only safe ones to use.

The photo-electric cell, in its application to the exposure meter, has found a useful place in the photographer’s kit. The meter shown in Fig. 83 gives the correct exposure and size of “stop,” or lens opening, to use under any light condition.

In my own home I have found it much to our advantage to keep a bulb in every socket in the house, regardless of how little it is used. Light is then available at any instant. I also keep spare bulbs of various sizes on hand and make replacements from this source, never robbing a regular socket that may be needed.

There are several special bulbs made for use in motion picture projectors, stereopticons, etc., and such bulbs as a rule do not have a very long life. For this reason spare bulbs should be available to avoid the unpleasantness of being unable to finish the home movie show.

Where decorative lighting effects are desired under water, such as in swimming pools, fountains, artificial streams, etc., a special under-water bulb should be used. Otherwise it is necessary to provide a transparent waterproof covering which will properly protect the standard bulb.

Another special bulb of a radically different type is known as the "Mazda sun-lamp," types S_1 and S_2 , their use being described on page 240. They are used for giving ultra-violet health rays, as well as useful reading light. It is the use of mercury and special glass in these bulbs that makes them differ from the ordinary bulb. These bulbs can be used on alternating current circuits only and require a special reducing transformer which is made a part of the containing fixture. The bases of such bulbs are of a special size, so that they cannot be inserted in a regular lighting socket by mistake.

There are many imported bulbs sold in this country at a very low price, but these bulbs are very inefficient and consume more electricity for the light they give than our domestic product.

In order to meet this low price, a domestic bulb selling for about half price, is available, but it does not have the life of the regular standard bulb. In a 60-watt bulb, for instance, selling ordinarily for 20 cents, the life is about 1000 hours, as I have previously said, whereas in the cheaper bulb made by these same manufacturers, the average life is about 500 hours. While the original cost of these bulbs may be somewhat more attractive, this does not mean that they are cheaper in the long run, and this point should be kept in mind when purchasing.



"Pin-It-Up" portable wall lamps
[135]

In the following tables the style of bulb is given in the second column, and in Fig. 78 and Fig. 79 will be found some of the corresponding shapes. The figure after the style-letter is the maximum diameter of the bulb in eighths of an inch. For example, "A-19" means a style "A" bulb which is nineteen-eighths, or $2\frac{3}{8}$ inches, in diameter.

Suggested Sizes of Bulbs to Use in Home Lighting
For General Lighting

Size of bulb in watts	Style of bulb	Finish of bulb	Suggested application
7½	G-11	White	Night light
10	S-14	Clear	Night light
15	A-17	Inside frosted	Night lights
25	A-19	Inside frosted	Wall-brackets and shower fixtures
40	A-21	Inside frosted	Wall-brackets, shower fixtures and candle fixtures
50	A-21	Inside frosted	Utility wall-brackets, multiple-socket ceiling-fixtures, portable lamps
60	A-21	Inside frosted	Ceiling-fixtures, portable lamps
60	A-21	Daylight	Laundries, kitchens
75	A-23	Inside frosted	Ceiling-fixtures, portable lamps
100	A-23	Inside frosted	Ceiling-fixtures, portable lamps
100	A-23	Daylight	Laundries, kitchens and workshops
150	PS-25	Clear	Semi-indirect ceiling-fixtures
150	PS-25	Inside frosted	Indirect ceiling-fixtures and portable indirect lamps
150	PS-25	Daylight	Kitchen and laundry units
200	PS-25	Inside frosted	Indirect ceiling fixtures and indirect portable lamps

For Decorative and Ornamental Lighting

Size of bulb in watts	Style of bulb	Finish of bulb	Suggested application
10	S-11*	White	Decorative lamps
10	S-11*	Flametint	Decorative lamps—light ornaments
10	S-11*	Colored	Decorative lamps—light ornaments
15	G-16½*	White or flametint	Wall-brackets and decorative lamps
15	F-10*	White	Wall-brackets and decorative lamps
15	F-10*	Flametint	Wall-brackets and decorative lamps
15	A-17	Inside frosted	Decorative lamps and wall-brackets
25	A-19	Flametint, ivory or old rose	Decorative lighting effects
25	T-6½*	Clear	Modernistic wall-brackets and special fixtures
25	F-15	Flametint	Decorative wall-brackets and portable lamps
25	F-15	White	Decorative wall-brackets and portable lamps
25	G-18½	White	Decorative wall-brackets and portable lamps
25	G-18½	Flametint	Decorative wall-brackets and portable lamps
25	G-25	White	Fixtures and wall-brackets—decorative
25	G-25	Flametint	Fixtures and wall-brackets—decorative
40	A-21	Flametint, ivory or old rose	Decorative effects in wall-brackets and shower fixtures
40	G-25	White	Fixtures and wall-brackets—decorative
40	G-25	Flametint	Fixtures and wall-brackets—decorative

*These bulbs have special bases and cannot be used in the ordinary socket.

FOREWORD

To Chapter Four

WHEN you plan a motor trip over state highways to some distant point, what are the first things about the route maps that you take particular pains to check? If there are several routes to choose from, do you not give thought to the following?

What is the shortest route?

What route has the fewest "obstructions" of city traffic to pass through?

What route has the best roads—concrete, asphalt, macadam, gravel or dirt?

What route is recommended by the "A. A. A."—nothing under construction, no detours?

In short—What route is in the best condition "clear through"—with concrete pavement all the way?

Now let's take a look at the Electric Highway. Remember how in the beginning we studied the route map? It was not to be expected that you would get more from the first chapter than a general idea of the nature of this system. But by now you have gained sufficient knowledge of its purpose, construction and facilities for service to be something of a judge of how best to extend this highway to other and more distant points of interest.

No self-respecting motor highway, laid out to be a through-route, is content to stay at a "dead-end," nor does it intend to be restricted to state boundaries. When the public demand calls for extension the concrete pavement continues on in kind. Cheaper and less permanent construction is not advisable for the main highway, although it may be altogether proper for branch roads. There is a very sensible and helpful analogy in the motor highway system that makes the reasons for using certain construction and material in electric wiring extension easy to understand.

The journey that we are now to take, in this next chapter, has been planned for the special purpose of acquainting you with the most approved methods of extending the electrical system in your home. It will be apparent to you as you proceed over these new roadways, that the shorter and better "conditioned" route electricity has to travel over to serve the appliances installed in your home, the greater will be the convenience, comfort and economies you will derive from such appliances. But if you permit the use of makeshift extensions you not only run the risk of many "interruptions" of service, but you are speculating needlessly with the more serious factor of safety as well.

Avoid the use of long and unsightly portable extension cords, easily tripped over and likely to be pulled loose from convenience outlets. It is like taking the longest route with many detours.

Avoid making extension-circuits needlessly complicated, such as unnecessary switches, long connections, etc. It is like taking a route through city traffic.

Avoid any violations of the National Electrical Code rules. It will cause you inconvenience, like not heeding traffic regulations.

The subjects dealt with in Chapter Four are:

What general considerations to observe in extending the electric highway of your home.

When to use, and when not to use, portable cords.

The distinction between lamp cords and heater cords—a description of the various kinds in use.

Improved methods for permanently extending your wiring system.

How to check your electric wiring system to make certain it conforms to prescribed regulations and best modern practice.

How to make improvements in your wiring system for greater convenience: Replacement of old-style outlets with the duplex type, grouping lights on a single control switch plate, replacing old fixtures with modern designs—and other suggestions.

How to make provision for sufficient convenience outlets—for both permanently installed and portable appliances.

How to provide for outside wiring.

Proper provision for the telephone, the radio and bell extensions.

Why it pays to "modernize" your wiring system.



CHAPTER FOUR

Extending the Electric Highway of the Home

Almost daily, it seems, some new device for increasing our comfort, or improving our health, comes to us from the realm of science to make life more pleasant. It is no wonder, then, that electrical wiring, even in homes built as recently as five years ago, is not sufficiently complete to provide for all the new uses of that most helpful servant—Electricity.

The increasing use of electricity in all parts of the home often requires additional outlets, which may easily be provided. Extensions are usually inexpensive and the greater convenience and frequent economies gained by their use are worth several times their cost. For those living in rented homes it is well, however, to consult the owner or landlord and obtain approval before adding permanent extensions. Adequate wiring is an asset to any home and adds to its value, so that no broad-minded person will object to such improvements.

You will find it much more satisfactory to consider this job as a whole and plan a fairly complete program of modernizing your wiring system rather than to do a little now and a little later when the particular need of an added outlet arises. If you provide for funds in your monthly budget, setting aside a few dollars each month, it will not take long for you to save enough to do a really worth-while job of additional wiring. Furthermore, you will find it much less expensive than to call in an electrician every now and then and have him do just a little each time he visits you.

In an earlier chapter I went over with you in detail the electric highway in the home, showing you how it was installed in my own house and how easy it was to introduce improvements in the wiring system. An experienced electrician can extend your electric highway and put in extra lights or outlets without disturbing you in any way, and without injury to your walls, floors, ceiling or woodwork. There are electrical contractors specializing in this modernization, and in

their service they engage to leave your home in just as tidy a condition as they found it. They will cover up your rugs and your floors as they work and see that no traces of their efforts are left behind.

I cannot tell you off-hand just what particular type of wiring should be utilized in extending the electrical system. This will depend upon the regulations in effect in your own particular locality and upon the practices of your local electrician or wiring contractor. I suggest that you consult them for proper information inasmuch as they know your local conditions.

How to proceed to extend your electric highway to a point where you wish to place a reading lamp, radio, or an appliance, is not easy to suggest without a knowledge of conditions. It is best in extending any wiring system to avoid an installation not in accord with the regulations of the National Electrical Code. This code specifies the proper materials and methods of installing the electric highway in the home, and has been prepared for the protection of the home owner. Whoever does your wiring or other electrical work should have it impressed upon him that the work is to be carried out in accordance with these rules, and if anyone attempts to tell you that they are unnecessary and need not be followed it is a pretty good indication that this particular person is not the proper one for you to employ. Now, don't break any of these rules yourself and, particularly, do not countenance any temporary wiring or patching up that is not done the way it should be.

Portable Cords

Portable cords are relatively small highways and are like the driveway to a home leading off the main or a branch road. Such cords are intended for connecting a portable lamp or appliance to a convenience outlet and not to a fixed, or permanent, part of the regular wiring system.

In many homes, especially the older ones, lamp or portable cords have been used for extending electrical service. Such extensions, while admittedly convenient in many cases, do not make for good appearance and they are not as durable as mechanically protected permanent wiring. Nor are such extensions allowed by the National Electrical Code except in connection with an existing outlet where

there is a limited electrical load. Even where such cords are used for temporary service, they should be kept away from damp locations, or where they are subjected to much wear such as on the floor, under rugs and along the sills of doors. A typical example of these unsightly cords is shown in Fig. 84.

Cords should not be fastened by tacks or staples, but kept loose over well-rounded, smooth hooks. When a cord shows signs of wear, it should be renewed entirely and not cut and the bad portion removed, unless it is near either end, since cords should not be spliced. Being a small highway, only a light load such as a portable lamp, fan, cigarette lighter, radio, or appliance using less than five amperes, 550 watts, may be connected by means of the ordinary portable cord, known as No. 18. Larger cord (No. 14) is available for appliances using more than 550 watts. In cords supplied with appliances the proper size has been taken into consideration.

It might be well to illustrate the danger of using portable cords for extensions where some of the larger appliances might be used. In



FIG. 84.—Extension cords from ceiling fixture to table lamps are unnecessary when proper wall outlets are used

Fig. 85 is shown a convenience outlet properly connected to the distributing panel and protected by a 15-ampere fuse. By means of an attachment plug connected to this outlet, a portable cord is extended to another outlet. The permanent highway, or circuit, is large enough for carrying the 15 amperes allowed by the fuses. However, the extended convenience outlet, which is connected by means of the lamp cord, is on a very much smaller highway and should not carry a current of over 5 amperes (assuming a standard No. 18 cord is used). If a heater, or other appliance, consuming 15 amperes is connected to the extended outlet, too much current will pass through the portable cord and cause it to heat. This heating,

in time, may bake and loosen the insulation on the cord and very probably start a fire. The fuse, in this case, would be no protection since its purpose is to protect the first outlet which is perfectly safe

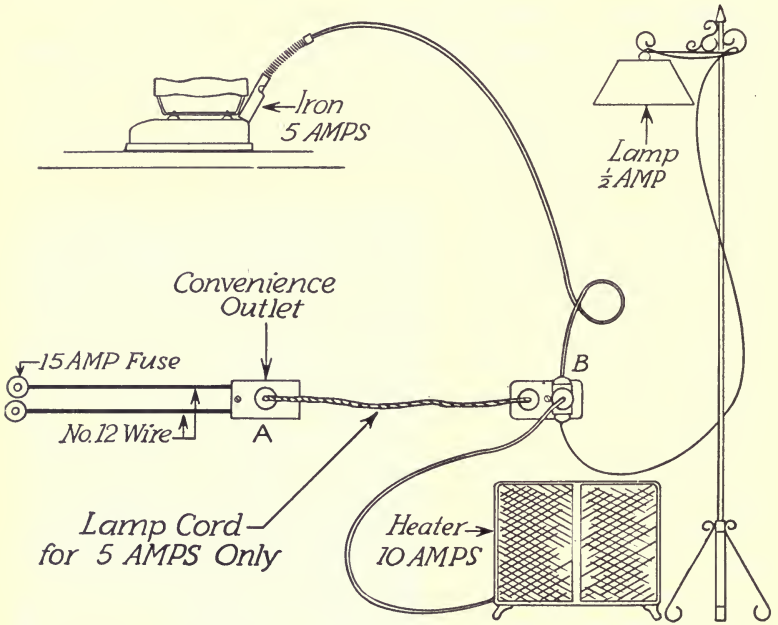

FIG. 85.—Improper use of extension cord should be avoided between outlets "A" and "B"

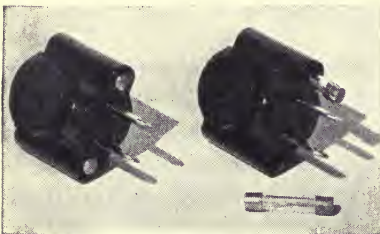

FIG. 86.—Fusible current tap for protecting branch circuits

for a 15-ampere load. If such an extension is to be made, it would be well to use a fusible current tap, which is shown in Fig. 86. This plug contains fuses that will not allow more than 6 amperes to pass through the heater cord, and it will give proper protection to the extended circuit.

There are several types of flexible or portable cords used for different purposes. These may be divided into two general classes—heater cord and lamp cord. Heater cord has an asbestos covering

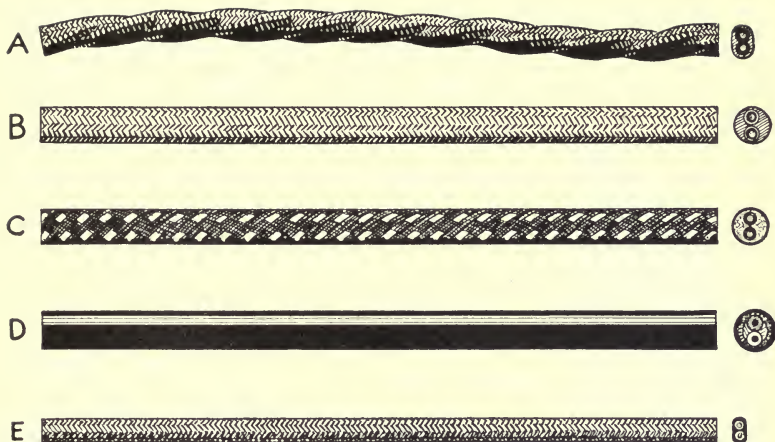

FIG. 87.—Typical extension cords. "A"—Twisted conductor, cotton covered. "B"—Portable show cord, but reinforced with a common cotton, rayon or silk covering. "C"—Portable heater cord, where each conductor is covered with asbestos to prevent burning. This type of cord should be used with all heating appliances, such as irons, heaters, toasters, etc. "D"—Rubber-covered cord, which is more durable than those previously described. Heavy-duty cord of this type has a thicker covering than ordinary cord. "E"—Decorative form of cord, usually oval in shape and covered with silk, rayon, cotton or rubber in several common colors

over each conductor to prevent any burning and is used with all electrical appliances dependent upon heat for their operation, such as the iron, toaster, stove, etc.

A description of portable cords may be of assistance since there are several kinds in use. These cords are shown in Fig. 87. Cords that have been approved by the Underwriters' Laboratories, Inc. have small tags wrapped around them every five feet, Fig. 88, and should be used.



FIG. 88.—Approved cord with identifying label

Other Means of Extension

A continuation of your present wiring system, unless it is very old and out of date, will probably be best for extensions. If you find that the desired extensions cannot be concealed on account of the construction of the house or the expense, the difficulty may be surmounted in several ways. An excellent exposed wiring system called "Surface Metal Raceway" is shown in Fig. 89. This metal

raceway, which contains the conductors, or wires, can be mounted on the inside surface of any building. It forms a complete wiring system suitable for the summer home or cottage, and for general

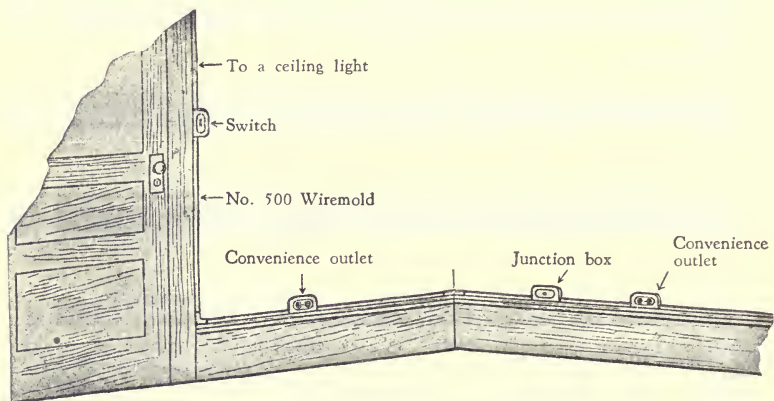

FIG. 89.—Surface metal raceway extension



FIG. 90.—A Wiremold installation in a summer cottage

extensions in any dry location. Fig. 90. By means of this raceway any wiring system may be extended. It is an ideal system, complete in every detail, and may be extended or removed at any time to suit your convenience.

In cases where it is desired to make a short extension from an existing convenience outlet, one of two methods may be used:—

The first is by means of a narrow metal raceway, shown in Fig. 91, where a permanent connection is made to the terminals of an existing convenience outlet. A special surface plate is used for covering the outlet. The two No. 14 conductors contained in this raceway are

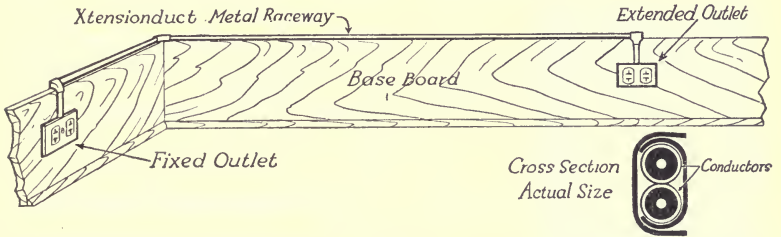

FIG. 91.—A method of extending the electric highway from one convenience outlet to another

then extended to other outlets and permanently connected. In this system the conductors are amply protected against mechanical injury and are also protected electrically by the regular fuse in the circuit being extended. Surface metal raceways may be painted any color to match existing finishes.

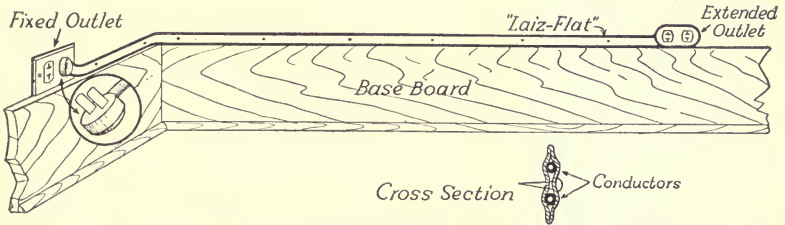

FIG. 92.—Another method of extending the electric highway for short distances

A second form of extension from an existing outlet is shown in Fig. 92. This consists of a special attachment plug into which are connected the conductors to be extended. The two conductors are rubber-covered flexible wires laid parallel in a flat fabric covering with sufficient space between the conductors to permit fastening with an insulated-head upholstery tack. When tacked into place, extra convenience outlets are permanently installed. There is a special

fitting for turning a right-angle corner which makes a neat appearance. This flat wire is made in colors to match standard woodwork.

It is difficult to make anything but general suggestions since all such extensions are prescribed by the National Electrical Code and are also subject to approval by local wiring inspection departments of many cities. However, the important consideration is to protect wiring from mechanical injury, to be certain that no live wires are

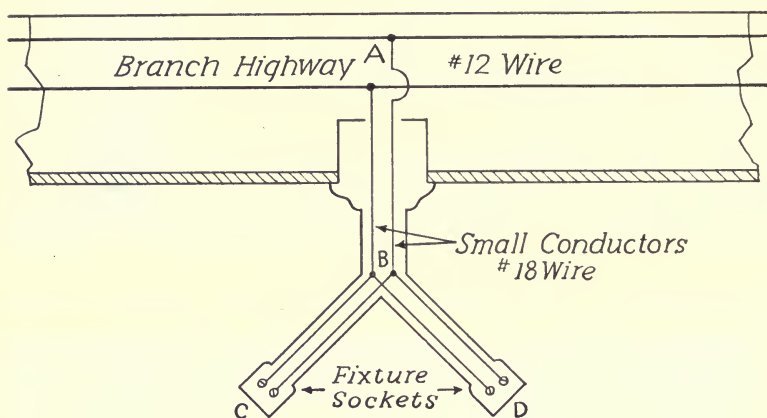

FIG. 93.—Fixture highways are usually small and should not serve heavy-wattage appliances. The fixture highway, "B," which connects the fixture sockets "C" and "D" to the branch circuit "A," is intended for supplying light bulbs only

exposed, and that the circuits are properly protected electrically by fuses of the correct size.

Care must be exercised that extensions do not overload existing circuits. It must be remembered that the circuits, when they were originally installed, provided a sufficiently broad electric highway to serve the original outlets. The addition of a number of outlets to these original circuits by means of miscellaneous extension cords is likely to increase the amount of electricity going through these original wires at one time to a point which may be dangerous, or may interfere with the efficiency of the lights or appliances that are connected to these extended circuits. Extensions from lamp sockets used for lighting fixtures should be avoided since the electric highway in the average fixture is small and not built for connecting appliances, especially those using over 660 watts. Fig. 93.

Checking Your Electric Highway

In planning your rewiring job it would also be well for you to check up on the wiring already in your home to make sure that it is capable of carrying any additional load and to see that the wiring already in use is still in safe and usable condition. It would be advisable, therefore, to have your electrical contractor go over the wiring system with you and check the service entrance wires leading from the street into the house to see that they are sufficiently large to supply your increased needs. Your main service switch should be enclosed in a metal box. Fig. 94. The distributing panel, or the box containing the fuses on your branch circuits, should also be enclosed in a metal box, Fig. 95, although a wooden box lined with asbestos may sometimes be used. It would be well, also, to check the size of fuses to make sure that they are neither too small nor too large to render effective service. Furthermore, it would be a decided convenience to make a list showing the location of fixtures and outlets in the several rooms which are protected by each of these fuses, as already suggested.

If your distributing panel or fuse-box needs to be replaced it might be well for you to consider substituting a "Nofuze" load center. Fig. 96. This is a relatively new device and considerably more convenient than the old fuse-plug and cutout.

Sockets, switches, convenience outlets and all other fittings throughout the house should be examined to see that they are in proper working order, and any defective or frayed cords should

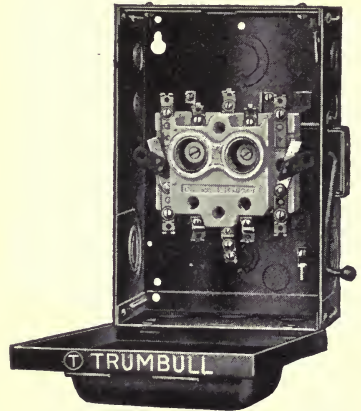

FIG. 94.—Modern service entrance switch

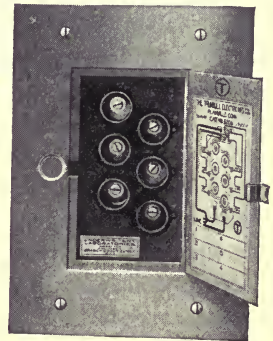

FIG. 95.—Modern distributing panel

be renewed. In the bathroom and laundry, or other locations where the floor is likely to be damp, all sockets, particularly those that are within reach, should be of porcelain. In all such cases chains from chain-pull sockets should be well insulated by a special insulator, Fig. 97, or by the use of an insulated cord. Go over carefully any exposed wiring in the cellar, basement or elsewhere to make sure

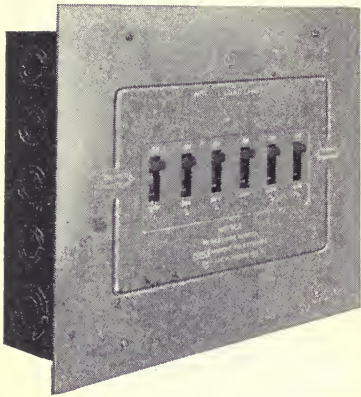

FIG. 96.—Distributing panel which uses circuit breakers instead of fuses. It is called a "Nofuze" load center

that the insulation on the wires is unbroken and adequate to protect the wires against possible contact or short circuit. Ask your electrical contractor whether the installation of the added outlets you have planned will make it necessary to install additional branch circuits, or will mean increasing the size of wire used in the branch circuits which you plan to extend.



FIG. 97.—Chain-pull socket insulator

Suggestions for Added Convenience

It is impossible to give any hard and fast rule for outlets to be included in any added wiring because of the different requirements of individual households. I shall, however, list a number of items which should have consideration and which may fit into your plans for making your electrical installation more convenient.

Because of the requirements of local ordinances and regulations affecting your fire insurance coverage, it is best to have a qualified electrical contractor supervise any extensive additions to your wiring installation. If you are going to make a few minor improvements yourself, however, it might be well that you follow the suggestions contained in Chapter Seven.

CHANGE SINGLE CONVENIENCE OUTLETS TO DUPLEX. One of the simplest improvements that can be made, and yet one which will add most definitely to your convenience in the use of electricity, is the substitution of duplex convenience outlets for the single outlets

thus making each wall outlet twice as serviceable. A double outlet can be substituted for the single outlet at a very slight expense and with practically no trouble at all, since it means no additional wiring.

COMBINE CONVENIENCE OUTLETS WITH PRESENT SWITCHES. Where additional outlets are needed in any room and where the item of expense must be considered, it might be well to incorporate a convenience outlet in the switch at the door, or with any of the wall switches in the room. Fig. 98. This change is usually a very simple matter and may not require additional wiring. It may not be quite as convenient as to have the outlet placed elsewhere in the wall, but it is certainly better than long extension cords dangling from center fixtures or wall brackets when using the cleaner or floor polisher.

INCREASE CONVENIENCE BY ADDING SWITCH CONTROL. Probably no feature of the electrical installation is so typical of the complete convenience afforded by electrical service as is the wall switch controlling your lights. At the touch of a switch as you enter, the room can be flooded with light. Again, as you leave the room, even though it be but for a moment, the switch turns off the lights until you need them again. Switches beside the doorway will prevent the annoyance of groping about in the dark for a pull-chain hanging somewhere in the center of the room, and will save you many a barked shin. And, in connection with dark places, don't overlook the automatic door switch for the closets.

In adding to the convenience of your wiring installation, therefore, the location of additional switches should be given particular attention. There should be a switch at each main entrance to every active room and hallway in the house. If the room or hallway has more than one main entrance, it will be of advantage to install two switches to control any light in that room. When two switches control a single light, the installation is called a "three-way" switch

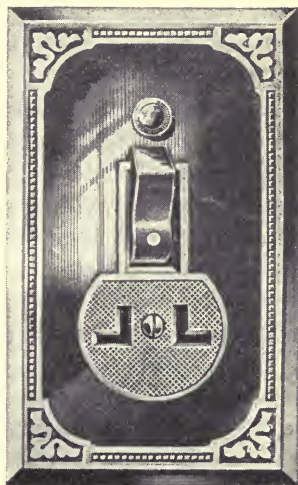

FIG. 98.—Combination switch and convenience outlet

control. A single light, or a group of lights, may be controlled from two or more points, as desired by using what are called "three-way" and "four-way" switches. Two-point control requires two three-way switches properly connected together, but control from three or more points requires the addition of a four-way switch for each location of more than two points. The terms "three-way" and "four-way" switches are somewhat confusing, but their installation is quite simple, and they are extremely useful when the same light must be controlled from more than one location. In hallways having three or four entrances there are sometimes as many as five switches all controlling the same light. If the two entrances to a room or hallway are more than ten feet apart it is well to provide a three-way switch at each doorway.

If your upper or lower hallway lights cannot be turned off or on from either the first floor or the second floor, an additional three-way switch should be installed and the present switch changed to one of the three-way type. Brackets and ceiling fixtures, as well as certain convenience outlets in some rooms, are usually controlled by wall switches at the door. Center lights in the kitchen, hallways or bathroom which have been operated by a pull-chain may be lighted much more conveniently if a wall switch is installed.

Fixtures containing several bulbs and controlled from one point may be so connected that one or more lights may be turned on or off as desired by an electrolier switch. For example, a ceiling fixture having four bulbs may be controlled by an electrolier switch so that one, two, three, or all lights may be turned on or off as desired or burned in any combination. The external appearance of an electrolier switch is the same as the ordinary type. However, the number of times it is operated determines the number of lights that are left on or off.

MODERNIZE YOUR LIGHTING FIXTURES. When revamping your wiring it would be well, also, to consider replacing some of the antiquated fixtures you may be using. Lighting fixtures are being improved constantly and new styles are periodically available. Not only are these new styles more attractive, but in many cases they are much more effective in diffusing the light to bring out the charm of your living room, or the beauty of your decorations or furnishings.

ADD CONVENIENCE OUTLETS IN THE LIVING ROOM, BEDROOMS AND HALLWAYS. If you were building a new home you would see

that plenty of convenience outlets were installed in the main rooms, but the present home is just as important. The rule for locating convenience outlets already mentioned in Chapter Three applies to any modernizing program and will bear repetition here on account of its importance.

“A sufficient number of convenience outlets should be installed so that no point along the floor line in any unbroken wall space is more than six feet from an outlet and with at least one convenience outlet in every wall space three feet or more in length.”

The cords supplied with floor and table lamps are approximately six feet long. This is the reason for the above rule. If, therefore, your outlets are placed approximately one for every twelve feet of wall space, a portable lamp can be connected at almost any point in the room.

The mere fact that you may not want to use all of these outlets with the particular arrangement of furniture which you now have in your living room, for instance, does not mean that they will not be needed to serve new lamps or another arrangement of furniture some-time later on. The location of convenience outlets, therefore, should be such as to provide connections for lamps and appliances regardless of the present furniture in the room.

For decorative lighting on the mantel, a special recessed convenience outlet can be mounted so as to allow the connecting plug of the lamp, or an electric clock, to sink out of sight below the surface. See Fig. 17, page 57.

In bedrooms where the wall space is such that but one arrangement of furniture is possible, a number of convenience outlets looking to future possible needs may not be absolutely necessary. At least two convenience outlets, however, should be provided in every bedroom, one for the night-light on the table next to the bed and the other for the connection of boudoir lamps and appliances on the dressing table.

PROVIDE FOR THE MORE CONVENIENT USE OF ELECTRICAL APPLIANCES. The increasing use of electrical labor-saving devices in the home has been so rapid within the past few years that few homes, even though they were built but three or four years ago, are completely equipped to make use of all of these modern devices. Electrical equipment for the home naturally falls into two classes:—

those which we may term portable appliances, such as the suction cleaner, toaster, floor polisher, percolator, waffle iron, etc.; and those devices which are more or less permanently located, such as the refrigerator, the electric range, the dishwasher, the oil burner, air-conditioner, etc. In any complete plans for rewiring a home these two types of equipment should be provided for.

In the kitchen, for instance, there should be a convenience outlet adjacent to the sink for the use of portable dishwashers, washing machines, percolators, kitchen mixers, etc. Unless this outlet can also be used for the connection of appliances on the kitchen table or kitchen cabinet, another outlet should be installed near that working area. The location of a convenience outlet at the back of the working shelf of your kitchen cabinet is particularly useful. The most desirable location for your ironing board will determine the proper point at which to place an outlet for your best ironing accommodation.

In the laundry there should be an outlet provided for the connection of your ironer, and it would be well to have this outlet installed on a separate circuit inasmuch as the usual ironer consumes more current than certain other appliances, and this current may be too much if the same circuit supplies other outlets. The outlet for the connection of the washing machine in the laundry may be suspended from the ceiling immediately in front of the washtubs. In this way the washing machine cord will not be lying on the damp floor, nor will it interfere with your movements around the machine.

The increasing number of health appliances being used makes an appliance outlet in the bathroom a decided convenience. This outlet should be located as far as possible from the wash basin or tub so that there will be no danger from handling appliances while in your bath. To this outlet can be connected the immersion hot water heater, milk bottle warmer, electric razor blade sharpener, or health appliances as needed.

The installation of convenience outlets adjacent to the workbench in the home shop, and in the garage or the children's playroom, should also be given consideration. You may want to use some of your appliances on the front porch, so do not overlook this location in planning additional outlets for greater convenience.

At least one convenience outlet should be provided at the front entrance, even where there is no porch, so that outdoor decorative lighting can be connected at Christmas or other seasons. On porches,

terraces and similar areas where guests may be served with a light luncheon, or where portable lamps and appliances may be used, convenience outlets should be provided on the house side for each fifteen feet of wall space.

PROVIDE CONNECTIONS FOR PERMANENTLY LOCATED ELECTRICAL EQUIPMENT. While doing your job of rewiring do not provide merely for the equipment which you may have at the time, but consider also the probability of your need for additional appliances in the future, as I have previously suggested. You are very likely to purchase an electric range if you do not already possess one. If you are not already using an electric refrigerator most certainly you will want to provide for that convenience as well. Possibly you will want to install an oil burner or an automatic anthracite burner to relieve you of your furnace tending. A dishwasher is a decided relief from the drudgery of old-fashioned dish washing. A ventilator in the kitchen, possibly in the transom over the outside kitchen door, or in the upper sash of one of the windows, will be a decided comfort in ridding the kitchen of cooking odors, or in bringing in the cool, fresh air from outside. You may want to install an electric hot-plate in the laundry, or an outlet for connecting a small heater in your garage.

Built-in heaters in your bathroom are also a decided convenience. The built-in type has, in many cases, replaced the former portable radiant heater because of the fact that the built-in heater is constructed so as to warm the air by circulation rather than providing heat in a single direction by radiation. You may want a time switch to turn on this heater just before you get up in the morning for your bath, so provide for this switch as well.

The increasing use and the complete satisfaction of electric clocks warrant special consideration of this recent addition to the list of electrical conveniences. At their present moderate cost several of these clocks can be used throughout the house most economically. An electric clock mounted on the kitchen wall is perhaps the first location to consider, while an electric clock on the living room mantel is a most satisfactory location for another electric time-piece. Electric alarm clocks for the bedrooms perhaps come next, and a "Grandfather's" clock for the hall makes a most desirable addition. When installing an outlet for the use of an electric wall clock, keep in mind the special clock outlet already mentioned.

Outside Wiring

The electric highway may be extended outside the home, either by placing convenience outlets on outside walls, or by running wires to points away from the house. Unless outside outlets are protected from the weather, they should be of the weatherproof type already suggested so that rain or snow will not get into them and cause corrosion. These connections will also serve for flood lights when illuminating the outside of the house, or for working in the yard after dark, for decorations during lawn parties, or special occasions. They are also necessary for supplying current to the electric lawn

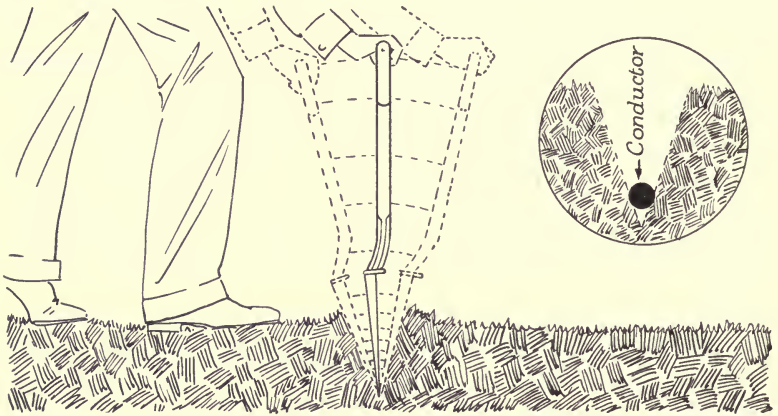

FIG. 99.—Method of laying underground conductors

mower or hedge trimmer. Other uses for electricity outside the house are suggested under the heading, "Out of Doors Electrically" in Chapter Five.

If possible, wire leading from the house should be placed underground, since overhead wires are unsightly. In most cases, underground wiring is easier to install and usually less expensive. Such a system may lead direct from the basement into the ground by means of a conductor called a "Parkway Cable." This duplex cable may be laid in the ground and does not need any special protection since it has a flexible metal covering of its own. A simple method of laying this cable in the ground is to make a small trench with a straight-blade shovel or spade stuck into the ground for a distance of about six inches and moved forward and backward so as to open

up a small "V"-shaped trench. Fig. 99. A similar trench, about 3 inches deep, may be made with an old axe. After the cable is laid, put the earth back in place and stamp it down. In crossing a driveway or garden, the cable should be put down deep enough to prevent being disturbed by any digging or washing away of the soil. Lead-covered cables may be installed in the same way and protected by placing them between boards in places where they might be disturbed. Connections should be made in waterproof junction boxes, or boxes protected from the weather. For temporary wiring, or for a few lamps a short distance from the house, rubber-covered heavy-duty portable cord may be used, either buried in the ground or used overhead. Such cable will last a long time, at least a year in average soil.

If overhead wires must be used, they may be supported on small poles or trees.

The switches for outside circuits should be within the house, so as to bring such a system under your control. Outside circuits should be independent of any others in the house.

Provide for Telephone, Radio and Bell Extensions

While planning the other electrical conveniences which you may wish to add to your present installation it might be well, also, to consider other related services.

The increasing use of the radio has brought about many makeshift installations. Your ground and aerial connections should be permanently installed in conjunction with, or adjacent to, a convenience outlet from which a wire is run to the attic for your aerial and another to the basement for your ground. This latter should be clamped to a water pipe (not a gas pipe). It might be well also to install an additional ground and aerial connection in one of the bedrooms so that a midget radio set can be used in addition to the main set.

Considerable improvement has recently been made in the equipment available for the bell and buzzer system of the home. Instead of having to use the old-fashioned bell or buzzer, mounted on the kitchen wall or in the back hall, these unsightly devices can now be replaced by a neat plate set flush with the wall, behind which can be located the bell-ringing transformer and the bell or buzzer. Such

a system may be combined with a convenience outlet. Perhaps a "Telechime" signal system, described in Chapter Five, may add to your convenience.

Where portable cords are used in connection with signal systems, intercommunicating telephones, and other low voltage circuits, they may be held in place above the baseboard by means of special metal clips such as are shown in Fig. 100. Such clips are easily inserted or removed.

Another feature which you may want to consider in revamping your wiring is an extension of your public telephone. Most telephone extensions have been installed with wiring run along moldings and over doorways, but these installations are being replaced by wire run through conduit inside the walls. Your electrical contractor, in conjunction with the business office of your local telephone company, will be glad to work out this problem for you.

All the foregoing methods and suggestions for modernizing the electric highway of your home and making it more adaptable to present-day needs, will be seen to have their

practical application when we come to our next chapter, or journey, dealing with the subject of electrical appliances. In other words, "there is a reason." Dirt roads and natural grades sufficed as long as old-fashioned wagons were our only means of travel, but today our highways must be of the very latest and most accommodating types of construction to further the speed, comfort and convenience of modern motor transportation. And by that same token, those modern "vehicles" of home comfort and convenience which are represented by your electrical appliances, should be afforded the best possible "surface" and "grades" to travel over, if you are to receive benefits commensurable with their full capacity for service—and that means a wiring system of the latest and most approved type.

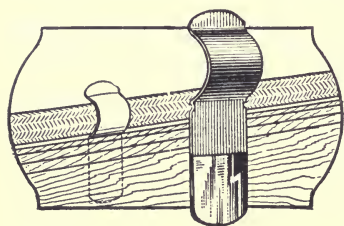

FIG. 100.—Metal clips held in place by the baseboard are sometimes used for extending cords

FOREWORD

To Chapter Five

IN the preceding chapters you were first made acquainted with "Enchanted Hill," learning how our home came by its name.

You were also given some idea of how easily every home can be made a place of enchantment—like the castle of your dreams—where no drudgery exists to cloud your domestic happiness.

You were then taken on a preliminary tour of inspection of the ingenious highway over which passes a continuous stream of electric "vehicles" bringing you every modern comfort which light, heat and power can bestow.

Following this initial inspection you were shown where and how to modernize and extend your own electric highway to facilitate the service these willing servants of comfort and convenience stand ready to provide.

In the next trip you were afforded a "night view" of this highway in which were pointed out a host of shortcomings inherent in the lighting facilities of the average home, all of which can so easily be remedied. And then you were shown how to extend the electric highway for your further comfort and convenience.

As our familiarity with this highway increases we are coming to see, more and more, how very efficiently it can be made to serve us. The purpose of highways, of course, is to enable us to travel safely, comfortably and conveniently to our destinations. But we do not live on them any more than we dwell in the hallways and other connecting passages of our homes. The electric highway and the hallway must both be conveniently designed and sufficiently wide to function properly, but when they have led us to the rooms where most of our indoor hours are spent, they have served their chief purpose.

The electric highway, then, merely provides our electric servants with the facilities required for the performance of their duties. The electric servants themselves, or the appliances which connect with the outlets opening off the electric highway, are what most concern us. It is these devices which supply the great majority of our daily comforts.

Let me add this word of explanation before we go any further into this chapter on Electric Appliances:—I fully realize that in this day and age a great many of the devices and their uses which I am listing and describing are familiar articles of utility already long in use in many homes. I ask my readers

who possess a great number of these appliances to bear with me in this repetition of their own experiences. Others, who have a few of these appliances which have been long in use, may find it desirable to learn of the latest and most efficient models here described. It is my hope that the majority of readers will find sufficient interest in the newer developments along this electric highway to warrant the journey. Much ground must be covered in a manner that provides, in many cases, for only brief descriptions. But what is necessarily lacking in detail I have tried to offset by completeness.

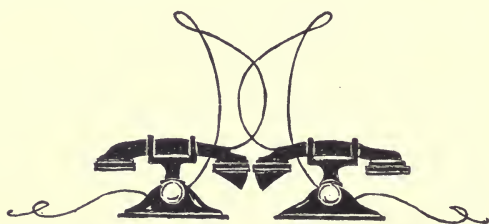

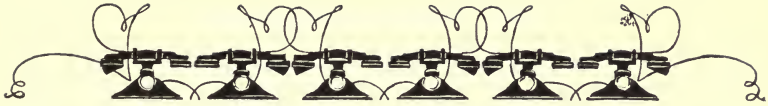

CHAPTER FIVE

Little Journeys Into Modern Wonderland

Somewhere I have read of an interesting family by the name of "Day." Have you ever made their acquaintance? The seven-room house in which they live is called "The Week," and it is located on "Month Street" which is one of the twelve roads running through "Year Town" in the wonderful country of "Time."

In casting about for some means of making our next journey—(which is a long one, because we must interview so many electric servants)—more comfortable and entertaining, this little fiction of Mr. and Mrs. Day and their family may serve as a useful and logical "conveyance." For must not our household duties be attended to every day in the week and every month in the year for all time?

Instead, therefore, of making this long journey all on one trip, it will be more convenient to divide it into seven short stages and, beginning with Sunday, plan a separate excursion for each day of the week. Our excursions will lead us through the "Seven-room" house in which the "Day Family" lives and we will imagine that each room stands for certain household duties which each member of this family, or any family, regularly performs by means of modern electrical appliances.

We will begin with Sunday, for that is a day of rest and recreation and our first trip is merely an introductory one in which we will ramble leisurely through the general subject of appliances. Needless to say, it is "Mr. Day's Room" we are now about to visit!

In each one of these "calls" upon this interesting family I want you to observe a few things of major importance about the discussions we shall have and, so that you may be prepared in advance, I shall give you a list of the subjects for each day. Not to burden you with all of them at one time, I am disclosing only the "program" for each day in turn and, in addition, I shall ask you ten questions before we start out on each journey. These questions will relate to the particular points of interest you will meet on the way. You will find the answers in each section following, so I would caution you to listen attentively to what the "guide" has to say!

SUNDAY'S PROGRAM

GENERAL STATEMENT OF APPLIANCES.

THE SELECTION OF APPLIANCES.

WHERE TO PURCHASE APPLIANCES.

CARE OF APPLIANCES.

COST OF OPERATING APPLIANCES.

What is the average hourly wage of an Electric Servant?

What are the two main considerations in purchasing electrical appliances?

What two classes are all electrical appliances divided into?

What kind of dealer is it best to buy your electrical appliances from, and for what two reasons?

What two other considerations are important to remember in the selection of appliances besides the purchase price?

What must be known about the kind of electricity your home is supplied with before purchasing some appliances?

Read carefully the section on "Care of Appliances." Are there any of these "points" you have not been in the habit of observing?

When should attention be given motor-driven appliances?

Is it clear to you why automatic appliances cost less per hour to use than non-automatic ones?

Must you be careful in purchasing appliances provided with regulating or automatic devices to make certain that they "fit" the kind of electricity you have in your home?

SUNDAY'S JOURNEY

In this great country of ours there are many happy homes where the routine of household duties is a pleasure to the families that live in them. The work is easy. In contrast to this are other homes that mean little to their occupants. There is less happiness and comfort. The necessary routine work is drudgery.

This contrast is due to many causes outside the province of this book, but it is a known fact that household drudgery is one of the chief factors contributing to domestic discomfort and unhappiness. Solve this problem and most of the other troubles disappear. A knowledge of what is being done electrically in many thousands of homes where the servant problem and the personal labor problem no longer exist may help you to banish such cares forever.

In this book, and especially in this chapter on Electrical Appliances, I am suggesting equipment that will help any family in its daily household problems. Scores of these electric servants are now efficiently at work in many homes and new appliances are constantly being developed by the manufacturers of electrical equipment. Since I cannot describe these new servants and services until they are made available, I suggest that you keep up to date electrically for your greater convenience and happiness.

But whatever the value of these future developments, it is well to remember these simple facts:—Electricity is ready to serve us at the touch of a switch. Electricity is never tired, and does more work for less money than any form of energy known. Every penny spent for electricity cures a household ill. It drives away drudgery and replaces it with health and happiness. Electricity embodies all the virtues of an ideal servant with none of a servant's customary faults. It is an unseen host—the counterpart of your every wish—instantly ready to do your bidding.

With such a servant available, it would really seem an extravagance to be without all of the useful devices through which it can be put to work. Today, electrical equipment is not a luxury but a necessity in efficient housekeeping. With the cost of electricity what it is, and the very low cost of many of the appliances, it really is more economical to have them than to try to get along with old-fashioned methods and devices. The electric iron probably is the best example. An hour's ironing can be done with the average

electric iron at a cost of about three cents. It is doubtful if we could buy other fuels to heat an old-fashioned iron at such a price.

The superiority of electrical devices, the clean, sootless heat they develop, and the thoroughness with which they do their tasks, make it preferable to use electricity. A broom or a carpet-sweeper may be less costly than a suction cleaner, but there is no comparison in the thoroughness of the jobs they do. Cooking with an electric range in some localities may be a little more expensive than using other fuels, but the automatic control and the clean, smokeless, odorless "fuel" which neither heats the kitchen nor darkens walls and curtains, and the satisfaction of using the most modern of ranges, all make up for any slight additional cost. An electric refrigerator may cost more than an ice-chest in the beginning, but it soon makes up for this initial cost through the advantage of scientific food preservation and the savings made in its higher efficiency.

In deciding on the purchase of any electrical appliance, there are at least two main considerations to keep in mind:—First, there is the matter of cost alone. Not only the first cost, but the cost of operation and the savings through its use should be considered in this connection. Second, there is the matter of the increased convenience in making use of electricity. Plan your budget to include such appliances as will help you most. There are many things, also, which electricity can do for us that no other agency can offer. This is particularly true in the field of health appliances such as the sun-ray lamp.

Considering these points, therefore, it is no wonder that the use of electrical devices is becoming universal and that every home is depending more and more upon electricity as a most practical and helpful servant. It would be impossible for me to describe all the appliances, or to give all the details of the many types which are available in a single kind of appliance, but in the following pages I shall try to bring out the essential services which can best be accomplished by electricity, the features to be considered in purchasing appliances, how to get the greatest use out of them, and how to take care of them.

With the exception of the special uses of electricity, as exemplified by health devices which depend for their action on various types of light and heat rays developed, all electrical appliances can be divided into two classes:—those using electricity for heating, and those

employing electricity to develop mechanical action. Heating appliances depend on the heat developed by an electric current passing through a special wire or through water, while mechanical action is produced through the use of electric motors which have an almost unlimited application.

THE SELECTION OF ELECTRICAL APPLIANCES

There are a few general principles to keep in mind in the selection of electrical appliances. I shall try to summarize these points briefly before taking up the features of individual appliances. Then, as we discuss each one separately, I shall bring out a few points for consideration regarding each particular device.

Buy From a Reputable Dealer

No matter how perfect a mechanical product may be, there is always a chance that it will need some little repair or adjustment from time to time. Care and attention after purchase is as important as courtesy during the sale. It is good policy, therefore, to purchase any electrical device from a dealer who is going to continue to do business and is as interested in making a second sale to you, even though it be some years in the future, as in making an immediate sale. An article may be unconditionally guaranteed, but the guarantee is only as good as the organization issuing it, for if there is no one to make good on a guarantee you might as well not have one. Some dealers who rely principally upon the low price of their merchandise to attract purchasers are able to offer such prices because they do not intend to render any service after the sale is made. So, in your selection, make sure that the dealer can be relied upon to serve you and secure new parts for your appliance when they are needed, for you can buy appliances good for years to come and not just for a few months.

Low Price is Only One of a Number of Important Factors to be Considered

Real economy in the purchase of any article concerns not only the original purchase price but the length of time the article will be useful and the cost of keeping it in working order. Therefore,

it is well to look beyond the original cost in purchasing any electrical appliance. Reputable manufacturers do not produce articles as low in price as those of some of their competitors, because years of experience have proved that many low-priced articles do not give entire satisfaction to their users, and that dissatisfaction reflects upon the manufacturer in his future sales.

The purchaser of appliances has many types to choose from, and at varying prices. With a price range of from one to nine dollars, there must be a considerable difference in flatirons, for example. The cheaper they are the more of a gamble they are, while the more expensive ones—fully automatic, chromium-plated, and with other desirable features—will last many years. The cheaper iron usually is not automatic, and has a perishable finish, but it may be better than no iron at all. The cheaper appliances may be satisfactory enough for use temporarily, or when required only for occasional use. It is impossible to pick out the best appliances in any one particular class, but those that are automatic in their operation are strongly recommended. The cost of appliances varies according to quality about the same as in any other equipment or material. There is, however, an element of gamble in buying any cheap appliance, since if it cannot be used, or does not last, it is money thrown away. But there is a "middle ground." If you cannot afford the best appliance, select one that is within your means, but don't go without its helpful service—"half a loaf is better than none."

In general, look for good mechanical construction, avoiding those appliances that are flimsy or not carefully put together. As a rule, all of the more expensive appliances are well made and with reasonable care will give many years of service. The fewer the parts the better, especially with such items as washers, cleaners, floor polishers, etc. Rust-proof materials, or non-tarnishing finishes, are always the most desirable. In such appliances as toasters, stoves, percolators, grills, etc., used on the table, are the supports so constructed that they will not scratch a polished surface? Has the appliance a nameplate so that you can tell who made it?

Unless you purchase appliances locally, the proper voltage of your house circuit should be determined and this information given to your out-of-town dealer when making purchases away from home. Your voltage is probably 110, 115 or 120 volts, which are the standards in this country. All appliances requiring heat will operate

on either direct or alternating current, but with some automatic appliances the kind of current to use must be known. When making a purchase, the question of the kind of current must be settled.

Improvements are continually being made in appliances, and new ones are being brought out from time to time, so be on the look-out for those that are up to date, as well as for new appliances which will provide you with additional helpful services.

THE CARE OF ELECTRICAL APPLIANCES

To obtain the greatest benefit from your appliances see that they are well taken care of. Well designed and constructed appliances, properly used and cared for, will give many years of service.

In many cases some little defect will make an appliance inoperative, and a few minutes' use of a screwdriver will eliminate the trouble. Furthermore, an occasional inspection may prevent the development of troubles.

The amount of care required by electrical appliances is very small but there are several things to keep in mind regarding all appliances.

- 1.—Follow carefully the directions furnished with the appliance by its manufacturer. Keep these directions on file where they may readily be consulted in case of necessity.
- 2.—Turn off the current when the appliance is not in use.
- 3.—Keep water away from the electrical parts of any appliance, especially heating elements and motors, or where water is not intended.
- 4.—Be careful of connecting cords, avoiding excessive strain and twisting by pulling on the plug rather than on the cord. Keep moisture and grease away from the cord since they tend to destroy the insulating covering.
- 5.—If you notice any loose screws or nuts, tighten them immediately or they may cause injury later on.
- 6.—In cleaning or repairing an appliance which has its active heating wires exposed, be most careful not to disturb the wires.
- 7.—If repairs are needed, attend to them at once.

- 8.—Keep appliances clean at all times. The use of a little ammonia in water is recommended for removing finger-prints, smears, grease, etc., on polished surfaces. Where the surface has been neglected and is tarnished or quite dirty, a good grade of metal polish should be used. If a nickel-plated surface has become badly worn it will be necessary to have it re-plated.
- 9.—If electrical contacts are dirty or corroded, clean them with fine emery cloth or sandpaper.

These suggestions cover the care of most appliances but I suggest that you carry out the instructions furnished by the manufacturers.

The electrical problem of motor-driven appliances is easily solved since it is confined entirely to the driving motor and its controlling switch and cord. The electric motor requires proper lubrication of its revolving shaft, and different methods of lubrication are used by various manufacturers. The usual method consists of a grease or oil cup on each of the two motor bearings which support the revolving shaft. This consists of a small metal cup which holds the oil or light grease, and a wick which passes from the inside of the grease cup through the motor bearing and rubs against the revolving shaft to keep it lubricated. Fig. 101. These cups should contain oil or grease at all times and should be kept clean.

Another method of lubricating the motor, where a few drops of oil should be used from time to time, is shown in this same illustration.

Ball-bearing motors require less attention than those fitted with plain bearings.

The kind of lubricant to use and the proper intervals between refilling the lubricating cups for each particular motor will be found in the instructions furnished by the manufacturers, which should be carefully followed. Regardless of instructions, however, it is most important to see that lubrication is always provided, so when purchasing a washer, a cleaner or any other motor-driven device, always observe how it is lubricated.

In any motor-driven appliance it is important that the motor should start the instant the switch is turned on. If the motor fails to start and simply "hums," the switch should be turned off immediately, as otherwise the motor might be damaged. A motor should

never smoke or give out a strong burning odor. If it does, something is wrong and it should be investigated at once. All motors develop a certain amount of heat after being in operation for some time. This heat should never be so excessive that you cannot hold your hand on the outside frame of the motor. If an unfamiliar noise develops in any machine, locate the cause immediately and then make whatever correction is needed.

COST OF OPERATING ELECTRICAL APPLIANCES

Even in the hey-day of the old-fashioned "hired girl" of years ago, when she did everything in the home from mowing the lawn and doing the laundry for the entire family to washing the children's faces before they went to Sunday School, a wage of three cents an hour would have been unheard of. And yet, today, that is about what we have to pay per kw.h. for the use of our most efficient servant—Electricity.

It is difficult to give the exact cost of operating any particular appliance on account of the different rates charged for electricity in various parts of the country, and also on account of the varying sizes of appliances and amounts of electricity required for their operation. Appliances having regulating switches or thermostats also make the cost of electricity difficult to determine.

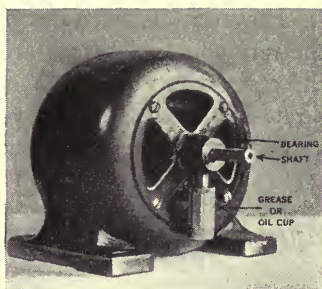

Motor fitted with grease or oil cup



Grease or oil cup removed from motor and wick exposed



FIG. 101.—Parts of the motor that require lubrication. Wick "B" in center illustration conducts oil or light grease to motor bearing

However, if the watts or power consumed by any device, and the rate you are charged are known, it is a simple matter to obtain the cost for any period of operation desired. In the following table a rate of three cents per kw.h. has been assumed for the use of each appliance for a period of one hour.

Approximate Cost of Operating Average Electrical Appliances

<u>Appliance</u>	<u>Watts consumed</u>	<u>Cost per hour</u>
Air-Conditioner	1000	.03
Casserole	325	.00975
Chafing Dish.....	660	.0198
Cleaner, suction	300	.009
Clock	2	.53 a year
Clothes Dryer.....	1320	.0396
Coffee Maker	400	.012
Cooker, fireless type.....	450	.0135
Comb, oil	25	.00075
Corn Popper.....	500	.015
Dishwasher	150	about .05 a week
Doughnut Baker.....	660	.0198
Drink Mixer.....	22	.00066
Egg Cooker.....	660	.0198
Fan, desk.....	50	.0015
Fan, ventilating.....	100	.003
Floor Polisher	400	.012
Food Preparer	110	.0033
Freezer, ice cream.....	250	.0075
Fryer, deep French.....	1150	.0345
Grate, fireplace	60	.0018
Hair Dryer	450	.0135
Heater, aquarium.....	75	.00225
Heater, auto engine	200	.006
Heater, household water	2000	.06
Heater, large air.....	1320	.0396
Heater, radiant	660	.0198
Heater, water immersion	300	.009
Heating Blanket	100	.003
Heating Pad	60	.0018
Hedge Trimmer	50	.0015
Hotbed Heater	120	.0036
Hot Plate, large.....	1320	.0396
Hot Plate, small	660	.0198
Humidifier	50 (motor)	.0015
Insekiller	75	.00225
Iron, automatic.....	1000	.03
Iron, non-automatic	660	.0198
Iron, curling	25	.00075
Iron, waffle	500—800	.015—.024
Ironer, rotary type	1320	.0396
Ironer, presser type.....	1320	.0396
Kettle, tea.....	1000	.03

<u>Appliance</u>	<u>Watts consumed</u>	<u>Cost per hour</u>
Lamp, infra-red ray.....	100—250	.003—.0075
Lamp, ultra-violet ray.....	175—400	.00525—.012
Lawn Mower.....	500	.015
Lighter, tobacco.....	100	.003
Milk Bottle Warmer.....	660	.0198
Paint Sprayer.....	200	.006
Potato Baker.....	450	.0135
Pump, washer.....	100	.003
Pump, water supply.....	250	.0075
Radio.....	100	.003
Range.....	7500	.225 entire range
Refrigerator.....	225	about \$18 a year
Roaster.....	635	.019
Sandwich Grill.....	660	.0198
Sewing Machine.....	25	.00075
Sharpener, razor blade.....	25	.00075
Shop Tools.....	50—250	.0015—.0075
Skin Patter.....	8	.00024
Soldering Iron.....	55—100	.00165—.003
Toaster, plain.....	450	.0135
Toaster, automatic.....	925	.02775
Toys.....	25—400	.00075—.012
Vaporizer.....	1000	.03
Vibrator.....	60	.0018
Warmer, food or plate.....	660	.0198
Washer.....	250	.0075
Wiener Cooker.....	300	.009

The above figures are for the maximum wattage of the appliance, operated continuously for one hour.

If your local rate is more or less than 3¢, the cost given in the foregoing table must be multiplied by a figure that represents the ratio of your local rate to the 3¢ rate. For example, if your rate is 4¢, multiply by 1⅓. See other examples as follows:

Rate	Multiply by	Rate	Multiply by
.01	1/3	.06	2
.02	2/3	.07	2 1/3
.03	1	.08	2 2/3
.04	1 1/3	.09	3
.05	1 2/3	.10	3 1/3

For any different period of time than 1 hour, simply multiply by the number of hours or fraction of an hour desired; as, for example, a flatiron consuming 660 watts (.660 kw.) is used for 2¼ hours. The cost of operating on a 3¢ rate would be 3 × .660, or \$0.0198—practically 2¢ (\$0.02) per hour. For a period of 2¼ hours it would cost 2¼ times this amount, or 4½¢. If the rate were 5¢,

the cost would be $4\frac{1}{2}$ times $1\frac{2}{3}\text{¢}$, which is $\$0.074$. For more details about the kilowatt-hour, see pages 28 and 409.

The table of operating costs (pages 170-171) is compiled by dividing the watts consumed by the appliance by 1,000—which gives the number of kilowatts consumed by the device. In other words, an appliance consuming 500 watts would be equal to $\frac{1}{2}$ kilowatt, or 500 divided by 1,000. The number or fraction of kilowatts is then multiplied by the rate of 3¢ —which, in the above case, would be $1\frac{1}{2}$ ($.5 \text{ kw.} \times .03 = 1\frac{1}{2}$ cents)—the total cost of operating the device for one hour.

The figures for the watts consumed by the various appliances may vary somewhat from those given in the table, and the most accurate way is to determine the number of watts consumed by reading the name-plate on the appliance.

If the watts are not given, as in the case of motors, they may be obtained by multiplying the volts and the amperes together. Thus 115 volts multiplied by 6 amperes equals 690 watts, or .690 kilowatts. The watts consumed by a motor vary with its load, or work it is doing, and can only be obtained by measurement. However, if we take three-quarters of the sum obtained by multiplying the volts and amperes together, the watts consumed may be approximated. The name-plates show the amperes at full load.

In figuring the cost of operating any appliance it must be remembered that in their general use the amounts of current vary, since many appliances are controlled by some regulating device or thermostat which turns the current on and off intermittently. For example, an electric oven may consume 3,000 watts in reaching its proper temperature, taking several minutes to do so. The thermostat then shuts off the current and keeps it off until the oven requires more heat. From this it will be seen that the 3,000 watts are not used continuously.



PREPARATION FOR MONDAY'S JOURNEY

The genial and leisurely "Mr. Day" now having given us a general dissertation on the activities of his busy family, we might have very natural misgivings as to the reception we are likely to meet with in our next call upon "Mrs. Day"—in Monday's Room! In the first place, how would we ever get to our destination through the blockading clothes lines and "detour" signs of flapping sheets and underwear? And even if we should succeed in reaching Monday's doorway, would Mrs. Day have any time to give us?

But, of course, we were thinking of the old-fashioned "Washday." As a matter of fact there were neither clothes lines nor flapping white "ghosts" to impede our journey. And, as a further surprise, Mrs. Day opened the door to us—a gracious, smiling hostess with a cheery welcome, dressed as if she were giving a "bridge"—which, it developed, she actually was!

It appeared that the washing and ironing had all been done, and without the least labor or confusion. Quite to the contrary, it had been a pleasure—as it always was in this modern Monday's Room.

"But I will let you judge for yourselves," she said, as she led us into her amazing Electric Laundry.

"Of course, there must be an abundant supply of hot water," she explained, "and so I will first show you our electrical water heating equipment."

And so, part two of this series of trips to Modern Wonderland now begins with:

MONDAY'S PROGRAM

HEATING WATER ELECTRICALLY.

LAUNDERING CLOTHES ELECTRICALLY.

What principal methods, employing electrical devices, are available for supplying hot water to meet all household requirements?

What advantages have electric water heaters over other types of equipment for furnishing hot water supply?

What two mechanical principles of cleaning are employed in the design and construction of electric washers?

What precautions should be taken in sorting clothes for the electric washer? Should colored goods and those made from vegetable and animal fibres be handled separately?

Failure to obtain desirable results in washing blankets is due to what six causes?

Are you familiar with the most approved methods of laundering various types of clothing and materials?

What treatments are best for removing various kinds of stains from materials and clothing?

What modern convenience and economy features should you look for in an electric hand-iron?

What other types of electric ironers and pressers are available besides the hand-iron for large pieces and more extensive laundry requirements?

What five great advantages are offered by electric clothes dryers?

MONDAY'S JOURNEY

HEATING WATER ELECTRICALLY

Perfection is again reached by heating water electrically: a tumblerful, a teakettleful, or a supply for the entire house. It is just a matter of putting an especially constructed electric heater in water and turning on the switch—continued simplicity!

There are three general types of water heaters: the permanently installed heaters in storage tanks for general household requirements, electric teakettles containing a heating element, and the small immersion heater for portable use.

HOUSEHOLD HOT WATER HEATING. A constant supply of hot water is a necessity in any home and there are two general types of heating systems in use—the instantaneous and the storage tank. The former heats the water as it is required and takes a large amount of fuel for a short time. The use of the storage tank is preferable since a smaller quantity of fuel is required, but for a longer time. Such storage tanks are heated by the fire in the range or furnace. In these systems, the amount of heated water and its temperature depend upon the condition of the fire. Such storage systems require that the tank be located very close to the stove or furnace. Furthermore, this combination of storage tank and means of heating requires a chimney or flue for removing the fuel gases and smoke from the heating source. This, as well as other limitations, does not always allow the storage tank to be economically located. The use of long pipes wastes hot water. Any storage tank should be thoroughly insulated so that little heat goes off into the room to be wasted. Pipes carrying hot water should also be insulated to prevent the loss of heat in the water.

The electric hot water heater, shown in Fig. 102, overcomes all these objections and may be placed in any convenient or economical location—the kitchen, any closet, bathroom or hallway. Its attractive appearance in various colored finishes makes it unobjectionable in exposed locations. It is entirely independent of any fire and does not require a chimney or flue, and there is no chance for explosions. Besides the ordinary piping connections for both hot and cold water, all that is necessary is its proper connection to the electric highway of your home. This circuit, like that of the range, should be independent of all others. The electric hot water heater, with its auto-

matic thermostat control, will provide hot water the year 'round. without any attention. Where a satisfactory system is now in use in connection with the main heating system of the home, the electric heater may be used as an auxiliary, supplying all the hot water

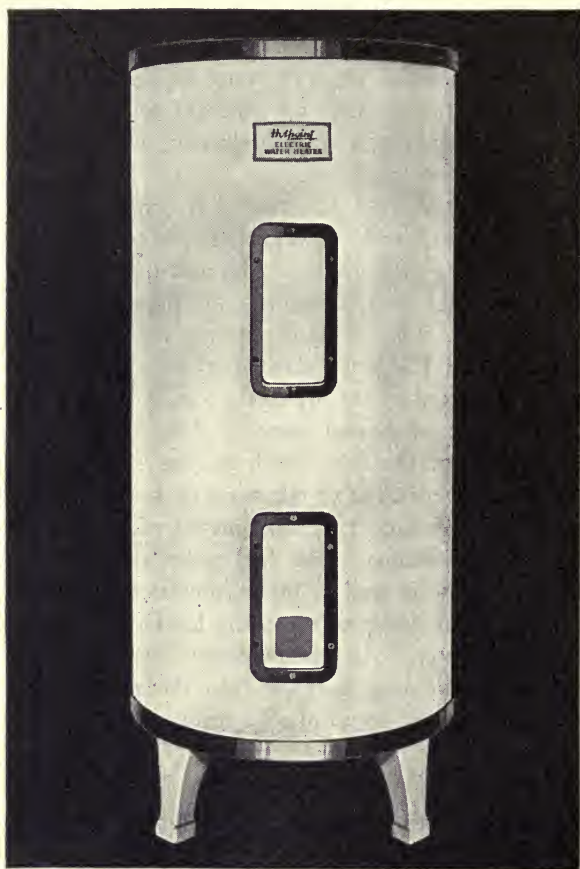

FIG. 102.—Modern electric water heater for family supply

during the off-heating or summer season. An independent electric heater may be attached to your present storage tank, if desired, as shown in Fig. 103.

These heaters work on the same principle as the little immersion heaters (a description of which follows), with a large heating unit

attached to the water storage tank. The efficiency of heating hot water electrically is practically 100 per cent because all the heat developed by the electric current passing through the heating element is absorbed by the water in the tank.

The capacity of the storage tank required in your home will depend upon the size of your family and its requirements for hot water.

The cost of heating water electrically depends upon the rate you pay for such service. In some locations reduced rates are available at night and such cases offer a saving by heating water at that time and using it during the day. This may call for

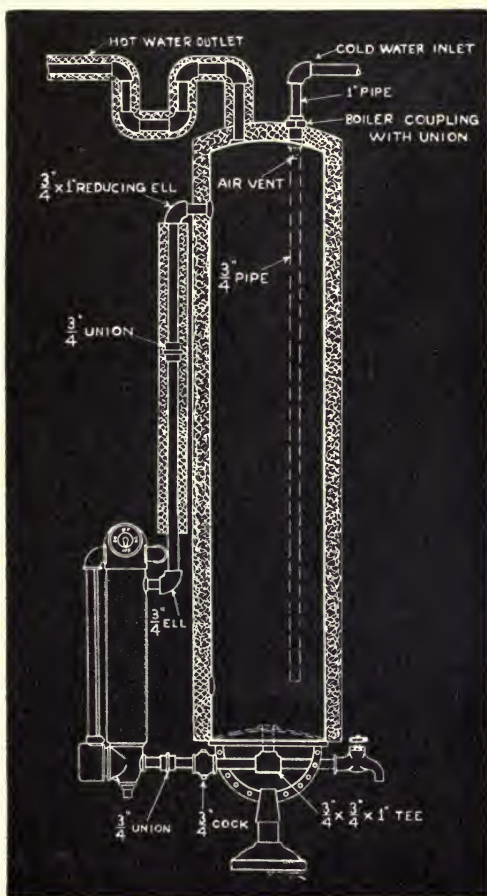
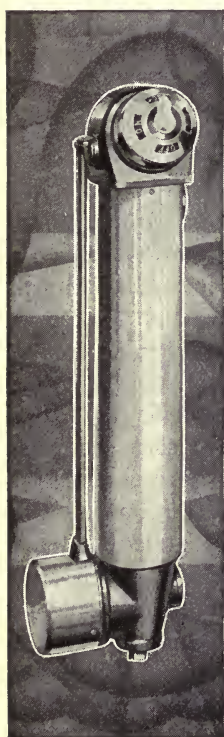

(Hotpoint)

FIG. 103.—Non-automatic water heater (at left). Shown attached to storage tank (at right)

a larger storage tank, and automatic time switches for proper control of such systems.

TEAKETTLES. Although the teakettle is a comparatively new electric appliance, it is already made for practically every purpose. For washing and sterilizing and for use in the kitchen, especially in



(Universal)

FIG. 104.—Electrically heated tea kettle with self-contained heating unit

the summer, you can buy a heavy aluminum or copper kettle of several quarts' capacity with the heating element on the bottom, so that you can boil water quickly and conveniently. For use in first-aid, in the nursery, in the kitchen of the summer cottage, or in the second floor bathroom in case of illness, the similar but smaller size is a godsend. Fig. 104. The hostess serving tea has the choice of several types. She may select a small chromium-finished kettle that rests on a

stand containing the heating element. In reality, this is a tiny stove which has a fast and slow heat, so that after the water boils it may be kept hot without further boiling. Or, she may prefer just a little chromium-finished kettle with a built-in heating unit. Again, she may be attracted by a dainty model that has a separate base beneath,



(Westinghouse)

FIG. 105.—Immersion water heater

and above, suspended on a stand—a kettle that may be either lifted off or tilted forward in position when the water is poured. Or she may like to make her tea with a somewhat similar kind that has a tea ball in the top and is complete in itself.

IMMERSION HEATERS. Immersion heaters are for the purpose of heating a small amount of liquid—a mug of water for shaving, warming

the baby's milk, or for use in summer hotels or cottages when a hot drink or small quantity of hot water is desired. To heat more than a few pints of liquid with this type of heater requires considerable time.

The metal end away from the handle, Fig. 105, contains the heating element which must be entirely immersed in the liquid before

the current is turned on. Most heaters have either a two-piece attachment plug or a switch on the handle for ease in connecting and disconnecting. It is very important that the electricity be shut off when the heater is not in the water, since otherwise it will overheat and burn out.

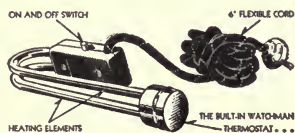
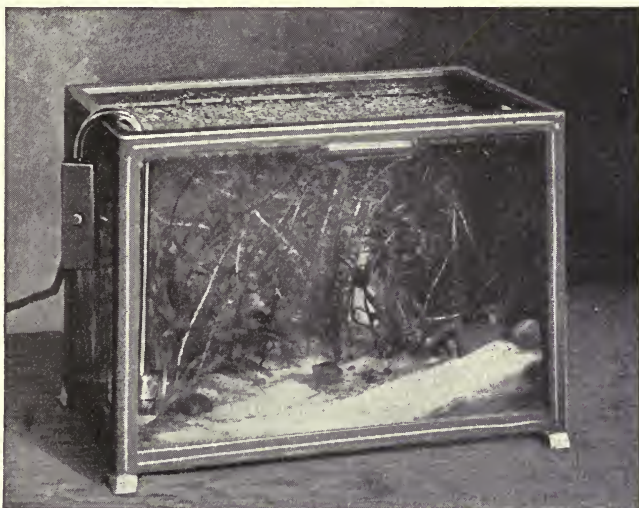

FIG. 106.—Automatic aquarium heater and its application

AQUARIUM HEATER. Another form of immersion heater, shown in Fig. 106, is used for keeping the water of the tropical aquarium at a proper temperature. This heater differs from the regular immersion heater, since it contains an automatic thermostat and cannot become overheated.

LAUNDERING CLOTHES ELECTRICALLY

As a labor-saving device, the electric washer has no equal, and for convenience the electric iron has earned the reputation of being used in more homes than any other electrical appliance. However,

there are other devices made for the home laundry, all of which make the laundry work easier and certainly save time.

Such equipment, which I am suggesting in the following pages, is as follows:

WASHING MACHINES.

FLATIRONS.

AUTOMATIC IRONERS.

ROTARY TYPE.

FLAT-PLATE PRESSER TYPE.

CLOTHES DRYERS.

IRONING BOARDS.

The Electrically Operated Clothes Washer

Washday! How many years of drudgery that word suggests, for washday is almost as old as history. And to my mind the methods used today in laundering are a pretty good measure of the progress made by the individual housewife. There are still many improvements to be made in the laundering habits exhibited in American homes: scrubbing boards, tubs filled with pails of hot water and the old-fashioned clothes boiler are still in use, even where the family budget allows hiring outside help to do the washing. Many do not realize the terrific wear and tear on clothes which are sent out to the laundry. Clothing that is washed at home lasts much longer. Then, too, there are many housewives who have electric washers and are not using them to full advantage because they have never stopped to study the easiest and simplest way to put this electric servant to work. It is to help the present owners of washers to secure greater service from their machines, as well as to guide those who are going to purchase new washers, that I am describing the washer and suggesting ways of using it.

THERE ARE TWO PRINCIPLES USED IN MODERN WASHERS. The purpose of any apparatus for washing is to force the water and soap through the clothes so that the dirt and soil will be removed. This is true in all cases, whether the home scrubbing board and clothes boiler are used, or the huge revolving vats of the power laundry and the modern, small and efficient, yet gentle electric home washer are

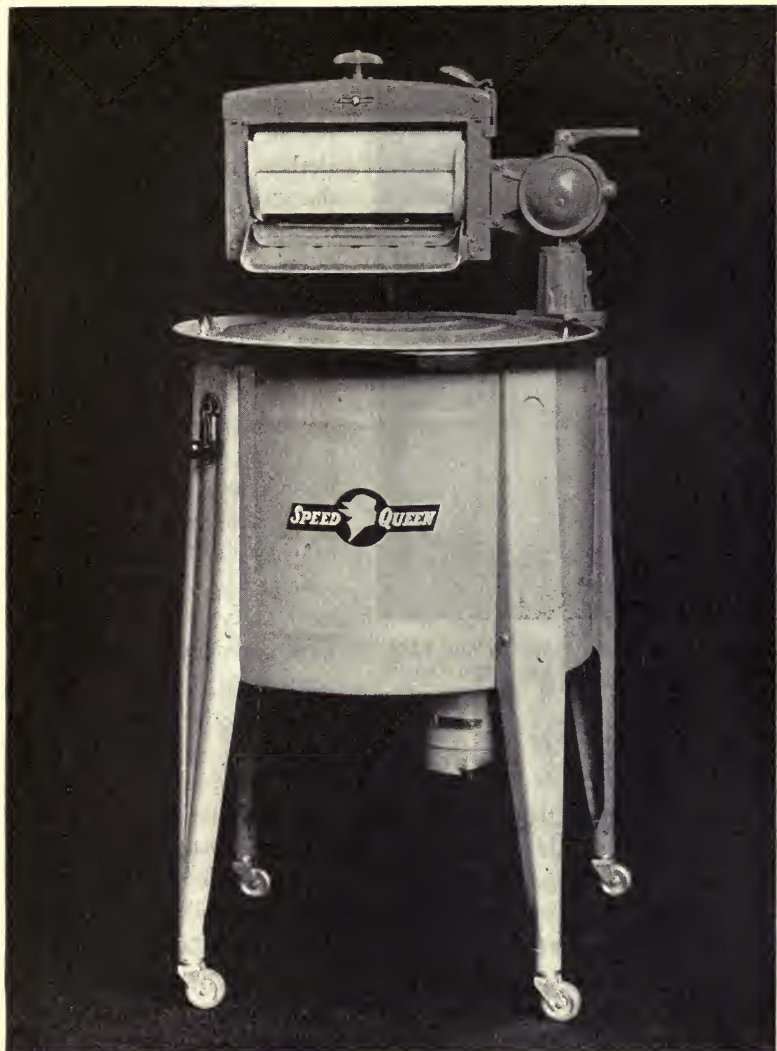

FIG. 107.—Typical washing machine

employed. The scrubbing board, however, has the disadvantage of wearing out the clothes quite rapidly by friction.

Washers for home use embody two principles of operation. The more common of these two principles is found in the agitator type,

Fig. 107, while in Fig. 108 is shown an interior view of this same washer. There are all manner of agitators—some with single wings and some with double; some set one way and some another; and in certain machines the clothes are tossed about by the action of the tub, so that the tub itself acts as the agitator. The other type of mechanism employs the principle of the vacuum cup, an action which forces suds through the clothes by an up-and-down, as well as a revolving movement of the vacuum cup, both operating at the same time. Both types of machines have proved satisfactory, although the agitator type is now the one most generally used on account of its simplicity.



FIG. 108.—Interior view, showing agitator, of washing machine illustrated in Fig. 107

Selecting a Washer

More important than the principle of construction, are two other features which should be kept in mind in the selection of the type of washer best adapted to your own particular needs. These features are the convenience in operating the machine, and the reliability or reputation of the manufacturer.

SIZE. The size of the machine is not so important since all standard types will wash about the same quantity of material, some being more efficient than others; but in making your choice remember that you are going to divide the clothes into two or three, or possibly more, batches so that certain materials and certain colors will be washed separately.

CONVENIENCE OF OPERATION. There are a number of points about washing machines, an understanding of which will be helpful in their operation. Important among these is the question of a drain

pipe fitted with a valve and properly threaded so that by means of a hose connection it can be connected to the drain. This is a very helpful feature, but even though this is not provided with the machine, every washer should be so equipped that lifting the water in pails, both before and after the washing, is unnecessary. If a connection cannot be made to the drain, then a pump or water extractor will be found very convenient for emptying the water, which in turn does away with the annoyance of using buckets for this purpose.

Special mechanically operated pumps driven by the washer motor are usually used or may be attached to the washer. For machines that are not provided with a pump, one may be attached as shown in Fig. 109. This pump is operated by a small motor, and by means of a short garden hose extension the water from the washer may be pumped into the tubs. The end casing of the pump is removable for easy cleaning. The extractor accomplishes the same purpose of emptying the washer tub by means of water pressure. It is connected to the water faucet as shown in Fig. 110 and may also be used for filling, or for emptying, the washer tub.

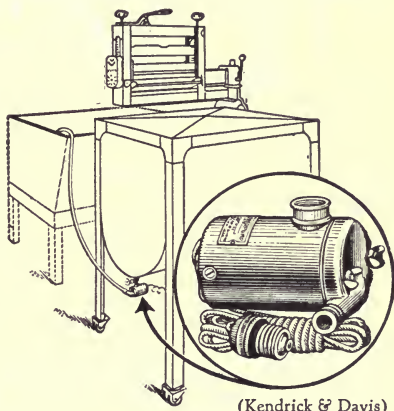

FIG. 109.—Electrically operated pump saves time and effort in emptying washing machine

The control for starting and stopping the washer, if conveniently located, will assist in the use of the machine. If it is placed in the front of the washer it will always be accessible to the operator.

Wringers are usually provided that will swing from one position to another to suit various laundry arrangements of tubs, etc., and four right-angle locking points are desirable. The safety attachment on the rolls of the wringer should be understood so that the rolls may be released in case too many clothes attempt to pass through at one time.

A round-bottom tub is easier to keep clean and will increase water action during the washing process. A tub with a protecting outside cover having a heat insulating space between will keep water hotter for a longer time.

CONSIDER THE POSSIBILITY OF PURCHASING A SMALL-SIZE WASHER. Several manufacturers are offering small washers which can be used on the kitchen sink, or in the bathroom, and which are particularly suitable for the daily washing of the baby's things, or for silk underwear or stockings which need frequent laundering to keep them in the best condition. Very often both the regular-size and small-size machines are used in the home, the larger machine for the weekly wash of the family and the smaller one for the dainty things

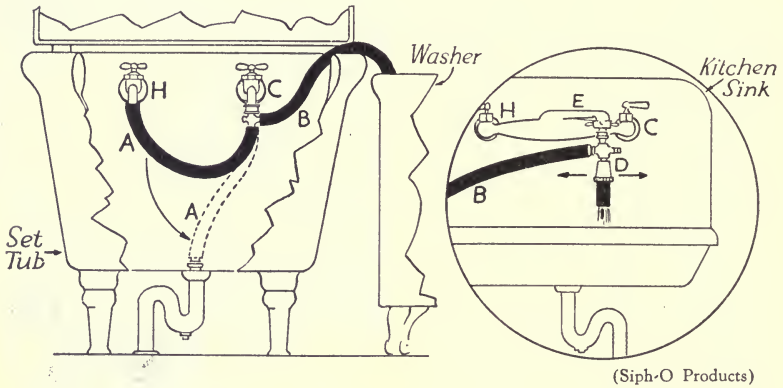

FIG. 110.—Hose connections for filling and emptying washing machine. "H" and "C" are hot and cold water faucets. Sketch at left shows hose in position to fill washer. When hose "A" is placed in position shown by dotted lines, the washing machine may be emptied. Hose "B" connects both faucets to the washer. Sketch at right shows a combination outlet "E" for both faucets. By turning valve at "D" the washer may either be filled or emptied

and the children's clothing which need laundering more often. However, a large washer will do all that a small washer can do, and just as efficiently.

MAKE SURE OF THE PROPER TYPE OF MOTOR TO OPERATE ON THE CURRENT SUPPLIED IN YOUR HOME. As was explained on page 27, there are two types of electrical energy supplied to homes throughout the country. One is direct current (D.C.) and the other, which is more common; is alternating current (A.C.). No motors, except possibly those on the small portable washer, are universal—that is, they may be used on either current. If you purchase your washer locally your dealer will know what type of motor should be supplied, but it is well in any case to raise this point and make

sure that the motor which is to operate your machine will function properly on the current in your home.

How to Get the Most Out of Your Electric Washer

The most work for the least effort—that is the story of efficient use of any electrical servant—and there are many ways to save time and effort in operating a washer. Naturally, we have not reached the stage as yet where we can press a button and have the laundering done automatically, so it will pay anyone who owns a washer, or who intends to purchase this household help, to spend a little time in finding out the best way to make use of it. A study of the following paragraphs may give you some helpful hints.

NO SOAKING OR BOILING NECESSARY. In the old days of the knuckle-scraping washboard, everything possible was done to reduce this back-breaking effort, and really we can't blame the housewives of that time for resorting to less painful substitutes. But now, when electricity will do the work, it is not necessary to take such precautions. Soaking loosened the dirt to some extent and boiling helped a little too. There is one lesson which can be learned from the old boiling process, though, and one that can be applied in the use of the electric washer. That is, that boiling or too hot water is likely to set stains or soil into the clothes. Possibly you will remember that clothes to be boiled were started in cold or lukewarm water, which was then brought to the boiling point. This was in order to allow the lukewarm water to dissolve as much of the dirt and soil as possible. Then the boiling, with bubbles coming up from the bottom of the boiler, helped further to loosen the dirt. Therefore, do not use water that is too hot in your washer.

The gentle action of the agitators is sufficient to loosen even the most stubborn soil so that the extra time necessary for soaking and boiling, and the extra handling of the clothes, can be eliminated. An efficient modern washer will remove all dirt without the necessity of boiling or soaking the clothing.

SEPARATE THE CLOTHES INTO SEVERAL BATCHES. In order to secure the best results and to make the most efficient use of the washer, clothing and other materials should be divided into batches each of which may be treated separately. This division should be based on two considerations: the type of fabric or of the fibre in the

fabric, and the color. There are, in general, two classes of fibre: vegetable, including such materials as linen and cotton; and animal, consisting of such materials as wool and silk. These two types of fibre must be treated very differently and should be washed separately, since linens and cottons may need, and can withstand, much more strenuous treatment than can be given silks and woolens. The following outline indicates the difference in the characteristics of the two fibres:

Vegetable (linens and cottons)

- Tougher than animal fibres.
- Greater resistance to heat, friction and chemicals.
- May be boiled.
- Slight rubbing will not injure.
- Soap can come in direct contact with them.

Animal (silks and woolens)

- Very sensitive to heat, friction and chemicals.
- Wool—if rubbed while wet—interlocks, shortens the fibre and results in shrinkage.
- Silk—does not shrink but is injured by alkalies and stiffened by heat.
- Must be washed in lukewarm water at about 110° F.

When washing an article made of both animal and vegetable fibre, treat like animal fibre.

Synthetic materials such as rayon, bemberg and celanese should be treated the same as animal fibre materials.

The other consideration in sorting clothes is that of color. Colored materials should be washed separately, particularly dark stockings and similar materials in which the color is likely to stain other articles.

THE WASHING PROCESS

STEP BY STEP

Operation of the Washer

Attach the cord to the convenience outlet.

Fill washer with water (110°-120° F.) to the water line. Start the agitator while putting in the water.

Dissolve soap before putting it into the water unless fine soap is used which is sure to dissolve with the action of the washer, before

the clothes are put into the water. Stop agitator as soon as good suds are developed and all soap is dissolved.

Start machine and put in the dry clothes, piece by piece, opening each as you do so. Put in only enough material to ensure free circulation. Let it run from 8 to 10 minutes according to the condition of the clothes, but for badly soiled clothing, 15 to 20 minutes may be necessary.

EXTRACTING THE WATER AFTER WASHING. Modern washers employ three general methods of extracting water from the clothes: the wringer; the dryer, using the centrifugal extractor which whirls the water out; and the most recent addition to the line, the pressure extractor which presses the water out.

The wringer type is equipped with soft-rubber balloon rolls, which press out the water and loosened dirt as the clothes are fed through them. The rolls operate in either direction simply by reversing the lever, so that the clothes may be run through in whichever direction is convenient. These rolls can be released instantly by a safety release lever in the event that, by mistake, you put too many clothes through the wringer at one time. The wringer itself pivots around and locks into different positions for convenience in rinsing the clothes and is equipped with a reversible drain board.

The dryer type has a "centrifugal extractor," as it is called, because the dryer basket revolves at such a speed that the water is removed or thrown outward from the clothes by centrifugal force. These revolving baskets are usually made of metal and have perforations in them, so that the water can escape evenly. About five minutes time is usually required to whirl the water out of the clothes.

In placing clothes in the dryer, care should be taken to balance the load properly by arranging the clothes around the edge in wads so that there will be the same weight on all sides. Where a particularly heavy piece, such as a rag rug, is being dried in this way it may be necessary to put something else into the dryer to counterbalance its weight. Where long blankets are to be dried, lay them lengthwise around the edge instead of wadding them up on one side. Proper placing of material in the dryer will avoid wrinkling.

The pressure extractor is operated by pressure exerted by a flexible rubber cover which fits down upon a basket. As pressure is increased within the rubber cover, it expands, actually pressing the water out of the clothes in the basket. Pressure is supplied either by compressed

air pumped in by the motor on the machine, or by water pressure obtained from the faucet at the sink. For this method, arrange the pieces as evenly as possible in the basket.

RINSING. Rinsing may be done in the washer so as to save rinsing by hand. In this way, hotter water can be used for the rinsing than where the process is being carried on by hand. Extract the water from all clothes after they are washed and before rinsing.

Silks, woolens and colored clothes should be rinsed in water of the same temperature as recommended for their washing—about 110° F.

Special Treatment for Special Materials

ANIMAL FIBRES (SILK AND WOOL). Woolens, real silks and artificial silks require special handling because they are made of animal fibres which are susceptible to heat. They shrink in hot water and turn yellow and burn easily under a hot iron. They are also affected by acids and alkalis, deteriorating if strong soap or washing soda is used. Rayon, bemberg, celanese and other synthetic silks, under various commercial names, are made of artificially formed fibres that require extreme care when wet. None of these materials should be rubbed, wrung, twisted, squeezed or subjected to too violent washing agitation.

Wash in lukewarm water (about 110° F.), using a neutral soap or soap flakes. Soap should be dissolved separately before adding to the wash water. If a water softener is needed, borax or a similar softener is recommended for silks and woolens because it is not strongly alkaline. The time for washing should be short. Silk garments, particularly, should not be allowed to become so soiled that a five-minute wash will not suffice. Perspiration destroys true silks, and garments soiled by it should be washed frequently. White and colored woolens should never be washed together.

WOOLENS. Measurements should be taken before washing (particularly knitted garments), so that they may be gently stretched or patted into original shape, if necessary, before drying. The modern way is not to hang them up, but to lay them flat in their proper shape and size.

BLANKETS. Washing blankets, so often the dread of the careful housekeeper, need present no problem if the right equipment and the right method are used. The regular procedure for silks and

woolens should be followed, but these special suggestions may be of value.

If small cotton and woolen blankets are washed together, never wash the woolens more than five minutes. If cotton blankets require longer washing, remove the woolen blankets. If woolen blankets are still soiled after five minutes, extract the water from them and wash in a second lukewarm suds for two or three minutes.

Do not crowd blankets. One full-size blanket makes a sufficient load. Failure in washing blankets is the result of:

Too hot water.

Too strong agitation.

Too long a washing period.

Insufficient soap.

Too strong soap.

Crowding.

If a wringer is used to extract water from the blankets, loosen the spring tension on the rolls to reduce the squeezing action, straighten the folds of the blanket and run through as straight as possible to avoid creases. If a centrifugal extractor is used, no special care is required except an even arrangement of material in the basket.

HOSIERY. Stockings should be turned inside out, and the feet of children's cotton stockings, if badly soiled, should be sprinkled or rubbed with extra soap. Unless colorfast, each dark color should be washed separately. White or light colored ones, both cotton and silk, may be washed with silk underwear, or with colored clothes, if the color is fast.

WORK CLOTHES. Very dirty or greasy garments such as overalls, boys' khaki trousers, denim rompers, etc., can be put to soak in warm water (not over 110° F.) in which a cup or two of stronger than neutral soap or soap powder has been dissolved. Let them soak over night. This soaking process—not necessary for ordinary clothes—is to allow a complete emulsification (mixing) of grease and oil. The weave of such garments is so close that if coated with grease, oil, perspiration and soil, they offer greater resistance to water and soap than fabrics not so glazed.

Wash in hot water (125° to 135° F.) from 10 to 15 minutes. Give second washing in clean suds, if necessary.

SLIP COVERS, CURTAINS, DRAPERIES, ETC. Follow directions for washing blankets with these added suggestions:

Shake dust from curtains, if very soiled. Soaking for 10 minutes will help loosen the fibres and free the dirt.

Rinse three times if the curtains are very dirty, the first rinsing being slightly soapy to free any remaining soil, and the following ones clear and of the same temperature as the wash water.

To avoid shrinkage and to keep the shape, dry on a curtain stretcher which has been adjusted to the correct dimensions of the curtains before they were washed. This is particularly advantageous in drying net or lace curtains. No ironing will be required.

Sheer curtains requiring ironing should be rolled in bath towels until ironed. Hanging such fabrics on the line is likely to stretch the edges and pull the curtains out of shape.

Most gloss curtains, with the exception of permanent-finish organdie, require light starching. Make starch according to directions on package. Be sure it is free from lumps. Starch for curtains should be thin and hot.

INFECTED CLOTHING. Clothing and linens of a person who has had a contagious disease should receive special laundering treatment. Under no circumstance should they be washed with the regular family wash!

Separate bags or containers that can be sterilized or destroyed are excellent for holding the infected clothing to be laundered. The clothes should be boiled for ten minutes in thick soapsuds. Put clothes in lukewarm water and let them come to a boil. Boiling is the method recommended by the Division of Textiles of the U. S. Department of Agriculture.

Special Treatment for Everyday Stains

FRESH COFFEE STAINS AND FRUIT STAINS. Pour boiling water through the goods stretched over a bowl. For old stains use Javelle Water (diluted solution) or Oxalic Acid treatment according to the materials. (For description, see next page.)

TEA STAINS. Pour on glycerine, then treat like coffee stains.

GRASS STAINS. Rub with kerosene, then wash as usual.

MILDEW. Soak in Javelle Bleach Solution.

IRON RUST. For white goods, wet with lemon juice, rub in salt and dry in sun. Or bleach with Javelle Bleach Solution, or treat with Oxalic Acid.

PAINT AND VARNISH. Sponge with turpentine, then wash as usual.

GREASE. Saturate with soap solution, scrub with brush, then launder. For heavy stains, rub in lard or sponge with kerosene, then launder.

JAVELLE SOLUTION AND ITS USE (FOR WHITE COTTON AND LINENS ONLY). Place 1 lb. washing soda crystals in enameled utensil. Pour over it one quart of boiling water. In another enameled utensil place $\frac{1}{2}$ lb. chloride of lime. Mix with two quarts of cold water. Combine solutions, then let stand until settled. Strain off the clear liquid through cheesecloth and bottle for use.

Javelle Solution

To use full strength, spread stain over bowl two-thirds full of warm water. Apply Javelle Solution with medicine dropper. Allow to stand a few minutes, then lower the fabric into the water, repeating until the stain disappears. Rinse thoroughly.

Javelle Water

To use as a bleach, use one cupful of Javelle Solution to from five to ten gallons of water. Soak garment in it and rinse thoroughly.

OXALIC ACID AND ITS USE (FOR SILKS). Buy concentrated solution from the druggist. Dilute with one-half its quantity of warm water. Use as directed for Javelle Water. Alternate with applications of household ammonia.

Care of the Washer

Because of the great variety of types of machines on the market, about the only recommendation which can be made for the care of a washer is that the instructions of the manufacturer, furnished with every machine, be followed in detail. If there is no booklet with the machine you buy, be sure and ask your dealer for one. Common sense will dictate the general care of washers but there are details

of oiling, cleaning, etc., which are different in the several types of washers now on the market.

In other words, the best advice as to the care of your machine will come from your dealer or the manufacturer of your washer. Be sure, therefore, that you have this information.

Electric Ironing

FLATIRONS. Of all domestic appliances now in use the flatiron leads by serving 96 per cent of the electrified homes of the country. Flatirons are now made in so many varieties and attractive styles that to select one or more for your particular home use requires a little knowledge of their design and purpose. Here especially, it is well to know what you want before you see the fascinating array. All modern irons are plated with chromium, and they are also equipped with a heel rest onto which the iron can be tipped back when not in use. A chromium-finished iron needs little care and does not tarnish.

The so-called "Standard Iron" weighs 6½ pounds and consumes not over 660 watts. But this is not enough heat for ironing very heavy wet linen, since the heat is used faster than it is produced. An automatic 6½-pound iron that overcomes this difficulty requires 1,000 watts. One kind for traveling has a removable handle and a stand for ease in packing. In recent years automatic irons of the same size as the standard irons have been developed which weigh only 3½ to 4 pounds and consume 1,000 watts. Smaller irons—3 to 4 pounds, consuming 350 to 400 watts—are used for ironing ruffles or children's clothes.

After deciding what weight iron you wish, the next point to determine is whether you want one which is automatic or non-automatic. The average iron is non-automatic, Fig. 111, and continues to heat until disconnected, there being no thermostat for automatically controlling the heat. This means that if the iron gets too hot it must be disconnected and allowed to cool. The automatic iron, Fig. 112, controls the amount of heat by a regulator which you set for the degree of heat you wish. The regulator may be marked with the words, *artificial silk*, *silk*, *wool*, *cotton*, or *linen*, which is the order of ironing different materials from a heat standpoint, artificial silk

requiring less heat than real silk, etc. Other irons are marked *high*, *medium* and *low*, or simply by lines, letters or numbers, but they all maintain the heat at the temperature at which you set the heat-controlling dial.

The advantages of the automatic types are obvious since through the use of the automatic feature (a thermostat) they are much more flexible in their use. They increase the speed of ironing, for no time is wasted in adjusting the iron by hand or worrying about scorching, which latter possibility can be eliminated by proper temperature adjustment. Moreover, if the

iron is left on by accident, it cannot get any hotter than the degree for which it is set, thereby greatly reducing the possibility of a fire.

If you decide that you wish to iron "deluxe" with one of these thermostatically controlled irons, select one that is made by a well-known and reliable manufacturer, because then you will be sure of getting an accurate mechanism. A good non-automatic iron is better than a poor automatic one which is always getting out of order and never satisfactorily holds its heat to a constant temperature. But be careful of the very cheap irons.

I do not mean to imply that the non-automatic irons are inferior to the automatic ones in construction, for they are also made in every quality. The difference in the two is a matter of convenience and service.

There are several special features built into the many irons you will find on the market, some of which may meet your fancy. Some



(Knapp-Monarch)

FIG. 111.—Non-automatic iron

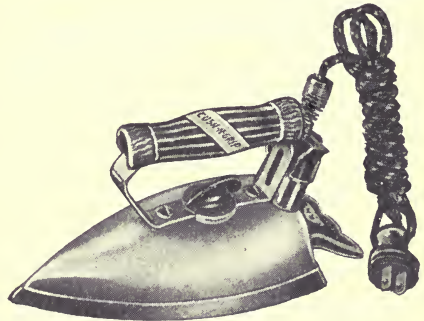

(Knapp-Monarch)

FIG. 112.—Automatic iron with thermostat

irons are provided with a thumb-rest, located on the right or the left side, for use in either hand. Others have a "button-nook," making it easier to iron around the buttons. Soft rubber or cork handles are sometimes preferred. Whichever iron you select to best suit your individual needs, be sure that it has a standard cord, so that in case it should ever need repairing any other standard cord may be substituted in the meantime. However, some irons are provided with a switch and the cord is not detachable.

Tip the iron back on the heel rest while it is warming. If the iron is automatic, do not put the regulator at a high temperature immediately, but advance the heat indicator gradually as the iron warms. When disconnecting the plug from the iron be sure to take hold of the plug and not the cord, for continual pulling on the cord will wear it out as well as tend to loosen the connections within the plug.

Electrically Equipped Ironing Stand

Where sufficient room is available, a specially constructed and equipped board, such as is shown in Fig. 113, will be found a most convenient item of equipment for the home laundry. This board, or stand, provides the regulation ironing surface of generous width and length, together with an additional "sleeve" board for difficult ironing, a sprinkling cup, iron stand and outlet plug with indicator for the electric iron—all conveniently attached. The cord for the iron is kept out of the way by a flexible arm so as not to interfere with the operator. A combination stand of this type simplifies the laundry-work and saves considerable time where much ironing is to be done.

Suggestions for Ironing

Different fabrics require different methods of sponging and pressing. Taffeta should never have water applied to it, nor be pressed with a hot iron. Rayon requires a dry cloth over it and an iron that is not too hot. If in pressing rayon or taffeta a very firm pressing is found necessary, steam the fabric by putting a dry cloth over it, and over the dry cloth another cloth that has been wrung as dry as possible, and press, using a hotter iron than when pressing direct.

There is a distinct difference between ironing and pressing. In ironing, one bears down with strength and firmness, not only smooth-

ing out all the wrinkles, but at the same time restoring the shape of the garment. In pressing, the iron is lifted gently over the fabric.

During the making of a cotton or linen garment, a moderately hot iron may be used on the fabric itself. Press on the wrong side. For the final pressing, use a thin cloth dipped into warm water and wrung as dry as possible, then press thoroughly on the right side with the cloth placed between the material and the iron.

For wool, a heavy muslin press-cloth should be used. This should be dipped into fairly hot water and wrung as dry as possible. Woolen fabrics require more pressure than others, but in no case should an ironing motion be employed.

In pressing seams in fabrics that mark easily, slip strips of paper under the seam edges, moving them along under the seams as you press. This will prevent the seam's width from showing through on the right side.

Velvets and pile fabrics should be steamed or pressed over a velvet pressboard. When a board is used, pressing must be done on the wrong side, using a dry cloth over the fabric. Moisture is seldom necessary. When

moisture is used, two cloths are required, a dry one next the fabric with a damp one

next the iron. A wire brush usually accompanies a wire pressboard to lift the nap in fabric and to aid in restoring the pile of the fabric that has been pressed under too much moisture.

In steaming fabrics with a damp cloth over a hot iron, have sufficient cloth over the iron so that the steam will filter through and not be wet when it reaches the fabric, but just damp enough to be effective. Hold material with wrong side next to the steam and brush

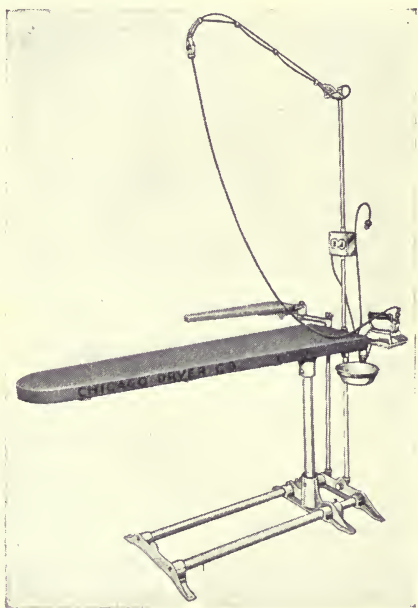

FIG. 113.—Electrically equipped ironing stand. A convenience for any laundry

nap the way it runs. Use a fine, soft, clean brush with the steaming—a wire one, or a whisk broom, on heavy fabrics.

Electric Ironers

Where much ironing is to be done, the electric ironer will be a very welcome addition to any home laundry. This development is particularly deserving of mention for it stands out from among all portable appliances as a unique example of large-scale commercial facilities now made possible for home application. Ironers of this type present to the householder a means of effecting "wholesale" economies in time and labor which no previously existing methods afforded. Not only this, but truly professional workmanship can be obtained through the use of such equipment which could not be duplicated so easily, or for such low cost, with the small hand iron which was the only appliance formerly available. Thus, for the large home, electric ironers patterned after the commercial models are a most convenient and practical innovation. These ironers are furnished in two general types, the rotary types and the flat-presser type, herewith described.

THE ROTARY TYPE. The rotary type consists of an electrically heated curved ironing shoe against which is pressed a revolving drum having the goods to be ironed placed on its surface, as shown in Fig. 114. The action is the same as with the hand iron, but the iron is stationary and the material is moved under the heated iron on the drum without effort on the part of the operator. The drum may also be pressed against the shoe without revolving where a pressing action is desired for pressing trousers, etc. In this type of ironer electricity is used for two purposes—to provide heat for the ironing shoe and to revolve the drum by means of a small motor. Ironing by this device is very simple since the revolving drum is brought up against the heated shoe by snapping a switch, or by simply pushing a small lever under the machine with your knee, leaving both hands free for ironing.

Simplicity of construction and plenty of free space around the drum make for greater convenience.

THE FLAT-PLATE PRESSER TYPE. Another form of ironer, shown in Fig. 115, has a heated shoe but irons on a different principle. As its name implies, the heated iron is pressed against the ironing board

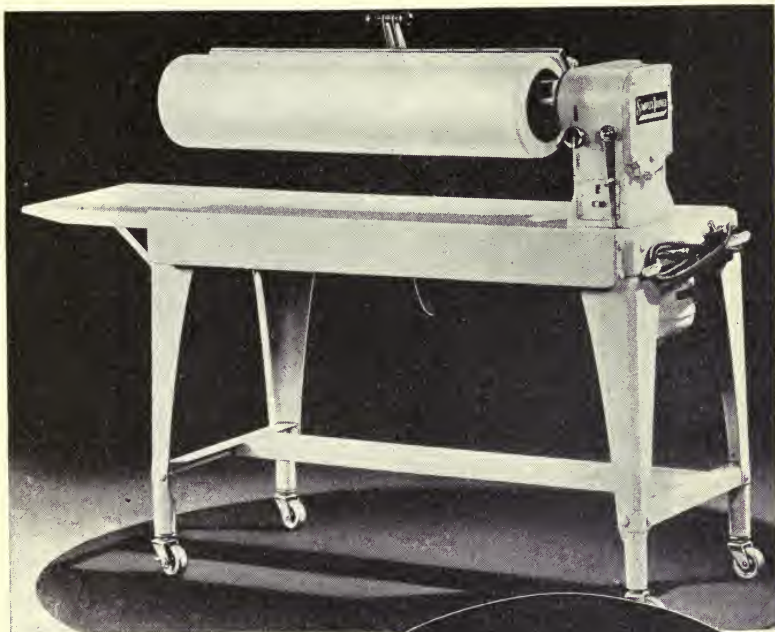
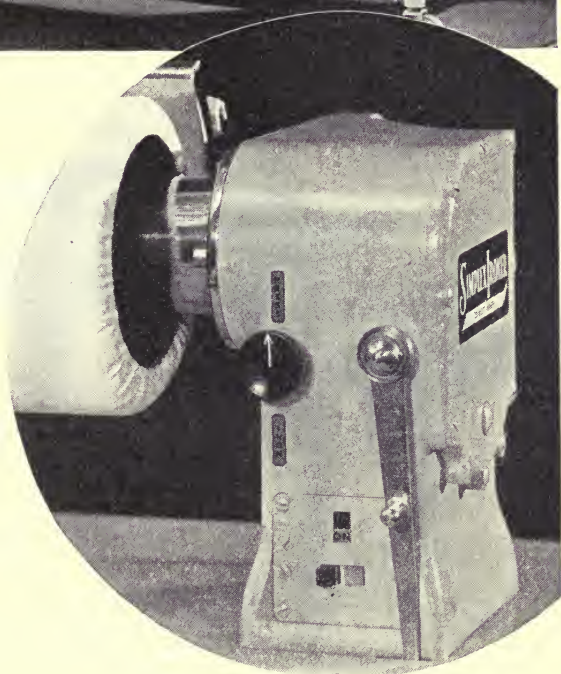
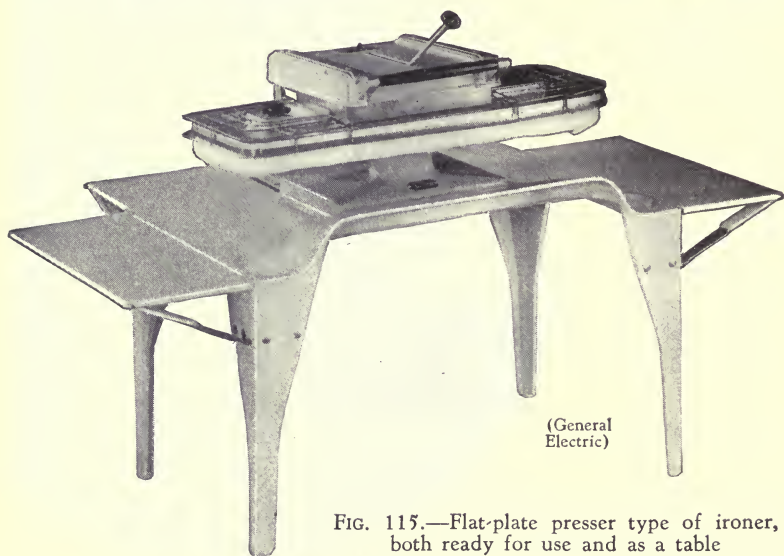

FIG. 114.
(Above)
Rotary
ironing
machine

(Right)
Details
of control





(General
Electric)

FIG. 115.—Flat-plate presser type of ironer,
both ready for use and as a table

with the goods to be ironed placed in between. In its operation the heated shoe is pushed back out of the way by hand, leaving the ironing board free for properly placing and removing the goods to be ironed. The heated shoe is then rolled forward and, by means of the controlling lever, pressed downward against the ironing board, remaining there a few seconds when the ironing is completed and the shoe rolled back by hand out of the way. It is well adapted to pressing men's and boys' suits. Shirts and other wearing apparel are easy to iron after a little practice. Large pieces are thus ironed by a step-by-step method with little effort required on the part of the operator. The operator has complete control of the speed at which the ironing is done. For ironing any material, the proper temperature of the shoe is maintained by means of two thermostats which also prevent overheating in case the operator forgets to turn off the electricity when not using the ironer. The ironing board or "buck," as it is called, is perforated so that all the steam goes in a downward direction and not in the face of the operator. A special cover is provided which converts the ironer into a useful table when not in use. This feature saves space when ironing is to be done in the kitchen. A flat-plate presser will iron 300 square inches (2+ square feet) at one pressing and is thus a big time-saver.

Clothes Dryers

What will the weather be on Monday? Just right, on Monday or any other day for drying clothes, if you have a modern dryer in your laundry.

Some of the advantages are as follows:

Clothes do not collect any dirt.

Cannot be torn by wind or clothes-pins.

No fading, and no discoloring.

Less effort and less time required.

For drying clothes in the laundry, several types of dryers are in use. They consist of a cabinet into which the clothes are placed on suitable racks. At the bottom of the cabinet is placed an electric heater, the heat in rising drying the clothes. Some dryers employ a

small fan to circulate the warm air from the heating coils through the clothes. Such a dryer has many advantages and may be used at any time regardless of weather conditions.

For use in the bathroom or kitchen, a small portable dryer may be used which will quickly dry small lots of clothing or dish towels, and at the same time keep them out of sight. The heating unit of the dryer will also help to heat the bathroom and provide a warm towel for use after a bath.

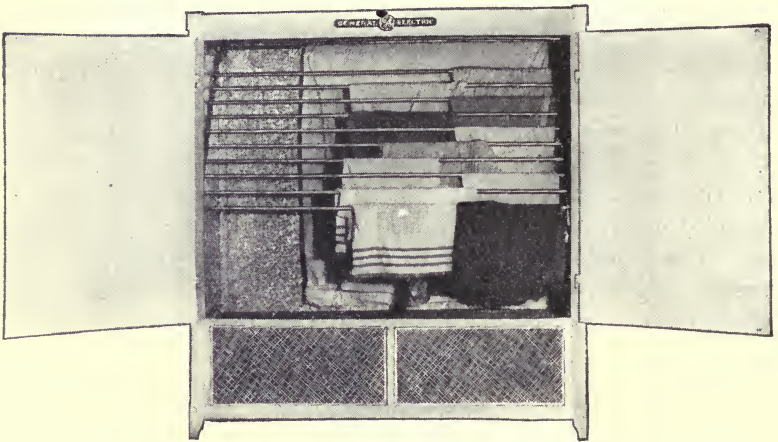

Electrically heated clothes dryer



PREPARATION FOR TUESDAY'S JOURNEY

Having been so pleasantly surprised by the efficiency and dispatch with which the dreaded washday of the past has been converted into a semi-recreation day of the present by Monday's electric servants, we can now look forward to Tuesday's journey with eager anticipation. What transformation shall we find here? For Monday already has absorbed "Ironing Day," thus affording the modern household, at the very start of the week, a full twenty-four hours of respite from labor.

As we approach Tuesday's Room, the province of the Day Family's eldest daughter, we find her reading a book—"Improving my mind," as she explains.

"But if all the ironing was done yesterday, is not this 'Cleaning Day?'" we ask, somewhat concerned.

"Oh, but that was taken care of hours ago!" is her smiling answer.

Observing our amazement, she pleasantly offers to show us how it has been accomplished so expeditiously. And so we follow Tuesday's Lady on our third journey of the week into the Wonderland of Electric Cleaning. And, incidentally, we learn something to our advantage about *Temperature* and *Humidity*: how these two mischievous little sprites which affect our health and comfort are made to obey the commands of another most interesting and useful Electric Servant—the Humidifier.

TUESDAY'S PROGRAM

CLEANING THE HOUSE ELECTRICALLY.

HEATING THE HOME ELECTRICALLY.

AIR-CONDITIONING AND KEEPING COOL ELECTRICALLY.

What percentage of dirt does the modern electric suction cleaner take from carpets and rugs as compared with the carpet sweeper and the broom?

In addition to eliminating arduous labor, how does the electric suction cleaner actually prolong the newness and usefulness of carpets and rugs as well as aid in the protection of health?

What four general instructions should you particularly heed in the use of electric suction cleaners?

What is the new and efficient method of taking care of floors that does away with the old fatiguing tasks of hand-scrubbing and polishing?

What points is it well to remember about the maintenance of floors and the materials and equipment that you employ with modern methods?

Under what conditions will electric heat give the most satisfactory service?

What various types of electric heaters are available and in what locations might you employ one or more of them to advantage?

What types of automatic burners used in connection with the home heating plant are solving the problem of furnace-tending and providing comfort and convenience with safety and economy in hundreds of thousands of American homes?

What modern method of "airing the house" provides four additional services that are essential to health and comfort?

What tends to make us feel cool? Warm?

TUESDAY'S JOURNEY

CLEANING THE HOME ELECTRICALLY

Once I owned a home in the country, far removed from traffic and situated on a knoll near the ocean. In this location I thought my problem of housecleaning would be greatly simplified since the sources of dust and dirt which are familiar to the dweller in cities and villages were here so noticeably absent. But after a few months in this home I was convinced that there is no getting away from dirt and that "a woman's work is never done," particularly where it concerns this continual battle of keeping carpets, rugs and upholstery clean, and hardwood floors, linoleum and other waxed or specially treated surfaces in the best condition.

Thanks again to electricity, however, and the invaluable aid of the electric suction cleaner and floor polisher which now form a most important part of the staff of electric household servants maintained in my present home, the cleaning problem has been most satisfactorily solved. Of all the many forms of equipment available for electric service in the home the suction cleaner and floor polisher are most certainly two appliances which I would class as indispensable. I doubt if many of my readers would argue this point, for cleaning rugs and floors are two operations which cannot well be avoided and really come before any other considerations, unless it be heating. We may live in the smallest of homes or apartments, even one room, take our meals out and send our soiled clothing to the laundry, but we cannot escape the necessity of keeping that home, small apartment or one room clean, either by our own efforts or through some other provision for that service.

Let us return for a moment to our analogy of the highway. As we speed along through some well-maintained residential district do we not note with interest and pleasure the soft, velvety lawns and well-trimmed hedges, and the attractive disposition of foliage and flowers, all kept freshly clean and neat by the home gardener—be he man, boy or servant—so as to delight the eye of both the owner and the passer-by? This external effect of well-kept grounds finds a parallel within the home where the bright, clean lawn becomes your polished floor and the foliage and flowers relate to your rugs and upholstery. How much more important it is, surely, that the interior effect of the home, subject not only to your own demands for cleanli-

ness but to the critical inspection of your guests, should be as immaculate and smart in appearance as available cleaning facilities can make it. Just as the lawns bordering upon actual highways should be provided with hose attachments, sprinkler systems and the like, so the electric highway of the home should afford the proper convenience outlets, cord extensions and other customary means of electrically servicing the cleaner and polisher which keep your interior furnishings free from dirt and dust.

The Electric Suction Cleaner

The evolution of home cleaning equipment from the broom to the electric suction cleaner is just as interesting and involves much the same aspects of efficiency, safety, health, cleanliness and economy as the evolution of home heating methods from the fireplace to the modern, labor-saving, automatic heating systems. Present day systems of home heating must take into account the size and type of home to be heated, its location and exposure, and a number of other considerations of a technical nature of which few of us have any knowledge. Similarly, many of my readers may be surprised to learn that the materials and weave of our carpets, rugs and upholstery fabrics, as well as the nature of the dirt and the manner in which it becomes imbedded in the tufts of pile fibres, also introduce technical considerations with respect to thorough and efficient cleaning that are no less important in point of the type of suction cleaner employed than are presented in the selection of the proper heating plant.

Without going into the technicalities of the subject, there are certain general considerations which should be borne in mind and which may be found helpful in selecting a type, or types, of cleaning equipment to serve your particular requirements.

RUG CONSTRUCTION, KINDS OF DIRT, AND WHERE IT LODGES. In recent years manufacturers of suction cleaners have made a study of the construction of rugs and the various forms of dirt encountered in many thousands of homes, and their findings have resulted in progressive developments which have solved the problem of cleaning in a very scientific manner.

If a rug is held in the hand and bent at an acute angle, parallel with either the weft threads or the warp threads, you will see that the little tufts of pile are arranged in rows with furrows between

them. These furrows act as storage spaces for dirt. Moreover, the closely woven base of the rug is so compact that very little air can be drawn through as a means of cleaning the furrows. It will therefore be seen that dirt infiltrates through a rug and gradually becomes lodged in pockets and furrows between the rows of piles and finally in the closely woven base of the rug itself where it is most difficult to dislodge.

This brings up the consideration not only of the various forms of dirt which a suction cleaner must remove, but its location in the rug and the harm it does if allowed to remain there. There are, in general, three kinds of dirt which accumulate in every home. First, there is the surface dirt and litter, including lint, dust, hairs, thread, pins, scraps of paper, etc., which is quite evident because it can be seen on top of the rug. Second, there is the heavier, gritty content, with hard cutting edges so injurious to the soft piles of the rug, such as sand and other foreign particles tracked into the house, and these work their way down into the furrows. And third, there are the very fine particles of grease and germ-laden dust which pack down into the pockets and clog up the fibres at the base of the rug. It is this latter type of dirt which is the most difficult to remove and the most dangerous from the standpoint of health.

This classification of dirt and its location is useful in explaining why one should go about the selection of a cleaner with an understanding of the requirements in mind. The broom or the carpet-sweeper will remove a portion of the surface litter, but they are apt to imbed more dirt in a carpet or rug than they remove. In addition to this, the broom contaminates the air with dust. Any type of suction cleaner can be depended upon to remove most of the surface litter and some of the dirt within the pile, but the infiltrated dirt is much more difficult to remove and only the better types of cleaners take out any appreciable percentage of it. There are only two ways of ridding carpets and rugs of the dirt which lodges in the pockets and furrows deep down in the base. One is the old-fashioned beating process which, in addition to being a terrific task, is likely to be injurious to the carpets and rugs themselves by weakening the fibres. The other method is the use of an electric suction cleaner of the most improved and efficient type. In this regard you should know that tests made with various makes and types of electric suction cleaners on dirty carpets and rugs, typical

A light cleaning each day will prevent dirt accumulation and save wear on your carpets and rugs from gritty particles lodging in the depths of the pile, and thus the more thorough weekly cleaning will be made that much easier. Pins or other sharp particles should be picked up from the surface before going over carpets and rugs with the cleaner since such objects might injure the cloth bag of the cleaner.

SPEED OF OPERATING FOR GREATEST EFFECTIVENESS. A simple suction cleaner will clean more effectively if it is moved rather rapidly across the floor. The reason for this is that the nozzle lip causes a certain amount of agitation of the pile and the faster the nozzle is moved the greater will be the agitation and consequent removal of dirt. At first thought, this might seem quite the opposite of what you would expect, but it must be remembered that if the suction of the cleaner is sufficiently strong any reasonable speed will readily remove the surface litter and dust, but no matter how slowly the cleaner is progressed over the carpet or rug, this suction alone is not sufficient to pull the dirt through the "closed" rows of pile. Only some form of agitation of the pile will open up the rows and allow the suction to do its work.

In the case of the motor-driven brush, or agitator-type cleaner, the motor does most of the cleaning by operating the brush or agitator which is driven at a fairly consistent speed regardless of the rate at which the cleaner itself is pushed across the floor. Consequently, it is desirable to move this type of cleaner at whatever speed results in the least expenditure of energy by the operator which, naturally, is a fairly slow rate.

WHEN TO MAKE ADJUSTMENTS. If the rubber belt becomes stretched through long usage so that it interferes with efficient operation, a new belt should be installed in its place. There is no positive way to tighten an old belt, for when the life of the rubber is gone it will continue to stretch. If the thickness, or height, of the pile in your carpets and rugs varies considerably, or in the case of "padded" carpets, you will probably find it necessary to make slight adjustments for these varying conditions so as to make proper contact of the nozzle on the surface for best results.

EMPTY THE BAG REGULARLY. The efficiency of any cleaner is reduced if the dust bag is allowed to become too heavily loaded. As soon as there is any appreciable amount of dirt collected in the

bag, the bag should be disconnected and the dirt removed. Where paper containers are used this can be done most conveniently, but in any case the bag itself should be vigorously shaken inasmuch as fine dirt will adhere to the texture of the cloth and diminish its filtering qualities. This dirt will not fall out of the bag naturally. When cleaning the bag make sure that hair, lint and all obstructing particles of dirt are removed from the mouth of the bag so that the opening will be clear for the free passage of air. Also remove hair and threads from the revolving brush from time to time. With the agitator type of cleaner, hair, lint, thread, etc., will not foul it.



FIG. 117.—The suction hand-cleaner. A convenient lightweight device for "above-floor" service

FOLLOW CAREFULLY THE INSTRUCTIONS OF THE MANUFACTURER. Every cleaner has its own characteristics and only the manufacturer of that machine can furnish you with proper instructions for its necessary care. This information usually gives detailed descriptions of parts, how to use the attachments and accessories, where and how to make adjustments, when to clean and oil the mechanism, and the like.

As I have previously pointed out with reference to the selection of any electrical appliance, the reliability of the manufacturer and the dealer, the readiness with which renewal parts may be obtained and the convenience of service facilities are all most important considerations which apply particularly to motor-operated devices such as suction cleaners, subjected as they are to hard service in daily use.

THE USE OF DUSTING TOOLS AND HAND-TYPE CLEANERS. All electric suction cleaners are furnished with a set of dusting tools and accessory attachments. These tools, when attached to the rigid extension member, are most convenient to use in cleaning operations which involve reaching into out-of-the-way places, cleaning radiators, dusting books on shelves, cleaning upholstered furniture, etc. The hose and brush will take care of draperies, furniture, hangings, curtains and most of the ordinary dusting tasks. Extension tubes, combined with the hose and the brush, will take care of moldings and high places and under low furniture. A flat nozzle is used in removing dust from tufts of upholstery and also for blowing dust from radiators and for aerating pillows.

The hand-cleaner, Fig. 117, is becoming very popular because of its many uses and convenient size. These cleaners are light in weight and are ideal for small cleaning jobs such as brushing clothes and upholstered furniture. It is a most convenient device for cleaning automobiles since it is easy to carry about and operate in cramped quarters, under seats, etc. The hand-type cleaner has the advantage in certain classes of work of always being ready to use without the trouble of attaching dusting tools. Further uses for the hand-cleaner are:—

Dusting curtains and draperies.

Cleaning stair carpets.

Cleaning mattresses and pillows.

Cleaning moldings, corners, etc., inaccessible with larger cleaners.

Cleaning closets, fireplaces and other nooks.

Cleaning framed pictures, bric-a-brac, etc.

Home Central Vacuum Cleaning System

The advantages of the Home Central Vacuum Cleaning System, with a fixed location for the vacuum producer, have long been recognized in office buildings, schools and hotels. The application to homes is now practical and economical, not only because of the greater speed and greater degree of cleanliness, but because the cost has been reduced to an amount which is negligible when spread

over the long term of years during which such a system will give satisfactory and reliable service.

From the vacuum producer in the basement a powerful suction is piped to conveniently located inlet valves throughout the house, as shown in Fig. 118.

The operator merely slips the hose connection into the wall connection. The actual cleaning is done with light-weight interchangeable cleaning tools with an aluminum handle attached to the free end of the flexible hose.

This system cleans everything from linoleum or cement floors to the finest rugs and upholstery. Walls, radiators, painted woodwork, hangings and even clothing and mattresses are swiftly and easily cleaned by a few easy strokes.

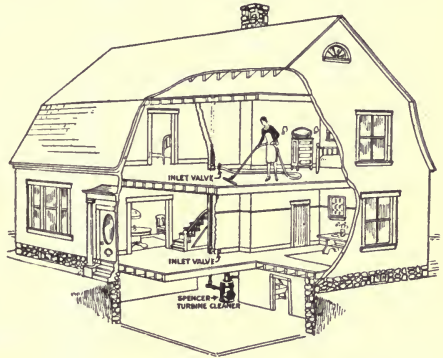

FIG. 118.—A complete "built-in" Spencer central vacuum cleaning system permanently installed in the home

The thoroughness of the central system in ordinary day-to-day cleaning has completely vanquished "spring cleaning"—that periodic household revolution of furniture moving, carpet cleaning and wholesale renovating to reach dust that surface cleaning methods could not reach.

Electric Steamers

Steam which is used for imparting new life to velvets, velours and other pile fabrics on unholstered furniture, crushed or worn by long usage, may be obtained from the portable electric vaporizer which in turn is operated by connecting to a convenience outlet. This vaporizer is also used for exterminating insects and is illustrated in Fig. 193, page 305. When serving as a steamer, water only is used for its operation. In addition to its application in restoring the life of the pile on upholstery materials—such as used on furniture and for auto seats, lap-ropes, cushions, pillows and the like—this appliance can be put to a number of useful purposes. Live steam is recognized as the most effective means of freshening

and renewing the surface texture of many fabrics as well as producing a sheen or luster on felt, restoring the curl or wave in human hair, etc. For this reason the electric vaporizer is deserving of at least a "Top-Sergeant's" rank on the "Cleaning Squad" of household servants, and qualifies as a most suitable companion for his senior brothers in arms—the suction cleaner and the floor polisher. It is, in effect, a small boiler containing two electrodes for conducting current which turns the water into steam. In a few minutes after the current is turned on, steam will come from the nozzle and it is then ready for operation. That is why I liken it to a drill sergeant, for you should see how instantly the little "pile soldiers" and weary fibres awake from their "naps" on the fabric and come to erect attention at his stern and steamy commands!

Cleaning Carpets and Rugs

For "freshening" your carpets and rugs, an occasional sponging with warm soapy water, to which a little ammonia has been added, will be found very efficacious.

Polishing Floors Electrically

Clean-looking, well-kept floors are the pride of any home, but often mean a lot of hard work for someone. Properly kept floors will last as long as the home itself, but if neglected will deteriorate rapidly. However, any floor may be kept in perfect condition by means of an electric floor polisher, shown in Fig. 119. This machine will wax, polish, scrub, remove the finish or sandpaper any floor, all with very little effort and time on the part of the operator. The machine consists of two brushes that rest on the floor and revolve in opposite directions. These brushes are revolved by a small motor built into the body of the machine. Various brushes are used for the different duties the machine will perform and are easily changed without the use of tools. The construction of the machine is simple and rugged.

Space does not permit complete instructions for caring for the different types of floor finishes used in the home, but the instructions furnished with the electric floor polisher give simple directions for the care and finishing of any kind of flooring, the particular type

of polishing brushes to use, waxes and other finishes, and methods of procedure. A badly worn spot in a hardwood floor may be refinished in a few minutes' time, or the entire finish of any floor may be restored. Floors that are kept in proper shape regularly by an electric floor machine always look like new.

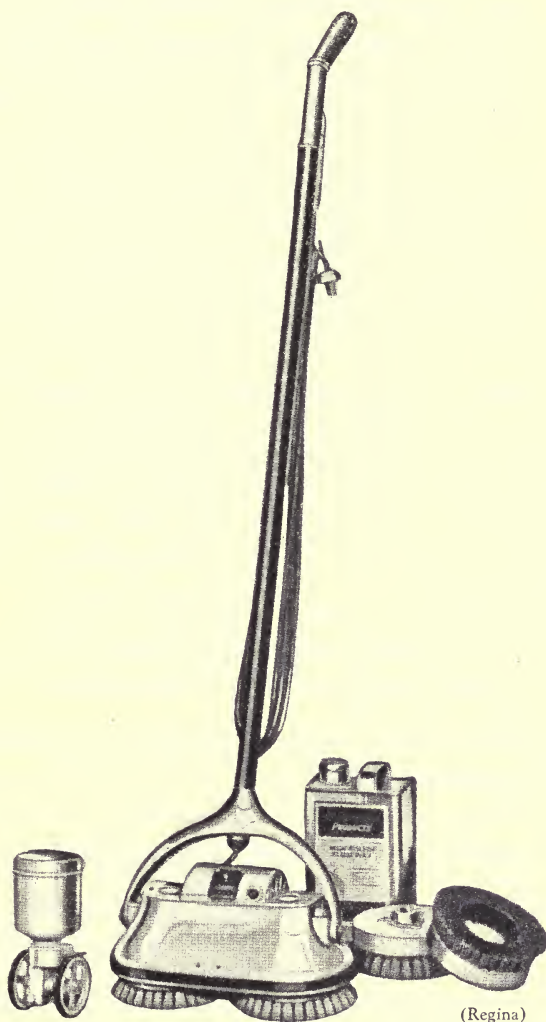
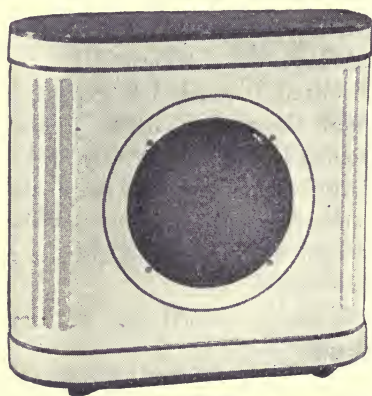

FIG. 119.—An electric floor polisher with attachments for conditioning and maintaining floors and flooring

AIR HEATERS. To heat rooms economically by electricity, air must be heated rapidly and distributed evenly throughout the room. Heaters of this character are called air or space heaters and are of two general types:—natural draft and forced draft.

In forced draft heaters the air is blown by an electric fan over electrically heated wires, bars, or coils, which heat the air by contact, the heated air then being distributed throughout the room by the draft of the fan. An illustration of a forced draft electric heater is shown in Fig. 120. It consists of a small coil of wire which is heated by the electric current, and a fan for circulating the air through the heated coil.



(General Electric)

FIG. 120.—Forced draft electric heater utilizing fan for air circulation

In natural draft heaters the air rises by natural draft over electrically heated bars, coils or wires in a grilled enclosure, being heated by contact with the heating element and thence ascending by natural draft and distributing itself throughout the room. The cool air enters the enclosure at the bottom, thus forming a continuous natural circulation of air through the heater into the room.

One form of such a natural draft electric heater is shown in Fig. 121. It has a series of spaced vertical copper plates bonded to the electrically heated bar or bars in the ornamental enclosure, so as to act as electrically heated chimneys or ducts. The cool air passing through the enclosure is divided by the spaced copper plates into a series of thin vertical columns or currents, which, being heated throughout by the hot copper plates on both sides, rise quickly by natural draft.

By means of these copper ducts, which increase the radiating surface, the air is heated about 40 degrees higher, and its circulation is correspondingly faster. Thus, the whole volume of heated air is more rapidly and evenly distributed throughout the room.

These heaters are available both with and without attached automatic thermostats, and in the standard sizes, 660 to 1320 watts.

One such heater can be connected into the ordinary convenience outlets of a home without special wiring. In large rooms where two or more heaters are used on one circuit, special wiring is necessary. In a properly insulated home where the outside temperatures rarely go below 20° F., these heaters will heat about one cubic foot of room space for each watt consumed.

It is this type of heater that is recommended for basic heating in localities where the rate for current is low, or where the need for electricity is only occasional, as in moderate climates. It is

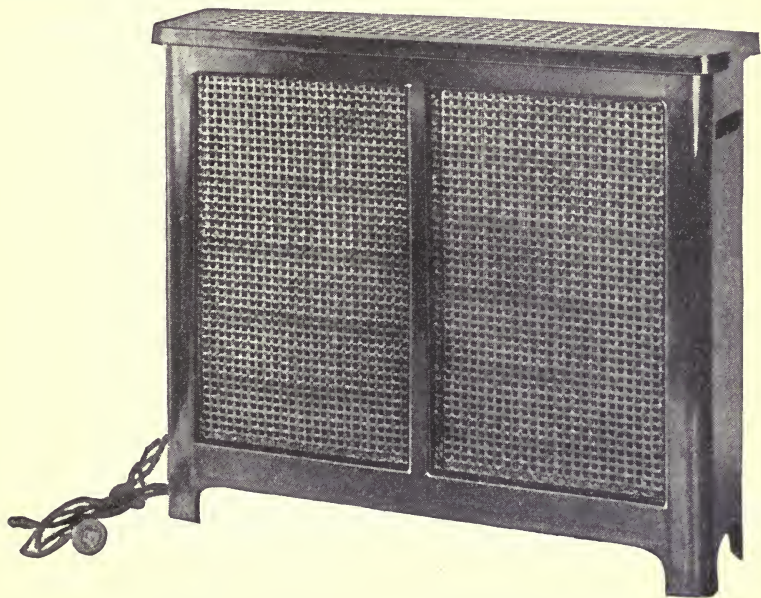

FIG. 121.—“Duct” natural draft electric air heater

particularly useful for week-end homes, camps, bungalows and garages.

RADIANT HEATERS. Here again we have a convenient source of heat which may be obtained in a few seconds and is available at any convenience outlet in limited quantities, not over 1,300 watts. They are called “radiant heaters” since the heat is reflected, or radiated, away from the heating element.

These heaters are for warming a person or object, where a small amount of heat is wanted for a short time. They are not

There are a few points about maintaining floors that are well to remember:—

A floor that has been waxed should not be varnished, because the varnish cannot dry on top of the wax. If the floor is to be varnished, all wax must be removed.

When waxed floors are slippery and “show tracks,” it is usually due to the following causes:—(a) wax applied too thickly; (b) not thoroughly polished; (c) not allowed to dry thoroughly before polishing. This is not likely to happen if the wax is applied automatically and polished by an electric floor polisher.

Do not use cheap wax, since it will not give satisfaction.

Water should not be allowed to remain on the floor, but should be wiped up immediately, otherwise it will spot any kind of finish.

Paint, varnish, wax and other finishing materials and many cleaning preparations are somewhat inflammable and readily catch fire, but if ordinary caution is exercised while using them, no harm will result.

Wax should never be heated over an open flame. The proper method is to set the container in hot or boiling water.

Cleaning rags, waxing cloths or other materials used in finishing floors should never be left in a can or closet or tucked away in a corner, but burned after they have been used. Many fires have been caused by spontaneous combustion as a result of carelessness with old cleaning rags.

Linoleum requires the same attention as wood floors.

Use the various brushes as directed by makers of the machine.

Provide a space for storing your polishing machine and polishing equipment when not in use.

Keep the floor machine clean and lubricate it in accordance with the maker's suggestions.

HEATING THE HOME ELECTRICALLY

Electric heating is ideal for the home where the cost of current is low, or the need of heat is occasional; or to supplement steam and hot water heat, as in moderate climates; or during the midseason months; or in week-end homes, camps, bungalows and garages. No cellar or fuel storage space, furnace, boiler, piping or chimney is needed.

A simple turn of a switch, and the heat is available in a few minutes. A thermostat on each heater will maintain the temperature of each room automatically at any desired degree, independently of any other room. Since there is no combustion, there is no consumption of the vital oxygen of the air.

Electric heaters can be installed in wall recesses out of sight with a slight loss, however, of some effectiveness due to slower circulation; or they can be obtained in portable form in ornamental enclosures, so that they may easily be carried from room to room, or put away during the warm season.

Electric heating is extremely efficient because all the heat goes into the room and there is no loss through the chimney.

A home that is properly heat-insulated is much less expensive to heat with any kind of fuel. Where the cost of current is low, such a home can be heated most economically throughout. By "heat-insulated," is meant the use of heat-insulating material between the outer and inner walls and between the floors and the roof of the house. Existing homes may be heat-insulated by forcing insulating material between the inside and outside walls.

There are several types of electric heaters which may be used for general and special heating as desired:—

AIR HEATERS.

RADIANT HEATERS.

ELECTRIC GRATES.

AUTO-ENGINE HEATERS (FOR THE CAR).

Electric heaters function by means of either of the following principles:—circulation of air through electrically heated conductors, and heating air by radiation from heat-reflecting surfaces.

If a heater is to be used in a bathroom, or other small space, as supplementary to the regular heating system of the house, it should be constructed on the air-circulating principle. Such heaters, to be effective, should be of fairly high wattage—1,000 or over.

The other type of heater is commonly known as the radiant or hot-spot heater, and directs or reflects the heat from the electrically heated coil by radiation all in the same direction, similar to light from a spot light.

AIR HEATERS. To heat rooms economically by electricity, air must be heated rapidly and distributed evenly throughout the room. Heaters of this character are called air or space heaters and are of two general types:—natural draft and forced draft.

In forced draft heaters the air is blown by an electric fan over electrically heated wires, bars, or coils, which heat the air by contact, the heated air then being distributed throughout the room by the draft of the fan. An illustration of a forced draft electric heater is shown in Fig. 120. It consists

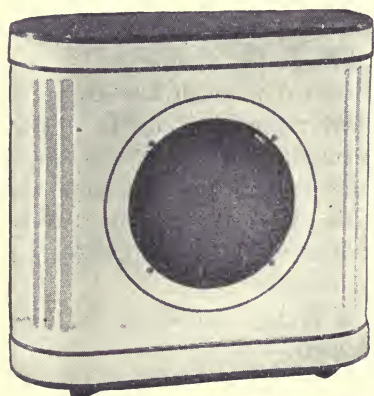

(General Electric)

FIG. 120.—Forced draft electric heater utilizing fan for air circulation

of a small coil of wire which is heated by the electric current, and a fan for circulating the air through the heated coil.

In natural draft heaters the air rises by natural draft over electrically heated bars, coils or wires in a grilled enclosure, being heated by contact with the heating element and thence ascending by natural draft and distributing itself throughout the room. The cool air enters the enclosure at the bottom, thus forming a continuous natural circulation of air through the heater into the room.

One form of such a natural draft electric heater is shown in Fig. 121. It has a series of spaced vertical copper plates bonded to the electrically heated bar or bars in the ornamental enclosure, so as to act as electrically heated chimneys or ducts. The cool air passing through the enclosure is divided by the spaced copper plates into a series of thin vertical columns or currents, which, being heated throughout by the hot copper plates on both sides, rise quickly by natural draft.

By means of these copper ducts, which increase the radiating surface, the air is heated about 40 degrees higher, and its circulation is correspondingly faster. Thus, the whole volume of heated air is more rapidly and evenly distributed throughout the room.

These heaters are available both with and without attached automatic thermostats, and in the standard sizes, 660 to 1320 watts.

One such heater can be connected into the ordinary convenience outlets of a home without special wiring. In large rooms where two or more heaters are used on one circuit, special wiring is necessary. In a properly insulated home where the outside temperatures rarely go below 20° F., these heaters will heat about one cubic foot of room space for each watt consumed.

It is this type of heater that is recommended for basic heating in localities where the rate for current is low, or where the need for electricity is only occasional, as in moderate climates. It is

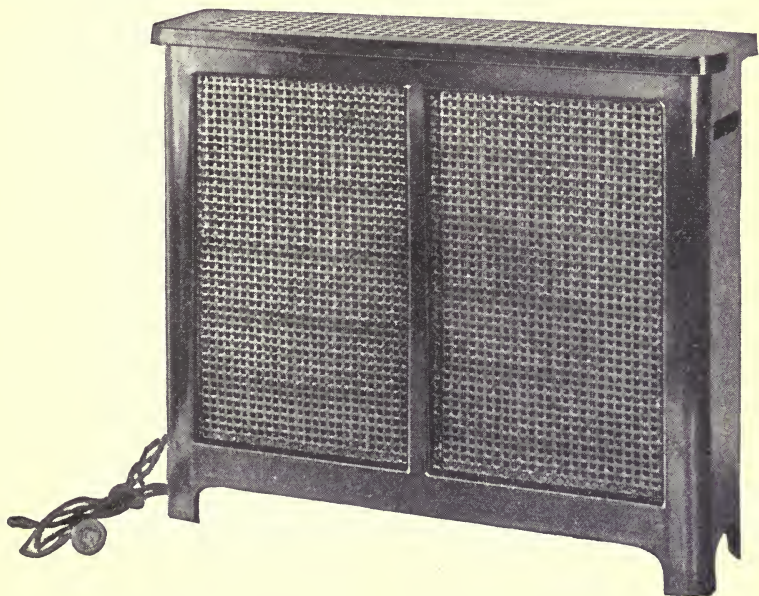

FIG. 121.—“Duct” natural draft electric air heater

particularly useful for week-end homes, camps, bungalows and garages.

RADIANT HEATERS. Here again we have a convenient source of heat which may be obtained in a few seconds and is available at any convenience outlet in limited quantities, not over 1,300 watts. They are called “radiant heaters” since the heat is reflected, or radiated, away from the heating element.

These heaters are for warming a person or object, where a small amount of heat is wanted for a short time. They are not

intended for continuous heating of even very small rooms, or for taking the place of the ordinary method of heating any part of the house.

These heaters are made in a variety of designs and sizes, either rectangular or bowl-shaped. Fig. 122. The heating element is mounted in front of a non-tarnishable metallic reflector covered with a guard so that one will not come into contact with the heating element. These heaters are light in weight so that they may be easily carried about and connected to a convenience outlet wherever needed.

The radiant heater has so many uses that it is virtually a necessity in a large number of homes. When the regular heat goes off in the home or apartment, or when a cold spell comes in the early morning before your room is warm, and for similar situations, the bowl-type heater has a most desirable feature in that it can be tipped at any angle desired so as to reflect the heat to your body. In like manner it is invaluable for warming the young baby in the winter months when a proper room temperature is required during the bath. After a shampoo at home, or when your hair has not thoroughly dried at the hair-dresser's, or after you come in from swimming or from the shower, this heater may be used as a hair dryer.

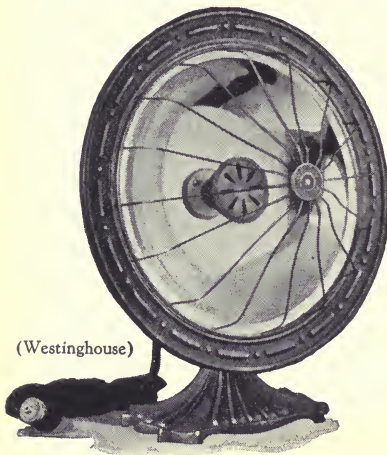

FIG. 122.—Bowl-type radiant heater

THE ELECTRIC GRATE. There is nothing more cheerful than an open fire in the fireplace and yet there is all the bother of ashes, kindling and constant attention to the fuel supply. Electric grates are becoming more and more popular as substitutes, and they do away with the unpleasant features. The electric grate is about the only source of heat with the appearance of fire that can be used in an artificial fireplace. When used in a regular fireplace with a chimney, the flue in the chimney should be closed. Electric grates

are of two varieties:—one is for purely decorative purposes and the other combines this feature with an electric heating element, providing enough heat to assist the regular heating system on particularly cold days, or to supplement it before the furnace fire has been started. Fig. 123.

There are several designs for the decorative grate and many of them, when properly installed with a few burned logs, have to be

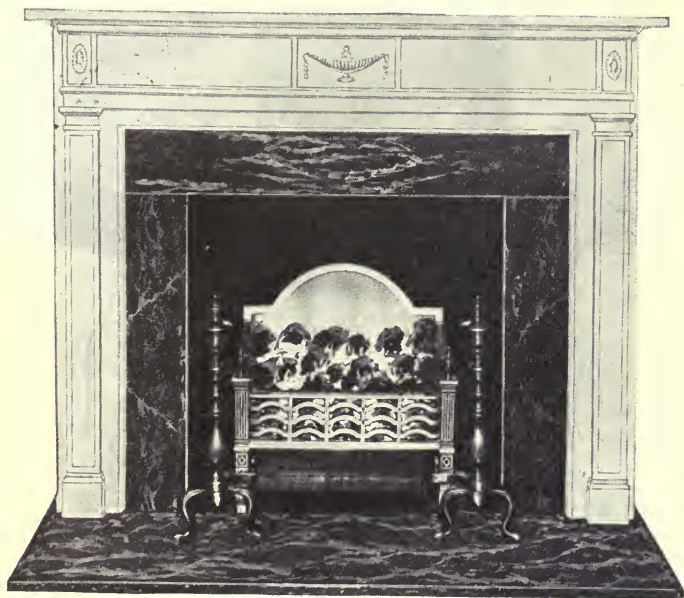

FIG. 123.—“Magicoal” electric grate

carefully scrutinized to discern whether they are real or imitation. To secure the effect of flames the heat from an ordinary incandescent bulb is used to rotate a colored cylinder.

There are two other types of heaters which burn other fuels but depend upon electricity for their control and operation. These are the oil burner and the automatic anthracite burner.

THE OIL BURNER. I have often said that if some agency can do a job better or more cheaply than electricity, then electricity can usually turn about and make that agency do a still better job and at less cost.

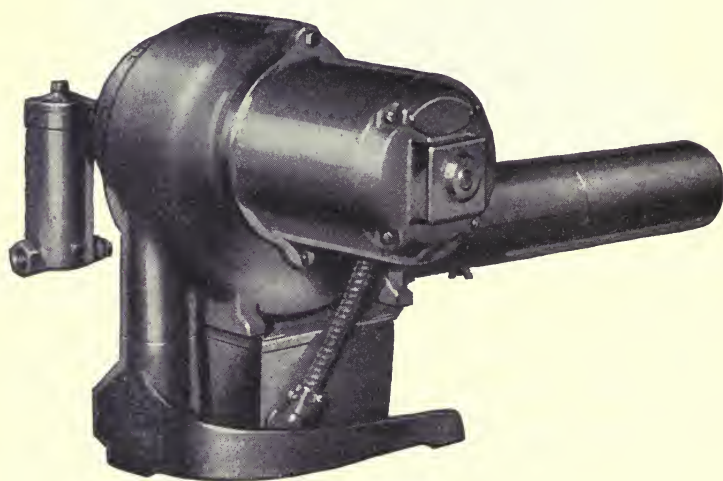
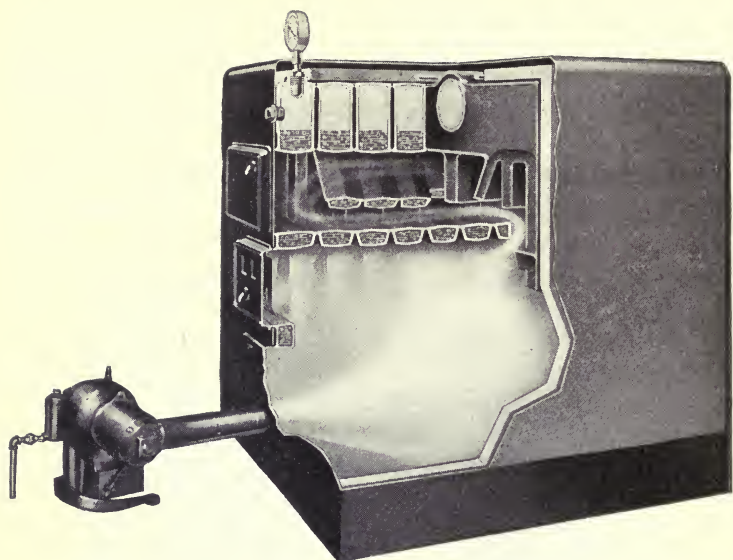

FIG. 124.—“Nokol” oil burner for use with household furnace or boiler

A case in point is the automatic oil burner, used for heating many homes. This is one of the most convenient of modern heating devices, but it is electricity that makes this burner possible. It not only lights the burner when heat is required, and supplies air necessary for proper combustion, but it shuts it off when heat is not needed. It is in the use of the thermostat that electricity is able to completely control the oil burner.

Oil burners may be installed in existing furnaces and boilers as shown in Fig. 124. For most efficient heating, and for homes where the appearance of the heater is of importance, a combined boiler and burner, as shown in Fig. 125, is desirable. Such a burner is entirely automatic and requires little attention.

The subject of oil burners is beyond the scope of this book, but they are mentioned on account of their great convenience and their connection with the electric highway of the home. A special highway or circuit should be provided for the oil burner, independent of all other circuits, but under the control of the main service switch.

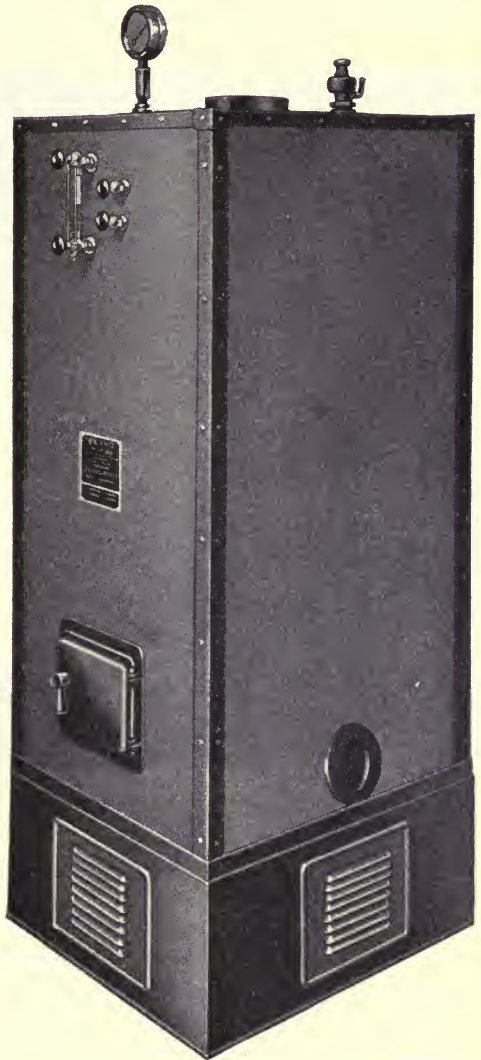

FIG. 125.—“Nokol” combined boiler and burner

THE ANTHRACITE BURNER. Another automatic device for the home heating system which depends upon electricity for mechanical operation and air supply, is the anthracite or hard coal burner, shown in Fig. 126.

It is this device which has modernized anthracite heat for homes, providing the means of utilizing the smaller and more economical

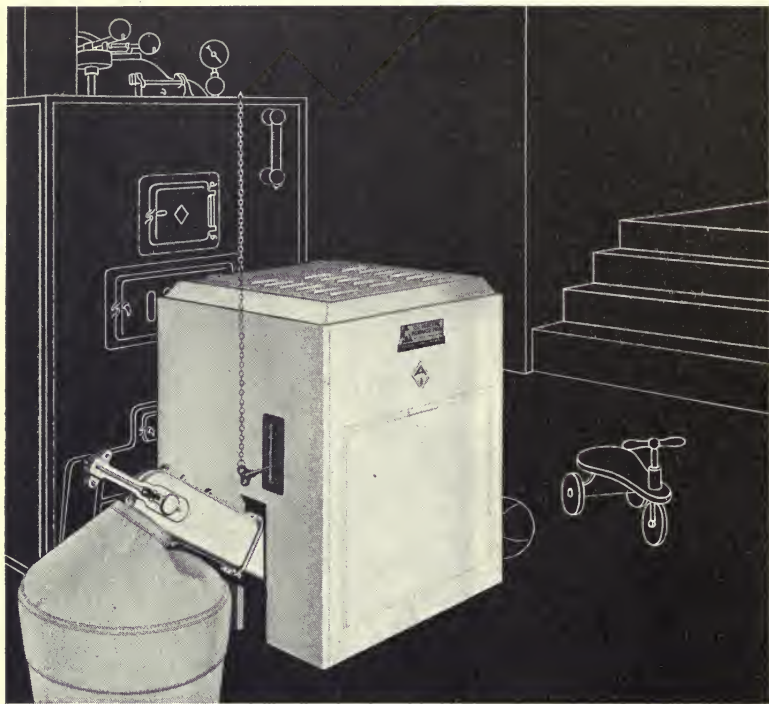

FIG. 126.—"Electric Furnace-Man" automatic anthracite burner

sizes of coal known as "buckwheat" and "rice." The coal is automatically fed from the supply hopper to the burner through a "worm" conveyor—as little or as much as may be required to keep the active rooms of the home at a uniform temperature (about 70 degrees) essential to health and comfort. Not only does this burner automatically regulate the coal feed and air supply by means of thermostat control, but it also automatically removes the ash to a sealed container, so that effortless, clean and highly efficient operation

is now assured by heating with anthracite in the modern way. Burners of this type are available for homes of any size and for any existing heating system. The same installation which heats the home also provides an all-year-round hot water supply.

Thus the electric motor, fan and thermostat lend their aid as willing servants and cheerful coöperators—immaterial to them whether they exercise their magic gifts in “lending a hand” to other heating agencies, or whether the electric current itself performs its direct function of heating—so long as the home can be safely and economically served in accordance with the modern demand for automatic, uniform heat, whatever the weather conditions.

HEATERS, AUTOMOBILE ENGINE. In especially cold climates it is often necessary to keep the automobile engine and its lubricating oil at a proper temperature so that it may be started easily. A heater for this purpose, Fig. 127, is hung inside the engine hood as near the carburetor as possible but away from grease, oil and gasoline. This device can be used in the garage by connecting it to a convenience outlet, or if a car is to be left out of doors the connection can be made to any of the outdoor outlets. To render it more effective, the engine hood should be covered with a robe or blanket.

Another form of heater is installed directly into the cooling system of the car. By connecting the heater to a convenience outlet the water in the cooling system of the car may be heated to its normal running temperature. By means of a time switch the engine may be heated at any predetermined time and made ready for use without having to wait until the engine is heated.



(Westing-house)

FIG. 127.
Auto engine heater

AIR-CONDITIONING

Air-conditioning in the home is a very interesting and important consideration from the standpoint of health, comfort and effort. We can exist without food and water for many hours or days, but without air our existence is a matter of minutes. For proper health and comfort, air in our homes should be clean, free from flying dust or dirt and maintained at a comfortable temperature, in winter usually from 68 to 72 degrees. Moreover, it should contain a certain amount

of moisture, or humidity. Complete air-conditioning in the home provides for all these conditions at all times. The term, "air-conditioner," has been applied to many devices that are only partially effective and usually perform only one or, at best, only a few functions of proper air-conditioning. Complete air-conditioning, in its present development, requires the use of more than one device, and entails a system consisting of permanently installed equipment.

Perhaps it would be simpler to divide the subject of air-conditioning into its several parts, considering each one separately, and later describing a complete system.

AIR CIRCULATION. Air circulation is essential for comfort and health. There is a certain amount of air circulation in all dwellings, caused by leaks around windows and doors, drafts up the fireplace chimney, and by heated air rising to the tops of rooms or to another floor. The use of electric fans, both for air circulation and for cooling a particular room is too well known to require special comment here. Excellent air circulation is also obtained with warm air heating systems.

Built-In Electric Ventilators

For air circulation affecting the entire home a simple, inexpensive system can be installed, using a ventilating fan, as shown in Fig. 128. This particular fan may be worked into a complete system of air circulation as shown in the illustration. It should be installed in the attic to expel heated air in hot weather. Such a fan is very effective in cooling a home when the days are hot and the nights are calm and cool. Ordinarily under these conditions the heated air in the house has no chance to cool quickly. The fan will exhaust the hot air from the attic, or top floor, and cool air from outside will be drawn into the house. By opening certain windows and doors in the different rooms, proper cooling will be effected. By closing all outside doors and windows, except in the room to be cooled, the cool outside air will be circulated through this room to the attic and expelled by the fan. Individual fans may also be placed in a window in the same way and create a comforting breeze on a hot night. Fans may be controlled by time switches or thermostat where permanent installations are made.

CLEANING AIR. To remove all dust and flying particles from the air in the home would be very difficult. The ideal condition can be approached, however, with a permanently installed filtering system. Small fans which force air through a filter made of cloth, or a spray of water, are partially effective and remove some dust and dirt in the room in which such an arrangement is placed. The more dust and dirt that can be removed from the air in the house the less effort is required for cleaning, and the better it is for one's health. The amount of dust and dirt in the air depends upon the location of the home and whether or not it is in a city or out in the country. A ray of sunlight in the daytime, or rays of light from a

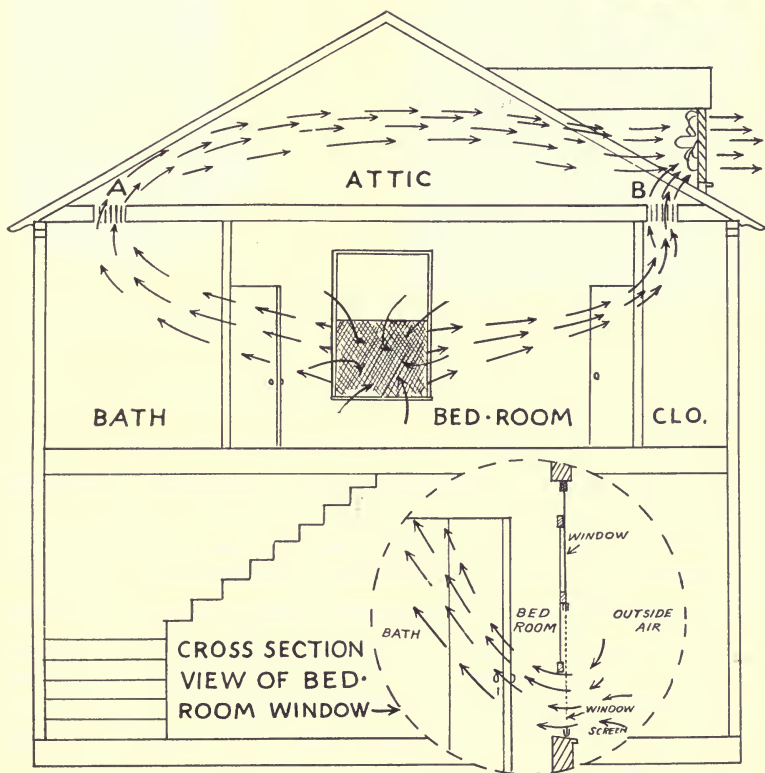
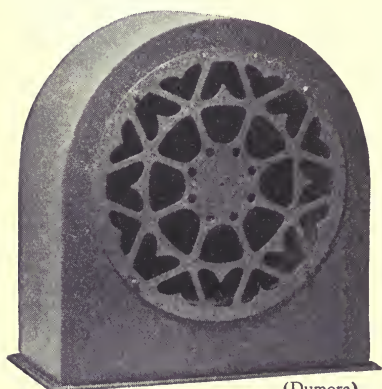

FIG. 128.—Household ventilating system

strong flashlight in a dark room at night, will light up dust—a simple means of determining to what extent the air is dust laden.

ROOM TEMPERATURE. For proper health and comfort, a room temperature of from 68 to 72 degrees in winter is considered best. With lower temperatures outside the home, some source of heat is necessary to make up the difference. When the temperature outside the home is much above 72 degrees, the problem must be reversed and some means of cooling provided. For proper health there should not be much variation in the temperature inside the dwelling, especially in winter, when the temperature should not fall below 68



(Dumore)

FIG. 129.—Portable air humidifier



(Westinghouse)

FIG. 130.—Portable air humidifier and air cleaner

degrees. And for comfort during the summer season it is best not to exceed 85 degrees.

HUMIDITY. Humidity means the amount of moisture contained in the air and plays a very important part in relation to our health and comfort. With too much moisture, or the high humidity usually prevalent in summer heat, the body moisture or perspiration does not evaporate so quickly, and we are uncomfortable even if the temperature is not high. High humidity tends to make us feel warm and low humidity tends to make us feel cool. In cold weather moisture in the air is lacking and thus low humidity may result in an uncomfortable and unhealthy condition. Hot dry air, or air of low humidity, absorbs moisture from every source. It takes moisture from our bodies, dries the skin, irritates the mucous membranes of nose and throat and invites infection. Not only is this

dry hot air bad for our health, but it is very bad for furniture, woodwork, etc., since the absence of moisture causes it to shrink and possibly fall apart.

When air contains all the moisture it can absorb, such as in a heavy fog, it is then saturated and is said to have a humidity of 100 per cent. If only one-half that amount of moisture is present in the air it is said to have a relative humidity of 50 per cent. The amount of moisture that air can absorb depends upon its temperature. Air, at 70 degrees, can absorb sixteen times as much moisture as an equal quantity of air at zero degrees.

Humidity varies continually both outside and inside the home. The evaporation of water and steam from cooking tends to change the humidity, but naturally no such means are effective for complete humidification. During cold weather moisture should be added to the air and during hot weather the reverse is true—moisture should be taken from the air. Adding moisture to the air calls for some system of evaporation, since evaporation means absorbing water or moisture. This can be done in several ways, as by boiling water, or using a fan to force air through a damp cloth or spray of water. Figs. 129 and 130.

Another form of humidifier, which also cleans the air as it passes through it, is shown in Fig. 130. Such a device will wash 200 cubic feet of air every minute. It holds three and a half gallons of water, enough for a twenty-four hour run, and requires no more electricity than an ordinary light bulb. The air, as it is washed, absorbs as much water as required to keep the humidity normal for the existing air temperature. In the washing process most of the odors, carried by the dust in the air, are removed.

There is a little instrument now available called the "Humidiguide," Fig. 131, which will keep you constantly informed regarding the air in your home by registering both the humidity and the temperature. It shows you when the air is either too dry for safety or too moist for comfort. Similar instruments are used for the automatic control of humidity.

KEEPING COOL ELECTRICALLY. Cooling a room is obviously just the reverse of heating it—that is, heat must be taken out of the



FIG. 131.—"Humidiguide" for registering relative humidity and temperature

room exactly in the same way that it is removed from the interior of a mechanical refrigerator. A room, therefore, may be considered the same as a large combination oven and refrigerator for, according to the temperature required, both heated and cooled air must be



(Frigidaire)

FIG. 132.—Combined air heating and cooling system installed in the home. Cooling unit in basement at right. (Letters refer to piping connections)

delivered to it if there is a variation in the outside temperature. In heating, the temperature may vary from, let us say, zero to 70 degrees. In cooling, however, the variation does not impose such a wide range of temperature, for a reduction of a few degrees will be sufficient provided the humidity is lowered at the same time. If the humidity in the room is lowered the air can then absorb the perspiration of our bodies and make us feel cool and comfortable. A room with lower humidity will feel cooler than another room of the same temperature, but with higher humidity.

Electricity is used to cool a room, just the same as it cools the refrigerator, by means of a larger cooling unit, usually placed in the basement. Fig. 132. The cooling coils themselves, instead of being in the refrigerator, are enclosed in a cabinet and placed in the room to be cooled. Lowering the temperature of a



(Frigidaire)

FIG. 133.—Room-cooling enclosure



(Frigidaire)

FIG. 134.—Room-cooling enclosure containing both heating and cooling units, making a compact and attractive installation

room requires cooling a large volume of air to a moderate temperature, whereas the refrigerator must have a relatively small amount of air cooled to a much lower temperature. These same room-cooling enclosures may be used for heating during the cold weather season

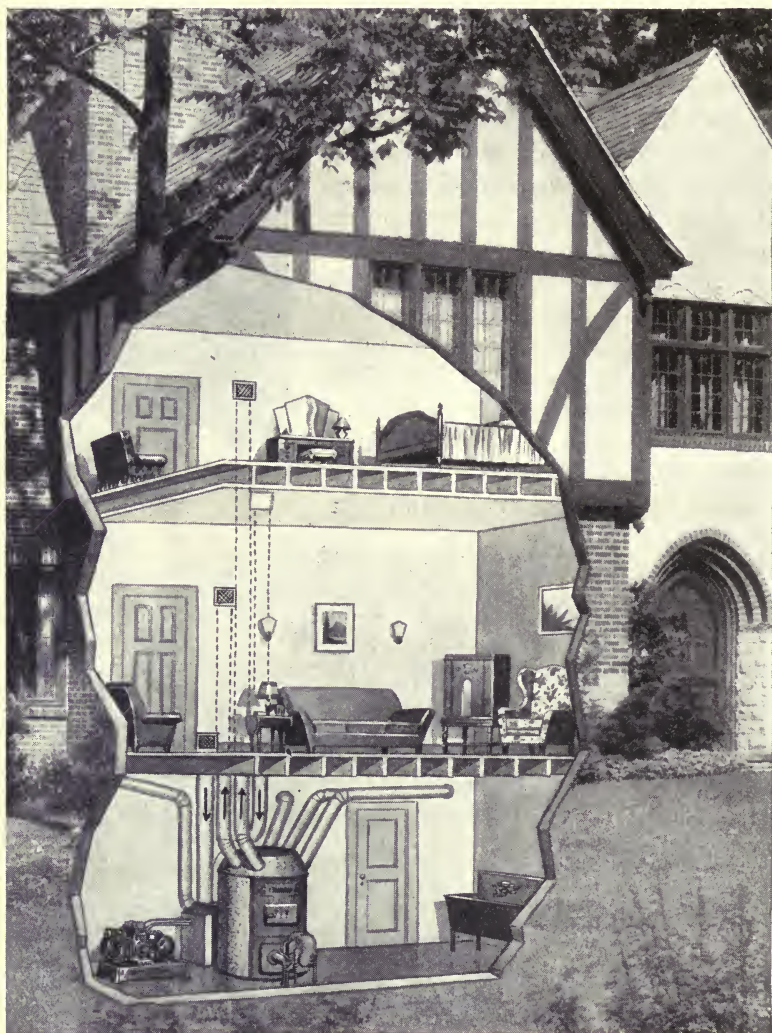

(Frigidaire)

FIG. 135.—Warm air furnace and cooling system combined, supplying warm air in winter and cool air in summer

and, consequently, no extra space is required. Figs. 133 and 134. Several cooling coils in different rooms may be connected with one cooling unit in the basement, and each coil used at different times. This provision keeps the size of the cooling unit in the basement small, reduces the cost of installation and gives a flexible arrangement. The living room, or dining room, may be cooled during the daytime and the cooling process then transferred to the bedroom at night to ensure comfortable sleeping conditions. Such an installation may be entirely automatic and controlled by a single switch.

Some cooling systems employ ice over which air from a fan is circulated and then passed into the room to be cooled. In other types the cold water from melted ice is used to cool a piping system around which a fan circulates air into the room to be cooled. Ice is not entirely satisfactory, since it cannot be stored from day to day, and occupies considerable space for the large quantities required.

In cooling any room it is advisable to keep the windows closed in order to prevent the outside heat from entering, just as cold is kept out of a heated room in the winter time.

COMPLETE AIR-CONDITIONING SYSTEM. A complete system must maintain a uniform temperature, purify the air by washing or filtering, afford correct humidity, and keep air circulating in a gentle motion during all seasons of the year. Any method of heating—vapor, steam, hot water, warm air or electricity—may be used.

An ideal system for the home is the modern warm air furnace. In such a system no space is taken up by radiators, since registers may be placed in the walls or floors. Proper circulation is obtained easily and the air entering any room may be thoroughly cleaned. The same equipment may be used in summer in connection with a cooling system and the air at all times maintained at the proper humidity. Automatic control simplifies the problem of attention. Such an ideal system is shown in Fig. 135.

Summary, for Complete Air-Conditioning

AIR CIRCULATION: Fig. 189. Increased by a portable electric fan in the location desired.

Fig. 128. By a blower (special type fan) installed in a permanent ventilating system in the house.

- CLEANING AIR: Fig. 130. Local, and in small amounts, by forcing air from a fan through water, cloth, or some other filtering material.
 Fig. 135. General system for the home by use of washing, or other filtering process, employing forced ventilation through ducts to reach each room.
- HEATING AIR: Figs. 132 and 135. Several methods employed using various fuels.
- INCREASING HUMIDITY: Figs. 129 and 130. By evaporating water over a radiator, or by the use of an electric fan to force the air over a wet surface.
 By boiling water and allowing the steam to escape.
 By a permanent automatic system installed in the home.
- COOLING AIR OR DECREASING HUMIDITY: Figs. 132, 133, 134 and 135. By electrically operated mechanical systems.
 By melting ice with forced air circulation in the room.
- COMPLETE AIR-CONDITIONING: Fig. 135. All functions of air-conditioning are possible with a system installed in the home as a complete working unit.



PREPARATION FOR WEDNESDAY'S JOURNEY

We have now come to the middle of the week and, since we have exploded many of the myths of housekeeping "hum-drums"—particularly Washday, Ironing Day and Cleaning Day—by relegating drudgery to the Dark Ages, we can well afford to take the time we have saved and pause from our contemplation of specific tasks.

Since this is Wednesday named for "Woden"—the great god of the Scandinavians who lived in a palace called "Valhalla"—it seems appropriate that we should give our attention on this day to those electrical conveniences which have made virtual palaces of modern homes. It will be recalled that Woden had two ravens which stood on his shoulders and when he wanted news of the world he sent these ravens out to fly 'round the earth and report back to him everything they saw and heard. Oddly enough, two of the topics we shall discuss on this inspection of the Wonders of Wednesday's Room are the telephone and radio. What more apt analogy to the ravens of Mythology could be found than the earth-encompassing telephone and radio of modern times?

WEDNESDAY'S PROGRAM

KEEPING WELL ELECTRICALLY.

PERSONAL ELECTRICAL APPLIANCES.

GETTING THE MOST OUT OF YOUR TELEPHONE.

GETTING THE MOST OUT OF YOUR RADIO.

What rays of sunlight do not penetrate ordinary window glass, and how are these health rays obtained by artificial indoor means?

What are the fundamental differences between the two distinct types of sun-ray lamps? What is the health effect of the Ultra-Violet Ray? Of the Infra-Red Ray?

What precautions should be taken in using sun-ray lamps?

For any major ailment why is it best to consult your physician before applying home treatments with sun-ray lamps, high-frequency machines and vibrators?

Read the section on "Personal Electrical Appliances."

Are your dressing table, bridge table, reading table and sewing room adequately provided with these little "hand-maidens" of utility and convenience?

How many other little servants of this type might you employ to advantage? Many new and ingenious utility articles—inexpensive to buy and of negligible cost to operate—are continually coming on the market. Be on the lookout for them. They are handy to have about the house and they make welcome gifts.

How much of your time might be saved and how many "unheard calls" avoided by installing extension telephones where needed? (See also Thursday's section on Signal Systems.)

How many important factors are there to be considered in selecting and installing your radio? Like the telephone extension service, inexpensive radio sets for children's rooms, or loud-speaker extension "outlets" connecting to a central receiving system, will prove a great convenience and a practical solution of the "family interference problem" in almost every home and apartment.

Why should only the highest quality of tubes obtainable be used in your radio receiver?

What do modern electric sewing machines offer in the way of special advantages that the old foot-treadle machines lacked?

WEDNESDAY'S JOURNEY

KEEPING WELL ELECTRICALLY

The application of electricity to health improvement offers an extensive field of useful endeavor for these amazingly clever and adaptable electric servants which have taken their nurses' and doctors' degrees and have thus become "Health Appliances."

Electricity will produce the same healthful rays artificially, and at any time, that are provided by Nature in sunlight. It will provide mechanical power for the massage, either local or over a considerable portion of the body at one time. In a specially constructed vessel it will provide heated vapors for inhaling purposes. It will also provide heat for the body. All of these benefits of electricity, either for keeping you well or for curing some particular ailment, may be obtained by making a connection to the ordinary convenience outlet in the home. There are any number of devices available which assist in one way or another to improve general health, or to cure particular ailments, but I shall take up only the most important applications.

Among the health appliances now generally used are the following:

SUN-LAMP (SUNSHINE)	HIGH-FREQUENCY MACHINE
INFRA-RED RAY LAMP (ELEMENT TYPE—MEDIUM HEAT RAYS)	WARMING PAD (LOCAL SURFACE HEATING)
BULB TYPE (MEDIUM AND DEEP HEAT RAYS)	HEATING BLANKET—LOCAL SUR- FACE HEATING (LARGE AREA)
LIGHT RAY AND HEAT BATH CAB- INETS	VIBRATOR (LOCAL MASSAGING)
	VAPOR HEATER (FOR INHALING)
	BODY EXERCISER (MASSAGING)

Almost limitless claims are made for some of these devices and, therefore, it is well to be somewhat cautious in making a selection. Well known national manufacturers do not make unjustified statements, their intention being to explain clearly the real benefits which may be expected. So when you contemplate purchasing health appliances be sure to buy only from a responsible and well-informed dealer. In any case, where you expect to cure a particular ailment, it is important to secure the advice of a reputable physician.

Throughout this section I have been forced to employ the accepted technical or medical terms used in connection with health lamps. I

can find no other terms that might correctly define the processes or technicalities herein described. I have tried to make the subject understandable to those of my readers who, as yet, have never had occasion to make use of sun-lamps, and if you will bear with me in the use of a few unavoidable phrases I am sure we can get over this part of our journey without too much mental fatigue and discomfort.

Sunlight Lamps

Strange as it may seem, the part of the sun's rays which are most beneficial to our health are completely invisible. Our eyes are built to register only certain parts of the sun's rays, just as a radio is capable of receiving waves of only certain lengths. There can be no disagreement with the idea that sunlight is essential to our health, but how many people today realize that the rays which really contribute most to our health do not pass through ordinary window glass? Because we cannot see these health-giving rays, and because we spend so much of our time indoors, it is becoming more and more important that we give attention to providing these rays artificially.

There are two distinct types of rays produced by sun-ray lamps. One is the ultra-violet ray and the other, the infra-red ray.

The ultra-violet ray contains very little heat and reacts on the blood stream of the body, increasing the supply of the valuable vitamin D, and producing the well known effect of sunburn technically called "erythema." This ray is of great benefit in preventing and curing rickets and in building up sound bones and teeth, thus improving general health and making us more resistant to disease.

The other type of invisible ray produced is called the infra-red ray. This is a heat ray which penetrates beneath the surface of the skin and is helpful in relieving pain, relaxing spasm and promoting circulation.

While artificial sunlight equipment has been used by physicians for a great many years in their treatment of disease, it is only within recent years that lamps which are safe and convenient for the home have been available. The first equipment perfected for home use was very similar to that used by physicians. These devices were large and rather cumbersome units which produced a very high percentage of the valuable invisible rays—such as would reach us from the sun

if it were not for the dust and smoke in the air and for the ordinary window glass which filters out many of the beneficial rays.

This accounts for the fact that mountain climbers in high altitudes, where the air is free from contamination, must protect themselves from sunburn in spite of the cold fully as much as bathers at the seashore.

"Ultra-violet radiation," as the physicians call it, but which, simply expressed, means only "throwing off" health-rays, just as in strong sunlight, may be divided into three forms, depending upon the "wave lengths" of the ultra-violet energy. And as for "wave length," it is simply a technical expression for the relative "health-quality" and penetration of the ray. These three forms follow:

The "near-ultra-violet" is that which affects the photographic film or plate and is readily transmitted by ordinary glass. The "middle-ultra-violet" is the "biologically effective" ultra-violet. Let us call it merely that which supplies the life-needs of the body. This form creates vitamin D in our bodies and is not transmitted by ordinary glass. The "far-ultra-violet" is germicidal and is used for the purpose of killing germs, sterilizing various things, etc. The far-ultra-violet is injurious to the eyes and any ultra-violet sources which emit such radiation should be used only under the direction of a physician, and in no case without the protection of the eyes by goggles.

Ultra-Violet Ray Lamps

There are three general classes of ultra-violet or sun lamps: the so-called carbon-arc type which first entered the field, the quartz mercury vapor lamp, and the Mazda sunlight type of lamp.

THE CARBON-ARC TYPE. This type, available in several different designs, produces ultra-violet and some infra-red rays, and may be used on either A.C. or D.C. circuits. It is usually of the floor type and mounted on a stand with adjustments for directing the rays in any particular direction. This device gives off light and produces ultra-violet and infra-red rays by the heating of special carbon rods with an electric current passing from one to the other. (In other words, an "electric arc.") Some of these lamps are quite powerful and they should be used with considerable caution in order to prevent the discomforts of sunburn by over-exposure. The eyes in all cases should be protected by proper glasses. It is also essential in using

these more powerful arc-type lamps to secure the advice of a good physician, or someone entirely familiar with the use of the apparatus, and carefully follow instructions so that no ill effects will result.

THE QUARTZ MERCURY VAPOR TYPE. This type of lamp, shown in Fig. 136, operates on either A.C. or D.C. circuits. It gives off a relatively small amount of infra-red rays, but is a powerful source of ultra-violet rays, a high percentage of which are "short-wave" radiation. (Note what has been said previously about "far-ultra-violet" radiation.) Such a lamp, therefore, should be used only under the supervision of a physician and the eyes must always be protected

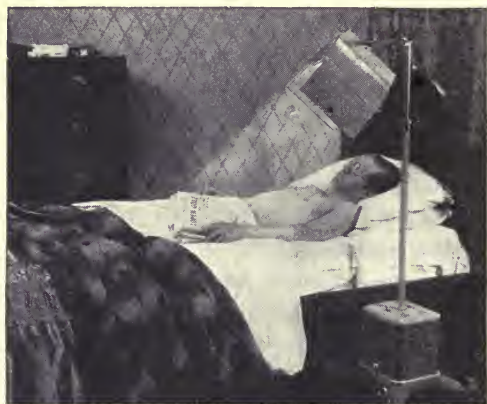

(Burdick)

FIG. 136.—By the use of ultra-violet rays, electricity serves a useful purpose in health treatments

with proper glasses. This type of lamp produces very powerful rays and is used for brief applications only. A time switch is employed to advantage here, since it turns off the lamp at the proper moment, after a safe period of treatment.

rays and may safely be used in the home. Fig. 137. This type consists essentially of a mercury-arc operating between two tungsten "electrodes." The arc is started by a tungsten filament somewhat similar to those used in regular bulbs. The bulbs are made of a special glass which readily transmits the middle, or "biologically effective" ultra-violet. That term doesn't scare us now since we know it merely means "something that is good for the body." This glass screens out the "short-wave" radiation, thus making it unnecessary to wear goggles and resulting in a lamp which anyone can use in the home with safety.

The sun-lamp bulbs are somewhat similar in appearance to ordinary bulbs. They are, however, quite different. They will not operate

(Below)—Portable type,
metal shade

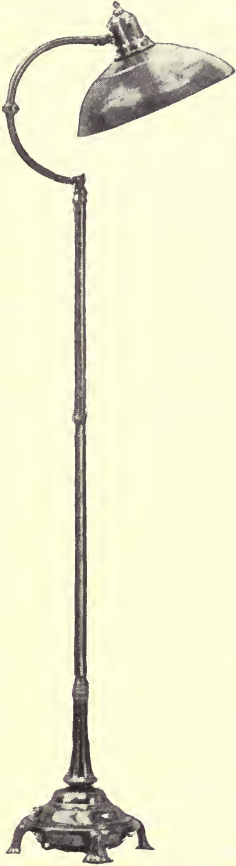

(Left)—Portable type,
decorative shade

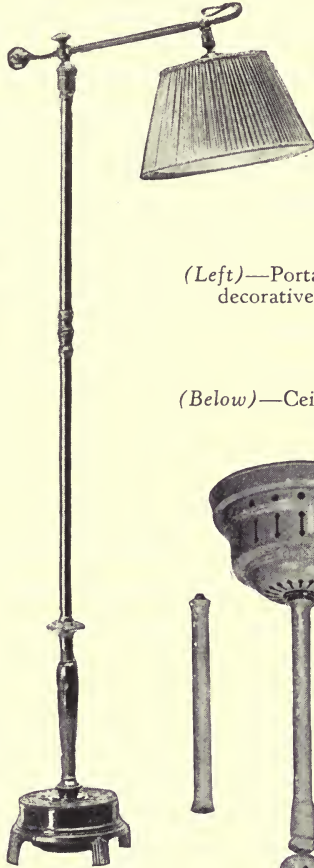

(Below)—Ceiling type

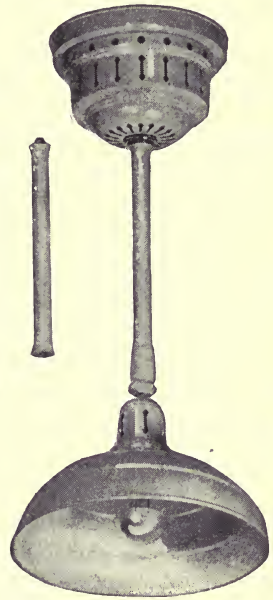

FIG. 137.—Typical sun-lamp fixtures

directly on the lighting circuit and will not fit standard sockets; nor can they be used on direct-current circuits. These lamps require transformers for their operation. The transformers, however, are furnished as component parts of the fixture.

Two sizes of lamps are available, known as Type S_1 and Type S_2 . The general principle of operation of these two lamps is the same. The Type S_2 lamp, however, has a metal cap fitted over the bowl of the bulb. The purpose of this cap is to concentrate heat back into the bulb. If the cap is removed the ultra-violet output of the lamp will be cut approximately in half and its life shortened.

In addition to ultra-violet rays, these lamps emit visible illumination of an excellent quality for general reading and working purposes. The more powerful lamp, the Type S_1 , consumes approximately 500 watts and is generally used as an applicator lamp where it is desired to receive an adequate dose of ultra-violet radiation during a short period of time. The Type S_2 lamp, consuming approximately 175 watts, may be used where it is desired to read or work under the lamp for several hours at a time and receive an adequate amount of ultra-violet over these longer periods.

The net effect of an ultra-violet dosage is the product of the intensity of ultra-violet, times the period of exposure. Therefore, practically the same beneficial results can be obtained from fairly high-intensity short exposures or from low-intensity long exposures.

For general lighting purposes these lamps are sometimes combined with ordinary lamps in what are known as dual-purpose lighting fixtures, the regular lamps furnishing indirect illumination and the sun-lamps supplying direct illumination plus ultra-violet.

In using the applicator type of lamp, the makers furnish exposure tables which indicate the length of exposure necessary at different distances from the lamps to produce what is known as "minimum perceptible erythema" (MPE), or the slightest visible reddening of the skin. This is really the beginning of sunburn. These tables are based on the sensitiveness of average human skin, and apply particularly to those parts of the body which are not ordinarily exposed to the weather. Considerably longer exposures, for example, are necessary to produce "MPE" on face and hands than on the stomach. Individuals vary quite widely from the average tabulated figures. In general, blondes will "sunburn" more readily than brunettes and should, therefore, use somewhat shorter exposures than the average.

There are many people who are not particularly sensitive to sunburn, and they can use longer exposures. Furthermore, as one becomes accustomed to exposure to ultra-violet radiation, the length of exposure can be increased. There is also considerable variation in the sensitivity of the human skin to ultra-violet depending upon its condition of relative moisture or dryness. Furthermore, the length of exposure may be different in summer and winter.

The output of sun-lamps also varies somewhat with the voltage on which they are operated, and decreases somewhat throughout their life. Exposure tables, therefore, are more in the nature of a general guide than an exact rule to follow in taking treatments. As a matter of comparison, midsummer noonday sunlight will produce "MPE" in approximately 20 minutes' exposure. The Type S₁ lamp, at a distance of 30 inches, will produce "MPE" in approximately 4 minutes' exposure. It is, therefore, at that distance about five times as powerful as midsummer noonday sunlight. The Type S₂ lamp, at a distance of 30 inches, will produce "MPE" in approximately 30 minutes' exposure. It is, therefore, at that distance a little less powerful than midsummer noonday sunlight. The following table shows the approximate exposure times required to produce "MPE" at different distances from the Types S₁ and S₂ lamps. These exposures are based on lamps operating in a vertical position, base up, and without the wire screen which was furnished with some of the early Type S₁ equipments:

Distance from Bottom of Fixture to Patient	Approximate Minutes or Hours Exposure for MPE Narrow-Spread Reflector	
	Type S ₁ Lamp	Type S ₂ Lamp
2 feet	3 minutes	20 minutes
4 feet	10 minutes	1¼ hours
6 feet	23 minutes	3 hours
8 feet	40 minutes	5 hours
10 feet	1 hour	8 hours
12 feet	1¼ hours	9¼ hours

If the lamps are used at an angle of 45 degrees, the intensity of the ultra-violet is cut approximately in half.

In the application of ultra-violet rays it should be remembered that it is not necessary to have a visible indication, in the form of a reddening of the skin, to secure beneficial results. One-tenth of the exposure required to produce reddening is still very beneficial.

Remember also that the reddening does not appear for several hours after the exposure, so do not wait for this noticeable effect as a sign of a sufficient dose. There is a wide range of ultra-violet dosage to which the human body readily accommodates itself, and sun-lamps may be used with about the same care that is taken in the



FIG. 138.—The infra-red ray lamp is used where the application of heat to the body is required

use of midsummer noonday sunlight. To illustrate this better, it takes two and a half times the dosage given in the preceding table to produce vivid reddening, five times for a burn, and ten times for a blister.

If exposure for a certain length of time is required a time switch will turn off the light at the proper time—10 minutes, 20 minutes, or whenever desired.

Infra-Red Ray Lamps

The infra-red ray, or the heat ray, is used in medical treatments where heat penetration is required. This ray is produced by two different types of lamps—one of which is mounted on a floor stand, while the other is equipped with a handle for strictly portable applications. Fig. 138. This ray can be detected by the warmth produced and is best used under the direction of a physician. As a general rule, the application of heat is necessary for at least twenty minutes, which makes the floor lamp of greater use. Sources of infra-red rays are from an electric arc (an electric current passing between the points of two carbon rods), tungsten or carbon filaments, or from an electrically heated silicon compound. Radiation from the tungsten-filament, high-efficiency, gas-filled bulb will penetrate to nearly three times the depth of the carbon-filament bulb.

Selection of the Right Sun-Lamp

There are several designs and makes of sun-lamps having different characteristics, but general information as to the fundamental differences between the health rays produced will probably be sufficient to guide you in the selection of the type of lamp which will best fit your needs.

The advance in the art of producing artificial sunlight has been so rapid during the past few years it is entirely possible that, within the next decade, the usual illumination in the home will include sufficient ultra-violet to afford most of the healthful benefits of sunlight itself. Already these units are available so that midsummer sunlight may be had in any home and the benefits enjoyed while reading or bathing, or while the children are playing, regardless of the season or the weather.

To review briefly the lamps described:

Ultra-Violet and Infra-Red Rays

ARC TYPE LAMPS: Strong ultra-violet rays and fairly strong infra-red rays. Can be used on either A.C. or D.C. circuits. Protecting eye glasses must be used.

QUARTZ-MERCURY-VAPOR LAMPS: Fig. 136. Very strong ultra-violet rays. Protective glasses must be used.

MAZDA SUNLIGHT
LAMPS:

Fig. 137. Ultra-violet rays and some infra-red rays. For use on A.C. circuits only. Protecting eye glasses not needed.

INFRA-RED RAY
LAMPS:

Bulb Type. Incandescent bulb, tungsten filament type, for high penetration of heat rays. May be used on A.C. or D.C. circuits. They produce light.

Element Type. Fig. 138. For medium penetration of heat rays. May be used on A.C. or D.C. circuits. They do not give off light.

Do not hesitate to ask the advice of a physician as to the proper use of these lamps in order that you may receive the greatest benefits from a health standpoint.



FIG. 139.—Light and heat ray bath cabinet for special health treatments

Light and Heat Ray Bath

For those who have had prescribed for them a light and heat ray bath a special cabinet is available, as shown in Fig. 139. This bath is effective on all parts of the body excepting the head, which is kept outside the cabinet. The heat and light are provided by special bulbs.

High Frequency Machines

Electricity as supplied to the home is of little use from a medical standpoint in its raw state, so to speak. However, by means of a special transforming device it may be changed into a high-frequency current that is beneficial and safe for treating certain ailments of the human body. The high-frequency currents are brought into contact with the body by means of variously shaped glass electrodes, the complete outfit being shown in Fig. 140. The high-frequency current discharge gives a cellular massage of the muscles. This discharge, through the vacuum in the glass electrodes, is violet in color and is called a "violet-ray." Where a small quantity of ozone is

required for medical purposes it may be obtained from this same machine by means of a special ozone-producing electrode.

Heating or Warming Pads

A heating pad should be part of the equipment of every home, for in case of need nothing can take its place. The hot water bottle does not maintain a constant temperature, is awkward and heavy and must be refilled continually, whereas the heating pad always gives just the degree of warmth you wish and it is soft, light and flexible. It is valuable for relieving many kinds of bodily pain, and for providing warmth for those who have poor circulation, or who sleep on porches or in cold places.

Various sizes of warming pads, with varying degrees of heat, are obtainable. Fig. 141. The majority of the smaller sizes, however, are made with only one heat, although if the enclosed heating element is closer to one side of the pad than the other, that side will be several degrees hotter than the other. Practically all of the larger sizes have three different degrees of heat controlled by a switch on the cord. Some of these switches have either raised or indented marks to

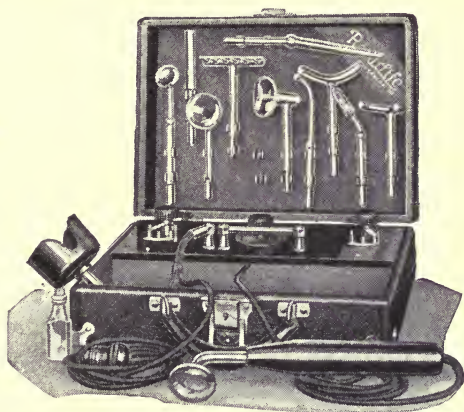

FIG. 140.—High frequency generator for cellular massage

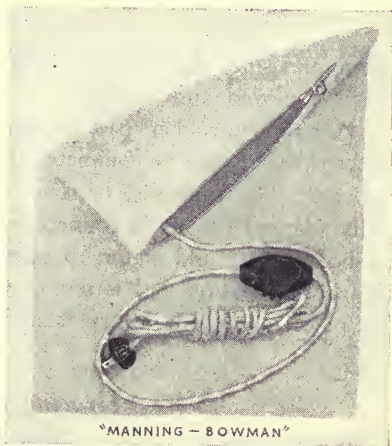

FIG. 141.—The electric warming pad now replaces the old-fashioned water bottle

indicate high, medium and low heat, so that the position of the switch may be discovered in the dark. Others have two push buttons, one for low, one for medium, and both for high heat. In selecting a warming pad be sure that it is controlled by a thermostat to keep the temperature constant, automatically turning off and on, with low at 125 degrees, medium at 160 degrees, and high at 185 degrees Fahrenheit.

For ordinary use, the pads made with the soft eiderdown covering are probably the most practical. They may be purchased in any pastel tint or darker shade, but some sort of light or dark washable cover usually comes with them for protection from soiling. An eiderdown pad with a rubber cover is an especially convenient type.

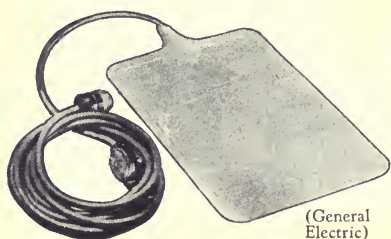

FIG. 142.—Sanoflex all-rubber heating pad which may be sterilized by immersion in boiling water

The special water-repellent material can be slipped on over the pad, so that poultices and compresses may be kept warm without injuring the pad. Moisture, otherwise, must be kept away from it, for water injures the ordinary pad.

Another type that can be used with wet as well as dry packs has a wet-proof inner surface underneath the eider-

down, and since the whole covering is in one piece it can be unbuttoned, removed and washed.

A moulded-rubber pad is also now available which is so constructed that it can be completely immersed in water without injury. Fig. 142. This type may be covered with softer material and is especially adapted for use in connection with wet applications. It may be washed in soap and water, or sterilized by boiling in water. When the rubber heating pad is not in use, it should be stored in a cool, dry place to prevent injury from light and air.

Heating Blankets

While the heating pad gives heat to a small area it is sometimes necessary to heat larger areas and perhaps a whole bed when one sleeps out of doors during cold weather. For this purpose an elec-

trically heated blanket is used as a bed covering. Such blankets should be kept dry since they are not covered with waterproof material.

Electrically heated blankets are also used for producing profuse perspiration.

Vibrators

For local massaging and for reaching definite spots on the body, a vibrator is used. This consists of a small motor mounted on a handle, as shown in Fig. 143. The motor causes the applicator to vibrate very rapidly. Different types and shapes of applicators are used, according to where the massaging is required. The intensity of the massage is varied by the speed of the motor and by the softness or hardness of the applicator. The makers issue complete instructions for using the vibrator, but for any major ailment the advice of a good physician should be obtained.

Another form of vibrator, which, when strapped on the back of the hand vibrates the fingers, may be used for massaging purposes. In this case the vibrator practically takes the place of the human hands, or at least supplies the human energy, and there is nothing for the operator to do but hold the device.

A vibrator should never be used while you are bathing and, at all times, should be kept away from dampness.



FIG. 143.—The electrical vibrator for local massaging

Inhaler

There are several types of inhalers for vaporizing liquids used for medical purposes. A small heating unit turns the water into steam, which passes through the oils or whatever is used for inhaling.

Body Exercisers

Body exercisers have been used extensively in the home, and the oscillating belt is used for vibratory massages over almost any part

of the body requiring treatment. But here again the advice of a physician in the use of such equipment should be followed.

Cold Compress

A continuous supply of ice cubes from the electric refrigerator makes it possible to make up a cold compress at a moment's notice.

PERSONAL ELECTRICAL APPLIANCES

There are a number of miscellaneous appliances for use by individuals for their special needs. In this class of equipment I am listing the following items:

TOBACCO LIGHTER
HAIR DRYER
OIL COMB
CURLING IRON
SKIN PATTEN

ELECTRIC SCISSORS
RAZOR BLADE SHARPENER
AUTOMATIC CARD TABLE
SEWING MACHINE

TOBACCO LIGHTER. Electric lighters for the smoker are so convenient that they are used in practically all homes, doing away with



(Manning
Bowman)

FIG. 144.—A tobacco lighter which lights a pipe as well as a cigar or cigarette

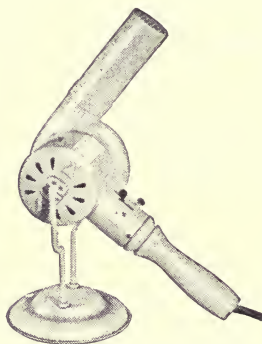

FIG. 145.—The electric hair dryer produces either cool or heated air at the touch of a switch

the dangerous match. There are several types of lighters which you either tip, or on which you press a button, to get a light. Some

types are equipped with a cabinet or magazine, most of them sufficiently large to hold a quantity of cigarettes, and they will deliver a lighted cigarette to you when you press a lever. Another kind contains a snuffer and ash tray, and may be purchased in silver or gold finish as well as chromium. Another type is made to clamp to the dashboard of your car, so that no matter how windy or cold the day, you may have a lighted cigarette or cigar while you are driving. The heating unit in these lighters is similar to those used in the range, but only a fraction of the size. The lighter shown in Fig. 144 will not only light a cigar or cigarette, but a pipe as well.

HAIR DRYERS. For drying the hair quickly, electricity performs two services: it provides both heat and a gentle breeze of air.

The most effective hair dryer is one that provides hot air for drying. Such a dryer is shown in Fig. 145 and consists of a small motor which revolves a fan for forcing the air through an electric heater contained in the nozzle. Either cool or warm air may be obtained from this dryer. A separate stand may be used, so that both hands are free for massaging the scalp during the drying process.

The motor-driven hair dryer has many uses, since it will dry anything requiring a strong current of either cool or warm air. If you can get it away from mother or sister, try it when drying photographs or in the shop when varnishing.

ELECTRICALLY HEATED OIL COMB. To properly apply heated oil or a tonic to the hair, the electrically heated oil comb, shown in

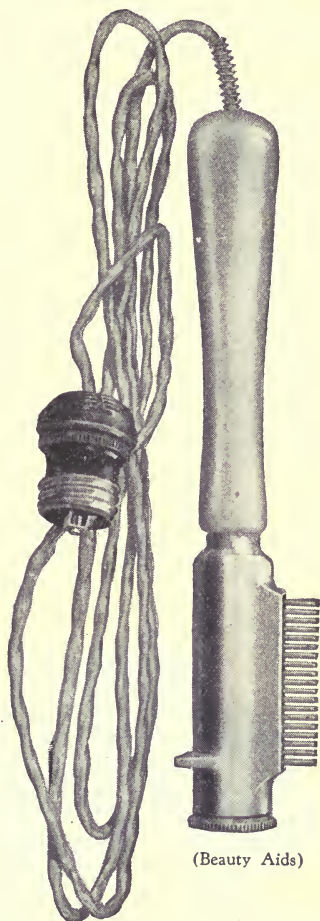

(Beauty Aids)

FIG. 146.—The electric oil comb for hot massage where heated oil is required

Fig. 146, provides an ideal method. It may also be used to dry the hair, or for a hot massage of the scalp, face, arms, or for applying heat to any part of the body.

CURLING IRONS. Electrically heated curling irons contain a small heating unit for keeping the iron at a constant temperature. Several styles are available, and some have removable clamps, a switch in the handle, etc., for your convenience.

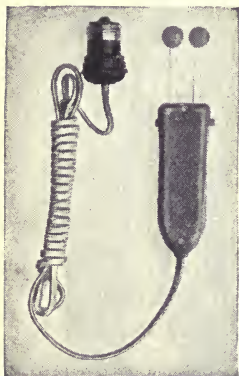

(Connecticut)

FIG. 147.—The electric skin-patter for stimulating blood circulation in facial treatments

SKIN PATTERS. Instead of a rubbing or vibratory motion, to stimulate circulation of blood in the face, a patting motion is often recommended by beauty experts. Such patting action may easily be obtained by an electrically operated skin patter. Fig. 147.

RAZOR BLADE SHARPENERS. Double-edge razor blades may be resharpened by means of an electric device, shown in Fig. 148, in which a small motor revolves a set of rolls upon which specially treated leather sharpening strips are wound. This device both hones and stropps the blade in one operation. The blade is placed between these rolls and the cover of the sharpener is then closed,

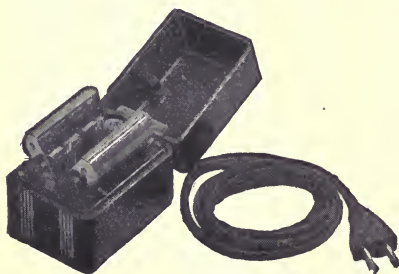

(General Electric)

FIG. 148.—The electric razor blade sharpener saves time and temper

which automatically starts the motor. After a blade has been resharpened, the rolls are stopped automatically.

AUTOMATIC CARD TABLE. Avoiding misdeals and using cards that are properly shuffled help to keep one's mind on the game of bridge. This may be done by using a bridge table that shuffles and deals cards

mechanically by means of a small motor mounted under the top of a standard type folding card table. A pack of cards is placed in a small drawer on one side of the table. Closing the drawer starts the card distributor, which places an equal number of cards in a small compartment in front of each player, properly

shuffling them in the process. When one hand is being played, another pack is being shuffled and dealt ready for use when wanted. A cord connects the table with any convenience outlet. The top of the table is free, since all the distributing is done beneath its surface.

ELECTRIC SCISSORS. Mechanical motion required for making scissors cut cloth may be supplied by electricity. All you have to do is to press a button and guide the scissors. Patterns may be cut easily and accurately with perfect safety. Any weight material from the sheerest of silk to three or four layers of woollens may be cut easily and quickly with this device.

Sewing Electrically

Analogies are often helpful in understanding and simplifying any subject which appears to be somewhat technical and difficult, as in the case of likening the home wiring system to the automobile highway. I therefore ask of my feminine readers the privilege of referring to the sewing machine as "The Woman's Workshop." And now that electric power does the work of the foot-treadle, saving human energy and strength as well as adding vastly to the comfort and pleasure of this most useful of household arts, sewing with the modern electric machine has ceased to be a task.

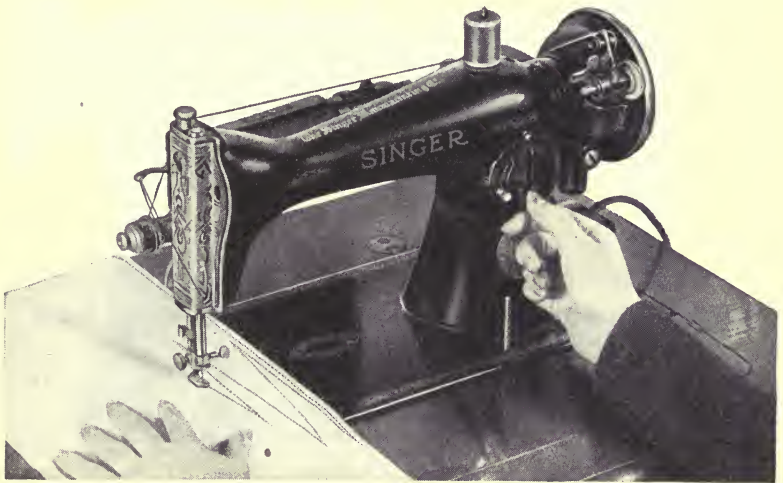

FIG. 149.—A machine that sews forwards and backwards at the touch of a switch

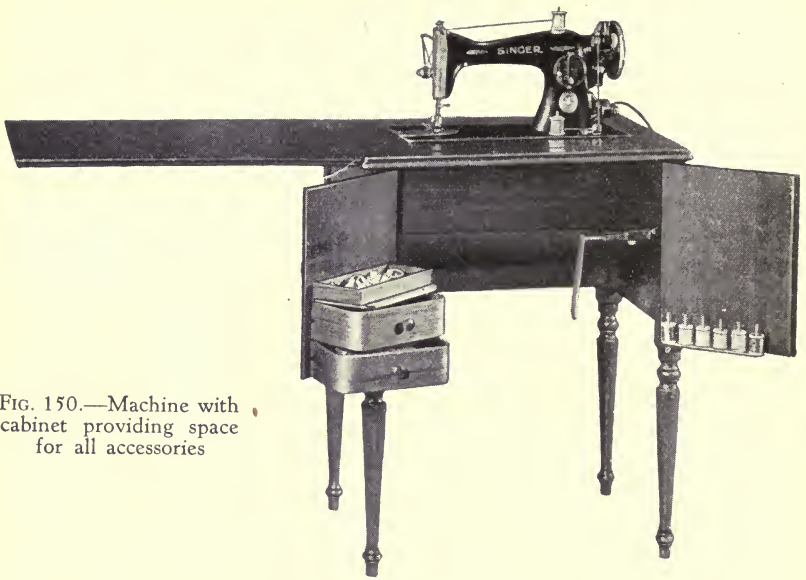

FIG. 150.—Machine with cabinet providing space for all accessories



FIG. 151.—Head of standard model sewing machine

THE MODERN SEWING MACHINE MAKES ANY ROOM A SEWING ROOM. The "business end" of this machine, or we might call it the "Electric Work-Bench," is shown in Fig. 149. This machine represents the greatest advancement that has ever been made in the sewing art. Here is a precision model which is not only mechanically perfect but is also under the complete control of the operator, it being possible to obtain and maintain any desired speed of sewing. With a machine of this type one can easily stitch either forwards



FIG. 152.—The standard machine with folding table top. Head is enclosed when not in use. An attractive piece of furniture for any room

or backwards and the number of stitches may be varied at will to suit the needs of the work being done. The care and maintenance of such a machine has been reduced to a minimum and the numerous advantages over the older foot-treadle type of machine incorporated in this electric model leave nothing to be desired in respect to sewing accomplishment and time and labor-saving operation. When not in use the machine folds down into its cabinet or table and makes it an ornamental and useful article of furniture—a convenient woman's work-bench for any room in the house without detracting from its

appearance. Fig. 150. The head of still another model of the electric sewing machine is shown in Fig. 151, while the same machine, together with its cabinet, is shown in Fig. 152.

THE PORTABLE ELECTRIC SEWING MACHINE. For small homes

or apartments, where space is limited, or for the summer cottage, a portable type of machine, Fig. 153, is very desirable. Such a machine may be placed on any table and immediately put to work after making the electrical connection to a convenience outlet. This machine is also furnished without belts and is just as modern

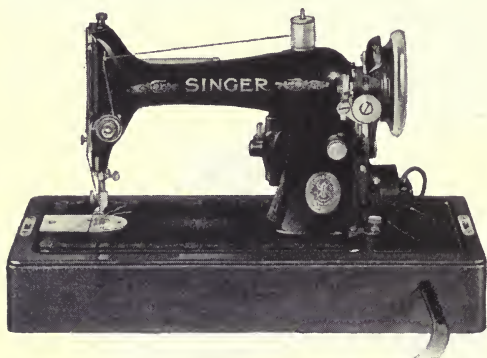

FIG. 153.—The convenient portable type sewing machine

and complete in every particular as the machine which has a containing table of its own.

THE SEWING MACHINE AS AN AID TO ECONOMIC RECOVERY. Not long ago I had the pleasure of discussing "The woman's job in the home" with a lady of national prominence in club and social work.

"I think you men should know that women are really helping to right the economic ship, easing your problem and their own as well," she said. "We are returning to our home crafts and ancient arts by way of doing our part in the reconstruction movement. But, today, we are employing modern methods and machines which impart a speed and skill to these home-making accomplishments that would have amazed our grandmothers. And, unbelievable as it may seem, we are finding this new home industry just as fascinating as manufacturers doubtless will find their businesses once the almost idle machines start work actively producing again. That is the kind of bargain we are now making and it is so simple and such a pleasure to make our own and our children's clothing and home decorations that I wonder we were so tardy in discovering it."

HOME DRESSMAKING AND DECORATING. However, not all of us have been so tardy, and I am thinking just now of a particular friend

of ours in whose home it is always a pleasure to visit. In this home are two very charming daughters, Dot and Margaret, aged 17 and 15. And would you believe it?—these girls have never worn a garment from a ready-to-wear department. Their mother makes everything she herself or her daughters wear, and they are known as the best dressed “three” in town. Of course, our friend’s sewing machine, or “The Woman’s Workshop,” as I have called it, is a marvel of completeness, being equipped with all the modern tools for making dress trimmings and other feminine things. There was a time when we had many a friendly argument on why a woman should or should not do her own sewing, but not any more. We are all on the same side now.

While our friend is a woman of considerable means, and could certainly go to her favorite shops and buy what she wanted, if she could find it, yet she prefers to make her own selection of yard goods, style it to suit her own or her daughters’ individuality, and be assured of the correct lines, color combinations, and quality of materials. And how she does insist on quality! “It is never necessary to accept a substitute,” is her uncompromising rule of purchase.

She is an unfailing source of information on what is the correct thing to wear at all times and for all occasions. She knows about the newest materials, where they can be bought, and what are to be the fashionable colors. She says, “It’s every woman’s business to know,” and I think she is right. The money spent on clothing for herself and daughters is her responsibility and she sees to it that it is wisely spent.

Regardless of how often we call, we are always due for a new surprise in what she accomplishes. One never finds her rushing here and there as so many of us do, and yet she is able to do so many things, seemingly with perfect ease. I have learned that what can be accomplished with a sewing machine doesn’t end in making beautiful sports and evening dresses for growing daughters. The house comes in for a “dressing up” now and then, and that’s where our friend furnishes so many surprises. On one of our trips to town, recently, we stopped in to have tea with her. She had just returned from a tour of the shops, matching materials, getting samples here and there and jotting down notes on pleasing color combinations and style trends.

Again I was seized with that old urge for an argument, and so in mock protest I demanded, “Now here—why do you go to all this

work making drapes, slip covers, and lord knows what when surely you can buy them in any drapery or house furnishing department?"

"Possibly so," she said, "but not just as I want them. What you see here isn't all new. I have only added to what we had, and changed the decorative scheme by shifting things about.

"I feel that, since these are the rooms we live in, we must have



FIG. 154.—Curtains "just to your liking" with the modern machine

a genuine liking for everything in them, just as we have for one another and our guests. Before making any changes—which I do often, believing that a shifting of scenes is good for anyone—I sit down and study the possibilities. In the end I may only change the slip cover on one chair, but even in so slight a change I must be satisfied as to the proper effect of color and design—something that will be complementary to the other decorations. Could I go down and buy that particular slip cover? Not a chance in a hundred; but yard goods, yes. There's so

much more to choose from—I can combine colors if I choose and style the cover to suit."

And then our friend continued, "You know how Dot loves frilly things, lots of them, so I decided to make her room more to her liking."

By this time we were in that young lady's room, and I was gazing at cool crisp organdie curtains. Fig. 154. They weren't at

all like the usual curtains one sees in the stores. I couldn't help but observe their evenness and that she had not skimped on materials, for the plaited ruffles, even with my knowledge of such things, were of a most pleasing width and fullness. Then I noticed the dressing



FIG. 155.—Any effect of feminine fancy can be obtained by the use of the various attachments

table in all its frills, Fig. 155, carrying out the same effect as the curtains and bed-spread, and the profusion of inviting cushions tucked about in cosy places. I would have known it was Dot's room. It suited her perfectly.

The decorations in Margaret's room were quite different, the most interesting being the tufted bedspread and drapes to match; also a screen and a chair with "moss fringe," as our friend called it. Fig. 156.



FIG. 156.—Other examples of home craft obtained by modern needle work methods

As we went from room to room and our hostess pointed out to us a new curtain here and something else there, she explained that it wasn't her electric sewing machine alone that made sewing so simple: it was the many attachments that come with the machine.



FIG. 157.—The "Singercraft Guide" in use

"You know," she said, "I have always made great use of these attachments, particularly since the girls were very small. Little girls' dresses must have tucks and ruffles, but I have found the Binder and Hemmers equally as important as the Tucker and Ruffler when making things for the home."

We found her very enthusiastic about a "Singercraft Guide" she had added to her collection of attachments for making rugs, fringes

and trimmings of all kinds, and she explained how the tufted spread and drapes in Margaret's room were made with this simple Guide. Fig. 157. She told us of her plans for a rag rug so easily made with this attachment, and, judging by the many ingenious creations this lady's sewing machine has been responsible for, I have no doubt this rug will be the envy of all her friends. Fig. 158.

I don't know when our friend learned to do all these things, but by her own statement it seems she has always known, and she claims there are literally thousands of women doing just what she is doing.

HOME SEWING COURSES.

Our friend then proceeded to tell us of the Home Sewing Courses that were available in every part of the country offered by a company whose name the world over had been synonymous with sewing to women of three generations. In the schools or service shops of this company, which are located in so many hundreds of cities and towns that no woman can fail to find one conveniently available, she informed us that expert teachers give free instruction in the use of the modern sewing machine and its attachments, help women to make the dress of their choice or any other articles with which they may need assistance.

"So really," she added, "there doesn't seem to be any excuse, any more, for a woman not knowing how to sew when there is so much



FIG. 158.—Rugs—Another home product of the modern sewing machine

written on this subject and information free for the asking. But just to convince you, and settle this friendly argument, I have here a set of instruction booklets which came with my new machine. I am sure you would find the subject quite in keeping with your electrical hobby, and if you would do me the favor of reading up a bit on this 'feminine lore' it will even the score between us. After all, it is no more than fair if you expect me to become interested in *your* precious electrical workshop!"

Man though I was, and much to my wife's amusement, I devoted the entire hour on the train ride back home to my first lesson in the



FIG. 159.—A complete course in dressmaking and home craft for the modern needleworker

art of sewing, and I must confess to so rapt an interest that if I had been alone, I would have been carried past my station!

"The course begins," one little booklet read, "with thorough instruction in the care and proper use of your sewing machine. The winding of bobbins, tension adjustments and threading are among the subjects covered. Next you will be taught how to use the Binder, Tucker, Hemmer, Ruffler and the other easy-to-use attachments which add so much to the finish of your garment."

Here was a home interest with which I was not familiar except in a general way, and yet it wasn't much different in principle from my own completely equipped workshop at home. This was certainly a woman's work-bench if ever there was one, and it gave me an entirely new conception of a sewing machine. In these attachments were the tools for every kind of stitching purpose—much like the wide assortment of cutting tools I employ with my electrically operated lathe and drill.

In another booklet of the series I read: "Sewing the modern way with perfected patterns, fabrics of beauty that can be bought at little cost, and a sewing machine with hidden power that responds instantly to one's wish, makes sewing recreational and intriguingly interesting. The creation of things that are both beautiful and useful is an art that every woman can master and enjoy."

With the evidence so recently seen at our friend's house I could well believe it, in fact I wondered how any woman found it possible to resist that appeal. Even I was tempted!

And so I take pleasure in reproducing in Fig. 159 the booklets which beguiled my journey—not alone the train ride to my home, but the excursion of unsuspected interest into unaccustomed fields of feminine arts.

OPERATION OF THE ELECTRIC SEWING MACHINE. It is not the province of this book to discuss in any detail the operation of a modern electric sewing machine, the principles of which are familiar to most, if not all, of my feminine readers. But for the sake of reviewing briefly the more important instructions and helpful hints contained in one of the booklets, I will mention here a few considerations about the operation of the modern sewing machine and the use of attachments which will serve as a partial reference to this subject.

It goes without saying that anything electrical or mechanical occasionally needs some slight adjustment, replacement or repair. This holds true, as I have already indicated, with respect to the electric wiring system, light bulbs and appliances. It is equally true in the case of the tools and equipment in my workshop; and the electric sewing machine, also, is subject to the same need for occasional attention and adjustment.

Good oil is most essential if you are to keep any piece of machinery running smoothly, and in the care of a sewing machine the use of only the highest grade of sewing machine oil is the first consideration.

Next, be sure that all lint from materials, threads and ravel are removed with a fine brush or soft cloth.

When you are certain that all moving parts of the sewing machine are cleaned, well oiled and smooth-running, the next thing of importance to consider is the needle. Much depends on a perfect needle of correct size for the thread used. If your seam shows skipped

stitches, the trouble can nearly always be traced to a blunt or bent needle, or else your needle is too small for the thread used.

Another annoyance is the breaking of thread. If the machine is properly threaded, again you can trace the trouble to the needle. Examine it to see that it is set properly, being sure that the sewing thread follows the long groove on the side of the needle. If the trouble is not here, perhaps the thread is too heavy for the size of the needle. Too many women do not consider the needle enough, and often use the same needle for months regardless of the material being sewed or the size of thread used. In order to ensure beautiful seams, great care should be taken to match the thread to the fabric and the needle to the thread.

A seam that draws or puckers is never beautiful. Also a tight thread is apt to break and allow the seam to come apart. This can always be avoided by being sure your stitch is not too long for your

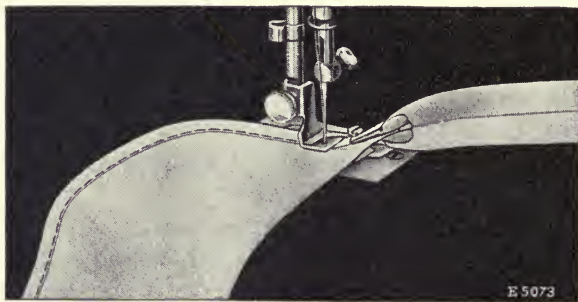

FIG. 160.—The binder

material, and that the tensions are even—that is, both top and bottom threads pulling with equal tautness.

“Looped stitches” appearing in the seam are usually due to improper threading, or to one tension being looser than the other.

So, you see, the common causes of machine troubles can best be avoided by first keeping the machine clean and well oiled; second, by being sure that the needle is perfect and of correct size; third, by correct threading; and last, by properly regulating the tensions.

WHAT CAN BE ACCOMPLISHED WITH ATTACHMENTS. I should not care to leave this interesting subject without mentioning again the attachments found in every sewing machine. They are little wonder workers. It doesn't matter how often styles change in

women's or children's clothes or home decorations—these attachments will always play an important part.

Let's take the binder for example. Fig. 160. There are always edges to be bound, and zip, with this attachment it's all done in one operation! Bound edges—think of them—too numerous to mention!

Then there are the hemmers—two of them: the foot hemmer, Fig. 161, for very narrow hems, about $\frac{1}{8}$ inch; and the other an adjustable one so as to make a hem any size from $\frac{1}{8}$ to a full inch. Fig. 162.

There are other ways of finishing edges, but one of the neatest is the narrow hem, and with the foot hemmer much time is saved. No tedious turning by hand and basting. The hemmer does all this for you, and in a short time you have yards and yards of hemmed material for ruffles. French seams are easily made in one operation. For sheets, towels, table linens, etc., requiring wider hems, the adjustable hemmer is used with the same ease.

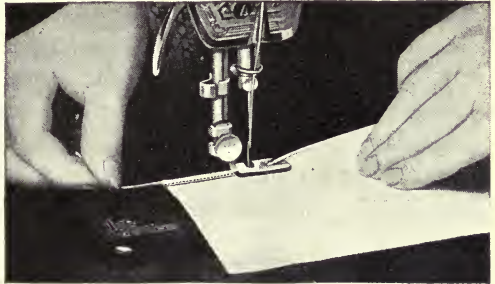

FIG. 161.—The foot hemmer

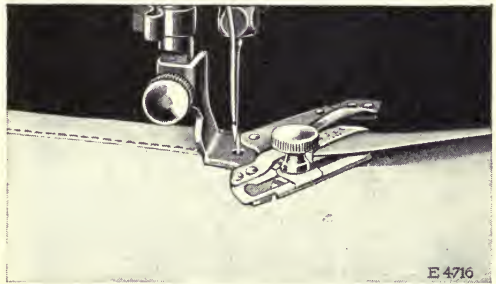

FIG. 162.—The adjustable hemmer

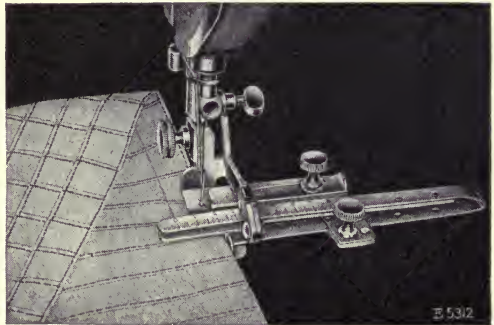

FIG. 163.—The tucker

The tucker is always fascinating. Fig. 163. Seeing the material pass between the levers and underneath the presser bar, with the dainty tucks so magically forming, it will impress you as something big and important. Tucking is a natural trimming which knows no seasons. It is always appropriate for children's clothes, lingerie, collar and cuff sets and many home decorations.

I have referred to bindings, hems and tucks, but ruffling, I'm told, is the best known of all trimmings. We can trace styles back to the time when every ruffle was trimmed with another ruffle, and there seemed to be no end of ruffles. And yet today we have an even greater variety of ruffles and more ways in which they can be used.

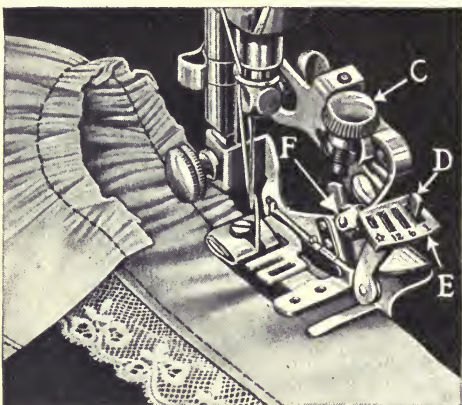

FIG. 164.—The ruffler

(Figs. 149-165 © U. S. A. 1923-29-32-33 by Singer Mfg. Co.)

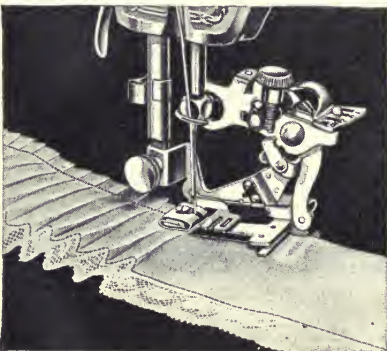

FIG. 165.—The ruffler used for plaiting

Fig. 164. The ruffler attachment not only ruffles but plaits. Fig. 165. Plaits may be obtained with every stitch or every 6th or 12th stitch as desired, varying in depth from $\frac{1}{16}$ to $\frac{1}{4}$ inch. Only slight adjustments are necessary for the many effects that can be obtained, thus making this attachment indispensable.

Those who desire to gain the fullest benefits from these attachments may obtain from the makers of this equipment very complete information which they are prepared to furnish.

To properly supplement this section on sewing electrically, it is suggested that you refer to page 195 on handling fabrics and pressing various materials; also the section on ironing, page 194, may be of interest.

GETTING THE MOST OUT OF YOUR TELEPHONE

Like the electric light, the telephone is a necessity as well as a convenience in any home. Here again, electricity is the agency that carries your voice without delay to your next-door neighbor, or to a foreign land thousands of miles away.

Because of the value and usefulness of the telephone, it is more and more important that the telephone instruments should be conveniently located and readily accessible to all members of the household. There was a time when one telephone was considered sufficient for the home. Today, however, the modern home has telephones conveniently placed in or near the rooms most frequently used, such as the living room, the bedroom and the kitchen.

The added convenience and the many steps saved by having at least one telephone on every floor of two-story and three-story homes is generally realized. For rooms used only occasionally, such as the guest room, the sun parlor and the game room, portable telephones are available which can be plugged into wall sockets and moved from one room to another as desired. Fig. 166. The hand telephone is modern and distinctive in appearance and provides added comfort and convenience while telephoning. Fig. 167.



FIG. 166.—The guest 'phone which may be used in any room desired by connecting to special telephone outlet

Various telephone arrangements are available which make the service more flexible and help to meet its many diversified uses in the home. These include arrangements to cut off certain telephone bells as desired. This feature and many others are contained in:

A NEW SERVICE FOR THE HOUSEHOLD. In homes where a number of telephones can be used to advantage, a new type of service known as the "Key Equipment" has been developed, enabling the user of each telephone to communicate direct with any other room where an instrument is installed. This is accomplished by means of keys located in the base of the compact and attractive hand-set telephone



FIG. 167.—The modern hand 'phone.
"One hand instead of two."

shown in Fig. 168. The keys are easy to operate and their functions simple to understand. The new system provides for either one or two outside lines and as many as eleven telephones may be included in the service. Following are the special features of this system:

Each telephone may make or receive outside calls.

Each telephone may make or receive inter-communicating calls with any other telephone, or signal by buzzer to all other stations on the premises.

When one telephone is connected to a line through the central office, all other telephones are locked out, thus insuring privacy and freedom from interruption.

Incoming calls may be answered at any telephone and transferred to another telephone, as desired.

One or two conversations over the central office lines and one conversation with another telephone in the home can take place simultaneously.

This system greatly simplifies the planning of the day's program, saves time and steps and results in a quiet, smooth-running household. From the telephone in the bedroom, orders may be given to the servants in the kitchen, the menu for the day arranged, and then,

over the outside line from the same telephone, orders for supplies may be promptly given to the tradesmen. From the telephones in the living room, library, or other locations, friends may be visited, appointments arranged, and business transacted quickly and comfortably with the assurance that no one can listen in from any other telephone in the house. Guests, too, will appreciate having a telephone for their own use.

The desirability of planning in advance for telephones is generally recognized by architects, builders and home owners. The location of telephone wires and accessory apparatus during construction results in general improvement of the homes, and better appearance is secured by con-

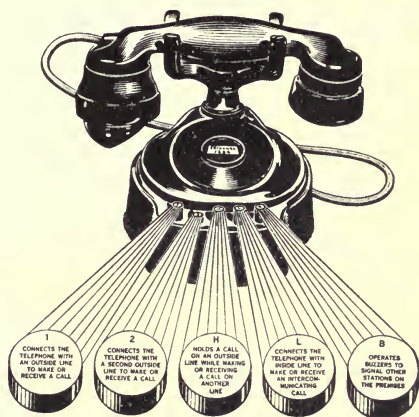

FIG. 168.—“The Key Equipment.” A new telephone service for the modern home

cealing the wires and some of the apparatus. This advance provision of telephone facilities is not difficult, expensive or complicated. It simply means the placing of conduits or pipes for the wires to the different rooms and suitable cabinets or outlets in the walls, so that telephones may be connected easily and the apparatus may be placed inconspicuously.

Space does not permit more details of telephone conveniences and I suggest that you get in touch with the local manager of your Telephone Company for further information. The Telephone Company offers ready assistance without cost in this planning and brings you the benefits gained by years of experience.

GETTING THE MOST OUT OF YOUR RADIO

Radio in the home, far from being a novelty or luxury, has reached the point where it has become an established necessity. There is no other agency which provides, in one instrument, the latest news, every form of entertainment and a world-wide library of educational and informational services of interest to every member of

the family—and all this at practically no cost other than the original purchase price of a good receiving set.

From the beginning, radio has been and continues to be one of the fastest moving developments in industrial history. Radical improvements have followed one another in rapid succession until today the modern receiver bears no more semblance to the earliest type than the modern automobile resembles the first horseless carriage. Broadcast transmission, too, has made vast strides in increased power and quality of transmission, giving wider and more efficient coverage.

It will readily be seen that to keep abreast of the great advances made in the art, the radio listener must provide himself with a truly modern receiver capable of bringing into his home, with the utmost fidelity, convenience and economy, the wealth of material which the broadcasters now provide.

In the matter of economy and compactness, even greater progress has been made by manufacturers, for the cost of radio has been steadily and drastically lowered and the external appearance of the home radio receiver has gradually taken more convenient and attractive forms, suited to every type of requirement.

WHAT RADIO TO SELECT. There are several factors to consider when selecting a suitable radio for the home. First, as a general principle, the instrument should be one produced by a reputable manufacturer of long standing; second, the performance capabilities of the instrument should be considered, for with the advent of the popular, tiny receiver designed to meet the need for an extra, inexpensive radio set for the maid's or children's room, the cabin or the summer bungalow, there is a wide variety in performance within a comparatively small price range.

Then, from the standpoint of the fastidious housekeeper, appearance and location should be the next important factors to take into account. A good substantial furniture type of receiver is recommended for the living room, to provide a high standard of reception for the family circle and for visiting friends. The smaller sets, although not equal in performance to the more substantial type of instrument, nevertheless have undeniable advantages of adaptability and convenience because of their compactness, so that they can be taken almost anywhere and set up for "supplementary" radio reception. Radio receivers are now available in a sufficiently wide variety of cabinets and woods to match in appearance and period design

Bi-Acoustic

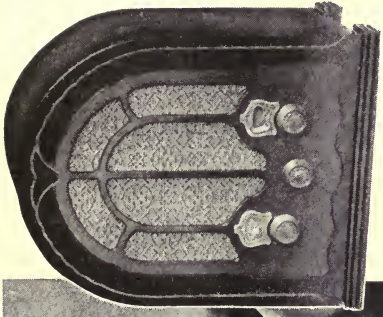
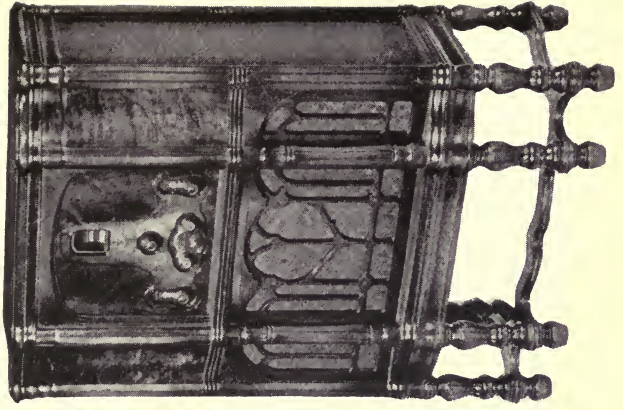

Caryette
Cathedral



Fig. 169.—Modern
radios

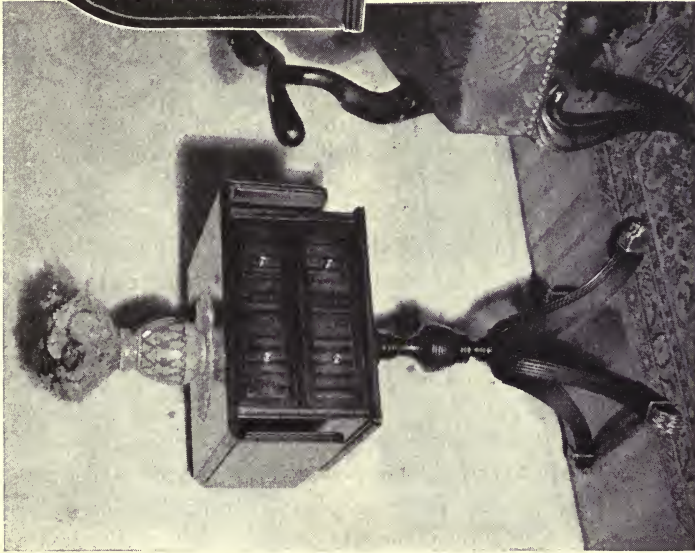

Duncan
Phyfe

practically any type of furniture for service in any room in the house.

If you are situated near a powerful broadcasting station which tends to blanket out the signals from lower-powered stations, it will be well to make sure that the receiver is one providing sufficient "selectivity" to tune out interfering stations.

In determining the performance capabilities of a receiver, the following points should be taken into consideration:

Selectivity. By this is meant the ability of the set to separate the different broadcasting stations without interference, one from another.

Tone Quality. This is the ability of the set to reproduce programs exactly as they enter the microphone in the broadcasting station. This is a very important consideration, for poor tone quality will spoil the best musical programs.

Sensitivity. This term means that the set should be able to pick out a large variety of stations. This feature is essential in locations having no "local" broadcasting stations.

Automatic Volume Control. A recent development that maintains the volume at a constant level regardless of the power of the station tuned in, whether distant or local.

Tone Control. A feature which permits the operator to adjust the programs so that the high and low ends of the tonal scale are emphasized when desired.

All of these features should be obtainable in the modern radio receiver, several typical types of which are shown in Figs. 169 and 170. Here again, it is important to bring to the attention of the radio purchaser that the presence of a well-known trade-mark of long and reputable standing is usually the best guarantee that the instrument will do all that is claimed for it.

SPECIAL CUSTOM-BUILT APPARATUS. For the larger and more luxurious homes, and where cost is of less consideration, there are available special built-to-order radio-phonograph systems. This type of installation usually takes the form of a centralized radio-phonograph mechanism, located unobtrusively in some part of the house,



FIG. 170.—
Smaller size
radios



Carryette, maple chest



Carryette, tambour front



Combination radio and phonograph

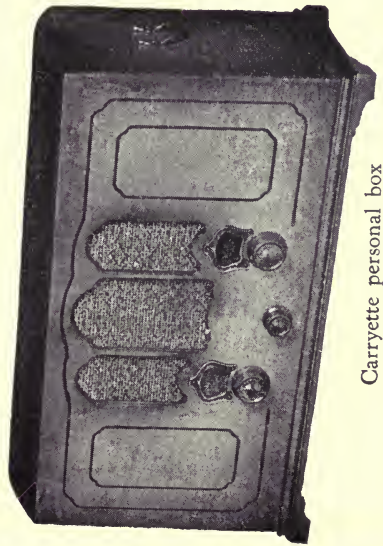

Carryette personal box

which system provides radio and phonograph programs to a multiplicity of loudspeakers concealed in various rooms of the home. Each of the loudspeakers may be individually controlled. Fig. 171.

One unique adaptation of such a system consists of a dial, similar to the automatic telephone, connected to the main radio-phonograph instrument. By dialing coded numbers, any station may automatically be tuned in at will, the volume raised or lowered, the automatic phonograph mechanism set into motion, or even a record rejected, if desired. These dial controls may be placed in any room in the house.

By means of an inexpensive time clock arrangement, the radio receiver may automatically be turned on at a given hour in the morning and shut off at any time desired.

THE NEW ELECTRIC PHONOGRAPH. Since the spectacular advent of radio, a large portion of popular interest has been diverted from the phonograph and it is a surprising fact that the great majority of music lovers are unaware of the remarkable advances which have been made in phonograph recording and reproduction. In this field of development, also, the same electrical technique which makes possible the present day radio, has been applied to the new-day, revived phonograph. The range of audible tones which can faithfully be reproduced has been increased to a remarkable extent. Electrical amplification provides a range of volume from the merest whisper to the full sonority of a symphony orchestra. Record materials have been improved so that surface noises have been considerably minimized, and a recent development in recording has produced the new so-called long-playing record which is capable of reproducing up to fifteen minutes of music on each side of the record.

These new records are played at a lower turntable speed, and all the new electric phonographs make provision for utilizing both this new speed and the faster speed for playing the ordinary records. Then too, for the more expensive instruments, automatic record changing devices are now in general use, which are almost human in providing continuous programs lasting for over an hour.

AUTOMOBILE RADIO. Radio has been constantly widening its scope of usefulness and, recently, we have seen its widespread adaptation for use in the automobile. Manufacturers have finally produced a compact receiving unit, containing radio chassis, loudspeaker and eliminator in one tiny case, which can easily be installed in any type of car. Fig. 172. The control units, providing tuning

Programs from selected stations may be dialed at will from various locations in the house. Reception is obtained through a loud-speaker system

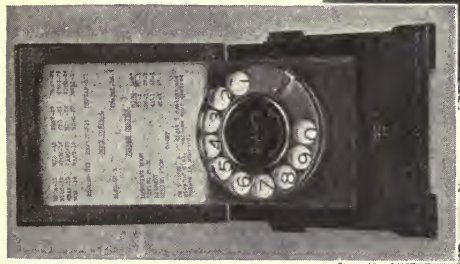
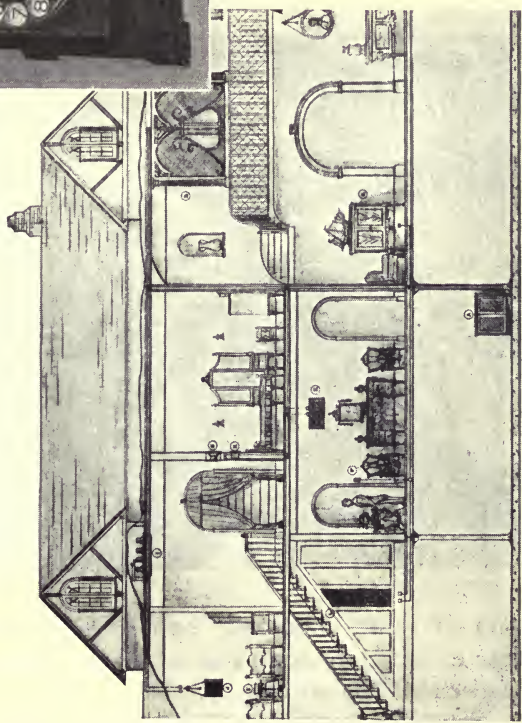

FIG. 171.—Custom-built radio installation with remote control



and volume controls, are usually attached in a convenient position on the steering post. Modern automobiles are equipped with an antenna concealed in the top of the body, all ready for radio installation. "Ground" is obtained by connection to the car frame.

This radio is doing much to dissipate the monotony of the long automobile journey. It also provides a convenient means for keeping in touch with news and radio events on vacation or business trips.

FIG. 172.—The automobile radio. At "A" is shown tuning and volume control with switch for locking. (See insert.) Arrow at lower right hand corner indicates radio set

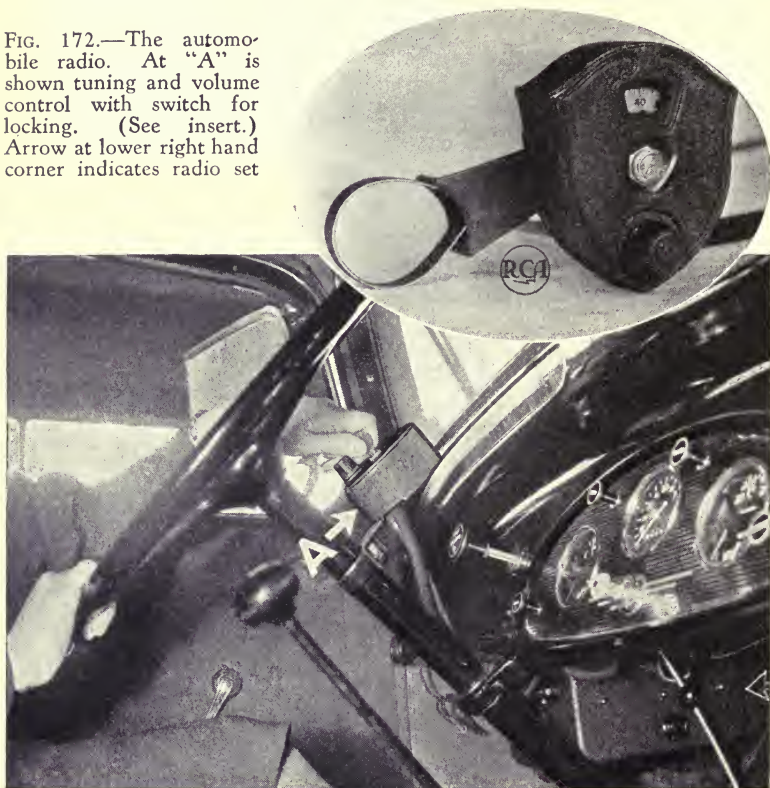

INSTALLATION OF THE RADIO. Any radio installation should have its proper electrical connections the same as for any other type of electrical apparatus or appliance.

You have already seen, in Fig. 16, page 56, a special plug used for connecting the radio set to the electric highway and also to the

antenna, or outside wire, and ground. If the radio is moved about, or its location is likely to be changed to conform with a rearrangement of furniture, several of these plugs may be installed. If you are using a battery set, you may have all the batteries located in some out-of-the-way place, such as in the basement or a closet, using the same type of convenience outlets that I have already mentioned. Batteries should be placed as near the radio set as possible to avoid long wiring connections.

If the radio is one of the modern all-electric sets, it should be connected to either the special plug just referred to, or to one of the regular convenience outlets or baseboard sockets provided for the connection of floor lamps or appliances, and located close enough to this socket so that the power cord furnished with the radio set will readily make the connection and without necessitating an extension.

Since moisture or dampness is harmful to any electrical apparatus, your radio should always be located in a dry place, and the cord should be kept off the floor.

Careful thought should be given to the aerial and ground connections which are used to pick up and transmit radio signals to the receiver. When an outdoor aerial is used, from 50 to 200 feet, a high wire removed as far as possible from electric light or telephone wires, is desirable. It does not matter a great deal what kind of wire is used provided it is strong enough to hold the weight of the down-lead, or lead-in wire, and to withstand the strain of wind and weather. The aerial wire should not be connected to a tree if it is possible to avoid it. If you are obliged to connect the aerial to a tree, however, it may be well to use a spring between the tree and the aerial to absorb the strain on the wire when the tree sways.

In order to comply with insurance requirements, it is necessary to use an approved type of lightning arrester when you have an outdoor aerial. The lightning arrester is a small device which should be fastened on the outside wall at the point where the lead-in wire from the aerial is brought into the house. Fig. 173. The lightning arrester is provided with three connections, one going to the aerial, one to the radio set and the third to the ground. Do not economize by buying a cheap lightning arrester. Be sure that the one you use is approved by the Underwriter's Laboratories, and in any case follow the directions furnished by its makers. The ground connection for

the lightning arrester should be a pipe or ground rod driven into the earth directly underneath the lightning arrester.

To complete the radio installation, a wire should be connected from the ground terminal or wire of the radio set to a pipe or other metal object making good contact with the earth. Generally a cold water pipe provides a satisfactory ground connection. A sheet of

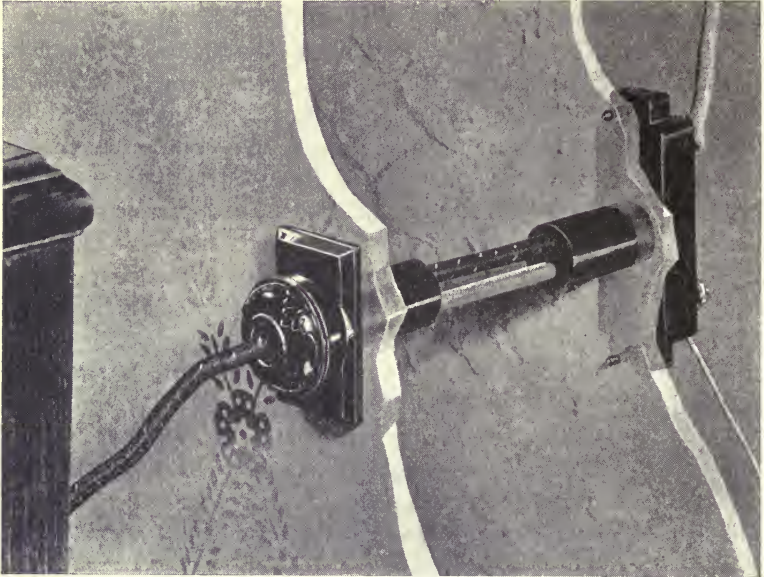

FIG. 173.—Suggested arrangement of radio aerial and ground wires. The lightning arrester is installed on outside wall of house. (Shown at right) (Woodruff)

metal with a wire connected to it, thrown down an old well or cistern, often provides an excellent ground for the radio. Avoid the use of a steam pipe or gas pipe since it makes a poor connection with the ground and may be extremely noisy, thus interfering with the operation of your radio.

RADIO NOISE. After you have installed your radio set in accordance with the preceding suggestions, you will expect, of course, to enjoy radio programs. At times, however, you may find that in addition to hearing radio programs you hear a great deal of noise such as rattles, buzzes, clicks and crashes. Some of these noises may be caused by electrical disturbances present in the air such as thunder

storms, northern lights, etc. There is nothing you can do about these noises except turn off the radio and wait for the atmosphere to clear. Most of the noises that you hear, however, are caused by loose or intermittent connections, such as electric light switches, telephone dial contacts, sign flashers, certain types of motors and many household appliances. These noises can be kept out of your radio. In the early days of radio it was thought that much of the noise was due to troubles arising from operation of electric power lines. While in the beginning this was partly true, today, through the combined efforts of lighting companies and apparatus manufacturers, such

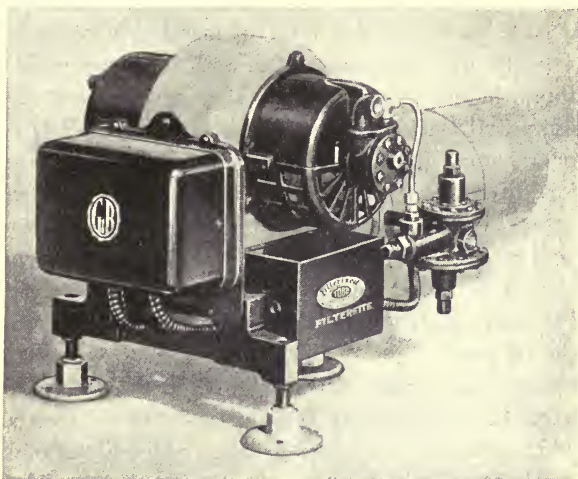

FIG. 174.—Installation of a "Filterette" for suppressing radio noise at the source

causes as may have existed have been practically, if not entirely, eliminated. It is much more likely that any disturbances you now experience from the electrical system occur within your own or your immediate neighbors' homes, rather than on the outside lines. Household appliances connected to home electric highways are servants over whom power companies have no control and their occasional "pranks" must be curbed by their individual owners.

It is a simple matter to suppress radio noise at the source by applying suitable devices, such as a "Filterette." These devices are fastened directly to the apparatus causing the noise, and they keep the noise from being carried out on the electric light wiring. Fig. 174

shows a typical filter installation which confines noise to the point at which it starts.

Although you can easily suppress the noise from your own apparatus, it is not always easy to persuade your neighbors to quiet their electric "servants," so you may find it necessary to take special care in installing your radio set to make sure that noises are kept out of it. Scientific investigation has shown that when a good outdoor aerial is used, the aerial itself picks up radio signals practically without noise and that most of the noise heard in the radio is picked up on the lead-in wire which connects the outdoor aerial to the radio set. In order to prevent this noise pick-up, it is necessary to shield the lead-in wire: that is, to enclose it in a layer of metal. Wire especially constructed for this use is now available and, when properly installed, is being found highly satisfactory for keeping noise out of the radio set. This filterized shielded wire alone is not a cure-all. In fact, if it is not properly used, it may eliminate the radio signal as well as the radio noise. In order to prevent the signal loss, special connecting units must be used for fastening the filterized shielded lead-in wire to the aerial and to the radio set. Fig. 175 shows a typical radio installation with filterized shielded lead-in wire and connecting units. This lead-in wire, with the necessary antenna and receiver units, is available in kit form.

With many radio sets, noise may enter the radio through its connection to the power line. If this appears to be the case, a properly designed filter unit connected between the radio and the power socket will do much toward eliminating the noise. A properly designed unit contains choke coils and condensers and is so constructed that it does not interfere with the operation of the radio.

IMPORTANCE OF REGULAR RADIO INSPECTION. No matter how much care is taken in the original installation of the radio, or in the application of filterettes and filterizers to keep radio noise out of the set, regular inspection is advisable. In order to get the best out of your radio set, a competent radio service man or dealer should be called in for a complete inspection at least once a year. The radio tubes should be tested every six months. It is not economical to neglect tube replacements.

RADIO TUBES. Radio tubes may be considered not only the heart, but the brains and other vital organs of your radio as well. Regardless of the make or model of the set you are using, it is no better

than its tubes. These compact devices, properly made, require an exceptional degree of manufacturing skill and an intensive program of testing in order that they may perform their functions creditably. Consequently, it is wise to exercise great care in buying tubes, as

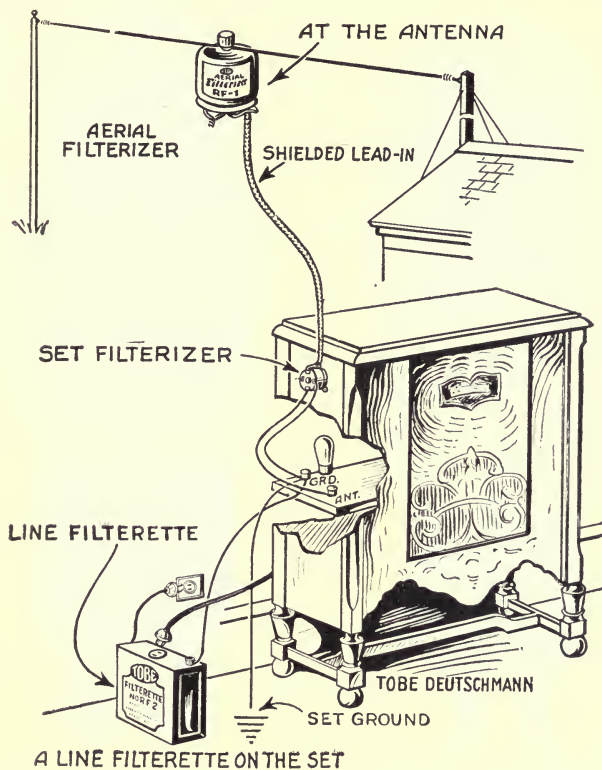
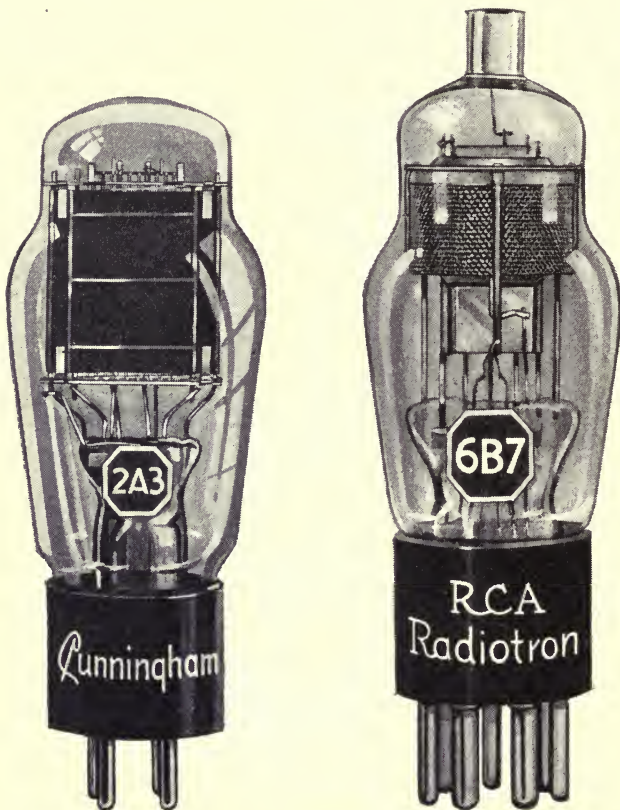

FIG. 175.—Typical radio installation showing filterized connections for eliminating undesirable noises

well as to give the tubes proper attention while they are in your radio set.

There are many types of radio tubes, each identified by a type designation consisting of a number, or a combination of numerals and letter (Examples: 24-A, 35, 12Z3). Your radio has been designed for particular types, and these types should always be used in the sockets intended for them. Sockets in most radios are marked to correspond with the tube types required. With a few exceptions the



C-2A3—This power output tube of unique design is largely responsible for the exceptional tone quality and power of certain modern receiving sets

RCA-6B7—This modern receiving tube is capable of performing four distinct functions simultaneously

FIG. 176.—The "heart" of radio

There are more than 75 types of radio receiving tubes. The two shown are among the most modern. Older types continue to be made by modern methods

type numbers used by various manufacturers are the same, or at least the last two digits and following letter are the same (Example: RCA-71-A is interchangeable with FY-71-A, RCA-27 with MZ-527, etc.). In case of doubt, consult a reliable dealer or service man.

New tube types are frequently introduced to enable set designers to design more efficient sets. In general, these tubes are not intended to replace earlier types or to be used in sets previously made. However, the manufacturer of good tubes never stops improving the older types, so that the buyer of a standard brand tube is assured of a modern, improved tube, regardless of the type.

Unfortunately, radio tubes do not last indefinitely—they wear out in use. This is due to the active substance on the filament or cathode being used up, a process essential to the functioning of the tube. Worn-out tubes may be at the seat of many radio ills, such as faint signals, distortion, noise, etc. The deterioration is very gradual and depends on the length of time the set is in use. To insure continuously satisfactory service from your radio, it is advisable to have a reliable dealer or service man test the tubes about every six months—or whenever the set does not appear to be functioning properly. Free testing is a service now offered by practically all agencies selling radio tubes.

Only one precaution need be observed while removing tubes from, or returning them to, their sockets: *Be sure the set is disconnected.* The metal containers used in the set to shield the tubes electrically are easily removed by pulling upward.

Typical radio tubes are shown in Fig. 176.



PREPARATION FOR THURSDAY'S JOURNEY

Maid's Afternoon Out! What a confusing interlude of interrupted service that good old custom has occasioned in most households in years gone by! Not so, however, with the Day Family. We found them all happily employed and far more tranquil than if they had a houseful of servants of the human variety to wait upon them.

Our very first experience in calling at Thursday's Room gave promise of a delightful visit, for we were accorded a musical reception. But we will come to that presently as the story of our journey unfolds.

The Day's eldest son, who was the electrician of the household, was busily engaged in his favorite hobby, just now checking over the signal and alarm systems to see if everything was shipshape.

"It's one of the most important considerations of any service highway," he said, in answer to our query about some clock mechanism he was adjusting, "to make certain that the traffic signals work properly. And in the case of the electric highway of the home, as well as of the grounds about the home, there is the same need of what I call 'police protection' as on our public roads.

"But wait!" he continued, evidently sensing that the purpose of our visit was to learn something about the electric service which came under his particular supervision. "Since you are curious as to how we can still be most efficiently served and protected in spite of a 'Maid's and Man-Servant's Moratorium,' suppose we take up the discussion of the day's program in an orderly manner."

THURSDAY'S PROGRAM

KEEPING TIME ELECTRICALLY.

TIMING DEVICES FOR AUTOMATIC REGULATION AND
FUNCTIONING OF ELECTRICAL EQUIPMENT.

HOME SIGNAL AND ALARM SYSTEMS.

FUNCTIONS OF THE ELECTRIC FAN.

KILLING INSECTS ELECTRICALLY.

LIGHTNING PROTECTION.

OUT-OF-DOORS ELECTRICALLY.

MISCELLANEOUS ELECTRICAL EQUIPMENT.

What sources of current may be used to operate a signal system?

For more pretentious homes, or where more extensive systems of intercommunication are desired, what three types in addition to bell and buzzer systems are available?

In what ways can electric chimes be employed?

What three general systems of burglar alarms are obtainable?

What six precautions should be observed with reference to the proper installation of lightning rods?

Do you know that electricity within the home does not endanger you during thunderstorms?

What are some of the practical uses for an underground wiring system for out-of-door service?

What alarm systems and applications of the time switch are mentioned in the "Prologue"?

How many special duties can you think of where time switches and other regulating or automatic devices would be of enormous advantage to you in matters of daily routine? Several applications are mentioned in the section which follows. Also in the section on Cooking Electrically (See Friday's Journey). Throughout the entire book there are many references to time switches and their uses.

What applications of the electric clock would be useful in your home?

THURSDAY'S JOURNEY

KEEPING TIME ELECTRICALLY

With the tempo of present-day social and business life accelerating at a pace where our daily schedules of routine duties, engagements and even pleasures must be maintained with split-second punctuality, the need of exact and dependable methods of keeping track of time is hardly debatable.

An old-time horse and buggy plodding along in the inside lane of modern traffic is not a whit more out-of-place, when you stop to consider it, than an old-fashioned laggard timepiece holding up the procession of the speedy and efficient electric appliances which serve our homes today so punctually and dependably. It is also just as illogical to depend upon old-fashioned clocks which have to be wound and regulated and constantly checked for accuracy, as to continue to employ the old phonograph for musical entertainment when all the advantages of the radio and modern electric phonograph are available—and at far less cost.

With the advent of "regulated frequency," as now furnished by lighting companies practically everywhere, it has become possible to utilize the exact pulsations of alternating current to operate synchronous electric clocks with a precision that is almost beyond imagination. Just think of being able to maintain time to within a small fraction of a second—day in, day out forever—without any winding, adjusting or attention, and for a current cost that is negligible! The lighting companies now send you over the electric highway of the home absolutely accurate time, by means of regulated frequency, as a part of their modern service—and without any charge for it whatsoever.

Everyone is, of course, familiar with the way an ordinary clock operates. A mainspring furnishes the power and keeps the clock going for a day, or several days, as the case may be. Besides this power, a regulating system must be provided so that the hands will turn at exactly the same speed at all times. The electric clock is entirely different for, in place of the mainspring, a very small motor is used—probably the smallest commercial motor known, for it delivers only one-millionth of a horsepower! This small motor is called a synchronous motor due to the fact that it runs at exactly

the same speed (or a multiple of the speed) as the electric generator supplying your home with electricity.

It may be of interest to you to learn how the lighting companies maintain the generator speeds in the power house at a constant value so as to provide you with absolutely correct time. First, did you know that the great telescopes of the country's observatories take the time from the stars? It is from one of these sources—the United States Naval Observatory, at Washington, D. C., from which comes our official government time—that the lighting companies receive the exact time, broadcast by radio signals. In the power station is a master clock which is kept accurate according to these signals, and by means of this clock an expert controls the number of impulses of the current. Your own electric clocks in the home, with their synchronous motors, are in turn controlled by these impulses. Therefore, your electric time in the home is maintained with the same accuracy as the master clock at the power station and with the same accuracy as Government Observatory calculations. *Hence it is as infallible as the stars!*

While the electric clock never needs to be wound, it must be connected to a source of alternating current supply. For use on a direct current system an ordinary type of household clock is sometimes used, with a small motor automatically winding the mainspring. In other words, it is a self-winding clock.

Electric clocks are made in a variety of styles, finishes, sizes and models for every room and location, as well as to conform with any decorative scheme, or to satisfy special individual tastes or ideas with reference to unusual applications. For example, electric time may readily be incorporated in a radio receiver for your greater convenience and certainty in bringing in scheduled programs, or it may be incorporated in some existing article of furniture by installing the electrical movement and dial without the clock case. It has such flexibility of application that any number of convenient locations may be devised for electric time that would not be found possible with ordinary clocks.

There is a most unique and direct method of telling time electrically now receiving wide attention—not only for the home, but for clock towers, public buildings, factories and general commercial use—which may revolutionize all previously established ideas of telling time. This new design of electric clock is known as “The

Minitmaster," and it gives you the exact time by numeral indication without any dial or hands at all! This is a handy type of clock to install in the home, since it avoids any possible confusion of hour and minute hand, and enables children to tell time instantly and accurately by means of numerals with which they are familiar. It is also a most convenient type for the business office where scheduled appointments are kept track of much like a railroad bulletin board—by numerals only. This type of clock almost *speaks* to you, minute by minute warning you *in direct figures* of the passage of time. In the "Minitmaster" design there is a still further feature of interest, for the seconds pass in review on a revolving disk which gives you the last word, or I should say "the last numeral," in the electrical meaning of accuracy!

It must be remembered that among the various makes of electric time clocks now on the market there are two distinct types. One of these types, while it is operated by a synchronous motor, is not self-starting should there be a momentary current interruption. It remains stopped until manually started again. An alarm clock of this type, for example, may stop during the night and stay stopped, thus giving you no alarm whatsoever in the morning.

The other type of clock is operated by a self-starting motor, so that it starts up again automatically after a short current interruption. There is another thing about this improved type of electric clock which especially recommends it. It is provided with a little red disk which turns on the instant that a current interruption takes place. It is like telling you, "I am an honest clock—my accuracy has been impaired by a little interruption—you had better check me, for perhaps I am a half-second slow!"

There are two kinds of alarm clocks available in the self-starting types—the 12-hour model and the 24-hour model. With the latter type, if you set the alarm for seven o'clock in the morning, you merely press a trigger and it stops. But tomorrow morning it goes off again just the same, the alarm being omitted during the evening. In other words, it is provided with an automatic resetting device.

Both models are furnished with illuminated dials, if desired, so that you may conveniently tell time at night. These dials serve as very practical "night lights," the total current consumption of such clocks being so small as to be almost negligible in cost of operation.



The "Bullfinch"

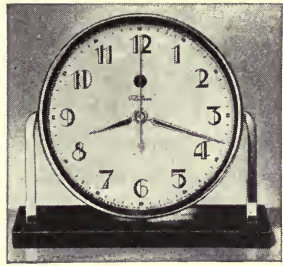

The "Telart"



The "Huntington"



The "Consort"



The "Minitmaster"



The "Daphne"

FIG. 177.—Typical "Telechron" clocks

Several attractive models of table, desk and wall clocks are shown in the illustration of typical electric clocks, Fig. 177. Particular attention is called to the many types for all locations. Some models are provided with an auxiliary spring movement which maintains the correct time for a period of about two hours—long enough to bridge the gap of the most serious interruption of current which is ever likely to take place. This same feature may also be obtained in grandfather and mantel chime clocks.

Grandfather and Mantel Chime Clocks. There is no article of furniture in the entire home which so nearly approaches kinship with one's family in a traditional sense as the grandfather clock. Its measured "tick-tock, tick-tock" suggests the stored up secrets, incidents and romances of American family life back to the landing of the Pilgrim Fathers. If only its sonorous tones might be interpreted in a language we could understand! Longfellow's poem of "The Old Clock on the Stairs" is a beautiful and enduring reminder of the place which the grandfather clock has occupied for generations past in the intimate sanctuary of the home. Patiently tolling the hours from early Colonial days to modern times, its yellowing face and hesitant, tiring hands are at length giving evidence of the wearied wooden movement within. And now, after long years of faithful vigil, it is content to pass along its rich heritage of service to its deserving heir and grandfather of generations yet unborn—the electric clock.

In Fig. 178 are shown typical designs of hall or grandfather clocks with the famous Westminster and Canterbury chimes. Whittington chimes are also available in some clocks.

The story of how these chimes came by their names may be of interest. There is a difference of opinion about the Westminster chimes although it is generally accepted that this carillon was composed by a celebrated professor of music named Doctor Randall who conceived the theme from the fifth bar of the opening of Handel's Symphony: "I know that my Redeemer liveth." They were first fitted into the tower clock at the University Church, St. Mary's the Great, in Cambridge and were later reproduced on a large scale in the Victoria Tower Clock of the House of Parliament.

A craftsman visiting England was responsible for the Canterbury chimes, this being his way of expressing admiration for the famous cathedral.

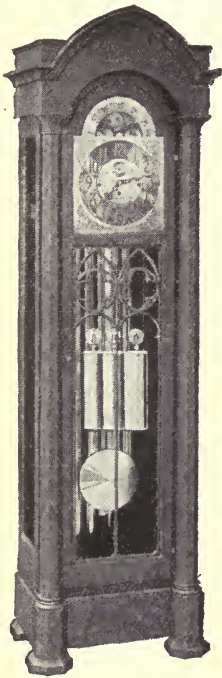

"Orne" hall clock,
gothic style,
Westminster chimes

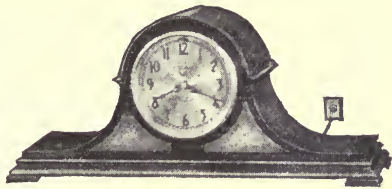

Mantel clock with raised numerals,
Westminster chimes



Mantel clock, gothic style,
Westminster or Canterbury
chimes

FIG. 178.—Typical examples of electrically operated period design hall and mantel clocks with "Telechron" movement and chimes

The origin of the Whittington chimes comes down to us in the quaint legend of a poor boy, Dick Whittington, who, in his escape from the drudgery imposed upon him in his master's household, paused at the first milestone to listen to the chimes which came from the city he had just left. They seemed to say to him, "Turn again, Whittington, Lord Mayor of Londontown." The chimes which came to bear his name were first rung in the Church of St. Maryle Bow, in the fourteenth century.

The electric grandfather clocks combine these beautiful chimes in varying arrangements according to the model. In one of the many period designs all three chimes are obtained, with nine tubular bells chiming all quarters. Four bells are used for the Westminster, six for the Canterbury and eight for the Whittington, an extra tubular bell of deep tone being used for the hour strike. There are also two-chime and single-chime clocks, clocks with moon dials which register each lunar phase from new to full moon, third quarter, old moon, etc., and many other models whose dials are beautifully etched and finished in hand-spun silver, with enamel inlays and raised bronze numerals. Whether in the period designs of master-craftsmen of a bygone age or in the modern conventional models, all of these clocks combine a perfection of artistry with an accuracy of time-keeping which accord them a place of delight and interest among the prized possessions of the electric home.

Mantel clocks with chime movements are also available, differing from the floor models, however, in that they are furnished with chime rods instead of tubular bells. Fig. 179. In these designs, in some clocks are combined both the Westminster and Canterbury chimes, while others have only the Westminster chimes, the chimes playing at all quarters, and the hour striking as a harmonious chord. In all models, both floor and mantel, the chimes can be either changed or silenced. There is also a self-adjusting chime feature which insures the correct sequence of notes at each quarter as well as a dial signal which shows red when there is a service interruption.

Keeping time electrically is now accomplished so simply and inexpensively that there is no excuse for being without absolutely accurate time. Provide for electric clocks in every important location in the home—hall, kitchen, living rooms, bedrooms, as well as the porch and garage. This means providing suitable convenience outlets.

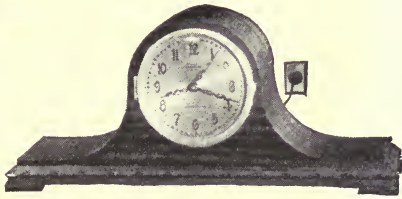

Mantel clock, colonial style,
Westminster chimes



Mantel clock, gothic
style, Westminster
chimes

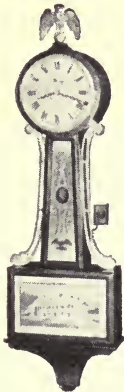

"Washington Bi-Cen-
tennial" wall clock,
Westminster chimes

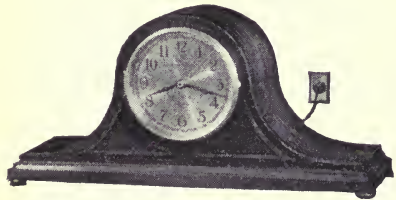

Mantel clock, Westminster chimes

FIG. 179.—A few of the many attractive designs of wall and mantel clocks with "Telechron" movement and chimes

TIMING DEVICES FOR AUTOMATIC REGULATION AND FUNCTIONING OF ELECTRICAL EQUIPMENT

The use of time switches in industrial and commercial establish-

ments is well known, but lately they have found many uses in the home. Where lights are to be turned on or off at a certain time, or for some other function where definite hours are to be kept, the time switch will perform this service. In many cases they have been made a part of the control equipment such as is used in heating systems, electric ranges, etc. The time switch in a heating system will start the furnace going in the morning at any predetermined time and will

prevent the furnace from operating at night when there is no necessity for keeping the house up to its full daytime temperature. The time switch is also combined with electric ranges for automatically controlling the oven, etc.

A time switch, as its name implies, is the combination of a clock operating an electric switch. Such switches may be used to make an appliance automatic as far as timing is concerned.

There are several portable types which work in connection with a clock and may be either

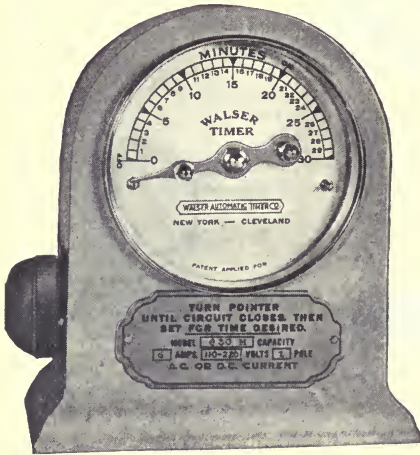

FIG. 180.—Portable time switch for disconnecting circuit automatically after a fixed time interval



FIG. 181.—Wall type time switch with same action as switch shown in Fig. 180

set on a table, Fig. 180, or mounted on the wall, Fig. 181. These switches are usually connected into the circuit between a convenience outlet and the device to be controlled and will turn the electric current off at whatever time is desired, up to an hour. For example, the switch may be set to turn off the current of a cooker or other appliance at any time desired within reasonable limits

Another form of time switch, shown in Fig. 182, may be mounted in a regular outlet box in the wall, or provided with a base it may be used as a portable timer. This switch will turn the current either on or off as desired at any predetermined time. It may also be set to operate as an ordinary switch by locking the timing feature. Both of these time switches must be set by hand for each particular operation they are to perform.

There is still another variety of electric time switch, Fig. 183, which winds itself. This particular type of switch is entirely automatic and will turn on and off a circuit one



FIG. 182.—Combination time switch for permanent installation



FIG. 183.—Automatic self-winding time switch for complete circuit control. This switch will continue operation if current supply is interrupted, so that the timing schedule is not disturbed

or more times during the day and repeat this function for every day in the week without attention. It is, however, so arranged that if the particular function is not desired on some particular day such as Sunday, the clock will automatically omit operating the switch on that particular day. This feature may be extended to any day in the week, or for several days as desired. This switch contains a clock mechanism so as to continue its operation for at least ten hours in case the electrical current is interrupted. Such switches have many uses and may be employed as part of an appliance or used separately. Time switches may also be operated by hand, if desired.

The usual time switch designed for continuous service has a switch operating system for turning on the electric current for definite periods of time. When defrosting the refrigerator the reverse of this operation must be used since, in this case, the electricity must be kept off for a short time.

The time switch illustrated may be used for keeping a circuit on, except at desired predetermined intervals, as well as off, and is called a "Defrosting Switch." It is used with the refrigerator.

In cases where the refrigerator is not supplied with a drain for carrying off the water from the cooling unit, it is best to have an indicator light or buzzer to warn when defrosting starts. In such cases the time switch should be set on a day and time when someone is sure to be near the refrigerator so that the cleaning may be done at this time.

Space does not permit going into the details of these timing devices, but it can safely be said that there is a particular type of time switch available which will provide for practically any function that may be desired in your home.

HOME SIGNAL SYSTEMS

Many homes of today are modern in every respect with the exception of a convenient signal system. A short time ago I inspected a house which had just been completed at a cost of nearly \$50,000. This home was modern in every respect, having an oil burner and an electric dishwasher, but for a signal system it had merely a back and front doorbell and a buzzer for the dining room. No means of communication were available for calling the servants from any of the various rooms.

To have installed a proper system in this house when it was originally built would have cost not over \$25.00 at the most. The occupants of the house will have to put in some kind of signal system for calling the servants from various quarters, but the cost will probably be double. And, too, it is more difficult to make as neat an appearing installation after the home is finished. The expense of a first-class signaling system is no greater than that of one of poor quality, and whatever installation is made should be of lasting quality and dependable service.

The improvements in signal systems in recent years have fully kept pace with other household developments. For the average house the signal system is very simple. About all that is required is a push button located at the front door, one at the rear door, and a third one connected with the dining room. The signalling devices for all three of these call buttons should be located in the kitchen and should have different tones which are entirely distinctive. A mellow-tone single-stroke bell is best for the dining room, and it should make only sufficient sound to be heard in the kitchen or the pantry, where the maid would naturally be during meal hours. In any event, it should not be so loud that the diners know when the maid has been called. One of the most convenient arrangements for the dining room signal is by means of a small foot-treadle placed underneath the rug. This does away with the necessity of making any holes in the rug or of having an extra cord fastened to the table. For the back door, a buzzer will give a distinctive tone that cannot be heard at too great a distance. For the front door, a vibrating bell should be used which has an entirely different tone from the single-stroke, mellow-tone gong used for the dining room.

This entire system should be installed just as carefully and permanently as the regular lighting system. The current for operating the bell system, while it comes from the regular electric light current, has a pressure or voltage (8 volts) reduced by means of a small transformer which is contained in an outlet box, together with the



(Edwards)

FIG. 184.—Complete household signal system contained in same housing as convenience outlet. It is known as the "Flushcall System"

signal bells, as shown in Fig. 184. The transformer then becomes the source of power and is located with the bells in one box, which is mounted flush with the wall. Such an arrangement makes a neat appearance, is substantial, and in case of trouble all equipment may conveniently be reached.

In cases where the electric light current is not available, the ordinary dry cells may be used for operating these signal systems. Dry cells will usually last a year, and oftentimes much longer.

Wires for connecting the bells to the various push-buttons should be carefully installed, kept away from any dampness, and protected

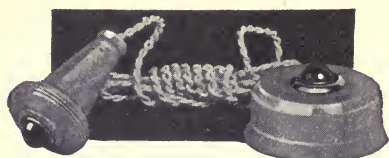

(Edwards)

FIG. 185.—Fancy push-buttons for portable use

against mechanical injury. We have a choice of some very attractive portable push-buttons for use on a table or desk. Fig. 185. Such push-buttons are connected to a wall outlet by means of a flexible cord. The flush type of push-button is usually used, and some of

these are furnished with fancy crystal centers representing precious stones.

In larger homes where it is necessary to have more than the three signals from the dining room and the two doors, an annunciator should be used. This annunciator, illustrated in Fig. 186, should be separate from the other door-bells and buzzers and should be connected with the various rooms from which the servants may be called.

Modern annunciators have printed upon them the room from which the call is made. The annunciator shown is of the flush type. It may be placed in the kitchen and it does not in any way mar the appearance of the room.

In large homes a duplicate of this annunciator should be placed in the servants' quarters, and both annunciators may be reset by means of a small push-button located at either or both stations.

Practically any kind of signal system can be arranged to meet your convenience. You may use bells, chimes or lights for giving signals, or all in combination. It is simply a case of knowing what you want and your electrical contractor can easily meet your requirements, and without any great expense.

ELECTRIC CHIMES. Characteristic of the many innovations which not only are beautifying and modernizing the home, but are revolutionizing earlier methods of performing electrical services where the mere utility or act received consideration in advance of the refinement or art of execution, is the Electric Telechime Call System.

I can think of no better example to cite by way of illustrating the latter-day progress being made in the direction of adding charm and artistic finality to the practical side of home electrification than

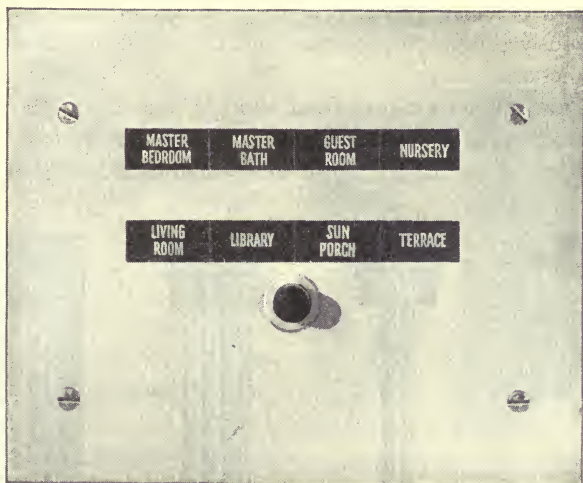

(Edwards)

FIG. 186.—Typical flush type annunciator for home use

this tonal contribution to the already existing harmonies of effortless operation and economy-comforts now so greatly desired.

With the introduction of this Telechime system there is made available for all home signal needs a melodious call-service of restrained cathedral dignity. Wherever installed there is a gratifying absence of nerve-fatiguing noises of constant daily irritation and in their place are calm, mellow tones of pleasing musical variety tolling out their delightful cadence in happy summons to front, back or side door, telephone, dumb-waiter, or to meals and other family gatherings. As soothing to the senses as a grandfather's clock compared to the startling effect of an alarm clock's compelling clatter, Telechime softly requests, or joyously entreats, your response to

outside calls, and gracefully serves every household signal requirement in diplomatic contrast to the harsh and peremptory commands of bells and buzzers.

A further benefit which the installation of "Telechime" confers upon the home is the rich, melodic accompaniment it affords for piano, radio, voice and other musical provisions for family entertainment. Additional still to their tonal function is the decorative interest which these chimes, encased in beautiful recessed panels and wall cabinets, impart to reception hallway, dining room, living room, library and other locations, invariably enhancing the artistic motif so assiduously sought by architects and decorators for homes of taste and distinction.

Standard chimes ranging from a single tone up to four or more in combination, as shown in Fig. 187, are obtainable for practically any purpose. The adaptability of this system to code-calls and remote

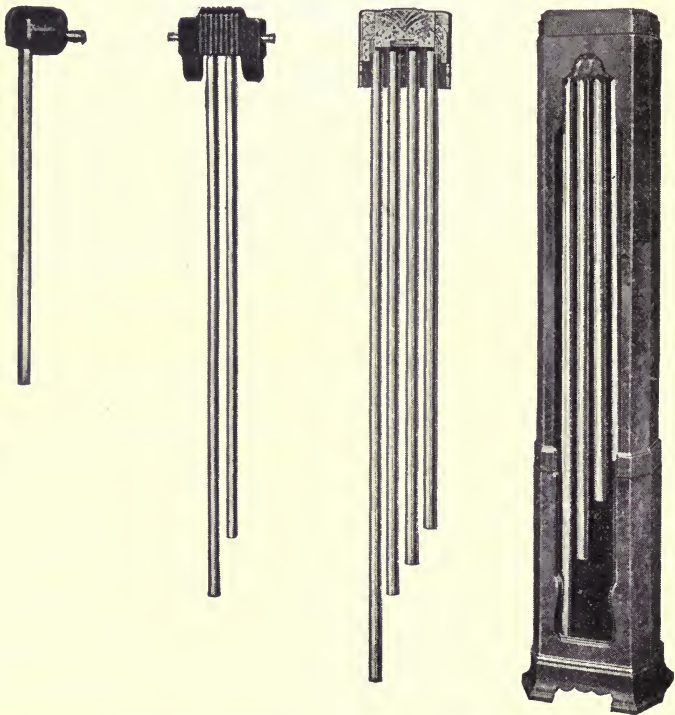

FIG. 187.—Wall and cabinet type "Telechimes"

control operation—as in signalling to and from any desired rooms of the residence proper or outlying buildings—makes it particularly serviceable, since a variety of recognizable tone gradations may be effected to satisfy the individualistic needs of a large household.

As an illustration of the flexibility of application, the “Aristocrat” model Telechime is a residential door-chime made to play a different melody for each new caller, repeating itself in a cycle of selections, so that no one ever tires of its call. Also, by means of a musical keyboard furnished with the “Aristocrat,” it is possible to play numerous refrains, as on a carillon of bells.

The chimes are easily installed, either during building construction or in existing homes, the same simple wiring and push-button connections as for an ordinary bell system being employed. The service is comparatively inexpensive to install and operate, and is economical of current—costing only a few cents a month to maintain. Both single and multiple-tone chimes are operated by means of a small motor-mechanism forming an integral part of the instrument equipment, and an ingenious electrical interlock arrangement prevents signal interference, giving “right-of-way” to any primary service—such as front-door calls—to be determined upon in the regulation of the system.

HOME TELEPHONE SYSTEMS. In some homes an intercommunicating telephone system will be found very convenient. I am showing one in Fig. 188, where the telephone is placed in the owner’s bedroom and other stations are located in the maid’s quarters and in the kitchen. Such an arrangement is inexpensive and will save a great many steps. It is independent of the regular outside commercial system. These telephones, of course, may be extended to any other part of the home or the garage, and they are very simple to install and connect. A small push-button for making the call is mounted on the handle of the ‘phone. These little ‘phones can be of the wall type, or just like



(Edwards)

FIG. 188.—Inter-communicating telephone system for home use

the portable type of public telephones that are now so generally coming into use.

BURGLAR ALARM SYSTEMS. For protecting the home against unwanted visitors the electrically operated burglar-alarm gives a warning whenever an outside door or a window is partially opened. A special switch is mounted in the door jam, or window casing, and connected to whatever alarm system is used, such as a bell or a light or both, and located wherever it will be heard or seen. There is practically no limit to what can be accomplished by means of these burglar-alarm systems. They can be made to give an alarm notifying you if anyone attempts to enter the premises or moves around the house. Here again is where the "electric eye" will act for your protection.

Another suggestion for protection in an unoccupied home is to use a time switch for turning on a few lights every evening, making it appear that the house is occupied, and turning them off at any time desired.

For larger homes an annunciator is used similar to that shown in Fig. 186. It has a "drop" marked for each window and outside door to be protected. By going to this annunciator you can tell which one of these windows or doors is open, without examining them. If one of them is open you know exactly which one it is, and this check can be made without giving any alarm.

At night the alarm can be set to give any kind of a signal you wish, and the minute any door or window is disturbed it is indicated on the annunciator and the alarm given.

My suggestion is to determine just what kind of protection you want, where you want it, and how the signal is to be given. You will then find that an installation can be made which will exactly meet your requirements.

FUNCTIONS OF THE ELECTRIC FAN

The electric fan is such a well known household accessory that no detailed explanation of its operation is necessary.

Electric fans are built in various types and sizes, the size being designated by the diameter of the fan itself. Thus, 8, 10, 12 or 16 inches means the fan diameter. Most fans are adjustable so that they may be set upon a desk or table or mounted on the wall. Fig. 189.

Fans equipped with a switch for regulating their speed are desirable, especially in the larger sizes—10 to 16 inches—so that the amount of air circulated may be regulated. Some fans are stationary and will circulate air in only one direction, while others are oscillating and swing from side to side to distribute the circulation of the air to all parts of the room.

There are many uses for these modern fans and in checking up the many applications, several uses are herewith suggested.

FOR KEEPING AIR IN CIRCULATION. This is probably the most common use, especially in the summer season.

Not only is a fan of immense help during the summer in circulating air, but it can be used in winter, also, by placing it so that it will blow air into the radiator, thus increasing the circulation of heat in the room.

FOR REMOVING COOKING ODORS FROM THE KITCHEN. The modern kitchen is not complete these days without the installation of a ventilating fan, either built into the wall or permanently located in the window or transom. Fig. 190.

Ventilating fans of this type come in any number of designs and models. The two principal considerations in purchasing such a fan are the volume of air which it will move and the vibration or noise it may develop.

Some of the fans, whether they are of the built-in or the temporary type, which can be installed in the top sash of a window, are available with reversible motors, so that the fan either will rid the kitchen of cooking odors by blowing out the inside air, or will bring outside air into the kitchen.

A fan set in the kitchen window, as shown in Fig. 190, will also do an excellent job of ventilating the kitchen. Fans may also be mounted on swinging arms and these arms attached to brackets set in the window sash which may be moved from one window to another as may be desired.

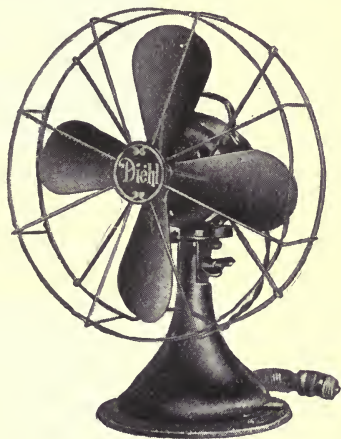
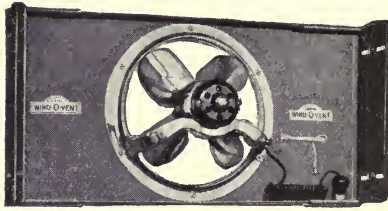

FIG. 189.—Typical electric fan for desk or wall mounting

FOR VENTILATING CLOSETS. Another use is for ventilating closets which are kept closed most of the time and need an occasional airing.



(Above)—Portable type window ventilating fan

(Below)—Permanent ventilating fan installation



(Diehl)

FIG. 190.—Typical ventilating fans for household use

If you merely open the door and set a fan blowing air into the closet, it will only take a few moments to change the air.

FOR DRIVING AWAY FLIES ON THE PIAZZA. While sitting on your open porch you may be annoyed by flies and mosquitoes. A

fan placed on a table near your chair will not only afford a cooling breeze, but will often rid you of the annoyance of these insects.

FOR HARDENING ICINGS ON CAKES. If you are in a particular hurry, place a fan so that it will blow air over the frosting. It will help materially in hardening the icing.

IN DRYING CLOTHES, a fan will serve as both breeze and sun-heat rays when clothes cannot be hung outside the house on a rainy washday. When you have to hang your clothes inside the house, place a fan so that air will circulate around and through the wet articles. You will find that the time needed for drying will be materially reduced.

KILLING INSECTS ELECTRICALLY

MOTH EXTERMINATORS. Moths may be seen flying about when clothing or other cloth objects hanging in closets are suddenly moved. The moth itself does not destroy, but it does lay eggs that develop into small worms. These worms, whitish in color, thrive by eating the clothing or other fabric in which they have hatched. They are



FIG. 191.—Moth exterminators

especially fond of wool, feathers, hair and fur and all other fabrics which are derived from this material. They also attack stuffed animals and birds, piano felts and similar materials. Moths do not live much more than a month, but during that month they certainly can produce some extremely destructive offspring.

The continual fight against the ordinary moth has a new weapon in the form of a gas which is generated by heating a special compound in a small container. The ideal heat for melting the compound used in such devices is electricity, and two types of these moth exterminators are shown in Fig. 191. One type is designed to rest on the floor, while the other may be suspended from a hook or rod.

In principle they consist of a small container which may be placed in a closet and electrically connected to a convenience outlet. This



FIG. 192.—The "Insekiller" for electrocuting flying insects

exterminator, when heated, generates fumes which will penetrate all the clothing in the closet and will kill moth worms, but are not injurious to human beings. The device is left in a closet over night, or for a longer period if there is much clothing in the closet, and the fumes which penetrate the clothing will prevent destruction by moths. Some particular closet can be picked out and all the clothing placed there for treatment. It is well to have the clothing separated so that the fumes may penetrate all parts and thus be uniformly distributed. The closet door, of course, should be kept tightly closed and the electric moth exterminator placed on the floor underneath the garments. If it is to be used in some particular

piece of furniture, such as a chair, it should be placed underneath the chair and the chair itself completely but loosely covered with paper, or a heavy blanket, so as to keep the fumes confined. Usually from twenty-four to thirty-six hours' exposure is best.

Makers of this class of material furnish definite instructions for using these devices, and these instructions should be carefully fol-

lowed. This is a subject that is well worth the attention of any householder and its application is so simple, and the expense of its operation so little, that the problem of moths may now be solved both effectively and conclusively.

INSECT ELECTROCUTERS. Ordinarily, electricity for operating appliances is used for producing heat, or for driving a small electric motor for producing power.

Well, for killing flying insects the small motor or heat is not effective, but electricity has another great qualification which I never thought would be useful to the home. This use is for electrocuting insects such as mosquitoes, moths, or any other night flying insects. In Fig. 192 is shown this device, which looks like an ordinary birdcage, but instead of containing a canary it contains an ordinary light bulb. The small vertical wires that surround the bulb are charged with electricity and when any insect comes in contact with these wires it is instantly killed. The base may be removed to clean out the dead insects. The device, which is hung from the ceiling, can be used with alternating current only. Any bugs that are attracted by a bright glow will find themselves in difficulties the minute they go for this particular light.

Since some bugs are apparently quite particular as to what kind of light they associate with, the device may also be fitted with a mercury-vapor lamp which gives light of a different color.

These "Insekillers" are not only useful for the home, and especially the summer home, but are also valuable for the greenhouse and for use in protecting gardens and orchards from destructive flying insects.

The electrically heated vaporizer already mentioned on page 211, and shown in Fig. 193, is used for exterminating such pests as moths,



FIG. 193.—Electrically heated vaporizer for exterminating moths, water bugs, and cold-blooded insects

water bugs, cockroaches, etc., which it will accomplish in a most thorough manner, bringing them out from crevices in walls, under flooring, etc., where one would never imagine they existed, and destroying them almost instantly. The gas generated is very penetrating and will reach into the remotest recesses of clothes closets, storage rooms, basements and other places where it is essential to be rid of every vestige of insect life.

LIGHTNING PROTECTION

For those who are afraid of lightning, it may be of some comfort to know that it has been figured out from statistics that your chances of being struck during a storm are about one in 200,000. Lightning rods properly installed on a house are good insurance against damage by lightning and may be worth a great deal to those who experience fear during a severe storm.

The object of lightning rods is to keep lightning from striking the home by allowing any accumulation of an electrical charge that may exist in the nearby ground, or on the building itself, to be carried off into the air. Such rods also carry into the ground lightning that may strike the house. Tall trees, or taller buildings around a home, give some protection and there is also some protection in the metallic drainpipes that pass through the roof of many homes or in other metal conductors, such as gutters, that are properly grounded.

However, if lightning rods are to be used, they should project above the highest point in the home, especially chimneys, and cover all sharp points such as the ends of the ridge-pole of the house and over ells and dormer windows. The rods themselves should be as straight as possible, and most important of all is that they be thoroughly "grounded,"—that is, they should be carried into the ground to a sufficient depth to reach continuously damp soil. These rods may be fastened directly to the house proper. If you feel that lightning rods are necessary, I suggest that you get the details of an installation from some reputable maker who can supply definite instructions for proper protection. Be sure the equipment carries the Underwriters' label of approval. If you are building a new home the lightning rod equipment may be concealed in the walls of the house while under construction.

The use of electricity in the home does not in any way endanger your life from the standpoint of lightning. While there is little personal danger during a thunderstorm, at the same time it is just as well not to touch a lamp socket or large metal object. When the storm is extremely near, it is perhaps best not to touch any electrical equipment or, in fact, metal of any kind, inasmuch as lightning may strike somewhere near your home and induce an electric charge into any metal in the neighborhood. Since sound travels about a mile in five second's time, it is quite easy to roughly check up how far away the lightning is from your home by timing the flash and its thunder. In very heavy near-by storms this calculation is hardly possible.

OUT OF DOORS ELECTRICALLY

Electricity is now being extended beyond the inside of the home and there are several devices that can be used out of doors to advantage.

Such conveniences mean that electricity should be available outside the house. This can be accomplished by means of waterproof convenience outlets, and these outlets may be further extended to various parts of the grounds or garden by means of simple underground wiring, as already described.

Devices which may properly come under this head are as follows:—

LAWN MOWER.

HEDGE TRIMMER.

HOT-BED HEATER.

WORM CHARMER.

LAWN MOWER. Electricity used to drive a small motor has now been applied to the lawn mower, and where electricity out of doors is available it can be used economically. The motor on the lawn mower provides the power, and it is only necessary for the operator to guide the machine. Fig. 194. A switch in the handle of the lawn mower starts and stops the motor at will. The area that can be mowed depends upon the location of convenience outlets, since there is, of course, a limit to how far the cord can be carried by the

lawn mower without getting in the way of the operator. For large lawns it would be best to have several convenience outlets located at important points, these waterproof outlets being fastened to posts located where desired.

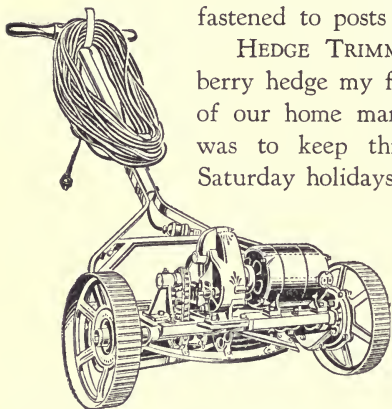

FIG. 194.—Electrically operated lawn mower

HEDGE TRIMMERS. I well remember the barberry hedge my father planted around the grounds of our home many years ago and what a job it was to keep this hedge trimmed. How many Saturday holidays became the hardest kind of work days, with all my plans spoiled and my patience ruined, because of the long hours required to do this tedious hedge-trimming by hand! What a boon it would have been if, in my young day and generation, this electric hedge trimmer with its thousands of cuts per minute had been invented—and my father had owned one!

Wasn't it Tom Sawyer whose clever ruse succeeded in getting his young friends to pay him in personal treasures for the privilege of whitewashing his father's fence? No ruse would be necessary today with this magic device, for any boy would think it true sport to use it. The only problem would be in getting Dad to sacrifice his own pleasure for his son's benefit. Nor would this trimming job now interfere with fishing, or any other holiday plan, for a half-hour's time will suffice for clipping an average hedge.

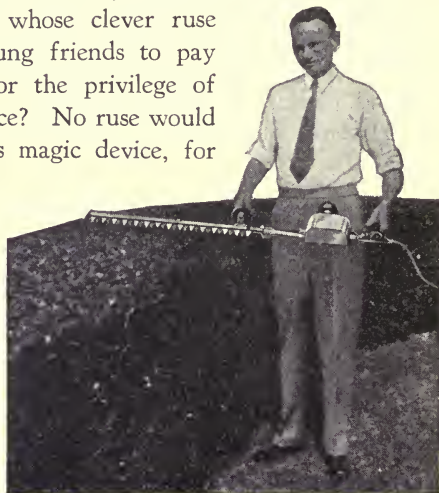

FIG. 195.—“Little Wonder” hedge trimmer

Even the shrubbery and grass along walks, flower beds and borders in the home garden can be cared for with these electric shears or trimmers and with far better results than by former methods. No

leaf so tender, nor branch so tough, these shears cannot cut through them quickly and smoothly and without physical effort. It is indeed like passing a magic wand over the hedge, so surprisingly fast do the sharp teeth work by electric action to bring a scraggly and unruly hedge, or mass of shrubbery, into a neat and trim condition. Hiring help for these regular tasks can well be dispensed with, except, perhaps, on large estates or extensive grounds. And what an opportunity for an ambitious boy to earn money in caring for neighbors' grounds with one of these handy outfits, combined with an electric lawn mower!

These electrically driven hedge clippers are connected to a convenience outlet through a length of cable or extension cord which may be several hundred feet long, if required, without loss of cutting power. Sizes are available with cutting blades varying in length from five feet down to about fifteen inches. They are of light weight, easy to handle, work from any

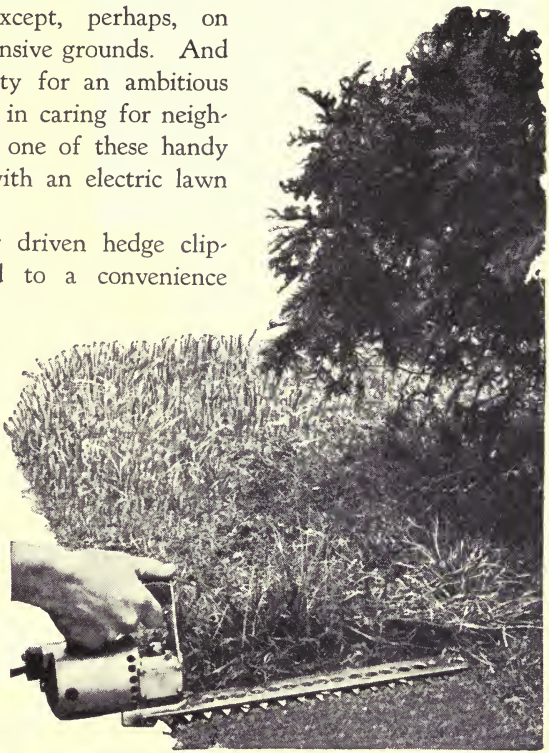

FIG. 196.—The "Hedshear" for trimming shrubbery, walk borders, etc.

angle, and cut backwards or forwards with equal facility. One of the larger types is shown in Fig. 195, while Fig. 196 illustrates a smaller model with a cutting edge on both sides. All types can be operated from either alternating or direct current.

HOT-BED HEATER. Electricity is used for so many purposes nowadays that when we come across an unfamiliar application it naturally arouses unusual interest. Not long ago when selecting

some electrical equipment for outdoor use, my attention was called to a special hot-bed heater which appealed to me as an appliance our old gardener would be interested in, so I purchased the equipment

and took it out to where he was working. He looked at it in a puzzled way for a moment and then turned to me with the amusing remark:

“Well, of all the magic things I’ve heard about electricity, this certainly beats all. So now you can get garden fertilizer out of a light socket!”

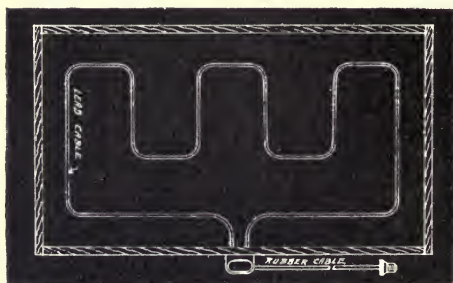

FIG. 197.—The hot-bed heater, showing location of heating coil

In Fig. 197 is shown the hot-bed heater I have reference to. It is used to heat a small area of ground under cover. This device keeps the ground in the hot-bed at the proper temperature so that seeds will fertilize and plants will grow and reach a proper stage for transplanting when the weather has become normal for plant growth.

This device, which consumes but little electricity, consists of a small heating wire which is enclosed in a lead-covered cable. This makes it waterproof and allows sufficient flexibility to cover the greatest area of ground. The device is fitted with a waterproof flexible cord and may be connected to any near-by convenience outlet.

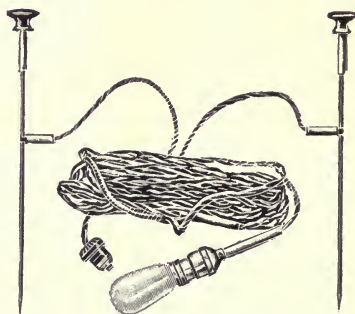

FIG. 198.—Worm charmer. It “gets ‘em” if they are there!

WORM-GETTER OR CHARMER. I doubt very much if the average fisherman would believe that electricity could be used for making worms come out of the ground. Well, it does that very trick, and any fisherman will be interested in the simple process. Poultry keepers are also interested, but I wonder what the poor old worm has in mind when he receives a shock from the electric current that

makes him want to get out of his warm bed immediately and without benefit of a warning alarm!

This device, shown in Fig. 198, is extremely simple. It consists of two metal rods called "electrodes," which are stuck into the ground several feet apart. The electricity goes through the moist ground from one electrode to the other and the ground itself becomes a conductor. Any worm in this area between the rods will get a shock if it is in a horizontal position between the electrodes. To avoid this shock the worm must be in a vertical position, and it will naturally go to the surface to get out of the electrified zone and see what it's all about. It must be remembered that the worm may not be the only one to get a shock, since damp soil will conduct electricity to the operator as well. In using the electrodes, *the metal must never be touched* when the



(Stanley)

FIG. 199.—The automatic door for the home controlled by the "Electric Eye"

electricity is on. Be sure to turn the current on only after the electrodes have been stuck in the ground and ready for business.

MISCELLANEOUS ELECTRICAL EQUIPMENT

ELECTRICALLY OPERATED ELEVATORS. A small, single-passenger elevator in the home may be the means of adding comfort to an invalid in the household. Two types, electrically operated and controlled, of course, are used—the direct lift and the inclinor for the straight stairway. The former is the same as used in larger buildings, while the latter rolls up and down a special track on the

side of the stairway wall. It consists of a platform which may be folded up and put out of the way when not in use.

ELECTRICALLY OPERATED DUMB WAITERS. Electrically operated dumb waiters provide an added convenience in many types of homes, particularly where the kitchen is located on the basement level and food, dishes, etc., must be carried to the dining room above, or to higher levels. The same system may be used in place of the "laundry chute" for delivering clothes and soiled linen from upper floors to

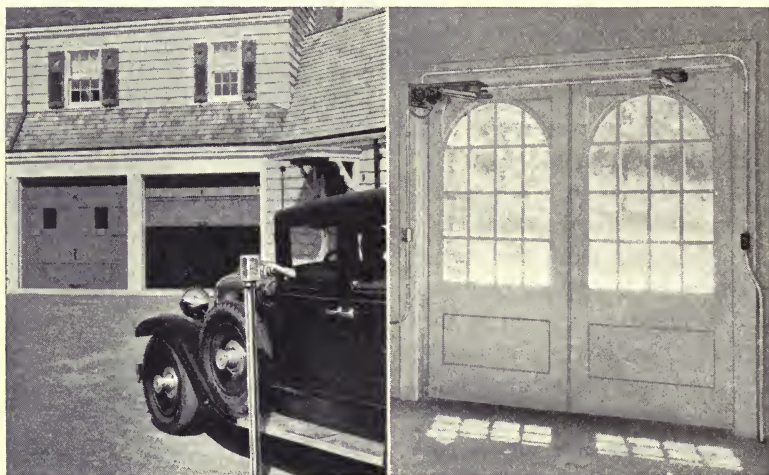

(Stanley)

FIG. 200.—Garage doors may be automatically opened and closed. Control button at left and door control mechanism shown installed at right

kitchen or basement. Existing shafts may be converted to electrical operation quite simply with the modern equipment now available, and in new homes it is well to provide for this service.

ELECTRICALLY OPERATED DOORS. The automatic opening and closing of doors has been made possible by the use of electricity. Such doors are used for the garage and sometimes in the interiors of larger homes. Fig. 199 shows an application between the pantry and the dining room where the door is divided into two sections. The photo-electric cell or "electric eye" mentioned in the "Prologue" actuates a switch for controlling the door.

Garage doors may be either of the swing type, opening on both sides, or of the roll-up, overhead sliding type. Fig. 200. Such doors may be opened or closed automatically by means of a small push-

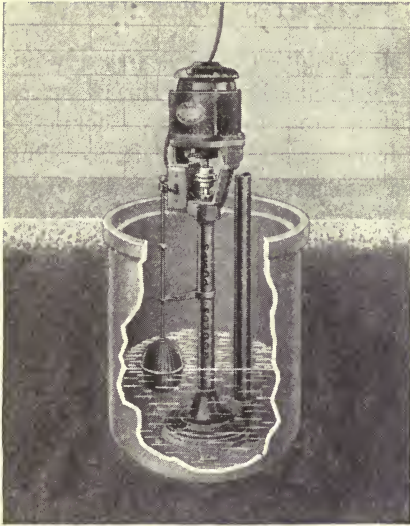

(Gould)

FIG. 201.—Automatic “Sump” or cellar drain pump

after a heavy rain. By means of a special pump driven by an electric motor such water may easily be removed. Automatic control starts the pump whenever the water enters the cellar and shuts it off after the water has been discharged. Fig. 201.

AUTOMATIC WATER SUPPLY SYSTEMS. Running water is a necessity in any home and where water from a central supply is not available, an automatic system, shown in Fig. 202, may be used. Such a system consists of an electrically driven pump which keeps the water under pressure in the supply tank ready for instant use. The outfit may be located in the basement since the pressure in the tank will force the water to any part of the house or grounds.

button, conveniently located, or also by the “electric eye” just mentioned.

CELLAR DRAIN PUMPS. Under the basements of some homes the soil conditions are such that a cellar may not be properly drained. This may cause it to become flooded

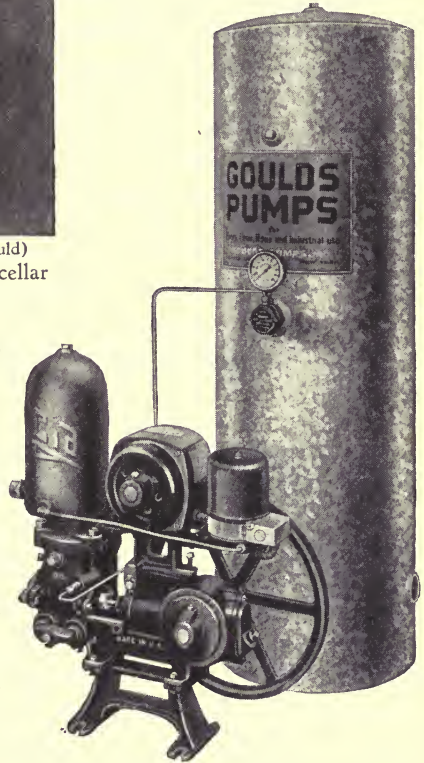

FIG. 202.—Complete electrically operated automatic water system for household use

PREPARATION FOR FRIDAY'S JOURNEY

One of the most exciting of all our little journeys was now in prospect. "How in the world," we asked ourselves, "has this resourceful Day Family solved the burdensome problem of Home Cooking?" For, solve it they would, we knew from our previous experiences. But still it was difficult to banish from our minds the prevailing picture of a turbulent kitchen, hot and distressing, with its steaming atmosphere and confusion of pots, pans and piled-up dishes.

But no such scene presented itself to our astonished gaze when, after a short interval of greeting, we were led into the immaculately clean and delightfully cool kitchen of the Days.

Mrs. Day and her two daughters were in the garden when we arrived, calmly assembling a bouquet of flowers for the evening's dinner party to which we had been invited. They explained that they had been out riding all afternoon and now, with a number of guests coming, here they were giving their precious time to such trivial matters as table decorations and, apparently, not the least concerned over the fact that it lacked only a half-hour to dinner time!

"How can you possibly manage it," we asked, "since you told us only yesterday that 'maid's afternoon out' had become a prolonged blessing?"

"Oh, but we still have servants!" insisted Mrs. Day. "And they are the very best kind—electric ones, you know. Come! There is still time; let us show you Friday's Room.

"You see," she continued, leading the way to the house, "the bothersome Baking Day which used to be Saturday, as you know, is banished from our kitchen forever. First of all, what is left of it we have moved back to Friday so as to leave Saturday completely free for holiday pleasures. And secondly, Baking Day is hardly deserving of the name any more since there is so very little that we ourselves have to do about it, as you will presently see. The tables are literally turned these days. Much of the kitchen is in the dining room, and vice-versa. It has become so completely automatic, with our electric servants doing all the work, that we hardly see food until it is prepared and served. We do not even have to announce dinner. Listen!"

From within the living room we heard the soft, lovely tones of chimes sounding a sweet refrain.

Dinner is Served



“And there are words for it,” chimed in the younger daughter in her own sweet, little voice. “What is playing now is called ‘Dinner is served.’ We found it in a wonderful little book furnished with the Telechimes. Here it is on page 7,” she said, indicating a bar of music in a little book which hung near the serving table.

“But we will change it now to another signal which is called the ‘Grand Entrée,’ since guests are coming,” she said laughingly.

It seemed to be a very simple thing to do, and this is the music we now heard:

Grand Entrée



“Come, daughter!” said Mrs. Day, smiling, “We can have the chimes again after dinner when Sister will play your favorite song, ‘The Bells of Saint Mary’s,’ for our friends.

“It makes a delightful accompaniment for the piano,” she said, turning to us, “but while we have the time I want you to see the modern, or *All-Electric*, kitchen we have been speaking of.”

And so, with heightened interest, we followed the Days into:

FRIDAY'S PROGRAM

ELECTRICAL COOKING APPLIANCES.

FOOD PREPARING ELECTRICALLY.

PRESERVING FOOD ELECTRICALLY.

WASHING DISHES ELECTRICALLY.

THE ALL-ELECTRIC KITCHEN.

What six factors make cooking electrically the most desirable of all methods?

How many kinds of cooking devices are you personally familiar with besides those listed?

What do you recall reading in other chapters about time switches, clocks, thermostats and other regulating devices? How many applications of these "controls" in the kitchen alone can you think of where greater convenience and economy would result if installed in your own home?

How does the electric range prevent "shrinkage," and at the same time preserve juices and savor, in cooking meats and other foods?

What chief distinctions as to utility should be made between the proper use of the Range, Hot-Plate, Stove and Oven Combinations on the one hand, and Portable Cooking Appliances, Food-Warmers and Table-Serving Devices on the other?

What considerations of construction, appearance and serviceability should guide you in the choice of any appliance?

What kitchen labors have now been eliminated by mechanically driven food preparers?

Why is the installation of an electric refrigerator a measure of health protection, as well as economy, in household management?

What is the average weekly wage of the electric servant who washes the family dishes?

Note how the section on the "All-Electric Kitchen" briefly summarizes the advantages of modern, automatic and mechanical food preparation. Can you think of other devices it would be of advantage to include with this equipment?

FRIDAY'S JOURNEY

ELECTRIC COOKING APPLIANCES

Cooking electrically is the most modern, convenient and advantageous of all methods and is becoming more popular and necessary every year. The superiority of electricity for cooking is due to several factors:

Cleanliness—since it provides heat without smoke or soot.

Safety—since it provides heat without flame.

Health—since it consumes no air.

Convenience—since it can be used anywhere it is desired, even out of doors.

Economy—since it can be automatically controlled.

Efficiency—since no heat is wasted.

Portable cooking appliances may be used in any part of the home where there is a convenience outlet, for electricity is a "fuel" which needs no chimney and no pipe connections.

Heat for cooking appliances is usually obtained from a small wire heated by an electric current. In all the appliances made for cooking food, described and illustrated in this part of our seven-day journey, you may depend upon it that all but a very few are built around a simple little wire, just as in olden days a home was built around a fireplace. Just turn on the switch and the heat is there. No tons, gallons, or cubic feet of fuel to think about and provide storage space for. No blackened pots and pans to scour—grim and greasy reminders of wasted fuel dollars, *going up in smoke!* Only a little wire that glows like a hot coal and is never consumed. Aladdin's lamp was never so wonderful as this phenomenon of making a fiery furnace appear out of a small wire all in an instant, at the mere touch of a switch!

I wonder how many of us ever pause to think what a marvelous blessing comes to us in the form of electric heat? Whether or not there is a "rainbow 'round my shoulder," to quote from a popular song, I know that there is a rainbow on my electric range and a pot

of golden opportunity at each electric terminal unit. A little daily adventuring in the Book of Modern Electric Recipes quickly brings us to our rainbow's end in any one of a number of efficient cooking appliances—each one a perfection of design for a particular purpose, and each one serving a savory feast such as no other form of heat can supply, or art produce.

There are a few appliances in which the wire is omitted and the electricity passes through water and heats it directly, as in the egg cooker and one form of milk bottle warmer. The wiener cooker is just as simple, or perhaps more so, since here the electricity cooks the wiener by boiling the water that is already contained in the wiener itself.

An excellent example of the efficiency of electrically produced heat is afforded by a comparison with the open fireplace. The direct heat from the fire goes up the chimney and only a small portion is radiated into the room. If there were no chimney and all the heat could go into the room, only a small fire would be required. This, however, is impossible in the home on account of the smoke and flame. With electric heat these obstacles do not exist and for this reason electric heat can be applied just where it is wanted. It is also more efficient, since little heat is wasted.

Practically all automatic heating appliances depend upon a simple device, called a "thermostat," for controlling the heat. The thermostat

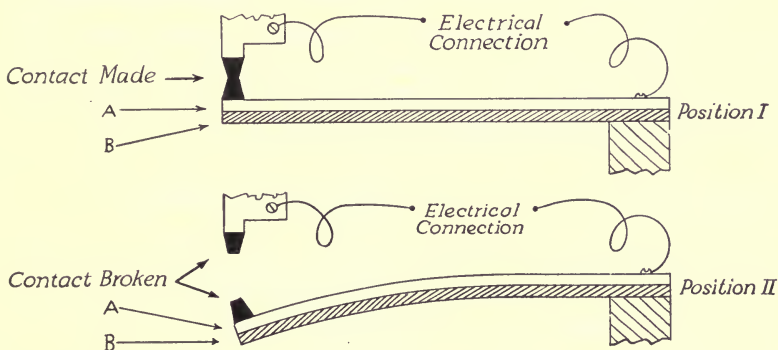

FIG. 203.—The thermostat acts as an automatic switch, breaking the electrical circuit when it becomes heated. The principle of operation is based on the difference of expansion of two metals, "A" and "B." When heated by the current, metal "A" expands more than metal "B," causing the contact points to separate as shown in Position II. This breaks the electrical circuit, allowing the metals to cool, which restores them to the normal Position I

may be considered as a simple switch which is turned on or off automatically by the action of heat instead of by hand. Fig. 203.

If you placed a thermometer in a tumbler of water being heated by an electric immersion heater, and you desired to vary the temperature between a low point of 180° F. and a high point of 212° F., you could regulate the temperature by a hand switch. When the water boiled and the thermometer registered 212 degrees you would shut off the current and the water would cool. Now, when it cooled to 180 degrees, you could turn the current on again and the water would heat and boil once more, and so on. That is what a thermostat does for you automatically and accurately.

Clocks which operate switches are used also for turning the electric current on and off at predetermined times so that you may be doing other things and let the electrical appliance take care of itself.

I have mentioned these two examples because they have much to do with the control of many home electrical appliances and a general idea of their functions may help you. The application of automatic control to cooking is just one of the ways in which the electrical appliance is providing the average home maker with more free time to take care of more important things. Automatic control makes it possible for the housewife, or servant, to have entire freedom from watching food as it is being cooked.

There are many types of cooking devices on the market. Following is a list of the principal ones, a description of which appears later on in this chapter. With the exception of the range, all are of the portable type, fitted with a flexible heater cord, and may be connected to convenience outlets.

CASSEROLE
CHAFING DISH
COMPLETE ELECTRIC KITCHEN
CORN POPPER
DEEP FRYER
DOUGHNUT BAKER
EGG COOKER
ELECTRIC ROASTER
FIRELESS COOKER
FOOD WARMER
GRIDDLE
GRILL

MILK BOTTLE WARMER
OVEN
PERCOLATOR AND COFFEE MAKER
PLATE WARMER
PORTABLE STOVE OR HOT PLATE
POTATO BAKER
RANGE
SANDWICH GRILL
TOASTER
WAFFLE IRON
WIENER COOKER

The Electric Range

The electric range is the best example of the superiority of electric cooking. All that I have said previously about the advantages of electricity for cooking applies directly to the range. I shall review these advantages briefly since they mean so much to any home:

The clean, fireless heat can be applied just where it is wanted—that is, inside the oven or directly to the bottom surface of a pot or pan—so that none is wasted in heating the kitchen.

The cleanliness of electricity not only eliminates the annoyance of black pots and pans, but saves the walls and ceiling and the curtains of the kitchen from becoming soiled with the soot from a flame.

The oven can be controlled automatically, giving freedom for attention to other important household tasks, or other interests. The perfect control of the heat means better cooked food and the automatic feature means prevention of waste and spoilage, for electrically cooked food and controlled operations mean scientific preparation—nothing overdone and nothing underdone.

Electricity means a saving of time in cooking and cleaning the kitchen, and fewer headaches for the cook.

If good cooking can be done on ranges heated by other fuels, then still better cooking can be done on the electric range. There was a common complaint a few years ago that cooking on the electric range was much slower than when using other fuels, but the development of the modern range heating units, with their speedy action, has completely overcome this objection.

In some of the earlier installations where the old-fashioned coal range was replaced by the electric range, the question of heating the kitchen often presented a problem. The electric range is so efficient that only a very little heat actually reaches the kitchen, which means much in hot weather. Better heating of the kitchen during cold weather can be provided by the regular heating system of the home. Such heat can be controlled and is not dependent upon the heat required for cooking.

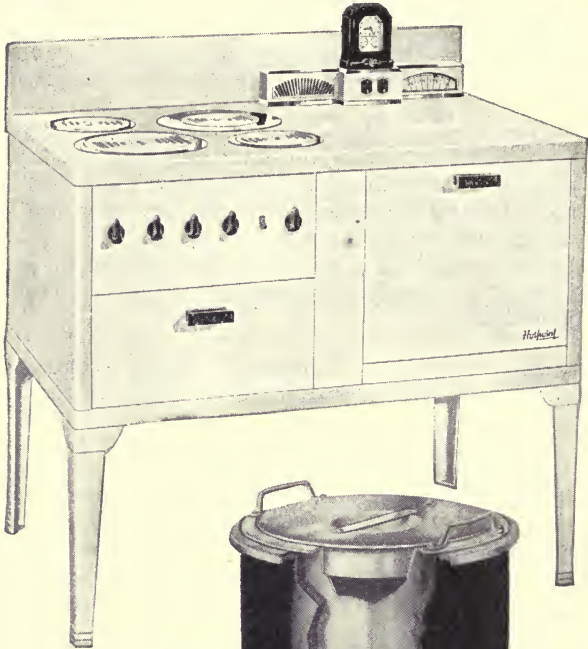
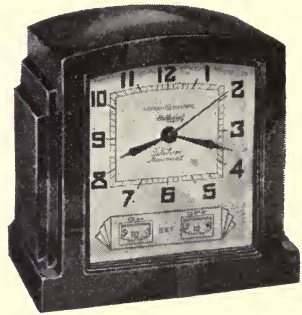
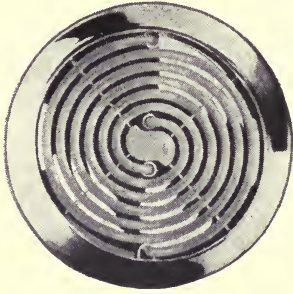

(Upper Left)—Quick-heating surface unit

(Upper Right)—Electric clock and oven time control

(Lower Right)—The thrift cooker, inserted in top of some ranges

FIG. 204.—The electric range with its principal parts

• What has been said about heating the kitchen also applies to heating water for the home.

The electric range may also be mounted in combination with an electric refrigerator. Just as the electrically operated refrigerator properly preserves food, the electric range properly and efficiently cooks it.

The modern electric range, as now designed, is a marvel of heating efficiency and constructional perfection which belies its apparent simplicity. I shall not attempt to describe the design principles involved, but Fig. 204 shows a typical range with its accessory parts.

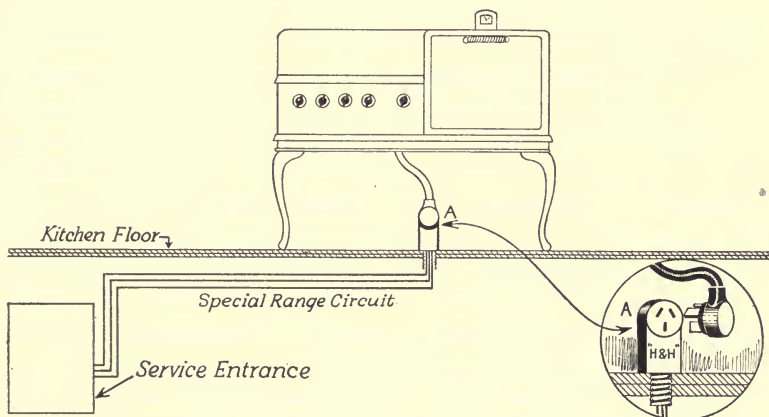

FIG. 205.—The electric range may be easily moved at a moment's notice, merely by disconnecting heavy duty plug at special range outlet "A"

In addition to the regular grills and oven, a special cooker is used for braising, pot-roasting, steaming, stewing, etc. Both cooker and oven are automatically controlled in some types of ranges. The automatic control of the convenience outlet on a range makes it possible to start the coffee maker, or other appliance, in the morning while you are getting up.

The installation of the range requires nothing more than its connection to your electric highway, using a special circuit, as shown in Fig. 205. The range may be moved at any time for cleaning under and around it, or when moving to new quarters, simply by disconnecting it electrically. A modern electric range will last for many years and requires no special care outside of keeping it clean.

SELECTION OF THE RANGE. The selection of the proper range for your use, assuming that you purchase one of the nationally known makes, and that you buy from a reputable dealer, is primarily a matter of getting the right size for your family, with due consideration of its special features. The size of the oven is also important, since a great deal more cooking is being done in home ovens these days. And above all, make certain that there are ample facilities for cooking entire meals, including vegetables and all at one time as a matter of both convenience and efficiency.

The size, or wattage, as it is called, of the heating elements is another important consideration. Only by means of the larger wattage units can you get the speed in your cooking that you have a right to expect from a modern range. Two 1500-watt elements in the oven—one below for baking, and the other above for broiling and browning—are most satisfactory. By turning on both of these heating units you will find that it takes but a very few minutes to raise the temperature in the oven sufficiently for almost any baking requirement. At least one of the heating units on the top of the range should be of high wattage so that water can be boiled quickly or large pots of vegetables brought to the boiling point without delay.

GETTING THE MOST OUT OF YOUR ELECTRIC RANGE. The modern housewife should be just as scientific in her management of the home as her husband in running his business. Considering her interest with respect to the best ways of producing desired results in the home, I am offering a few suggestions that should be remembered in the use of any modern range, but which apply particularly to getting the most out of the range for the least expenditure. Electricity is so easily controlled that every advantage of this modern cooking method should be gained.

PROPER USE OF THE ELECTRIC OVEN. One of the outstanding advantages of electric cooking is in the saving in the cost of heat made possible by the proper use of the oven. Inasmuch as the heating element is completely enclosed within the oven whose walls, in turn, are heavily heat-insulated, not only is all the heat developed thus retained, but also there results a decided saving in the shrinkage of roasts and other foods cooked this way. Instead of having a 10-pound roast turn out to be but $7\frac{1}{2}$ or 8 pounds when it is ready to serve, you will find it has lost but little weight when roasted in an electric oven. Particularly in summer will you appreciate this completely

enclosed heating unit, for with this construction and the excellent heat insulation provided in the modern electric range oven, there will not be enough heat lost by radiation to affect materially the temperature of the kitchen. In fact, we have operated our oven with a plant in bloom on its top without injuring the plant or the flowers in the least.

OVEN-COOKED MEALS. Another use of the electric oven which is adding greatly to its popularity, because of the convenience of operation and the excellent results secured, is the preparation of the complete oven-cooked meal. A number of delightful and tasty recipes are now available which have been especially planned for the electric oven and which may be cooked in combination all at the same time, thus effecting maximum economy in the use of electric current. These combinations include not only the meat and potatoes, but also one or more vegetables. By this method an entire dinner can be prepared, placed in the oven, the regulators set, and the range will do the rest without requiring any further attention. The saving in fuel which the complete oven cooked meal effects is a very important advantage, but the convenience and freedom from supervision are oftentimes equally as helpful in planning the efficient management of the home.

USE OF AUTOMATIC CONTROL. Both the temperature to be maintained and the time of starting and turning off the heat are controlled automatically in most electric ovens. There are various methods of securing this control. One design employs a clock mechanism which can be set to turn on the current (which means the heat) at any given time, as well as to turn it off after any desired period of heating. Another design employs a temperature control device (the thermostat I have already mentioned) which is set to maintain any desired degree of heat in the oven. In the range already shown in Fig. 204 the two foregoing methods are used in combination. First, the clock turns on the current, and then the thermostat keeps the heat at the desired temperature until the clock turns the current off.

Most housewives have now learned at what temperatures their favorite recipes turn out the best, and how long to apply the heat. Modern recipes customarily give this information.

The exact method of operating the control devices on any electric range which you may purchase will be found included in the manufacturer's instructions. An outstanding feature of all electric ranges and ovens is their simplicity of construction and ease of operation.

Any child can be trusted around them for there is nothing to turn on and off that will cause harm. They are safe!

Care must be taken, of course, when pre-heating the oven, to set the clock accordingly. Where a hot oven is desired before the food is put in, both the top and bottom units may be turned on so as to reduce the time required to reach the proper temperature. After reaching this point, the bottom unit will be sufficient to maintain the required degree of heat. It is interesting to check the length of time during which it is unnecessary to use electricity at all, because of the fact that the heat stored in the oven and retained by the heavy insulation of the oven walls, will keep the temperature up for several minutes. The bull's-eye of the pilot-light glows only when electricity is actually being used in the oven. When you observe how short these "glow periods" are, it may seem impossible that sufficient heat is being supplied to keep the right temperature in the oven. But while you marvel at the infrequent demand for current on the part of the oven, remember that it is due chiefly to the fact that the location of the insulation confines the heat to the oven interior and allows only a slow leakage to the outer air when the oven door is kept tightly closed.

The automatic heat regulator can be relied upon to do its job properly. Try not to open the door of the oven while food is cooking, for every time the door is open a certain amount of heat comes out into the room and this loss must be made up by the use of more current. A considerable economy can be effected by a little care in this simple matter. If a long enough time has seemed to elapse, and still the cake or the pie is not quite as brown as you desire, the top unit of the oven may be turned on for just a few minutes until the desired result is secured.

BROILING. More and more, modern housekeepers are substituting broiled meats for fried. There is no better heat than the electric oven for this type of cooking, since there is no open flame, and the heat can be just as intense as you like it. The top unit in the oven is provided primarily for this purpose. Chops or steaks broiled in an electric oven are as near perfection as it is possible to make them. You may find it better in broiling meats to leave the oven door partly open. With the top unit on and the bottom unit off, no heat is applied to the pan, which is kept cool by having the oven door open. This eliminates undesirable smoking.

Steak or other meats taken directly from the refrigerator should be allowed to reach room temperature before being placed in the electric oven, otherwise the extreme cold of half-frozen meat coming in contact with the high heat of the oven produces steam and the juices of the meat are lost.

ECONOMIC OPERATION OF SURFACE PLATES. A little attention to the operation of the heating plates or burners will result in great economy in the amount of electricity used. There are a few important things to be kept in mind in this regard:

Use Very Little Water in Cooking Vegetables

About the only use of water in boiling is to prevent burning, and since there are no flames leaping up the sides of the utensils on the electric range, there is much less danger of scorching. Only enough water to cover the bottom of the pan, and to allow for a little to boil away, is necessary with an electric range. It is entirely unnecessary to have all of the vegetables covered with water, for those above the water-line will cook in the steam if the proper covered utensil is used. Not only will this save electricity by reducing the amount of water to be heated, but it also allows the healthful vitamins to remain in the vegetables.

Use the Correct Utensils

Flat-bottom pans with straight sides, and which cover the entire surface of the heating unit, should be used so that as much as possible of the heat developed will go into the food to be cooked and not escape around the side of the pan, into the air. Fig. 206. The varying sizes of units, and the additional flexibility provided by two heating coils in some of the units, make it possible to cook either small or large quantities of food in the same containers. In order to retain as much of the heat as possible, and also to allow the vegetables which are not immersed in water to cook properly, all pans should have well fitted covers.

Turn the Unit to "Low" as Soon as the Pot Boils

Naturally you will want the pot to boil as soon as possible and therefore, at the beginning, you will probably turn the unit on full heat. Much less heat is necessary to keep the pot boiling, however, than to raise it to the boiling point and, therefore, as soon as the

*Turn the Current Off Entirely a Few Minutes Before
the Vegetables Are Done*

Because of the amount of heat stored up in the heating unit itself, you may find it desirable to turn off the current entirely, even before the food is done. The pot will continue to boil on this stored-up heat. A little practice will enable you to take the fullest advantage of this saving.

Do Not Heat More Water Than Is Necessary

In former days, when the stove was always hot anyway, there was no waste in heating a whole teakettleful of water whenever a little was needed for tea or for other uses. Considerable economy can be effected in these days, however, by heating only the amount of water actually needed. There is no occasion for heating a quart of water when only a cupful is required.

STOVE DOMES. In many homes where the electric range is not used, some means of carrying off the fumes from the fire and, with any range, the odors from cooking, will make the kitchen a more comfortable place in which to work. Such a dome, shown in Fig. 207, is installed over the range and connected with a ventilating flue. A small motor on top of the dome forces the rising fumes or odors from the range into the flue, and expels them out of doors. Besides the small motor, a handy light is built into the dome, making it possible to see everything on the range, regardless of the regular lighting used in the kitchen.



(Universal Stov-Dome)

FIG. 207.—Cooking odors from any range may be removed by means of the electrically equipped "Stov-Dome," providing both light and ventilation

Portable Cooking Appliances

In the range we have a complete cooking device—hot plates and oven—and in some ranges an electric cooker, warming oven and

grill. For cases where the range cannot be used and where other appliances, not a part of the range, are desired, a complete line of portable cooking appliances is available. The list includes an appliance for every cooking requirement and there are many useful combinations, such as a casserole and a hot-plate, or a hot-plate and grill, oven, etc. By means of these portable appliances food may be cooked anywhere electricity is available from a convenience outlet, even in the dining room if desired. Not only is there a wide range of these appliances as to type and purpose, but they may be had in a variety of finishes to match almost any decorative scheme, such as aluminum, chromium or other finishes, as well as in china, porcelain and glass combinations of attractive and colorful design.

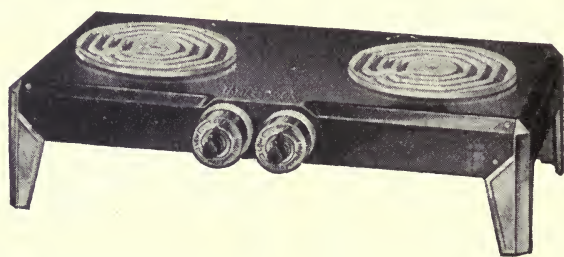

(Nesco)

FIG. 208.—Portable electric “hot plate”

By proper planning and use of these appliances, such as having some on high heat while others are on low heat, much of the household cooking may be done on a smaller electric circuit, or highway, than that required for a range. A circuit having a capacity of 1350 watts, or 15 amperes, with two devices on medium heat—or one on high heat (1,000 watts), and one on low heat (300 watts), at one time—will amply provide for the cooking needs of a small family.

STOVES OR HOT PLATES. For the kitchenette and for cooking small quantities of food, there are several types of small portable stoves which are often called “hot plates,” and it is surprising how much real cooking can be done with them. Fig. 208. These small portable stoves contain the same individual heating units as those used in the electric range. They are made in many different forms and usually contain one or two heating elements mounted in one compact frame which, being small, may be put away when not in use. These stoves are often mounted in frames in combination with a

small oven, a grill or a casserole, thus increasing their usefulness. Fig. 209.

Many of these stoves are provided with a regulating switch for each element, so that three different degrees of heat—high, medium

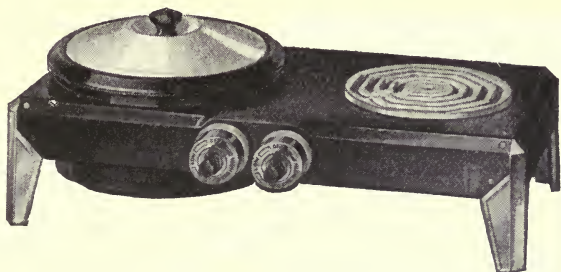

(Nesco)

FIG. 209.—Combination casserole and stove

and low—may be obtained. Some of the less expensive stoves do not have controlling switches and are turned on and off by disconnecting the attachment plug from the convenience outlet.

For keeping food warm or coffee hot without boiling, a very useful type of stove which maintains a low cooking temperature, and will not burn ingredients that are being heated, is shown in Fig. 210. It will provide the slow, even heat necessary for melting chocolate and will keep the chocolate in the desired condition for proper handling. It is also useful for melting butter, and the mixing bowl containing butter may be mounted right on the stove, since it is designed for this purpose. In creaming butter for cakes this stove speeds up the process considerably and the heat helps to blend the sugar, resulting in a fine-textured mixture.

It may also be used for warming several plates at a time, and it will keep them at a proper temperature for serving.

This useful little unit is easy to clean, requiring only the use of a damp cloth lightly coated with soap. The stove, however, like any other heating appliance, should not be put into water.

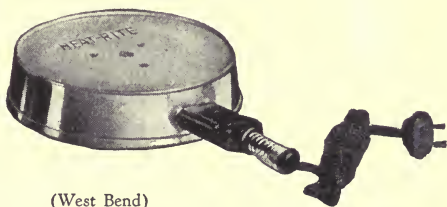

(West Bend)

FIG. 210.—Low-heat electric stove for warming and slow cooking

GRILLS. Grills are often employed as supplementary cookers for use on the table when small amounts of food are to be broiled. In some types of grills where the heating element is located either

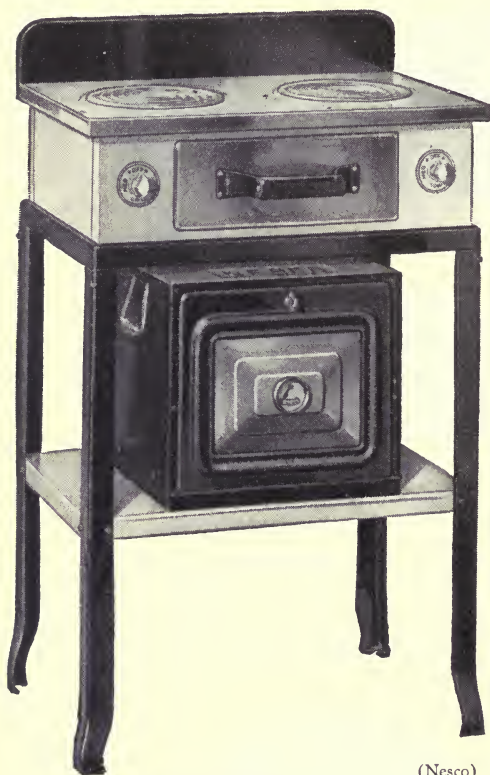

(Nesco)
FIG. 211.—Portable combination stove, oven and grill

above or below the pan used for cooking as many as three different vegetables, together with a steak, may be cooked at one time. Grills are often mounted with a portable stove, casseroles, etc., in the same frame, and the combination makes a very complete cooking outfit. Fig. 211 shows a small stove containing two hot plates and a portable oven. Between these hot plates is a drawer containing a grill.

SANDWICH GRILLS.

The sandwich grill, or "table cooker," as it is sometimes called, Fig. 212, is a most useful appliance for aiding in the preparation of breakfast or luncheon, particularly in the "one-room" city apartment and in the

shore cottage where cooking facilities must necessarily be limited.

Not only is it practical for toasting delicious sandwiches, two at one time, but it may be used for making toast and pancakes, broiling chops, frying eggs and bacon, and for "serving up" a great variety of tasty dishes for the hurried morning meal, after-theatre supper, etc.

A little familiarity with this handy appliance will develop a number of ways of using it to advantage. In toasting sandwiches, they must be buttered on the outside to obtain an even brown. The

grill in the illustration also has a separate pan to be attached for frying and broiling.

This grill contains two heating units between which the sandwiches are placed for toasting. The units are adjustable to accommodate different thicknesses and the temperature is kept constant by a thermostat. The toasting grids, as well as the broiling and frying grids, are removable for cleaning.

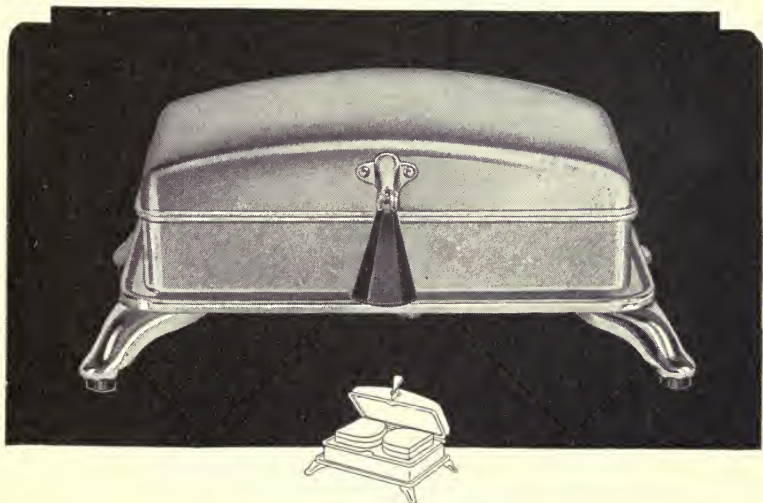

FIG. 212.—“Edicraft” sandwich grill

GRIDDLES. For frying pancakes properly, a griddle which has a uniformly heated surface and which is large enough for a hungry family is desirable. Electricity admirably performs this service in an electrically heated appliance especially designed for this one purpose. The broad, flat surface of smooth aluminum, with no appreciably raised edge to interfere with the implement used for turning the cakes, makes it a most desirable appliance to include in the dining room group of “handy serving-maids.” It may also be used for frying bacon and eggs and other dishes not requiring a deep cooking pan.

Portable Electric Cookers

There are four distinct types of cookers available, each having somewhat different characteristics from the others and therefore best suited to a particular use, but all four being alike in that they operate

on the oven principle, one or more heating units being made an integral part of a closed container. These four types are usually referred to as oven, cooker, casserole and roaster.

OVENS. In the general type of portable oven the heating units—one or more in number depending upon the size and heat-capacity required—are mounted directly in the oven and are arranged to quickly produce a high temperature for baking. Ovens of this type, of which there are several sizes and kinds to choose from, are the same as those used in the electric range except



(Knapp-Monarch)
FIG. 213.—Portable potato baker

that they are self-contained and portable.

For light work, there are small ovens not provided with self-contained heating units, but being heated by placing them over a hot plate. The oven heat is regulated by varying the heat in the hot plate, and a thermometer in the door indicates the inside temperature. These ovens are usually heat-insulated, like the larger self-enclosed unit types, and may be had in square and rectangular shapes. (Fig. 211.)

Another type of portable oven, circular in shape, is shown in Fig. 213. It is well adapted for baking potatoes and apples and for warming pies and other foods before serving. It has a self-contained heating unit, but is not heat-insulated. Its light weight and attractive appearance bring it within the general class of serving-table appliances.

COOKERS. The electric waterless cooker is another form of portable oven,



FIG. 214.—Portable cooker of the fireless type

usually cylindrical in shape, in which you can very conveniently bake, boil, roast, stew or braise a large variety of foods according to the amount of heat you use. Direct heat, both high and low, may be obtained as desired and stored heat may be used for slow cooking of several foods at one time by using different containers.



FIG. 215.—Portable electric casserole

A small heating unit is mounted between the inside lining of the cooker and its outside case, which is thoroughly heat insulated, making the cooker very economical to use.

These cookers may be connected for low heat and left to take care of themselves, thus relieving you of any further attention. Such a cooker, shown in Fig. 214, will be found especially convenient for the summer home or camp. Food can be cooked in the morning and, by taking the cooker along it will keep hot for picnic lunches or camping trips. If you plan an all-day picnic, a time-switch will automatically turn on the electric current in the cooker and start the cooking process early in the morning. After breakfast you can put the cooker in the car and have a hot lunch at noon without the least bother. It has a handle and is easy to carry.

Some electric ranges now have one of these cookers included, either in place of a surface burner or in a lower cabinet.

CASSEROLES. There are many foods cooked in an ordinary casserole placed in an oven, but in Fig. 215 is shown a casserole which

may be used independently of an oven anywhere electricity is available. During the cooking process the outside of the casserole remains cool and thus it may be used on the table as a serving dish. It is an ideal waterless cooker, retaining all the savory flavors of the food.

The heating unit encircles the sides of the casserole, making it less likely to burn foods. Two heats are provided—high, for starting the cooking until steaming commences, and low, for continuing the cooking without further attention. Furnished in porcelain, enamel or chromium finish, it is easy to keep clean and food will not stick to the bottom when cooking.

Casseroles are also available in pairs, or in

combination with a hot plate, to increase their range of usefulness, as was suggested in Fig. 209. The casseroles used in these combinations may be removed from their heating containers for serving and for cleaning.

ROASTERS. For roasting meats, and for cooking a whole meal at one time, an oval-shaped roaster, shown in Fig. 216, will be found



FIG. 216.—Portable electric roaster

very convenient. It contains two heating units—one in the bottom and one encircling the sides—arranged for high and low heats. The foods are placed in the cooking well, or in separate removable cooking pans of porcelain enamel made to nest in the oval well, so that three foods may be cooked at one time. A baking set may also be used for baking pies, cakes, bread, etc. Heat insulation on the sides and bottom conserves the active heat and greatly increases the efficiency. The roaster has a porcelain lining and, like the casserole, it may be used on the table as a serving dish.

Food Warmers

Food warmers should not be confused with hot plates, for they have entirely different purposes. The food warmer, or warming oven, is not designed for cooking, but rather for keeping warm, dishes already prepared. It has a flat surface containing enclosed heating elements, usually having three heats operated by a single switch, and is obtainable in different sizes. They are often a part of the electric range or, for the larger homes, are built into a kitchen cabinet, as shown in Fig. 217. The small stove, already shown in Fig. 210, may be used as a food warmer since it gives a continuous low heat, especially desirable for warming liquids. The small round oven, shown in Fig. 213, is useful for warming foods such as pies, biscuits, etc.



FIG. 217.—Electric food and plate warmer

Toasters

Toast at breakfast is almost a necessity in the American home and the electric toaster is one of the oldest and most widely used of

appliances. The majority of toasters now on the market are made with beautiful non-tarnishable chromium finishes, creating not only a greatly improved appearance but obviating the necessity of polishing. They are always bright and attractive and the heating elements of these improved types toast much more rapidly than the elements of the former types.

Toasters vary slightly in size, but the majority either toast one piece of bread on both sides at the same time, or two pieces on one side. If you have a large family, you may need a model that toasts two pieces on both sides at one time.

In selecting a toaster you have your choice of two types: the

open element type or the oven type. In the open element toasters, which are practically all vertical, Fig. 218, the bread is placed on hinged racks, one on each side of the open heating element, and after the bread is toasted on one side, you either turn the bread over with your fingers, or the toast simply slides down and reverses itself when you turn a handle. A few of the open element type toasters are horizontal, in which case the bread is laid on a flat rack sometimes hinged and reversible, but these are not so universally used.

In the oven type, which may be either vertical or horizontal, but more commonly vertical, the bread is toasted on both sides at one time, since a double heating element is used.

The majority of the open element type toasters are not automatic, since you must turn the handle to reverse the toast. On the other hand, practically all of the oven type toasters are automatic. This type is becoming increasingly popular and the latest models are very satisfactory.

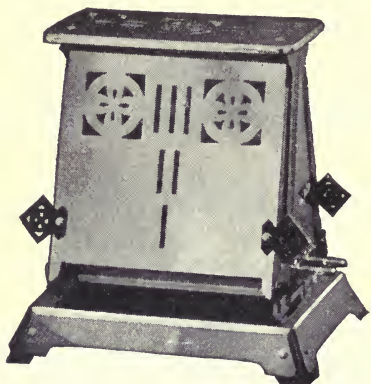

(Westinghouse)

FIG. 218.—Non-automatic toaster

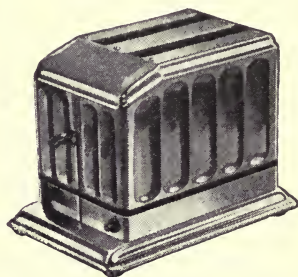

FIG. 219.—The "Toastmaster" automatic toaster

A typical automatic toaster, shown in Fig. 219, contains a thermostat which controls a clock mechanism for timing the toasting period. This flexible arrangement of controlling the clock toasts all slices of bread uniformly. It has a regulator, in the form of a dial, which you set for the desired degree of brownness. With this type you put in the bread, push down a lever which turns on the current, and the built-in timer automatically releases the toast when it is properly browned, and turns off the current.

Although automatic toasters are more expensive than the non-automatic, their convenience and economy make them worth the extra cost. With automatic types the possibility of burning the toast is eliminated and there is the added convenience of not having to give the toaster your constant attention. You can have your toast just the way you want it, with every piece exactly the same.

It is better to set a toaster having an open bottom on a tray rather than on a padded table cloth, since this would interfere with the air circulation of the toaster.

Waffle Irons

A waffle iron is an invaluable appliance, for not only is it used for making waffles, as its name implies, but delicious luncheons and

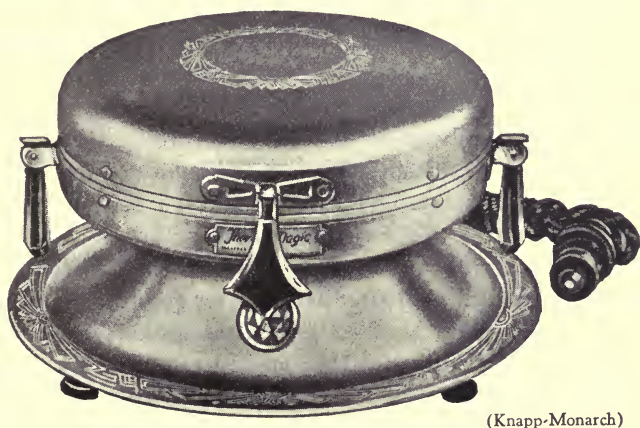

FIG. 220.—Automatic waffle iron

suppers may be served with it as well. It can always be relied upon in an emergency. The convenience of the electrically operated waffle

iron has made waffles one of today's most popular dishes. Never try to serve more than six people at one time, however, unless you have a second waffle iron in use.

Practically all waffle irons are now either automatic or have a baking-heat indicator. The automatic waffle iron maintains the correct temperature for baking, with various methods used to indicate it. One type, for instance, uses a revolving disk that shows the words *cold*, *bake*, *too hot*, through an opening in the upper right griddle, whereas another flashes on a red light when it is time to pour on the batter, and turns the light off when the waffle is done. Fig. 220 shows a typical waffle iron.

Be sure that the iron is sufficiently heated before the batter is put in, for if it is not hot enough the waffle may stick. Do not open the iron until the batter has stopped steaming. When no more steam can be seen, the waffle is usually done, but a little more time may be necessary if you like your waffles particularly crisp or well browned.

In addition to the heat control, some automatic irons have a regulator which may be set for the degree of brownness you wish. If the waffle iron has no heat indicator, or automatic device, there are several ways of determining when the griddles are at the right temperature for cooking. Put a teaspoonful of water inside and when the iron stops steaming the temperature is correct. Another method is to put a piece of white paper between the griddles, and when the paper is golden brown the iron is hot enough to use.

The maker's directions for the use and care of the waffle iron should be followed, although a few general rules may be applied to almost any iron. Practically the only care you have to give it is when you first use it. Grease both griddles with oil or an unsalted fat, painting them with a tiny pastry brush. Cook and throw away the first waffle, and then the iron is ready for future use and seldom needs further greasing. Needless to say, the griddles are never put into water or washed, although they may be wiped with a dry cloth, and if the batter should chance to stick, it can be removed with a small wire brush. If it continues to stick, the oil film is probably gone, and you will have to grease it again, as at first. After you have finished using the iron, leave it open to cool in order to preserve the oil film.

Chafing Dishes

Whatever one may think about the merits or demerits of beer, whether of the "3.2" variety or any other percentage, there is one thing that brooks of no denial—that is, the return of the chafing dish to popular favor among our select group of "party" appliances. Those who appear to speak with authority in the matter of "Welsh Rabbit" recipes claim that no "Bunny" is worthy of the name unless made with beer, and so we find that the good old days of the convivial "Three Musketeers"—the stein,



FIG. 221.—Electric chafing dish

the rabbit and the chafing dish—have come back into vogue with wide acclaim! Nor need there be any fear of violating the law by the use of too much alcohol, or of burning tablecloths and ruining the finish on mahogany surfaces, for the reincarnated "3.2 model" of chafing dish is electrically heated. It would be too much like carrying coals to Newcastle to explain to old devotees of the famous melted cheese and cracker dainty how the chafing dish performs its mystic rites, but for the benefit of the younger set whose memory of "Blue Ribbon Days" may be somewhat dim, Fig. 221 shows an old friend in modern party dress. The chafing dish may also be used for cooking other dishes where the direct heat should not come in contact with the food.

Coffee-Makers or Percolators

Coffee makers are either of the percolator or drip type. The percolator type can be obtained in practically any size, material or style that you may wish. For the small family there is the three-cup, and for the large family the nine-cup, with other sizes in between. The standard size, however, is the six-cup which is made with a finish for every purpose. If you want it for use in the kitchen, an

aluminum percolator will probably be satisfactory. Fig. 222. For formal occasions, the silver-finished percolator is more appropriate, but there are also other finishes such as porcelain and glass to choose from. For ordinary use in the dining room or breakfast nook,



FIG. 222.—“Hotpoint” coffee percolator

chromium and aranium which do not tarnish, or a pretty china pot, are preferable to tarnishable materials, such as nickel and copper. Perhaps the styles, rather than the material, will determine your choice, for you may wish to carry out the period style of silver used in your dining room.

The method of making coffee in the percolator type is simple. Hot or cold water is put into the percolator; the coffee, ordinary or steel cut, placed in the perforated covered basket on top, and the current is turned on. The percolating tube, which carries the water up, extends from the center of the base up into the basket and may, or may not, have a valve.

Some features, however, are essential to satisfactory service with the percolator type. Since few of them are automatic, you may find that a safety fuse or a circuit-breaker is used so that, if the current is left on accidentally, the circuit breaks before the percolator can be damaged. It is common practice for manufacturers to supply extra fuses with non-automatic percolators, and it is always best to keep a few spare ones on hand. Fuses can be replaced very easily by unscrewing the base of the percolator and following the simple directions either written on the bottom or contained in an accompanying folder. There is an automatic type of percolator, however, which has a thermal protector—that is, a built-in device which prevents damage from overheating, even if the percolator should become dry. When a predetermined temperature is reached, the current is automatically turned off.

Most percolators of the drip type are automatic, but in a different sense; that is, they make coffee automatically. The water goes through the coffee once and then slowly drips down. Many believe

that coffee made by this method is much better in flavor, because water remains in contact with the coffee grounds for only a few minutes.

Most of the drip types are made of metal, but there are a few designs where the coffee comes into contact with practically nothing but glass. This latter drip type consists of a separate stand containing the heating element and two glass bowls, one on top of the other, with a perforated porcelain drainer covered with a filtering cloth between them. Fig. 223.

A spring, which runs down through the tube, holds the drainer in position. Pulverized or finely ground coffee is put into the upper bowl and water into the lower bowl. As the water heats, it is forced to the top bowl by the pressure of expanding air and steam, and in a few minutes the brewed coffee drips to the lower bowl through the pull of the vacuum created. Then the top bowl, drainer, etc., are removed and the coffee is poured from the lower bowl.

The heat may be left on to keep the coffee hot, although it should not be allowed to reach the boiling point. A chromium-finished cap, containing a slit for holding tea balls, is furnished with some models if you wish to convert it into a teapot.

Some care, of course, is necessary in washing percolators, for the heating element should not be immersed in water. The movable parts should be taken out and the inside wiped out with a damp cloth and finished with a dry one. Each maker, however, gives special directions for the care and use of his percolator, and by



FIG. 223.—“Silex” coffee maker

reading these carefully and following the recommendations, you will derive the best results.

Egg Cookers

One of the simplest applications of electricity is in cooking eggs, a device used for this purpose being shown in Fig. 224. All that is necessary is to place the eggs in the cooker and put in a teaspoonful of water for each minute you desire the eggs to be cooked. The water forms an electric circuit causing it to boil until it is evaporated, thus providing the timing element of the device. The steam from the boiling water cooks the eggs. That's getting it down pretty simple, especially where there are no moving parts to wear out or to cause trouble. The standard sizes will cook from one to four eggs and are extremely convenient for use on the dining room table.

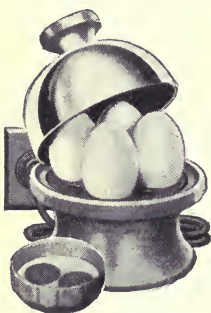

FIG. 224.—“Hanks-craft” egg cooker

An extra casserole dish which comes with this appliance may be used for coddled and baked eggs and custards as well. For such purposes the water is placed in the bottom of the cooker and the baking is timed in that way.

Directions are furnished for the care of the cooker, which must be cleaned occasionally since a lime deposit will form from the evaporation of water.

Corn Poppers

Corn poppers are useful not only for making pop-corn at Hal-lowe'en parties and gatherings, but also for roasting chestnuts and freshening nuts. Most corn poppers are made inseparable from the heating element and for this reason they cannot be immersed in water for cleaning.

All corn poppers work on the same principle. After they are heated for about five minutes, the corn is put into the receptacle over the heating element and is kept in motion by a gyrator with an insulated knob on the outside of the cover. Fig. 225. The gyrator is turned by hand or by a small motor, and since poppers are not

usually equipped with a thermostat, one has to watch the corn to see when it is done. All types have perforations for allowing the moisture to escape. Turn off the current and empty the popper as soon as the corn is done, or it will stick and burn. Then wipe the inside with a dry cloth. Do not put salt or butter into the popper; do that in another dish.

Since the heating element in corn poppers is contained in the base, care must be taken to set the popper on a mat or pad if it is used on varnished or painted surfaces. The slight downward heat might discolor the surface.



(Dominion)

FIG. 225.—Electric corn popper

Doughnut Bakers

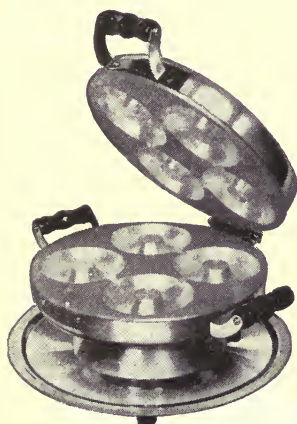

(Dominion)

FIG. 226.—Electric doughnut baker

Baking doughnuts right on the dining room table may be accomplished with the baker shown in Fig. 226. No grease is used and four doughnuts may be baked at one time. Just turn on the current and allow the baker to heat for about twelve minutes. Then fill each of the four moulds with the batter and in a few minutes more you have your cooked doughnuts, and without any grease. An indicator on top of the baker shows you the temperature. After making all you need, just wipe the baker with a damp cloth, allow the baker to cool and put it away.

Plate Warmers

See Food Warmers, page 337.

Electric Deep-Fryers

The deep-fryer, shown in Fig. 227, is well adapted for preparing French-fried potatoes and similar oil-cooked foods. The device has an electrical heating unit in the bottom.



(West Bend)

FIG. 227.—Electric deep fryer

A safety expansion chamber prevents any oil from bubbling over the side of the utensil, thus eliminating the possibility of burned fingers or fire hazard. It will also be found useful for preparing other foods such as pork chops, cooking them brown in five minutes, and stewing oysters in a minute or two, while doughnuts may be fried in from three to five minutes.

This device is economical in its operation, requires less oil than with ordinary deep-frying methods, and the accurate temperature guide prevents loss of oil through absorption or decomposition. The cooking oil may be used over and over again by cleaning it through filter paper. When oil has been heated to the required temperature it is often possible to turn off the current, allowing the food to cook on stored heat in the oil.

The fryer can easily be cleaned by means of water and soap flakes. The current is turned on and water in the fryer allowed to boil. After this it is just a matter of washing it out and letting it dry. The heating unit should never be immersed in water at any time.

Wiener Cookers

Here again we have the use of electricity in its simplest form where the "hot dogs" are cooked by running the electricity through them. Alternating current should be used. The electricity boils the water contained in the food and causes it to do its own cooking. Such a cooker, shown in Fig. 228, has another automatic feature

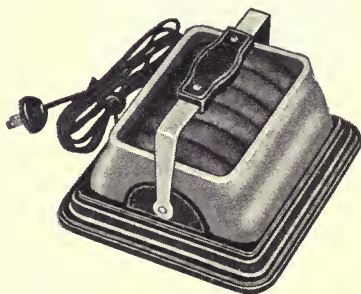

FIG. 228.—Electric wiener cooker

inasmuch as the carrying handle also controls the switch. When the handle is in its vertical position the current is on, and when the wieners are cooked the handle is put to one side or the other of the device, automatically shutting off the current and leaving free space for handling the wieners. These devices are furnished in different sizes and colors to suit one's fancy.

Milk Bottle Warmers

Did you ever have to get up at two o'clock in the morning and go downstairs into the kitchen to warm the baby's bottle? If so, you will appreciate to the fullest extent the automatic electric bottle warmer, which you can place on your bedside table at night. Fig. 229.

A metal time-table, one on the cord and another on the bottom of the warmer, instructs you as to how much water is required to heat the milk to the correct temperature, for the number of teaspoonfuls of water determines the temperature of the bottle, just as in the egg cooker previously described. For instance, one and a half teaspoonfuls of water are required to heat four ounces of milk, two teaspoonfuls to heat six ounces, two and a half to heat eight, and so on. Then at feeding time, all you have to do is to turn on the current, pour in the previously measured water and put in the bottle of milk. In from three to five minutes the bottle is warmed to the correct temperature, so that it needs no testing, and the current automatically goes off.

On the bottom of the warmer will be found directions for cleaning, which consist merely of unscrewing and removing the heater plate in the bottom and scrubbing the device. It is made of porcelain in a variety of attractive colors and modernistic designs and is very easy to keep clean.

Metal-type bottle warmers are also available. Since they are not automatic, you have to fill them with water to the milk level in the bottle and make your own temperature tests.

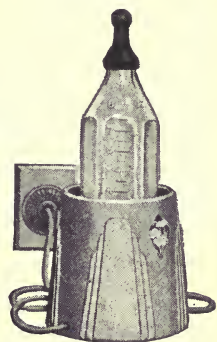

FIG. 229.—“Hanks-craft” bottle warmer

MECHANICALLY DRIVEN FOOD PREPARERS

The electrical appliances I have been describing are all built around the heating wire, or "element," as the complete unit is called. In addition to cooking appliances, electricity provides many other helpful servants for use in the kitchen where mechanical power, instead of heat, is required.

Where power is needed to operate an appliance, a small electric motor is used. Such motors are the heart of the appliances they operate and simply change electricity into mechanical power.

Following is a description of a number of such appliances or "Food Preparers," as they are sometimes called.

MIXERS AND BEATERS. Mixers and beaters have saved women more time and relief from drudgery and arm-ache than almost any other small appliance. Your cake or muffin batter is mixed without any expenditure of energy on your part, while you are measuring the next ingredients, or doing something else. And when time is at a



FIG. 230.—The "Quick-Mix" small portable beater

premium, or when unexpected guests drop in at the last minute, your beater can be making you a dessert while you are eating the first course.

Not all beaters, of course, will mix all kinds of batters, for the lighter ones are not designed for heavy work. A slightly heavier type is made for beating light batters, such as those for waffles or muffins and for making mayonnaise. There is also a small beater and drink-mixer which has only one speed and is usually restricted to mixing drinks. With a suitable attachment it can be used for beating eggs, cream and for making mayonnaise. Such a mixer is shown in Fig. 230 and is provided with a hook for hanging on a wall when not in use.

The majority of beaters, however, can be used for mixing heavy batters, so you should make sure that the machine you select is capable of doing sufficiently heavy work.

Some of the models made with a combination beater, juice extractor, food choppers, etc., may appeal to you. Fig. 231. Changing from one attachment to another is easily accomplished.

The beater that has non-tarnishable double blades, well reinforced, and at least two speeds for different kinds of work, is very serviceable. A beater should have a good, solid support so that it is not likely to fall over when left to operate by itself.

Beaters and mixers require very little care, except cleaning. The attachment is removed, washed and replaced,

and the maker's directions are followed for the occasional oiling it may need.

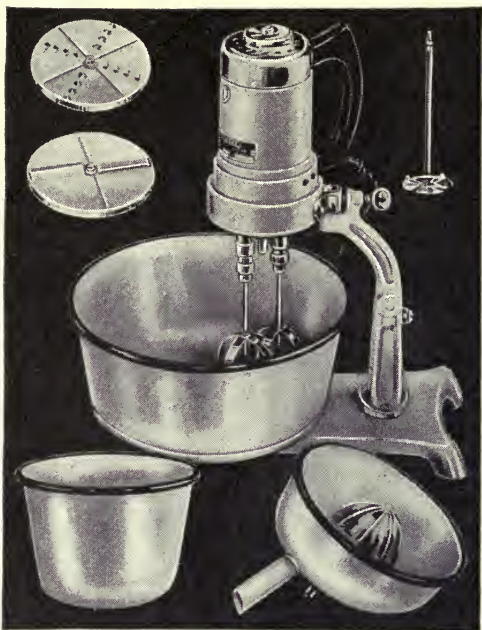

FIG. 231.—“Universal” food preparer

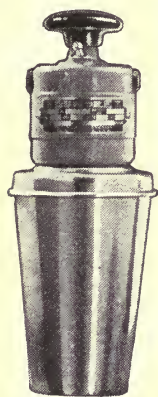
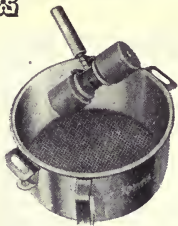

FIG. 232.
“Dumore” drink
mixer

DRINK MIXERS. For properly mixing drinks several types of portable mixers operated by a small motor are made, a typical one being shown in Fig. 232. Remember that non-tarnishable metals or special finishes are an advantage since they will require less care and last longer.

FRUIT JUICE EXTRACTORS. Another convenience in any home is a fruit juice extractor. Many of these extractors, as already mentioned, are combined with a beater. Here again a small motor provides the power for removing the juice from such fruits as oranges, lemons, etc.

ICE CREAM FREEZERS. A small motor attached to an ice cream freezer saves a whole lot of muscle



Colander, sieve and roller set



Shredder plates



Fruit juice extractor



Ice or hot water jacket

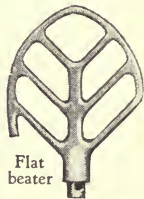

Flat beater

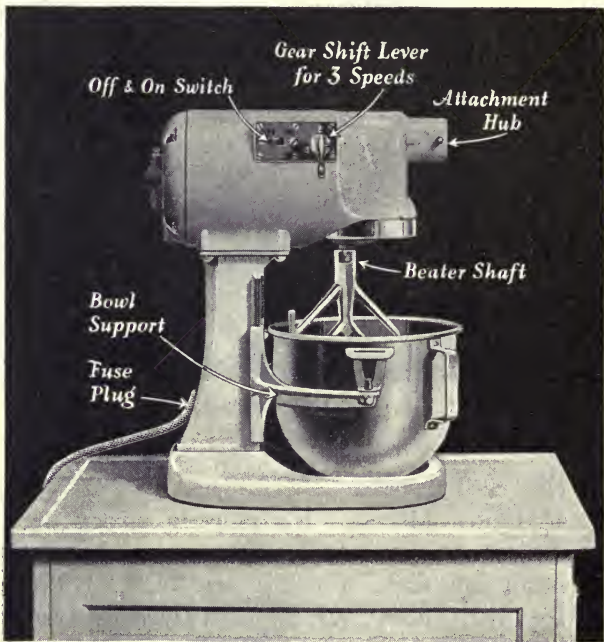

Wire whip



Coffee and cereal grinder



Oil dropper

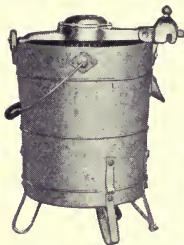

Ice cream freezer

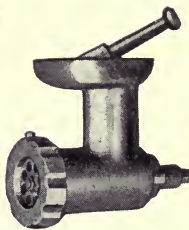

Food chopper

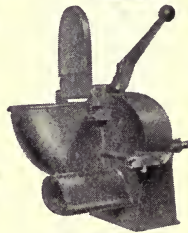

Vegetable slicer

FIG. 233.—"Kitchen Aid" electrical food preparer

and makes freezing ice cream a pleasure. Electrically driven freezers are available in several sizes and types. A typical freezer is used with the kitchen mixing outfit, employing the same motor that operates other attachments.

KITCHEN MIXING OUTFIT. A complete outfit for food preparation, shown in Fig. 233, will perform practically all the duties of food preparation. It is a complete, self-contained outfit with many fittings for grinding meats, nuts, coffee and other foods, and for beating and stirring, extracting juice, freezing ice cream, etc. With the exception of the ice cream freezer, everything is self-contained—a place for everything in the cabinet drawers and easy to keep clean.

Complete and substantially made equipment of this type that will last a lifetime is most desirable. It requires no special care and its cost of operation is only a few cents a month.

PRESERVING FOOD ELECTRICALLY

THE ELECTRIC REFRIGERATOR. The practically universal acceptance of the mechanical refrigerator, Fig. 234, and its constantly increasing use is sufficient proof of the superiority of that method of food preservation, so that time will not be taken to mention all of its advantages. There are, however, several points to be kept in mind in the selection of the proper refrigerator for your particular needs and its care in every-day use.

In the ordinary ice chest, cooling is obtained by melting ice which absorbs the heat from the foods placed in the box. A disadvantage of using ice as a cooling medium is in not being able to make any frozen desserts or convenient ice cubes of pure water. The mechanical refrigerator has overcome this, as well as other disadvantages, and at less cost in practically all cases.

The use of ice in the ice chest of other days seemed simple enough: just keep the ice compartment filled with ice, drain off the water from the melting ice and place the ice chest in a cool place to make the ice last longer. This was not so simple after all, for when the mechanical refrigerator was developed it was found that it required no ice renewals, could be placed anywhere desired, and did a much better job of food preserving. It was like the discovery of a cake of ice that would not melt and had a much lower temperature than any ice made by freezing water.

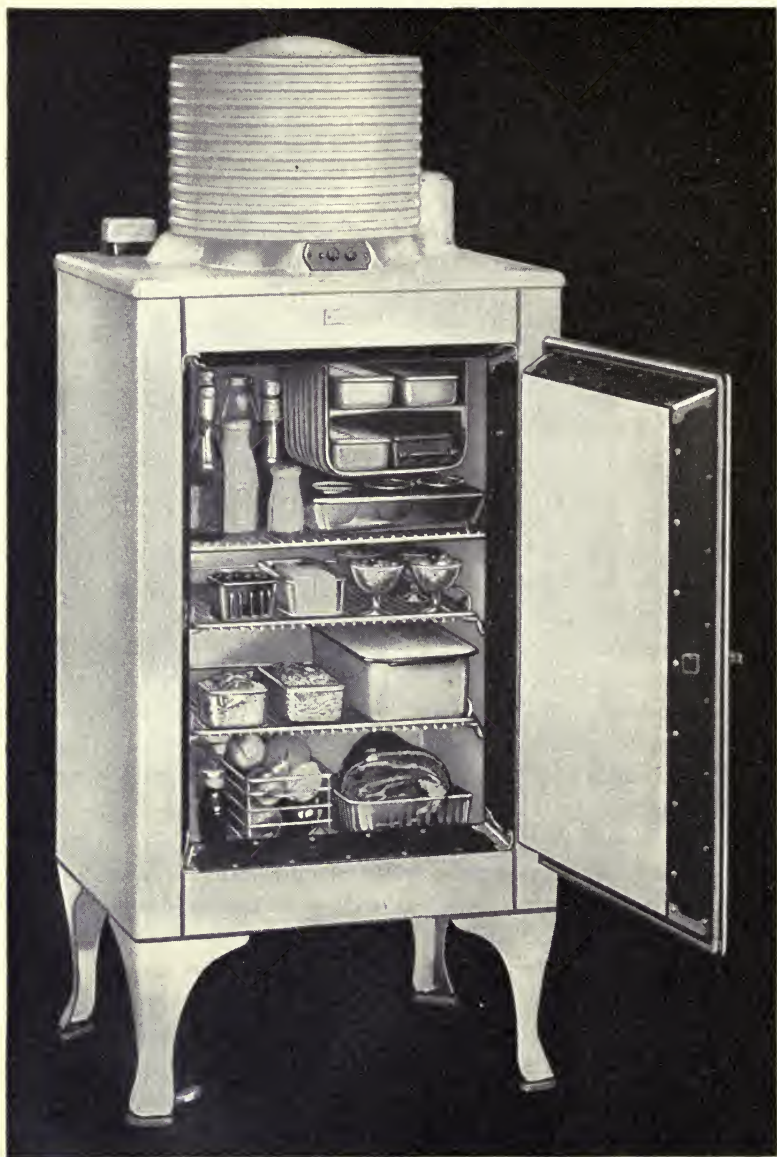

FIG. 234.—Modern electric refrigerator. Door-opening pedal shown at foot of lower left leg. Automatic door-switch for lighting interior

The principle of the refrigerator is just the reverse of that of an oven. Both employ a heat-insulated chamber—one to confine the heat within and the other to keep it out. But in the case of the refrigerator, the heat must first be removed. This heat is contained in the air inside the refrigerator, and in the food or water you put into the refrigerator. In any case this heat must be removed in order to preserve the food or freeze the water. In the case of the oven, we must have means of heating food evenly to a high temperature, probably as much as several hundred degrees for a short time. In the case of the refrigerator, the temperature must be maintained continuously below 50 degrees, and above 32 degrees.

Electricity performs both heating and refrigerating duties in an extremely simple manner. In the oven, it makes coils of wire red hot and raises the temperature of the chamber, while in the refrigerator it runs a small motor which in turn pumps the heat out of the refrigerator and thus lowers the temperature of the chamber.

In order to take full advantage of modern refrigeration, it is well to learn some of the fine points of food preservation. The question of temperature necessary for proper refrigeration has been very definitely settled by medical and health authorities. For household purposes, if food is kept at a temperature below 50 degrees Fahrenheit, the danger of bacterial growth or spoilage is practically eliminated. There is, however, an advantage in keeping many foods at even a lower temperature. Milk, for instance, will keep much longer at a temperature of 40 degrees, and uncooked meat will remain in proper condition for a longer period at lower temperatures. In general, however, if a constant temperature below 50 degrees is maintained, food will be excellently preserved for ordinary periods.

Constancy of the proper temperature is also important. With melting ice this is not possible on account of the changing volume, and with ice chests no automatic means are available for making replacements at proper intervals. The changing temperature of an ice chest, even though it never varies as many degrees as the temperature of the external atmosphere of the room, tends not only to reduce the effectiveness of refrigeration, but affects the crisp freshness of many vegetables and impairs the preservation of all foods.

If you are using an ice chest, it might be well to see whether or not it is giving you sufficient protection by putting an ordinary household thermometer inside. Make this test with varying amounts

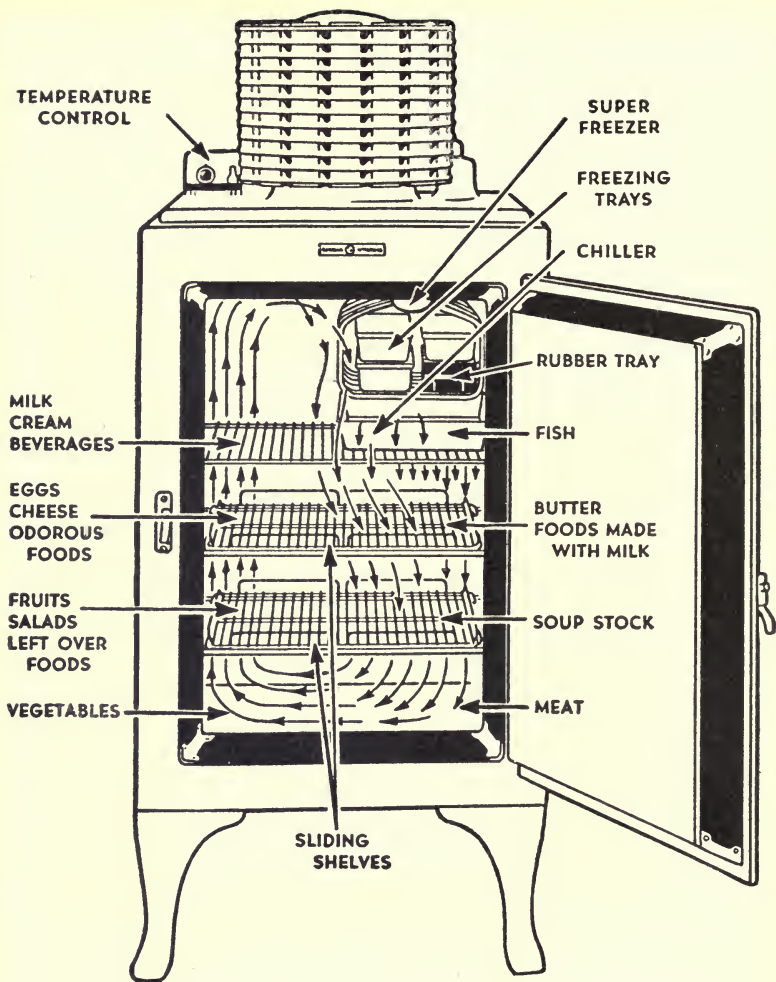

FIG. 235.—Proper arrangement of food in modern refrigerator

of ice in the box. While the temperature should be fairly uniform throughout the box, the lower shelves will be slightly colder than the upper ones, but nowhere in the ice chest should the thermometer read higher than 50 degrees. It is this slight difference in temperature that causes air circulation, the cold air near the refrigerating unit dropping to replace the warmer air which, in rising, is again cooled. The free circulation of air inside the refrigerator is, therefore, most

important and for this reason plenty of room should be left around any food or dishes on the shelves. This necessity for free circulation of air is the reason for the use of wire mesh shelving.

ARRANGEMENT OF FOOD IN THE REFRIGERATOR. Since some foods are better preserved at lower temperatures, the location of various articles should be given careful consideration in order to take full advantage of the economy possible through proper refrigeration. A suggested location for different foods is given in Fig. 235.

The amount of moisture in the air within the box also affects the preservation of food in the refrigerator. In early days, before the effect of refrigeration was known, or in climates where ice was unobtainable, food was dried to preserve it, and it has long been known that the less moisture there is in and about most foods the longer they will keep. Naturally the air within a refrigerator is not dry in the same sense that a sun-dried atmosphere is and, therefore, refrigerated foods differ from dried foods and happily so, as we well know. While no one today would care for dry, moistureless foods, we must keep in mind the fact that in the modern electric refrigerator we are dealing with a principle of refrigeration which aims to avoid actual freezing, since this tends to break down the cellular structure of the foods. Therefore to assist this principle, too much moisture in the interior of the box should be avoided. Also a reduction in the moisture of the air within the box will prevent the formation of mold. The air in the electric refrigerator is always dryer than in ice-cooled chests, because as the moisture-laden air comes in contact with the covering coils, the moisture not only condenses but freezes. Foods to be kept moist, therefore, should be covered or placed in a covered container with a bit of water in the bottom. Thus, lettuce can be kept marvelously crisp at a low temperature for days at a time.

POINTS TO REMEMBER IN SELECTING A REFRIGERATOR. In selecting a refrigerator, consider its continuous use for years to come more seriously than its first cost. Refrigerators are more expensive than many other household devices, and therefore considerable care should be exercised in making your selection.

Proper size and quality are most important so that the refrigerator may meet the particular needs of the family to be served. Then again, is the size of the family likely to be increased? A box sufficiently large to provide accommodations for quantity purchases is advisable, for it takes but little more electricity to cool a large box

than a small one. In this way, shopping trips can be limited to not more than two per week, saving both time and money, for often it is possible to take advantage of low prices on particular days and lay in supplies at reduced cost. Then again, there should be ample room for "left-overs" which, when used, mean economy.

A general rule is to provide two cubic feet of content for each person in the family. Refrigerators are rated by their internal size expressed in cubic feet of storage space. This internal size or volume is obtained by multiplying the height, width and depth (all measured in feet) together, less the space occupied by the chilling units. If all measurements are in inches, multiply them all together and divide by 1728, the number of cubic inches in one cubic foot.

The cost of maintaining a low temperature is primarily dependent upon the efficiency of the heat insulation in the box. In other words, the amount of electricity necessary to keep the contents below 50 degrees depends on how well the box keeps out the heat of the room. Attention, therefore, should be given to the construction of the box, the fit of the doors, the type of lock which keeps the doors closed, etc. Unless the cabinets are carefully constructed they are apt to warp or crack, thus allowing warm air from outside to get into the box. The insulating material inside the walls of the box is also most important. It is not always economy, therefore, to buy the less expensive refrigerator, for the insulation or the construction may not be as efficient. Every day, winter or summer, the inside of the box must be kept many degrees cooler than the room.

The cost of electricity varies in different localities, but in general, mechanical refrigeration is a saving over ice for cooling the same size box to a proper temperature. In many communities, special rates for electricity are available when a refrigerator is installed. It would be well, therefore, in purchasing an electric refrigerator to make sure that you are being given this advantage.

The arrangement of the shelves and their spacing has much to do with the amount of food that can be placed in the refrigerator, and a wide shelf will hold more dishes than two narrow shelves having the same total area. A properly designed refrigerator will have the maximum of shelving area for the external size of the cabinet.

Accessibility of the cooling unit within the refrigerator cabinet makes it easier to keep clean. This unit requires cleaning both inside and out. The cooling machinery of most refrigerators may require

occasional oiling and, if so, the oil cups should be easily accessible and should be so located that there is little likelihood of any spilt oil reaching the floor of the room. Some machines, however, do not require oiling.

It is also a great advantage to have the cooling machinery so designed and constructed that it will operate quietly and without attention for an indefinite period of time. The fewer the exposed moving parts used in this mechanism, the greater the freedom from disagreeable noise.

If the corners on the inside of the refrigerator are rounded, especially at the bottom, it will help considerably in cleaning. A little step in the door frame in the front of the refrigerator will prevent liquids that may be spilled from running out on the floor.

The finish of both inside and outside surfaces should be of such material that it may readily be cared for and will not lose its good appearance with continual cleaning.

An installation which does not require plumbing connections or alterations in the kitchen area will make it possible to place the refrigerator anywhere you may desire and will simplify moving it to any other location that may be necessary at some future time.

Freezing trays of different sizes will add to the variety of ice cubes.

A temperature regulator is an important factor in the modern refrigerator, since by this means quick freezing of ice cubes or desserts is possible.

The economical use of electricity is, of course, most important, and that factor depends upon the design of the refrigerator, its heat insulating properties and the mechanical cooling element.

ECONOMIES POSSIBLE THROUGH PROPER REFRIGERATION. While proper refrigeration affords economy through making possible larger purchases and fewer trips to market, the reduction in spoilage of foods is an even greater advantage. For instance, many housewives carefully plan to cook a two or three days' supply of potatoes at one time, when they can be sure that they will not spoil. This not only saves fuel in boiling the potatoes, but takes less time.

Even with the most careful marketing, there is bound to be some food left over after the average meal, and if it is kept fresh it can be used in any number of palatable ways. Cooked meat can be kept amazingly well for several days, at proper temperatures. An

efficient refrigerator, therefore, makes it possible to use up even the last scraps of a large roast. A roast of lamb, for instance, can be served hot Sunday noon, again cold for Thursday night's supper, and converted into pot-pie for Saturday. Such economy is entirely possible with proper refrigeration and is not at all uncommon among families where strict budgeting makes it essential to count the pennies.

Preparation of special foods for infants and children is greatly simplified through good refrigeration. It is not only a bother, but a real extravagance, if new batches of broth and cereals, to say nothing of the formula for baby's milk, have to be prepared fresh at every feeding. For variety's sake, two or three kinds of cereal can be on hand if there is a proper place to keep them. Illness in the household also accentuates the advantages of good refrigeration. Custards, gruels, broths and the like can be prepared in quantity, kept in excellent condition, and be ready to serve at a moment's notice.

SPECIAL USES FOR ELECTRIC REFRIGERATORS. Frozen desserts add to the variety of menus for the ordinary occasion and help in entertaining. There are many mousses, frappés and similar dishes which can give that final touch of novelty and taste to a bridge luncheon or evening party. In the preparation of such dainties, it is well not to let them freeze for too long a time. A large bowl of the basic ingredients can be whipped up and left on the refrigerator shelf for use at any time. In this way, a portion of this base can be flavored with several kinds of fruit for serving in two or three different ways on succeeding days.

Mechanical refrigeration is also particularly adapted to the preparation of numberless gelatins for salads and ring moulds. Not only are these dishes most decorative for entertaining, but they are extremely healthful and a decided economy for the usual family dinner. Even the lowly carrot comes into its own for health and decoration when served in a sliced or grated salad form, and is a most appetizing dish for any occasion. Lettuce or parsley, after being kept in covered containers with a little water in the bottom at this low temperature, may be relied upon to be crisp and fresh for serving with salads or as a garnish. The use of ice cubes, either plain or colored, is another unique and convenient product of this modern refrigerator.

The busy housewife can mix a quantity of dough, cut it down once and store it in an electric refrigerator until wanted. Biscuits, cookies and other batters and doughs will keep perfectly until you

want to bake them. Yeast dough will hold its lightness at any stage you wish. Pastry will ripen and be all the better for a day or two of chilling. Wrapping in waxed paper is the best assurance against surface drying.

CARE OF THE ELECTRIC REFRIGERATOR. Electric refrigerators require little care, but there are a few things that the householder should consider. Everything that is put into the refrigerator should be cleaned, and paper wrapping should be removed from food while it is warm, replacing it, if desired, after it is chilled. About once a month it is well to wash the shelves and lining with warm water in which a little borax has been dissolved. It is also important that freezing trays be thoroughly cleaned after the freezing mixtures have been removed. The outside of the refrigerator should be washed with warm water and mild soap. Polish which has a harsh or gritty base should never be used. Follow the instructions of the manufacturer as to the proper care and use of your refrigerator.

Frosting on the cooling unit is caused by moisture collecting on the metal parts of the unit and freezing. The refrigerator should be defrosted at regular intervals by turning off the current and removing the ice cubes from the trays or else removing the trays themselves. The ice tray can then be filled with hot water and replaced in the freezer, closing the cabinet door. In about three-quarters of an hour to an hour the frost will usually be melted; but if not, more hot water should be added and the process continued. The cooling element inside the refrigerator should finally be wiped with a dry cloth. The refrigerator is then ready for further use by turning on the switch. Defrosting should be done at least once a month and preferably oftener. At no time should the frost on the coils be allowed to collect to more than one-half an inch in thickness. Do not remove the frost on the coils with any sharp instrument, but merely allow it to melt during the defrosting process.

To get the best results from a refrigerator, it should not be overcrowded and air should be free to circulate inside the cabinet.

It is best not to keep bananas or any other food in a refrigerator that will keep just as well outside. Bananas spoil rapidly when the temperature is less than 62 degrees.

Do not use ice picks or other sharp instruments in removing the ice trays. Usually a silver knife or spatula will be found sufficient to loosen them. Placing the bottom of the tray under the faucet

will loosen the ice cubes. Rubber ice trays are a great convenience, allowing individual ice cubes to be removed with ease.

Hot foods, especially those with decided odors, should not be placed in the refrigerator. Such foods should first be cooled outside. There is no harm in placing hot foods in the refrigerator, except that it consumes more electricity and entails more frequent defrosting.

IN CONCLUSION. Electric refrigeration is beyond the experimental stage, and assures a greater uniformity of proper temperature than is possible with the average ice-cooled chest. Present credit terms make it easy for almost anyone to own an electric refrigerator and the guarantees now made by responsible manufacturers ensure utmost reliability and maximum service.

In the selection of your refrigerator be sure to consider the proper size for your needs, as well as the construction and quality of the box and the mechanical unit. And be sure to purchase one of the recognized makes produced by a manufacturer and sold through a dealer who will accept responsibility for published claims, both as to the quality of product and the dependability of service. Mechanical refrigerators are sturdy and, if properly built and installed, should not require attention for many months. Some day, however, a part may need renewing and you should be able to obtain it without delay, as well as to have it installed without replacing the cabinet. The cheapest box is not always, therefore, the most economical.

A bulb that lights when you open the door, as was shown in Fig. 63, and a foot-pedal for opening the door when your hands are full, are worthwhile conveniences.

In your use of electric refrigeration, take every advantage which it affords. Constant cold is not only an economy, but a necessity if you are going to give yourself through the food you eat that degree of protection which is essential to the maintenance of good health.

WASHING DISHES ELECTRICALLY

Another labor-saving device for the kitchen is the automatic dishwasher. Here again electricity makes itself useful by means of a small motor. No kitchen is complete without this most useful of electric servants, which I am showing you in Fig. 236. The dishwasher will wash dishes cleaner, more hygienically and more quickly than human hands, because hotter water can be used.

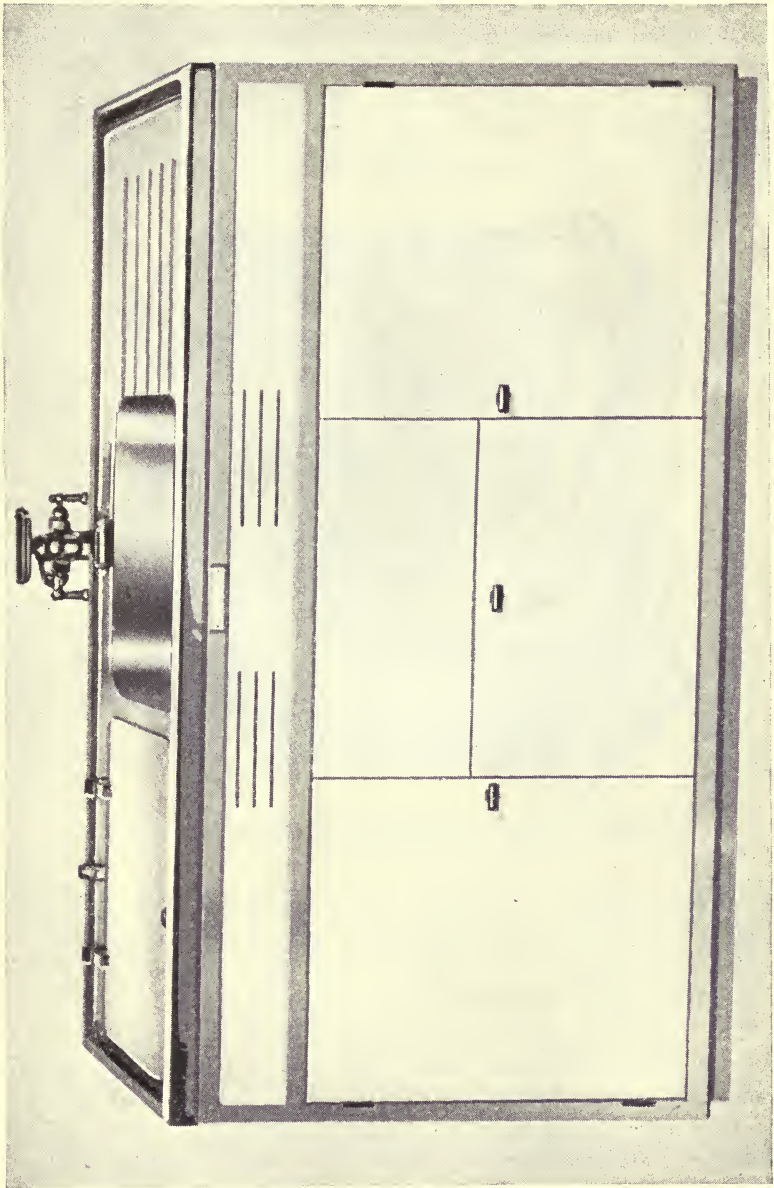

(General Electric)

FIG. 236.—Automatic electric dishwasher combined with sink

The dishes, glassware and silverware are all washed together and in a few minutes' time. Fig. 237 shows how the dishes are arranged in the soft rubber-plated trays, ready for washing. A small amount of washing powder, usually a tablespoonful, is placed in the cleansing container, and the washer cover is closed. The controlling button is then turned to the spraying, washing and rinsing positions

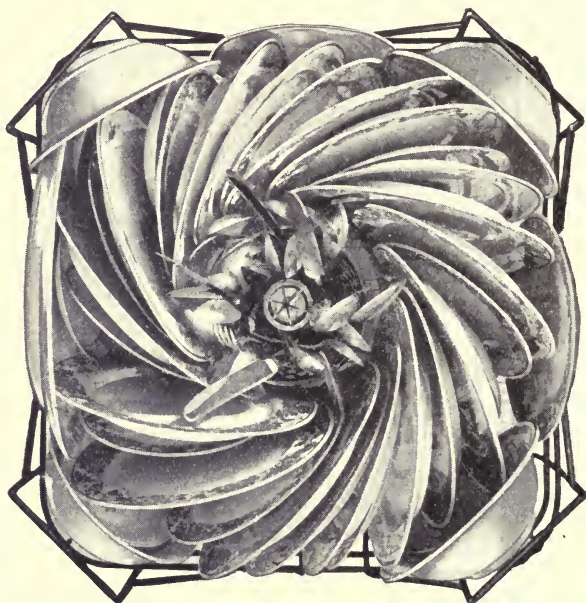

FIG. 237.—Proper arrangement of dishes and silverware in removable tray used with electric dishwasher shown in Fig. 236

for a few minutes—usually three—and the dishes may then be removed. The whole process takes about three gallons of hot water, the hotter the better. The chinaware will dry itself, but it is best to dry the glass and silverware in the usual manner.

The machine is self-cleansing and requires no attention from the operator. The controlling button operates the hot water supply, changes the spray, washing and rinsing water application, and opens the drain all at the proper time, besides controlling the motor. The dishes, etc., are stationary and there is no chance for breakage or chipping—so common with the old-fashioned hand method. Dirty dishes may be placed in the machine out of the way after each meal

and all washed at one time during the evening, if desired. Dishes left standing overnight, and those used for eggs, as well as small open pots and pans, are easily washed. Its cost of operation is about five cents a week.

These dishwashers are furnished as a single unit or in combination with a sink and drain board to suit the requirements of various kitchens, and are finished in white enamel or stainless steel, either of which will last many years. A cabinet underneath the sink or drain board is convenient for keeping utensils out of sight. For best results the dishwasher should be permanently installed in combination with the ordinary sink. This is just as simple as the sink, requiring only plumbing connections and a near-by convenience outlet for the small motor. Portable dishwashers are available having hose connections for both water supply and drain.

THE ALL-ELECTRIC KITCHEN

In that far distant time, following upon the "seventh day" of creation, when man first turned his discovery of fire to the use of roasting the meat of animals and found it more palatable than raw food, the first rudimentary kitchen came into existence. In the beginning, his embryonic stove was no more than a pile of stones to confine the heat of hot embers. Built in the open, or at the mouth of a cave, it constituted the first equipment in that nebulous concept of a home which dawned on the primitive mind of our earliest ancestors.

The faggot fire of the Stone Age, the kitchen hearth of Colonial Days and the electric range of Modern Times differ only in respect to their evolutionary sequence in man's progress. They are alike in that they have come to represent, each in its own period, the embodiment of all those domestic comforts which we call home.

And so today, no less than in ages past, the kitchen enjoys the distinction of being the first room in importance to the true homemaker. Electrical science has drawn unstintingly upon its vast resources, aided by extensive research in fields of home economics, the culinary arts and interior decoration, to achieve that goal of complete electric service, comfort and colorful harmony which woman's needs and tastes prescribe should be nothing less than absolute perfection.

The frontispiece showing a typical All-Electric Kitchen, clearly indicates that the household Utopia of perfect system, convenience and economy has at length been realized. Nor does it stop here, for there is now available to every home in the country a service which enables the homemaker to have planned for her the All-Electric Kitchen Unit of her choice, architecturally designed and complete in every detail of essential utility and beauty.

Thus science and art have indeed combined, not only to emancipate woman from her traditional kitchen drudgery, but to provide for her a room of new and fascinating interest as a further advance in the electrical regeneration of the American home, and for the attainment of higher and happier standards of living.

Many of the appliances already described, if combined in one room, would make an All-Electric Kitchen, but the nation-wide service I have referred to goes at the problem in an altogether different manner than merely assisting you in arranging and adding to your present equipment. Just as the architect works with you in planning the new home, offering you the advantage of years of specialized training in the details of correct construction and design, so does the corps of home economics experts in this service organization or Kitchen Institute start to help you, from the very beginning, with your dream of the ideal kitchen.

These specialists take the floor and wall plan of your existing kitchen, or the one planned for the new home, and work out for you an arrangement that will exactly suit your needs. Not only do they advise you as to the proper use of wall space, location of range, refrigerator, dishwasher, ventilating and lighting system, clock, radio, call-bells and the like, but they assist you also in selecting cabinets and other furnishings, floor coverings, decorations and accessory comforts—all planned to save steps and wasted minutes and designed to give you a harmonious color effect that will vie with the most modern artistic setting secured in any other part of the home.

A plan-sheet drawn up by the Kitchen Institute for both floor and side-walls of the All-Electric Kitchen, visualizes the ultimate arrangement and effect just as an architect's drawing affords a conception of the home to be built. Once this plan is laid out to suit your individual taste, you may then work gradually to its eventual fulfillment or incorporate all its provisions at one time and in

advance of final payment, simply by making convenient installments over an extended period of time.

Just the other day I was visiting a home in which an All-Electric Kitchen had been planned in accordance with this service. The delight of this family was a pleasure to witness. Although like most people in good circumstances they had acquired a coffee percolator, iron and several other portable appliances year by year as they were introduced on the market, finally adding an electric refrigerator to their kitchen equipment, still they had no conception of how marvelously convenient and attractive a "planned" kitchen on a scientific, labor-saving basis could be made until it was worked out for them in their own home.

"You have no idea of the pride I feel in exhibiting my treasure to my guests," my hostess said, as she pointed out to me all the thrilling new experiences she was daily meeting with on this ingenious electric highway and its accompanying "recreational center" the Kitchen Institute service had planned for her.

"Imagine a kitchen giving one a restful feeling!" she continued. "And yet it is true. I simply can't keep out of the kitchen these days, not because of the old bug-a-boo of work which used to hold us enslaved to the cook-stove, the pots and pans, the dishes and the tubs, but because of the fact that I love to be here. And everyone who visits us experiences the same fascination—they make a bee-line for the kitchen almost as soon as they enter the front door!"

And I could well believe it, for here was certainly expressed everything that a woman's heart could wish. In the most amazing way it combined the comfort and coziness of an old Dutch kitchen—the same immaculateness, too—with the businesslike efficiency of an advance auto show, chromium-finish model of a de luxe automobile. I called my hostess's attention to this fact.

"Yes, and perhaps you do not realize what a true comparison you have made," she replied, "for all that you see here—every appliance, cabinet, furnishing and decoration—in short, the All-Electric Kitchen complete, has cost us less than a moderately priced car. And as for upkeep," she added, "the operation of this private Pullman of mine costs but a fraction of what we spend to maintain our little coupé. More than that, there is little depreciation, no yearly models, and my 'All-Electric' will keep its lovely newness for a lifetime of economical satisfaction."

And with that she proceeded to show me all her bright array of electric servants—"My Pullman porters on parade," she laughingly quoted from an old popular song.

Space will not permit repeating the many virtues of the dishwasher, range, refrigerator, juice extractor, cookers, mixers, beaters and all the other electric aids which have previously been described under their individual headings in this same chapter. However, a summary of the more important appliances and equipment for you to consider in contemplating your own All-Electric Kitchen of the future may not be amiss at this point. Following is a suggested list of conveniences for your complete electrified kitchen:—

- REFRIGERATOR: (Page 351) to preserve food properly and provide a safe place for storage. No ice, no leaks, no dirt.
- RANGE: (Page 321) to cook all food properly and economically. No fire, no smoke, no soot. No unnecessary heat, odors or headaches.
- DISHWASHER: (Page 360) to wash and dry all dishes and glassware cleaner, quicker and without breakage.
- KITCHEN MIXING OUTFIT: (Pages 348-351) to prepare food, grind, beat, mix, extract fruit juices and freeze ice-cream—all without human effort.
- FOOD AND PLATE WARMER: (Page 337) to keep plates and prepared food warm until ready to serve.
- PORTABLE COOKER: (Page 333) to supplement the range in cooking special or additional foods.
- SIGNAL SYSTEM: (Pages 294-297) to announce outside calls from telephone and doors and for individual room service.
- RADIO: (Page 267) to benefit from new recipes and helpful kitchen ideas broadcast on home economics programs.
- CLOCK: (Page 284) to assist in the proper scheduling of household duties.

VENTILATING FAN: (Page 300) to keep air in circulation, for greater comfort.

And last but not least, its attractive appearance when assembled renders the All-Electric Kitchen as æsthetically satisfying as it is practically helpful. (See Frontispiece.)

With the above equipment there will be provided, of course, proper illumination, sufficient convenience outlets for both permanent and portable appliances, timing devices for automatic control of baking and cooking so that constant attendance is not necessary, and many other convenient and time-saving features which a modern All-Electric Kitchen provides for your complete comfort and enjoyment.

In building a new home the proper design of the All-Electric Kitchen is easily accomplished, but by careful planning an existing kitchen may be converted to one of the most modern type, adding one item at a time if a limited budget must be adhered to.



PREPARATION FOR SATURDAY'S HOLIDAY

Now comes the most wondrous day of all—the Saturday Holiday. With the two young children home from school and Daddy Day's office closed because of the summer schedule, we knew that a full complement of "Days" would be found at the "Week House" on "Month Street" on this, our final journey into the "Year-Round Realm" of home appliances which you will hereafter use for all "Time."

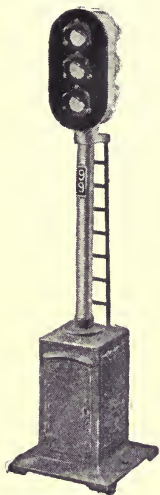

More or less expecting to disturb still further an already distracted household—what with the party of the night before and two little Days hanging 'round clamoring for something to do—we timidly descended the steps leading to Saturday's Room in the basement and signalled our presence.

All was at peace in this quarter of the house, evidently, for we heard no sound. But wait! Suddenly from the back depths of the basement, heard through the screen door, came a strange whirring noise rising and falling on the ear—now dimmer, now louder—which seemed to encircle the basement. There was something about it which suggested a tree-top chorus of katy-dids on a summer's evening. But this was broad daylight in the early morning. And furthermore, we could now distinguish the delighted cries of children—yes, and a man's voice, too—mingling with the mysterious sounds. It was certainly to be doubted that whatever party was in progress was being entertained by a "host" of katy-dids!

We pressed the buzzer again, and this time above the gentle din, our signal was heard—for Mr. Day came to the door.

"Come right in," he said, still beaming with the joy of some game we could see being played by a group of youngsters in the play-room beyond the furnace alcove. "You are just in time to join our excursion to the 'Land of Make-Believe' on our little electric railway. A few of the neighborhood children have come in to play with my two youngsters and we have organized a railroad company. It's a great way to learn geography and commerce, and have real fun doing it.

“We have turned the basement floor into the map of the United States with its rivers, mountains and lakes, agricultural, mining and industrial sections all properly laid out. Each youngster here represents some kind of industry and just now we are transporting products from one part of the country to another just as in real life.

“As you can see, there’s no depression down here. It would be a fine thing if grown people had the same confidence and imagination as these children! And that’s one thing these splendid toys accomplish. Just you wait and see what this coming generation will do when it vaults into the business saddle with all the advantage of this training, helping to formulate its desires as to what it really wants to become!

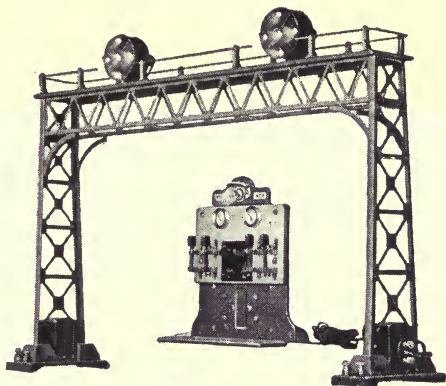

“So now let’s enter into the sport. I am sure you will enjoy it. After all, we’re only children and the best of us get somewhere in life only because we retain a child’s eagerness to do things for the pure joy of action.

“I will be the Chief Engineer,” continued Mr. Day, “and you can be the Board of Directors and just watch, or the train crew and really learn something to your advantage about electric operation. After an hour of this, we are all going to inspect the home workshop in another part of the basement and, under my eldest son’s direction, see how industry is conducted in a bigger way with larger electric tools.

“We are putting on a home movie show tonight for the benefit of the youngsters and perhaps you would like to join the party. We plan to show some of the films we have taken the past few years—vacation trips and little plays we have staged, with members of the family and friends making up the cast. Various scenes have been pieced together and titles added so that our guests may follow the continuity of the pictures with more interest and enjoyment, just as in a regular movie show.’ Some day, perhaps, we shall have real

'talkies' and even 'television' in our little home theatre, but for now we are content with the entertainment and instruction which our present electrically operated movie projector affords, and it is a good way to wind up our Saturday holidays."



(Eastman Kodascope)

"We are putting on a home movie show tonight . . ."



To add to the pleasure of your home movies, or to stage a home concert . . . at the touch of a finger the electrically operated ÆOLIAN DUO-ART will pour forth for you perfect music—when you want it—as you want it . . . and it will be the kings of jazz or the immortals of the concert stage who will play this music for you—right on your own piano!

SATURDAY'S PROGRAM

ELECTRIC TOYS FOR THE CHILDREN.

ELECTRICALLY DRIVEN TOOLS FOR THE HOME SHOP.

Since this is a holiday journey we shall ask you only five questions under today's program. But once you get into the spirit of what can be done with electric toys and tools, the questions you will ask yourself as to the many ingenious developments continually being added to this fascinating branch road of electric service and enjoyment, will know no end.

Do you know what work is in progress in the public schools where toys are used as an aid to education? Do you attend Parent-Teacher Association Meetings, or otherwise help contribute to this worthy cause?

Do you ever take the children on excursions through the toy departments of the stores in your neighborhood—not only at Christmas-time but occasionally throughout the year? You will find that doing so is, in itself, an education—for parents as well as children.

Do you subscribe to any children's magazines—as a means of stimulating the growing boy's and girl's imagination in matters of worthwhile educational interest?

Have you ever visited the school which your children attend to see them all happily at work in their vocational occupations? Do you encourage them in these natural interests by providing suitable home equipment for their use, supplemental to their school work? Many schools can afford to give a child only an hour's use of the school shop equipment each week.

Do you subscribe to any home shop magazines? There are some very interesting and practical ones published which give a broad grasp of the electrical, mechanical and wood-working crafts.

THE SATURDAY HOLIDAY

ELECTRICAL TOYS FOR THE CHILDREN

As a child, I well remember the limitations of mechanical toys that depended upon a spring for their motive power, or the flame of an alcohol lamp for making steam. The children of today are fortunate indeed in having toys operated by electricity which, being safe, do not cause mothers to worry, and which are instructive from a most practical and educational standpoint.

Modern toys are patterned after working drawings of larger equipment and are well constructed and designed. The gift of an electrically operated toy may be the means of developing a child's mental power, as well as furnishing unlimited entertainment. A child wants action. Electricity as a motive power always holds a child's interest and its cost is negligible.

One of the most fascinating toys of all is the miniature electric railway system, several units of which have been used in my household for many years. These new toys make you a child all over again and I often wonder what my children have thought of me for the many hours I have spent with them in building and operating their miniature railway system.

In Fig. 238 I am showing a modern electrically operated train which can be started, stopped and reversed from a distant point. Automatic signals, gates, power houses and everything that goes to make up a complete system are supplied. Also the little station, platform, etc., provided with a miniature lighting system, add to the effect of realism.

Such a toy gives the child a real insight into modern railroading and will provide hours of entertainment for the whole family. In fact, these systems are so complete that they will operate automatically without anyone touching the trains or switches.

These railroads may be installed permanently in any home where there is room, or they may be taken down and put away when not wanted. They may be used in any location where electricity is available, and a great many very elaborate miniature railroad systems are now operating throughout the country. They are built to operate on the floor or table, or they may be elevated by means of small wooden supports, usually built up against the wall of a room. The

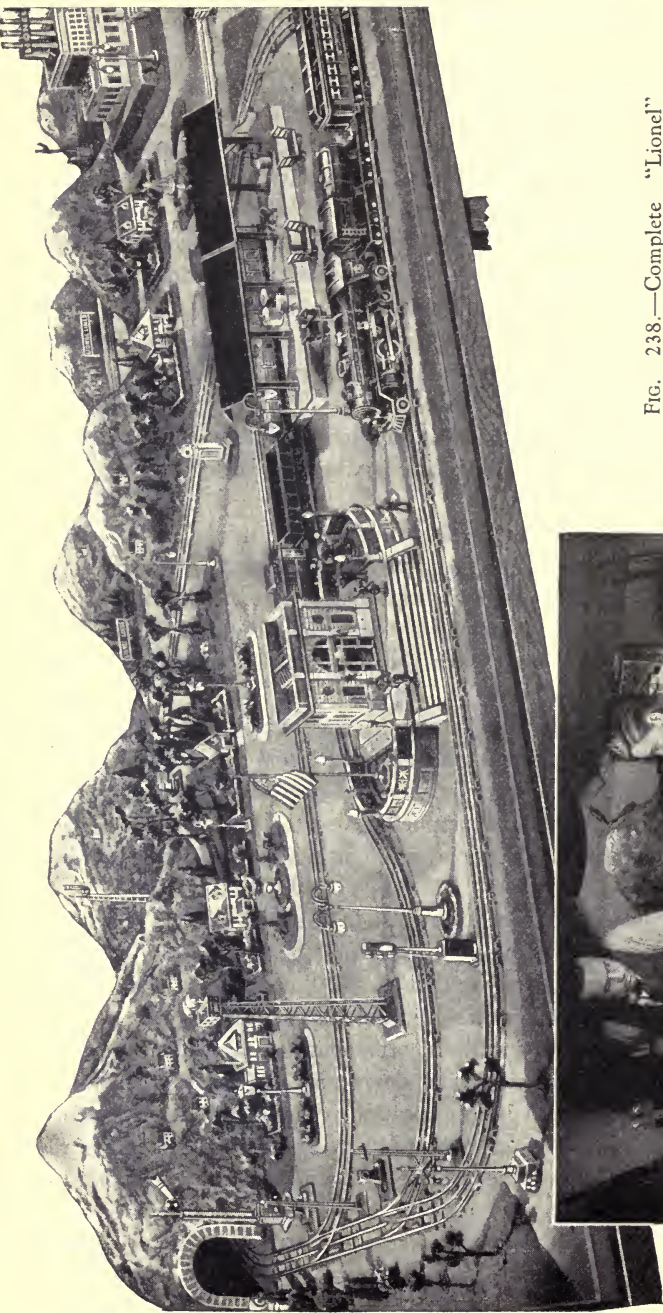

FIG. 238.—Complete "Lionel" miniature electric railway system. Includes everything known to modern railroading. An entertaining and instructive diversion for both young and old



engines and cars of these railway systems are furnished in three sizes, together with their corresponding track gauges, and are most complete in every detail.

These miniature railway systems are perfectly safe for children to use, since the electric current in the home is reduced to a low, harmless voltage by means of a transformer. Refinements go to the point of disconnecting the electricity automatically in case of any trouble on the railroad system. An interesting innovation which adds a note, or I might say "chug," of realism is called a "Chugger." It is a small "buzzer" mounted in the little steam locomotive and operated by a contact point on the revolving axle in such a manner that it sounds like the exhaust of a real engine—slow or fast, according to the speed.

In apartments or homes where the slight noise of the train might be objectionable, special rubber pads may be placed under the tracks which eliminate any noise and create the effect of a special roadbed, such as might be constructed for an actual railroad system.

Besides these electric railroads, there are many other electrical toys that are constructive as well as entertaining. One of these is the remote-control electric truck, shown in Fig. 239. To this truck is attached a small cord which runs to the controlling transformer in the hands of the operator. By simply pressing the button on this controlling transformer, it is possible to make the truck go forward or backward, to steer it, and also to dump its cargo.

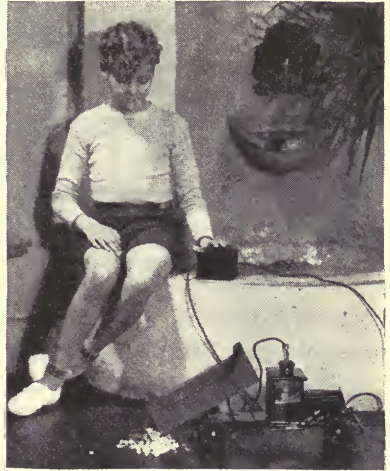

FIG. 239.—"Buddy-L" remote-control electrically operated truck

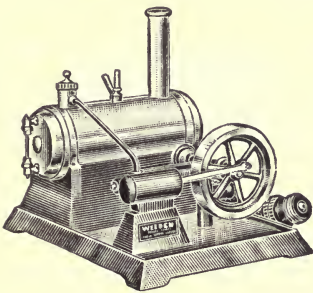

FIG. 240.—"Weeden" electrically heated steam engine

The toy steam engine has always been of extreme interest to children. In the older types an alcohol lamp provided the flame which made the steam for operating the engine, but today it is only necessary to connect the engine to the ordinary convenience outlet

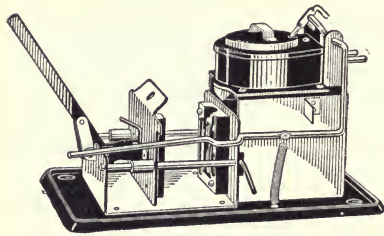

FIG. 241.—“Kaster Kit,” for making lead soldiers, cannon, etc.

and electricity will provide the heat for making the steam to operate the engine. Fig. 240.

Lead soldiers, cannon, etc., prized by many a child, may now be made at home by means of a “Kaster Kit,” shown in Fig. 241. Here the heat of an electric current from a convenience outlet melts the lead in the melting pot, and it may

be poured direct from the melting pot into various molds for making many objects. Best of all there is no flame and no hot ladle to handle.

Many small motors and miniature tools, all of which depend upon electricity for their operation—either from a convenience outlet or from dry cells—are available for children today.

Dry Cell Operation

There are already many toys, and others being developed, that use small dry cells, for their operation, lights, etc. There are also many toys a boy can construct for himself, by means of a few dry cells, some No. 18 annunciator or magnet wire, miniature lamps, sockets, switches and other fittings.

It might be well to say a word about dry cells. These are made in several sizes. A single unit is called a cell, but when two or more are connected together the combination is called a battery. The smaller cells are used for flashlights and for operating small toys having either motors or lights, or both. Where the boy is using electricity in the shop or playroom the larger dry cell, known as the No. 6, will be better and more economical.

Parts of small motors, Fig. 242, may be obtained so that the boy, in making his own motor, may receive valuable elementary instruction at the same time. In Fig. 243 is shown a type of motor that

may be built into some other toy the boy may be making, such as a boat, locomotive or automobile. And in Fig. 244, a small electric top is shown.

A device which is interesting as well as educational to the growing child, and which is operated by a dry cell, is the Electric Questioner.

Fig. 245. This ingenious device consists of a card on one-half of which is a list of questions and on the other half a list of answers.

By means of a small buzzer the child can tell the correct answer to any of the questions that are asked. These questions cover many subjects in history, geography, science, etc. The set is also fitted so that it may be used as a telegraph instrument—employing the dots and dashes of the

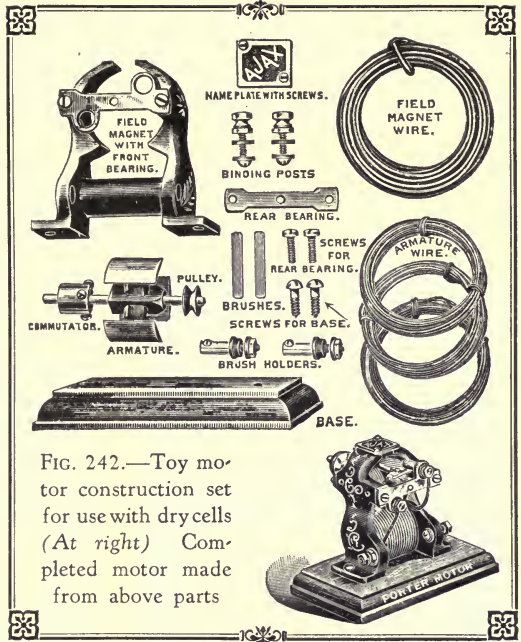

FIG. 242.—Toy motor construction set for use with dry cells (At right) Completed motor made from above parts

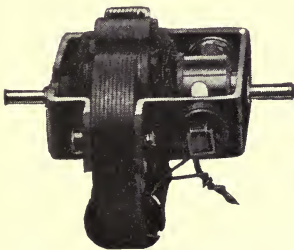

FIG. 243.—Built-in type toy motor for use with mechanical toys

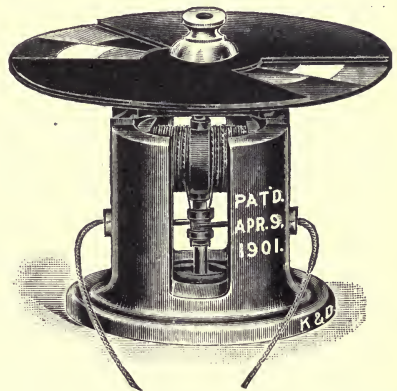

FIG. 244.—Electric top which operates from a single dry cell

regulation telegraph code obtained from the buzzer. For this purpose, it is operated by a small telegraph key.

Electrical toys require some care, so keep on hand the manufacturer's instructions to guide you in their proper use.

Visit the Toy Shops

It is impossible to list all the electrical toys in use today, with more being continually developed, but my suggestion to any parent is to give consideration to toys that combine education with entertainment. While on this subject of child education, may I further suggest that a visit to the toy department of any of our large department stores will repay the parent, as well as the child, in the knowledge gained of remarkably ingenious and instructive toys to be found there, many of which have already received the magic interest of electric operation.

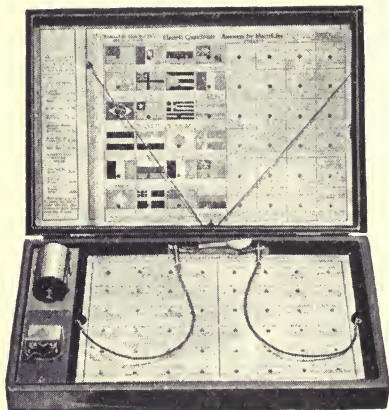

FIG. 245.—“Knapp” electric questioner and toy telegraph instrument

The amount of electricity consumed by toys is small and, even if used daily, add only a few cents to the monthly bill.

Domestic Science for the Girls

Growing girls in a family should have an opportunity to learn about modern home electrical appliances, since the more they use and understand these facilities, the better they will be equipped for their future lives. Domestic science will be of greater interest and easier to teach with electrical equipment. In years to come, when they grow up, electrical facilities that today appear to be in their infancy will be in common, every-day use.

For the younger children there are several home appliances made in miniature size. A good example of them is the electric range, shown in Fig. 246. This little range has an oven and can be used

for cooking small quantities of food in exactly the same way as it is in the larger ranges. It is much safer for any child to play with than equipment which uses an actual flame. In addition to the range, a small suction cleaner, Fig. 247, washing machine, etc., are available.

Electricity will also add greatly to the pleasure in playing with a doll house. Miniature sockets and lights are available that are suitable for the small doll house and may be operated either by

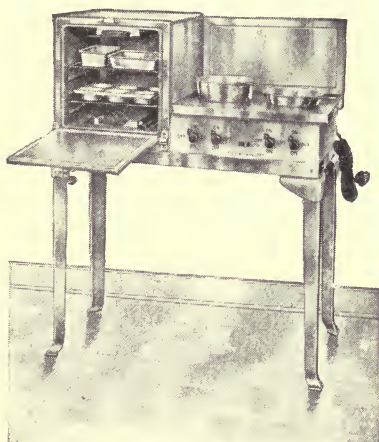

FIG. 246.—Toy electric range complete with active heating units and cooking utensils



FIG. 247.—Toy suction cleaner equipped with small motor. A device that really cleans

dry cells or by connection to the regular lighting system in the home. A standard Christmas tree lighting outfit having eight small bulbs may be used to advantage for lighting a fairly large doll house.

ELECTRICALLY OPERATED TOOLS FOR THE HOME SHOP

A workshop installed in the home for growing boys, and the men of the family as well, is an asset to any household and community. Here the mechanically minded have a place for doing those worthwhile things that count so much in life's enjoyment, as well as in producing useful articles for the home. It keeps the boys at home

and profitably occupied and helps to prepare them for future years in business by encouraging them to learn useful crafts.

For boys who have vocational training, it will supplement their school work; for those who are not fortunate enough to receive

vocational training, it will give them an opportunity of learning how to build things themselves. And, after all, experience is the best teacher. How often have we observed with admiration, if not actual envy, the facility with which some people use tools? It is not so much to be wondered at if we will but think that they doubtless learned the use of them in the vocational school or home shop during boyhood days until the interest acquired in such crafts became a virtual hobby. But today, even without such training, the average person can readily



acquire almost an expert facility with the modern tools that are available.

It may be found that, after all, it is not so much the years of early training as the tools themselves which make men and boys of today able craftsmen. Provide yourself with good, modern, first-class tools and you will be surprised at the workmanlike jobs you can soon perform with them. In practically any home some space can be found—either in the basement or in the attic—which can be utilized as a workshop. The suction cleaner will keep it clean.

THE WORKBENCH AND GENERAL EQUIPMENT. After you have decided upon a suitable location for the home shop, the next thing to consider is the equipment you will need to start with, the same as in furnishing the kitchen or laundry with the essential “fixtures” to take care of the primary requirements of the household. If we compare the home shop with the kitchen, for example, then a good, substantial workbench will be your first necessity just as the range and sink combined constitute the housewife’s “workbench” in Friday’s

Room which we visited in yesterday's journey. Then, too, you will recall in Wednesday's journey, under "Sewing Electrically," the many useful things that could be made with the modern electric sewing machine and all its various attachments, or "tools," and how I was so strongly reminded of the lathe and other electrically operated tools in my own home shop that I called my friend's sewing machine and cabinet the "Woman's Work Shop."

So, not to be outdone by the feminine members of your household, with their many "workbenches" in kitchen, laundry and sewing-room, you can well take special pains to provide yourself with at least one workbench that will measure up to your heart's desire in every particular, for it is the foundation of the home shop upon which and around which, as time goes on, you will assemble the equipment and tools you are to work with.

While it is not very difficult to construct a simple bench that will do well enough for a time, it may not be long before you will find it necessary to make some changes and additions. So if you plan to make a bench, you may find it helpful to obtain working drawings and instructions from a maker of benches. Such cooperation is gladly given and, besides, you will receive valuable suggestions about the use of ready-cut material, bench parts, hardware, etc., which you may purchase with less trouble and expense than if you tried to make them yourself.

Or you might be better satisfied to purchase at the outset a ready-made, knock-down unit such as is shown in Fig. 248. Such a bench has many advantages. First of all, it is correctly designed and solidly built from proper materials by those who are skilled in shop-craft and know the requirements. Such a bench is not a fixture, but can readily be moved about as desired. Then, too, there is a wide range of sizes and styles to select from, all the way from a simple, plain bench to the most completely equipped models imaginable, with drawers, tool cabinets and handy fixtures and attachments that would delight the most advanced craftsman.

In other words, the design and construction of workbenches is an art in itself which has reached a stage of refinement comparable with the manufacture of the electrical equipment and tools designed for the home shop, and to be consistent as well as practical and up-to-date, it is suggested that you give careful consideration to the selection of one of these benches. Moreover, it will pay you, before

you finally decide on the type and size of bench to install, to lay out a general plan for the rest of the shop and the equipment you have in mind to include, so that the bench you order will amply meet your requirements for many years to come.

When you have settled upon the matter of the bench to your liking, the next unit of equipment you should provide is a substantial

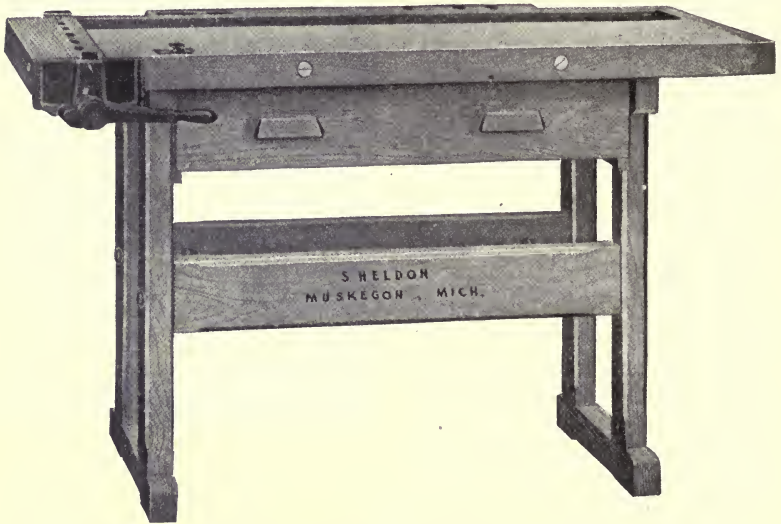

FIG. 248.—A well-constructed bench is the first requirement of the home shop

vise. After that, several common tools should be on hand, such as hammers, saws, planes, chisels, gouges, a brace and set of bits, square, screwdrivers, monkey wrenches, etc. There are available today complete assortments of tools contained in handy cabinets, varying from simple and inexpensive combinations up to the most complete and elaborate sets for every wood-working need. For the average home shop a few common tools will be sufficient at first, and I recommend that you proceed slowly in accumulating such equipment, so that you can judge wisely of the best tools to procure to serve your purpose as your work progresses, without incurring unnecessary expense or obtaining a miscellaneous assortment of doubtful value simply for the sake of having a "complete" outfit. It is better to have a few really useful tools of the best make than a large "shoddy" collection you will never have any pride in possessing.



FIG. 249.—Examples of household furniture made in the home shop

Be sure to provide sufficient light, so that you can see what you are doing. Any workbench, drawing-board or draughting table needs proper lighting and this should be considered in the general scheme—another place for a daylight lamp and reflector.

One or more duplex convenience outlets should be provided for the use of electrically driven tools, soldering iron, etc. A separate

circuit is advisable if several tools are likely to be in use at one time, thus drawing considerable current.

The shop should have the necessary equipment for making useful furniture and other articles, as well as for making repairs around the house, both inside and out. You can readily build the necessary cabinets for keeping tools, supplies, small fittings, etc., in the shop itself. Some provision for storing a little lumber will also be found convenient. It is possible today to purchase at very moderate prices good, first-class motor-driven tools with which to build all kinds of furniture, radios, cabinets, and in fact anything that may be used

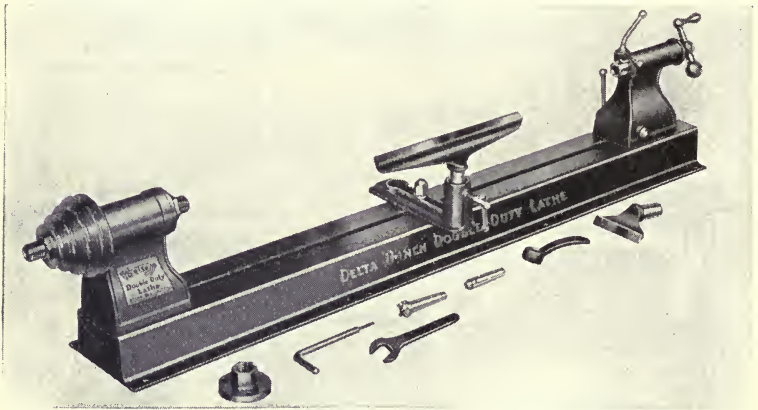

FIG. 250.—Wood-turning lathe

to furnish and decorate the home. The table upon which I am writing this book was made by one of my boys at the age of thirteen. There are many home shops in this country today where bureaus, tables, desks, beds, garden furniture, boats, and many other articles are being built which are equal in quality to the best cabinet work on the market, costing considerable sums of money. A few such items, representative of the work of home craftsmen, are shown in Fig. 249.

There is no limit to what may be accomplished in the home shop, since it depends entirely upon yourself, your interest and your application. Tool and equipment manufacturers will gladly co-operate with home shop owners, suggesting proper methods for the use of all tools, and often furnishing working drawings and complete instructions for making many useful articles. I am suggesting here a num-

ber of wood-working tools suitable for the home shop, all of which have been selected for their practical application and moderate cost. Good tools help to make a good workman.

WOOD TURNING LATHE. Wood turning is one of the most fascinating of hobbies, and one of the least expensive, since a good lathe of the type shown in the illustration, Fig. 250, can be purchased for less than twenty dollars. This particular machine will turn pieces up to nine inches in diameter. It is fitted with high-grade roller

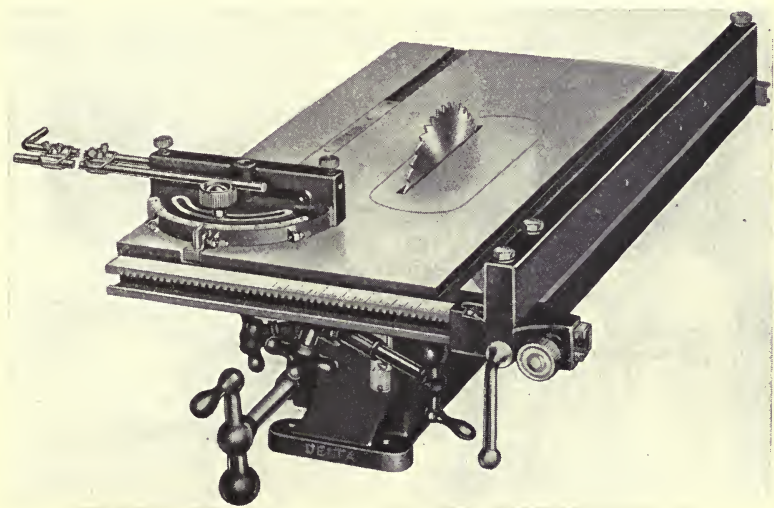

FIG. 251.—Small circular saw

bearings, and has an index mechanism built into the head which enables fluting, reeding and other fancy effects to be added to the work under construction.

CIRCULAR SAWS. The circular saw is really the foundation machine for the home workshop. One of the best types is shown in Fig. 251. This particular type overcomes one of the greatest objections to the ordinary small circular saw—that it is not capable of handling the occasional large job that must be done on it. In this type of saw this objection is entirely offset by ingenious extensions which can be added at any time, and which actually give the machine the capacity of a large factory saw.

Small circular saws of this type have reached a high degree of perfection. In fact, the machine shown in the illustration has some important improvements which are not to be found even on production saws. These include an "auto-set" miter gauge, which saves a great deal of time in fine joinery; a micrometer-adjustment rip fence; roller bearings; easy raising, lowering and tilting adjustments; height, ripping and tilting scales—and a number of minor features that make it a tool of exceptional handiness. Fitted with an eight-inch saw

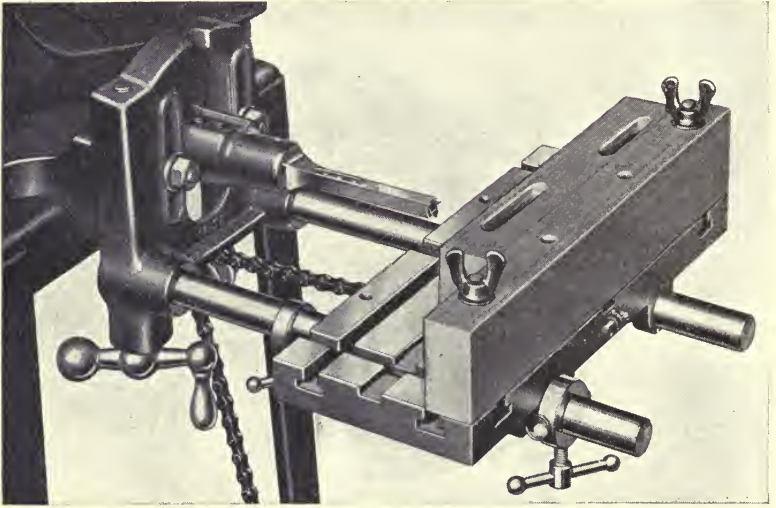

FIG. 252.—Mortising machine

blade, it will cut two-by-fours with ease, and will delight any craftsman.

MORTISING MACHINE. An addition to the circular saw that can be made at any time, is a mortising and routing machine which can be driven from the same motor, and which fits under the base of the circular saw.

With this machine, all kinds of drilling, routing, mortising, sanding, polishing and other work can be done in a manner equal to the best professional work. A mortiser of this type is shown in Fig. 252.

DRILL PRESS. The modern drill press, of the type shown in Fig. 253, may be termed the combination machine par excellence, for its use is by no means confined to the drilling of holes. The ingenuity of the

makers of this machine has enabled it to perform many other operations besides the mere drilling of holes in wood and metal, although this is still its primary function.

For example, by the addition of a simple attachment, the cutting of mortises for mortise-and-tenon joints becomes simplicity itself. This attachment, or hollow chisel, actually drills a square hole—believe it or not! Then all kinds of shaper cutters can be employed on this machine, with which the edges of work can be moulded and shaped into any form desired by the craftsman. This enables the drill press—with simple, safe cutters—to take the place of an expensive machine which, by the way, is considered dangerous in the ordinary shop. Special fences, guards, fixtures, etc., are all available for this machine, ensuring first-class shaping work.

In addition to these important uses, the drill press in the small shop will grind tools, smooth work by means of a sanding drum or disk, sharpen cutters for other machines, and perform routing and all kinds of grooving operations in wood. It can even be used for mixing casein glue and paint much better than these jobs can be done by hand. I have even heard of one ingenious shop owner who keeps on the right side of his better half by mixing her cake batter on his drill press!

SCROLL SAW. One of the most versatile tools that can be added to the home workshop is the modern scroll saw. Once a toy intended



FIG. 253.—Upright drill press

only for small fretwork and similar operations, the introduction of the saw, shown in Fig. 254, has changed all this, and the machine is now a full-sized tool, capable of real work. For instance, panels a full 24 inches wide can be cut on this machine, and it will cut wood up to 2 inches thick.

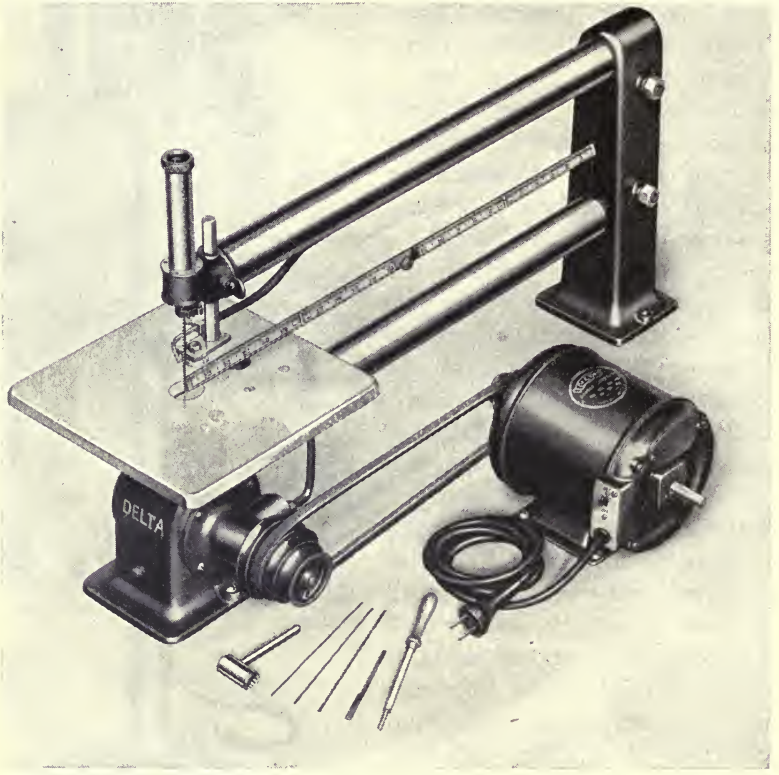

FIG. 254.—Scroll saw

Many owners of this scroll saw have put it to profitable use by making jig saw puzzles for sale, and a large number of small enterprises have sprung up in this line as a result of the introduction of this tool.

All kinds of scroll, fret and jig saw work can be done on this machine, from the very finest puzzle work to the coarsest cutting; and, in addition, it will do sanding and filing. Metal, too, can be cut

and filed with this remarkable tool—which is almost a necessity in the well-supplied workshop.

BAND SAW. The scroll saw described in the preceding paragraph is displacing the band saw in many workshops that are equipped for smaller work. The latter is indispensable in the workshops that handle scroll work over two inches thick. Many home workshop owners use both the scroll saw and the band saw, and would not be without either machine, for each is better adapted for certain kinds of work than the other.

Band saws are usually sold for home workshop use in two sizes, 10-inch and 12-inch. This dimension refers to the distance from the saw blade to the rear column of the machine, and means, in the 12-inch size, that the machine will cut to the center of a panel approximately 24 inches wide. Fig. 255 shows an illustration of a modern band saw.

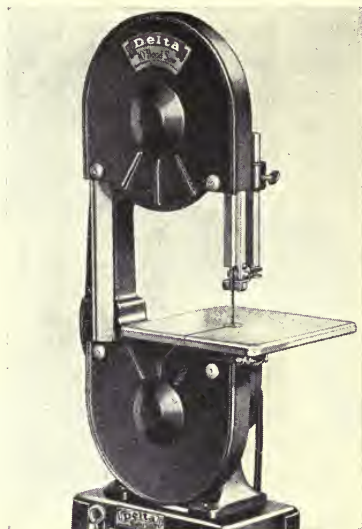

FIG. 255.—Band saw

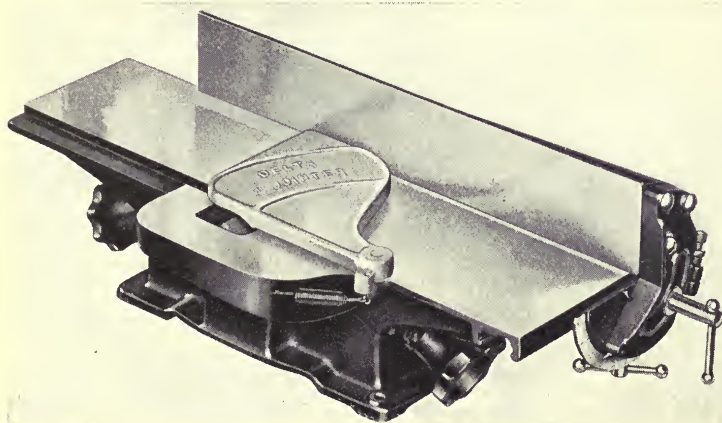

FIG. 256.—Jointer

JOINTER. Next to the circular saw, perhaps the machine of most importance to the serious craftsman is the jointer. Once thought of as a machine intended only for the factory, it is a poorly equipped workshop nowadays that does not boast of one of these handy tools.

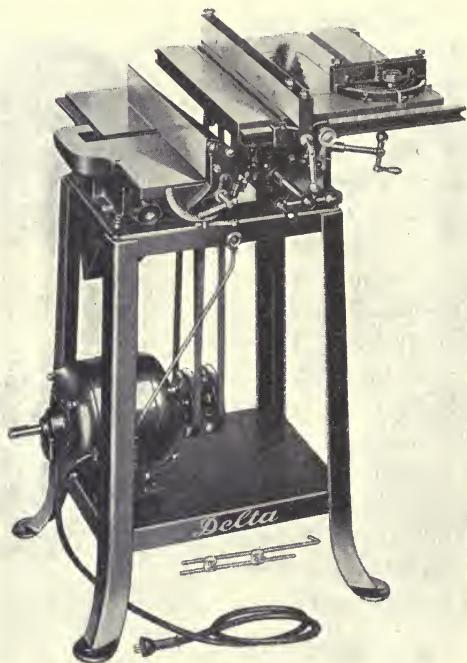

FIG. 257.—Combination circular saw and jointer

A suitable type for the home workshop is one that will joint or plane work up to four inches wide, and that will cut rabbets, etc. The machine shown in Fig. 256 is of this type. Like the other machines shown, it is fitted with ball bearings, and is a precision tool in spite of its comparatively low price.

Few of us enjoy the task of laboriously smoothing wood with the hand plane, and with this machine the task becomes a pleasure instead.

COMBINATION MACHINES. Combination machines that purport to do half a dozen or more jobs all on the same machine by the addition of various attachments, do not find much favor with the crafts-

man for, while these look handy on paper, they are usually anything but handy in practice. There is another class of combination machines, however, which is meeting with great favor, and that is a type of machine which is made up of two or more units such as previously described. Fig. 257 shows a machine of this type, comprising a circular saw and jointer mounted on the same stand and driven by the same motor. Either machine may be used at will merely by throwing off the belt on the machine not in use. In most cases, however, since the two machines are used practically all the time together—ripping a board and then jointing or planing it—the two may be allowed to run along together. Due to the ball-bearing construction of the machine the extra current consumption of this combination is negligible. In the small shop, where space is at a premium, a machine of this type is ideal.

GLUE POTS. In making furniture, or where much cabinet making is done, an electrically heated glue pot adds to the convenience of



FIG. 258.—Shop stove

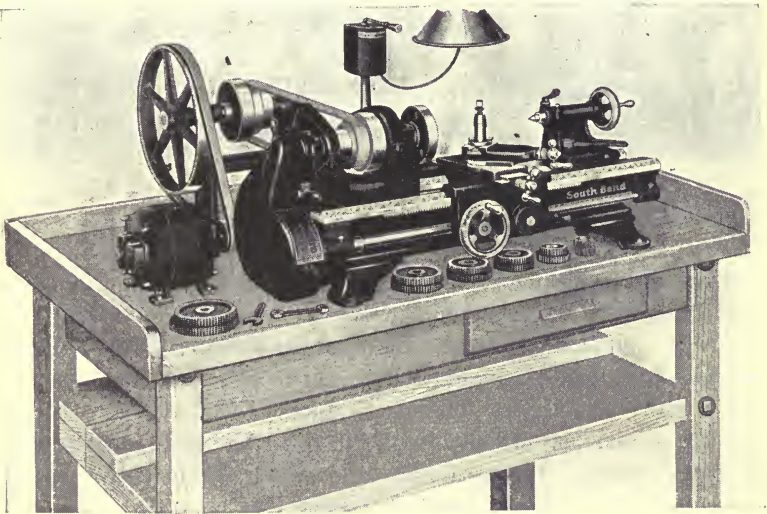

FIG. 259.—Metal-working lathe

the workman. The heating element keeps the water surrounding the glue container at a constant temperature of approximately 150 degrees when the pot is in use.

SHOP STOVES. Where heat is wanted for melting wax, paraffine, or glue, a small stove, shown in Fig. 258, is a most useful appliance for the home shop. It may be connected to any convenience outlet.

METAL-WORKING TOOLS. Some parents, and some boys as well, fail to realize what can be done in the home shop with metal for



FIG. 260.—A typical home shop containing a metal working lathe. Many interesting and constructive models may be built in such a shop

building and in making repairs. The average metal-working tool is a little beyond the scope of the home shop on account of its size and relatively high cost. However, the most convenient and most useful metal-working tool of all, and a precision tool as well, is now available for the home shop. This is the Junior Metal-Working Lathe, which I am showing in Fig. 259. With this lathe there is no limit to the types of metal-turning that can be done. It will be found a great convenience in connection with any work that boys are doing, and is extremely handy in connection with repairs of the automobile and

general home equipment. This lathe is a full-fledged tool and the work you can do with it is limited only by its size. It can be used for cutting threads and for making other tools. By means of accessory attachments, milling, grinding, wood-turning, etc., may also be accomplished. It can be provided with legs of its own or set upon a workbench and driven by means of a counter shaft. Whatever method of drive is used, a small motor which may be connected to the ordinary convenience outlet or lamp socket will provide the power.

Many interesting models may be made on the lathe, it being possible to obtain the necessary fittings and blue prints of engines, motors, etc., as suggested in Fig. 260, showing a typical home shop.

ELECTRIC SOLDERING IRON.

One of the most convenient tools in the home shop is the electric soldering iron, Fig. 261. Here again electricity makes the process very simple. The iron is heated by means of an enclosed heating unit mounted



(General Electric)

FIG. 261.—Electric soldering iron

near the soldering tip of the iron. The electric heat from this unit keeps the tip at the proper temperature for continuous use. The iron may be connected to a convenience outlet and used in any part of the house, the garage or out-of-doors. Any such iron can be used for mending toys or any other items that require soldering, and it will pay for itself in a short time.

Things That Are Easily Soldered

Tin, copper, brass, zinc and lead.

Things That Are Not Easily Soldered

Iron and steel. These metals are easily welded and such work can be done in the average garage.

A Metal That Requires Special Solder

Aluminum.

All parts to be soldered should be thoroughly cleaned and a "flux" such as resin must be used. Wire solder can be obtained with a core containing the necessary flux. When through with the iron, it should be kept away from any inflammable material until it has com-

pletely cooled. A fine point on an iron is convenient for soldering delicate connections, such as when making or repairing a radio.

PORTABLE DRILLS. A very convenient and necessary tool for the

home shop is the portable electric drill, shown in Fig. 262. This drill may be used anywhere electricity is available, which extends its utility beyond the shop. Lightness and compactness are features appreciated by the workman. Besides using this drill for boring holes in either wood or metal, an attachment may be used for holding a polishing or grinding wheel, thus increasing its usefulness. Pipes or other metal objects in any part of the house that are corroded beyond the power of ordinary polish to restore may be refinished by means of these wheels. Such a tool is a great help in the garage, both as a drill and as a means of removing carbon in the auto cylinders. A stand may be used with these drills for use on a bench

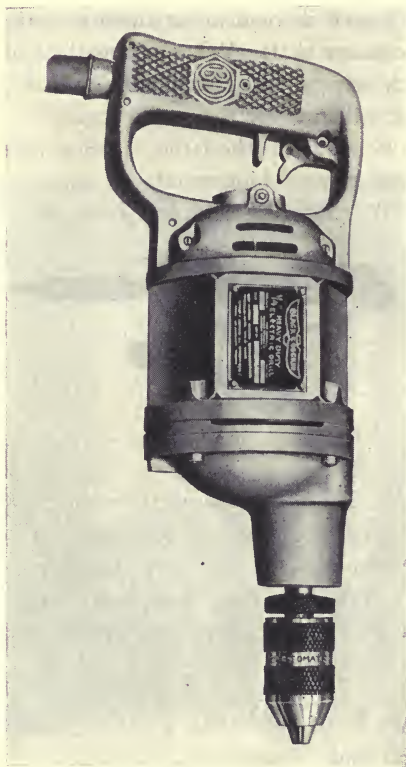

FIG. 262.—Portable electric drill

where more accurate drilling is required than is obtainable by hand use. A small trigger on the drill operates a switch for starting and stopping the motor.

TOOL GRINDER AND POLISHER. A small motor-driven polishing and grinding wheel on the shop bench, shown in Fig. 263, makes it possible to keep tools and skates sharp and to put finishing touches on small metal parts.

Different grinding wheels, fine or coarse, may be used as well as wire brushing wheels using stiff or fine wires. For polishing fine surfaces, cloth and felt wheels may be substituted.

FIG. 263.
(Right)—Bench
grinder and pol-
isher
(Black & Decker)

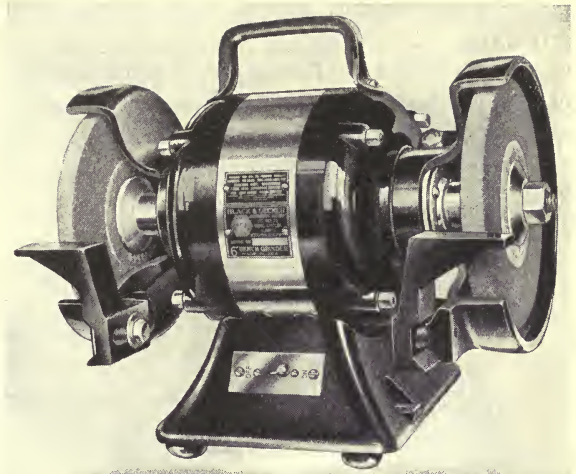

FIG. 264.
(Below)—Port-
able grinder for
fine work

PORTABLE GRIND-
ER. For light grinding
and cutting in soft
metals and wood, and
especially convenient
for use in inaccessible
places, a handy tool
is shown in Fig. 264.
It consists of a small
motor with a drill
chuck mounted on
the extended shaft.
Many types of grind-
ing wheels or cutters
can be used with this
little grinder.

It is well adapted
for finishing parts of
small castings which
cannot be reached by
a regular grinding
wheel. Used as a
hand drill, small holes



not over one-sixteenth inch in diameter may be drilled in wood or soft metal.

PAINT SPRAYER. For applying paint properly, either inside or outside the house, and for furniture or the automobile, an automatic sprayer will give excellent results and is much easier to use than the



FIG. 265.—“Kellogg” paint spraying outfit

ordinary paint brush. All brush marks are avoided and the drudgery of continually dipping the brush into the paint and applying it to the surface, is avoided.

Fig. 265 shows a small portable spraying outfit. It consists of a small electrically driven air pump for supplying air to the sprayer, which also contains the paint. The paint spray can be regulated and turned on and off by means of a trigger. By using different nozzles round or flat sprays can be used. The angled nozzle will be found convenient when painting a ceiling, so that the operator doesn't have

to twist his neck or stand on his head. The outfit is provided with castors and a lifting handle, making it conveniently portable.

The same outfit can be used for spraying bushes and vines, protection against insects, etc., and is a very handy home tool.

SHOP MOTORS. Wherever mechanical power is required an electric motor, Fig. 266, will provide that power with a minimum of expense and ease of control.

A separate small motor on each tool is usually more convenient and efficient than one large motor operating several tools. Be sure to secure a high-grade motor with your tools. Those of the repulsion induction type are preferred over the so-called split-phase type. The split-phase motor should be used only where the starting load is light and where frequent starting and stopping is unnecessary. The repulsion induction type of motor is much more rugged and is better adapted for starting under load and for carrying short overloads. The terms "split-phase" and "repulsion induction" refer to the method of starting small alternating current motors. If direct current (D.C.) is used in the home, then D.C. motors must be used in the shop. Some small tools are operated by universal motors which may be used on either current.

SHOP MOTOR CONTROL. A switch directly on the motor is desirable, but in any case the control should be near the tool. For a fully equipped shop, the electric circuit or circuits to which your

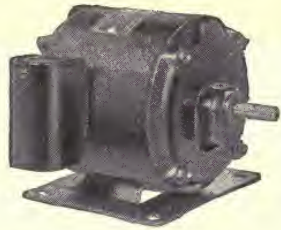

Split phase

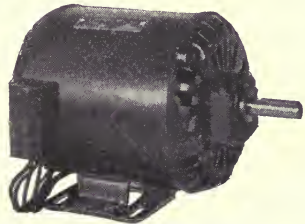

Repulsion induction

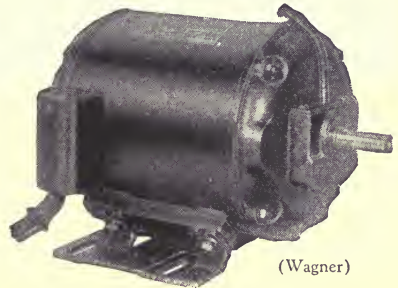

(Wagner)

Special mounting for quiet operation

FIG. 266.—Typical motors for the home shop

electrical apparatus and tools are connected can be controlled most advantageously by a master switch, Fig. 267. You will then be able to disconnect all electrical equipment at one point and in one action,

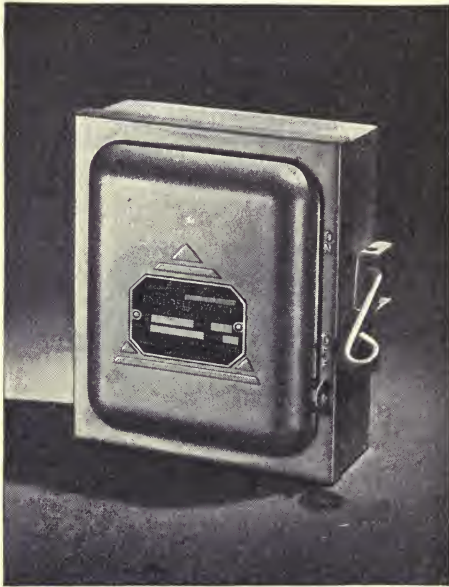

(H.&H.)

FIG. 267.—Master switch for the home shop

a convenient and safe provision which prevents others from tampering with your tools when you are not present. To guard against this contingency, the switch should be located out of reach of small hands, or a lock provided if you prefer. But even more than this is the convenience to yourself in having the power supply under the control of a single switch, with the assurance that if you are suddenly called away from your work, or in leaving the shop "closed for the day," all tools are electrically disconnected and the shop "branch

highways" as well as "motor highways" are likewise "closed to traffic." This same switch may find an additional application in controlling the circuits serving outbuildings, garage and grounds.

In General

The tools illustrated and described in this section on "the home shop" have been selected for their practical utility in meeting the general requirements of a well-appointed wood-and-metal-working "den" for leisure hours. Consulting manufacturers' catalogs may suggest other items you would like to include as time goes on. A few other devices of possible home use might be mentioned but space does not permit.

You can plan a simple shop, with one or two tools, or the most elaborate one that the heart of a craftsman could desire, but whatever the extent of your investment, it will come back a thousand times over in health, happiness and renewed interest in life. And then there are the dollars you will save over a course of years by making your own household improvements and repairs as well as many useful articles.

I should like to say a few words to the boys who are interested in the shop or already have one established. Learn to use your tools properly, keep them in perfect condition and put them away when not in use. Be systematic. Have a place for everything and keep everything in its place. The suction cleaner will come in handy for keeping the shop clean. You will find that in the shop especially, as well as outside of it, what you do is what actually counts, since "nothing succeeds like success."

Find out what things are wanted in the house, building the most essential ones first, and make it a point to keep everything in the house in the best of repair. The more useful things that you can build and do for your home, and the more you learn, the more willing your parents will be to provide you with additional tools and facilities to carry on the work in which you are interested. Plan your work, laying it out on paper before you start to build. Whatever work you do, systematize it so as to avoid as many mistakes as possible.

Keep on hand in a proper place spare bulbs, fuses, cords, a switch, a socket or two and some friction tape. But above all things, do not neglect your school studies for the home shop. Rather, make the home shop a spare-time means of assisting with your education.

FOREWORD

To Chapter Six

THERE is an old adage which reminds us that "The workman is worthy of his hire." This was never so true as in the case of our Electric Servants, and in the following chapter you will see what a prodigious amount of work they accomplish for a mere penny's wage.

But even though it costs so little to employ them, it won't do any harm to apply good old-fashioned principles of thrifty management in their use, for "A penny saved is a penny earned." And the housewife should not overlook the fact that with this accumulation of earnings laid by in a contingency fund she can occasionally afford to buy some new appliance that she needs—just out of wise savings!

That keen sense of values which America has come to possess has made the once despised penny loom large in shopping importance. It has come to be the fashion to bargain for penny reductions in the purchase of food, drugs and other household necessities, so why not go on a tour of your wiring system with efficiency in mind and see where you can make your Electric Servants shop to better advantage with respect to the current they consume? Just declare a jig-saw holiday for an evening or two and go a-bargaining through your home with Chapter Six as a guide. It may require a little study, but the results will more than repay you for the time.

Following are a few of the guides to economy suggested:

How the location of your home, changing seasons, color of your walls and other considerations affect your electric service bills.

The increased service and convenience of electric operation over old-fashioned methods and why cost comparisons cannot logically be made in all cases.

Why you pay less per unit when you use more current.

How to economize by using the proper kind and size of bulbs.

Why you should replace bulbs when their efficiency diminishes.

How the kind and condition of lamp shades affect your lighting efficiency. Other ways to save.

Why electricity is more efficient and economical than other sources of light, heat and power.

The use of automatic control devices as economy aids.

What one cent's worth of electric current will give you.

How to read your electric meter and determine costs.

Chapter Six

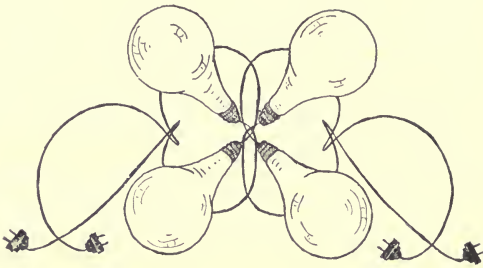



CHAPTER SIX

The Efficient Use of Electricity

There is probably no other agency which has so many uses and is so essential to modern life as electricity. Electricity has attained a position of first place in our home life because it is so convenient, so simply controlled and so efficient, but this very ease of control may lead to unnecessary use.

Because electricity is so convenient, it is sometimes used too freely and even though it is available at a very low cost, it pays to use it carefully. By using it carefully I do not mean that it should not be used as much as may be necessary, but I do mean that a little care will give you all the use you need from your electric servants without wasting their energy!

I have some figures showing the cost of electricity in several homes we have had, but they would be of little help now since conditions were different a few years ago. Moreover, the cost of electricity today is uniformly much less everywhere. We had one home located on a large plot with no shade trees or nearby houses and, being on the side of a hill, it gave us a well lighted basement and laundry. In this home only an occasional light for a closet was needed in the daytime. Another home, well shaded and with dark walls, required light for several hours in some rooms during the day. Such homes require more lighting during the winter and on cloudy days.

Dark walls and dark ceilings absorb light. Especially in the kitchen, laundry and such rooms, the walls should be as light-colored as practicable so that all possible light can be utilized. Shorter days in the fall and winter months will increase your lighting bill in contrast to the summer months, especially where daylight saving is in effect.

Then again, I figure this cost from the standpoint of what I receive for my money and the savings I make by using electricity instead of some other agency. For example, our electric refrigerator saves more than its cost of operation by properly preserving our food and relieving us of the anxiety as to whether or not we need ice.

This is a direct saving, with its convenience costing us nothing, and the first cost will be absorbed years before the refrigerator wears out or becomes obsolete.

A broom is cheaper in the beginning than a suction cleaner, but the cleaner really cleans and doesn't just move the dirt from one spot to another, while it also saves time that can be employed for something else. This is just one of the numerous examples I could cite which prove to my complete satisfaction, at least, that electricity, if it is properly used, is the most efficient and economical servant available today.

In making the most efficient use of electricity there are two or three things to keep in mind. Probably the most important is that the cost of electricity is based on the amount of current which is used in actual operation of a bulb or an appliance. The mere fact that a bulb or an appliance is connected to an outlet does not mean that electricity is being consumed, for current is used only when the light is turned on, or the appliance operating.

As a rule, the more current you use the less that current costs per unit. It is like buying many other things in large quantities. The larger the quantity you buy, the less the cost per unit. If, therefore, you have an electric range or an electric water heater, the rate charged per unit (or kw.h.) for electricity for operating these devices may be much less than if only the usual lighting and small appliances were used. This sliding scale of rates is usually printed on the monthly bill which you receive from your lighting company.

Some companies follow the practice of installing two meters, one for lighting and the other for appliances. If this is the case in your locality, be sure that all of your larger appliances such as the refrigerator, oil burner, range, etc., are connected to outlets served through the appliance meter, because the rate for this electricity is less than that charged for lighting.

There are two things to be considered in determining the value of electricity: one is whether or not you are making the most efficient use of the current you pay for in operating your lights and appliances, and the other is whether or not electricity can work more effectively for you than some other source of heat or power.

I shall first take up the most efficient use of the current you pay for in operating the essentials to modern convenience, such as your lights and the more common appliances. Probably one of the greatest

economies can be effected by making sure that the bulbs you use are of the right size and give the greatest amount of light for the least amount of current consumed. Standard domestic bulbs as used today give many times the amount of light per unit of electricity consumed compared with bulbs used a number of years ago. There are, however, some other types of bulbs of foreign make which cost much less than the standard domestic bulbs, but are much more expensive to use.

I will give two examples of one type of waste which can be eliminated by making sure that you use domestic bulbs. A bulb of foreign make, which was rated at 50 watts, was compared with one of my domestic bulbs. While it burned nearly three and one-half times as long as my domestic bulb, the foreign bulb operated at such a low efficiency—that is, it gave so little light for each unit of electricity consumed—that by the time it burned out, it had cost \$3.90 more than the same amount of light for the same length of time would have cost had a standard domestic bulb been used. In another case I checked up a small bulb marked “5 watts,” such as is often used for a night light, and found that by domestic standards I should have received the bulb free and 75 cents in addition to repay me for the extra cost this lamp added to my light bill before it burned out.

Foreign bulbs may be distinguished from domestic makes by a foreign name or symbol marked on the end of the bulb. Where no such marking appears the identification will usually be found on the metal base, just below its junction with the glass.

Another way to economize in using bulbs is to be sure that they are replaced before they burn out. The average life of a bulb is about 1,000 hours. During most of this life it continues its efficient production of light, but after it has burned for, say, 800 hours it does not produce quite the same amount of light per unit of electricity that it did in the beginning. When a bulb begins to turn dark gray, therefore, it would be well to discard it or at least to change its location to one where the amount of light is not of such vital importance. The fall of the year, when the number of lighting hours begins to lengthen, is a good time to go over all the lamps in the house and make bulb renewals. Keep a supply of new bulbs of various sizes on hand. Do not use an old bulb for a replacement when a new one is required. For instance, a bulb which has been used quite continuously in a reading lamp for some time might to

better advantage be moved into a closet or basement where it would be used only occasionally. A new bulb in the reading lamp will give you the required amount of light for reading, and the old bulb will still give plenty of light in some location where it is not used so often and where the amount of light is not so important.

The proper size of bulb for a particular purpose is also a very important consideration with respect to the efficient use of electricity. If too dim a light is used for reading or studying, or in the kitchen or laundry, there is likely to be unnecessary eyestrain which may result in weakening the eyes. Then again, if too bright a light is used in these instances, or in the lanterns on your front porch, or in a basement socket where light is necessary only to see your way around, the cost may be unnecessarily high.

There is no hard and fast rule which can be laid down for the proper size of bulbs because of their various uses, but there are one or two things to be kept in mind in this connection. Remember always that the human eye was originally made for use in daylight which, even on cloudy days, runs into millions of foot-candles. (The term "foot-candles" refers to the measure of the amount of light striking a surface.) Where reading or any fine work is being done, therefore, plenty of light is necessary to prevent eyestrain. In factories, it has been found that a man can do more and better work in good light than with insufficient light.

The proper care of your lighting equipment and the proper type of shades are other important things to keep in mind. Dark lamp shades absorb a great deal of light. Shades are absolutely necessary for the avoidance of glare, but they should be light in color and of proper material to allow as much light as possible to pass through them. This, of course, is not the case in indirect or semi-indirect lighting where it is intended to change the direction of the light, and where the light which is used comes as a reflection from the walls or ceiling. Lamp shades should be cleaned regularly, and the bulbs themselves should be washed occasionally. Permitting dust to accumulate on a bulb or a shade is nothing short of an absolute waste of money, for even a light coating of dust reduces the amount of light considerably.

Care should be used, also, not to leave lights on when not required. Proper switching of lights will do as much to effect economy as anything else. Indicator lights, which glow as a reminder that lights

have been left on, are a great help, particularly for lights in basement, attic and garage. These indicator lights can be located in some spot visible from main hallways or active rooms, so that even though the lights to which they are connected cannot be seen, they serve as reminders of lights still "burning." This habit of turning off the current when lamps are not in use applies also to appliances.

The second of the two things I mentioned in dealing with the subject of the efficient use of electricity was whether to choose this source of heat and power in preference to some other. Electricity when properly used is the most efficient source of heat and power for the home which we have, since it can be used just where it is needed, and just as often as it is needed, without waste. In the electric oven the heating unit is actually inside of the oven and practically all of the heat produced is retained right where it is needed, very little escaping through the insulating material of the oven walls.

Thus, in an electric oven, all the heat produced as the electricity passes through the heating element goes into heating the oven. None is wasted by heat losses, as with other fuels, or in circulating around the kitchen where it is not wanted. When heat is produced from gas, oil or coal, a certain amount is necessarily wasted because air is required for combustion.

This same principle of heat losses applies to the heating of water. Of course, the cost of other fuels as compared with that of electricity will determine whether, in consideration of their wasted heat, these fuels are actually cheaper. At the same time the cleanliness and the ease of control of electricity must also be taken into account in making a decision as to which heating agency you prefer to use.

The Thermostat (automatic temperature regulator) is a great help in the economical use of such appliances as the electric iron, toaster, waffle iron, heating pad and range. This device keeps the appliance at just the right working temperature. All that is necessary is to connect the appliance and the automatic control will do the rest. It will bring the device to the proper temperature as quickly as possible and then it will cut off the current until its further use is required.

While it is impossible to give exact costs of using lights or appliances because of the different rates throughout the country, and the manner of using appliances in various homes, it might be interesting to have a few examples of just how much work electricity will do for

you for the meager "wage" of one cent. The following table is based on a rate of 5¢ per kw.h.

One Cent's Worth of Electric Current Will:—

- Make fifteen cups of coffee.
- Make fifteen slices of toast.
- Heat an iron for twenty minutes.
- Operate a cooker for thirty minutes.
- Heat a waffle iron twenty minutes.
- Heat a grill twenty minutes.
- Operate a radiant heater for twenty minutes.
- Operate a health lamp for twenty-four minutes.
- Operate an egg cooker for twenty minutes.
- Run a fan for four hours.
- Run a washer for one hour.
- Run a suction cleaner for one hour and fifteen minutes.
- Light a floor lamp for more than three hours.
- Run a clock for one hundred hours.
- Run a sewing machine for four hours.
- Operate a radio for three hours and thirty minutes.

The relative cost of operating light bulbs of various sizes, shown in the following table, is based on a lighting rate of 8¢ per kw.h., assuming that bulbs are burned for 100 hours each, which is an average monthly use of a reading lamp, or one used for lighting an active room in the house where it would be turned on approximately three and one-half hours each evening.

Size of Lamp in Watts	Cost of Operating for 100 Hours
25	\$0.20
40	.32
50	.40
60	.48
75	.60
100	.80
150	1.20

From this table you will notice that the cost of operating bulbs is directly proportional to their size—that is, the cost of using a 50-watt bulb is one-half that of a 100-watt bulb. However, the latter will produce more light than two rated at 50-watts, since it is more efficient.

The Kilowatt-Hour and What It Means

The kilowatt-hour is the unit of electricity purchased by the home owner. It is the kilowatts used, multiplied by the hours they are used. Six kilowatts used one hour equals six kilowatt-hours, and if used three hours would equal 18 kilowatt-hours. Used for one-half hour it would equal 3 kilowatt-hours. The kilowatt equals 1,000 (kilo) watts. A 50-watt bulb consumes fifty watts continuously while it is in use, or at the rate of 50 watts per hour, or 1/20th of a kilowatt-hour. If in use 10 hours, it would consume 500 watt-hours or 1/2 kilowatt-hour.

Understanding Your Electric Meter

If you wish to check your electric bills, or determine how much electricity any particular device uses, or how much you use over any particular time, learn how to read your meter. It is a very simple matter.

In Fig. 268 is shown the dial of a typical meter through which the electricity used in your home passes. In this particular case the first reading is 0562 kilowatt-hours, and the second reading, taken many months later, is 2198 kilowatt-hours. The difference between these two readings is 1636 kilowatt-hours. The earlier (top) reading is subtracted from the later (bottom) reading. Each figure on the right hand dial indicates 1 kw.h.

Each figure on the next dial to the left means 10 kw.h.; 100 kw.h. for the next dial, and 1,000 kw.h. for each figure in the last left hand dial. This means that the pointer on each dial, starting at the right, must make one complete revolution to move the pointer on the next left hand dial from one figure to the next.

By taking readings from day to day, or for any other period of time, you can check the cost of electricity for that period.

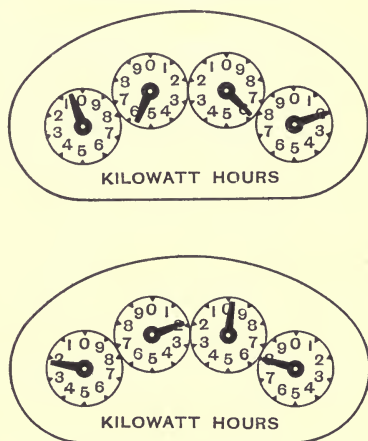

FIG. 268.—Typical household meter dial, showing two readings taken several months apart

Summary

Use lights of proper size.

Turn lights off when not needed.

Do not use bulbs that have turned dark gray.

Do not use sub-standard imported bulbs in important locations.

Keep bulbs and shades clean and free from dust.

The cost of lighting your home is greater during the winter season of fewer daylight hours than during the summer months, especially where daylight saving is in force.

Do not keep appliances operating longer than necessary.

If a discount is given for paying your bill before a certain date, take advantage of this saving.

In figuring your cost for electric service, balance the figures against the service received.

FOREWORD
To Chapter Seven

A LITTLE care and personal supervision of your equipment will maintain your electric highway and its connected service at the peak of efficiency. This chapter deals with the following considerations of personal maintenance of the electrical system and how to avoid the occurrence of trouble.

First, shut off the current before working on any part of the wiring, or in making repairs to fixtures.

The proper use of fuses. How to tell when they are rendered useless. How to locate the causes of "blown" fuses. What to do in making replacements.

How to treat loose sockets and fixtures, cords and other equipment which become defective.

Take care of your appliances—keep screws and nuts tightened to avoid their being lost.

Keep your appliances clean, electrical contacts firm and in good condition. Discard cords that are beginning to wear. Secure new parts rather than patch old ones. Don't procrastinate.

Call the repair-man or "electrical doctor" when the trouble is too serious for you to cure. Don't tinker or experiment when you are not certain of the cause of trouble.

If interested, watch how the repair-man goes about his task. Observation is the best teacher.

Respect electricity—avoid shocks.

Do not use substitutes for fuses, since they may lead to serious troubles.

If your local lighting company maintains a service department for your convenience, consult them whenever need arises.

Chapter Seven

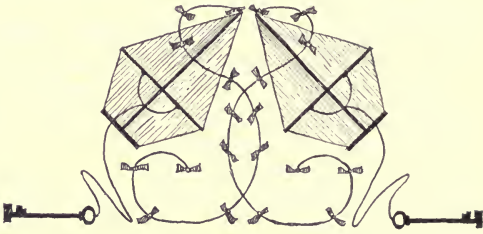

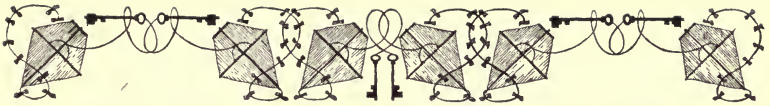

CHAPTER SEVEN

Home Supervision of the Electrical System

The electric highway of the home requires little attention if it is of good material and has been properly installed. It is usually the exposed fittings such as sockets and switches that need attention.

Sockets and switches should work smoothly, but with continual use small screws or nuts may become loose, or a cord become worn, so that the light either flickers or goes out entirely. Such flickering or refusal to light is due to a poor connection. This should be repaired at once before any further trouble or inconvenience arises.

My suggestion is to remedy immediately anything that needs attention, whether in the electrical system or not. Don't procrastinate! Often the tightening of a small screw or nut will prevent its being lost later on and save you from considerable inconvenience—"a stitch in time saves nine," and perhaps more. In most families there is usually some member of a mechanical turn of mind who can keep things in repair. If there is not, then call in an electrician.

For those who are mechanically inclined, I am offering a few suggestions for making minor electrical repairs. I suggest that you follow the same procedure as in consulting your doctor. A slight cold or a small cut you would treat yourself, but for a real sickness you would call a physician. Electrical ills require much the same treatment. Fix a cord or a socket or renew a fuse yourself if you wish, but beyond this consult your electrical contractor or lighting company. They are your electrical doctors. Don't confuse repairs with tinkering, and leave things alone if they are working as they should.

There is one very important thing to remember if you ever attempt repairs on your electrical equipment: that is, to *Shut Off* the electricity *First* and don't turn it on until you are all through. When the electricity is off, you are safe in your work. This is a simple matter with any portable light or appliance, since the electricity is off when you remove the connecting plug from the source of current. If the socket, outlet or switch is connected to the fixed or permanent elec-

tric highway, the electricity may be shut off by removing the fuse or fuses supplying that circuit; or better yet, by turning off the main switch supplying the entire house. In cases where it may be necessary to turn off the main switch, this "off" period should not be long, particularly where the use of an oil burner, an electric range, or clocks would be affected, because of the resulting interruption of service.

In cases of old or inferior sockets or switches, it is better to put in new ones than to patch up the old ones. In making repairs or renewals it is a good plan to see how the original was used or put together so that the new one may be replaced in the same way.

Electricity as used in the home is not dangerous and there is no occasion to fear it, but it should be respected and there is no excuse for getting a shock. As I have said before, the electric highway consists of two parts—live metal and dead insulation. The insulation is harmless, but *touch the metal only when it is dead electrically*. Don't get on or off a train when it is moving or put your hands in the lion's mouth when he is alive!

A modern, up-to-date electrical system has no exposed parts from which you can get a shock. About the only way you can get a shock, if you do insist, is by putting your finger inside an empty lamp socket when the current is on. Lamp sockets should never be empty, and there should be no temptation to put your fingers where they do not belong. It is the same idea as with the railroad train—you must get on the track to have the train run over you.

To the Boy Scout, or anyone else who is interested in the electrical equipment used in the home, I suggest that whenever an electrician is working in your home you watch him and see how he does his work. Undoubtedly he will be willing to answer your questions and show you how electrical work is done, how electrical connections are made, and other things of interest. It's often easier to learn by watching someone else than by reading a book. Observation is one of the best teachers.

Fuses

On page 39 I have already told you something about the fuse and what it is for. It might be well to give you a little more information about this simple device, since it is a very important item in every home.

The fuse in the electric circuit is like a weak link in a chain. Such a weak link or fuse is purposely inserted so as to confine the "break," in case of an overload, to one special spot where it may be easily mended. When too much electricity tries to pass through a

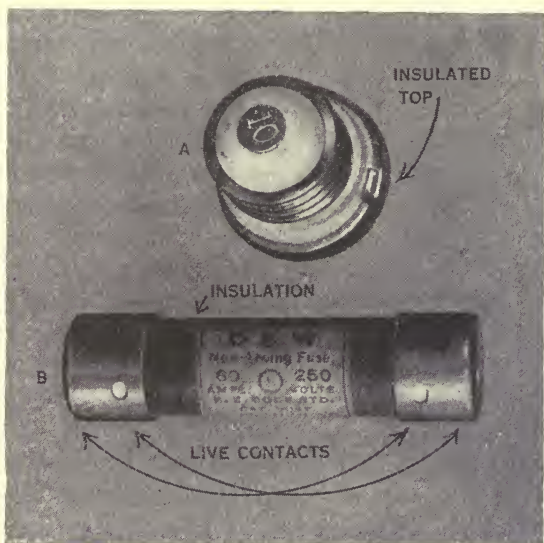
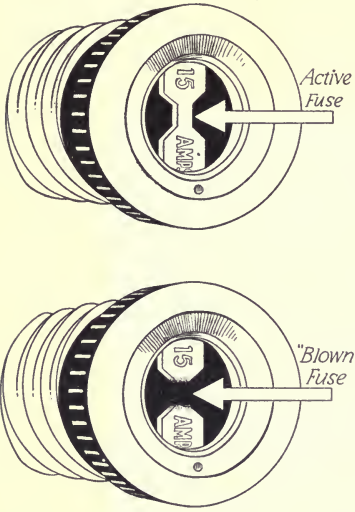

FIG. 269.—Typical household fuses. "A"—Plug type.
"B"—Cartridge type

fuse, a small lead alloy wire (fuse wire) in the fuse melts and breaks the circuit. Fuses are made in several types, two of which are shown in Fig. 269.

I have already told you that all the circuits in your home are protected by fuses. These are for your protection as well and the proper sizes should be used. Unless you are otherwise advised by specific instructions from your contractor or your lighting company, I suggest that you use 15-ampere fuses on your branch circuits. Fuse protection is graded. The largest fuses, usually 30-amperes, are the main or entrance service fuses which protect all circuits, and the smaller ones, 15-amperes, protect the branch circuits. A "blown" fuse should be replaced with a good fuse. Anything else is dangerous. It is a simple matter to keep extra fuses on hand, and these only should be used. It is absolutely essential that you never use a substitute for one of these fuses.

A "non-tamperable" fuse, as it is called, has been developed which prevents replacements by substitutes or a change in the size of the fuse, and may some day come into general use.



The common everyday "plug" fuse, as it is called, Fig. 270, is usually provided with a mica cap, and when the fuse "blows" this mica cap will be found blackened on the inside and therefore can easily be located.

Sometimes it is hard to locate just which fuse has "blown." In some cases a single fuse will "blow," and again two or more may burn out, according to circumstances.

Do not be alarmed if a fuse "blows." It simply has done its

FIG. 270.—Good and "Blown" fuses. Condition can be determined by looking through mica cap

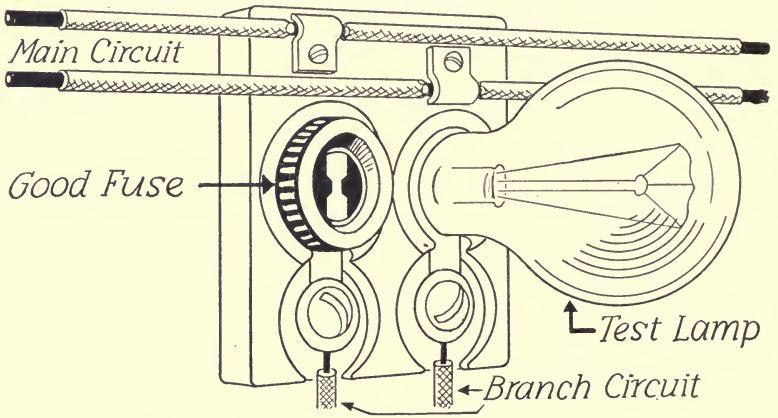

FIG. 271.—Checking a circuit for fuse renewal

First. Locate the "blown" fuse, and if two on the same circuit have gone, replace one only.
 Second. Then put in a good bulb. If the bulb burns dimly or not at all, a new fuse may be inserted.

Third. If the bulb burns brightly, locate the trouble by going to each socket or outlet and disconnect any appliance or turn "off" the socket. Watch the bulb in the fuse cut-out whenever you make a change at a socket or outlet. If the bulb goes out or burns dimly, you have found the trouble.

duty in cutting off the electricity when too much was passing through the circuit. It has acted entirely for your protection.

If possible, it is well to determine what caused any particular fuse to burn out. Perhaps it was due to a defective portable cord or possibly somebody used a defective appliance. The trouble may also have been due to a faulty lamp socket, a defective bulb, a defective fuse itself, or some other defective device. When a fuse burns out it is well to see what everybody about the house was doing in connection with the electrical system at that particular time. Frequently this will locate the trouble easily.

Fig. 271 shows a method of determining whether or not it is all right to put in a new fuse to replace one that has burned out. This is not necessary if the trouble has definitely been located, but if it has not, it is better to make this simple test than to keep on "blowing" more fuses.

In replacing a fuse it is well to turn off the main service switch supplying the system. This should not be done, however, until after the test has been made and the defective fuse accurately located, since electricity is needed for the test. Some lighting companies make a practice of sealing the entrance switch and fuses in the home. In such cases you will find that they are prepared to renew these fuses for you in case of any difficulty. Put their 'phone number in the space provided at the back of this book for future reference. As a general rule, it is not the main fuse that burns out, but one of the branch circuit fuses contained in the distributing panel. The use of a "Nofuze" circuit breaker, Fig. 272, will do away with fuse renewals.

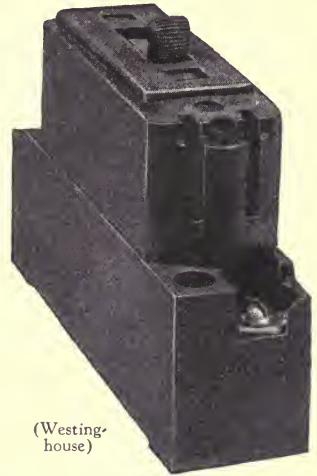

(Westing-
house)

FIG. 272.—"Nofuze" circuit breaker

Loose Sockets and Fixtures

Sockets are usually screwed to fixtures, which means that if they become loose they should not be turned many times or they will twist

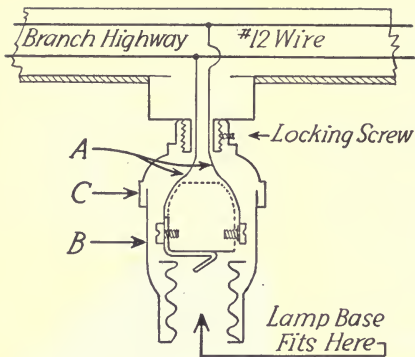

FIG. 273.—Method of tightening loose socket. "A" (conducting wires) should not be twisted. Socket may be tightened on fixture by removing shell "B" where it joins cap "C." Cap "C" may then be screwed on tightly to fixture and held in place by locking screw shown at right. Shell "B" is then replaced. (Be sure current is "off" before tightening socket)

the wires on the inside and possibly break them. Fig. 273 shows how sockets are assembled on a fixture. By referring to this sketch you will see that the socket body can be removed, and the cap properly tightened, without in any way disturbing the small connecting wires. The locking screw should be tightened when the socket is in place.

Many fixtures are screwed to wall outlets or to a "Crowfoot." If such a fixture becomes loose turning it many times may twist and

perhaps break the fine conductors it contains.

Switch Plates

The plates which surround flush wall switches often become soiled or even corroded. These plates are easily removed by simply taking out one or two screws on the surface of the plate. When a switch plate is defaced it is best to replace it with a special colored plate that matches the walls of the room. Several special finishes are available, including a chromium finish, and their use will improve the appearance of almost any wall. Such plates may also be obtained for replacing soiled plates on the convenience outlets.

Portable Cord

Portable cord is subject to considerable wear in the home, and repairs are sometimes necessary. These repairs are comparatively simple, and the following method of procedure is suggested:

The first thing to remember is to disconnect the cord entirely from the electrical circuit. *Never cut a cord when the current is on!* If the cord is badly worn or broken away from its ends an entire, new

cord should be used, since joints should be avoided. If the defect in the cord is near either end, or if the ends have become badly worn, the cord should be cut back just beyond the break and a new start made. If a cord is in bad condition it is best to renew it before it breaks or gives trouble through short circuiting.

Portable cord which has an outer covering of rubber requires careful cutting of this covering so as not to injure the fine wires of the conductor.

The following method of renewing portable cords will be of assistance to those having their first experience. At "A" in Fig. 274 is shown a typical heater cord. At "B" this same cord is shown with its outer cotton covering removed, exposing the two asbestos-covered wires. In this view the threads that make up the outside covering have been cut off and the remaining covering tightly tied with common thread to prevent raveling. Both the outer covering and the asbestos covering may be cut with ordinary scissors, but *care must be exercised not to cut any of the fine wires*. At "C" these same two wires are shown with the asbestos covering removed exposing the rubber insulation on the top wire, while the lower wire has its rubber insulation removed.

All the rubber insulation must be carefully removed from both wires before they can be put under the binding screws in the attachment plug cap, or the appliance terminal. It is then ready for final connection with a strip of friction tape about $\frac{3}{8}$ ths of an inch in width bound tightly around the cord. The space occupied by this tape is larger than the hole in the attachment plug cap through which the cord passes. The object of this tape is to take the strain from the conductors where they are fastened by the binding screws. Put the cord through the hole in the attachment plug cap before applying the tape.

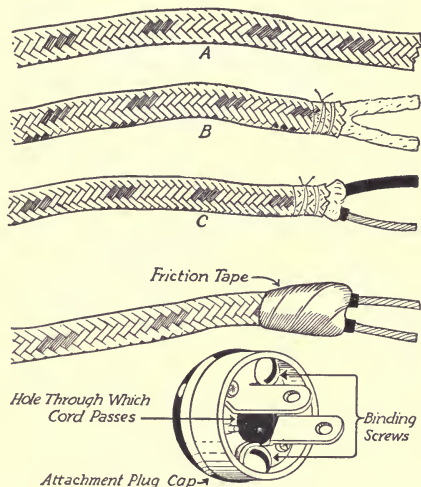

FIG. 274.—Method of connecting portable cord to convenience outlet cap

The two wires are now ready for final connection, each one to a binding screw in the attachment plug cap, as shown in the illustration.

The most important thing of all in connecting cords of this type to the attachment plug is to see that all the small wires of each conductor are twisted together, and that they are all properly fastened underneath the binding screw of the attachment plug. None of the strands from either of these conductors should come in contact with strands of the other conductor, otherwise a short circuit will result.

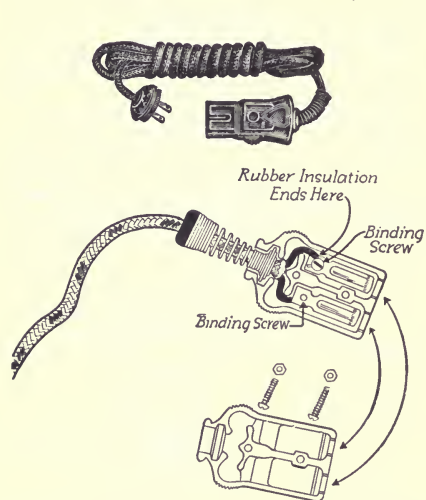

FIG. 275.—Method of renewing a cord, showing how the conductors are connected to an appliance heater plug

When replacing an old cord with one of these connectors, take it apart carefully and see how it was originally connected, so that replacements may be made in the same way. When making repairs be careful not to lose any of the small screws or nuts, since they are often hard to replace.

To check a renewed or repaired cord, connect it to an iron or other appliance that is known to be in good working condition.

It might be well to keep on hand some spare cord, both of the heater and lamp type, as well as some friction tape and rubber splicing compound. A place in the home shop may be provided for these items, together with spare bulbs, fuses, etc.

Place the wires under the binding screw in such a manner that tightening the screw will tend to pull the strands in the same direction. In replacing an old cord be sure that all the small wires have been entirely removed from the attachment plug or the appliance.

Fig. 275 shows how connections are made to the standard style of connecting plug, which is usually used with irons, toasters, etc. When replacing an old cord with one of these connectors, take it apart carefully and see how it was originally

FOREWORD
To Chapter Eight

IT is not to be expected that you should know all the details of highway construction as a qualification for purchasing and driving a new automobile even though you must pass certain tests before being granted a driving license, and local ordinances require that every car-driver should be thoroughly familiar with traffic regulations.

Similarly, when making plans for your new home, it is not necessary to know as much as your architect and builder about matters that relate to their specific business and experience. Nevertheless, it is always helpful when the owner is possessed of sufficient information about the practical considerations of building a home to express his needs and desires intelligently to those who are to provide the means of satisfying them. Time and money are thereby saved and when the structure is completed it is much more certain to measure up to the owner's expectancy.

While much of the subject matter contained in the following chapter will be found elsewhere in this book, I consider it desirable to summarize in one place certain important considerations with which the home-builder will necessarily be involved—or at least should give some thought to—when building his new home. I am sure he will find it helpful to acquaint himself somewhat with the various methods of wiring and their proper application by way of being prepared to discuss with his architect and builder a plan that will insure to him all the services and conveniences to which he is entitled. A brief outline of this chapter follows:—

Electrical wiring symbols and their meaning.

The methods of wiring available.

Why you should have a Certificate of Inspection from the contractor.

The Service Entrance—what to install.

Branch Circuits—make certain they are properly laid out and of sufficient capacity for your requirements.

Wiring of individual rooms. Be sure that you are provided with sufficient outlets, and that their locations meet every requirement.

What type of outlets and switches to install for various rooms and locations—inside the house and on porches and outbuildings.

Proper outlets for call bells, buzzers, chimes, and burglar alarms. Individual call systems, telephones, etc.

Minimum wiring requirements—a table of suggested outlets.

A word about making provision for future needs—main circuits of suitable capacity and spare branch circuits.

Chapter Eight

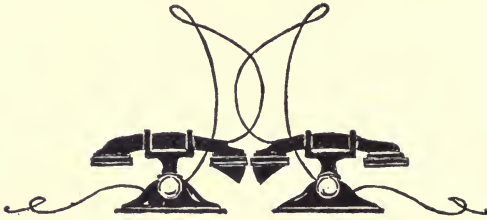

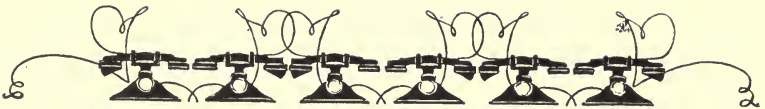

CHAPTER EIGHT

The Electric Highway for the New Home

If I could give you great pleasure if I could go over with you the plans for your new home and make suggestions as to how it should be wired and where outlets for lights and appliances should be located—but that is manifestly impossible. If you will give this subject a little study and spend a few minutes in going over the details of each room, you will be in a position to talk intelligently with your architect or your electrical contractor. The more you know as to what you want and how the home is to be furnished, the better you can lay out a system that will give you the first-class service you desire. It is less expensive to install electrical outlets when building a home than to make additions after it is finished, so it will pay you to do a complete job at the beginning.

When looking over plans for a new home, you will see symbols used to mark the location of switches, outlets, etc. In Fig. 276 are shown these various symbols and their meaning.

I am going to make a few suggestions that might be well for you to consider when you are planning the wiring of your new home.

WIRING SYMBOLS

- CEILING OUTLET
- ⊥-WALL BRACKET
- ⊙-DROP CORD
- ⊕²-DOUBLE CONVENIENCE OUTLET
- ⊙-FLOOR OUTLET
- ⊙-SPECIAL PURPOSE OUTLET
- S¹-1 WAY SWITCH
- S³-3 " "
- S⁴-4 " "
- S[⊖]-AUTOMATIC DOOR SWITCH
- S¹-SWITCH AND INDICATOR

FIG. 276.

Wiring Methods

There are several methods of wiring used in the construction of the electric highway of the home. These are distinguished from each other primarily by the means employed for supporting and protecting the wires, or conductors. In many sections the regulations of local electrical ordinances and lighting companies govern the use

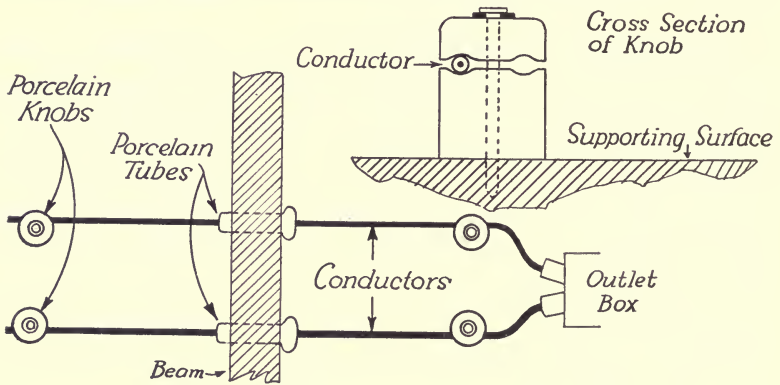

FIG. 277.—Knob-and-tube wiring

of these several methods of wiring and define their limitations. The advice of a good contractor familiar with local practice or the recommendations of the representative of your lighting company should, therefore, be secured on this point.

Wiring methods in general use and recognized as safe by the National Electrical Code may be described briefly as follows:—

KNOB-AND-TUBE. Knob-and-tube wiring is one of the oldest methods in use. It consists of porcelain supports in the form of grooved knobs for holding the conductors in place, and porcelain tubes for insulating the conductors when they pass through a wall or partition. This method of wiring is illustrated in Fig. 277. In some cities it is no longer allowed and in recent years has been supplanted by other methods of wiring.

NON-METALLIC SHEATHED CABLE. In this method of wiring, the conductors are completely incased in a special insulating covering. This method may be used in practically any part of the home except where dampness is present, although it is no longer allowed in many localities. It is illustrated in Fig. 278.

FLEXIBLE ARMORED CABLE. The flexible armored cable system is probably the most universally used today. It consists of insulated



FIG. 278.—Non-metallic sheathed cable
 "A"—Conductors or "electric highway"
 "B"—Electrical insulation
 "C"—External protective covering

wires contained in flexible metallic tubing, as shown in Fig. 279. This flexible tubing is made continuous from outlet to outlet, is very simple to install and gives excellent mechanical protection to the wiring.

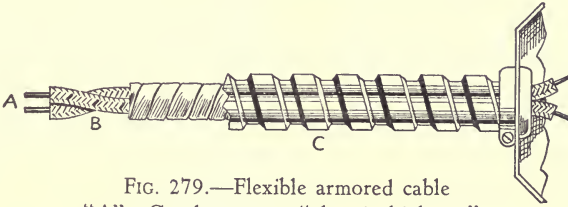

FIG. 279.—Flexible armored cable
 "A"—Conductors or "electric highway"
 "B"—Electrical insulation
 "C"—External protective covering

RIGID CONDUIT. Rigid conduit wiring is sometimes required by local ordinances for certain parts of the house wiring system. It consists of a complete piping system which provides a space for the

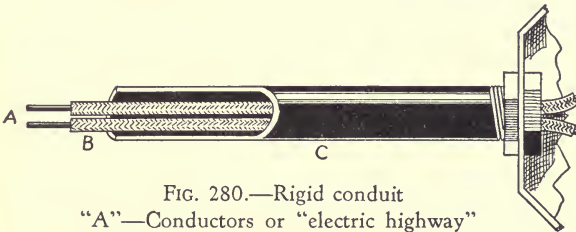

FIG. 280.—Rigid conduit
 "A"—Conductors or "electric highway"
 "B"—Electrical insulation
 "C"—External protective covering

electrical conductors. Fig. 280. This conduit system is first installed complete as a piping system, and the wires are then pulled through the conduit and properly connected. This system is very flexible,

for wires may be removed or replaced at any time, but its advantages may be offset by its additional cost.

THIN WALL TUBING. Thin wall tubing, or electric metallic tubing as it is often called, is similar to rigid conduit except that

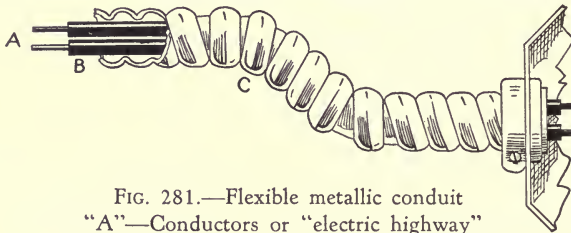

FIG. 281.—Flexible metallic conduit
“A”—Conductors or “electric highway”
“B”—Electrical insulation
“C”—External protective covering

the tubing itself, or the pipe into which the wires are drawn, is of much lighter construction and, therefore, is usually less expensive to install than rigid conduit.

FLEXIBLE METALLIC CONDUIT. Instead of rigid conduit a flexible metal conduit, Fig. 281, is often used and is somewhat easier to install.

SURFACE METAL RACEWAY. The surface metal raceway system of wiring may be used in the home where wiring cannot be concealed.



FIG. 282.—“Wiremold,” or surface metal raceway (cross section at right)

It cannot be used in damp locations, but is well adapted for use in the garage, a finished basement, or any room where exposed wiring must be used. Fig. 282. This system is well adapted for summer homes or cottages where the construction of the house does not permit the wiring to be concealed. Fig. 283.

Material and Workmanship

It will be cheaper in the long run to use the best of wiring material and fittings. This means first-class sockets and switches, since these items receive the most wear in the electrical system of any home.



FIG. 283.—Examples of "Wiremold" installations

Then again, insist upon first-class workmanship and that all work be done in accordance with the National Electrical Code.

INSPECTION OF WIRING INSTALLATION. For their own protection, as well as for that of home owners, the Fire Insurance Companies of the country have indirectly set up the National Electrical Code, which is a set of rules and regulations for the safe installation of electrical wiring and fittings. The rules are similar to traffic regulations on the highway and are equally important. Without these rules the use of electricity would be limited and possibly dangerous, and its application greatly hindered. They are of great benefit to us all, since they relieve us of the responsibility of looking out for many details of wiring safety.

Inspection of residential wiring is a function of our municipalities. This inspection service is valuable to home owners. Anyone having a new home wired should insist upon it, for it is inexpensive and assures a safe wiring job. You should have a definite understanding with your electrical contractor that he is to furnish a certificate of inspection from the proper authorities. In many cities inspection of this kind is required by law, but whether or not it is required, the service is available in any section. Your lighting company will give you information as to how to secure this service. In case your electrical contractor does not want to promise you this inspection certificate, you had better seek a new contractor.

Points to Be Considered in Planning Your Wiring

SERVICE ENTRANCE. It is necessary that you have an up-to-date enclosed service entrance with sufficient capacity to take care of your future, as well as your present, requirements. When you build your home you may not think of using an electric range or air-conditioning equipment, but in spite of this I strongly advise you to put in a service entrance that will allow for equipment which may be needed in the future. It is much less expensive to install a service entrance which will provide for future increase in your use of electricity than to be forced later on to take out the original installation and replace it with a larger size. Electricity is being used more and more in making housekeeping easier and new uses are constantly being developed. The entrance wiring which you use should, therefore,

consist of at least three No. 6 wires which should be connected through a 60-ampere switch.

BRANCH CIRCUITS. Provide an ample number of branch circuits and take care not to overload any of them. Branch circuits distribute the electricity from the main supply to the various outlets in the house. They lead out of what is called a distributing panel or fuse box and each serves a certain group of lights or appliance outlets.

Unless care is used in laying out these circuits, electricity may be wasted by trying to push its way through too small a wire. Losses of this kind are quite frequent in using larger appliances such as an ironer or range, and also smaller appliances such as a waffle iron and flatiron, if other outlets on the same circuit are being used at the same time. Such losses mean that you are not securing efficient use of the electricity which you purchase, since a portion of the electricity is used to transmit the balance of the electricity through wires which are too small for the intended purpose.

The wire used in these branch circuits should not be smaller than No. 12. The number of outlets served by one of these branch circuits should be carefully checked so that none of them will be overloaded and therefore waste electricity. The National Electrical Code limits the number of these outlets as far as the safety of the wiring is concerned, but the application of these regulations in some localities does not always afford the most efficient use of electricity.

The number of branch circuits which any house may need should be considered from two points of view: first, those to provide for the lighting and ordinary convenience outlets, and second, those to supply the outlets where appliances are permanently connected or are more likely to be used. The amount of lighting needed in any room depends primarily on the amount of space in that room. The amount of electricity which will be needed to light any room, therefore, is roughly proportionate to the floor area. Convenience outlets, with the exception of those in the dining room, kitchen, pantry, laundry and bathroom, are used principally for connecting portable lamps and small appliances, so that the convenience outlets in these rooms, plus the lighting outlets, both ceiling and wall brackets, are served by what might be called lighting circuits.

LOCATION OF OUTLETS IN INDIVIDUAL ROOMS. In order to make sure that you obtain the most efficient use of electricity in your new home, careful consideration should be given to the wiring of each

room in the house. Changes of wiring, after the house is complete, are much more costly than when including them in the original installation. Exposed extension cords around baseboards and moldings of a room are unsightly and should be avoided.

Since many electrical contractors base their ability to secure work only upon the fact that they do the work more cheaply than their competitors, it is not always well to take the lowest bid. In many cases, particularly where there is any great difference between them, it is likely to mean that the lower bid does not include all of the work which the higher bidding contractor is intending to install. Each outlet which is to be installed should, therefore, be carefully marked on the plans and listed in the contract for the job, and this means that the outlets in each room must be decided upon in advance.

As a guide in laying out the wiring for individual rooms, I have listed briefly a few items which should receive consideration. Study the floor plan of your new home and see that every outlet is plainly indicated and that the contractor who is going to do your work agrees with you as to what you want.

General Recommendations

CONVENIENCE OUTLETS. All convenience outlets, except the one suspended over laundry trays and those limited by local ordinances, or to serve specific devices, should be of the duplex type.

Make certain that before outlets are permanently located they are not behind radiators or doors. When two or three are required in a room, they should be located on different sides of the room where they will be most convenient with respect to furniture spaces.

LOCATION OF SWITCHES. Switches should be provided at each main entrance to all rooms, halls, passages and storage spaces having 30 or more square feet of floor area. Three-way and four-way switch control should be installed between all active floors and all main entrances to each room or hall in which entrances are more than 10 feet apart; also within the house to control at least one light in, or on, any detached garage or other outbuilding.

ENTRANCES AND PORCHES. There should be at least one light outside each entrance, with the switch just inside each door and an illuminated house number at the front entrance.

Additional ceiling or bracket lights for covered porches should be installed, at least one such outlet for every 100 square feet of floor area.

At least one waterproof convenience outlet should be provided at the front entrance, even where there is no porch, so that outdoor decorative lighting can be connected at Christmas or other seasons. On porches, terraces and similar areas where guests may be served with a light luncheon, or where portable lamps and appliances may be used, convenience outlets should be provided for each fifteen feet of wall space on the house side.

HALLS, PASSAGES, STAIRWAYS, ETC. At least one ceiling or bracket light should be provided for every hall or passage to illuminate head and foot of stairways. Additional lighting outlets should also be provided—one for every 15 feet of length—in any hall or passage.

And, in addition to the above, there should be at least one convenience outlet for every 12 feet of wall space in hall or passage, for portable lamps, suction cleaner, floor polisher and other appliances.

LIVING ROOM, BEDROOMS, RECEPTION HALL, LIBRARY, DEN, SUN ROOM, ETC. Increasing use of the newer center fixtures which are hung close to the ceiling, and are in proportion to room dimensions, makes it desirable to provide a ceiling outlet with switch control even though no fixture may be contemplated for immediate use. For rooms whose length is more than one and one-half times the width, two ceiling outlets should be provided. Wall brackets are primarily decorative unless special semi-indirect or indirect fixtures are specified. Outlets supplying brackets should be controlled by a switch or switches. (Localized lighting is supplied by portable lamps connected to convenience outlets.)

Convenience outlets should be placed so that no point in any unbroken wall space is more than 6 feet from an outlet. In order to supply electricity adjacent to small tables, radio, telephone stands and the like, located along short wall spaces, at least one outlet should be provided in every wall space three feet or more in length.

Radio ground and aerial connections adjacent to, or in conjunction with, convenience outlets should also be provided in several of the rooms where a radio may be used.

DINING ROOM, BREAKFAST ROOM OR BREAKFAST NOOK. In almost every such room, a center fixture is essential. Decorative brackets

may supplement such general illumination, but if used without the center light they should be of the indirect or semi-indirect type.

Provide a minimum of two convenience outlets to supply appliances in each such room having an area of more than 100 square feet. (Floor outlet, when used, considered as one of required minimum.) Add outlets for each additional wall space adaptable to use of buffet, serving table, etc.

In smaller rooms, and where the dining table will be set against the wall, one convenience outlet at table height will usually suffice.

KITCHEN, KITCHENETTE, PANTRY, ETC. Provide a single ceiling outlet in small kitchens, and two in large kitchens, with supplementary lighting over range, sink and other work areas. Unless construction makes it impossible, brackets are suggested for supplementary lighting.

Provide a convenience outlet at the sink, ironing board and adjacent to other work areas with special outlets for range, refrigerator, clock, dishwasher and ventilator.

LAUNDRY. Provide a ceiling outlet supplemented by light over laundry trays and ironer location. (Specify daylight bulbs and suitable reflectors.)

Provide a washing machine convenience outlet suspended from ceiling in front of trays. The drop cord on this outlet should be rubber-sheathed. Also make provision for a wall outlet for rotary or flat-plate ironer, and a wall outlet for hot-plate.

BATHROOMS, LAVATORY. Provide a center light, with bracket, on each side of mirror. The center light may be omitted in bathrooms or lavatories having less than 90 square feet of floor area, but even in small bathrooms a ceiling outlet might well be used for a sun-ray lamp.

Provide a vapor-proof receptacle in shower compartment and in tub recess (controlled by switch outside compartment).

Use a convenience outlet (where in accord with local ordinance) 42 inches from floor and not adjacent to the tub.

CLOSETS. Install a bracket fixture immediately over door in all clothes closets (wardrobe excepted). In large closets, specify ceiling outlet controlled by a switch at the door, or use an automatic door switch.

BASEMENT AND ATTIC. Use a ceiling light or bracket in each enclosed space as well as in front of furnace, over workbenches, etc. At least one basement light should be controlled by a switch upstairs, connected with an indicator light. Provide proper reflectors.

Install appliance outlets for the suction cleaner, oil burner, use of tools, etc., and a special connection for water heating and the home shop. Finished rooms in basement or attic take specific classification according to their use.

GARAGE. Use one ceiling outlet for lighting over the hood of each car with additional ceiling outlets for lighting at the rear of the cars. In multiple garages these ceiling outlets for the rear of the cars can be placed between each two cars. In single garages the two ceiling lights can be controlled by the same wall switch, but in larger garages it may be desirable to have two or more switch controls.

Install one convenience outlet on the rear wall at each car location, about four feet above the floor.

A light should be provided outside of the garage for lighting the entrance and driveway, as well as the path between the garage and the house, if one is used.

In garages which are separate from the house it is desirable to have the wiring between the house and the garage installed underground to avoid unsightly wires. A switch controlling the light on the outside of the garage should be located inside the house.

MASTER SWITCH FOR BURGLAR PROTECTION. Install in the master bedroom one wall switch which will turn on one or more lights in any or all of the rooms and halls of the house, independently of switches normally controlling these outlets. The number and location of lights to be connected to this switch depend upon the details of construction of the house. The fewer the lights thus connected which will give light in or near all active rooms, the better, for this installation is somewhat expensive. When thus turned on by the master switch the lights cannot be controlled by the regular switches until again turned off at the master switch.

BELLS, BUZZERS AND CHIMES. Install an outlet for the connection of a bell-ringing transformer with wiring to a push button at each outside door to operate bells or chimes of different tones, or bells and buzzers which will usually be located in the kitchen. A foot-operated push button under the dining room table will also be found convenient to signal the kitchen. In larger homes push buttons are usually installed in some of the other principal rooms to signal in the kitchen or the servants' quarters. (See page 294 for further details of signal systems for the home.)

TELEPHONE SERVICE. Install one outlet with concealed wiring for outside telephone connection on each active floor. Consideration should be given to installing concealed conduit for connection of telephone wires from the point at which they reach the house. This conduit should be run from the point on the outside of the house where the telephone wires enter to a point in the basement where a metal entrance box can be located.

Minimum Wiring Requirements for Adequate Electrical Service

The recommendations for convenience in the installation of residence wiring suggested in the preceding pages will supply a complete layout adequate to serve most present needs. At the same time it is realized that, in some homes, the building dollar must be stretched to the limit. The following recommendations are, therefore, sug-

Location	Ceiling light outlets	Wall light outlets	Switch outlets	Duplex convenience outlets
Porches (over 80 sq. ft.).....	1	or 1	1	1
Entrances (front or rear).....	1	or 1	1	..
Vestibule	1	or 1	1	..
Lower Hall.....	1	or 1	2*	1
Passage Hall	1	or 1	1*	..
Living Room	1	or 4	1*	3
Dining Room.....	1	..	1*	1
Kitchen	1	..	1*	1
Breakfast Nook.....	1	or 1	..	1
Upper Hall	1	or 1	2*	..
Bathroom	1	or 2	1	1
Bedrooms (each).....	1	or 2	1	2
Closets (over 3 ft. deep).....	1	or 1
Attic	1	or 1	1	1
Cellar or Basement.....	1	..	1	1
Laundry	1	1
Garage	1	..	1	1
Reception Hall or Foyer.....	1	or 2	1*	1
Library, Den or Music Room.....	1	or 2	1*	2
Sun Room	1	or 2	1	2
Breakfast Room or Nook.....	1	or 1	1	1
Kitchenette	1	or 1	1	1
Pantry	1	or 1	..	1
Sleeping Porch	1	or 1	1	1
Servant's Bedroom.....	1	or 1	1	1
Lavatory	1	or 1
Recreation Room.....	1	or 2	1	1
Each Enclosed Space in Cellar or Basement	1	or 1	..	1

*In rooms or halls having main entrances more than twelve (12) feet apart, at least one light outlet should be controlled from each entrance. Lights which illuminate the foot and head of stairs should be controlled separately from both floors. Switches should be placed on the knob side of doorway

gested as an absolute minimum below which it is felt no present home could enjoy the complete convenience of modern electricity. An average home laid out on the basis of this schedule, while not complete in every detail, will secure the greatest possible convenience with the least number of outlets.

SPARE CIRCUITS. Attention should be given to the number of circuits, in order that at some future date too many lights or too many appliances may not be used on one circuit. Therefore, in single dwellings, provision should be made for the addition of at least one future circuit for the first seven or less active circuits installed, and for the addition of two future circuits for eight to twelve active circuits installed—such provision to be made by a spare fuse cut-out in the distributing panel or cabinet.

SERVICE ENTRANCE PANEL. To provide for present and future needs, a service entrance of suitable capacity should be installed, but due to technical considerations its actual size must be determined locally. Three No. 6 wires with a 60-ampere switch are recommended as a minimum.

The very decided trend toward heavy-wattage appliances in homes makes it necessary that a considerable excess capacity be provided over that required for the present connected load, in order to take care of the addition of large appliances such as water heater, ironer, built-in wall heaters, range and the like, at some future date.



FOREWORD
To Chapter Nine

IT is only a few years ago that tire manufacturers were guaranteeing five thousand miles on the assumption that this was the ultimate expectancy of the useful life of a tire. Automobile manufacturers had not projected their engineering possibilities beyond the four-cylinder, or at best the six-cylinder, engine and among the many uncertainties which involved the problems of future developments was the grave consideration of whether or not the "closed car" would meet with the approval of the public. And so the automobile of the future has, year by year, been surrounded with conjecture as to what, if any, improvements might still be made to advance the appearance, comfort, efficiency and service of the motor-car as a means of insuring customer satisfaction and the continued growth of the industry.

In view of the many progressive changes we have witnessed since the day when four-cylinder engines and tires of five thousand miles guarantees represented what was considered near-perfection, it can be assumed that the crowning achievement in any field of science, whether it be automobiles or electrical "vehicles" of home service, is a "will-o'-the-wisp" which we may be forever chasing, but will never catch. Even the advanced stage of development which home electrification has reached today may appear as very elementary to later generations looking back upon this period—and who knows but that our own children will smile reminiscently a few years hence in their recollections of what we now call "modern lighting" and "modern appliances?"

I have no intention of prophesying what the electrical developments of the next decade will be like, for anyone's guess is as good as mine. However, there are certain unmistakable "signs" pointing to the electric home of the future which suggest one last journey over our electric highway. But this time, let me make it clear, we are going adventuring into the Realm of Imagination where there are as yet only a few guide-posts and, unless we are cautious, we may lose our way.

Chapter Nine

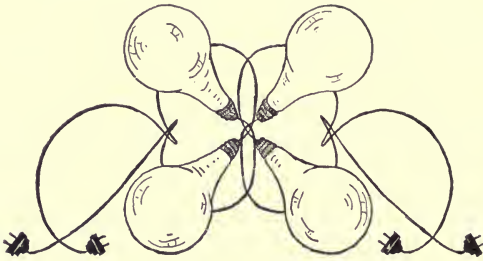

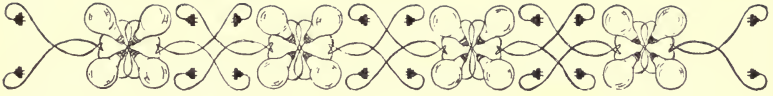

CHAPTER NINE

The Electric Home of the Future

If we stop to consider what has already been accomplished in the way of home electrification, it will take only a little imagination to picture the "All-Electric Home of the Future." In this fast moving era it is almost impossible to predict with any certainty what the next few years may bring, but the use of electricity in our daily home life has already progressed far enough to permit a fairly accurate picture of what a few more years of development will offer. With the equipment and knowledge now available, this all-electric home is a not-far-distant certainty.

While we may not as yet be in a position to anticipate fully the description of such a complete home, a few necessities and conveniences which can be applied to present homes will serve to indicate the direction such developments may take. Such homes will be designed so that electrical equipment for all manner of uses may be installed easily and inexpensively and constructed so scientifically that it will function efficiently. Existing and future homes will include the services of the appliances already described, but with improvements, simplifications and additional devices, and with the "All-Electric Kitchen," "Air-Conditioning" and Lighting quite likely making the greatest advances. In any event, the design and construction of future homes will be built around a complete array of electrical servants.

LIGHTING. The next step in improved lighting will probably be in the type of the light source. Gases may be used instead of heated filaments. The day may not be so very far away when incandescent bulbs, fitted into individual sockets, will be replaced by luminous panels as large as our present windows, built into the walls or even by entire walls or ceilings made to glow with a soft, even light. There will, of course, always be spots of brighter light here and there for reading and to relieve the monotony of uniform light or to add attractive spots of color and variations in light and shadow, but the

general illumination will doubtless be provided by a much larger light source than the incandescent bulb.

This lighting will in all probability approach daylight and contain the healthful rays given off by the sun. The modern sun-ray lamp is only a start in this direction, for without doubt all future artificial light will include the ultra-violet and the infra-red rays so essential to our health. It will no longer be necessary to put the baby outside for its daily sun-bath or to go to the seashore or the country to absorb the ultra-violet of which we are cheated by the smoky atmosphere of our cities through which the sun's rays must pass.

What has been said about interior artificial lighting may also be applied to the yard, so that anyone entering or leaving the house can do so under practically daylight conditions as far as the yard itself is concerned. Here again such a system may be extended to keep away the uninvited guest and hold him captive until assistance arrives.

CONTROL. It is now possible to have frequently used doors open and close automatically when anyone wishes to pass through. Windows may also be opened and closed by pressing a button or by the wave of a hand. Or, as science already provides, such domestic acts can be made subject to the commands of the human voice—and even more finely attuned to the pitch or quality of one particular voice—your own, if so desired!

When darkness occurs in any particular room, light will be turned on automatically. Such a system of automatic control can be realized even now to the extent that a person entering a room will cause it to be properly lighted and the light will automatically go out when that person leaves the room. With our present knowledge of the art, practically any automatic arrangement you can think of can be worked out in connection with lighting your home or in providing other services.

AIR-CONDITIONING. I have told you about air-conditioning and there is no question but that the future home will have such systems permanently installed and made entirely automatic. This may bring back the warm-air furnace of years ago, arranged to supply filtered cool air in summer in place of warm air in winter, with no radiators in sight. With such a system, better and cleaner air will be available without opening a window, since foul air will never exist. Cleaning the home will be much easier when filtered air is used. Houses will

be carefully insulated against heat and cold from the outside and they will be heated and cooled more economically.

ENTERTAINMENT IN THE HOME OF THE FUTURE. Trends and developments in the field of television make the most fantastic dreams seem almost within reach. This field of electrical improvement is still somewhat in the laboratory stage but progress within the past few years seems to point with certainty toward the universal application of sound and motion to the field of radio. The first step will be through the use of television sets which will receive entertainment broadcast from studios, much as radio is transmitted today, but with the added feature of seeing the actors as they play their rôles. Possibly this type of entertainment will be available in theatres, such as the present-day movie, where sound and action will be transmitted by the radio rather than by the usual film.

The next step may be the reporting of news events. Can you imagine the increasing interest with which you would watch as well as hear a football or a baseball game, or the inaugural address of the President of the United States, or the wedding of the Prince of Wales? And then, a few years later it may well be that you can enjoy the magnificent scenery of the Grand Cañon or the glory of the Egyptian pyramids, or view the horrors of a revolution as you sit in your home. Soon after this stage in the transmission of light and sound over the radio, might well come two-way communication, so that instead of having to travel miles to join a family reunion, you may gather with a dozen of your friends and relatives through the medium of the radio, without any of you having to leave your own homes. Just as you heard the voices and saw the faces of your friends, they could hear and see you.

The day is in sight when the more expensive homes will have a room fitted up exclusively for radio-electrical entertainment. The "Home Theatre" will become another American institution. Television and home talkies will share attention with a radio news bulletin and talking books that read themselves aloud to those who wish to save their eyes.

Just what will happen to our daily lives when such a stage is reached no one can say, but certainly, if we could all of us see just how the people of other countries were living, what they did for entertainment, how they produced their goods, or how they suffered for lack of some of the things we have, there would be a broader

understanding of world problems and a greater sympathy for our fellow beings, and we would remove the primary factors which contribute to the unrest, ill feeling and war in the world today.

Just what new phases of home-making can be taken over by electric servants it is hard to predict, but the advance which has already been made is sufficient assurance that when a new problem arises, electricity will be applied to its solution. Probably greater advance will be made in the increasing knowledge of how to employ electric servants than in new devices produced. The proper use, and the variations in the use, of appliances constitute a broad field for future development.

In Chapter Five many of these added services of modern appliances are mentioned, but the novel applications of electricity to home use seem to be almost without limit. Have you ever thought of using electricity to shovel snow, for instance? By merely imbedding resistance wires in the concrete of your front walk or the steps of your front porch, heat generated by electric current would melt snow as fast as it fell and would keep your walks clear of snow and ice without shoveling, and at moderate cost, since it would be in use only while the snow was falling or the ice forming.

It is because electricity is such a versatile and efficient servant and its use is continuing to increase by leaps and bounds, that I have suggested in my chapter on the electric highway that ample provision be made in the wiring of every new home, and in modernizing the wiring in present homes, for uses which may not be contemplated at present but which are almost sure to come in the near future.

The future of electricity in the home and the greater use of present-day appliances, as well as those in contemplation, depend largely upon two factors: cost, and understanding by the home owner. The cost of electricity itself, and the cost of the equipment for home use are its only limitations. It is the more extensive use of equipment and electricity itself that will lower the cost to such a point that the acquisition of these desirable services will be made possible for every home in the land. It is the large sale and universal use of automobiles that makes their low cost possible. This is true of practically anything—as, for example, our cost of travel and of food, and even a better example is found in the electric light itself. Years ago these bulbs cost five times their present price and gave but a

fraction of the amount of light of modern bulbs. It is quantity production that has decreased their cost and bettered their quality. If only a few people made use of what was available the prices would be prohibitive. It is the wholesale use of any commodity or service that lowers its cost, with electricity a leading example.

Conclusion

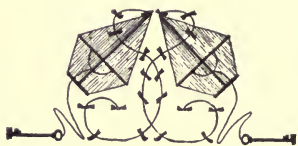

CONCLUSION

It is hoped that the contents of this book have been, or will be, the means of adding to the happiness of every member of your family through a practical understanding of the nature and uses of electricity. In the case of my own home, this knowledge of the simple truths of electricity has bestowed untold comforts upon us all. Personally, this "pursuit of happiness" on my hobby of home electrification has led me into countless pleasurable and profitable adventures. It began in my childhood home with the simple application of an electric spark for lighting the gas and has extended through the years to the use of our most modern appliances, such as the mechanical refrigerator, the suction cleaner and many other conveniences and necessities. This same hobby is a steed which will faithfully serve every master who will feed it with scraps of time, and water it with imagination. And that is something which everyone can well afford.

In closing this book, I would leave a brief message with the home owner and with members of our great electrical fraternity who have made THE ELECTRIC HOME possible.

TO THE CHIEF EXECUTIVES OF OUR PUBLIC UTILITIES: Continue your high standard of electric service, and continue to reduce the cost of this service so that its use in the home may continue to grow. The price should not be so low that it would be necessary to reduce the standard of service and make unprofitable the extension of service or deprive your stockholders of a fair return on the money they have invested. You have an important part to play in the development of the future American home, and your employees should be among your greatest users and believers in the products you have to sell—electricity and service.

TO THE STORE THAT SELLS ELECTRICAL EQUIPMENT FOR THE HOME: Select and purchase electrical equipment on a basis of quality and service, and determine its unquestioned merit and utility by trial in your own home. Discourage the manufacture of sub-standard material by not offering it to your customers. Train your salespeople

in the use and proper demonstration of appliances. Your customers may require servicing of appliances; see that every practical and reasonable facility is provided for this purpose.

TO THE ARCHITECT WHO DESIGNS THE HOME: Keep in mind the family which is to live in the home you design, and plan for the extensive use of electrical appliances as well as light in every room. Especially give thought to adequate provisions for the home shop and, if there are children to be considered, the electrically equipped playroom as well. Keep up to date electrically and consider in minutest detail the application of electricity in the home to meet the most modern requirements. Design an adequate electric highway and allow for the future use of appliances not in common use today, but which will become the necessities of tomorrow. Keep in mind the electrical contractor who installs this electric highway and provide an efficient right-of-way. Specify materials you know by experience to be the best. Plan for the radio, the electric range, air-conditioning and signal systems as well.

TO THE CONTRACTOR WHO INSTALLS THE ELECTRIC HIGHWAY OF THE HOME: Use only the best of materials and the best of workmanship in installing this electric highway of the home. Make this installation in accordance with the National Electrical Code. Explain the system you have installed to the home owner.

TO THE HOME OWNER AND HOUSEHOLDER: Last but not least, it is the householder and his family who should understand the benefits and appreciate the value of electricity in the home. It will be due in no small part to our increasing use of electricity that its cost will be lowered and its beneficial applications scientifically promoted to encompass every conceivable domestic need. You will receive the fullest return from the use of this great agency by understanding "THE ELECTRIC HOME."

GIFT SUGGESTIONS

USEFUL gifts may play an important part in the lives of our friends and relatives. A gift that helps to lessen the burdens or adds to the pleasures of a friend is easy to select from the long list of useful electrical devices. For this reason I have listed on a following page items that will be found acceptable to any home and in practically any price range. I have also provided space for a memorandum of anniversaries of friends and relatives, since being remembered on the day adds to the pleasure of remembrance.

SUGGESTED ELECTRICAL GIFTS

LIVING ROOM	BEDROOM	KITCHEN
Floor Lamp	Floor Lamp	Electric Refrigerator
Table Lamp	Table Lamp	Refrigerator Light
Health Lamp	Health Lamp	Electric Range
Ornamental Lamp	Skin Patter	Dishwasher
Tobacco Lighter	Curling Iron	Ventilating Fan
Electric Grate	Fan	Clock
Humidiguide	Radio	ENTIRE HOUSE
Mantel Clock	Clock	Floor Polisher
Radio	Heating Pad	Moth Exterminator
	Sewing Machine	Electric Vaporizer
COOKING APPLIANCES	LAUNDRY	"Wallite"
Electric Casserole	Washer	Fan
Electric Roaster	Light Weight Iron,	Flashlight
Deep French Fryer	1,000 watts	Suction Cleaner
Sandwich Grill	Ironing Stand	BATHROOM
Chafing Dish	Ironing Machine	Blade Sharpener
Automatic Toaster	Washer Pump	Oil Comb
Food Preparer	Water Ejector	Hair Dryer
Coffee Maker		Air Heater
Waffle Iron	RECREATION ROOM	Immersion Water
Egg Cooker	Corn Popper	Heater
NURSERY	Electric Grate	Health Lamp
Milk Bottle Warmer	Tobacco Lighter	Skin Patter
Health Lamp	Drink Mixer	GARAGE
Heating Pad	Health Lamp	Trouble Lamp
Dim-a-Lite	Radio	Tire Pump
Vibrator	Clock	Battery Charger
Clock		Auto Engine Heater
DINING ROOM	GARDEN	Clock
Clock	Hedge Shears	PLAY ROOM (GIRLS)
Ornamental Lamp	Lawn Mower	Set of Doll House
Chimes	Hot Bed Heater	Lights
(See Cooking Appli- ances)	Flood Lights	Toy Range
PLAY ROOM (BOYS)	SHOP	Toy Cleaner
Electric Railway	Bench	Toy Washer
Electric Truck	Soldering Iron	Electric Questioner*
Electric Questioner*	Scroll Saw	Flashlight*
Electric Top*	Portable Drill	
Electric Motor*	Upright Drill	SUMMER COTTAGE
Kaster Kit	Bench Grinder	Water Supply Pump
Steam Engine	Lathe	Flash Lights*
Flashlight*	Paint Sprayer	Worm Charmer
	Clock	

*Operated by dry cells.

INDEX

Air Conditioning	223	Coffee Maker	341
Alarm Systems	300	Combs, Electrically Heated, Oil	249
Alternating Current	26	Conclusion	445
Amperes	26	Conductors	29
Annunciators	296	Convenience Outlets, General.	50
Appliances	161	Clock	57
Care of	167	Duplex	55
Care of Motor Driven.....	168	Fan	59
Cooking	318	Radio	56
Cost of Operating.....	169	Recessed	57
Personal, Electric	248	Single	54
Purchasing	165	Waterproof	71
Thermostatic Control of....	319	Cooking Appliances	
Bath, Light and Heat Ray....	244	Casserole	336
Bench—Shop	382	Chafing Dish	341
Body Exerciser	247	Coffee Maker	341
Branch Circuits	43	Corn Popper	344
Bulbs		Deep Fryer	346
Bases for	131	Doughnut Baker	345
Daylight	129	Egg Cooker	344
Decorative	130	Fireless Cooker	334
Electric	128	Food Preparer	348
Glow	132	Food Warmer	337
Photographic	133	Griddle	333
Rating of	129	Grill	332
Sunlight	240	Hot Plate	330, 331
Burglar Alarms	300	Milk Bottle Warmer	347
Burners		Oven	334
Coal	222	Percolator	341
Oil	219	Plate Warmer	345
Card Table Electric	250	Portable Stove	330, 331
Carpet Cleaning	212	Potato Baker	334
Casserole	336	Range	321
Cellar Drain Pumps	313	Roaster	336
Chafing Dish	341	Sandwich Grill	332
Chimes, Electric	297	Toaster	337
Cigar and Cigarette Lighter...	248	Waffle Iron	339
Circuits	35, 148, 429	Wiener Cooker	346
Cleaners	203	Cooking, Electric	318
Suction	204	Cooling a Room Electrically..	227
Suction, Built-in System....	210	Cords	
Suction, Hand Type.....	209	Improper Use of	143
Types of	206	Portable	142
Use of	208	Portable, Proper Marking..	145
Clocks	284	Portable, Repairing	419
Chimes	288	Corn Popper	344
Grandfather	288	Current, Alternating & Direct.	26
Mantel	288	Current Taps, Fusible	144
Clothes Dryer	199	Deep Fryer	346
Clothes, Washing Process	186	Direct Current	26

Dishes, Washing Electrically..	360	Heating Pads	245
Distributing Panel	41, 149, 150	Hedge Trimmer	308
Doors, Electrically Operated..	312	High Frequency Health Ma-	
Doughnut Baker	345	chine	244
Drink Mixer	349	Hot Plate	330, 331
Dry Cells	376	Humidifiers	226
Dryer		Humidity Measurements	227
Clothes	199	Inhalers	247
Hair	249	Insect Electrocutors	305
Egg Cooker	344	Insulation	29
Electric Cooking	318	Insulator	29
Electric Highways	35	Ironers	
Methods of Extending	141	Electric	196
System, Electric	37	Flat Plate Presser Type ...	196
Electric Home of the Future..	439	Rotary Type	196
Electric System, Care of.....	413	Ironing	192
Electricity	24	Stand	194
Efficient Use of	403	Irons, Electric	192
Elevators, Household Electric..	311	Keeping Well Electrically.....	235
Exposure Meter	134	Killing Insects Electrically ...	303
Fans		Kilowatt Hours	28, 409
Electric	300	Kitchen, All Electric	363
Functions of	300	Lamps	
Ventilating	224, 302	Adapter	90
Fireless Cooker	334	Current Consumed by.....	408
Fixtures		Infra-red Ray	242
Ceiling	84	Portable	89
Wall	87	Portable Bi-Flector	92, 93
Flashlights	126	Reflectors	95
Flood Lights	126	Shades	94
Floors, Polishing Electrically..	212	Sunlight	236
Food Preparer	348	Ultra Violet Ray	237, 238
Food Preserving Electrically..	351	Laundering Clothes Electrically	179
Food Warmer	337	Lawn Mowers	307
Frequency	26	Lighting	75
Fuses	39, 414	All Night	119
Checking for Renewal.....	416	Aquarium	104
Future Electric Home.....	439	Architectural	80
Gifts, Electrical.....	448-449	Attic	118
Grate, Electric	218	Bathroom	115
Griddle	333	Bedroom	112
Grill	332	Breakfast Nook	108
Ground	40	Closet	114
Grounded Neutral	40	Cove	78
Hair Dryer	249	Decorative	79
Health Appliances	235	Dining Room	106
Heaters		Direct	77
Aquarium	179	Emergency	113
Air Type	216	Entrances	98
Hot Bed	309	Fireplace or Mantel	103
Radiant Type	217	Flood Lights	126
Water Immersion	178	Fountain	122
Heating		Garage	119
Anthracite Burner	222	Halls	101
Electric Grate	218	Illuminated House Number.	100
Household	214	Indirect	78
Oil Burner	219	Kitchen	108
Heating Blankets	246	Laundry	110

Lighting—(Contd.)		Sockets—(Contd.)	
Miscellaneous Rooms	118	Loose on Fixture	417
Out-of-Door	120	Chain Pull Insulator	150
Pantry	110	Steamers, Electric	211
Picture	104	Stove Domes	329
Planning for Individual		Sunlight Lamps	236
Rooms	96	Switches 38, 46, 149, 398	
Recreation Room	116	Door 48, 114	
Refrigerator	110	Time 292	
Semi-indirect	77	Tea Kettle, Electrically Heated	178
Sunlight, Artificial	82	Telephones 265	
Upper Hallway	112	Inter-communicating	299
Vestibules	101	Thermostats 319	
Wallite	115	Time, Keeping Electrically	284
Lightning Protection	306	Time Switches 292	
Meter, Electric	409	Toaster 337	
Milk Bottle Warmer	347	Tobacco Lighter 248	
Motors		Tools, Electrically Operated	397
Shop 397		Toys	
Toy 377		Electric for Girls 378	
Moth Exterminators	303	Electrically Operated	373
Outlets, Convenience	50	Ventilators 224	
Out-of-Doors, Electrically	307	Vibrators 247	
Out-of-Doors Lighting	120	Volt 26	
Oven 334		Waffle Iron 339	
Percolator 341		Wallite, Use of 42, 115	
Photographs, Electric	272	Washing Machines 180	
Photographic Exposure Meter	134	Care of 191	
Piano, Electrically Operated	371	Operation of 186	
Plate Warmer 345		Selection of 182	
Plugs (See Outlets)		Water Heating	
Portable Stove 330, 331		Complete Household 175	
Potato Baker 334		Small Quantities 178	
Push Buttons 296		Water Systems	
Radio 267		Household 313	
Automobile 272		Cellar Drain Pumps 313	
Installation of 274		Watt 27	
Noise 276		Wiener Cooker 346	
Selection of 268		Wiring	
Tubes 278		Clips 158	
Range, Electric 321		Miscellaneous 157	
Razor Blade Sharpener	250	Modernizing 149	
Reflectors, Lamp 95		Outlets, Minimum 434	
Refrigeration, Electric	351	Outside 156	
Refrigerators, Electric, Care		Wiring Methods	
of 359		A New Home 423	
Roaster, Electric 336		Fabric Covering 147	
Sandwich Grill 332		Flexible Armored Cable	425
Service Entrance 37, 149		Flexible Metallic Conduit	426
Service Switch 38, 149		Knob and Tube 424	
Sewing Electrically 251		Non-Metallic Sheathed Cable	424
Sewing Machines 253		Rigid Conduit 425	
Portable Type 254		Surface Metal Raceway	
Shop Tools 384, 396	 145, 147, 426	
Signal Systems 294		Thin Wall Tubing 426	
Sockets 46		Worm Charmer 310	



